

MEASUREMENT REPORT

FCC PART 2 & 22 & 24 & 27

FCC ID: ZMOFM101NA
Applicant: Fibocom Wireless Inc.
Application Type: Certification
Product: LTE Module
Model No.: FM101-NA
Brand Name: Fibocom
FCC Rule Part(s): Part 2, 22 (H), 24 (E), 27
Test Procedure(s): ANSI C63.26: 2015
Test Date: November 09 ~ 13, 2021

Reviewed By: 

Approved By: 



The test results relate only to the samples tested.

This equipment has been shown to be capable of compliance with the applicable technical standards as indicated in the measurement report and was tested in accordance with the measurement procedures specified in ANSI C63.26-2015. Test results reported herein relate only to the item(s) tested.

The test report shall not be reproduced except in full without the written approval of MRT Technology (Suzhou) Co., Ltd.

Revision History

Report No.	Version	Description	Issue Date	Note
2110RSU053-U6	Rev. 01	Initial Report	12-17-2021	Invalid
2110RSU053-U6	Rev. 02	Corrected the calibration date of equipment	12-23-2021	Valid

CONTENTS

Description	Page
1. GENERAL INFORMATION.....	5
1.1. Applicant.....	5
1.2. Manufacturer.....	5
1.3. Testing Facility.....	5
2. PRODUCT INFORMATION	6
2.1. Product Information	6
2.2. Radio Specification under Test	6
2.3. Description of Available Antennas.....	7
2.4. Test Methodology.....	7
2.5. EMI Suppression Device(s)/Modifications	7
2.6. Configuration of Tested System	8
2.7. Test Environment Condition.....	8
3. TEST EQUIPMENT CALIBRATION DATE.....	9
4. MEASUREMENT UNCERTAINTY.....	10
5. TEST RESULT	11
5.1. Summary	11
5.2. Occupied Bandwidth Measurement.....	12
5.2.1. Test Limit.....	12
5.2.2. Test Procedure.....	12
5.2.3. Test Setting	12
5.2.4. Test Setup	12
5.2.5. Test Result	13
5.3. Frequency Stability Measurement	16
5.3.1. Test Limit.....	16
5.3.2. Test Procedure.....	16
5.3.3. Test Setting	16
5.3.4. Test Setup	17
5.3.5. Test Result	18
5.4. Equivalent Isotropically Radiated Power Measurement	21
5.4.1. Test Limit.....	21
5.4.2. Test Procedure.....	21
5.4.3. Test Setting	21
5.4.4. Test Setup	22
5.4.5. Test Result	23

5.5.	Band Edge Measurement	26
5.5.1.	Test Limit.....	26
5.5.2.	Test Procedure	26
5.5.3.	Test Setting	26
5.5.4.	Test Setup	27
5.5.5.	Test Result	28
5.6.	Peak to Average Ratio Measurement	30
5.6.1.	Test Limit.....	30
5.6.2.	Test Procedure.....	30
5.6.3.	Test Setting	30
5.6.4.	Test Setup	30
5.6.5.	Test Result	31
5.7.	Conducted Spurious Emission Measurement.....	34
5.7.1.	Test Limit.....	34
5.7.2.	Test Procedure	34
5.7.3.	Test Setting	34
5.7.4.	Test Setup	35
5.7.5.	Test Result	36
5.8.	Radiated Spurious Emission Measurement.....	40
5.8.1.	Test Limit.....	40
5.8.2.	Test Procedure.....	40
5.8.3.	Test Setting	40
5.8.4.	Test Setup	40
5.8.5.	Test Result	42
6.	CONCLUSION	45
	Appendix A - Test Setup Photograph	46
	Appendix B - EUT Photograph	47

2. PRODUCT INFORMATION

2.1. Product Information

Product Name	LTE Module
Model No.	FM101-NA
Brand Name	Fibocom
IMEI	Conducted Measurement: 867141050004112 Radiated Measurement: 867141050004062
Operating Temperature	-30 ~ 75 °C
Power Type	3.135 ~ 4.4Vdc, typical 3.8Vdc
Antenna Information	Refer to Section 2.3
UMTS Specification	
Single Band	Band 2, 4, 5
Modulation	Uplink up to 16QAM, Downlink up to 64QAM
E-UTRA Specification	
Single Band	Band 2, 4, 5, 7, 12, 13, 14, 17, 25, 26, 30, 41, 42, 43, 48, 66, 71
HPUE Band	Band 41
Modulation	Uplink up to 16QAM, Downlink up to 64QAM

Note: The information of EUT was provided by the manufacturer, and the accuracy of the information shall be the responsibility of the manufacturer.

2.2. Radio Specification under Test

T _x Frequency Range:	Band II: 1850 ~ 1910MHz, Band IV: 1710 ~ 1755MHz Band V: 824 ~ 849MHz
R _x Frequency Range:	Band II: 1930 ~ 1990MHz, Band IV: 2110 ~ 2155MHz Band V: 869 ~ 894MHz

Note: For other features of this EUT, test reports will be issued separately.

2.3. Description of Available Antennas

Technology	Frequency Range (MHz)	Antenna Type	Max Peak Gain (dBi)
WCDMA Band II	1850 ~ 1910	PIFA	2.63
WCDMA Band IV	1710 ~ 1755		2.86
WCDMA Band V	824 ~ 849		1.61

2.4. Test Methodology

According to the specifications of the manufacturer, the EUT must comply with the requirements of the following standards:

- ANSI C63.26:2015
- FCC CFR 47 Part 22, Part 24, Part 27
- FCC KDB 971168 D01 v03r01: Power Meas License Digital Systems
- FCC KDB 971168 D02 v02r01: Misc Rev Approv License Devices
- FCC KDB 412172 D01 v01r01: Determining ERP and EIRP

2.5. EMI Suppression Device(s)/Modifications

No EMI suppression device(s) were added and/or no modifications were made during testing.

2.6. Configuration of Tested System

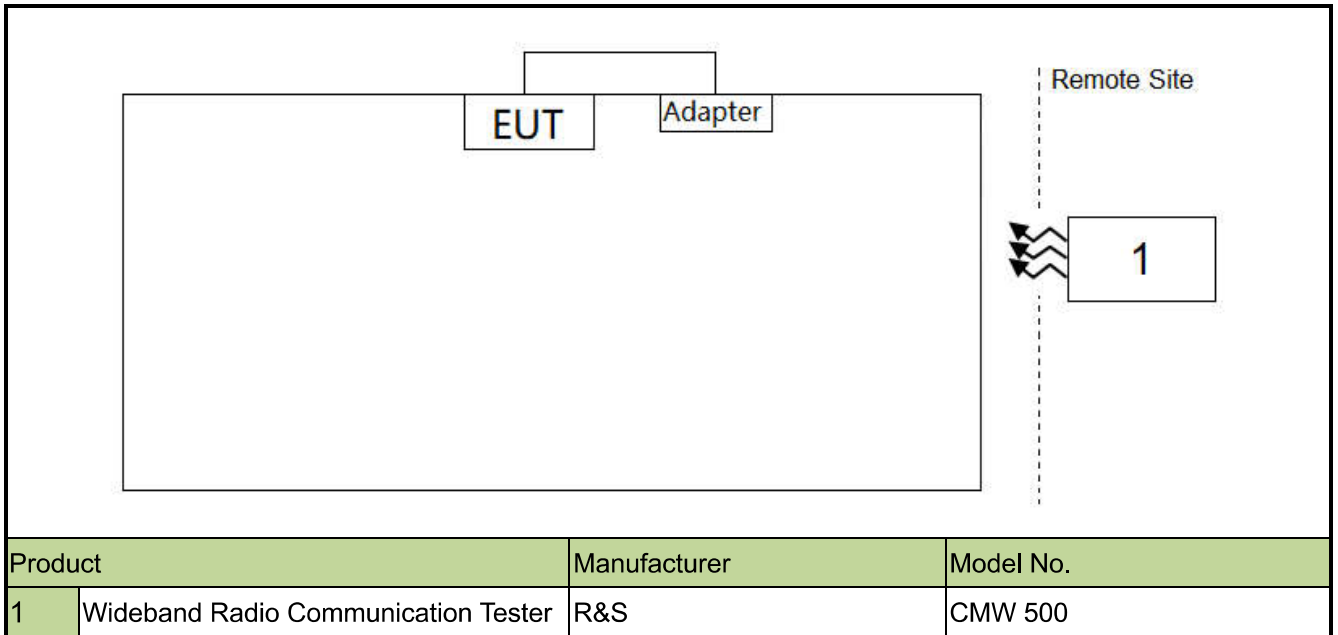

2.7. Test Environment Condition

Ambient Temperature	15 ~ 35°C
Relative Humidity	20% ~ 75%RH

3. TEST EQUIPMENT CALIBRATION DATE

Instrument Name	Manufacturer	Model No.	Asset No.	Cali. Interval	Cal. Due Date	Test Site
Communication Tester	R&S	CMU 200	MRTSUE06009	1 year	2022/9/7	SIP-SR1
Communication Tester	R&S	CMW500	MRTSUE06243	1 year	2022/10/10	SIP-SR1
Signal Generator	Keysight	E8257D	MRTSUE06453	1 year	2022/6/24	SIP-SR1
Thermohygrometer	testo	622	MRTSUE06629	1 year	2022/11/2	SIP-SR1
Signal Generator	Keysight	E8257D	MRTSUE06904	1 year	2021/12/8	SIP-SR1
DC POWER MODULE	Keysight	N6743B	MRTSUE06905	/	/	SIP-SR1
DC POWER MODULE	Keysight	N6743B	MRTSUE06906	/	/	SIP-SR1
Low-Profile Modular Power System Mainframe	Keysight	N6700C	MRTSUE06907	/	/	SIP-SR1
Signal Analyzer	Keysight	N9021B	MRTSUE06915	1 year	2022/1/18	SIP-SR1
Temperature Chamber	BAOYT	BYG-80CL	MRTSUE06932	1 year	2022/3/16	SIP-SR1
Shielding Room	MIX-BEP	SIP-SR1	MRTSUE06948	/	/	SIP-SR1
EMI Test Receiver	R&S	ESR3	MRTSUE06185	1 year	2022/1/12	SIP-AC2
Signal Analyzer	Keysight	N9010B	MRTSUE06559	1 year	2022/6/24	SIP-AC2
Horn Antenna	Schwarzbeck	BBHA 9170	MRTSUE06599	1 year	2022/10/20	SIP-AC2
Preamplifier	EMCI	EMC184045SE	MRTSUE06602	1 year	2022/10/11	SIP-AC2
Thermohygrometer	testo	608-H1	MRTSUE06623	1 year	2021/12/3	SIP-AC2
Thermohygrometer	testo	608-H1	MRTSUE06624	1 year	2021/12/3	SIP-AC2
Preamplifier	EMCI	EMC051845SE	MRTSUE06644	1 year	2021/11/26	SIP-AC2
TRILOG Antenna	Schwarzbeck	VULB 9168	MRTSUE06647	1 year	2022/8/5	SIP-AC2
Horn Antenna	Schwarzbeck	BBHA 9120D	MRTSUE06648	1 year	2021/11/26	SIP-AC2
Anechoic Chamber	RIKEN	SIP-AC2	MRTSUE06781	1 year	2021/12/24	SIP-AC2

Software	Version	Function
EMI Software	V3	EMI Test Software

4. MEASUREMENT UNCERTAINTY

Where relevant, the following test uncertainty levels have been estimated for tests performed on the EUT as specified in CISPR 16-4-2. This uncertainty represents an expanded uncertainty expressed at approximately the 95% confidence level using a coverage factor of $k = 2$.

Radiated Spurious Emissions
Measurement Uncertainty for a Level of Confidence of 95% ($U=2Uc(y)$): Horizontal: 9kHz ~ 300MHz: 5.04dB 300MHz ~ 1GHz: 4.95dB 1GHz ~ 40GHz: 6.40dB Vertical: 9kHz ~ 300MHz: 5.24dB 300MHz ~ 1GHz: 6.03dB 1GHz ~ 40GHz: 6.40dB
Conducted Spurious Emissions
Measuring Uncertainty for a Level of Confidence of 95% ($U=2Uc(y)$): 0.78dB
Output Power
Measuring Uncertainty for a Level of Confidence of 95% ($U=2Uc(y)$): 1.13dB
Occupied Bandwidth
Measuring Uncertainty for a Level of Confidence of 95% ($U=2Uc(y)$): 0.28%
Frequency Stability
Measuring Uncertainty for a Level of Confidence of 95% ($U=2Uc(y)$): 76.2Hz

5. TEST RESULT

5.1. Summary

FCC Part Section(s)	Test Description	Test Limit	Test Condition	Test Result	Reference
2.1049	Occupied Bandwidth	N/A	Conducted	Pass	Section 5.2
2.1055, 22.355 24.235, 27.54	Frequency Stability	< 2.5 ppm		Pass	Section 5.3
22.913(a)(5)	Equivalent Radiated Power (B5)	< 7 Watts Max ERP		Pass	Section 5.4
27.50(d)(4)	Equivalent Isotropic Radiated Power (B4)	< 1 Watts Max EIRP		Pass	Section 5.4
24.232(c)	Equivalent Isotropic Radiated Power (B2)	< 2 Watts Max EIRP		Pass	Section 5.4
2.1051, 22.917(a) 24.238(a), 27.53(h)	Band Edge	< 43 + 10log ₁₀ (P _[Watts])		Pass	Section 5.5
22.913(d), 24.232(d) 27.50(d)(5)	Peak to Average Ratio	< 13dB		Pass	Section 5.6
2.1051, 22.917(a) 24.238(a), 27.53(h)	Spurious Emission	< 43 + 10log ₁₀ (P _[Watts])	Pass	Section 5.7	
2.1053, 22.917(a) 24.238(a), 27.53(h)	Spurious Emission	< 43 + 10log ₁₀ (P _[Watts])	Radiated	Pass	Section 5.8

Notes:

- 1) The analyzer plots shown in this report were all taken with a correction table loaded into the analyzer. The correction table was used to account for the losses of the cables and attenuators used as part of the system to connect the EUT to the analyzer at all frequencies of interest.
- 2) Pre-scan has been conducted to determine the worst-case mode from all possible combinations between available modulations the worst-case was found.
- 3) All supported modulation types were evaluated. The worst-case emission of modulation was selected. Therefore, the Frequency Stability, Band Edge, Radiated & Conducted Spurious Emission were presented worst case in the test report.

5.2. Occupied Bandwidth Measurement

5.2.1. Test Limit

The occupied bandwidth, that is the frequency bandwidth such that, below its lower and above its upper frequency limits, the mean powers radiated are each equal to 0.5 percent of the total mean power radiated by a given emission shall be measured.

5.2.2. Test Procedure

ANSI C63.26-2015 - Section 5.4

5.2.3. Test Setting

1. Set center frequency to the nominal EUT channel center frequency
2. RBW = The nominal RBW shall be in the range of 1% to 5% of the anticipated OBW
3. VBW $\geq 3 \times$ RBW
4. Detector = Peak
5. Trace mode = max hold
6. Sweep = auto couple
7. Allow the trace to stabilize
8. Use the 99% power bandwidth function of the instrument and report the measured bandwidth.

5.2.4. Test Setup

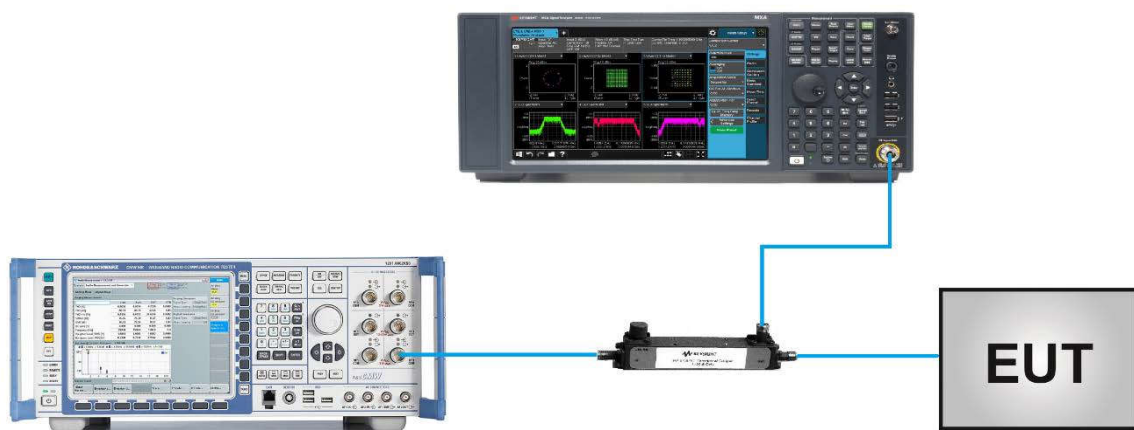

5.2.5. Test Result

Product	LTE Module	Test Site	SIP-SR1
Test Engineer	Candy Luo	Test Date	2021/11/09
Test Band	WCDMA Band II		

Channel	Frequency (MHz)	99% Bandwidth (MHz)
Low	1852.4	4.13
Middle	1880.0	4.14
High	1907.6	4.13



Product	LTE Module	Test Site	SIP-SR1
Test Engineer	Candy Luo	Test Date	2021/11/10
Test Band	WCDMA Band IV		

Channel	Frequency (MHz)	99% Bandwidth (MHz)
Low	1712.4	4.12
Middle	1732.4	4.13
High	1752.6	4.14



Product	LTE Module	Test Site	SIP-SR1
Test Engineer	Candy Luo	Test Date	2021/11/10
Test Band	WCDMA Band V		

Channel	Frequency (MHz)	99% Bandwidth (MHz)
Low	826.4	4.13
Middle	836.4	4.14
High	846.6	4.12



5.3. Frequency Stability Measurement

5.3.1. Test Limit

The frequency stability shall be measured by variation of ambient temperature and variation of primary supply voltage to ensure that the fundamental emission stays within the authorized frequency block. The frequency stability of the transmitter shall be maintained within $\pm 0.00025\%$ ($\pm 2.5\text{ppm}$) of the center frequency.

5.3.2. Test Procedure

ANSI C63.26-2015 - Section 5.6

5.3.3. Test Setting

Frequency Stability Under Temperature Variations:

The equipment under test was connected to an external AC or DC power supply and input rated voltage. RF output was connected to a frequency counter or spectrum analyzer via feed through attenuators. The EUT was placed inside the temperature chamber. Set the spectrum analyzer RBW low enough to obtain the desired frequency resolution and measure EUT 20°C operating frequency as reference frequency. Turn EUT off and set the chamber temperature to High. After the temperature stabilized for approximately 30 minutes recorded the frequency. Repeat step measure with 10°C decreased per stage until the Low temperature reached.

Frequency Stability Under Voltage Variations:

Set chamber temperature to 20°C. Use a variable AC power supply / DC power source to power the EUT and set the voltage to rated voltage. Set the spectrum analyzer RBW low enough to obtain the desired frequency resolution and recorded the frequency.

Reduce the input voltage to specify extreme voltage variation ($\pm 15\%$) and endpoint, record the maximum frequency change.

5.3.4. Test Setup

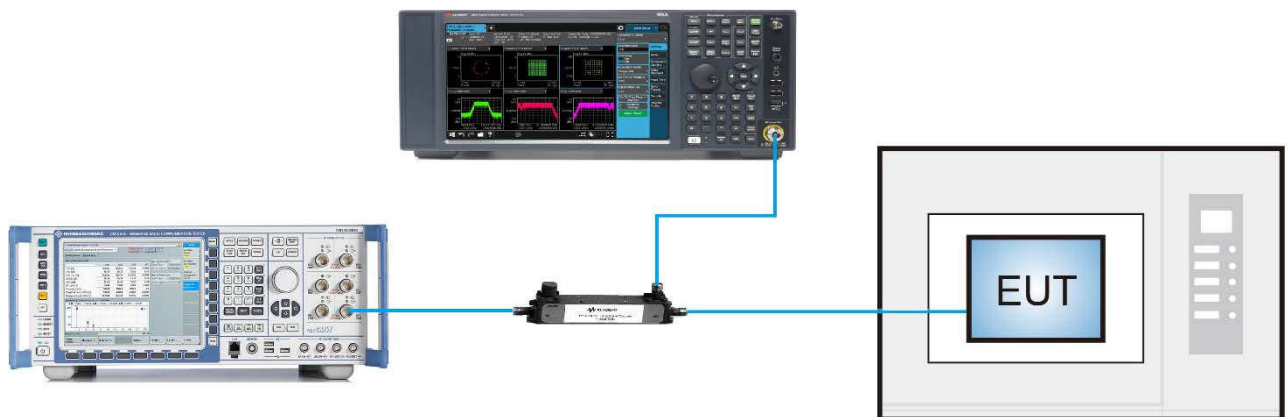

5.3.5. Test Result

Product	LTE Module	Test Site	SIP-SR1
Test Engineer	Candy Luo	Test Date	2021/11/10
Test Band	WCDMA Band II		

Power (Vdc)	Temp. (°C)	Frequency Tolerance (ppm)
3.8	- 30	0.0070
	- 20	0.0051
	- 10	0.0056
	0	0.0061
	+ 10	0.0053
	+ 20	0.0057
	+ 30	0.0056
	+ 40	0.0058
	+ 50	0.0071
4.4	+ 20	0.0059
3.135	+ 20	0.0067

Product	LTE Module	Test Site	SIP-SR1
Test Engineer	Candy Luo	Test Date	2021/11/10
Test Band	WCDMA Band IV		

Power (Vdc)	Temp. (°C)	Frequency Tolerance (ppm)
3.8	- 30	0.0029
	- 20	0.0023
	- 10	0.0032
	0	0.0033
	+ 10	0.0035
	+ 20	0.0029
	+ 30	0.0027
	+ 40	0.0035
	+ 50	0.0013
4.4	+ 20	0.0031
3.135	+ 20	0.0029

Product	LTE Module	Test Site	SIP-SR1
Test Engineer	Candy Luo	Test Date	2021/11/10
Test Band	WCDMA Band V		

Power (Vdc)	Temp. (°C)	Frequency Tolerance (ppm)
3.8	- 30	0.0011
	- 20	-0.0009
	- 10	0.0023
	0	-0.0019
	+ 10	0.0016
	+ 20	-0.0007
	+ 30	-0.0023
	+ 40	0.0015
	+ 50	0.0008
4.4	+ 20	-0.0017
3.135	+ 20	0.0004

5.4. Equivalent Isotropically Radiated Power Measurement

5.4.1. Test Limit

Band 2:

Mobile and portable stations are limited to 2 watts EIRP and the equipment must employ a means for limiting power to the minimum necessary for successful communications.

Band 4:

Fixed, mobile, and portable (hand-held) stations operating in the 1710-1755 MHz band and mobile and portable stations operating in the 1695-1710 MHz and 1755-1780 MHz bands are limited to 1 watt EIRP.

Band 5:

The ERP of mobile transmitters and auxiliary test transmitters must not exceed 7 watts.

5.4.2. Test Procedure

ANSI C63.26-2015 - Section 5.2

5.4.3. Test Setting

Average power measurements were performed only when the EUT was transmitting at its maximum power control level using a broadband power meter with a pulse sensor. The power meter implemented triggering and gating capabilities which were set up such that power measurements were recorded only during the ON time of the transmitter.

The relevant equation for determining the maximum ERP or EIRP from the measured RF output power is given in Equation (1) as follows:

$$\text{ERP or EIRP} = P_{\text{Meas}} + G_{\text{T}}$$

where

ERP or EIRP effective radiated power or equivalent isotropically radiated power, respectively (expressed in the same units as P_{Meas} , e.g., dBm or dBW)

P_{Meas} measured transmitter output power or PSD, in dBm or dBW

G_{T} gain of the transmitting antenna, in dBd (ERP) or dBi (EIRP)

$$\text{ERP} = \text{EIRP} - 2.15$$

5.4.4. Test Setup



5.4.5. Test Result

Product	LTE Module	Test Site	SIP-SR1
Test Engineer	Candy Luo	Test Date	2021/11/10
Test Band	WCDMA Band II		

Mode	3GPP Subtest	Conducted Power (dBm)			Antenna Gain (dBi)	EIRP (dBm)		
		Band II Channel				Band II Channel		
		9262	9400	9538		9262	9400	9538
WCDMA R99	1	24.07	23.88	23.83	2.63	26.70	26.51	26.46
HSDPA	1	23.03	22.88	22.78	2.63	25.66	25.51	25.41
	2	23.05	22.88	22.73	2.63	25.68	25.51	25.36
	3	22.54	22.40	22.27	2.63	25.17	25.03	24.90
	4	22.54	22.39	22.33	2.63	25.17	25.02	24.96
HSUPA	1	23.06	22.80	22.67	2.63	25.69	25.43	25.30
	2	20.99	20.76	20.73	2.63	23.62	23.39	23.36
	3	22.00	21.99	21.74	2.63	24.63	24.62	24.37
	4	20.92	20.93	20.75	2.63	23.55	23.56	23.38
	5	22.85	22.90	22.65	2.63	25.48	25.53	25.28
Limit	33.01dBm							

Note: The EIRP (dBm) = Conducted Power (dBm) + Antenna Gain (dBi)

Product	LTE Module	Test Site	SIP-SR1
Test Engineer	Candy Luo	Test Date	2021/11/10
Test Band	WCDMA Band IV		

Mode	3GPP Subtest	Conducted Power (dBm)			Antenna Gain (dBi)	EIRP (dBm)		
		Band IV Channel				Band IV Channel		
		1312	1412	1513		1312	1412	1513
WCDMA R99	1	23.96	24.06	24.28	2.86	26.82	26.92	27.14
HSDPA	1	23.00	23.11	23.27	2.86	25.86	25.97	26.13
	2	22.95	23.08	23.21	2.86	25.81	25.94	26.07
	3	22.43	22.61	22.72	2.86	25.29	25.47	25.58
	4	22.54	22.58	22.73	2.86	25.40	25.44	25.59
HSUPA	1	22.89	23.06	23.15	2.86	25.75	25.92	26.01
	2	20.90	21.14	21.28	2.86	23.76	24.00	24.14
	3	21.86	22.12	22.19	2.86	24.72	24.98	25.05
	4	20.94	21.15	21.14	2.86	23.80	24.01	24.00
	5	22.88	22.94	23.16	2.86	25.74	25.80	26.02
Limit	30.00dBm							

Note: The EIRP (dBm) = Conducted Power (dBm) + Antenna Gain (dBi)

Product	LTE Module	Test Site	SIP-SR1
Test Engineer	Candy Luo	Test Date	2021/11/10
Test Band	WCDMA Band V		

Mode	3GPP Subtest	Conducted Power (dBm)			Antenna Gain (dBi)	ERP (dBm)		
		Band V Channel				Band V Channel		
		4132	4182	4233		4132	4182	4233
WCDMA R99	1	23.87	24.02	24.11	1.61	23.33	23.48	23.57
HSDPA	1	22.90	23.03	23.14	1.61	22.36	22.49	22.60
	2	22.91	23.06	23.17	1.61	22.37	22.52	22.63
	3	22.41	22.57	22.62	1.61	21.87	22.03	22.08
	4	22.43	22.49	22.62	1.61	21.89	21.95	22.08
HSUPA	1	22.95	22.94	23.24	1.61	22.41	22.40	22.70
	2	20.93	21.09	21.14	1.61	20.39	20.55	20.60
	3	21.85	22.09	22.15	1.61	21.31	21.55	21.61
	4	20.97	20.94	21.05	1.61	20.43	20.40	20.51
	5	23.03	22.86	22.94	1.61	22.49	22.32	22.40
Limit	38.45dBm							

Note: The ERP (dBm) = Conducted Power (dBm) + Antenna Gain (dBi) – 2.15

5.5. Band Edge Measurement

5.5.1. Test Limit

For operations in the 824 ~ 849 MHz, 1850 ~ 1910 MHz, 1930 ~ 1990 MHz, 698 ~ 746 MHz and 1710 ~ 1755 MHz, the FCC limit is $43 + 10\log_{10}(P_{[\text{Watts}]})$ dB below the transmitter power P(Watts) in a 1 MHz bandwidth. However, in the 1MHz bands immediately outside and adjacent to the licensee's frequency block, a resolution bandwidth of at least one percent of the emission bandwidth of the fundamental emission of the transmitter may be employed.

5.5.2. Test Procedure

ANSI C63.26-2015 - Section 5.7

5.5.3. Test Setting

1. Set the analyzer frequency to low or high channel
2. $RBW \geq$ The nominal RBW shall be in the range of 1% of the anticipated OBW (in the 1MHz band immediately outside and adjacent to the band edge). For improvement of the accuracy in the measurement of the average power of a noise-like emission, a RBW narrower than the specified reference bandwidth can be used (generally limited to no less than 1% of the OBW), provided that a subsequent integration is performed over the full required measurement bandwidth. This integration should be performed using the spectrum analyzer's band power functions.
3. $VBW \geq 3*RBW$
4. Sweep time = auto
5. Detector = power averaging (rms)
6. Set sweep trigger to "free run."
7. User gate triggered such that the analyzer only sweeps when the device is transmitting at full power
8. Trace average at least 100 traces in power averaging (rms) mode if sweep is set to auto-couple. To accurately determine the average power over the on and off time of the transmitter, it can be necessary to increase the number of traces to be averaged above 100, or if using a manually configured sweep time, increase the sweep time.

5.5.4. Test Setup

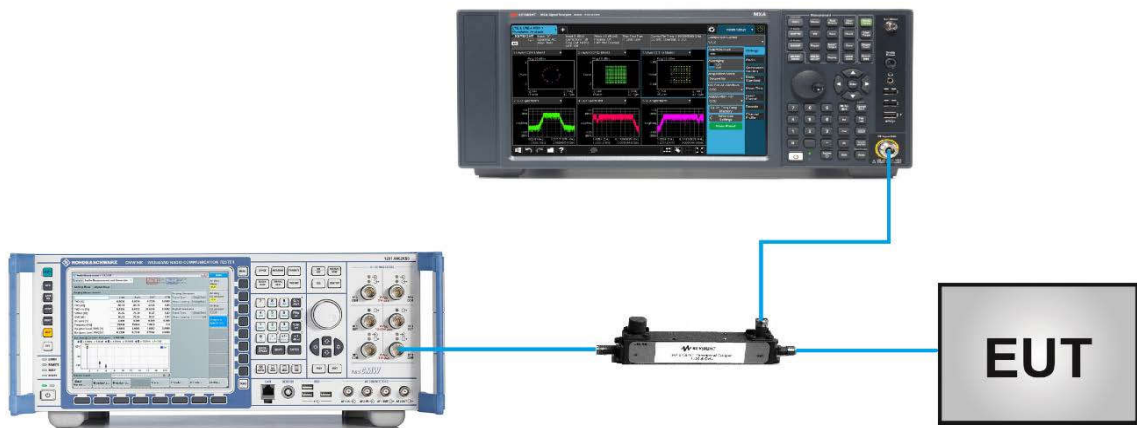

5.5.5. Test Result

Product	LTE Module	Test Site	SIP-SR1
Test Engineer	Candy Luo	Test Date	2021/11/10
Test Band	WCDMA Band II, IV, V		

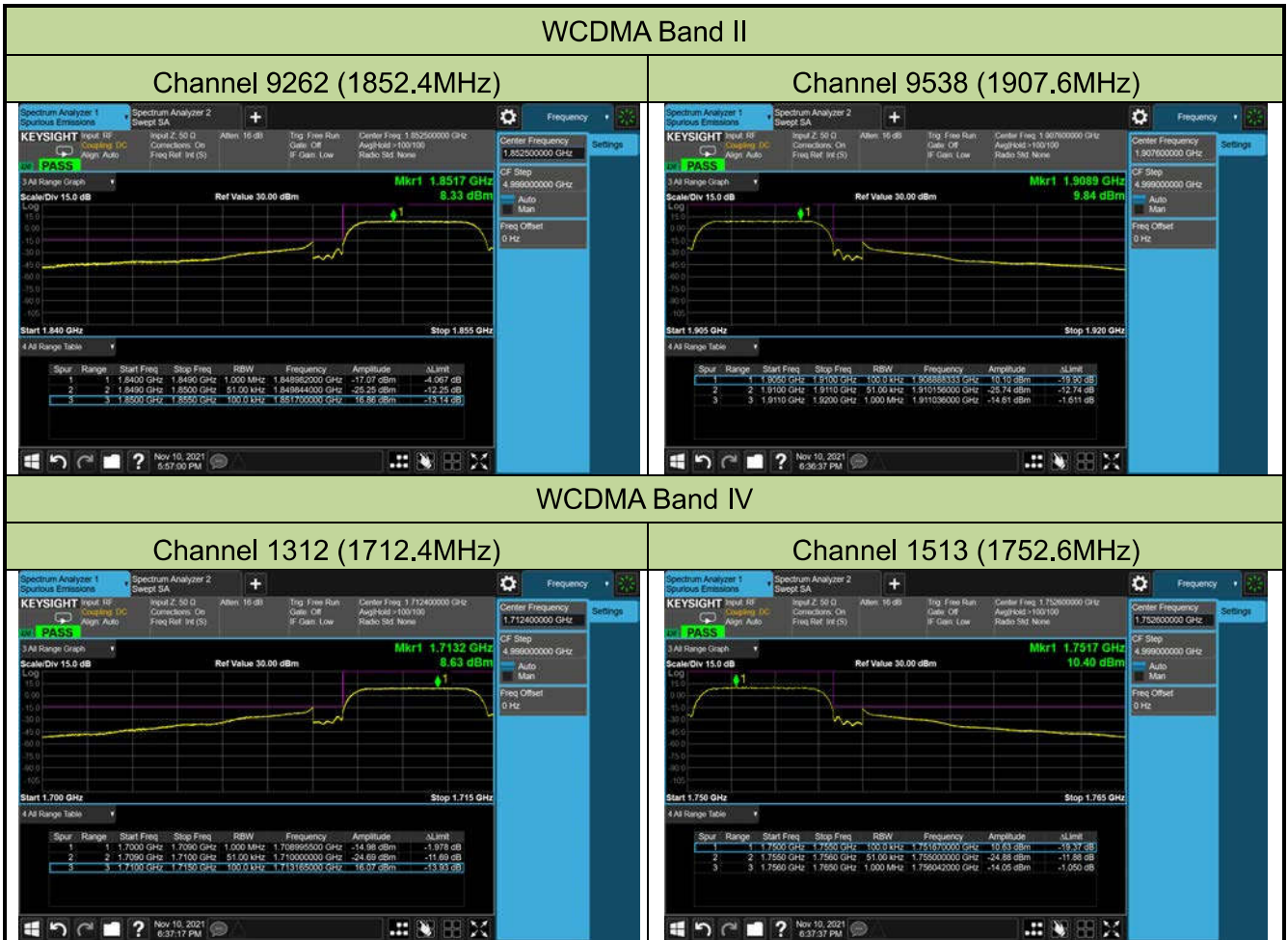

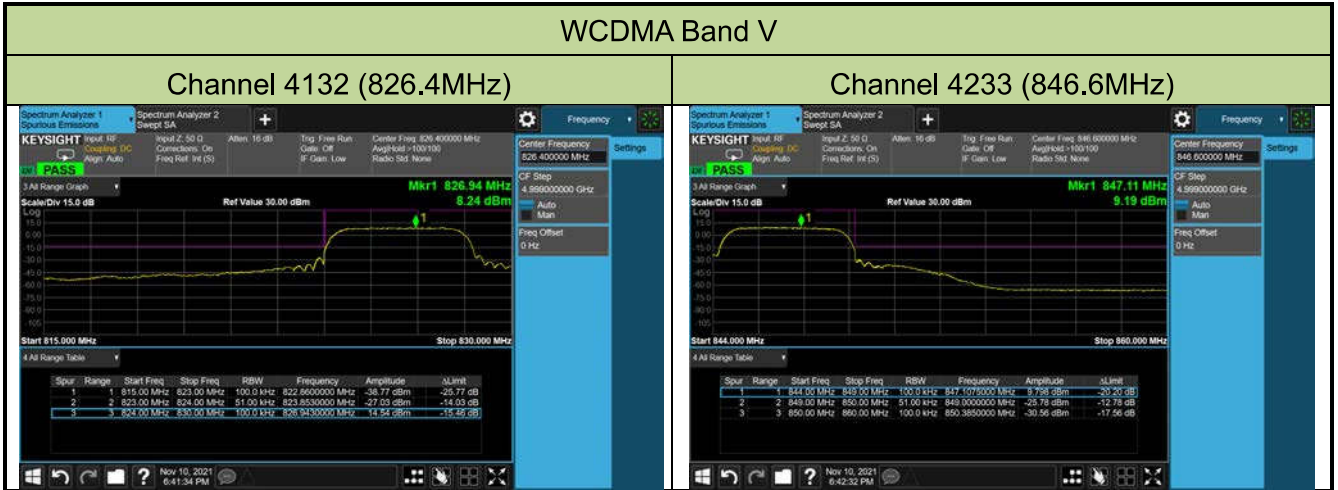

5.6. Peak to Average Ratio Measurement

5.6.1. Test Limit

A peak to average ratio measurement is performed at the conducted port of the EUT. The spectrum analyzers Complementary Cumulative Distribution Function (CCDF) measurement profile is used to determine the largest deviation between the average and the peak power of the EUT in a given bandwidth. The CCDF curve shows how much time the peak waveform spends at or above a given average power level. The percent of time the signal spends at or above the level defines the probability for that particular power level.

5.6.2. Test Procedure

ANSI C63.26-2015 - Section 5.2.3.4 (CCDF).

5.6.3. Test Setting

1. Set the resolution / measurement bandwidth \geq signal's occupied bandwidth
2. Set the number of counts to a value that stabilizes the measured CCDF curve
3. Record the maximum PARR level associated with a probability of 0.1%

5.6.4. Test Setup

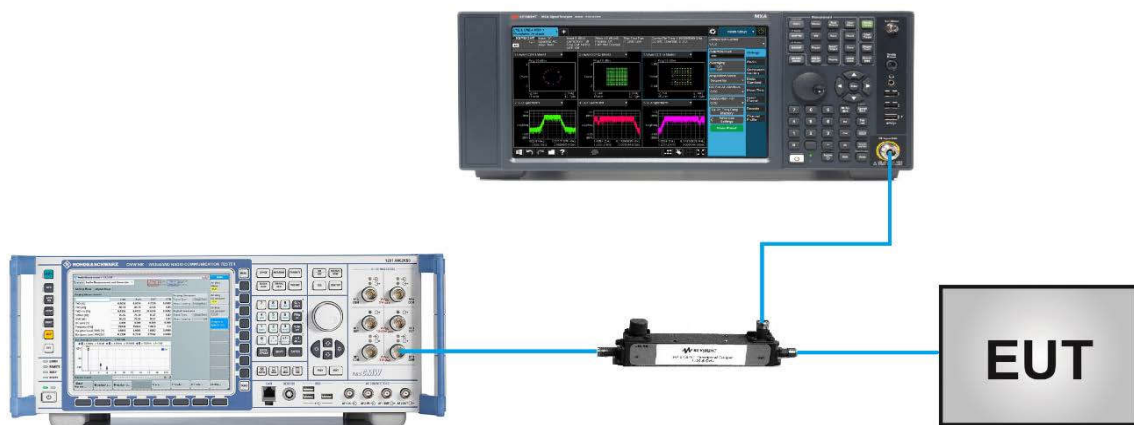

5.6.5. Test Result

Product	LTE Module	Test Site	SIP-SR1
Test Engineer	Candy Luo	Test Date	2021/11/10
Test Band	WCDMA Band II, IV, V		

Channel No.	Frequency (MHz)	Channel Bandwidth (MHz)	Peak to Average Ratio (dB)	Limit (dB)	Result
Band II					
9262	1852.5	5	3.09	≤ 13.00	Pass
9400	1880.0	5	2.60	≤ 13.00	Pass
9538	1907.6	5	3.09	≤ 13.00	Pass
Band IV					
1312	1712.4	5	3.08	≤ 13.00	Pass
1412	1732.4	5	2.87	≤ 13.00	Pass
1513	1752.6	5	3.01	≤ 13.00	Pass
Band V (Report Only)					
4132	826.4	5	3.14	≤ 13.00	Pass
4183	836.4	5	3.14	≤ 13.00	Pass
4233	846.6	5	3.00	≤ 13.00	Pass

WCDMA Band II

Channel 9262 (1852.4MHz)



Channel 9400 (1880.0MHz)



Channel 9538 (1907.6MHz)



WCDMA Band IV

Channel 1312 (1712.4MHz)



Channel 1412 (1732.4MHz)

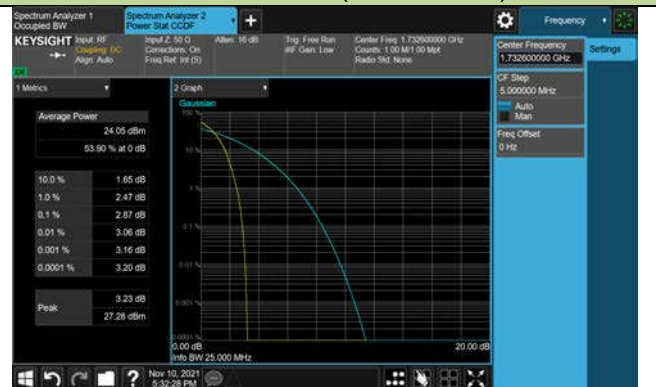

Channel 1513 (1752.6MHz)



WCDMA Band V

Channel 4132 (826.4MHz)

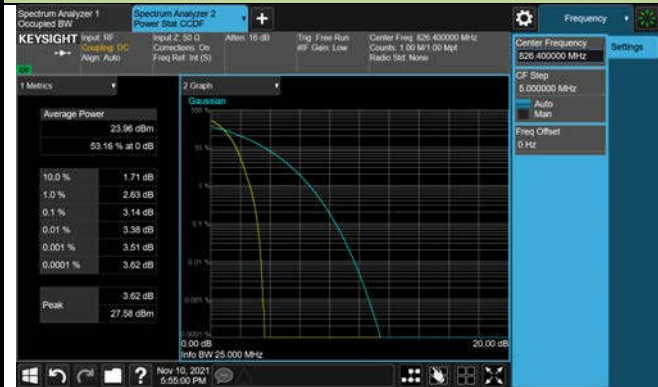

Channel 4183 (836.4MHz)

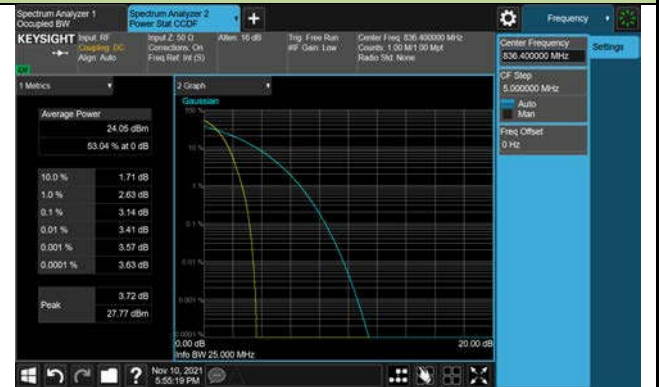

Channel 4233 (846.6MHz)

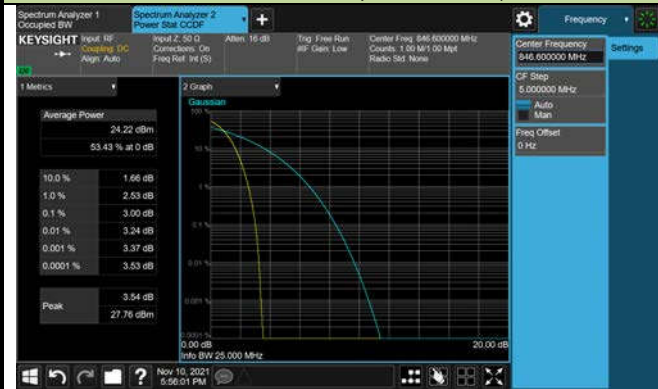

5.7. Conducted Spurious Emission Measurement

5.7.1. Test Limit

The level of the carrier and the various conducted spurious and harmonic frequencies is measured by means of a calibrated spectrum analyzer. The spectrum is scanned from the Low frequency generated in the equipment up to a frequency including its 10th harmonic. All out of band emissions are measured with a spectrum analyzer connected to the antenna terminal of the EUT while the EUT is operating at its maximum duty cycle, at maximum power, and at the appropriate frequencies. All data rates were investigated to determine the worst-case configuration. All modes of operation were investigated and the worst-case configuration results are reported in this section.

The power of any emission outside of the authorized operating frequency ranges must be attenuated below the transmitting power (P) by a factor of at least $43 + 10 \log(P)$ dB.

5.7.2. Test Procedure

ANSI C63.26-2015 - Section 5.7

5.7.3. Test Setting

1. Set the analyzer frequency to low, mid, high channel.
2. RBW = 1MHz
3. VBW $\geq 3 \cdot$ RBW
4. Sweep time = auto
5. Detector = power averaging (rms)
6. Set sweep trigger to "free run."
7. User gate triggered such that the analyzer only sweeps when the device is transmitting at full power.
8. Trace average at least 100 traces in power averaging (rms) mode if sweep is set to auto-couple.
To accurately determine the average power over the on and off time of the transmitter, it can be necessary to increase the number of traces to be averaged above 100, or if using a manually configured sweep time, increase the sweep time.

5.7.4. Test Setup



5.7.5. Test Result

Product	LTE Module	Test Site	SIP-SR1
Test Engineer	Candy Luo	Test Date	2021/11/10
Test Band	WCDMA Band II, IV, V		

Mode	Frequency (MHz)	Frequency Range (MHz)	Max Spurious Emissions (dBm)	Limit (dBm)	Result
WCDMA Band II	1852.4	30 ~ 20000	-36.41	≤ -13.00	Pass
	1880.0	30 ~ 20000	-36.43	≤ -13.00	Pass
	1907.6	30 ~ 20000	-35.73	≤ -13.00	Pass
WCDMA Band IV	1712.4	30 ~ 20000	-35.96	≤ -13.00	Pass
	1732.4	30 ~ 20000	-36.30	≤ -13.00	Pass
	1752.6	30 ~ 20000	-36.18	≤ -13.00	Pass
WCDMA Band V	826.4	30 ~ 10000	-38.03	≤ -13.00	Pass
	836.4	30 ~ 10000	-37.10	≤ -13.00	Pass
	846.6	30 ~ 10000	-36.35	≤ -13.00	Pass

Note: Spurious emissions within 9kHz – 30MHz were found more than 20dB below limit line.

WCDMA Band II

Low Channel

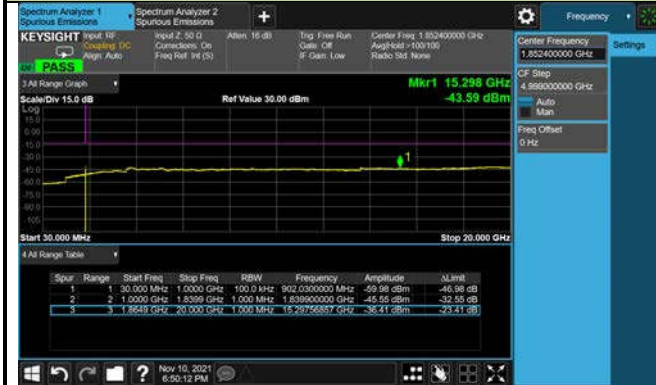

Middle Channel

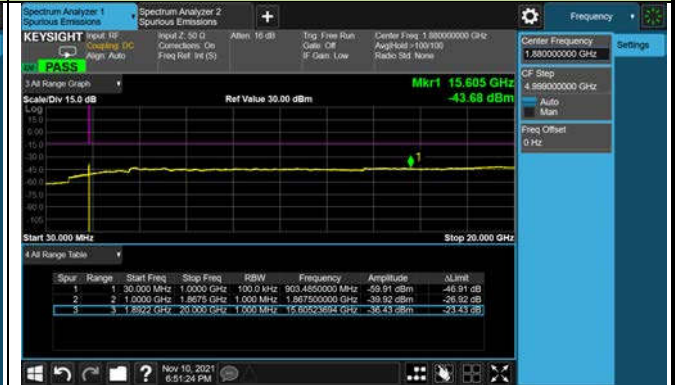

High Channel

