

Installation guide R&MinteliPhy

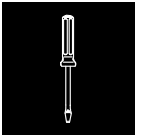

021.3477

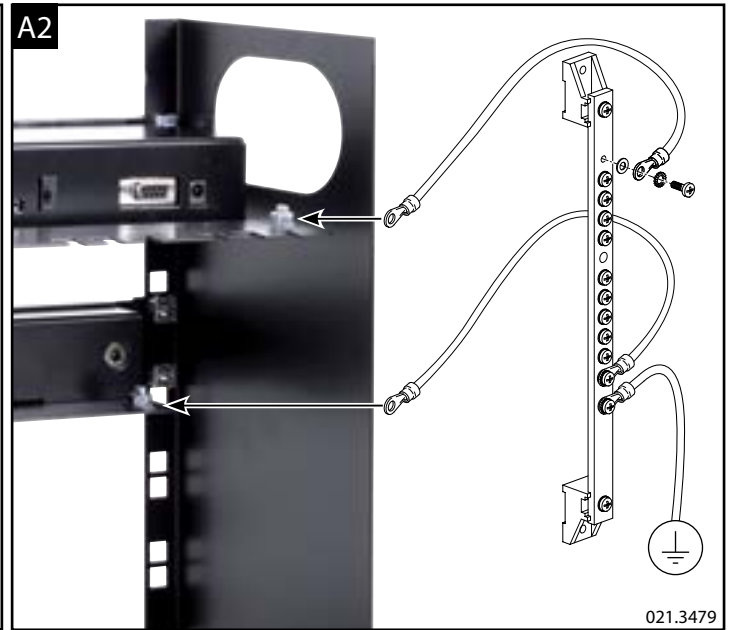

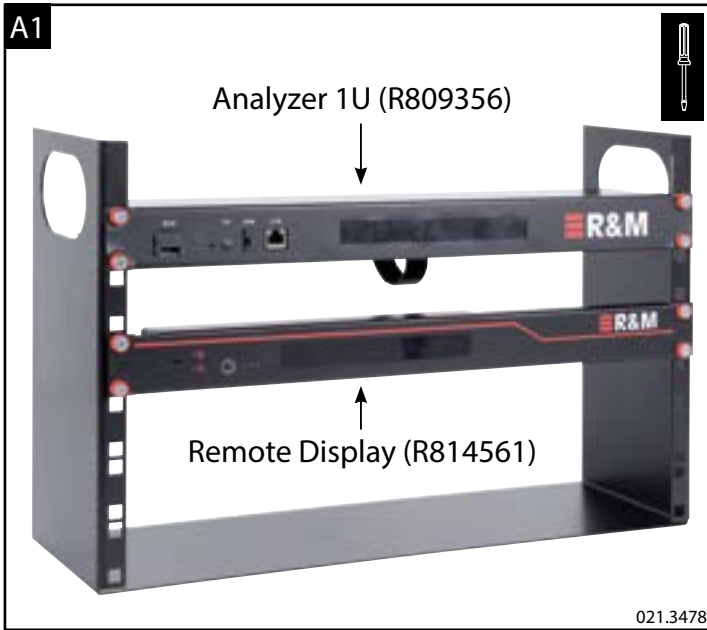
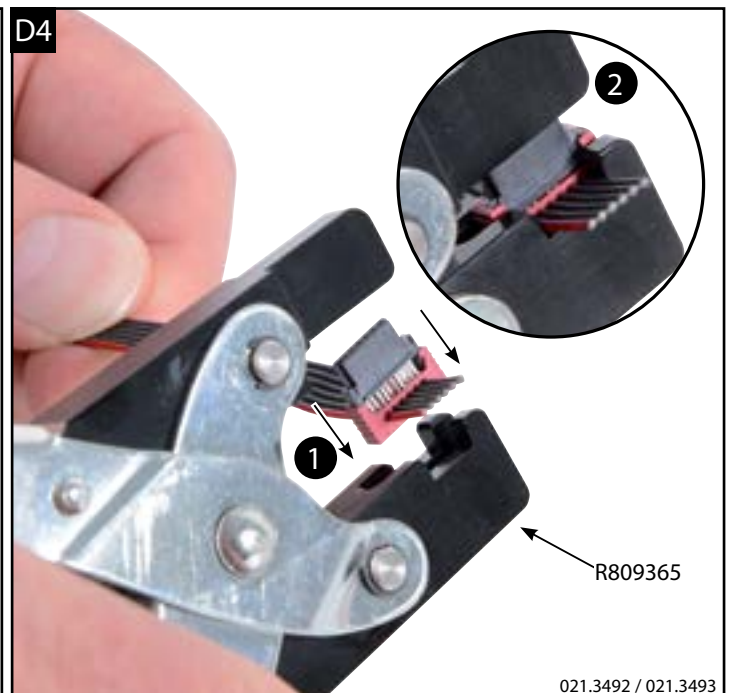
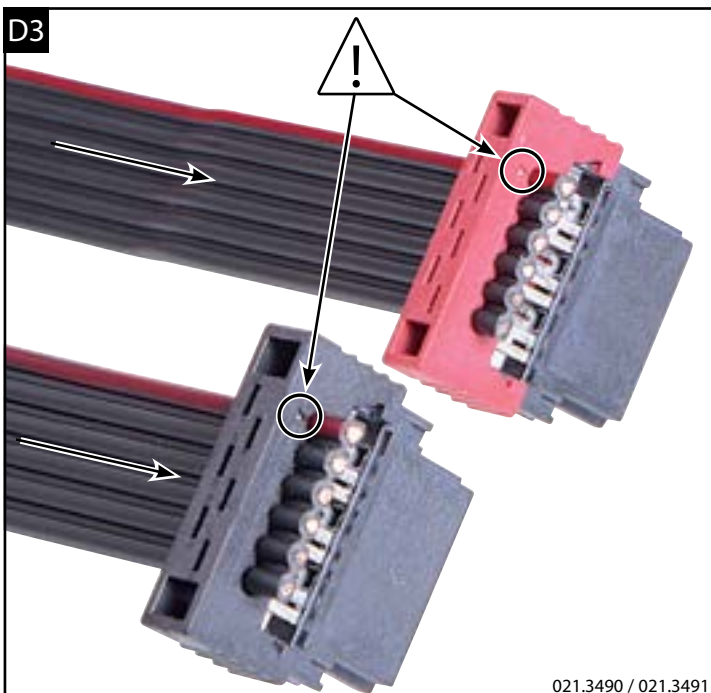
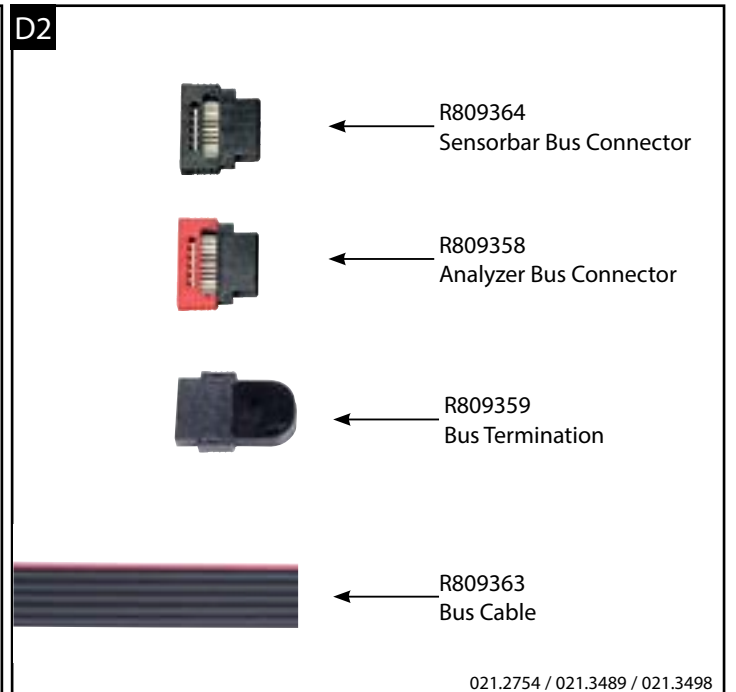
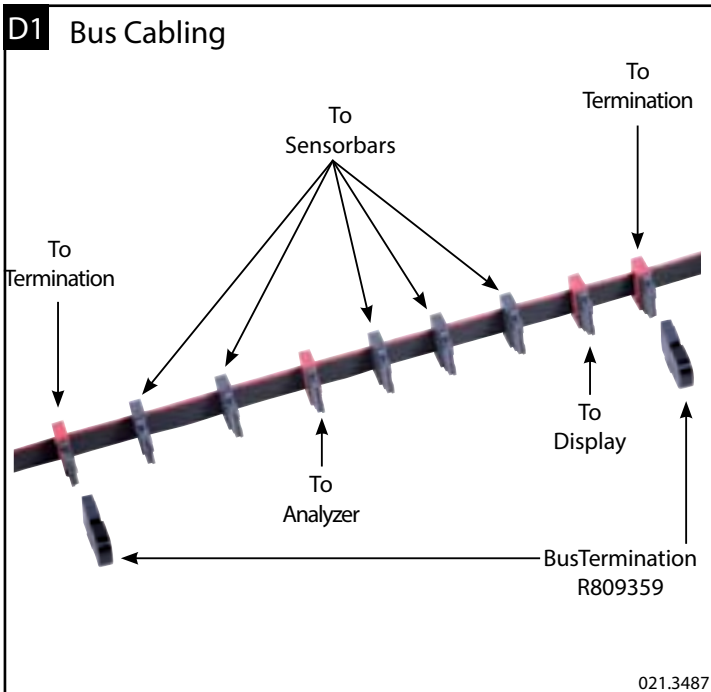

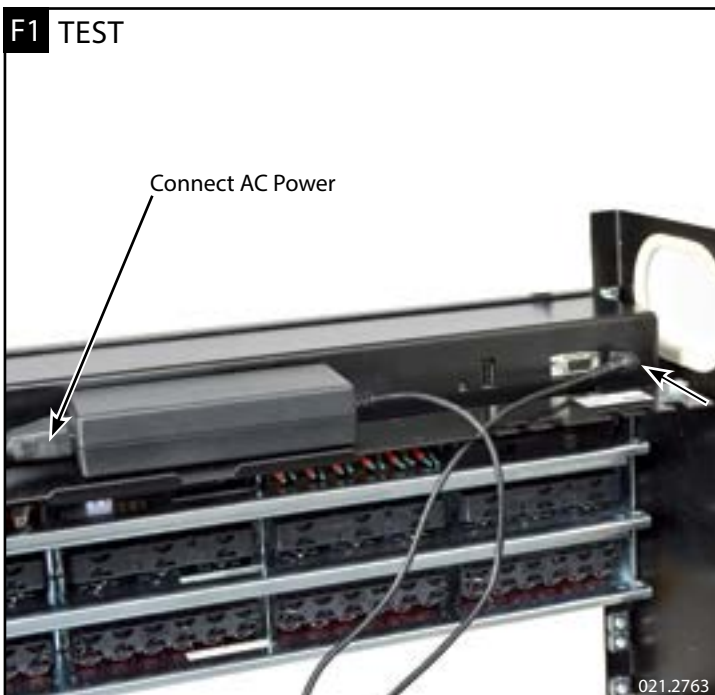

F1 TESTMODE

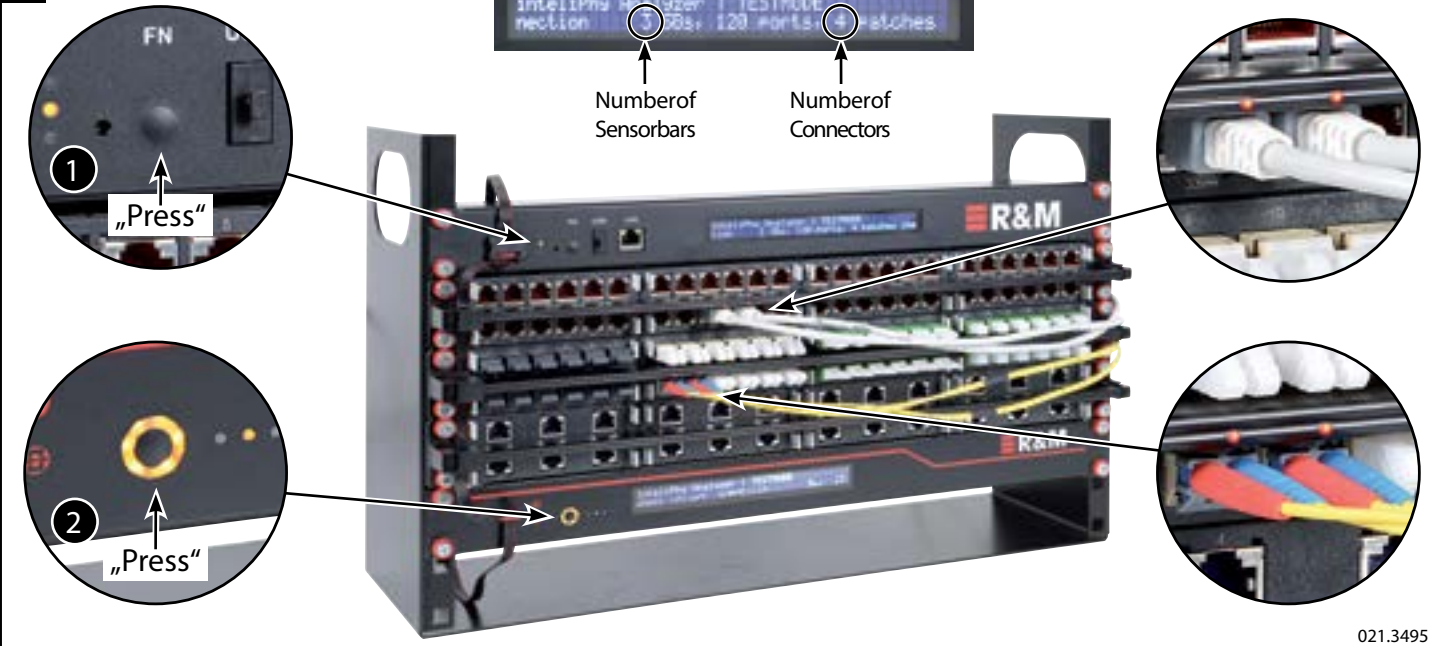

021.3495

G

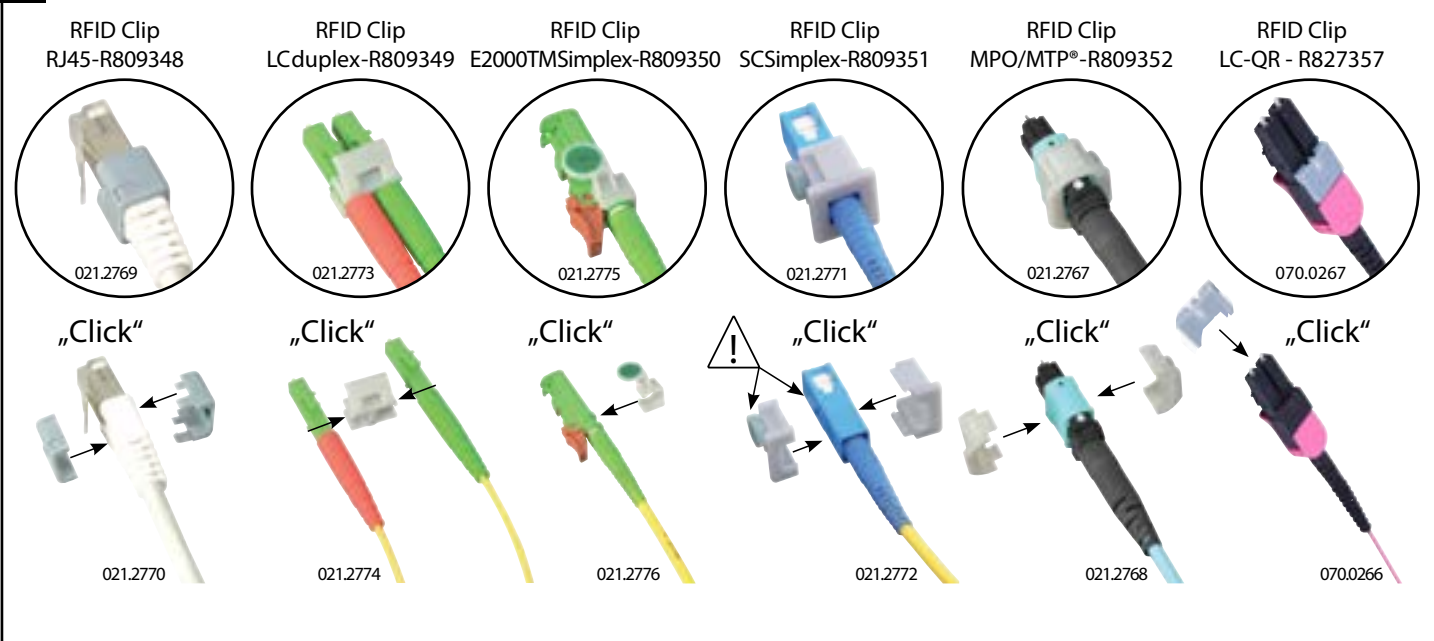

H

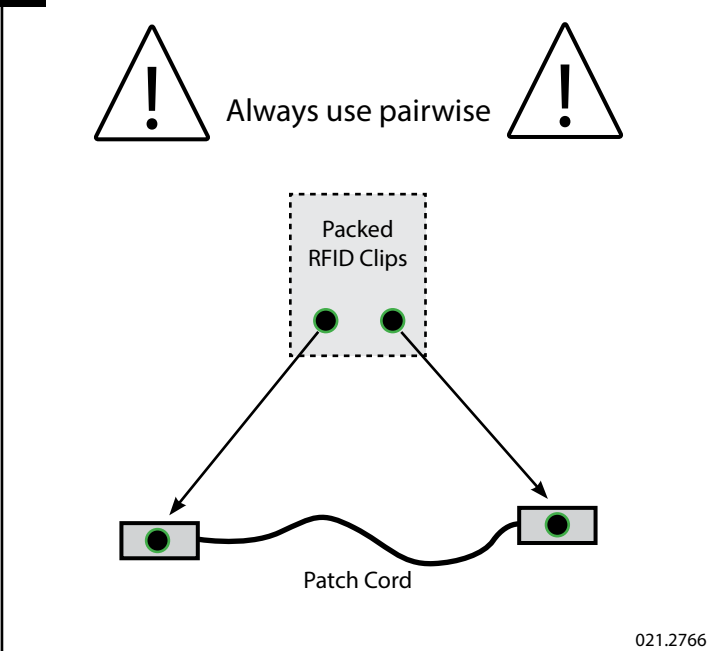

021.2766

NOTICE for R837017:

This device complies with Part 15 of the FCC Rules. Operation is subject to the following two conditions:
 (1) this device may not cause harmful interference, and
 (2) this device must accept any interference received, including interference that may cause undesired operation.

Changes or modifications made to this equipment not expressly approved by Reichle & De-Massari AG may void the FCC authorization to operate this equipment.

This equipment has been tested and found to comply with the limits for a Class B digital device, pursuant to part 15 of the FCC Rules. These limits are designed to provide reasonable protection against harmful interference in a residential installation. This equipment generates, uses and can radiate radio frequency energy and, if not installed and used in accordance with the instructions, may cause harmful interference to radio communications. However, there is no guarantee that interference will not occur in a particular installation. If this equipment does cause harmful interference to radio or television reception, which can be determined by turning the equipment off and on, the user is encouraged to try to correct the interference by one or more of the following measures:

- Reorient or relocate the receiving antenna.
- Increase the separation between the equipment and receiver.
- Connect the equipment into an outlet on a circuit different from that to which the receiver is connected.
- Consult the dealer or an experienced radio/TV technician for help.

Headquarters
Switzerland
 Reichle & De-Massari AG
 Binzstrasse 32
 CHE-8620 Wetzikon
 Telephone HQ +41 44 933 81 11
 Telefax HQ +41 44 930 49 41
 E-Mail hq@rdm.com
www.rdm.com

