

A80 user manual

1. This manual is designed for the usage of A80, applying to A80 automotive diagnosis platform.

No part of this manual can be reproduced, stored in a retrieval system or transmitted, in any form or by any means (electronic, mechanical, photocopying, recording, or otherwise), without the prior written permission of Xtool.

2. This electronic control system diagnostic unit is designed for professional vehicle maintenance technicians. It has a certain reliability, however, it can not exclude vehicle damage and loss caused by customer technical problems, vehicle problems or other factors, so users need to take risks.

3. Use the device only as described in this manual. The user will be responsible solely for the after-effects of violating the laws and regulations caused by using the product or its data information, Xtool will not bear any legal responsibility for that.

4. Xtool shall not be liable for any incidental or consequential damages or for any economic consequential damages arising from the accidents of individual users and the third parties, misuse or abuse of the device, unauthorized change or repair of the device, or the failure made by the user not to use the product according to the manual.

5. All information, specifications and illustrations in this manual are based on the latest configurations and functions available at the time of printing. Xtool reserves the right to make changes at any time without notice.

6. **XTOOL** is the registered trademark of Shenzhen Xtooltech Co., Ltd.

7. In countries that the trademarks, service marks, domain names, logos and the name of the company are not registered, Xtool claims that it still reserves the ownership of the unregistered trademarks, service marks, domain names, logos and the company name. All

other marks for the other products and the company's name mentioned in the manual still belong to the original registered company. You may not use the trademarks, service marks, domain names, logos and company name of Xtool or other companies mentioned without written permission from the trademark holder.

8. Please visit <http://www.xtooltech.com> for more information about A80 BT.

9. Xtool reserves the right for the final interpretation of this manual content.

Contents

Chapter I About A80 BT	3
1. Appearance.....	3
2. Layout of A80 BT Tablet	5
2.1 Top View of A80 BT Tablet	5
2.2 Side View of A80 BT Tablet	5
2.3 Outline diagram of VCI diagnostic kit	6
2.4 A80 BT technical parameters	7
Chapter II How to use A80 BT	8
1. A80 BT activation	8
2. A80 BT main interface and function buttons description.....	10
2.1 Main interface	10
2.2 Sub-menu and function buttons.....	10
2.3 Toolbar functional buttons	13
3. Connection diagnosis	14
3.1 Vehicle Connection test.....	14
3.2 Precautions Before Use	15
4. Diagnosis.....	16
4.1 Menu selection:	17

4.2 Test function:	18
4.3 Read ECU:	21
4.4 Read DTCs:	22
4.5 Clear DTCs:	23
4.6 Read live Data:.....	24
4.7 Special function:	25
4.8 Actuating components test:	25
5. Setting:.....	26
6. Diagnose report.....	30
6.1 Diagnose report:.....	30
6.2 Data playback.....	31
7. One-click upgrade:.....	31
8. Xtool Cloud System.....	32
9. Remote control:.....	33
Chapter III Location of Diagnostic link connectors on Different vehicle Models.....	35
1. Diagnostic link connectors locations of various vehicle models:	35
2. Location diagram of vehicle diagnostic link connectors:.....	39
3. Diagnostic Link Connectors Terminal Definition and Communication Protocols.....	40
Chapter IV Additional Information.....	43
1. Description of OBDII and the function of sensor components.....	43
1.1 OBDII function description.....	43
1.2 Sensor element function.....	45
2. Common faults and elimination of electronic control system.....	51

ChapterI About A80 BT

1. Appearance

1.1 Front view



1.2 Back view



2. Layout of A80 BT Tablet

2.1 Top View of A80 BT Tablet

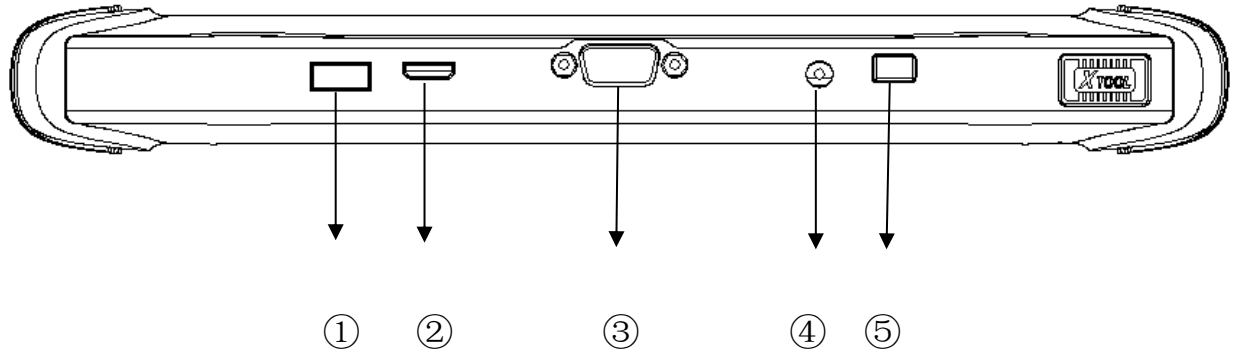

①USB3.0 interface: Wired data transmission

②Mini HDMI interface: Transmission of audio and video

③DB15 interface: Subsequent extended reservation port

④DC charging port: Charge for equipment, use 12V power supply

⑤Power Button: Power on or power off

2.2 Side View of A80 BT Tablet

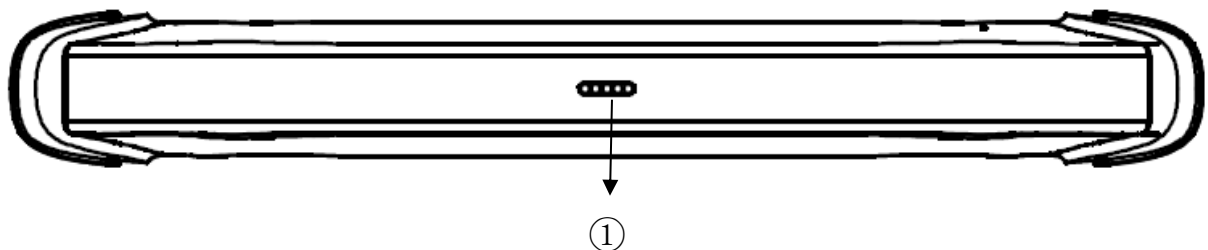

①Seat adapter: This is reserved for the socket, and can be charged with charging.

2.3 Outline diagram of VCI diagnostic kit

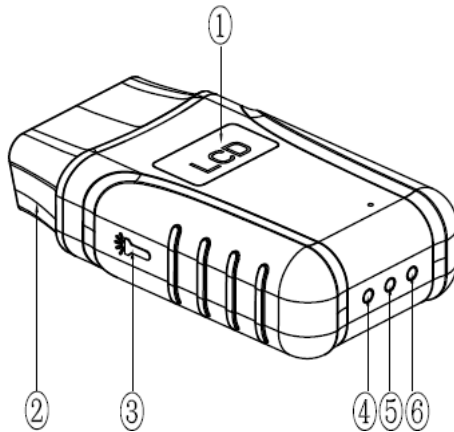

①Display: For voltage display

②OBD interface (head): Used to connect vehicles with international standard OBDII diagnostic seats.

③Lighting switch: Press the button, the lighting will be on, that convenient for users to find OBD diagnostic seat or other lighting.

④Bluetooth indicator: Bluetooth connection is successful, the indicator is blue; Bluetooth is not connected, the indicator is not on.

⑤Power indicator: The light is red after the power is connected.

⑥Vehicle diagnostic light: Entering the diagnostic system shows a green light flashing.

Function

VCI diagnostic box function: After inserting the vehicle diagnostic seat, it connects with A80 BT host computer by Bluetooth to realize wireless data transmission.

2.4 A80 BT technical parameters

Operating system: Android

Processor: quad core processor 1.8GHz

Memory: 2GRAM, 32GROM

Display / touch screen: 1024 • 768 resolution, 8 inch LED

Compatible touch screen

Camera: rear camera, 8 million pixels, with flash autofocus.

Sensor: gravity sensor

Audio input / output: microphone, 4 band 3.5 millimeter stereo.

Interface: USB3.0, DC charging port, MINI HDMI, DB15 interface.

Battery: 10000mAh 3.7V lithium polymer battery

Input voltage: +9~+36VDC, compatible with 12V and 24V voltage system.

Working temperature: -20 to 50 C (-4 to 126 C)

Relative humidity: <90%

Appearance size: 275 • 183 • 33.9 (mm)

Chapter II How to use A80 BT

1. A80 BT activation

1.1 In order not to affect the using and upgrading of newly released software, please be sure to activate A80 BT.

Skip

XTOOL

Activation code...

User name...

Password...

A80-000001

Email...

Confirm password...

Activate

1.2 First turn on the A80 BT host, enter the tablet setting function to enable the WLAN function, and connect to the wireless network. Click the A80 BT Diagnostics icon to activate the page: 1. Enter the activation code on the certificate; 2. Enter the six digits after the S/N code on the certificate; 3. Enter a username, such as A repair shop; 4, please enter the correct format of the mailbox account; 5 and 6, please enter a consistent custom password in the two columns. After clicking the activation, you will be prompted to verify the mobile number. Please enter the mobile number, receive the SMS verification code, and enter the verification code in A80 BT.

Note: In order to improve A80 BT, every time period, Xtool will update A80 BT, pop up the update box directly on the diagnosis interface, click

to install.

2. A80 BT main interface and function buttons description

2.1 Main interface

After A80 BT boot, the main interface and sub menu are shown below. ▼





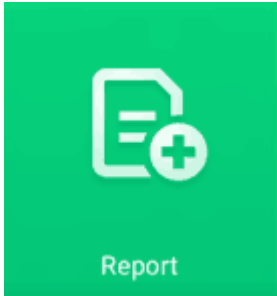

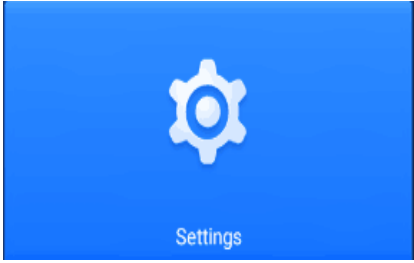
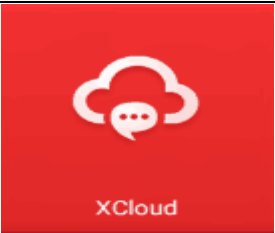
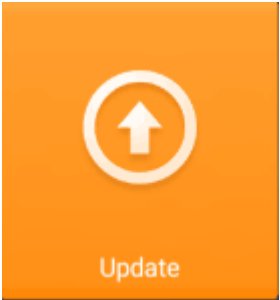

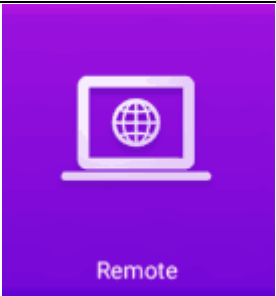
2.2 Sub-menu and function buttons

Functional Buttons	Functional descriptions
	<p>Diagnostic functions and special functions enter the button, and then select the desired functions for operation, such as reading diagnostic information, viewing data flow parameters, performing motion tests, special functions, etc.</p>
	<p>During the diagnosis of the vehicle, all diagnostic operations will be recorded, the exit system will prompt whether to save, the choice will be saved in the diagnostic report, such as vehicle information, system information, diagnostic information, test date, etc; enter the read data stream function, click data stream playback, the recorded dynamic data stream will be saved in the data stream playback, enter the diagnostic report, select the</p>

	<p>corresponding date and model to view.</p>
	<p>By selecting “Setting”, users can access the language setting and other system related settings.</p>
	<p>Online communication cloud Platform.</p>
	<p>After the user activates, you can upgrade the newly developed diagnostic software by directly clicking the one-click upgrade. The software is continuously updated. Please pay attention to the official website upgrade announcement or public announcement, and upgrade in time.</p>

	<p>This feature can accept Remote Assistance from the Xtool company Technical Support Center.</p>
---	---

2.3 Toolbar functional buttons

Functional Buttons	Descriptions
	<p>Return to previous interface</p>
	<p>decrease volume</p>
	<p>increase volume</p>
	<p>Return to the main interface of Android system</p>
	<p>Display recent usage procedures</p>
	<p>Press this button for screen captures.</p>
	<p>Click this button to return to the diagnostic vehicle interface, and the Bluetooth connection light will be shown in blue.</p>



Click this button to return to the diagnostic vehicle models interface.

3. Connection diagnosis

3.1 Vehicle Connection test

(1) The A80 BT host is connected to the vehicle through the VCI diagnostic box with the main test line.

(2) Turn on the car ignition switch and press the A80 BT key to diagnose the vehicle (see diagram below).

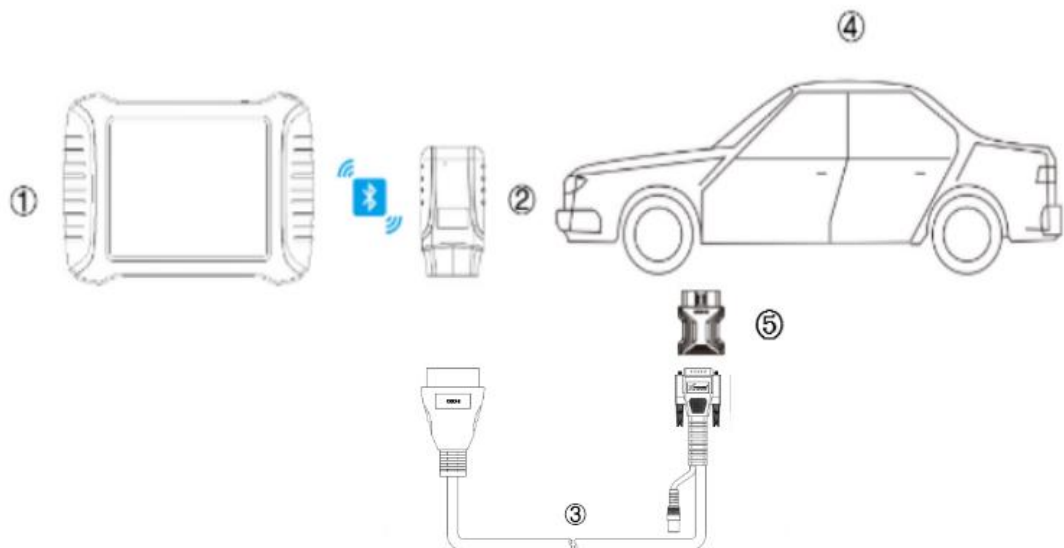

- ① A80 BT Mainframe
- ② VCI box (can be directly connected to the vehicle diagnostic seat or select ③⑤ Accessory after connecting the vehicle diagnostic seat)
- ③ Adapter cable (optional for non-standard OBD II 16pin connectors)
- ④ Measured vehicle
- ⑤ Adapter (optional for non-standard OBD II 16pin connectors)

3.2 Precautions Before Use

- (1) Battery voltage range on the car: +9~+36VDC.
- (2) When the test harness is unplugged, the application hand pinch the head of the front end of the wire harness to unplug, do not pull the middle segment of the wiring bundle, and the plug connection beam sees the direction of the corresponding interface flat plug, and does not tend to be inserted to avoid damaging the terminal.
- (3) When carrying out some special functions tests, users are required to operate the device according to operating instructions. For some tests the vehicle has to meet certain requirements, for example: engine temperature 80°C/105°C, turn off loads (such as headlights, air-conditioner, etc.), put accelerator pedal in released position, etc.

(4) As the domestic models equipped with the electronic control system is messy, such as the failure to test or test data is not correct, consider the selected menu and the measured electronic control system is appropriate, you can find the vehicle ECU, through the ECU sticker model for menu selection.

(5) You may not have a software upgrade or consult with the company's technical services when you do not find the vehicle or electronic control system in the A80 BT test menu.

(6) It is forbidden to use the wiring harness of the non-Xtool technology company to test the connection to avoid unnecessary loss.

(7) In A80 BT and vehicle communication, the direct shutdown is prohibited. You should cancel the task before returning to the main interface for shutdown.

(8) The use of A80 BT should be lightly handled, as far as possible to avoid vibration or impact. To ensure the service life of the touchscreen, touch the screen gently.

(9) During long period of non-use, please disconnect the power and then turn off the A80 BT unit.

4. Diagnosis

4.1 Menu selection:

(1) After the VCI box is connected to the car and the A80 BT host is successfully paired with the wireless Bluetooth, the diagnostic interface can be performed as shown in the following figure



(2) The menu can be selected according to your needs: Choose European car to enter the European car system, choose Asian Car Show Asian menu, choose the American Car into the American menu, choose the domestic car into the domestic menu, according to the model of the diagnosis of the choice of car system to enter the search. You can quickly search by clicking on the magnifying glass icon in the top right corner and entering models.

(3) In addition to common system troubleshooting, the development team also develops a range of special diagnostic functions for some vehicles, as follows.

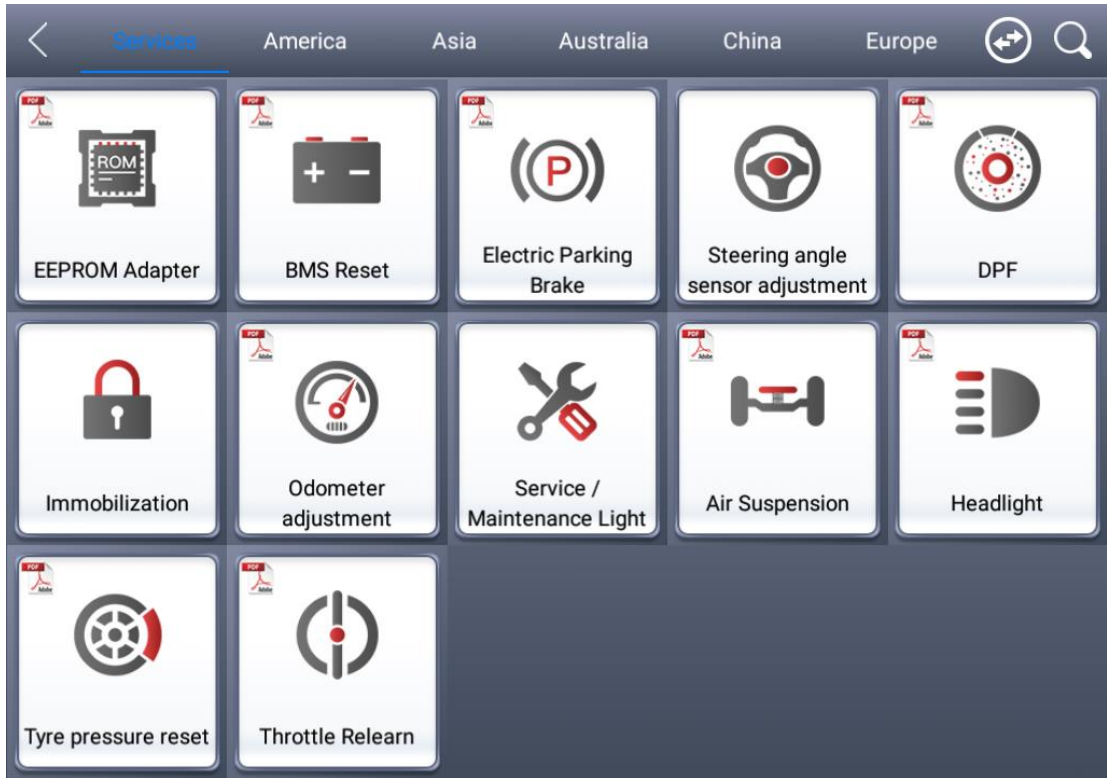

4.2 Test function:

(1) Using "BMW car" as an example, select "Royal Car V8.70", and then select the "GX9" menu to enter, you can see the "Engine system" icon, find the UMC engine system (UDS), click into the following image:

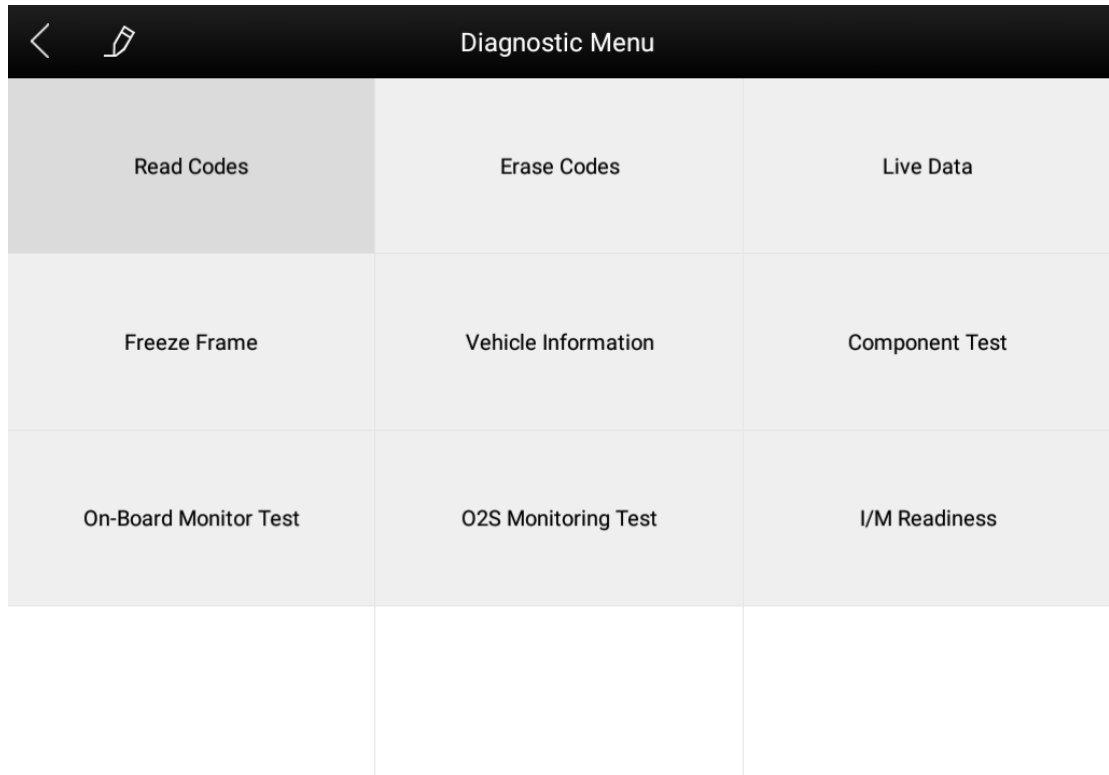

The main function menu for different cars is slightly different, and the following options are included in the common main features menu:

Read version information: This function reads the ECU version information and displays it as “system identification” or “system information” menu in some electronic control. It has the same meaning, and reads the software and hardware versions related to the ECU, the model of the diesel engine, Information such as the date of manufacture and part number. It is convenient for us to make records during the maintenance process, and also facilitate future data feedback and data management.

Read ECU: read the current fault code in the ECU.

Read DTCs: Read the fault codes of the history store in the ECU.

Clear DTCs: Clear the current and historical fault code memory stored in the ECU. It can be cleared only after all faults have been eliminated. If there is a fault that is not eliminated, the fault code cannot be successfully cleared. The fault code is always stored in the ECU and read this fault code ever. Recommendation: Do not remove the fault code casually. After reading the fault code, we must first record the fault content for the maintenance reference. When the fault is processed, there will be no fault code after re-reading the fault code.



Read live data: It is to read the parameters of the current engine running, such as oil pressure, temperature, engine speed, fuel temperature, coolant temperature, intake air temperature and so on. Through these parameters, we can basically directly determine which problems have occurred, so that we have narrowed the scope when performing maintenance, which is more convenient. For many vehicles in the actual operation process, because of the deviation of the operating characteristics of the electronic components, the sensitivity reduction, which all can be judged in the data stream; For this function, we need to be very familiar with the parameters of the engine, such as: idle speed For 800RPM or 750RPM, when the operating temperature of the coolant

is 80-105 degrees Celsius, the operating voltage and time of each sensor and actuator should be.

Actuation components test: The main purpose is to determine whether these actuator components are working properly.

Special Features: Special models only.

(2) Toolbar function buttons description

Functional Buttons	Descriptions
	Returns to the previous interface.
	Click to record the data, click again to send your feedback to XTOOL service center.

4.3 Read ECU:

(1) This function is to read the ECU version information, in some of the electronic control displayed as "System identification" or "System Information" menu, the meaning is the same., It reads the ECU related software, hardware version and part number and other information. As shown in the following figure.

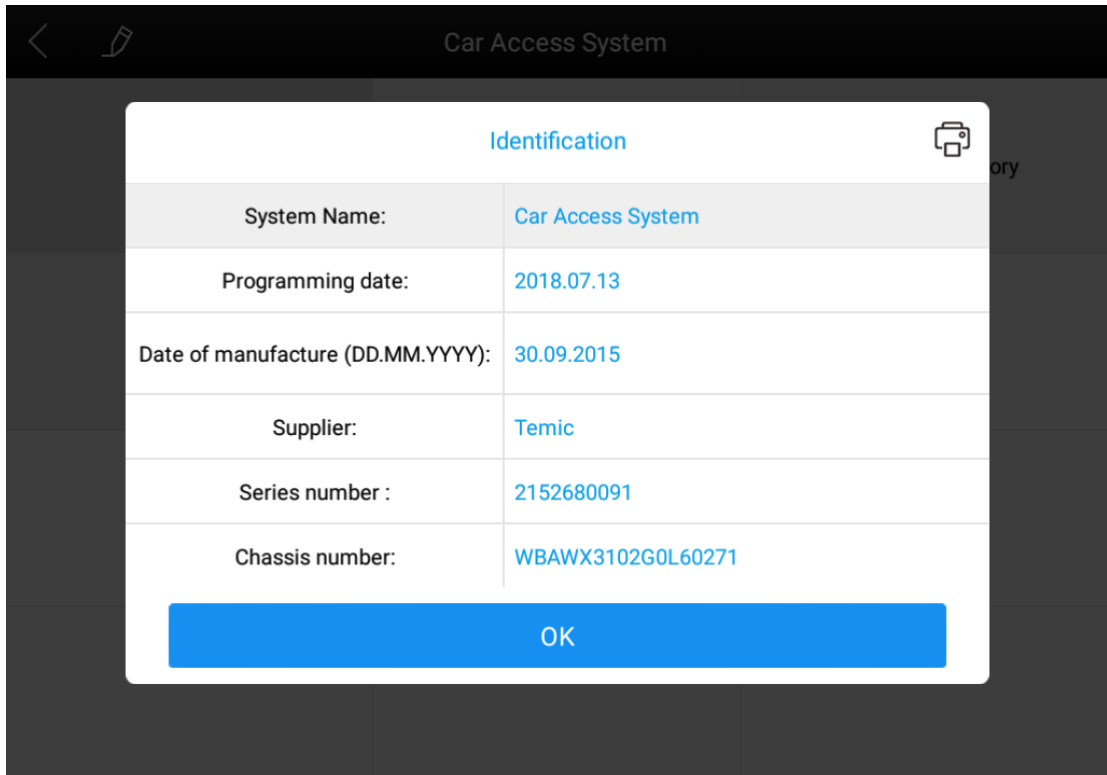

4.4 Read DTCs:

Select the "Read fault code" function to read the electronic control ECU stored in the fault code, read the fault code when the screen will display the read fault code and fault code definition, as shown in the figure below. ▼



Tip: When the fault vehicle is detected, if the "system normal" or "No Trouble code" is displayed, the ECU does not store the relevant fault code or some fault phenomenon is not in the ECU monitoring range, many belong to the mechanical system or circuit failure, it is possible that the sensor in the range of signal deviation, This can be judged in the data flow function.

4.5 Clear DTCs:

(1) After returning to the previous step, select the "Clear Code" function to clear the ECU stored in the current and historical fault code memory, the implementation of this function will be the current fault

code and the history of the fault code to clear all, clear the fault code before you need to confirm the failure code to record. As shown in the following figure.

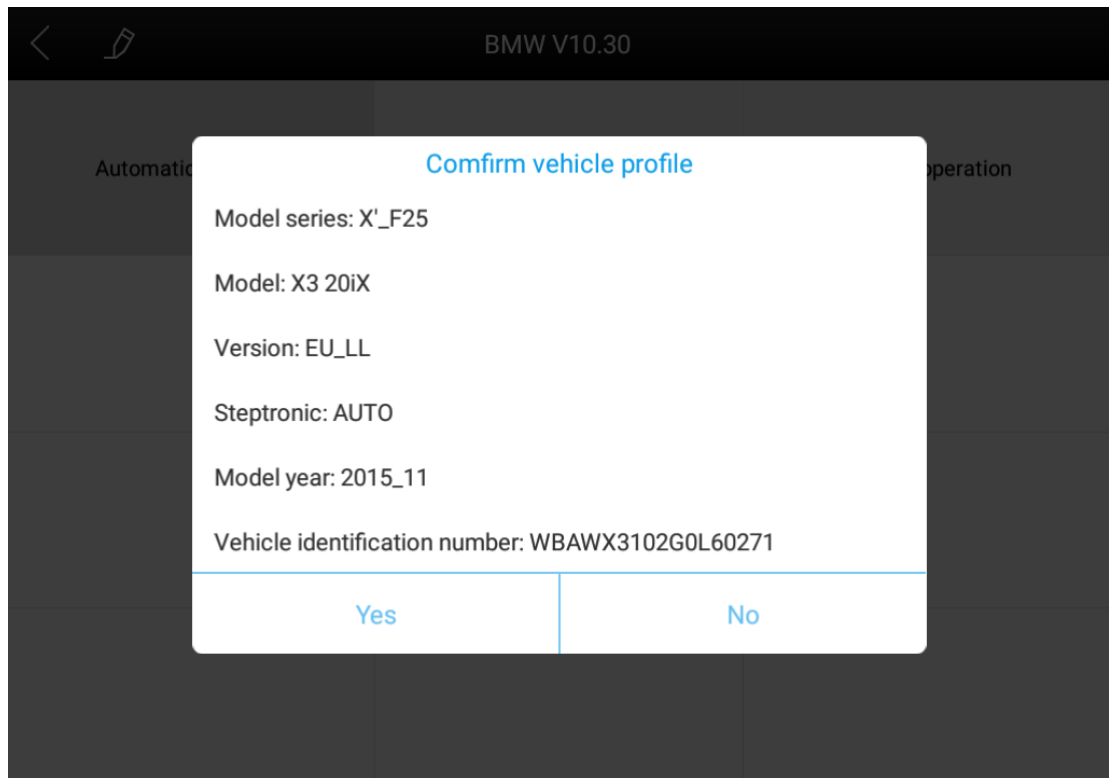

(2) Click "Yes" confirmation after clearing the fault code, such as normal communication will show "failure code cleanup success" or "fault code has been cleared", usually after clearing the fault code and read the code to confirm the failure code is cleared.

4.6 Read live Data:

Click "Save As Reference" function key, will save this model the current data stream of this system as a reference; Click the "Data Playback" function key to record the current data stream Dynamic Data,

please go to the diagnostic report inside the data playback for review.

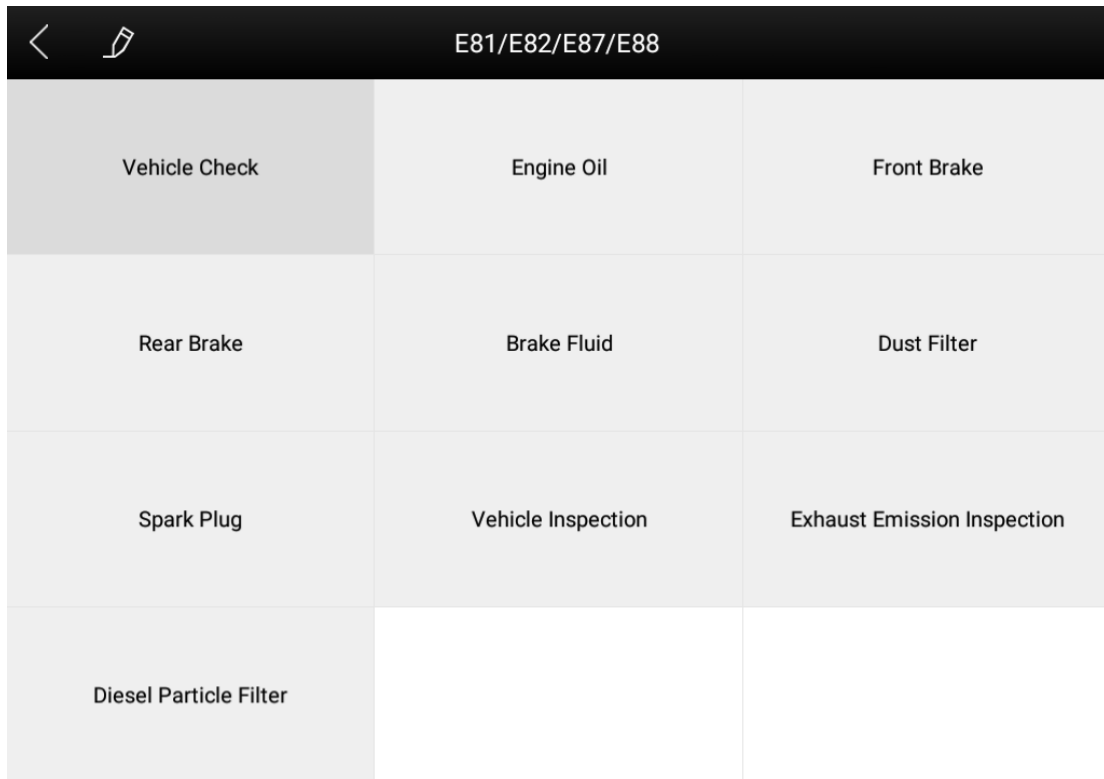

The screenshot shows a mobile application interface with a black header bar containing a back arrow, a pencil icon, and the text 'E81/E82/E87/E88'. Below the header is a grid of light gray rectangular buttons with black text. The buttons are arranged in four rows and three columns, with the last cell in the bottom row being empty.

E81/E82/E87/E88		
Vehicle Check	Engine Oil	Front Brake
Rear Brake	Brake Fluid	Dust Filter
Spark Plug	Vehicle Inspection	Exhaust Emission Inspection
Diesel Particle Filter		

4.7 Special function:

The special functions of different vehicle systems will also be different.

4.8 Actuating components test:

Test conditions: Follow the instructions, for example: The engine is not running and the ignition switch is turned on. If the engine is started or the speed signal is recognized, the motion test diagnosis is interrupted.

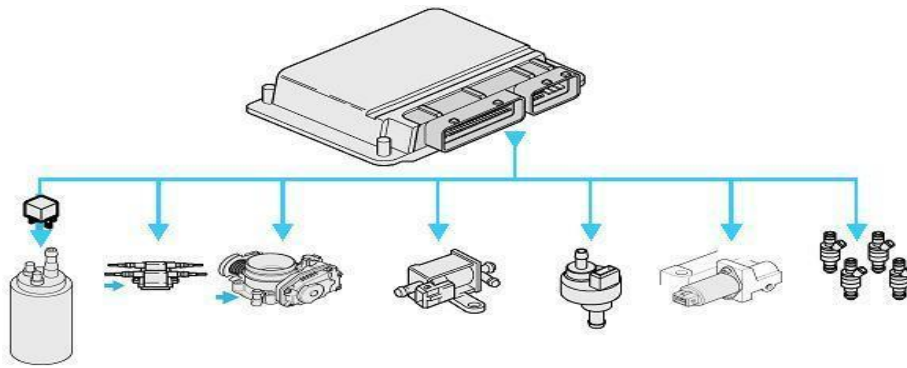

(1) Return the menu to "dynamic diagnostic data" to see the "Action test" function menu, choose to display the system can be used to perform action test of the Actuator component menu.

Tip: The "Action test" function is a part of the system to perform functional testing of components, when performing this function, the diagnostic instrument will simulate the ECU signal to carry out the action of the component to determine whether the actuator or line is good.

(2) Return the menu to "dynamic diagnostic data" to see the "Action test" function menu and select the Actuator component menu that will display the system for action testing.

5. Setting:

Choose the "Settings" application to open the Settings screen, you can set the language units and system-related selection, and so on, the

following 6 options are set:

Language: Select the language and select the desired language in the language options on the right.

Units: Select units of measure, metric or imperial tick

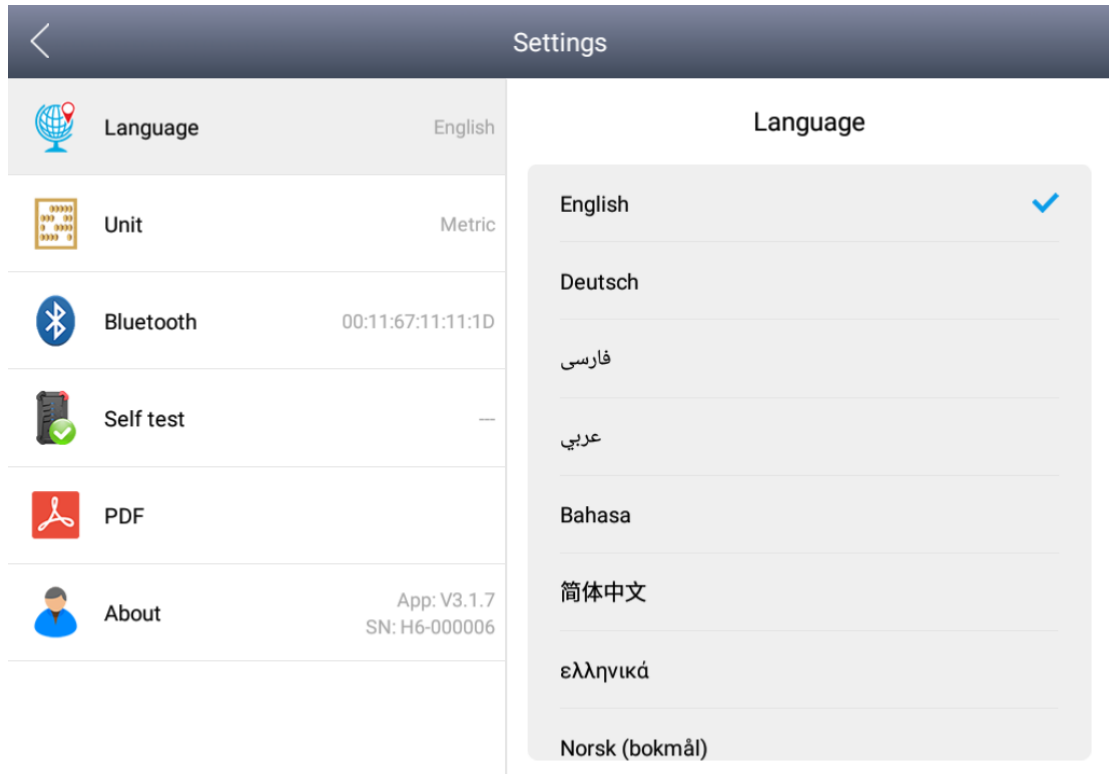

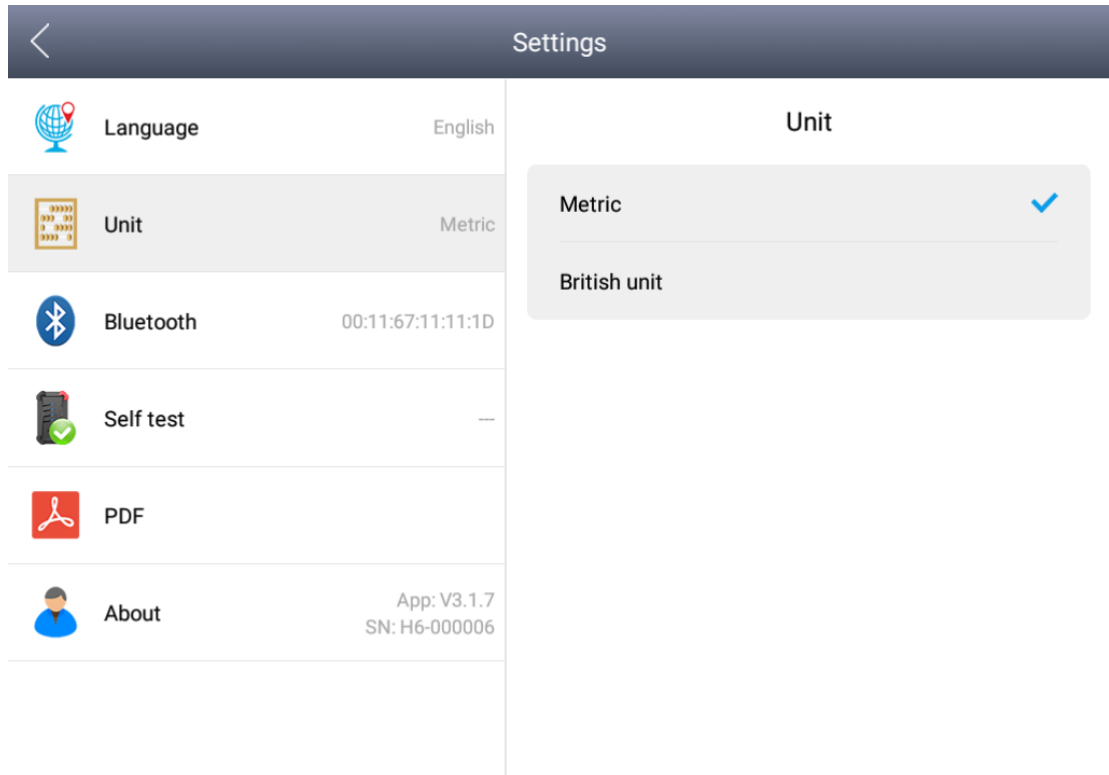

Bluetooth:

1. Host click on the gear icon to enter settings, tap Bluetooth, and then click Search Bluetooth, Bluetooth name for the corresponding serial number or diagnostic.

2. Then go to A80 BT app click Settings, turn on Bluetooth, tick, as shown in the following image:

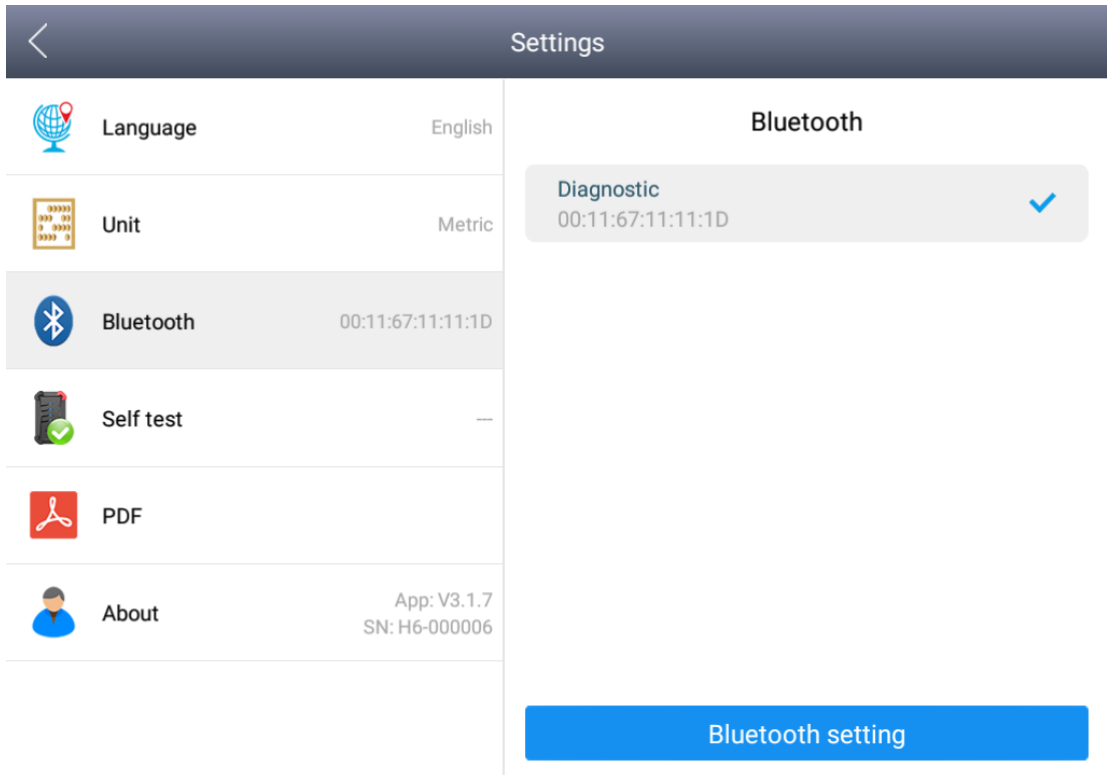

Self-test: Check the VCI box yourself to see if there is a malfunction

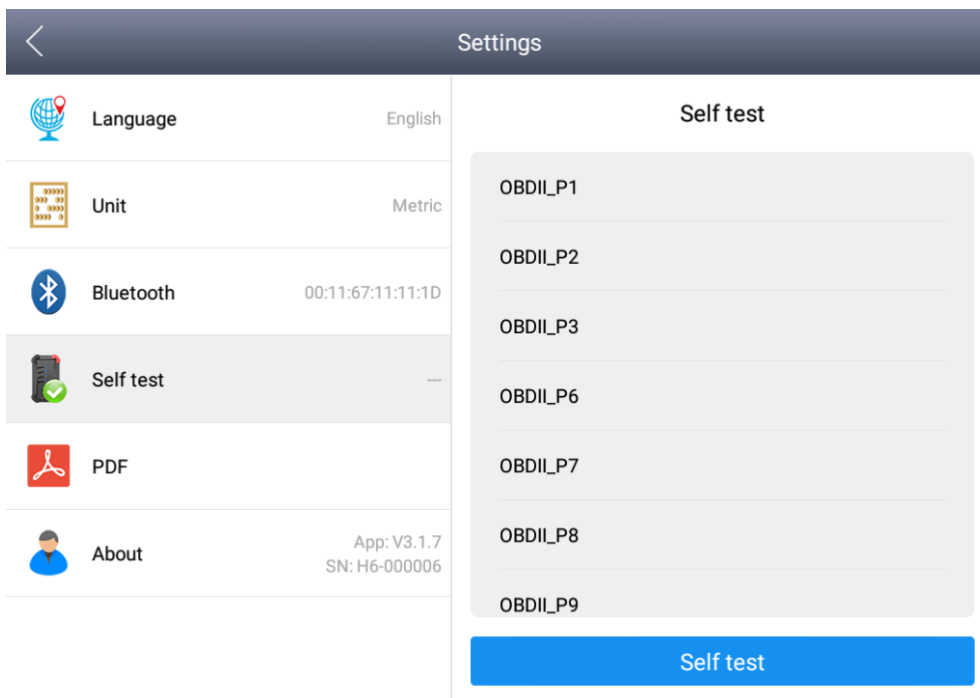

6. Diagnose report

Diagnostic Report is used for viewing and printing the saved files, such as Live Data, Trouble Codes or pictures generated in the process of diagnosis, users also can view a record of which cars have been previously tested. It includes three parts: PDF Files, Pictures and Data Playback.

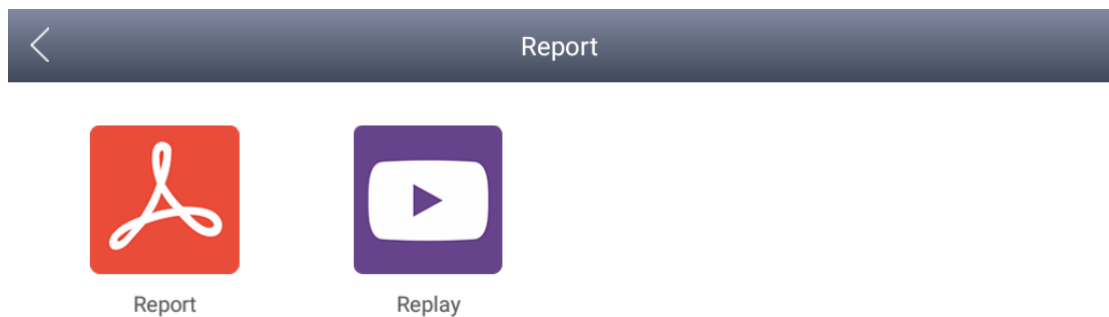

6.1 Diagnose report:

The diagnostic report of the data stream or fault code in the course of the vehicle is checked into the various diagnostic reports.



Report

6.2 Data playback

The Data playback feature lets you see which cars, which systems, and playback of recorded data streams freeze frames.

7. One-click upgrade:

The A80 BT device no longer requires a card to be upgraded, just open the app and click Upgrade, as shown in the following figure.

		Update			Update all
1	SERVICE LIGHT RESET-ASIA	V16.81	2018-09-26 03:04:57	<div style="width: 0%;"></div> 0%	Update
2	SERVICE LIGHT RESET-CHINA	V18.51	2018-09-26 03:04:59	<div style="width: 0%;"></div> 0%	Update
3	SERVICE LIGHT RESET-EUROPE	V18.21	2018-09-26 03:05:01	<div style="width: 0%;"></div> 0%	Update
4	SERVICE LIGHT RESET-AMERICA	V16.21	2018-09-26 03:05:02	<div style="width: 0%;"></div> 0%	Update
5	DIAGNOSIS-NISSAN PIN DATA	V5.0	2015-04-27 19:55:11	<div style="width: 0%;"></div> 0%	Update
6	DIAGNOSIS-OBDDII	V20.91	2017-07-26 23:07:02	<div style="width: 0%;"></div> 0%	Update
7	DIAGNOSIS-BUICK	V10.51	2018-05-12 08:46:07	<div style="width: 0%;"></div> 0%	Update
8	DIAGNOSIS-CHEVRO LET	V10.51	2018-05-12 08:46:07	<div style="width: 0%;"></div> 0%	Update
9	DIAGNOSIS-CADILLA C	V10.51	2018-05-12 08:46:07	<div style="width: 0%;"></div> 0%	Update

8. Xtool Cloud System

All vehicle maintenance Technicians using our equipment can easily inquire about the maintenance information we put on the cloud service platform, and can be combined with the results of the car diagnosis to query and use, and use the forum to communicate with other Xtool users, but also access to an online database that provides extensive repair and diagnostic techniques as well as vehicle maintenance programs.



9. Remote control:

Maintenance Master in the repair process encountered problems, do not know how to solve, you can open the application to seek Remote Assistance. How to accept support from the Xtool Technology Center

9.1 Turn on A80 BT and go to the A80 BT App

9.2 Click the "remote Control" application to open the TeamViewer interface. Generate and display the device ID

9.3 Provide your ID to the after-sales technical support staff

9.4 System pop-up window, allow the other control can be remote control, after-sales technical support personnel control your A80 BT, please do not operate the equipment, as far as possible to cooperate with

the staff to complete the operation.

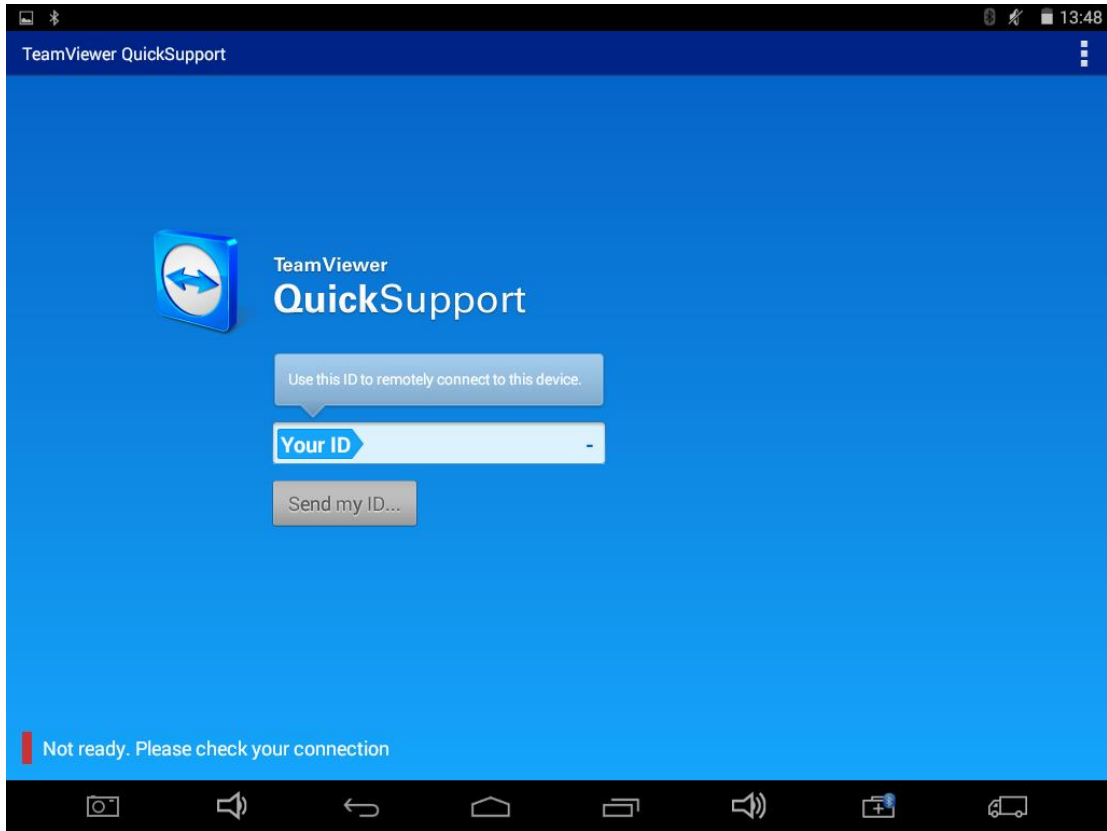

Chapter III Location of Diagnostic link connectors on Different vehicle Models

1. Diagnostic link connectors locations of various vehicle models:



*AUDI A6: the OBD plug is on the lower left side of the dashboard, use SMART OBDII-16 connector.



*VW Bollywood 1.8: the OBD plug is below the console, use SMART OBDII-16 connector.



*Benz S320,220 Chassis: the OBD plug is below the dashboard, use SMART OBDII-16 connector.

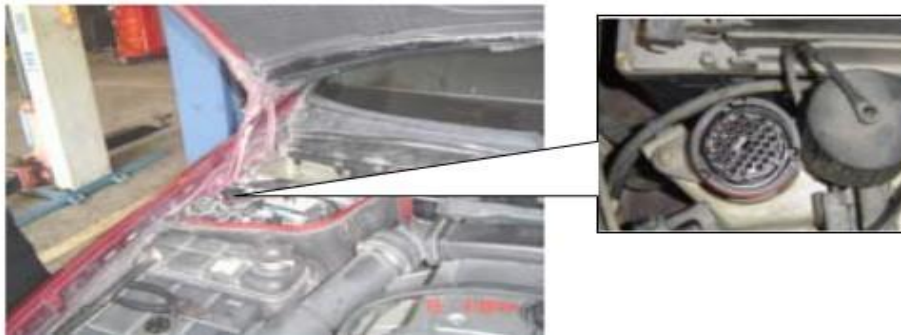

*Benz C180: the OBD plug is on the left hand side of the engine bay, use Benz-38 connector.



*Benz 300SEL 140 chassis: the OBD plug is on the left hand side of the engine bay, use Benz-38 connector.



*GM Buick: the OBD plug is below the dashboard, use SMART OBDII-16 connector.



*GM Buick GL8 : the OBD plug is below the dashboard, use SMART OBDII-16 connector.



*VW POLO: the OBD plug is below the dashboard, use SMART OBDII-16 connector.

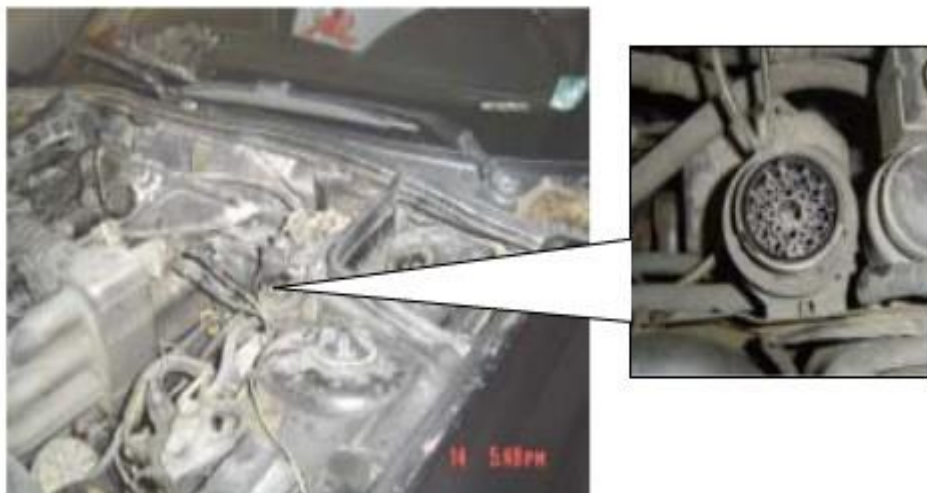

*BMW 735i: the OBD plug is in the right hands side of the engine bay, use BMW-20 connector.

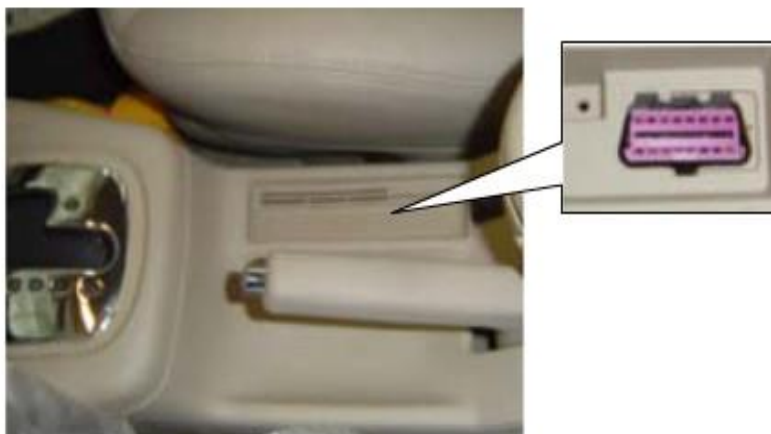

*VW Passat B5: the OBD plug is behind the gearlever and beside the parking brake lever. Lift the cover to access it. Use SMART OBDII-16 connector.

2. Location diagram of vehicle diagnostic link connectors:

Location diagram of pick-up truck diagnostic link connectors:

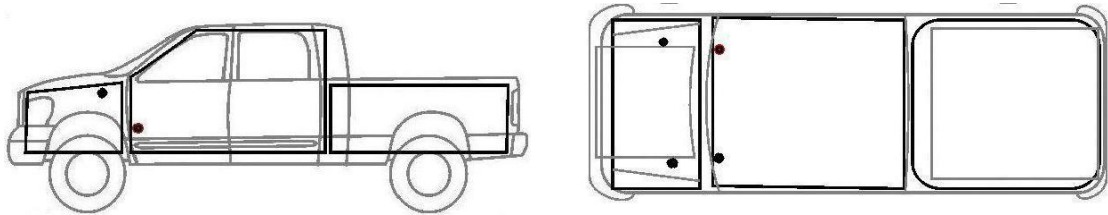

Location diagram of utility vehicles diagnostic link connectors:

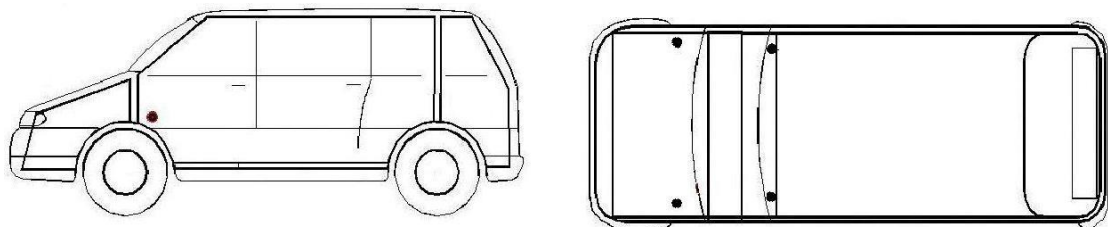

Link diagram of small car diagnostic link connectors:

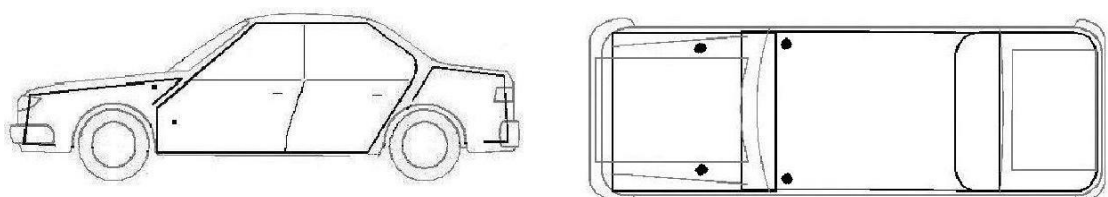

NOTE: Each vehicle manufacturer may use additional pins to diagnose a variety of systems. Not every manufacturer uses the same standard. The function on a certain pin will vary from manufacturer to manufacturer. Verify with the manufacturer.

3. Diagnostic Link Connectors Terminal Definition and Communication Protocols

- 1、 Standard OBDII Diagnostic Link Connector:

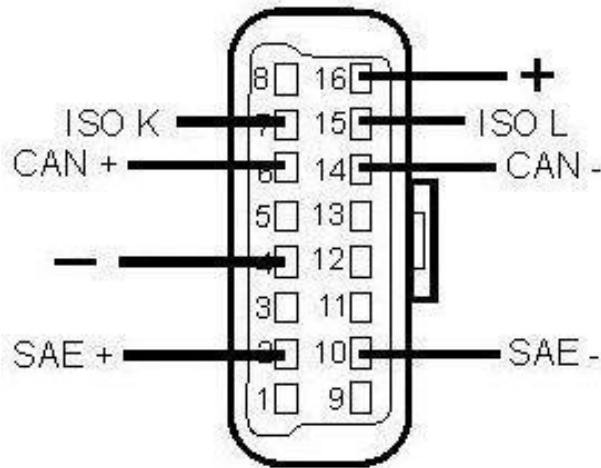

Pin definition (reference material)

Various pin definitions as follows:

- 1, Manufacturer definition
- 2, SAE J1850 bus positive
- 3, Manufacturer definition
- 4, Bodywork site
- 5, Signal site
- 6, ISO 15765-4 defined CAN high
- 7, ISO9141 and ISO14230 defined K line
- 8, Manufacturer definition
- 9, Manufacturer definition
- 10, SAE J1850 bus negative

11, Manufacturer definition

12, Manufacturer definition

13, Manufacturer definition

14, ISO 15765-4 defined CAN low

15, ISO9141 and ISO14230 defined L line

16, Permanent positive voltage

[1] 1, 3, 8, 9, 11, 12 and 13 are defined by manufacturer.

[2] 2, 6, 7, 10, 14 and 15 are used for diagnostic communication.

Unused definitions can be defined by manufacturers

Chapter IV Additional Information

1. Description of OBDII and the function of sensor components

1.1 OBDII function description

In 1994, the American Society of Automotive Engineers proposed the second generation of self-diagnosis system for on-board faults, namely OBD-II. OBD-II unifies the form of the fault detection socket, the number and meaning of the fault code, and the reading method of the fault code, and adds a strong data stream detection function. However, the fault code and data flow can only be obtained with the microcomputer fault detector, and the fault code cannot be read manually. So far, after the 1996 production of vehicles in the United States, the introduction of vehicles produced by American technology (such as Shanghai Buick, etc.) and vehicles sold to the United States, only OBD-II has been adopted,

and OBD-I has been completely abandoned, other vehicles are generally OBD-I and OBD-II coexist.

Electronic technology is applied to the engine management system. In addition to basic functions such as fuel injection and ignition functions, as well as on-board (OBD) function. When the system fails, the fault light (MIL) or the check engine warning light (Check Engine) lights up. At the same time, the powertrain control module (PCM) stores the fault information in the memory, and the fault code can be read out from the PCM through a certain program. According to the prompt of the fault code, you can quickly and accurately determine the nature and location of the fault, and then specifically check the relevant parts, components and lines to eliminate the faults.

OBD II set standards. The main points of the standard are as follows:

- (1) Standardized 16-pin diagnostic seats (DLC)
- (2) Standardized electronic protocols
- (3) Standardized diagnostic codes (DTC)
- (4) Standardized technology

The OBD II system is technologically advanced and very effective in detecting emissions problems, but OBD II is powerless to warn drivers of whether to accept MIL warnings. To this end, OBD III system

development, which is further than OBD II, is on the agenda.

The OBD III system mainly uses a small car wireless transceiver system to automatically notify the management department of the VIN, fault code and location of the vehicle through wireless cellular communication, satellite communication or GPS system. The management department according to the level of the vehicle emission problem. Issue instructions, including advice on where to go for repairs, and time limits for solving emissions problems. A ban on passwords is issued for vehicles that exceed the time limit, as permitted by law. In short, the main feature of OBD III is the support of social regulations. In China, there are some feasible solutions in combination with national conditions, such as the setting time limit of MIL warning lights, and the over-limit vehicles will be automatically banned. In addition, the OBD III system not only warns the driver of vehicle emissions, but also penalizes those who do not accept the warning.

1.2 Sensor element function

The control basic sensor of the car microcomputer control system detects the working condition of the car, and the electronic control unit processes and judges to issue the command execution component, and executes the command to complete the optimal work requirement.





Sensor connection example diagram (as shown below) ▼

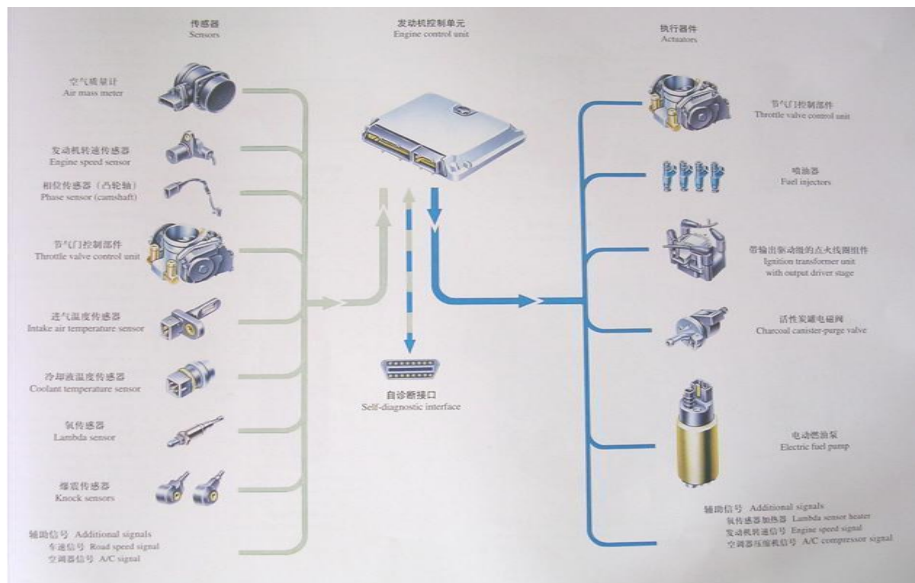

(1) ECU (Electronic Control Unit)

The ECU is the control center of the electronically controlled engine, which can control the action of each actuator by receiving the engine operation information transmitted by each sensor.

The ECU calculates the signals of the external sensors and limits them to the allowed voltage levels. The microprocessor calculates the injection time and injection timing from the input data and the stored MAP chart and converts these times into a time varying voltage process that matches the engine operation. Due to the high precision required, the

engine's operation is highly variable, so the calculation efficiency should be high.

The final stage is controlled by the output voltage, which provides sufficient power to regulate the common rail pressure operating units (Actuator) and shut off the plunger supply. In addition, the actuator controls engine functions (e.g. exhaust gas recirculation actuators, boost pressure actuators, electric oil pump actuators) and other auxiliary functions (e.g. fan relays, auxiliary heating relays, preheating relays, air conditioning units). The final stage is protected by short circuit protection and electrical overload. This type of fault and wire disconnection is fed back to the microprocessor. The diagnostic function at the end of the injector also identifies defective signal changes. In addition, some of the output signals are transmitted to other systems of the vehicle via the interface. Within the scope of the safety program, the ECU also monitors the entire fuel injection system.

The ECU also contains a monitoring module. The ECU and the monitoring module monitor each other and if a fault is found, any one of them can be separated from the other and cut off the fuel.

(2) Camshaft speed sensor

The camshaft controls the intake and exhaust valves, which rotate at half the crankshaft speed. Its position determines that the piston moving

up the dead point is in the compression stroke and then in the firing or exhaust stroke. This information is not available from the crankshaft position during starting. In contrast, the information generated by the crankshaft sensor is sufficient to determine the engine state while the vehicle is running. That is to say, the ECU still knows the engine state when the camshaft speed sensor fails during vehicle operation.

The camshaft speed sensor uses the Hall Effect to determine the position of the camshaft. The Hall Effect is as follows: A tooth made of ferromagnetic material is placed on the camshaft, and the teeth rotate with the camshaft. When the semiconductor wafer through which the current flows in the camshaft rotational speed sensor passes the tooth, the magnetic field of the sensor deflects the flow of electrons on the semiconductor wafer perpendicular to the direction of the current. Thus, a voltage signal (Hall voltage) is formed in a short time, and this signal informs the ECU that the first cylinder is in the compression stroke.

(3) Temperature sensor

The temperature sensor is used in several places: ① in the cooling water circuit to infer the engine temperature from the cooling water temperature; ② used in the intake port to determine the temperature of the intake air; ③ used in the oil to determine Oil temperature (optional); ④ used in the fuel return oil line to determine the fuel temperature

(optional). The sensor has a temperature-dependent resistance, the temperature coefficient of the resistor is negative, and the high-sensitivity NTC (negative temperature coefficient thermistor) resistance increases with temperature. It is a part of voltage divider circuit powered by 5V support. The voltage connected to the resistor is read by an analog-to-digital converter, which is a measure of temperature. There is a characteristic curve in the microprocessor of the ECU that gives the corresponding temperature for any voltage.

(4) Air flow sensor

In order to achieve the statutory emission limits, especially in the case of dynamic engine operation, the air-fuel ratio must be maintained. For this purpose, sensors that accurately determine the actual intake air mass flow are used. Changes in intake pulsation, back-flow, exhaust gas return and camshaft control, and changes in intake air temperature must not affect the accuracy of the load cell measurement. To achieve the above objectives, in a hot film air mass flow meter, heat is extracted from a heated sensing element by heat transfer to the air mass flow. The micromechanical measurement system works in conjunction with a hybrid circuit to measure air mass flow, including flow direction. When the air mass flow is strongly pulsating, back-flow can be identified. The micromechanical sensing element is disposed in the plug sensor flow

path. The plug-in sensor can be mounted in the air filter or in the measuring tube of the air guiding section. The measuring tubes are available in a variety of sizes depending on the maximum air flow required by the engine. The relationship between signal voltage and air mass flow can be divided into two signal ranges of reverse and forward flow. In order to improve the measurement accuracy, the measurement signal is correlated with a reference voltage derived from engine control. The characteristics of the characteristic curve are designed such that the wire breakage can be detected during the diagnosis of the repair shop, for example by means of engine control. To determine the intake air temperature, a temperature sensor can be built in.

(5) Intake pressure sensor

The intake pressure sensor detects the absolute pressure of the intake manifold behind the throttle and the valve. It detects the change of the absolute pressure in the manifold according to the engine speed and the load, and then converts it into a signal voltage and sends it to the controller (ECU). The ECU controls and corrects the fuel injection amount based on this signal voltage.

Note: The sensor pressure port should be perpendicular to the mounting surface. The maximum angle between the sensor and the vertical direction should not exceed 60 degrees. The sensor should not be

installed after the air intake heating device (if equipped). It is forbidden to enter the sensor during painting or cleaning.

(6) Accelerator pedal sensor

Unlike ordinary distribution pumps or in-line pumps, in diesel electrical control devices, the driver's acceleration requirements are no longer transmitted to the fuel injection pump through the cable or transmission rod system, but are learned by the accelerator pedal sensor and transmitted to the power supply. Control the accelerator pedal. A voltage is developed in the accelerator pedal sensor via a potentiometer based on the position of the accelerator pedal. The accelerator pedal position is calculated from the voltage based on the MAP chart.

2. Common faults and elimination of electronic control system

Trouble shooting of common vehicle self-diagnosis systems

Audi's V6 engine uses the MPFI multi-point fuel injection system, and its self-diagnostic system has 30 different faults stored in the microcomputer. Its characteristics are:

If the fault exists for more than a certain amount of time, the fault is stored in the memory in a stable form.

If a failure occurred during a certain period of time, the fault is considered to be a sporadic fault, and if the engine is started 50 times and

the fault still does not occur again, the occasional fault will be automatically cleared.

After turning off the ignition switch 150 minutes, the microcomputer enters the self-holding stage, if the fuel injection and ignition system is repaired during this period, then the fault code that has been stored should be recalled and removed.

Chrysler Automotive Fault Self-Diagnostic System

Chrysler Automobile's electronic control system is referred to as SBEC. When a car fails, the corresponding fault information is stored in SBEC in the form of code.

Each time the ignition switch is turned on, the “CHECKENGINE” indicator will flash for a few seconds to indicate that the indicator is working properly. If the SBEC receives an abnormal signal from various sensors or does not receive the signal at all, the instrument panel The “CHECK ENGINE” indicator will illuminate, indicating that the engine is faulty and needs to be serviced.

The method of entering the self-diagnosis state is to switch the ignition switch three times within five seconds, that is, ON→OFF→ON→OFF→ON, at this time, the “CHECKENGINE” indicator on the instrument panel will flash, thereby displaying the stored the fault code. The fault code is cleared by using the dedicated instrument DRBII to

clear the fault code. If there is no DRBII, the ignition switch can be turned ON/OFF 50 times and the fault code is cleared.



图 1-1 CHRYSLER 诊断座型式
 (a) SMEC 与 SBEC 诊断座 (b) CCD 与 LH 诊断座 (c) OBD-II-DLC 诊断座

Volvo Car Fault Self-Diagnostic System

The interface of the Volvo series of self-diagnostic system is in the right front corner of the car body, the engine cover is opened, and the front left headlights have two diagnostic seats A and B. The A seat has a diagnostic jumper, an LED light and a button. There are six diagnostic jacks in each of the two diagnostic seats A and B, each connected to a different diagnostic system.

Block A:

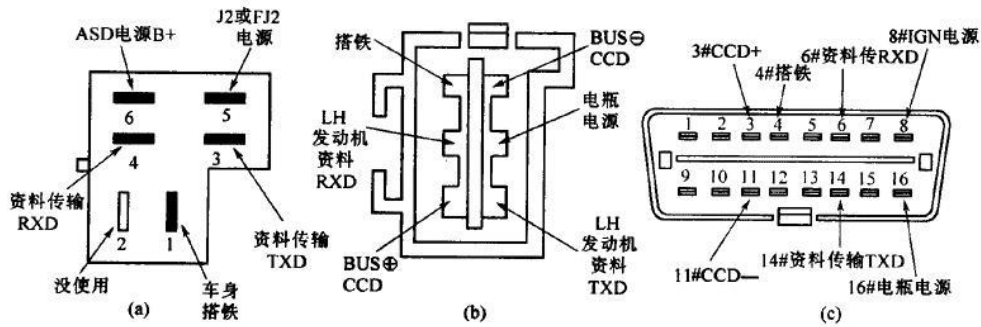
Hole 1 → Transmission

Hole 2 → Fuel System

Hole 3 → ABS System

Hole 5 → Turbocharging System

Hole 6 → Ignition System

Hole 7 → Instrument Diagnostic System

Block B:

Hole 1 → Central Air Conditioning

Hole 2 → Constant Speed Control System

Hole 5 → Airbag

Hole 6 → Power Seat

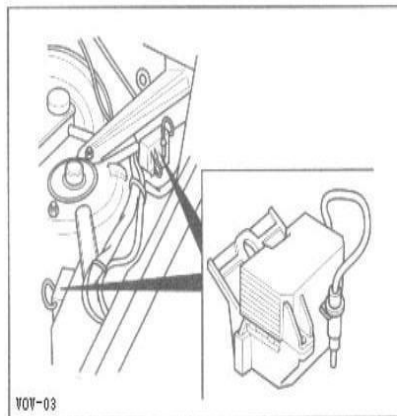

240, 740/760, 940/960 1995年 发动机室右后侧

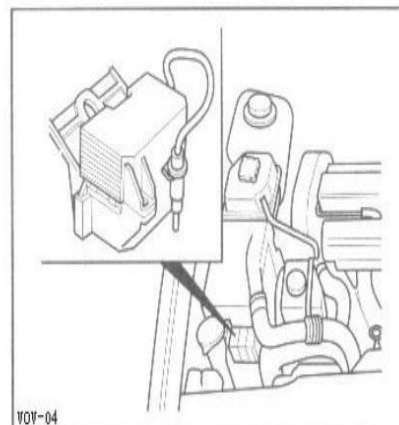

850 1995年 发动机室右前侧

The Volvo series models are capable of diagnosing 10 systems in terms of self-diagnostic functions, and in each system diagnosis, they can be divided into six modes:

1 fault code reading

- 2 control component action test;
- 3 Each control element operates simultaneously to control the test;
- 4 Develop component motion command control test;
- 5 numerical reading analysis instructions;
- 6 Reset the microcomputer memory command.

When diagnosing the car, you can use the jumper on the diagnostic stand directly into the different diagnostic holes, and press the buttons on the diagnostic stand to select various specific diagnostic modes by pressing 1 to 6 respectively.

To clear the fault code, first insert the diagnostic jumper into the corresponding diagnostic hole of the system to be diagnosed, set the ignition switch to ON, and read the fault code first, until all fault codes are displayed, the LED light is continuously on. From then on, press and hold the diagnostic button for more than 5 seconds to clear the fault code.

Crown auto ABS fault self-diagnosis system

- The new Crown sedan uses an anti-lock braking system (ABS). If the system fails, the fault self-diagnosis system in the anti-lock braking system will identify the fault that occurred, and the microcomputer (ABSECU) will represent the fault. The code is stored and the fault message is communicated to the owner via the ABS warning light

FCC Statement

This device complies with part 15 of the FCC rules. Operation is subject to the following two conditions: (1) this device may not cause harmful interference, and (2) this device must accept any interference received, including interference that may cause undesired operation.

Changes or modifications not expressly approved by the party responsible for compliance could void the user's authority to operate the equipment.

NOTE: This equipment has been tested and found to comply with the limits for a Class B digital device, pursuant to part 15 of the FCC Rules. These limits are designed to provide reasonable protection against harmful interference in a residential installation. This equipment generates uses and can radiate radio frequency energy and, if not installed and used in accordance with the instructions, may cause harmful interference to radio communications. However, there is no guarantee that interference will not occur in a particular installation. If this equipment does cause harmful interference to radio or television reception, which can be determined by turning the equipment off and on, the user is encouraged to try to correct the interference by one or more of the following measures:

- Reorient or relocate the receiving antenna.
- Increase the separation between the equipment and receiver.
- Connect the equipment into an outlet on a circuit different from that to which the receiver is connected.
- Consult the dealer or an experienced radio/TV technician for help.

The device has been evaluated to meet general RF exposure requirement. The device can be used in portable exposure condition without restriction.