

Antenna introducing

Model:FRX-M88CU-22

- ◆ Made by Copper-Nickel-Zinc Alloy material, work in 2.4~2.5GHz &4.9~5.825GHz.
- ◆ Design by dipole antenna theory.
- ◆ High gain, High efficiency, Good port matching.
- ◆ Make wireless equipments better communication.

Shenzhen Bilian Electronic Co.,Ltd.
Room 501, Building 3, No. 32, Dafu Road, Zhangge Community,
Fucheng Street, Longhua District, Shenzhen City, China

Antenna useful area

- ◆ Pads, note-book, reader and so on.
- ◆ IP camera, set top box and so on.
- ◆ DVD player, TV and consumer electronics.

Antenna size)



Antenna electrical properties

Frequency	2.4~2.5GHz&4.9~5.825GHz
Impedance	50ohm nominal
V.S.W.R	≤1.92
Return loss	≤-10dB
Radiation	Omni-directional
Gain(Peak)	2G:2.0dBi/ 5G:2.0dBi
Polarization	Linear
Admitted Power	2W
Connector	IPEX
Efficiency	2G:75%/ 5G:63%

Antenna S-parameter

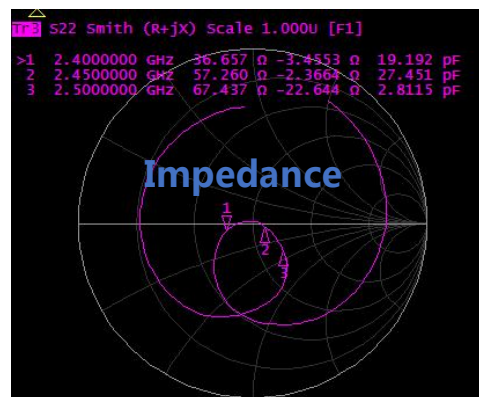

Antenna chamber structure

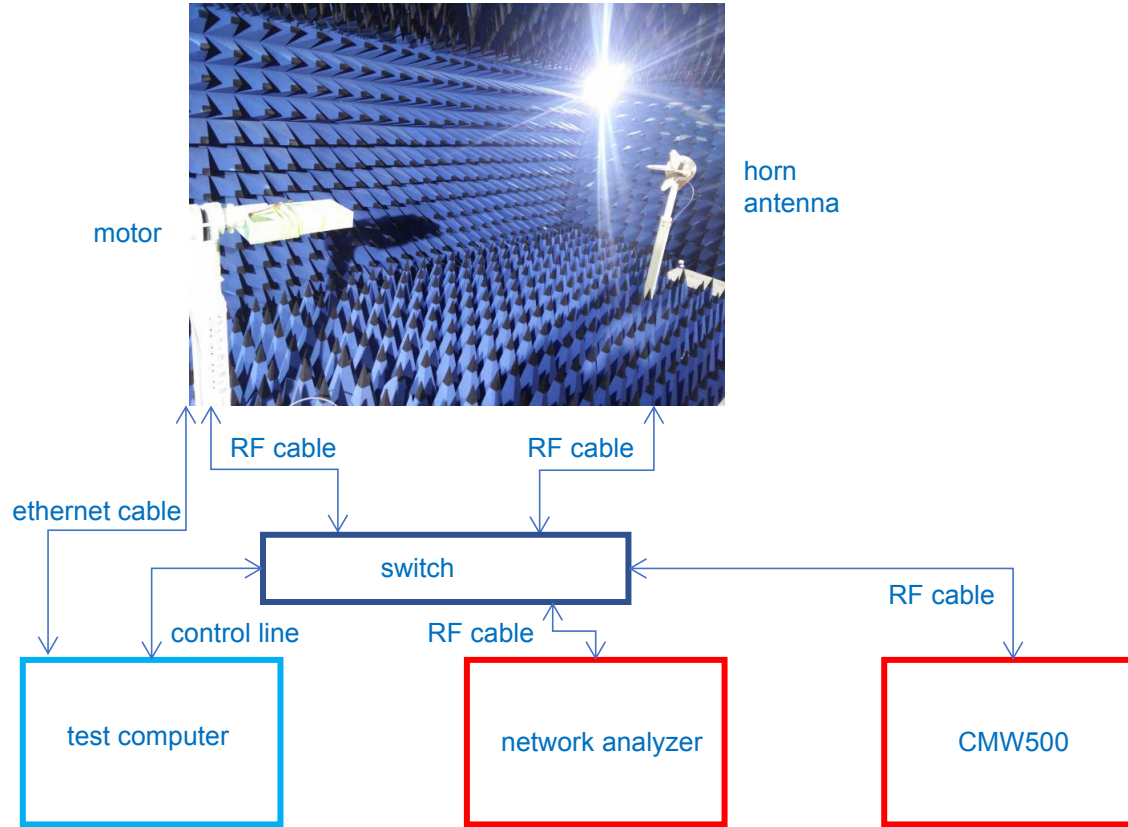

Antenna total gain and efficiency

	Freq. (MHz)	Gain (dBi)	Efficiency (%)
ANT	2400	1.3	72%
	2450	2.0	75%
	2500	1.62	73%

2450.000MHz

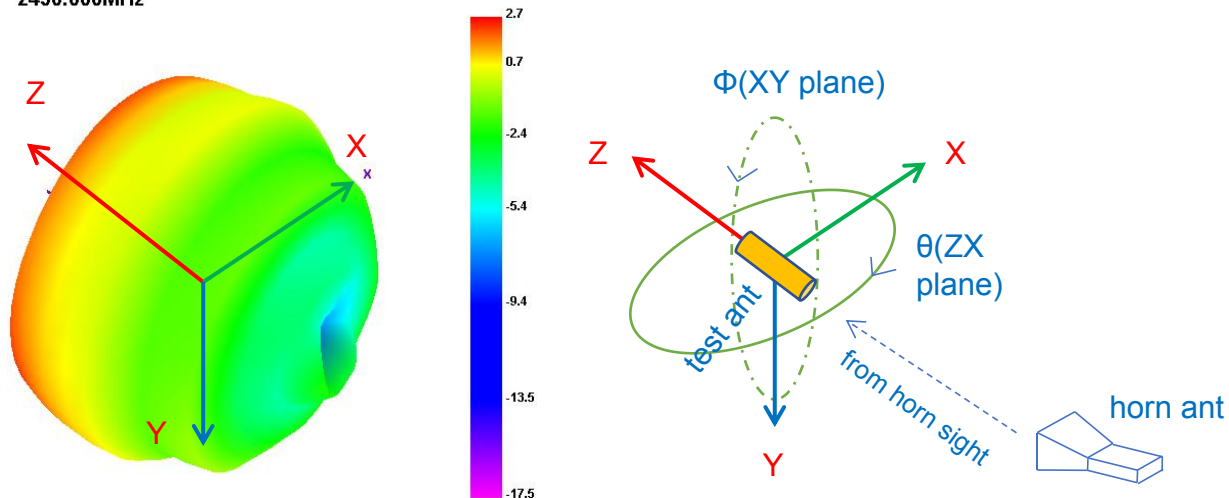

Radiation Pattern E_PLANE

	Freq. (MHz)	Gain (dBi)
ANT	2450	2.0

2450.000MHz

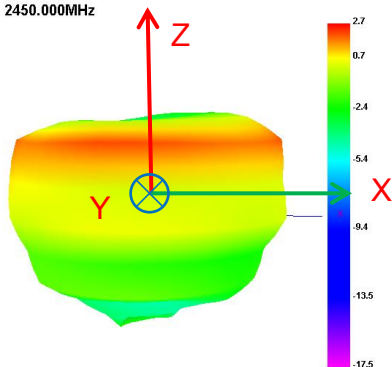

$\Phi=0^\circ$
 $\theta=0\sim360^\circ$



horn ant

E1 Face

2450.000MHz

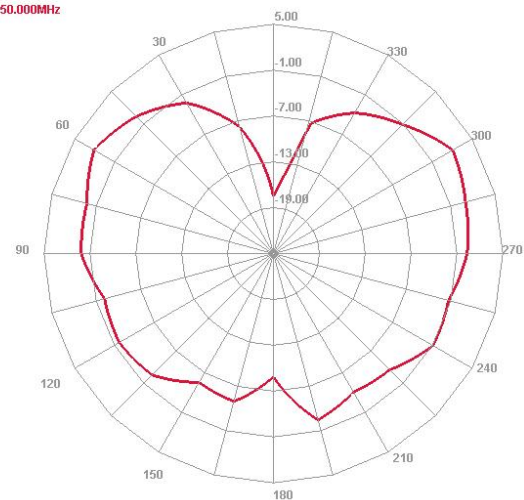

Far field E1_PLANE
 $\Phi=0^\circ$, ZX plane

	Freq. (MHz)	Gain (dBi)	Efficiency (%)
ANT	5100	1.75	62%
	5400	2.0	65%
	5820	1.8	62%

5400.000MHz

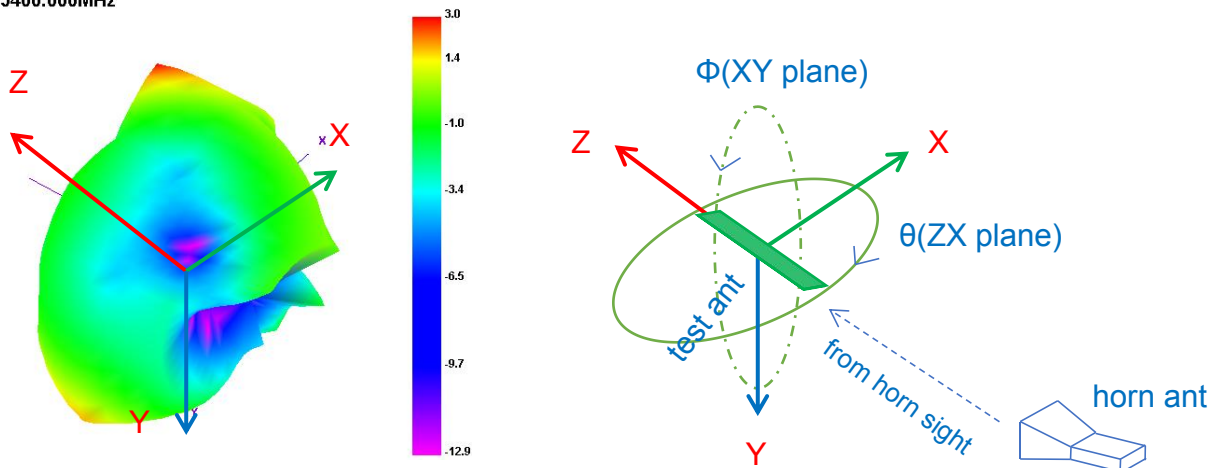

	Freq. (MHz)	Gain (dBi)
ANT	5400	2.0

E1 Face

5400.000MHz

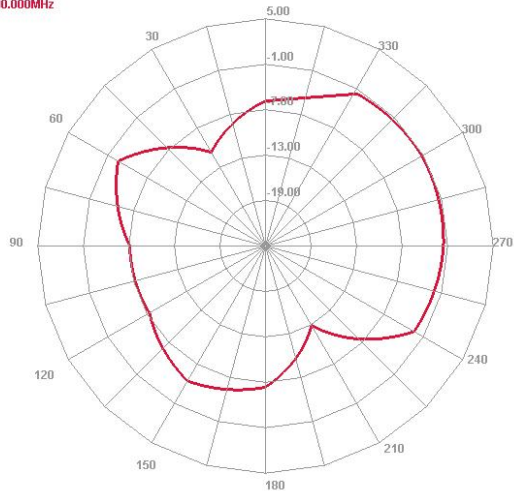

ZX plane

E2 Face

5400.000MHz

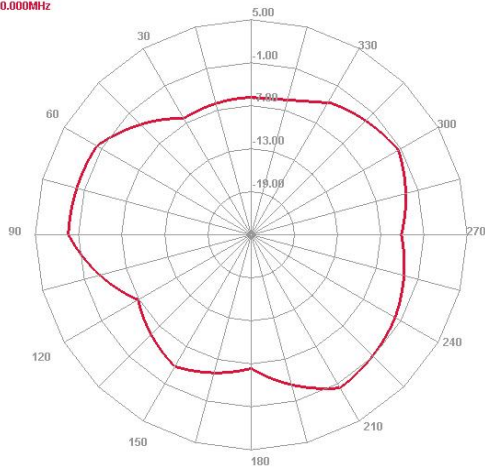

ZY plane

Horizontal

5400.000MHz

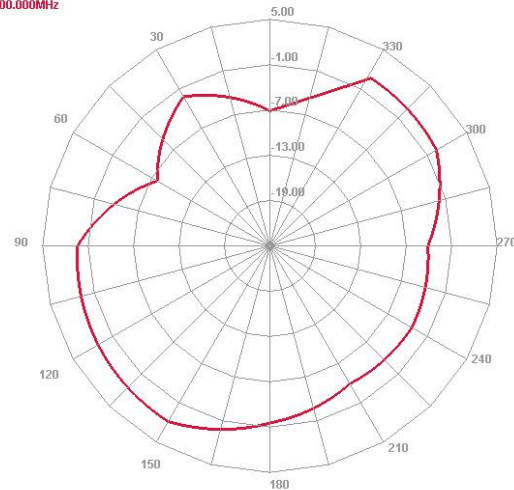

XY plane