

L005A User Manual

Contents

Safety Instructions	01
Notice	03
Package List	04
Overview	05
Remote Control	06
Power On/Off	07
Focus / Screen Recognition / Obstacle Recognition	08
Getting Started	09
Network Setting	10
Bluetooth Setting	11
Bluetooth Speaker	12
Input Signal	13
Projection Setting	14
Projection Mode	15
Keystone Correction	16
Screen Scaling	17
Video Setting	18
Audio Setting	19
APP Setting	20
Language Setting	21
Input Method Setting	22
Time Setting	23
Screen Mirroring	24
USB Connection	35
HDMI Connection	36
Projector Installation & Technology Features	37
Questions & Answers	38

Safety Instructions

Read all instructions before you use this device. Do not make any changes or create settings that are not described in this manual. If physical damage, loss of data or damage is caused by failure to follow instructions, the warranty does not apply.

Setup

1. To reduce the risk of fire or electric shock, do not expose the device to rain or moisture. Objects filled with liquids, such as vases, should not be placed on this device.
2. Do not place this device on soft surfaces such as tablecloths or carpets, otherwise the device could be a fire hazard.
3. Do not place this device in areas susceptible to excessive dust and dirt or near any appliance generating a strong magnetic field.
4. To prevent overheating, do not block or clog the ventilation holes.
5. Never place this device in a confined space. Always leave enough space around this device for ventilation.
6. Protect this device from overexposure to direct sunlight, heat, large temperature fluctuations and moisture. Avoid extreme temperatures. The suitable operations and storage temperature for this device and its accessories is (0°F to 95°F).
7. When this device is running for a long period of time, the surface may become hot. Shut it down immediately and unplug the charger. Resume operation after this device has cooled down.
8. Always handle this device with care. Avoid touching the lens. Do not allow children to handle the device without supervision.
9. Never place heavy or sharp objects on this device.
10. To avoid electric shock, do not disassemble the device.
11. Use attachments or accessories specified by the manufacturer only.
12. Avoid extreme vibration as it may damage the internal components.

The following safety instructions ensure the long service life of the projector to avoid fire or electric shock. Please read carefully and pay attention to the following warnings.

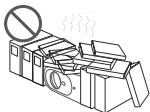

Don't install the projector in sites with improper ventilation.



Don't install the projector in hot and humid sites.



Don't install the projector near the temperature and smoke transducer. It may cause a sensor failure.

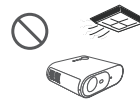

Don't install the projector in sites with direct blowing of warm and cool air-condition wind.



Don't cover the projector ventilation holes with any material.

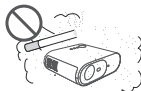

Don't install the projector in dust and smoke sites.

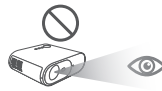

Don't look into the lens when the projector is working, otherwise it may hurt your eyes.



Please keep the projector away from water or any other liquid as it is not waterproof.

Notice

- (1) Please use the power cable with caution to avoid unduly bending. A damaged power cable may cause electric shock.
- (2) Please use the projector with caution to avoid dropping or shocking, which may damage the internal components.
- (3) Please use the same power voltage as marked on the projector.
- (4) Please use the projector in a dark room for the best results.
- (5) Please do not disassemble the projector by yourself, otherwise the warranty will be void.
- (6) Please turn off and unplug from the power supply if not using the projector for a long time.

Package List



Projector × 1

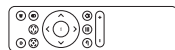

Remote Control × 1
(Batteries are not included)



Lens Cover × 1

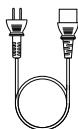

Power Cable × 1

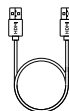

HDMI Cable × 1



AV Cable × 1



Screw Stand × 1



Projector User Manual × 1

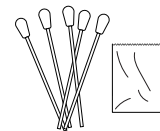

Clean Tool × 1

Overview

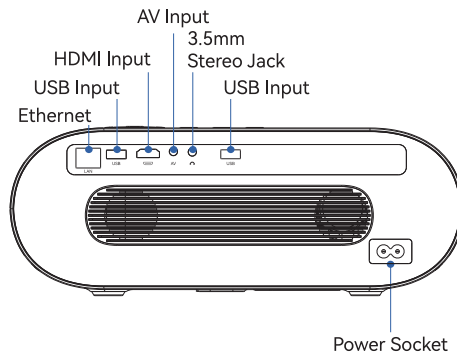
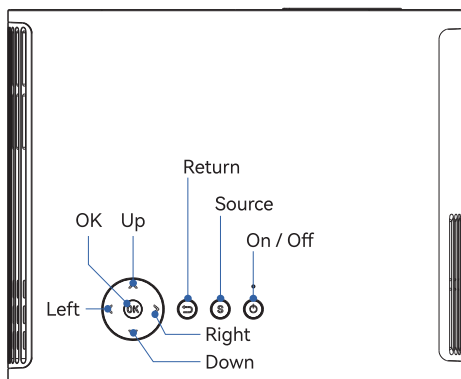

Tips:

1. Blurry Image

- * Go to setting - Display - Turn on the Auto Four-Corners Correction or enter Manual Keystone to adjust the image.
- * Press the focus button on remote control to get the best clarity.
- * Slightly swing the angle of the machine to autofocus.
- * Go to setting - Display - Auto Focus to enable autofocus.

2. Mounting Hole

Adopting a single mounting hole dual-use design, the projector is compatible with the standard camera tripod and 1/4 inch screw projector tripod stand. Meanwhile, you can rotate 360° the screw to meet different projection angle needs.

Remote Control

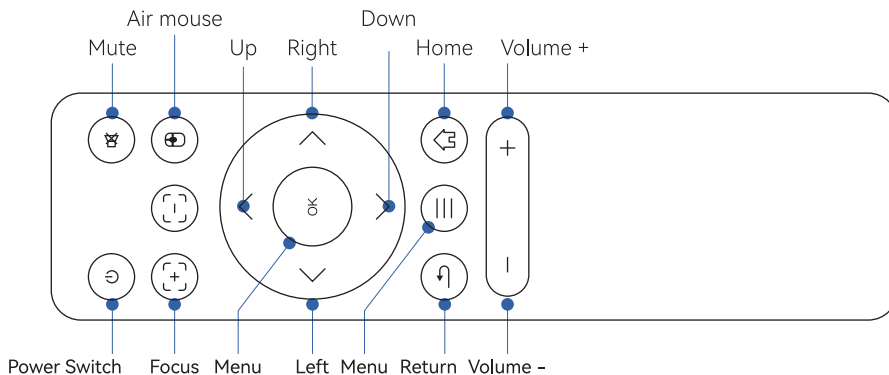

Attention:

1. Do not submerge the remote control in the water.
2. Do not put the remote control near fire or in wet or hot places.
3. Do not use old and new batteries together in the remote control.
4. Please take the batteries out if not using the remote control for a long time to avoid battery leakage.
5. Please point the remote control toward the IR receiver.
6. Please use the remote control within 6 meters distance and 30 degree angle.

Power On/Off

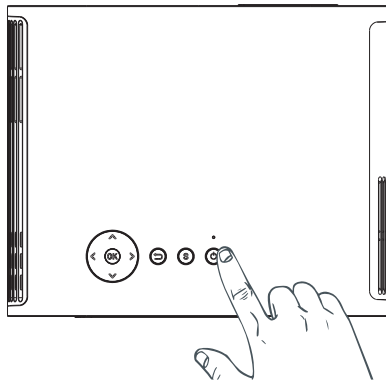

1. Power on: When the projector is power-off, press and hold the power button on the projector or the remote control for 2s to power on the projector.
2. Power off: When the projector is power-on, press and hold the power button on the projector or the remote control for 2s to power off the projector.

Focus / Screen Recognition / Obstacle Recognition

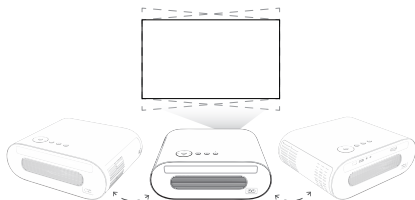

1. Auto Focus:

Slightly swing the angle of the machine to autofocus.



2. Manual Focus:

Press the focus button on the remote control to adjust focus.

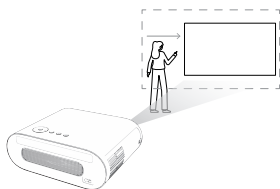

3. Screen Recognition / Obstacle Recognition:

Enter Setting - Display - Smart Recognition - Turn on Screen recognition / Obstacle Recognition.

Getting Started

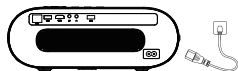

1. Plug the power cable to the projector.

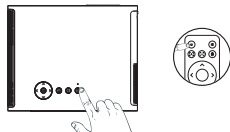

2. Press power button to turn on the projector.

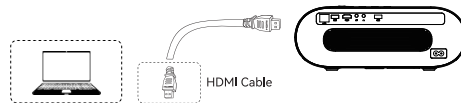

3. Connect projector to HDMI port support device.

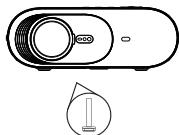

4. Adjust here accordingly.

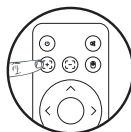

5. Use the manual focus by pressing the "Focus" button on the remote control.

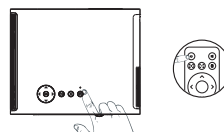

6. Press the power button to turn off the projector.

Tips:

Make sure the projector is horizontal to the projector screen.

Network Setting

Enter Setting - Network to enable the Wifi, then enter password to connect.

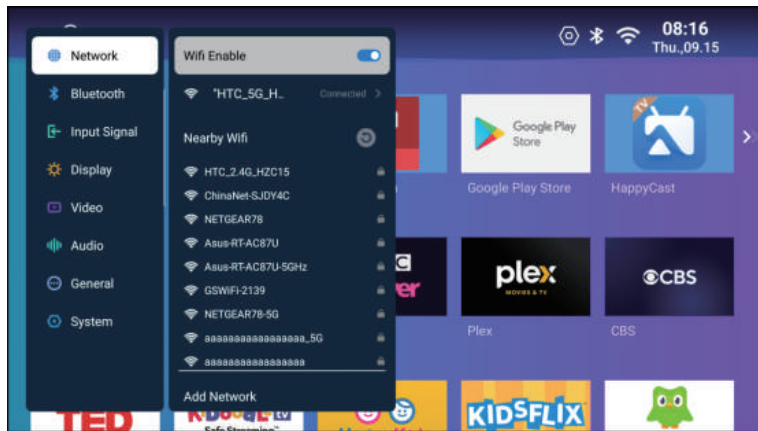

Bluetooth Setting

Enter Setting - Bluetooth to enable the Bluetooth, click Refresh to search and pair the device.

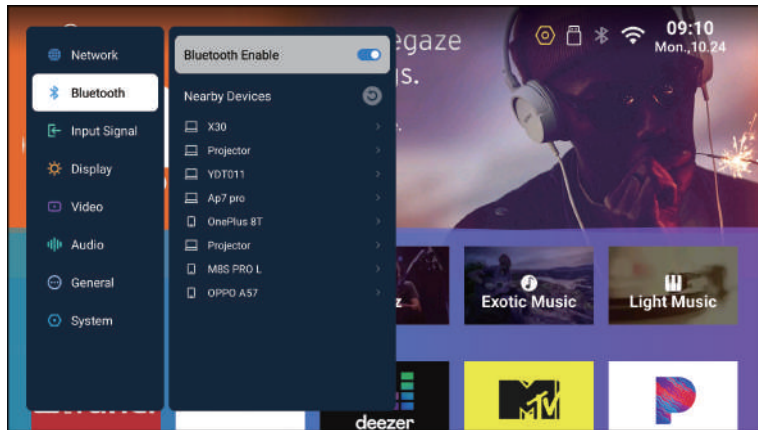

Bluetooth Speaker

Enter Setting - General - Bluetooth Speaker to enable the bluetooth mode, then enable the bluetooth function on the mobile phone, select Projector from the bluetooth device list for pairing. Click return button on the projector to return, select Setting - Cancel Pairing - Disconnect in the bluetooth device list from the mobile phone.

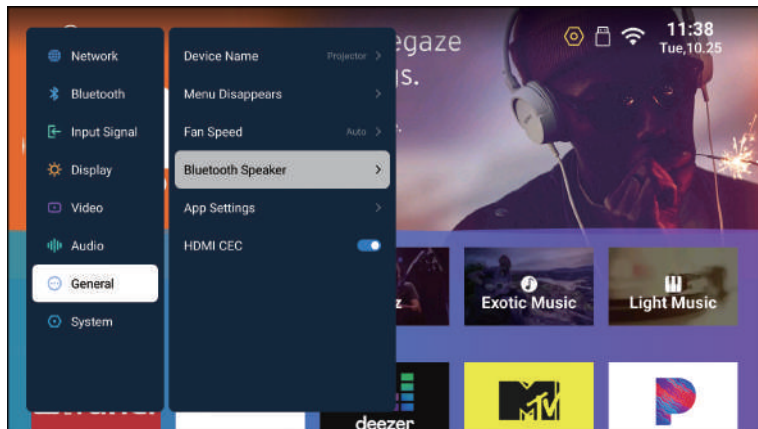

Input Signal

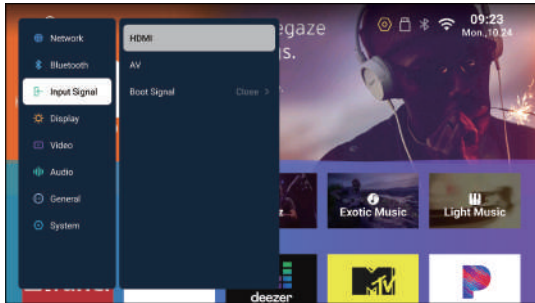

1. The HDMI input function is provided to input the content in other devices to the projector, you can enter the Input Signal at setting to select the HDMI mode.

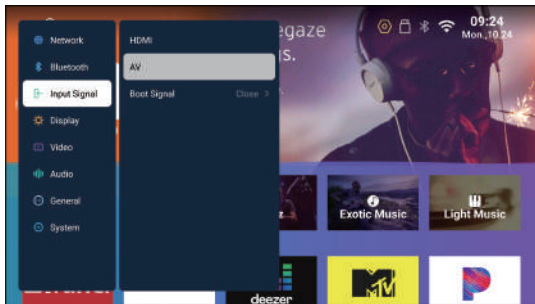

2. The AV input function is provided to input the content in other devices to the projector, you can enter the Input Signal at setting to select the AV mode.

Projection Setting

Enter Setting - Display to set the keystone correction, smart recognition, auto focus, screen scaling and projection mode.

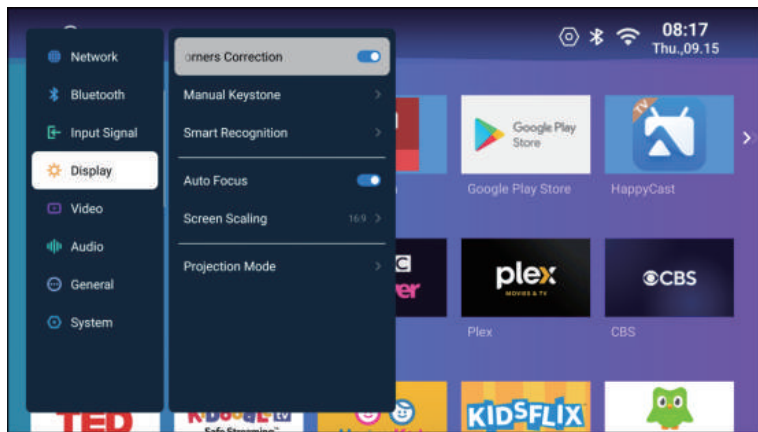

Projection Mode

The projection mode can be selected according to the placement of the projector. Four projection modes include front projection, rear front projection, rear ceiling projection and front ceiling projection.

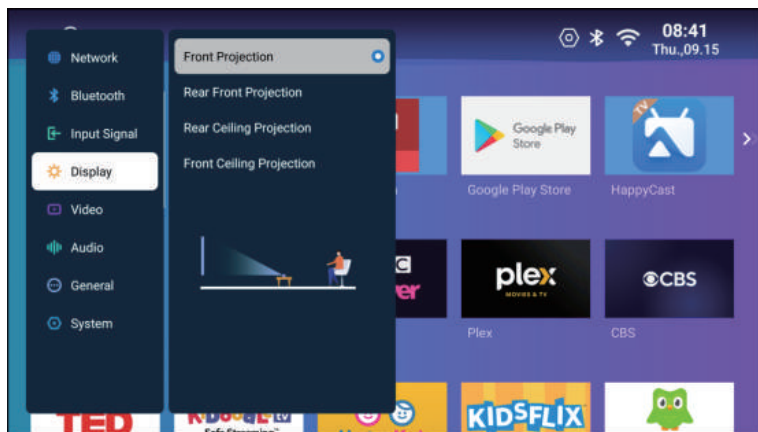

Keystone Correction

It supports auto keystone correction and manual keystone correction.

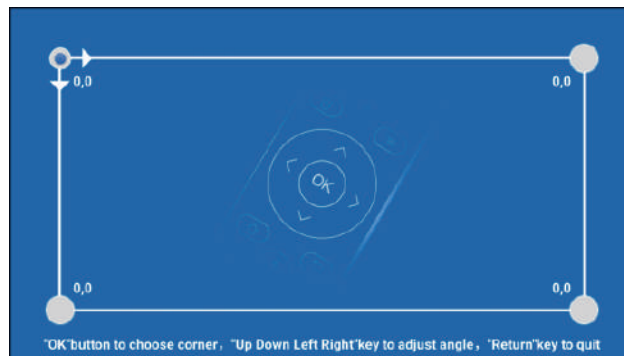
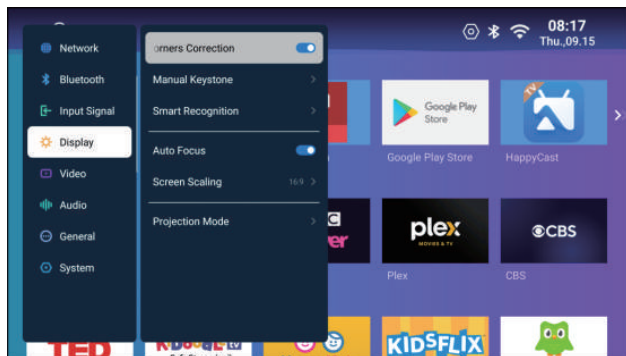

Screen Scaling

The size of the screen can be adjusted according to the different aspect ratios.

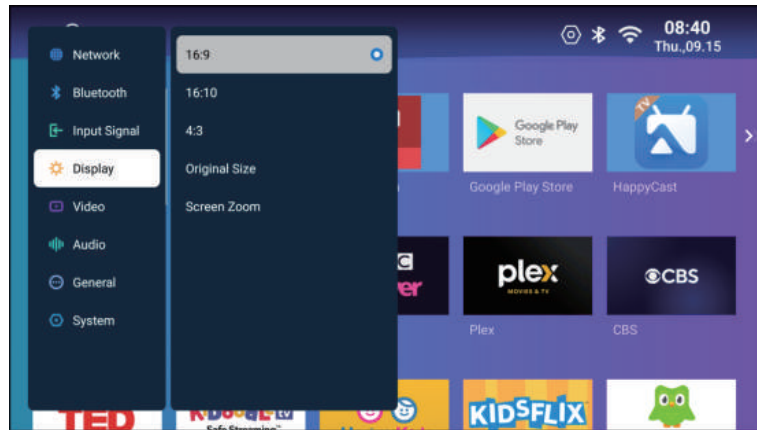

Video Setting

Enter Setting - Video - Picture Mode to set the different picture modes, it includes standard, soft, user and vivid four modes.
Enter Setting - Video - Advanced Picture to set Color Temperature, NR (noise reduction function), Dynamic Contrast, Flesh Tone, Blue Extend and Over Scan.

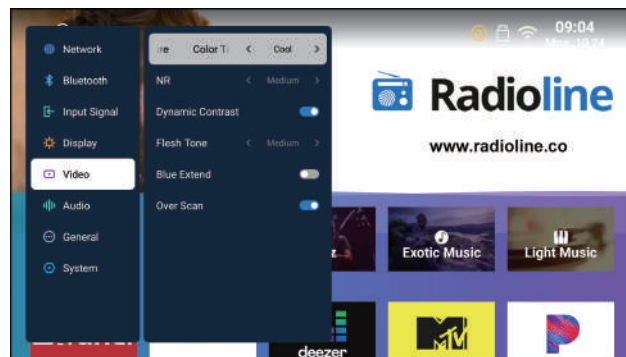
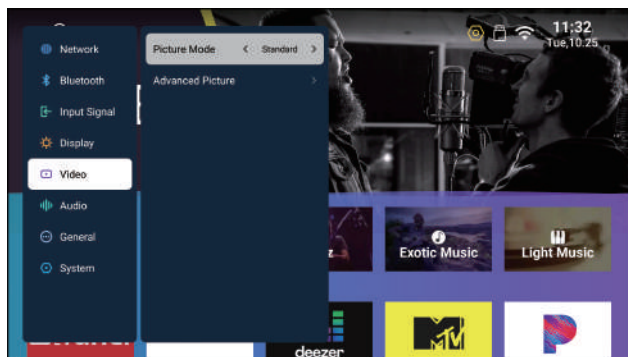

Audio Setting

Enter Setting - Audio to set Sound Mode, Voice Device, Advanced Voice, Sound Effects.

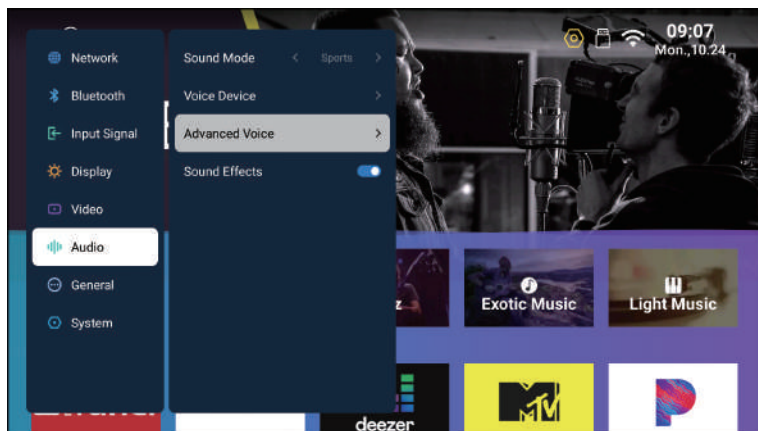

APP Setting

Enter Setting - General - App Settings to manage APP.

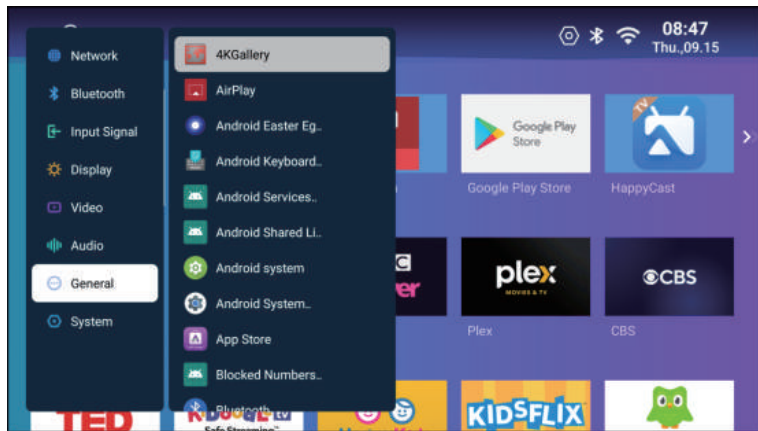

Language Setting

Enter Setting - System - Language to set the language.



Input Method Setting

Enter Setting - System - Input Method to switch keyboard input.

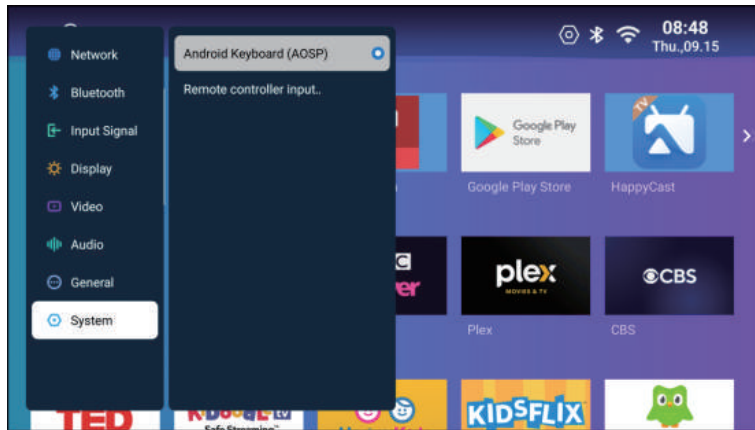

Time Setting

Enter Setting - System - Date and Time to set the time zone, date and time by remote control.

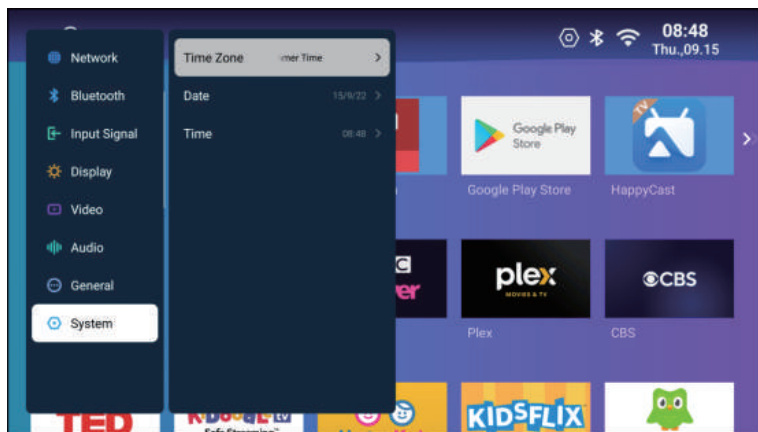

Screen Mirroring – EShare Instructions for Android

Install EShare on Android device

- ① Make sure the Android device and the projector are connecting with the same network.
- ② Run EShare on the projector. According to the prompts at the screen, visit <https://h.eshare.app>, download and install the EShare application on Android device.

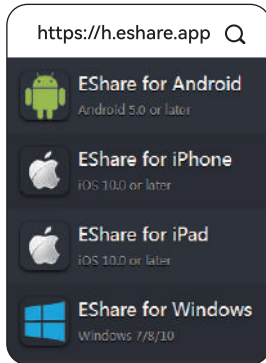

1. Make sure your device is connected to the same network with this device.
2. Visit <https://h.eshare.app> with web browser or scan the QR-code to download app.
3. Launch EShare and click **EShare** to connect.

A circular callout bubble with a dark blue background and a white border. It contains the text "Use your device is connected" at the top, followed by the URL <https://h.eshare.app> in a white box, and "with EShare and click 'EShare'" at the bottom.

Screen Mirroring – EShare Instructions for Android

1. Instructions

When EShare installation is finished, run EShare on smart phone side, then EShare will automatically search for the projector which shares the same network with it, click device list on the top to search again and check device. Click objective device name on the device list and the connection will be built. Click Share Screen to share screen with projector. Click Stop Sharing to quit screen mirroring.





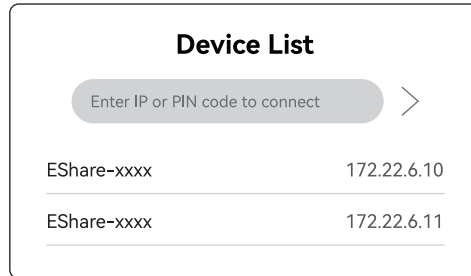

1. Make sure your device is connected to the same network with this device.
2. Visit '<https://h.eshare.app>' with web browser or scan the QR-code to download app.
3. Launch EShare and click 'EShare-xxxx' to connect.

connected to
are.app' with web
ck 'EShare-xxxx' to



Screen Mirroring – EShare Instructions for Android

	<p>2. Wireless File Transfer On completion of device connection, music, video, pictures, office documents, PDF, e-book, APK and other files can be transferred to projector from your Android device. Click Storage to realize file sharing and to save the local files.</p>
	<p>3. Wireless Control Click this icon in the EShare, then the smart phone can be used as a mouse, remote control, keyboard, or air mouse of the projector.</p>
	<p>4. Wireless Camera Click this icon in the EShare, pictures and sound of the smart phone camera can be transmitted to the projector in real-time.</p>
	<p>5. TV Mirroring Click this icon in the EShare, you can transmit pictures from projector to smart phone in real-time. Meanwhile, the smart phone will serve as touch panel for projector, you can achieve multi-point touch on the projector through the smart phone.</p>

Screen Mirroring – EShare Instructions for iPhone

Install EShare on iPhone device

- ① Make sure the iPhone device and the projector are connecting with the same network.
- ② Run EShare on the projector. According to the prompts at the screen, visit <https://h.eshare.app>, download and install the EShare application on iPhone device.

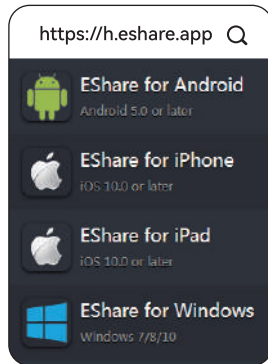

1. Make sure your device is connected to the same network with this device.
2. Visit <https://h.eshare.app> with web browser or scan the QR-code to download app.
3. Launch EShare and click "EShare" to connect.

A circular callout bubble with a dark blue background and a white border. It contains the text: "Make sure your device is connected to the same network with this device." followed by the URL <https://h.eshare.app> and the instruction "Launch EShare and click 'EShare' to connect."

Screen Mirroring – EShare Instructions for iPhone

1. Instructions

When EShare installation is finished, run EShare on smart phone side, then EShare will automatically search for the projector which shares the same network with it, click device list on the top to search again and check device. Click objective device name on the device list and the connection will be built. Click Share Screen – Start Broadcast to share screen with projector. Click Stop Broadcast to quit screen mirroring.





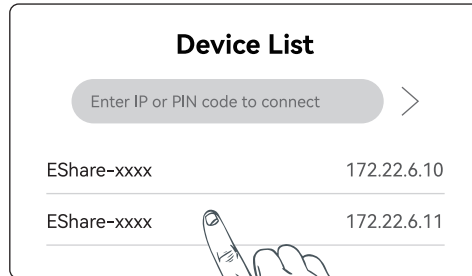

1. Make sure your device is connected to the same network with this device.
2. Visit '<https://h.eshare.app>' with web browser or scan the QR-code to download app.
3. Launch EShare and click 'EShare-xxxx' to connect.



connected to
are.app' with web
ck 'EShare-xxxx' to

Screen Mirroring - EShare Instructions for iPhone

	<p>2. Wireless File Transfer On completion of device connection, music, video, pictures, office documents, PDF, e-book, APK and other files can be transferred to the projector from your iPhone device. Click Storage to realize file sharing and to save the local files.</p>
	<p>3. Wireless Control Click this icon in the EShare, then the smart phone can be used as a mouse, remote control, keyboard, or air mouse of the projector.</p>
	<p>4. Wireless Camera Click this icon in the EShare, pictures and sound of the smart phone camera can be transmitted to the projector in real-time.</p>
	<p>5. TV Mirroring Click this icon in the EShare, you can transmit pictures from projector to smart phone in real-time. Meanwhile, the smart phone will serve as touch panel for projector, you can achieve multi-point touch on the projector through the smart phone.</p>

Screen Mirroring - EShare Instructions for Windows

Install EShare App on Windows Device

- ① Make sure the Windows device and the projector are connecting with the same network.
- ② Run EShare on the projector. According to the prompts at the screen, enter the download website into the address bar of browser, download and install EShare for Windows.

EShare will automatically search for the projector which share the same network with it. When EShare find the device, click projector name on the device list to build the connection. Click Start Mirror to wireless mirror the screen of the Windows device to the projector. Click Stop Mirror to quit screen mirroring.

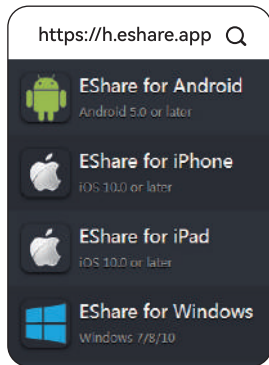

Screen Mirroring – Miracast Instruction

1. Make sure your phone and the projector are connecting with the same network. Turn on wireless screen casting in the status bar of your phone.
2. Select the searched projector for the wireless screen transfer function.

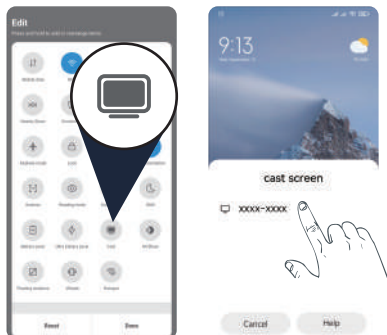

The screen mirroring ways for popular models:

1. Pull down the notification bar on the home screen, find the Cast / Share function and turn on Cast Screen.

Samsung: Pull down the notification bar on the home screen, click Smart View to turn on screen casting.

You can also turn on screen casting through the following setting path.

Xiaomi	Settings → Connect & Share → Cast Screen → Enter Screen Cast .
Huawei	Settings → More Settings → Phone Casting → Wireless Screen Casting.
OPPO	Settings → Other wireless connections → Phone Casting → Enter Casting.
VIVO	Other networks and connections → Phone Casting → Enter Screen Casting.

The setting path is for reference only due to the different models of cell phone manufacturers or system upgrades.

2. Then the phone will automatically search for the screen mirroring device, click connect.

Screen Mirroring - Airplay

1. Make sure your phone and the projector are connecting with the same network. Open Control Center and click Screen Mirroring.
2. Select the projector searched for. The wireless screen transfer function is now available.

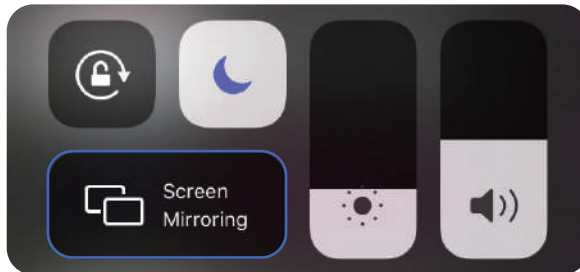

Screen Mirroring – iPhone Wired Screen Mirroring

1. Connect your phone and projector by the data cable, select Trust at the pop-up window.
2. If the phone has set the password, you need to enter the password to confirm. It will automatically share screen to projector.

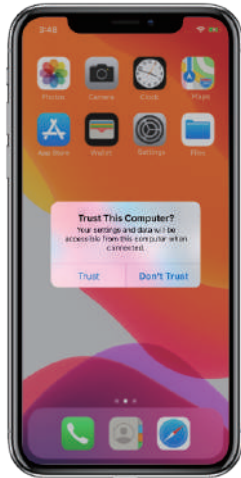

Screen Mirroring – Android Wired Screen Mirroring

1. Connect your phone and projector by the data cable, at the pop-up window, select View and Install App.
2. Make sure to open eShareLine in the pop-up window on your phone. It will automatically share screen to projector.

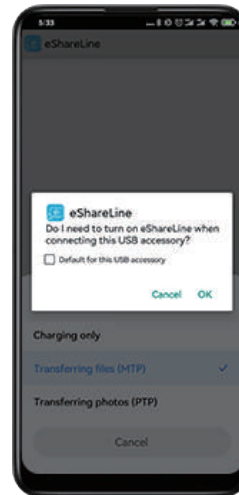
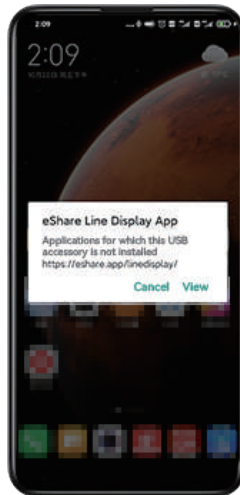

USB Connection

a. Insert the USB flash/storage hard drive into the USB port, the USB pop-up window will appear.

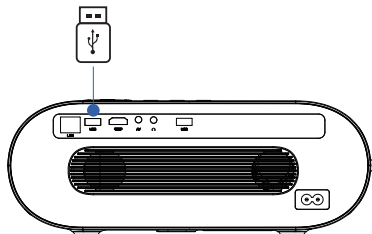

Support local decoding 2K

Supported multimedia formats

b. Choose the content which you need to play.

Video Play	H.264 / H.265 / Vp9 / MPEG1 / MPEG2 / MPEG4 / VP6 / VP8
Picture Play	jpg / png / bmp etc.
Audio Play	LPCM / MP3 / APE / MP3 etc.

HDMI Connection

a. Use the HDMI port to connect computers and HDMI compatible devices. Once connected, select the HDMI signal source.

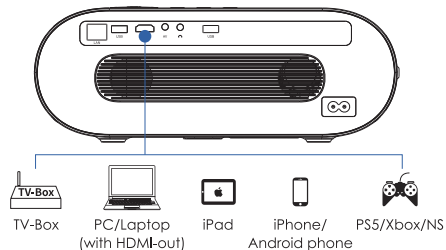

HDMI

The terms of HDMI and HDMI High-Definition Multimedia Interface, and the HDMI Logo are trademarks or registered trademarks of HDMI Licensing Administrator, Inc. in the United States and other countries.

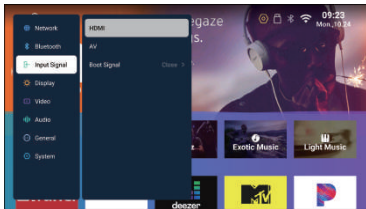

Tips:

1. Mini Display Port to HDMI Cable, Thunderbolt to HDMI Adapter are needed to be compatible with Apple iMac, MacBook, Surface, ThinkPad.
2. Supported resolution:
576P, 480P, 720P, 1080P, 640x480, 800x600, 1024x768, 1280x1024, 1280x720, 1440x900, 1366x768, 1920x1080, 1280x800, 1440x960, 680x1050
3. HDMI input supported refresh rate: $\leq 60\text{fps}$

3.5mm audio connection

a. Use a 3.5mm audio jack to connect headphones and speaker equipment.

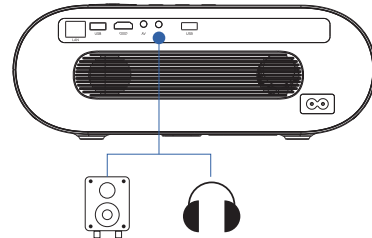

Projector Installation

Technology Features

Place your projector on the ceiling

1. When installing the projector on the ceiling, please purchase a projector bracket recommended by an installation professional and follow the instructions supplied with the bracket.
2. Before installing the projector on the ceiling, please check if the mounting structure can support the weight of the projector and the bracket. If in doubt, please consult the advice of an installation.

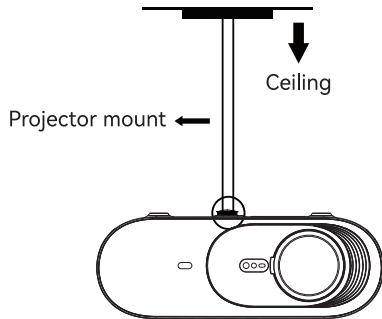

Fixed Hanger Screw Hole Type: 1/4 inch.
NOTE: Projector bracket and screw(s) are not included.

a. Parameters

Imaging technology	TFT LCD	Aspect ratio	16:9
Resolution	1920×1080	Focus mode	Electrical Focus Autofocus
Maximum compatible resolution	1920×1080, 2K	Power input	100-240V~ 50/60Hz 2A
Light	LED	Output	Earphone
Input	AV×1 / USB×2 / HDMI×1 / Ethernet×1	Speaker	8W×1
		Unit size	300×245×107mm
Projection ratio	1.5:1	Net weight	2650g

b. Projection Distance and Screen Size Recommended Projection Distance: 39-90 inches

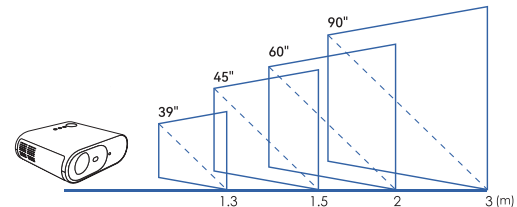

NOTE: Because the optical device has about 3% error, the above data is for reference only, please install the projector according to the actual measurement.

Questions & Answers

* Problems listed below might occur during the operation of your projector. Please refer to the possible factors which might cause the issue to do troubleshooting.

[Audio]Q: Why is the audio of the projector available but no display?

- A1: The video format is not supported by the projector.
A2: Encryption applied to the videos or media player which holds the video.
A3: If the lamp of the projector is off with only audio playing, the lamp is defective.
A4: Try another HDMI cable if you select the HDMI input source.
A5: Try YouTube if your screen mirroring player is Netflix, Amazon Prime, Hulu or Disney+. The problem will happen when playing these applications because of copyright.

[Audio]Q: Video playback is out of sync with sound and picture?

- A1: The fluency of playing is related to the network. If you are connected to a bluetooth device, it generally has a delay display.

[Signal]Q: Why does the projection screen show "No Signal"?

- A1: Make sure all cables are plugged correctly and firmly.

[Mounting]Q: What kind of screws do I need for mounting this projector?

- A1: 1/4 inch.

[Image]Q: What can I do if the image is blurry?

- A1: Press the auto focus button of the remote control / Adjust the focus ring by moving it leftward / rightward till it shows the correct image.
A2: Place the projector on a flat surface horizontally or vertically. An inclination at any angle may result in blurry displays or uneven colors.
A3: Darker environment suggested achieving the best projection performance.
A4: The eligible distance of 39-90 inches between the projector and projecting screen / wall.
A5: Projecting wall or screen is clean white if possible.

[Image]Q: How can I do if the image is up side down?

- A1: Enter Setting - Display - Projection Mode to rotate the image.

[Image]Q: How can I do if the projection screen is not square or allied horizontally?

- A1: If the projection screen is not square, you could enter Setting - Display - Manual Keystone to adjust the image.
A2: Make sure the projector is placed on a flat surface with a projector light in the middle of the screen.
A3: Make sure the projector screen is placed horizontally.

[Image]Q: How can I do if there is color distortion?

- A1: Make sure the video source has a fine resolution.
A2: Reset the projector to manufacturer setting: enter Setting-System - Factory Reset to reset.

[Image]Q: How can I do if there is line/blurry screen in the projection picture?

- A1: Please restart it to see if it can be solved. The line/blurry screen is caused by the motherboard or screen.

[Remote Control] Q: How can I do when the remote is unresponsive?

- A1: Make sure the batteries are installed correctly and the power is enough.
A2: Please make sure the IR receiver is not covered.

[Setting]Q: How can I change the language?

- A1: Enter Setting-System Setting-Language to select your language.

[Damage]Q: How should I do if there is expanding dark spot or smoke when using the projector?

- A1: Check if the fan noise increases or the fan stops working.
A2: Make sure the outlet and projector power adapter are not wet or humid which will cause sparks or smoke on outlet when power on the projector.

Questions & Answers

[Shut Off]Q: Why does the projector is shut off during playing?

A1: Make sure the power plug is working and firmly fitted into the outlet.

A2: Overheat the projector will activate the built-in power-off protection panel. Restart the projector when it gets cooler.

[USB]Q: Why doesn't anything work in the main interface especially with external storage connected?

A1: Correct input source must be selected when you use the USB disk, otherwise"

No Signal "will be shown on the screen.

[HDMI Connection]Q: Why does the projector show "No Signal" when HDMI connection?

A1: Please read the instructions of the HDMI adapter carefully before connecting.

A2: Please make sure to use an original cable, check the correct HDMI ports, or if there is any damage of the cable.

A3: For the first time connection to some computers, it needs to make setting of the projector: Set - display - set the projector as the second screen.



This equipment has been tested and found to comply with the limits for a Class B digital device, pursuant to part 15 of the FCC Rules. These limits are designed to provide reasonable protection against harmful interference in a residential installation. This equipment generates, uses and can radiate radio frequency energy and, if not installed and used in accordance with the instructions, may cause harmful interference to radio communications. However, there is no guarantee that interference will not occur in a particular installation. If this equipment does cause harmful interference to radio or television reception, which can be determined by turning the equipment off and on, the user is encouraged to try to correct the interference by one or more of the following measures:

- Reorient or relocate the receiving antenna.
- Increase the separation between the equipment and receiver.
- Connect the equipment into an outlet on a circuit different from that to which the receiver is connected.
- Consult the dealer or an experienced radio/TV technician for help.

Caution: Any changes or modifications to this device not explicitly approved by manufacturer could void your authority to operate this equipment.

This device complies with part 15 of the FCC Rules. Operation is subject to the following two conditions: (1) This device may not cause harmful interference, and (2) this device must accept any interference received, including interference that may cause undesired operation.

RF Exposure Information

This equipment complies with FCC radiation exposure limits set forth for an uncontrolled environment. This equipment should be installed and operated with minimum distance 20cm between the radiator and your body.