

### 【 Attention 】

Please read this manual carefully before use and keep it for future reference.

- 1.The projector is non dustproof or non waterproof.
- 2.In order to reduce the risk of fire and electric shock, do not expose the projector to rain and fog.
- 3.Please use the original power adapter. The projector should work under specified rated power supply.
- 4.When projector is working, please do not look directly into the lens, the strong light will flash your eyes and cause slight pain. Children should use the projector under the supervision of adults.
- 5.Do not cover the vents of projector. Heating will reduce the life of projector and cause danger.
- 6.Regularly clean projector vents, or dust may cause cooling malfunction.
- 7.Do not use the projector in greasy, damp, dusty or smoky environment. Oil or chemicals will cause malfunction.
- 8.Please handle with care during daily use.
- 9.Please cut off the power if the projector is out of use for long time.
- 10.Non-professionals are forbidden to disassemble the projector for testing and maintenance.

### 【Structure description】

The picture and function description of the projector are for reference only. It is subject to change without prior notice.

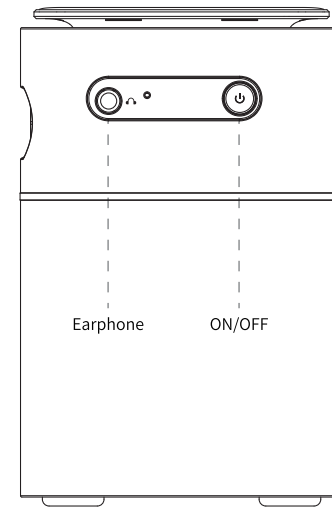
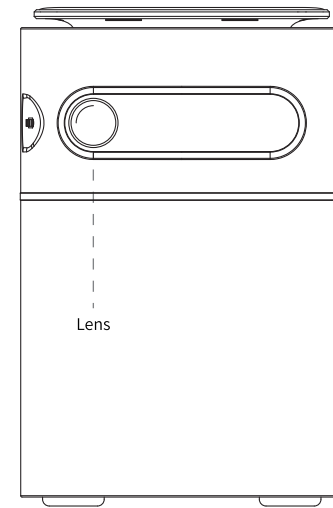
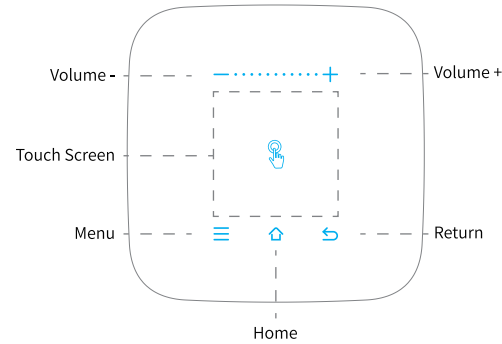

## Portable Projector

※ Quick Installation and Use Guide ※

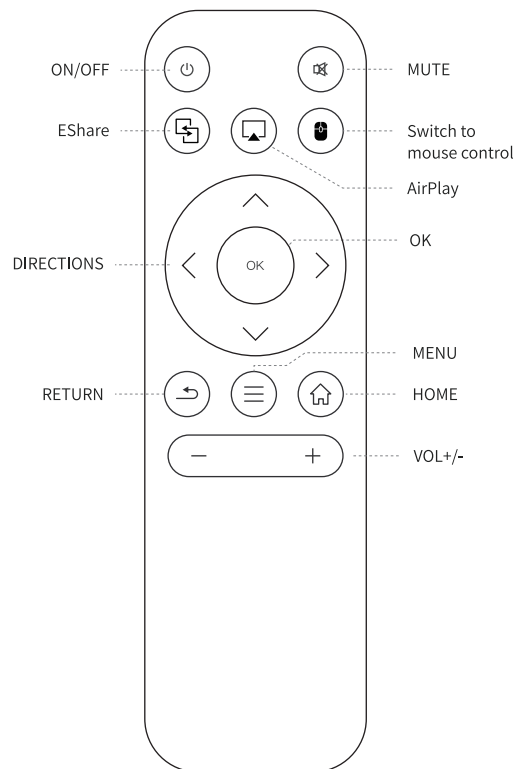
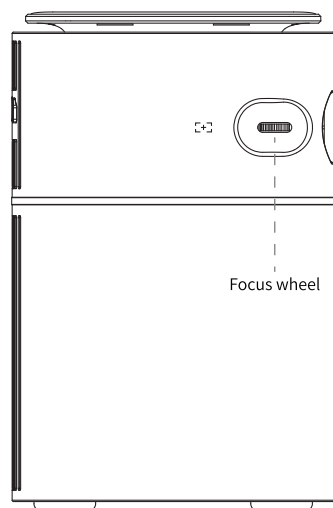
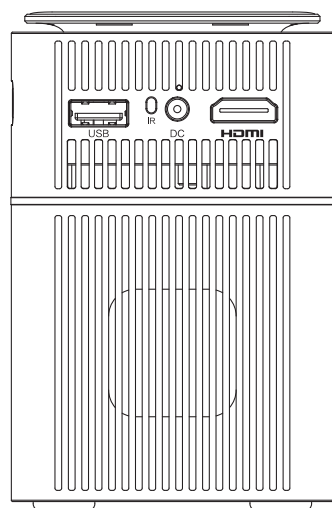

### 【Power ON/OFF】

Press ON/OFF button to turn it on, then press promptly to turn it off.

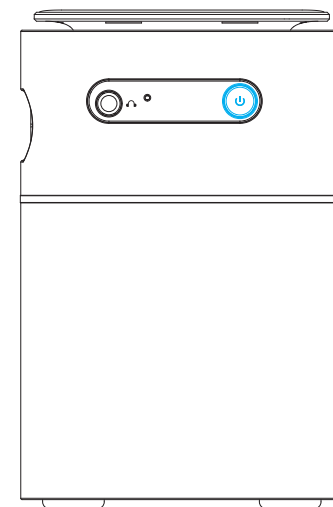

### FCC Warning

This device complies with part 15 of the FCC rules. Operation is subject to the following two conditions: (1) this device may not cause harmful interference, and (2) this device must accept any interference received, including interference that may cause undesired operation.

Changes or modifications not expressly approved by the party responsible for compliance could void the user's authority to operate the equipment.

NOTE: This equipment has been tested and found to comply with the limits for a Class B digital device, pursuant to part 15 of the FCC Rules. These limits are designed to provide reasonable protection against harmful interference in a residential installation. This equipment generates uses and can radiate radio frequency energy and, if not installed and used in accordance with the instructions, may cause harmful interference to radio communications. However, there is no guarantee that interference will not occur in a particular installation. If this equipment does cause harmful interference to radio or television reception, which can be determined by turning the equipment off and on, the user is encouraged to try to correct the interference by one or more of the following measures:

- Reorient or relocate the receiving antenna.
- Increase the separation between the equipment and receiver.
- Connect the equipment into an outlet on a circuit different from that to which the receiver is connected.
- Consult the dealer or an experienced radio/TV technician for help.

### Radiation Exposure Statement

This equipment complies with FCC radiation exposure limits set forth for an uncontrolled environment. This equipment should be installed and operated with minimum distance 20cm between the radiator and your body.

電波法により5GHz帯は屋内使用に限ります

(ZX-EN-D042210521)

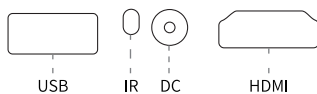

### 【Settings】

Enter settings for Network, Bluetooth, Language, Sound, Time, Projector settings.

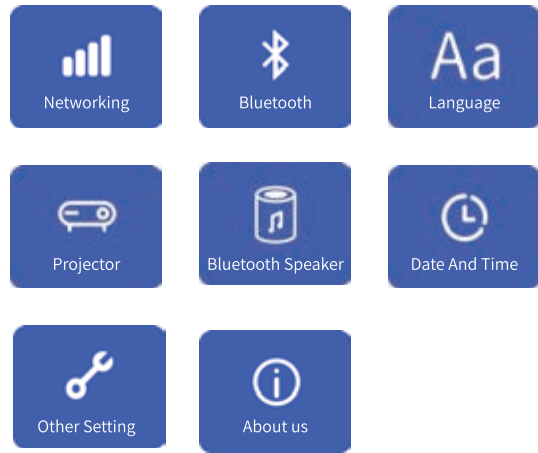

### 【WIFI Setting】

1. Settings - Network Setting - WIFI setting, WIFI "ON";
2. Scroll the WIFI list to select WIFI ID and input password to connection internet.

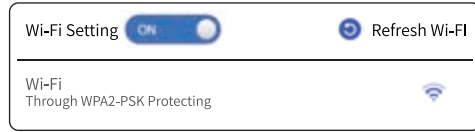

### 【Bluetooth Setting】

Settings - Bluetooth setting, Bluetooth "ON", click "Refresh Device" and search for device pairing until it is connected.

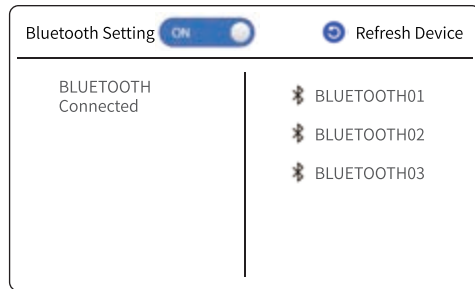

### 【Bluetooth Speaker Mode】

Settings - Bluetooth Speaker - Select "Speaker Mode: Open".

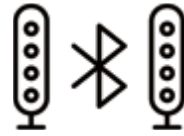

Bluetooth Name: Bluetooth\_Speaker  
Speaker Mode: Open

Turn on smartphone and search "Bluetooth Name" Bluetooth device, Select "Bluetooth Name" and start pairing, waiting for the instruction as below: Do you want to pair with Bluetooth Name? Press "OK" to finish the pairing.

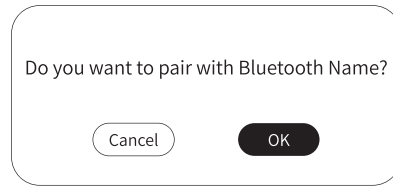

Press remote control "↩" or "🏠" button to quit "Bluetooth Speaker Mode".

### 【Language Setting】

Settings - Language Setting, enter to setup "Language" and "Input Selector".

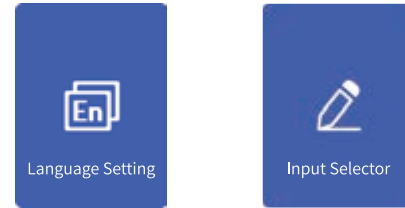

### 【Other Setting】

Setting - Other Setting, Application settings, Factory Reset, and Developer mode are available.

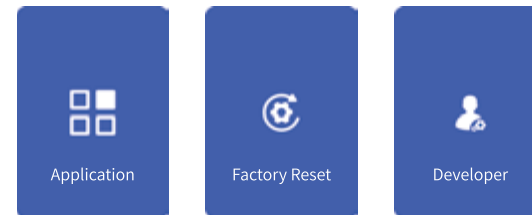

### 【Projection Setting】

Setting - Projector setting, Enter the projection settings to select the appropriate projection Mode, Keystone, adjust the brightness, adjust the color temperature adjustment, adjust the wind speed.

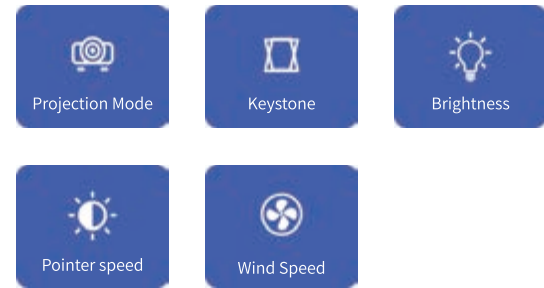

### 【HDMI IN】

This is an HDMI-enabled product, HDMI IN function, mainly input the signal from other equipment into the projector and project on screen, Come to projector menu and click "HDMI" icon to enter HDMI mode.



### EShare Instruction for Android

1. Install EShare App on Android Device  
① Please make sure that Android device and projector are connecting with same network.  
② Run "EShareServer" on projector side and operate according to the tips on the screen. Scanning QR code or visiting download website with Android smart phone, downloading and installing "EShare for Android"



1. Connect your cellphone to network (same network connected to the projector)
2. Visit "EShare download link" in explorer or scan QR code with cellphone to download and install the app.
3. Open EShare, then click "Device name".

2. Connect Projector with Android Device  
When EShare installation is finished, run "EShare" on smart phone side, then EShare will search for the projector which shares the same network with it automatically, click device list on the top to search again and check device. Click objective device name on the device list and the connection will be built. Projector will connect with device automatically when there is only one device available in EShare side.



3. Wireless File Transfer  
User can transfer selected files including music, video, pictures, office documents, PDF, e-book or APK from your Android devices to Projector by clicking "Storage".

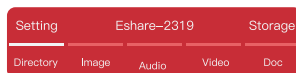

### EShare Instruction for Android

4. Wireless Control  
Click this icon in the EShare, then the smart phone can be used as the mouse, remote controller, keyboard or fly mouse of the projector.



Wireless Control

5. TV Mirror  
Click this icon in the EShare, you can transmit pictures from projector to smartphone in real-time. Meanwhile, the smartphone will serve as touch-pad for projector, you can achieve multi-point touch on the projector through the smartphone.



TV Mirror

6. Mirroring  
Click this icon on the smartphone, you can transmit the screen of Android device to projector screen.



Mirroring

7. Camera  
Click this icon in the EShare, pictures and sound of the smartphone camera can be transmitted to the projector in real-time.



Camera

### EShare Instruction for iPhone

1. Slide iPhone screen from bottom to top, click AirPlay mirror, then choose device in the list to achieve sharing screen with iPhone.



2. Install EShare App on IOS Device  
① Open App Store on iPhone or iPad;  
② Search "EShare" and install "EShare for iPhone/iPad".



EShare

3. Connect with Projector  
① Please make sure that IOS device and projector are connecting with same network.  
② Open "EShare" app, then EShare will search for the projector which share the same network with it automatically.



1. Connect your cellphone to network (same network connected to the projector).
2. Visit "EShare download link" in explorer or scan QR code with cellphone to download and install the app (iPhone can download in APP store).
3. Open EShare, then click "Device name".

4. Wireless Transfer  
After connection is built, user can transfer files from IOS device to projector including music, video, pictures, office documents, PDF, APK etc. User can share and save local files by clicking Save icon.

### EShare Instruction for Windows

1. Install EShare App on Windows Device  
① Please make sure that Windows device and projector are connecting with same network.  
② Run "EShareServer" on the projector and operate following the tips on the screen. Input download address in Explorer address bar, download and install "EShare for Windows".



1. Connect your cellphone to network (same network connected to the projector).
2. Visit "EShare download link" in explorer or scan QR code with cellphone to download and install the app.
3. Open EShare, then click "Device name".

2. Connect with Projector  
Run "EShare" app, then EShare will search for the projector which share the same network with it automatically. When EShare find the device, click projector name on the device list to build the connection.



### 【 Safety instructions 】

- Please pay attention to important information related to the operation and maintenance of the projector. You should read this information carefully to avoid problems. Following safety instructions will increase the life of projector.
- Please consult the qualified personnel for installation and repair services, and do not use damaged wires, accessories and other peripherals.
- Projector should be kept away from flammable, explosive, strong electromagnetic interference (large radar stations, power stations, substations), etc. Strong ambient light (avoid direct sunlight), etc.
- Do not cover projector vents.
- Please use the original power adapter.
- Keep adequate ventilation and make sure vents are not covered to avoid projector overheating.
- When projector is working, please do not look directly into the lens, the strong light will flash your eyes and cause slight pain.
- Do not bend or drag the power cord.
- Do not put power cord under projector or any heavy objects.
- Do not cover other soft materials on power cord.
- Do not heat the power cord.
- Avoid touching power adaptor with wet hands.