

WE APPRECIATE FEEDBACK!

Please allow our customer service team to help with any issues before you leave a review.



/atomismartino



/atomi_smart



@atomi.smart

Need assistance?



DO NOT RETURN THIS
PRODUCT TO THE STORE

Call 1-800-757-1440

Mon-Fri 9:00 a.m. - 5:00 p.m. EST (US)
or email us at info@atomiusa.com



Shower Head with Bluetooth Speaker

Single-Function Shower Head + Wireless Shower Speaker

User Manual

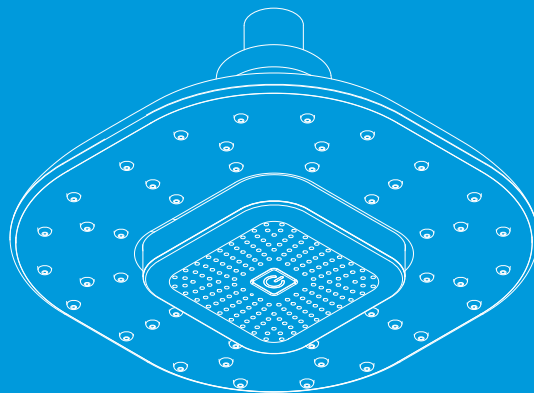

Date Code: 09/22

Thank you for purchasing the Atomi Shower Head with Bluetooth Speaker

Get ready to turn your shower into a spa experience. Just add water - and your favorite podcast or playlist - while getting ready in the morning and unwind at night. The bluetooth speaker also lets you answer phone calls!

High quality and great sounding, this shower speaker can be set up in a cinch.

What's Inside

Shower head
Bluetooth speaker
1-foot micro-USB cable

Specifications

Speaker: 5W
Battery: 500mAh Lithium-Ion
Bluetooth: Bluetooth® 5.0 - 33 ft. Range
Waterproof Rating: IPX4
Flow Rate: 1.8gpm (6.8L/min) Max.
Water Consumption: 1.8gpm (6.8L/min) Max.
Bluetooth name: Atomi Shower Head Speaker

Installation

1

Flush debris.

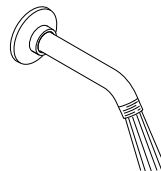

2

Apply sealant tape.

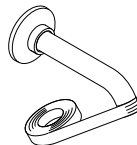

3

Install the shower head.

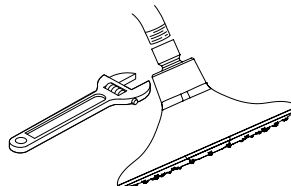

Note: Wrench not included.

Powering on and Pairing the Shower Head with Bluetooth Speaker

1

The Atomi Shower Head with Bluetooth Speaker has only one button, the power button.

To turn the Atomi Shower Head with Bluetooth Speaker ON:
Press the power button for 2 seconds.

To turn the Atomi Shower Head with Bluetooth Speaker OFF:
Press the power button for 2 seconds.

To pick up or end a call:
Short press the power button.

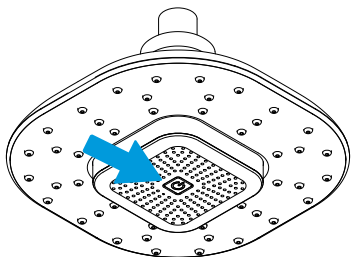

Volume is controlled only by the device connected to your Shower Head with Bluetooth Speaker.

2

To pair the Atomi Shower Head with Bluetooth Speaker with your device:

- Make sure your device has Bluetooth® capability.
- Turn the Atomi Shower Head with Bluetooth Speaker on.
 - Watch for the power button to fast-flash in blue, indicating that it's in pairing mode.

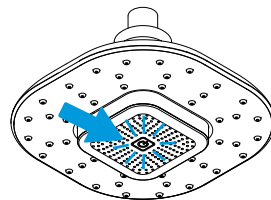

- Follow the instructions of your device to pair the unit.
- Pair your device by selecting Atomi Shower Head with Bluetooth Speaker from the Bluetooth® listing on your device or by selecting YES. When successfully connected, you will hear one beep and the power button on the Atomi Shower Head with Bluetooth Speaker will go steady blue.

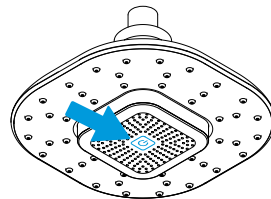

- Press play on your device and use controls on it to adjust desired volume.

Charging the Shower Head with Bluetooth Speaker

Pull the speaker from the Shower Head with Bluetooth Speaker to detach it. The charger is located on the back of the speaker. Charge by using the USB to Micro USB cord (included) with a computer or AC adapter with USB jack (not included).

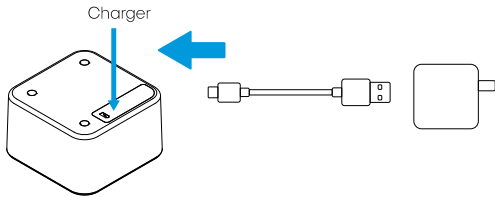
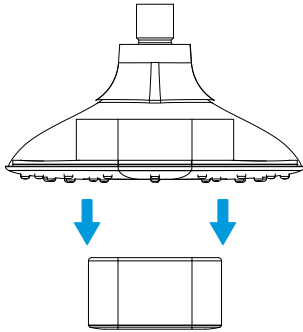

Power Indicator



Blue slow flashing (2s):
Low battery



Steady Red:
Charging



Indicator off:
Fully charged

NOTE: Please allow approximately 3 hours for full charge. Battery will last up to 5 hours when connected wirelessly.

IMPORTANT: Do not overcharge the battery for long periods, as it could damage the battery.

Built-In Microphone

The Atomi Shower Head with Bluetooth Speaker is equipped with a built-in microphone, for easy hands-free talking:

1. Make sure the Atomi Shower Head with Bluetooth Speaker is successfully paired with your device.
 2. To answer or end a call, simply press the power button one time when you hear a ringtone.
 3. To reject an incoming call, press and hold the power button for 2 seconds.

NOTE:

When an incoming call is detected, the Atomi Shower Head with Bluetooth Speaker will pause the music and a ringtone will sound. After the call is terminated, the music will resume to play automatically where it left off. When making a call, use your phone to dial and the Atomi Shower Head with Bluetooth Speaker will automatically go into hands free mode.

Note

- Once you have successfully paired your device, you may not need to repeat the above steps.
- When pairing with a computer, please consult your computer manufacturer for Bluetooth® pairing instructions and/or the latest Bluetooth® Drivers.
 - Keep all non-water-resistant devices (phones, mp3 players, etc.) in a dry place where they will not come in contact with water.
 - A pairing code is not required.
- The Atomi Shower Head with Bluetooth Speaker will automatically power off after 10 minutes of inactivity (no Bluetooth connection / no play)

Safety Information

1. Read these instructions carefully for best use.
2. DO NOT use the Shower Head with Bluetooth Speaker near open flames, such as candles, heat sources, radiators, and stoves.
3. Only clean the Shower Head with Bluetooth Speaker with a dry cloth.
4. **WARNING:** Risk of electric shock.
5. For connection to a power supply not in the U.S.A., use an attachment plug adapter of the proper configuration for the power outlet, if needed.
6. Please check before use, if the output voltage and current of the power supply are suitable for the product.
7. Children should be supervised to ensure that they do not play with the appliance. **THIS IS NOT A TOY.**
8. Use this product only for its intended use as described in this manual.
9. Atomi is not liable for any damage caused to smartphones, iPod®/MP3 player or any device.
10. Never operate this product if it has a damaged cord, plug, cable or housing.
11. Only set on dry surfaces. Do not place on surfaces wet from water or cleaning solvents.
12. **CAUTION:** Risk of property damage. Do not expose batteries to sunlight, fire, or other forms of excessive heat.
13. **CAUTION:** Risk of product damage. Do not submerge the wireless speaker.
14. **CAUTION:** Risk of product damage. The wireless speaker and battery are rated to operate in temperatures up to 140°F (60°C). Do not expose to heat sources or install in any location where the temperature may exceed 140°F (60°C).

FCC Statement

This equipment has been tested and found to comply with the limits for a Class B digital device, pursuant to part 15 of the FCC Rules. These limits are designed to provide reasonable protection against harmful interference in a residential installation. This equipment generates, uses and can radiate radio frequency energy and, if not installed and used in accordance with the instructions, may cause harmful interference to radio communications. However, there is no guarantee that interference will not occur in a particular installation. If this equipment does cause harmful interference to radio or television reception, which can be determined by turning the equipment off and on, the user is encouraged to try to correct the interference by one or more of the following measures:

- Reorient or relocate the receiving antenna.
- Increase the separation between the equipment and receiver.
- Connect the equipment into an outlet on a circuit different from that to which the receiver is connected.
- Consult the dealer or an experienced radio/TV technician for help.

Caution: Any changes or modifications to this device not explicitly approved by manufacturer could void your authority to operate this equipment.

This device complies with part 15 of the FCC Rules. Operation is subject to the following two conditions: (1) This device may not cause harmful interference, and (2) this device must accept any interference received, including interference that may cause undesired operation.

RF Exposure Information

The device has been evaluated to meet general RF exposure requirement.

The device can be used in portable exposure condition, compliance with exposure requirements.