

**SGS Germany GmbH**  
**Test Report No.: N1Y00001**  
**FCC ID: 2AVB6-E702613**

---

**Order No.:** N1Y0

**Pages:** 26

---

**Client:** Christ Electronic Systems GmbH

**Equipment Under Test:** Touch-it CE Front Panel glass 15,6

**Manufacturer / Importer:** Christ Electronic Systems GmbH

**Task:** Compliance with the requirements mentioned below:

**Test Specification(s):**  
[covered by accreditation]

- FCC 47 CFR Part 15  
§15.107  
§15.109
- ICES -003 Issue 6

**Result:** The EUT complies with the requirements of the test specifications.

The results relate only to the items tested as described in this test report.

**approved by:**

**Date**

**Signature**

Bauer  
Lab Manager EMC

Sep 24, 2020

This document was signed electronically.

## CONTENTS

<b>1 Result Summary .....</b>	<b>4</b>
<b>2 References .....</b>	<b>5</b>
2.1 Specification(s).....	5
2.2 Glossary .....	5
2.3 Information concerning FCC Equipment Authorization and Labelling .....	6
2.4 Information concerning ICES Equipment Authorization .....	7
2.4.1 Labelling Requirements .....	7
<b>3 General Information.....</b>	<b>8</b>
3.1 Identification of Client .....	8
3.2 Test Laboratory .....	8
3.3 Time Schedule .....	8
3.4 Participants .....	8
3.5 Environmental conditions .....	8
<b>4 Equipment Under Test.....</b>	<b>9</b>
4.1 Operational conditions.....	11
4.1.1 Software.....	11
4.1.2 Operation modes .....	11
4.2 Hardware Configuration.....	11
4.2.1 Components of the EUT.....	11
4.2.2 Interface description.....	11
4.2.2.1 Power supply port .....	11
4.2.2.2 Earthing and Grounding connections .....	12
4.2.2.3 Communication and signal ports .....	12
4.2.3 Cabling .....	12
4.2.4 Clock frequencies of the EUT resulting in determination of frequency range .....	12
4.2.5 External protection devices or measures.....	13
4.2.6 Modifications during the test.....	13
4.2.7 Operation and monitoring equipment .....	13
4.3 Deviations from Standard .....	13
<b>5 Test Equipment.....</b>	<b>14</b>
5.1 Test Facility .....	14
5.2 Measurement Uncertainty .....	15
<b>6 Test Conditions and Results.....</b>	<b>16</b>
6.1 Conducted disturbance (150 kHz to 30 MHz) .....	16
6.2 Radiated disturbances (30 MHz to 1000 MHz) .....	19

The test report shall not be reproduced except in full without the written approval of the testing laboratory

---

6.3 Radiated disturbances (1 GHz to 6 GHz) .....	23
<b>7 Disclaimer .....</b>	<b>26</b>

The test report shall not be reproduced except in full without the written approval of the testing laboratory

## 1 Result Summary

This report presents the test procedures used and the results obtained during the performance of an FCC 47 CFR Part 15 and ICES-003 test program. The test program was conducted to assess the ability of the tested sample to successfully satisfy the requirements specified in the references listed in Section 2 of this report.

### Tables of Results:

Phenomena	Reference	Frequency range	Criteria	Verdict <sup>1</sup>
Conducted Emission AC power port <sup>2</sup>	FCC 47 CFR Part 15 §15.107	150 kHz – 30 MHz	Class A	P
Radiated Emission Electric Field	FCC 47 CFR Part 15 §15.109	30 MHz - 1 GHz	Class A	P
Radiated Emission Electric Field	FCC 47 CFR Part 15 §15.109	1 GHz - 6 GHz <sup>3</sup>	Class A	P
Conducted Emission AC power port <sup>2</sup>	ICES-003	150 kHz – 30 MHz	Class A	P
Radiated Emission Electric Field	ICES-003	30 MHz - 1 GHz	Class A	P
Radiated Emission Electric Field	ICES-003	1 GHz - 6 GHz <sup>3</sup>	Class A	P

The test report shall not be reproduced except in full without the written approval of the testing laboratory

- <sup>1</sup> **P** (Pass): test object meets the requirement; **F** (Fail): test object does not meet the requirement; **NA**: test case does not apply to the test object; **NR**: test case is not requested by the client; **NP**: test case was not performed
- <sup>2</sup> According ANSI C.63.4 chapter 7.1: If the EUT normally receives power from another device that in turn connects to the public-utility ac power lines, measurements shall be made on that device with the EUT in operation to ensure that the device continues to comply with the appropriate limits while providing the EUT with power. If the EUT is operated only from internal or dedicated batteries, with no provisions for connection to the public utility ac power lines (600 VAC or less) to operate the EUT (such as an adapter), then ac power-line conducted measurements are not required.
- <sup>3</sup> See chapt. 4.2.4; Clock frequencies of the EUT resulting in determination of frequency range

## 2 References

### 2.1 Specification(s)

- [1] FCC 47 CFR Part 15:  
Code of Federal Regulations. Title 47: Telecommunication Part 15: Radio Frequency De-  
vices
- [2] ANSI C63.4-2014, American National Standard for Methods of Measurement of Radio-  
Noise Emissions from Low-Voltage Electrical and Electronic Equipment in the Range of  
9 kHz to 40 GHz
- [3] FCC Public Notice DA 09-2478; Nov 25, 2009; Office of Engineering and Technology  
Clarifies Use of Recently Published ASC C63®  
Measurement Standards for Compliance Testing of Intentional and Unintentional Radia-  
tors under Part 15
- [4] Industry Canada ICES-003 Issue 6; Information Technology Equipment (ITE) – Limits and  
methods of measurement

### 2.2 Glossary

AC	Alternating Current
AMN	Artificial Mains Network
AV	Average Detector
DC	Direct Current
EMC	Electromagnetic Compatibility
EUT	Equipment Under Test
HW	Hardware
LISN	Line Impedance Stabilization Network
QP	Quasi Peak Detector

The test report shall not be reproduced except in full without  
the written approval of the testing laboratory

## 2.3 Information concerning FCC Equipment Authorization and Labelling

### CERTIFICATION (47 CFR Section 2.907)

Certification is the most rigorous approval process for RF Devices with the greatest potential to cause harmful interference to radio services. It is an equipment authorization issued by an FCC-recognized Telecommunication Certification Body (TCB) based on an evaluation of the supporting documentation and test data submitted by the responsible party (e.g., the manufacturer or importer) to the TCB. Testing is performed by an FCC-recognized accredited testing laboratory. Information including the technical parameters and descriptive information for all certified equipment is posted on a Commission-maintained public database. In addition, equipment subject to approval using the Supplier's Declaration of Conformity (SDoC) procedure can optionally use the Certification procedure.

### SUPPLIER'S DECLARATION OF CONFORMITY (47 CFR Section 2.906) → SDoC

Supplier's Declaration of Conformity (SDoC) is a procedure that requires the party responsible for compliance ensure that the equipment complies with the appropriate technical standards. The responsible party, who must be located in the United States, is not required to file an equipment authorization application with the Commission or a TCB. Equipment authorized under the SDoC procedure is not listed in a Commission database. However, the responsible party or any other party marketing the equipment must provide a test report and other information demonstrating compliance with the rules upon request by the Commission. The responsible party has the option to use the certification procedure in place of the SDoC procedure.

#### The key FCC rule sections for SDoC are:

- a. Section 2.906 Supplier's Declaration of Conformity
- b. Section 2.909 Responsible party
- c. Section 2.931 Responsibilities
- d. Section 2.938 Retention of records
- e. Section 2.1072 Limitations on Supplier's Declaration of Conformity
- f. Section 2.1074 Identification
- g. Section 2.1077 Compliance Information

As the EMC-Lab of SGS Germany GmbH is an FCC-recognized accredited testing laboratory, this test report can be used as basis for both procedures.

Based on §15.3 the following description for locations and its emission classes is defined:

(h) **Class A digital device.** A digital device that is marketed for use in a commercial, industrial or business environment, exclusive of a device which is marketed for use by the general public or is intended to be used in the home.

(i) **Class B digital device.** A digital device that is marketed for use in a residential environment notwithstanding use in commercial, business and industrial environments. Examples of such devices include, but are not limited to, personal computers, calculators, and similar electronic devices that are marketed for use by the general public.

Based on §15.105 the relevant **information to the limit class** has to be included in the manual.

Guidelines for **labeling and user information for RF** devices are contained in the following documents:

- 784748 D01 Labeling Part 15 18 Guidelines v09 provides general guidance for Part 15 and Part 18 labeling and user information.
- 748748 D02 e labeling v02 provides guidelines for displaying label information electronically (e-label).

## 2.4 Information concerning ICES Equipment Authorization

ITE is designated as Category II Equipment<sup>4</sup>, meaning that no technical acceptability certificate (TAC) or equipment certification is required. ITE subject to ICES-003 is approved through the method of a “supplier’s declaration of conformity (SDoC)” by the manufacturer, importer or distributor of ITE, which shall ensure that compliance with all technical requirements prescribed by ICES-003 has been demonstrated and that the results have been compiled into a test report.

### 2.4.1 Labelling Requirements

The manufacturer, importer or supplier shall meet the labelling requirements set out in this section and in [Notice 2014-DRS1003](#) for electronic labelling for every unit:

- (i) prior to marketing in Canada, for ITE manufactured in Canada and
- (ii) prior to importation into Canada, for imported ITE.

Each unit of an ITE model shall bear a label (see below) that represents the manufacturer’s or the importer’s SDoC with Innovation, Science and Economic Development Canada’s ICES-003. This label shall be permanently affixed to the ITE or displayed electronically and its text must be clearly legible. If the dimensions of the device are too small or if it is not practical to place the label on the ITE and electronic labelling has not been implemented, the label shall be, upon agreement with Innovation, Science and Economic Development Canada, placed in a prominent location in the user manual supplied with the ITE. The user manual may be in an electronic format and must be readily available.

Innovation, Science and Economic Development Canada ICES-003 Compliance Label:  
CAN ICES-3 (\*)/NMB-3(\*)

\* Insert either “A” or “B” but not both to identify the applicable Class of ITE.

---

<sup>4</sup> See [Radiocommunication Regulations](#) (SOR/96-484).

### 3 General Information

#### 3.1 Identification of Client

Christ Electronic Systems GmbH  
B. Eng. Entwicklung  
Alpenstraße 34  
87700 Memmingen

#### 3.2 Test Laboratory

SGS Germany GmbH  
Hofmannstraße 50  
81379 München

#### 3.3 Time Schedule

Delivery of EUT: Sep 04, 2018  
Start of test: Sep 05, 2018  
End of test: Sep 14, 2018

#### 3.4 Participants

Name	Function
Reinhold Böhm	Accredited testing, Editor
Fath Allah Smaili	Accredited testing, Editor

#### 3.5 Environmental conditions

During the measurement, the environmental conditions were within the listed ranges:

Temperature: 20 - 26 °C  
Humidity: 30 - 60 %



## 4 Equipment Under Test

**Test item description .....**: Touch-it CE Front Panel glass 15,6  
**Trade Mark.....**: None  
**Manufacturer / Importer ..**: Christ Electronic Systems GmbH  
**Model/Type .....**: Touch-it CE Front Panel glass 15,6  
**Number of tested samples.....**: 1  
**Serial Number(s) .....**: SN 0088084-000-002  
**Ratings .....**: 24 V DC  
**Power Supply FSP060:**  
 Input 100 – 240 V AC; 50 – 60 Hz  
 Output: 24 V DC; Max 2.5 A

- The EUT is a Touchscreen display designed for front mounting.

The test report shall not be reproduced except in full without the written approval of the testing laboratory

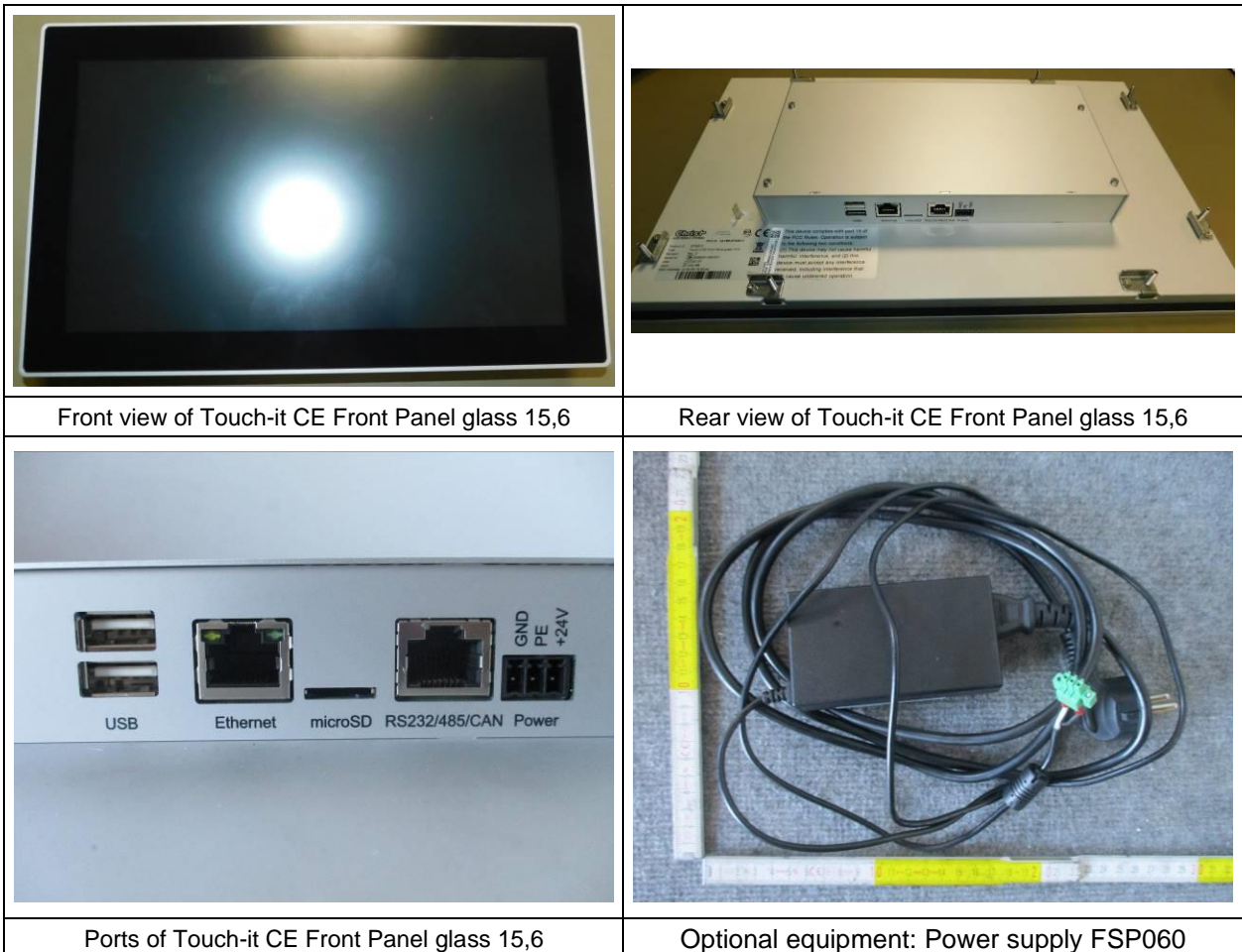

**Figure 4-1: Touch-it CE Front Panel glass 15,6 with Power supply**



Figure 4-2: Copy of type plate

The test report shall not be reproduced except in full without the written approval of the testing laboratory

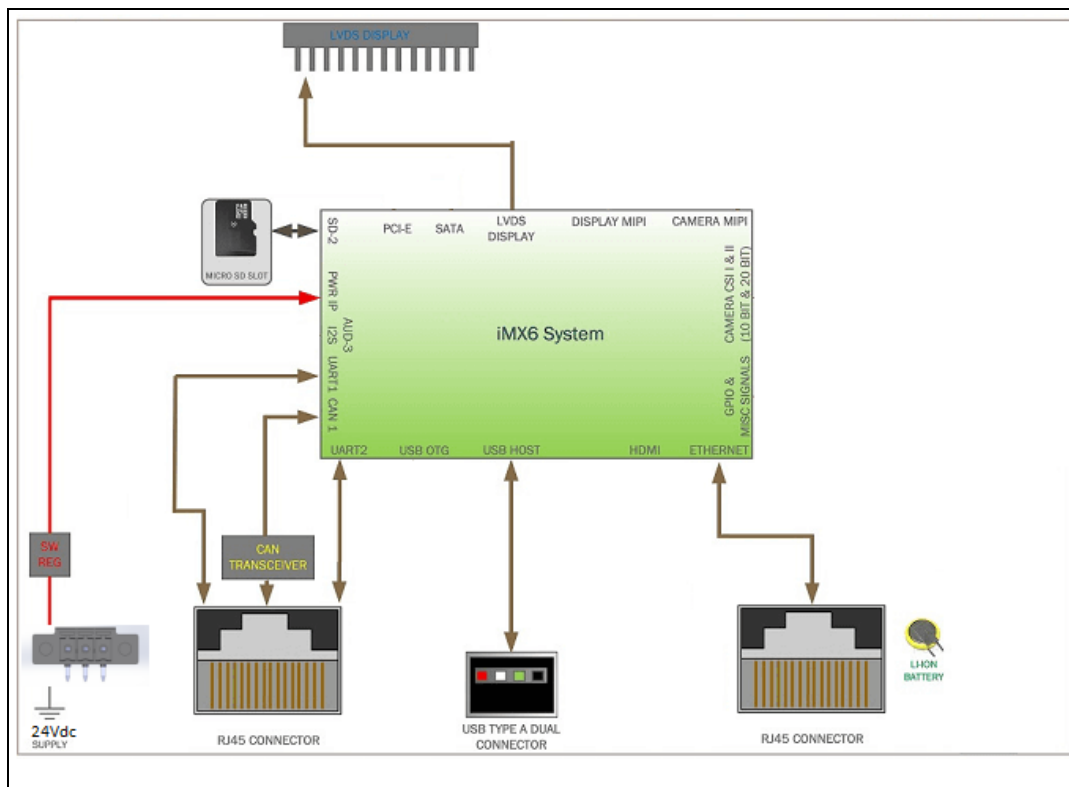

Figure 4-3: Block diagram of function

## 4.1 Operational conditions

### 4.1.1 Software

Software necessary for operating, controlling and monitoring the EUT:

c	Identification Code/Issue	Task
Linux	PA10003982	Operating System

### 4.1.2 Operation modes

Normal operation

Other operation:

Operation mode 1 ..... :

Operation mode 2 ..... :

## 4.2 Hardware Configuration

### 4.2.1 Components of the EUT

Name	Identification Code/Issue/Serial Number	Interface type	Quantity
Touch-it CE Front Panel glass 15.6	SN 0088084-000-002		1

### 4.2.2 Interface description

All interfaces are identified independent whether they are tested or not.

#### 4.2.2.1 Power supply port

Type (AC/DC)	Voltage	Frequency	Current	Power
DC	24 V	---	---	15 W
AC	100 – 240 V	50 – 60 Hz	1.5 A	

#### 4.2.2.2 Earthing and Grounding connections <sup>5</sup>

Type	Task	Connected to	Test E/I/NA
PE			

#### 4.2.2.3 Communication <sup>6</sup> and signal <sup>7</sup> ports

Type	Bit rate/frequency/ Signal	Task	Connected to
Ethernet	100Mbit	Communication	Open end
RS232/RS485/CAN	115kbit/115kbit/1Mbit	Communication	Open end
USB	480Mbit	Data transfer	USB stick
USB	480Mbit	Data transfer	USB stick

#### 4.2.3 Cabling

Name	Identification Code/Issue/ Serial Number	shield	Description of Connection / plug type	length	Quantity
Ethernet	---	yes	Open end	100	2
USB	---	yes	Connection to USB stick	185	2

#### 4.2.4 Clock frequencies of the EUT resulting in determination of frequency range

System / Sub-system	Highest clock frequency
CPU	1 GHz

The result of the table above with the highest frequency of internal source is basis of the determination of the necessity of measurement above 1 GHz. The highest internal source of an EUT is defined as the highest frequency generated or used within the EUT or on which the EUT operates or tunes.

See **FCC §15.33 a)** for relevant frequency range of **intentional radiators**.

See **FCC §15.33 b)** for relevant frequency range of **unintentional radiators**.

See e.g. the following table taken from FCC §15.33 b) 1)

Highest frequency generated or used in the device or on which the device operates or tunes (MHz)	Upper frequency of measurement range (MHz)

<sup>5</sup> Safety ground, functional earth, specific ground connections

<sup>6</sup> Connections to communication networks, analog, Ethernet, antenna, wireless, GPS,

<sup>7</sup> Signalling, monitoring and control ports

Below 1.705	30
1.705-108	1000
108-500	2000
500-1000	5000
Above 1000	5th harmonic of the highest frequency or 40 GHz, whichever is lower

#### 4.2.5 External protection devices or measures

None

#### 4.2.6 Modifications during the test

None

#### 4.2.7 Operation and monitoring equipment

Name / Identification	Task	Availability <sup>8</sup> C/L
Power supply FSP GROUP INC. / Model No: FSP0660-DAAN2	Power supply for conducted emission	C

#### 4.3 Deviations from Standard

None

The test report shall not be reproduced except in full without the written approval of the testing laboratory

<sup>8</sup> C: Provided by the customer, L: Available at laboratory

## 5 Test Equipment

### 5.1 Test Facility

The EMC-tests are carried out in the EMC-laboratory of SGS Germany, Consumer and Retail, Hofmannstraße 50, 81379 München, Germany.

Chamber	1	2	3	4 / 5	6
Dimensions (net)	17.7 * 10.8 * 6.8 m	9.6 * 8.5 * 5.3 m	7.4 * 6.6 * 5.2 m	4.1 * 3.5 * 3.5m	6.4 * 4.3 * 4.3m
Max. Door Exit (w x h)	2.9 * 3.86 m	3.9 * 4.0 m	2.0 * 2.7 m	0.9 * 2.25 m	1.8 * 3.0 m
Shielding material	Sheet steel (Thickness: 1.5mm on floor, 1.0 mm on walls and ceiling)	Sheet steel	Sheet steel	Sheet steel	Sheet steel
Absorbers	Hybrid absorbers on walls and ceiling (TDK), length 1 m	Hybrid absorbers on walls and ceiling (E+C), length 0.5 m	Hybrid absorbers on walls and ceiling (E+C), length 0.3 m	Without absorbers	Without absorbers
Floor	Metallic ground plane floor load: 12 t/m <sup>2</sup>	Metallic ground plane floor load: 1.5 t/m <sup>2</sup>	Metallic ground plane floor load: 1 t/m <sup>2</sup>	Metallic ground plane	Metallic ground plane
Turntable	Ø 4 m / 7 t	Ø 3.2 m / 1.5 t	Ø 2.0 m / 1 t		
Listings	Industry Canada listed until June 2018 Reg. No. 9058A-1	Industry Canada listed until June 2018 Reg. No. 9058A-2  VCCI-listed until Oct. 2019, Reg. No. R-2623, G-266	Industry Canada listed until June 2018 Reg. No. 9058A-3		VCCI-listed until Oct. 2019, Reg. No. C-2866 & No. T-1942
Specials	<p><b>Emission:</b>  <b>30 – 1000 MHz (d = 10 m)</b>                      - NSA acc. to:                      · CISPR 16-1-4                      · ANSI C63.4</p> <p><b>1 – 18 GHz (d = 3 m)</b>                      Site VSWR 1 – 18 GHz acc. to CISPR 16-1-4</p> <p><b>Immunity:</b>                      Field uniformity                      27 – 6000 MHz acc.                      IEC/EN 61000-4-3</p>	<p><b>Emission:</b>  <b>30 – 1000 MHz (d = 3 m)</b>                      - NSA acc. to:                      · CISPR 16-1-4                      · ANSI C63.4</p> <p><b>1 – 18 GHz (d = 3 m)</b>                      Site VSWR 1 – 18 GHz acc. to CISPR 16-1-4</p> <p><b>Immunity:</b>                      Field uniformity                      80 – 6000 MHz acc.                      IEC/EN 61000-4-3</p>	<p><b>Emission:</b>  <b>30 – 1000 MHz (d = 3 m)</b>                      - NSA acc. to:                      · CISPR 16-1-4                      · ANSI C63.4</p> <p><b>1 – 18 GHz (d = 3 m)</b>                      Site VSWR 1 – 18 GHz acc. to CISPR 16-1-4</p> <p><b>Immunity:</b>                      Field uniformity                      80 – 6000 MHz acc.                      IEC/EN 61000-4-3</p>		

The test report shall not be reproduced except in full without the written approval of the testing laboratory

**FCC** (Federal Communication Commission): Recognition by Bundesnetzagentur (BNetzA-CAB-14/21-09) and Designation as **CAB (Conformity Assessment Body)**: Designation Number DE0013; Test firm Registration #: 366296

Designation **KBA (Kraftfahrt-Bundesamt)** as Technical Service category A and D. Registration Number: KBA-P 00083-97

**CB** Testing Laboratory under the responsibility of SGS CEBEC as National Certification Body and to carry out testing within the **IECEE CB Scheme**.

Designation No. for **RRA** (Radio Research Agency) in **Korea**; **EU0145**

## 5.2 Measurement Uncertainty

As far as the underlying standards include requirements concerning the uncertainty of measuring instruments or measuring methods, they are met.

The data and results referenced in this document are true and accurate. The reader is cautioned that there may be errors within the calibration limits of the equipment and facilities.

The expanded measurement uncertainty of the measuring chain was calculated for all tests according to the "ISO Guide to the expression of uncertainty in measurement (GUM)". The results are documented in an "internal controlled document".

The measuring accuracy for all measuring devices is given in their technical description. The measuring instruments, including any accessories, are calibrated respectively verified to ensure the necessary accuracy. Depending on the kind of measuring equipment it is checked within regular intervals or directly before the measurement is performed. Adjustments are made and correction factors applied to measured data in accordance with the specifications of the specific instrument.

The expanded measurement instrumentation uncertainty of our Test Laboratory meets the requirements of IEC CISPR 16-4-2 "Specification for radio disturbance and immunity measuring apparatus and methods – Part 4-2: Uncertainties, statistics and limit modeling – Measurement instrumentation uncertainty" and the relevant basic standards for all listed Tests.

## 6 Test Conditions and Results

### 6.1 Conducted disturbance (150 kHz to 30 MHz)

Phenomena	Reference	Frequency Range	Criteria	Verdict <sup>1</sup>
Conducted Emission AC Power Ports	FCC 47 CFR Part 15 §15.107	150 kHz – 30 MHz	Class A	P
Conducted Emission AC Power Ports	ICES-003	150 kHz – 30 MHz	Class A	P

(The conducted emission limits of FCC 47 CFR Part 15 §15.107 Class A/B are identical with ICES-003 class A/B.)

#### Test procedure

Measured levels of power-line conducted emission are the radio-noise voltage levels across the 50 Ω LISN port (to which the EUT is connected) terminated into a 50 Ω EMI receiver. All radio-noise voltage measurements are made on each current carrying conductor at the plug end of the EUT power cord. The measurement is performed using a receiver with peak and average detector.

Only if the measured peak value is near or above the quasi-peak limit the detector function is changed to quasi-peak for final measurement of the highest voltage levels.

Exploratory emission measurements are to be performed considering operation states and cable arrangement to evaluate configuration with highest emission levels (C63.4-2014, Clause 7.3.3 and 7.3.4).

Acc. ANSI C63.4 chapter 10.2.8.3: AC power-line conducted emissions measurements are to be separately carried out only on each of the phase ("hot") line(s) and (if used) on the neutral line(s), but not on the ground [protective earth) line(s).

Table-top equipment is arranged 80 cm above ground plane.

EMC-Test-SW: EMC32 version 10.50.00 (R&S)

Sample Calculation with all conversion and correction factors used:

$$\sum CF = CF_{\text{Cables}} + CF_{\text{LISN}}$$

Test location: EMC-chamber No. 1

#### Instruments and accessories

ID	Measuring Instrument	Specification	Status	Calibration due
P0336	test chamber 1	17.7 x 10.8 x 6.8 m (net), 1 m hybrid absorbers	chk	Mar 2019
P0441	LISN (integrated pulse limiter P0488)	2 x 10 A; 50 Ohm	cal	Mar 2019
P2062	EMI receiver	9 kHz - 26,5 GHz	cal	Feb 2020

cal = Calibration, car = Calibration restricted use, chk = Check, chr = Check restricted use, cpu = Check prior to use, calchk = Calibration and check, ind = for indication only, cnn = Calibration not necessary, man = Maintenance



Photo documentation of the test set-up:



Figure 6-1: test setup Low voltage AC mains continuous disturbance

**Result:**

verdict:	<b>pass</b>
----------	-------------

For detailed results, please see below.

The test report shall not be reproduced except in full without the written approval of the testing laboratory

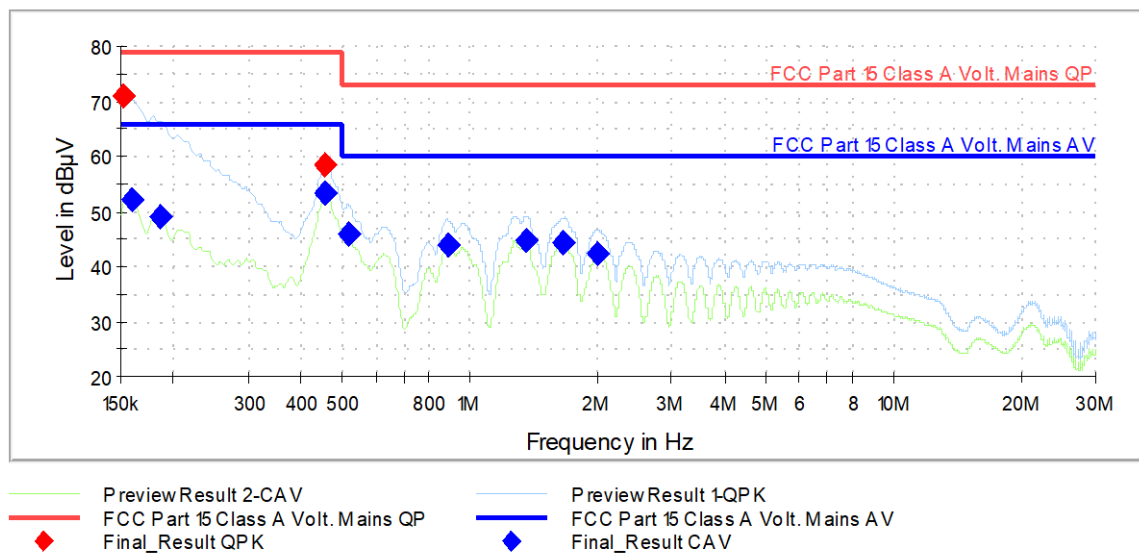
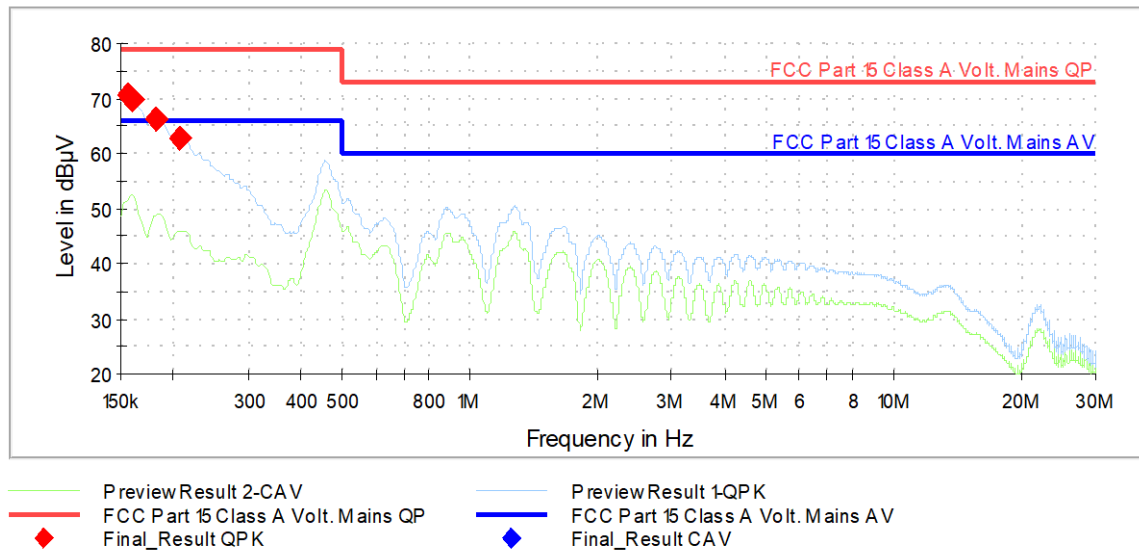

Figure 6-2: Graphical presentation Low voltage AC mains continuous disturbance, Neutral line

**Result table:**

Frequency (MHz)	QuasiPeak (dBµV)	CAverage (dBµV)	Limit (dBµV)	Margin (dB)	Meas. Time (ms)	Bandwidth (kHz)	Line	PE	Corr. (dB)
0.152250	71.03	---	79.00	7.97	1000.0	9.000	N	GND	20
0.159000	---	52.31	66.00	13.69	1000.0	9.000	N	GND	20
0.186000	---	48.96	66.00	17.04	1000.0	9.000	N	GND	20
0.453750	58.52	---	79.00	20.48	1000.0	9.000	N	GND	20
0.456000	---	53.49	66.00	12.51	1000.0	9.000	N	GND	20
0.514500	---	46.06	60.00	13.94	1000.0	9.000	N	GND	20
0.883500	---	43.94	60.00	16.06	1000.0	9.000	N	GND	20
1.356000	---	44.77	60.00	15.23	1000.0	9.000	N	GND	20
1.657500	---	44.37	60.00	15.63	1000.0	9.000	N	GND	20
2.010750	---	42.22	60.00	17.78	1000.0	9.000	N	GND	20



**Figure 6-3: Graphical presentation Low voltage AC mains continuous disturbance, Phase**

**Result table:**

Frequency (MHz)	QuasiPeak (dBµV)	CAverage (dBµV)	Limit (dBµV)	Margin (dB)	Meas. Time (ms)	Bandwidth (kHz)	Line	PE	Corr. (dB)
0.154500	70.50	---	79.00	8.50	1000.0	9.000	L1	GND	20
0.159000	69.64	---	79.00	9.36	1000.0	9.000	L1	GND	20
0.181500	66.42	---	79.00	12.58	1000.0	9.000	L1	GND	20
0.206250	62.85	---	79.00	16.15	1000.0	9.000	L1	GND	20

The test report shall not be reproduced except in full without the written approval of the testing laboratory

## 6.2 Radiated disturbances (30 MHz to 1000 MHz)

Phenomena	Reference	Frequency Range	Criteria	Verdict <sup>1</sup>
Radio Disturbance Electric Field	FCC 47 CFR Part 15 §15.109	30 MHz - 1 GHz distance 10 m	Class A	P
Radio Disturbance Electric Field	ICES-003	30 MHz - 1 GHz distance 10 m	Class A	P

**(The radiated emission limits < 1 GHz of FCC 47 CFR Part 15 §15.109 Class A/B are identical with ICES-003 class A/B.)**

### Test procedure:

Radiated measurements are performed in a semi-anechoic chamber meeting the normalized site attenuation of ANSI C63.4 and listed with the FCC. The applicable frequency spectrum is scanned with a calibrated RF measuring system using an appropriate broadband antenna and an EMI-receiver/spectrum analyzer and compared to the required limits. The measuring instrument performs the field strength calculations automatically. The measuring software provides resident AF and CF figures for individual antennas and cables. The receiver/analyzer is set to "peak" mode from 30 MHz to 1 GHz. On any emission of concern, the receiver is set to quasi-peak mode.

"Maximization" of each suspect frequency is accomplished by a combination of a 360° azimuth search using a turntable and varying the antenna to ground plane height from 1 m to 4 m. Also, both the vertical and horizontal polarization is scanned in the required frequency range per ANSI C63.4.

Maximization of emission results starts at 0° of the turn table with antenna in horizontal polarization is set to 1 m. While the turntable slowly moves to 360°, the spectrum analyzer is sweeping from 30 to 1000 MHz and maximum data is recorded. Antenna is set to 2 m and turntable slowly moves back to 0° while the spectrum analyzer is sweeping again. This is repeated until the antenna height of 4 m is reached.

The antenna polarization is set to vertical and the procedure described above is repeated.

For each frequency, the measuring software stores the maximum level as well as the corresponding settings of turntable and antenna. An azimuth resolution of about 3° is realized using this method.

At least the six highest frequencies are selected automatically by the software for performing the final measurements.

At each of these frequencies the turntable as well as the antenna is set to the corresponding settings. Then the antenna is slowly moved 50 cm down/up related to initial position while the receiver is measuring at this frequency. The highest emission level and the corresponding height are recorded. At this final position, the measurement is performed with quasi-peak detector. Exploratory emission measurements are to be performed considering operation states and cable arrangement to evaluate configuration with highest emission levels (C63.4, Clause 8.3.1 and 8.3.2).

Table-top equipment is arranged 80 cm above ground plane.

Test location: semi anechoic chamber No. 1

EMC-Test-SW: EMC32 version 10.50.00 (R&S)

Sample Calculation with all conversion and correction factors used:

$$\sum CF = CF_{\text{Cables}} + CF_{\text{Antenna}}$$

## Instruments and accessories

ID	Measuring Instrument	Specification	Status	Calibration due
P2062	EMI receiver	9 kHz - 26,5 GHz	cal	Feb 2020
P1140	Controller	4 ports, fiber optic, GPIB & LAN	cnn	
P0336	test chamber 1	17.7 x 10.8 x 6.8 m (net), 1 m hybrid absorbers	chk	Mar 2019
P1139	Mast	1 - 4m, hor./vert.	cnn	
P1352	antenna, Ultralog	30 MHz - 3000 MHz	cal	May 2019

cal = Calibration, car = Calibration restricted use, chk = Check, chr = Check restricted use, cpu = Check prior to use, calchk = Calibration and check, ind = for indication only, cnn = Calibration not necessary, man = Maintenance

## Photo documentation of the test set-up:



The test report shall not be reproduced except in full without the written approval of the testing laboratory



Figure 6-4: test setup for Radiated disturbances 30 MHz to 1000 MHz

**Result:**

verdict:	pass
----------	------

For detailed results, please see below.

The test report shall not be reproduced except in full without the written approval of the testing laboratory

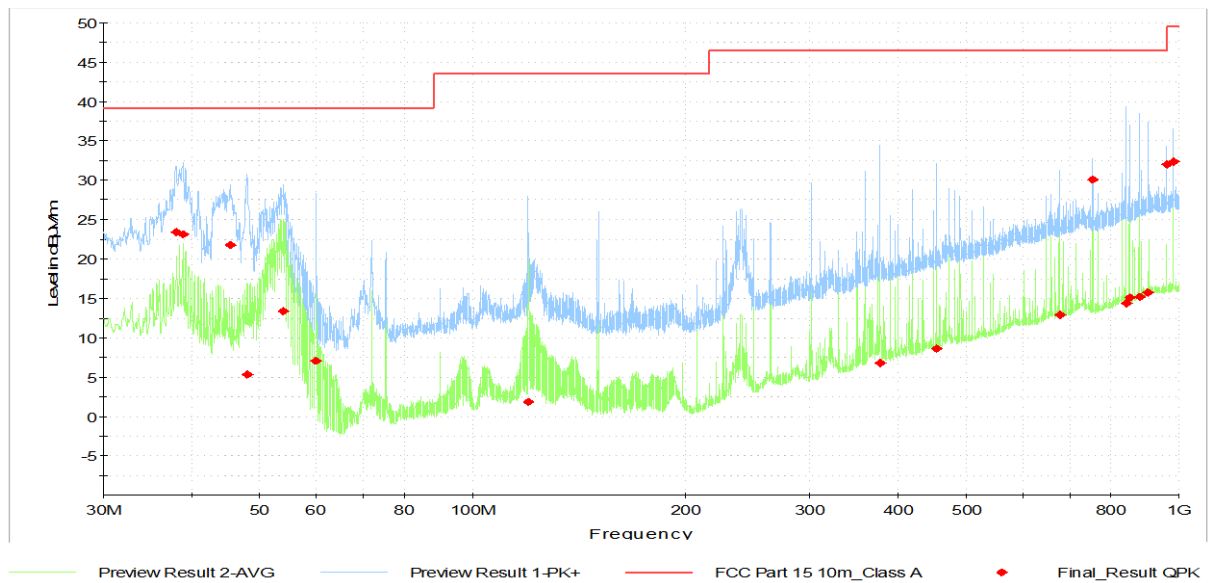

Figure 6-5: Graphical presentation Radiated disturbances 30 MHz to 1000 MHz

**Result table:**

Frequency (MHz)	QuasiPeak (dB $\mu$ V/m)	Limit (dB $\mu$ V/m)	Margin (dB)	Meas. Time (ms)	Height (cm)	Pol	Azimuth (deg)	Corr. (dB/m)
38.100000	23.46	39.10	15.64	1000.0	100.0	V	178.0	16
38.910000	23.18	39.10	15.92	1000.0	131.0	V	179.0	15
45.360000	21.82	39.10	17.28	1000.0	148.0	V	158.0	12
48.000000	5.33	39.10	33.77	1000.0	104.0	V	226.0	10
53.940000	13.41	39.10	25.69	1000.0	316.0	V	335.0	7
60.000000	7.07	39.10	32.03	1000.0	314.0	V	12.0	6
120.000000	1.85	43.50	41.65	1000.0	140.0	V	45.0	11
377.130000	6.77	46.40	39.63	1000.0	120.0	V	1.0	15
452.550000	8.66	46.40	37.74	1000.0	400.0	V	0.0	17
678.810000	12.92	46.40	33.48	1000.0	135.0	H	300.0	20
754.260000	30.07	46.40	16.33	1000.0	314.0	H	178.0	21
842.730000	14.37	46.40	32.03	1000.0	107.0	H	-2.0	22
851.280000	15.14	46.40	31.26	1000.0	101.0	H	2.0	22
881.010000	15.18	46.40	31.22	1000.0	385.0	H	145.0	23
901.740000	15.76	46.40	30.64	1000.0	218.0	H	319.0	23
959.940000	31.98	46.40	14.42	1000.0	353.0	H	184.0	24
980.520000	32.39	49.50	17.11	1000.0	115.0	H	92.0	24

The test report shall not be reproduced except in full without the written approval of the testing laboratory



### 6.3 Radiated disturbances (1 GHz to 6 GHz)

Phenomena	Reference	Frequency Range	Criteria	Verdict <sup>1</sup>
Radio Disturbance Electric Field	FCC 47 CFR Part 15 §15.109	1 GHz – 6 GHz Distance 3 m	Class A	P
Radio Disturbance Electric Field	ICES-003	1 GHz - 6 GHz Distance 3 m	Class A	P

**(The radiated emission limits > 1 GHz for AV-detector of FCC 47 CFR Part 15 §15.109 Class A/B are identical with ICES-003 class A/B. In addition, ICES-003 requires also a peak-limit with 20 dB above relevant AV-limit.)**

#### Test Execution

Radiated measurements are performed in a semi-anechoic chamber meeting the normalized site attenuation of ANSI C63.4 as well as the Site VSWR requirements of CISPR16 and listed with the FCC. The applicable frequency spectrum is scanned with a calibrated RF measuring system using an appropriate broadband antenna and an EMI-receiver/spectrum analyzer and compared to the required limits. The measuring instrument performs the field strength calculations automatically. The measuring software provides resident AF and CF figures for individual antennas and cables. The receiver/analyzer is set to "peak" mode in the relevant frequency range. On any emission of concern, the receiver is set to average mode.

For EUTs having a size larger than the beamwidth of the antenna, appropriate countermeasures shall be taken, e.g. increasing the measuring distance or different antenna positions (lateral) to scan the complete surface of EUT.

“Maximization” of each suspect frequency is accomplished by a combination of a 360° azimuth search using a turntable and varying the antenna to ground plane height from 1 m to 4 m. Both, the vertical and horizontal polarization is scanned in the required frequency range per ANSI C63.4.

Maximization of emission results starts at 0° of the turn table with antenna in horizontal polarization is set to 1 m. While the turntable slowly moves to 360°, the spectrum analyzer is sweeping from 1 to 6 GHz and maximum data is recorded. Antenna is set to 1.5 m and turntable slowly moves back to 0° while the spectrum analyzer is sweeping again. This is repeated until the antenna height of 4 m is reached (step: 0.5m).

The antenna polarization is set to vertical and the procedure described above is repeated.

For each frequency, the measuring software stores the maximum level as well as the corresponding settings of turntable and antenna. An azimuth resolution of about 3° is realized using this method.

At least the six highest frequencies are selected automatically by the software for performing the final measurements. At each of these frequencies the turntable as well as the antenna is set to the corresponding settings. Then the antenna is slowly moved 25 cm down/up related to initial position while the receiver is measuring at this frequency. The highest emission level and the corresponding height are recorded. At this final position, the measurement is performed with average detector.

Exploratory emission measurements are to be performed considering operation states and cable arrangement to evaluate configuration with highest emission levels (C63.4, Clause 8.3.1 and 8.3.2).

Final measurements were performed acc C63.4, clause 8.3.2.2 aimed at the emission source for receiving the maximum signal.

Table-top equipment is arranged 80 cm above ground plane.

Test location: semi anechoic chamber No. 1

EMC-Test-SW: EMC32 version 10.50.00 (R&S)

Sample Calculation with all conversion and correction factors used:

$$\sum CF = CF_{\text{Cables}} + CF_{\text{Antenna}} + CF_{\text{Preamplifier}}$$

Instruments and accessories

ID	Measuring Instrument	Specification	Status	Calibration due
P2062	EMI receiver	9 kHz - 26,5 GHz	cal	Feb 2020
P1140	Controller	4 ports, fiber optic, GPIB & LAN	cnn	
P0336	test chamber 1	17.7 x 10.8 x 6.8 m (net), 1 m hybrid absorbers	chk	Mar 2019
P1589	preamplifier (MZ1)	0.1 - 20GHz, gain ca. 28dB	cal	Apr 2020
P1354	antenna (MZ1)	0.85 GHz - 26.5 GHz	cal	Aug 2020
P1314	Mast (MZ1, GHz)	1 - 4m, hor./vert., Tilt	cnn	

cal = Calibration, car = Calibration restricted use, chk = Check, chr = Check restricted use, cpu = Check prior to use, calchk = Calibration and check, ind = for indication only, cnn = Calibration not necessary, man = Maintenance

Photo documentation of the test set-up:

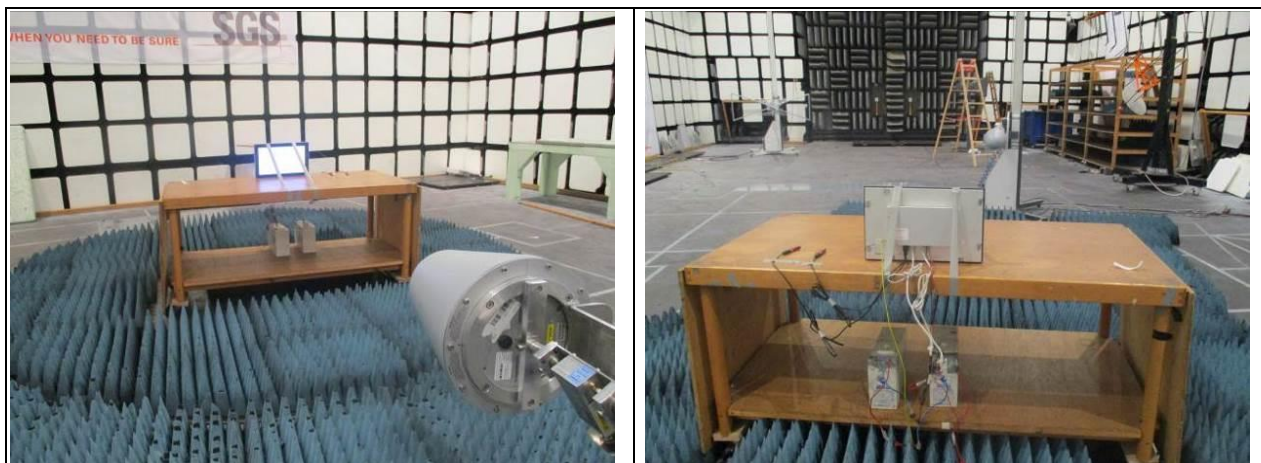

**Figure 6-6: test setup for radiated disturbances 1 GHz to 6 GHz**

Result:

verdict:	<b>pass</b>
----------	-------------

For detailed results, please see below.

The test report shall not be reproduced except in full without the written approval of the testing laboratory



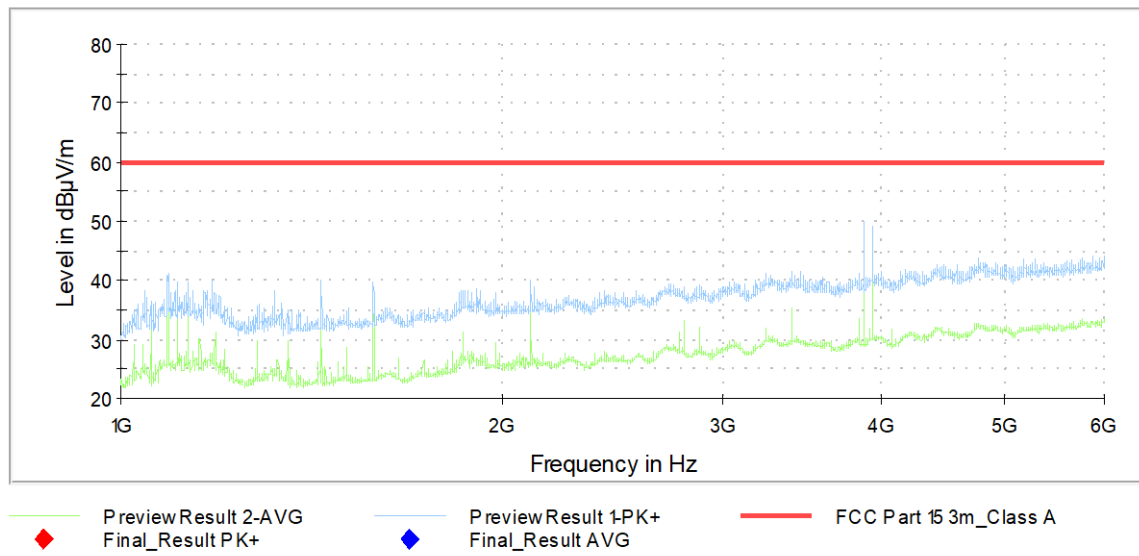

Figure 6-7: Graphical presentation Radiated disturbances 1 GHz to 6 GHz

**Result table:**

*N/A because of margin to the limit > 10 dB*

The test report shall not be reproduced except in full without the written approval of the testing laboratory

## 7 Disclaimer

This document is issued by the Company subject to its General Conditions of Service ([www.sgsgroup.de/agb](http://www.sgsgroup.de/agb)). Attention is drawn to the limitations of liability, indemnification and jurisdictional issues established therein.

This document is an original. If the document is submitted digitally, it is to be treated as an original within the meaning of UCP 600.

Any holder of this document is advised that information contained hereon reflects the Company's findings at the time of its intervention only and within the limits of client's instructions, if any. The Company's sole responsibility is to its Client and this document does not exonerate parties to a transaction from exercising all their rights and obligations under the transaction documents. Any unauthorized alteration, forgery or falsification of the content or appearance of this document is unlawful and offenders may be prosecuted to the fullest extent of the law.

The test report shall not be reproduced except in full without the written approval of the testing laboratory