

FCC TEST REPORT

Client Information:

Applicant: TANKYA DEVELOPING CO., LIMITED
Applicant add.: 6F, B Building of Tengyao Technology Park, 2nd Gushu Road, Xixiang, Baoan, Shenzhen China
Manufacturer: SHENZHEN SHOUERNUO TECHNOLOGY CO.,LTD
Manufacturer add.: Room 901, Building 5, 10th Industrial Zone, Tianliao Community, Yutang Street, Guangming District, Shenzhen, 518127,Guangdong, China

Product Information:

Product Name: Qi2 3 in 1 Foldable wireless charge stand
Model No.: TKWC-054
Brand Name: N/A
FCC ID: 2AV8L-TKWC-054

Applicable standards: FCC CFR Title 47 Part 15 Subpart C

Prepared By:

Guangdong Asia Hongke Test Technology Limited

B1/F, Building 11, Junfeng Industrial Park, Chongqing Road, Heping Community, Fuhai Street, Bao'an District, Shenzhen, Guangdong, China

Tel.: +86 0755-230967639 Fax.: +86 0755-230967639

Date of Receipt: Jun 29, 2024 Date of Test: Jun 29, 2024 ~ July 30, 2024

Date of Issue: July 30, 2024 Test Result: Pass

This device described above has been tested by Guangdong Asia Hongke Test Technology Limited and the test results show that the equipment under test (EUT) is in compliance with the FCC requirements. And it is applicable only to the tested sample identified in the report.

Note: This report shall not be reproduced except in full, without the written approval of Guangdong Asia Hongke Test Technology Limited, this document may be altered or revised by Guangdong Asia Hongke Test Technology Limited, personal only, and shall be noted in the revision of the document. This test report must not be used by the client to claim product endorsement.

Reviewed by:

Leon Yi

Leon.yi

Approved by:

Sean She

Sean She



1 Contents

| | Page |
|--|-----------|
| COVER PAGE | |
| 1 CONTENTS | 2 |
| 2 TEST SUMMARY | 5 |
| 2.1 STATEMENT OF THE MEASUREMENT UNCERTAINTY | 5 |
| 2.2 MEASUREMENT UNCERTAINTY | 5 |
| 3 TEST FACILITY..... | 6 |
| 3.1 DEVIATION FROM STANDARD..... | 6 |
| 3.2 ABNORMALITIES FROM STANDARD CONDITIONS..... | 6 |
| 3.3 TEST LOCATION | 6 |
| 4 GENERAL INFORMATION | 7 |
| 4.1 EUT TEST MODE | 8 |
| 4.2 DESCRIPTION OF TEST SETUP..... | 8 |
| 4.3 PERIPHERAL LIST..... | 9 |
| 4.4 EUT PERIPHERAL LIST..... | 9 |
| 5 EQUIPMENTS LIST FOR ALL TEST ITEMS | 10 |
| 6 CONDUCTED EMISSION TEST | 11 |
| 6.1 CONDUCTED EMISSION MEASUREMENT | 11 |
| 6.2 POWER LINE CONDUCTED EMISSION LIMITS | 11 |
| 6.3 TEST PROCEDURE..... | 11 |
| 6.4 DEVIATION FROM TEST STANDARD | 11 |
| 6.5 TEST SETUP..... | 12 |
| 6.6 EUT OPERATING CONDITIONS | 12 |
| 6.7 TEST RESULT | 13 |
| 7 RADIATED EMISSION MEASUREMENT | 15 |
| 7.1 RADIATED EMISSION LIMITS..... | 15 |
| 7.2 ANECHOIC CHAMBER TEST SETUP DIAGRAM..... | 16 |
| 7.3 TEST PROCEDURE | 16 |
| 7.4 DEVIATION FROM TEST STANDARD | 17 |
| 7.5 TEST RESULT | 17 |
| 8 BANDWIDTH TEST..... | 21 |
| 8.1 TEST PROCEDURE | 21 |
| 8.2 TEST SETUP..... | 21 |
| 9 ANTENNA REQUIREMENT:..... | 24 |
| 10 TEST SETUP PHOTOGRAPHS OF EUT | 25 |



| | | |
|----|-----------------------------------|----|
| 11 | EXTERNAL PHOTOGRAPHS OF EUT | 25 |
| 12 | INTERNAL PHOTOGRAPHS OF EUT | 25 |

Revision History

| Revision | Issue Date | Revisions | Revised By |
|----------|---------------|---------------|------------|
| 00 | July 30, 2024 | Initial Issue | Sean She |
| | | | |
| | | | |

2 Test Summary

| Test Item | Section in CFR 47 | Result |
|----------------------------------|-------------------|--------|
| Antenna requirement | 15.203 | Pass |
| AC Power Line Conducted Emission | 15.207 | Pass |
| Spurious Emission | 15.209(a)(f) | Pass |
| 20dB Bandwidth | 15.215 | Pass |

Note

1. Test according to ANSI C63.10:2013.
2. The measurement uncertainty is not included in the test result.
3. Test results in other test report (RF Exposure Evaluation Report)

2.1 Statement of the Measurement Uncertainty

The data and results referenced in this document are true and accurate. The reader is cautioned that there may be errors within the calibration limits of the equipment and facilities. The measurement uncertainty was calculated for all measurements listed in this test report acc. To CISPR 16 – 4 “Specification for radio disturbance and immunity measuring apparatus and methods – Part 4: Uncertainty in EMC Measurements” and is documented in the AiT quality system acc. To DIN EN ISO/IEC 17025. Furthermore, component and process variability of devices similar to that tested may result in additional deviation. The manufacturer has the sole responsibility of continued compliance of the device.

2.2 Measurement Uncertainty

| Test Item | Frequency Range | Measurement Uncertainty | Notes |
|----------------------------------|-----------------|-------------------------|-------|
| Radiated Emission | 0.009MHz-30MHz | 3.10dB | (1) |
| Radiated Emission | 30MHz-1GHz | 3.75dB | (1) |
| Radiated Emission | 1GHz-18GHz | 3.88dB | (1) |
| Radiated Emission | 18GHz-40GHz | 3.88dB | (1) |
| AC Power Line Conducted Emission | 0.15MHz ~ 30MHz | 1.20dB | (1) |

Note (1): The measurement uncertainty is for coverage factor of k=2 and a level of confidence of 95%.

3 Test Facility

The test facility is recognized, certified or accredited by the following organizations:

FCC-Registration No.: 251906 Designation Number: CN1376

Guangdong Asia Hongke Test Technology Limited has been registered and fully described in a report filed with the (FCC) Federal Communications Commission. The acceptance letter from the FCC is maintained in our files.

IC —Registration No.: 31737 CAB identifier: CN0165

The 3m Semi-anechoic chamber of Guangdong Asia Hongke Test Technology Limited has been registered by Certification and Engineering Bureau of Industry Canada for radio equipment testing with Registration No.: 31737

A2LA-Lab Cert. No.: 7133.01

Guangdong Asia Hongke Test Technology Limited has been accredited by A2LA for technical competence in the field of electrical testing, and proved to be in compliance with ISO/IEC 17025: 2017 General Requirements for the Competence of Testing and Calibration Laboratories and any additional program requirements in the identified field of testing.

3.1 Deviation from standard

None

3.2 Abnormalities from standard conditions

None

3.3 Test Location

Guangdong Asia Hongke Test Technology Limited

Address: B1/F, Building 11, Junfeng Industrial Park, Chongqing Road, Heping Community, Fuhai Street, Bao'an District, Shenzhen, Guangdong, China

Tel.: +86 0755-230967639 Fax.: +86 0755-230967639

4 General Information

| | |
|------------------------|---|
| EUT Name: | Qi2 3 in 1 Foldable wireless charge stand |
| Model No: | TKWC-054 |
| Serial Model: | MagTrio Plus |
| Brand Name: | N/A |
| Test sample(s) ID: | AiTSZ-240629001-1 |
| Sample(s) Status: | Engineer sample |
| Operation frequency: | Coil1: For Phone: 113kHz-205kHz,360kHz Coil2: For Earphone: 113kHz-205kHz Coil3: Watch: 300kHz-350kHz |
| Modulation Technology: | ASK |
| Antenna Type: | Loop coil Antenna |
| Antenna gain: | 0dBi |
| Hardware version.: | N/A |
| Software version.: | N/A |
| Power Supply: | Input: DC 12V=3A 15V=2.33A Output 1 Max: 15W(MPP) Output 2 Max: 2.5W(Watch) Output 3 Max: 5W(AirPods) |
| Model different: | Different model names |
| Note: | For a more detailed features description, please refer to the manufacturer's specifications or the User's Manual. |

4.1 EUT Test Mode

Equipment under test was operated during the measurement under the following conditions:

| Test Mode | Description | |
|-----------|---|------------|
| Mode 1 | AC Adapter + EUT + Phone + Earphone + Watch | Record |
| Mode 2 | AC Adapter + EUT + Phone + Earphone | Pre-tested |
| Mode 3 | AC Adapter + EUT + Phone + Watch | Pre-tested |
| Mode 4 | AC Adapter + EUT + Phone | Pre-tested |
| Mode 5 | AC Adapter + EUT + Earphone + Watch | Pre-tested |
| Mode 6 | AC Adapter + EUT + Earphone | Pre-tested |
| Mode 7 | AC Adapter + EUT + Watch | Pre-tested |
| Mode 8 | Test the EUT in idle mode. | Pre-tested |

Note: 1. All test modes were pre-tested, but we only recorded the worst case in this report.

4.2 Description of Test setup

EUT was tested in normal configuration (Please See following Block diagram)

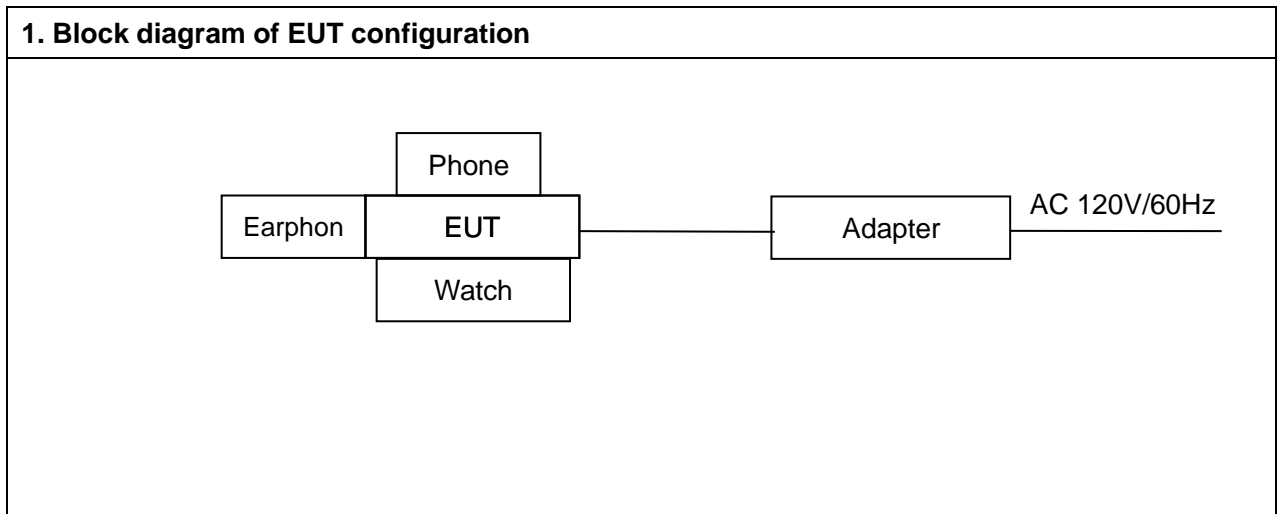

4.3 Peripheral List

| No. | Equipment | Manufacturer | Model No. | Serial No. | Power cord | signal cable |
|-----|-----------|--------------|-----------|------------|------------|--------------|
| 1 | Adapter | HNT | HNT-QC530 | N/A | N/A | N/A |
| 2 | Phone | YBZ | 15W | N/A | N/A | N/A |
| 3 | Earphone | PocBuds | K6 | N/A | N/A | N/A |
| 4 | Watch | Apple | S6 | Watch | N/A | N/A |

4.4 EUT Peripheral List

| No. | Equipment | Manufacturer | Model No. | Serial No. | Power cord | signal cable |
|-----|-----------|--------------|-----------|------------|------------|--------------|
| 1 | N/A | N/A | N/A | N/A | N/A | N/A |

5 Equipments List for All Test Items

| No | Test Equipment | Manufacturer | Model No | Serial No | Cal. Date | Cal. Due Date |
|----|-------------------------------------|--------------|-----------------|--------------|------------|---------------|
| 1 | Spectrum Analyzer | R&S | FSV40 | 101470 | 2023.09.08 | 2024.09.07 |
| 2 | Spectrum Analyzer | Keysight | N9020A | MY51280643 | 2023.09.08 | 2024.09.07 |
| 3 | EMI Measuring Receiver | R&S | ESR | 101660 | 2023.09.08 | 2024.09.07 |
| 4 | Low Noise Pre-Amplifier | HP | HP8447E | 1937A01855 | 2023.09.08 | 2024.09.07 |
| 5 | Low Noise Pre-Amplifier | Tsj | MLA-0120-A02-34 | 2648A04738 | 2023.09.08 | 2024.09.07 |
| 6 | Passive Loop | ETS | 6512 | 00165355 | 2022.09.04 | 2024.09.03 |
| 7 | TRILOG Super Broadband test Antenna | SCHWARZBECK | VULB9160 | 9160-3206 | 2021.08.29 | 2024.08.28 |
| 8 | Broadband Horn Antenna | SCHWARZBECK | BBHA9120D | 452 | 2021.08.29 | 2024.08.28 |
| 9 | SHF-EHF Horn Antenna 15-40GHz | SCHWARZBECK | BBHA9170 | BBHA9170367d | 2021.08.29 | 2024.08.28 |
| 10 | EMI Measuring Receiver | R&S | ESR | 101160 | 2023.09.13 | 2024.09.12 |
| 11 | LISN | SCHWARZBECK | NNLK 8129 | 8130179 | 2023.10.29 | 2024.10.28 |
| 12 | Pulse Limiter | R&S | ESH3-Z2 | 102789 | 2023.09.13 | 2024.09.12 |
| 13 | Pro.Temp&Humi.chamber | MENTEK | MHP-150-1C | MAA08112501 | 2023.09.08 | 2024.09.07 |
| 14 | RF Automatic Test system | MW | MW100-RFCB | 21033016 | 2023.09.08 | 2024.09.07 |
| 15 | Signal Generator | Agilent | N5182A | MY50143009 | 2023.09.08 | 2024.09.07 |
| 16 | Wideband Radio communication tester | R&S | CMW500 | 1201.0002K50 | 2023.09.08 | 2024.09.07 |
| 17 | RF Automatic Test system | MW | MW100-RFCB | 21033016 | 2023.09.08 | 2024.09.07 |
| 18 | DC power supply | ZHAOXIN | RXN-305D-2 | 28070002559 | N/A | N/A |
| 19 | RE Software | EZ | EZ-EMC_RE | Ver.AIT-03A | N/A | N/A |
| 20 | CE Software | EZ | EZ-EMC_CE | Ver.AIT-03A | N/A | N/A |
| 21 | RF Software | MW | MTS 8310 | 2.0.0.0 | N/A | N/A |
| 22 | temporary antenna connector(Note) | NTS | R001 | N/A | N/A | N/A |

Note: The temporary antenna connector is soldered on the PCB board in order to perform conducted tests and this temporary antenna connector is listed in the equipment list.

6 CONDUCTED EMISSION TEST

6.1 CONDUCTED EMISSION MEASUREMENT

| | |
|-----------------------|--------------------------------------|
| Test Requirement: | FCC Part15 C Section 15.207 |
| Test Method: | ANSI C63.10:2013 |
| Test Frequency Range: | 150KHz to 30MHz |
| Receiver setup: | RBW=9KHz, VBW=30KHz, Sweep time=auto |

6.2 POWER LINE CONDUCTED EMISSION Limits

| FREQUENCY (MHz) | Limit (dBuV) | | Standard |
|-----------------|--------------|-----------|----------|
| | Quas -peak | Average | |
| 0.15 -0.5 | 66 - 56 * | 56 - 46 * | FCC |
| 0.50 -5.0 | 56.00 | 46.00 | FCC |
| 5.0 -30.0 | 60.00 | 50.00 | FCC |

Note:

(1) *Decreases with the logarithm of the frequency.

6.3 TEST PROCEDURE

- a. The EUT was placed 0.8 meters from the horizontal ground plane with EUT being connected to the power mains through a line impedance stabilization network (LISN). All other support equipments powered from additional LISN(s). The LISN provide 50 Ohm/ 50uH of coupling impedance for the measuring instrument.
- b. Interconnecting cables that hang closer than 40 cm to the ground plane shall be folded back and forth in the center forming a bundle 30 to 40 cm long.
- c. I/O cables that are not connected to a peripheral shall be bundled in the center. The end of the cable may be terminated, if required, using the correct terminating impedance. The overall length shall not exceed 1 m.
- d. LISN at least 80 cm from nearest part of EUT chassis.
- e. For the actual test configuration, please refer to the related Item –EUT Test Photos.

6.4 DEVIATION FROM TEST STANDARD

No deviation

6.5 TEST SETUP

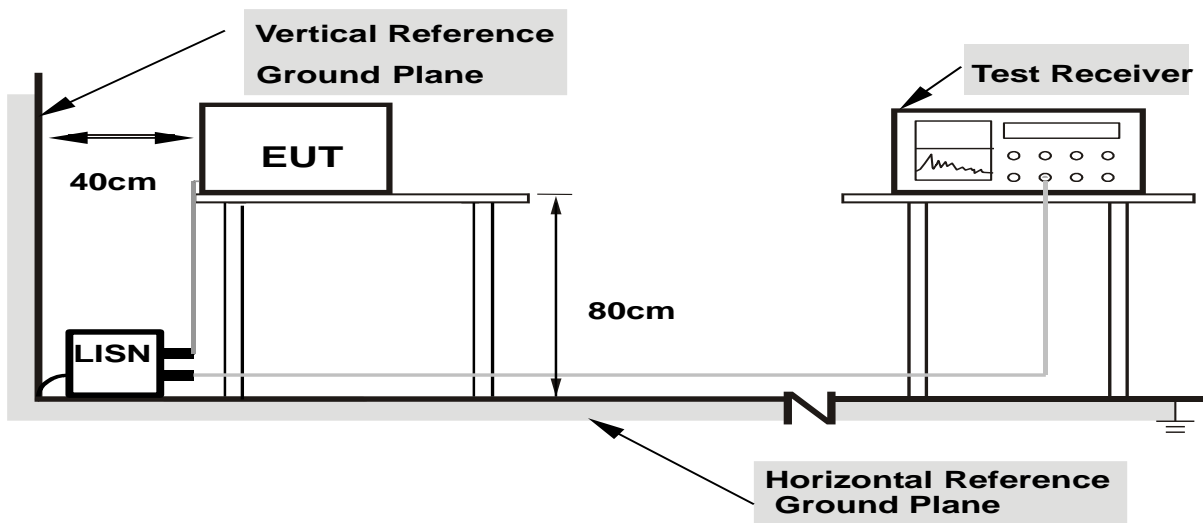

- Note:**
1. Support units were connected to second LISN.
 2. Both of LISNs (AMN) are 80 cm from EUT and at least 80 from other units and other metal planes

6.6 EUT OPERATING CONDITIONS

The EUT was configured for testing in a typical fashion (as a customer would normally use it). The EUT has been programmed to continuously transmit during test. This operating condition was tested and used to collect the included data.

We pretest AC 120V and AC 230V, the worst voltage was AC 120V and the data recording in the report.

6.7 Test Result

| | | | |
|----------------|--------------|--------------------|-----|
| Temperature: | 26°C | Relative Humidity: | 54% |
| Pressure: | 101kPa | Phase : | L |
| Test Voltage : | AC 120V/60Hz | | |

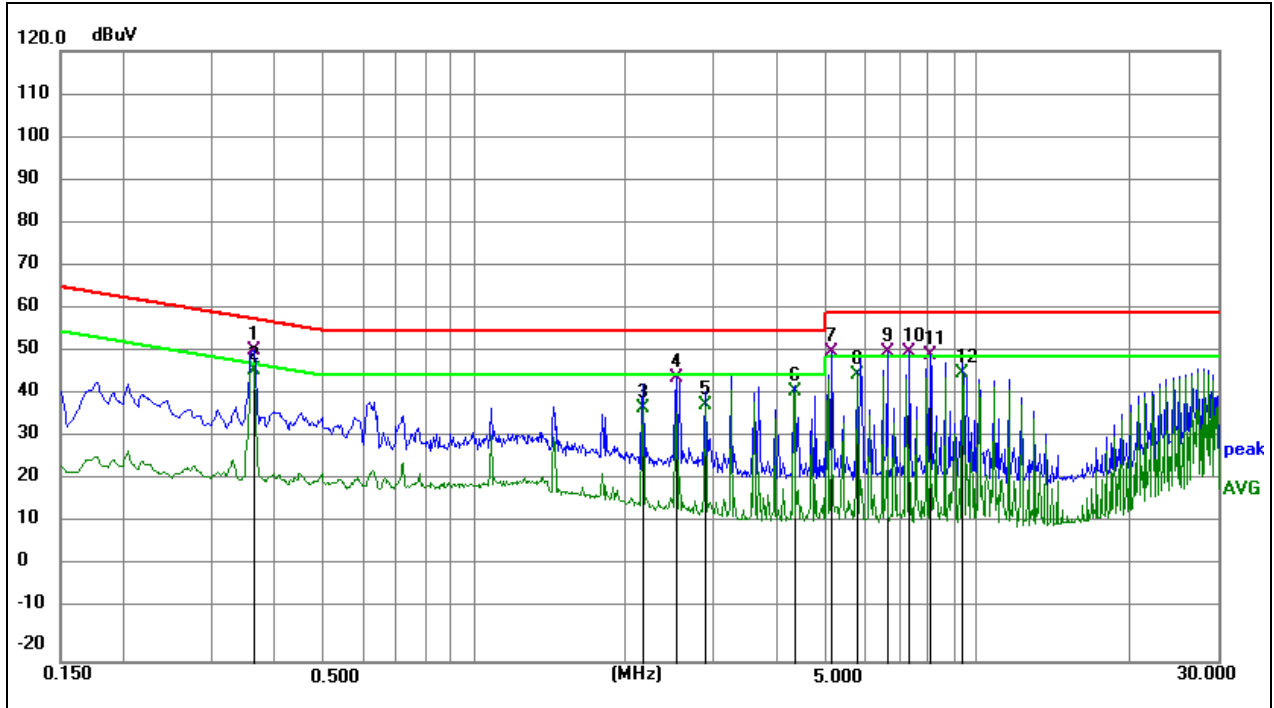

| No. | Frequency (MHz) | Reading (dBuV) | Correct (dB) | Result (dBuV) | Limit (dBuV) | Margin (dB) | Remark |
|-----|-----------------|----------------|--------------|---------------|--------------|-------------|--------|
| 1 | 0.3615 | 40.57 | 10.69 | 51.26 | 58.69 | -7.43 | QP |
| 2 | 0.3615 | 36.22 | 10.69 | 46.91 | 48.69 | -1.78 | AVG |
| 3 | 2.1570 | 27.51 | 10.79 | 38.30 | 46.00 | -7.70 | AVG |
| 4 | 2.5170 | 34.18 | 10.79 | 44.97 | 56.00 | -11.03 | QP |
| 5 | 2.8770 | 27.91 | 10.80 | 38.71 | 46.00 | -7.29 | AVG |
| 6 | 4.3170 | 30.91 | 11.01 | 41.92 | 46.00 | -4.08 | AVG |
| 7 | 5.1315 | 39.89 | 11.02 | 50.91 | 60.00 | -9.09 | QP |
| 8 | 5.7525 | 34.76 | 11.03 | 45.79 | 50.00 | -4.21 | AVG |
| 9 | 6.5940 | 40.00 | 11.03 | 51.03 | 60.00 | -8.97 | QP |
| 10 | 7.3275 | 39.92 | 11.05 | 50.97 | 60.00 | -9.03 | QP |
| 11 | 8.0610 | 39.39 | 11.06 | 50.45 | 60.00 | -9.55 | QP |
| 12 | 9.3480 | 35.29 | 11.00 | 46.29 | 50.00 | -3.71 | AVG |

| | | | |
|----------------|--------------|--------------------|-----|
| Temperature: | 26°C | Relative Humidity: | 54% |
| Pressure: | 101kPa | Phase : | N |
| Test Voltage : | AC 120V/60Hz | | |

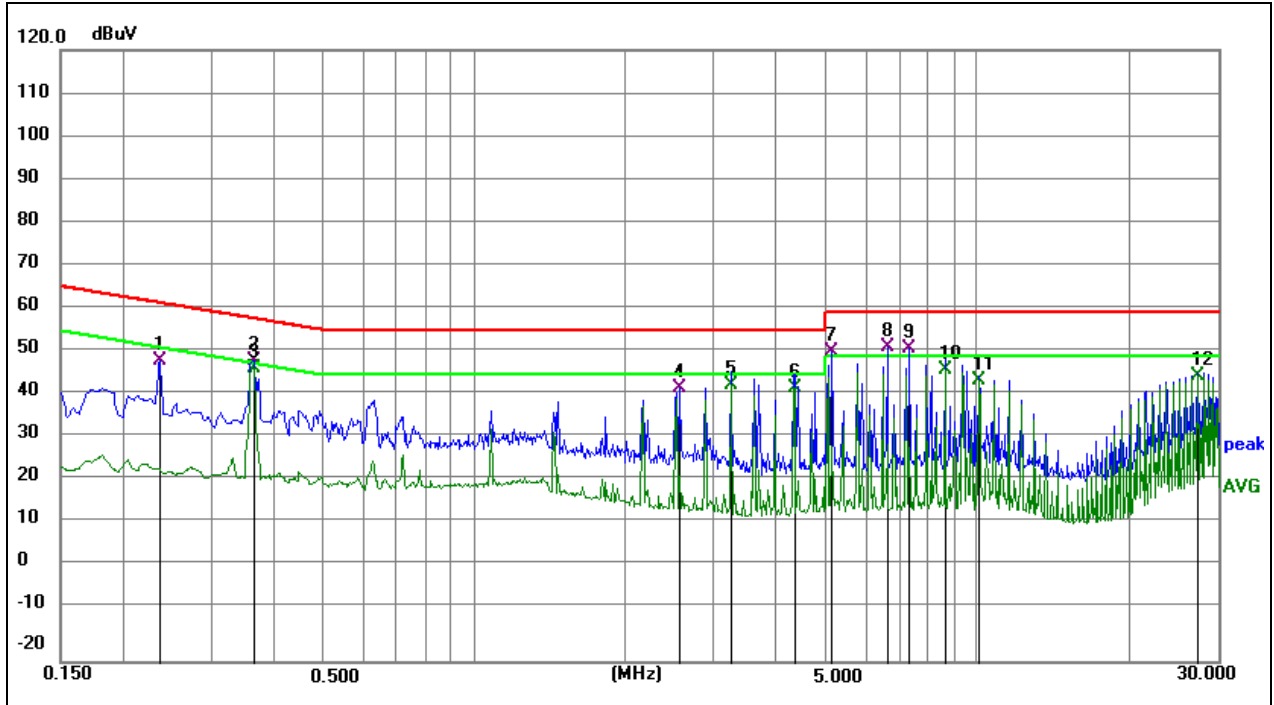

| No. | Frequency (MHz) | Reading (dBuV) | Correct (dB) | Result (dBuV) | Limit (dBuV) | Margin (dB) | Remark |
|-----|-----------------|----------------|--------------|---------------|--------------|-------------|--------|
| 1 | 0.2354 | 38.10 | 10.69 | 48.79 | 62.26 | -13.47 | QP |
| 2 | 0.3615 | 38.41 | 10.68 | 49.09 | 58.69 | -9.60 | QP |
| 3 | 0.3615 | 36.62 | 10.68 | 47.30 | 48.69 | -1.39 | AVG |
| 4 | 2.5620 | 31.89 | 10.79 | 42.68 | 56.00 | -13.32 | QP |
| 5 | 3.2370 | 32.52 | 10.82 | 43.34 | 46.00 | -2.66 | AVG |
| 6 | 4.3170 | 31.83 | 11.00 | 42.83 | 46.00 | -3.17 | AVG |
| 7 | 5.1314 | 40.08 | 11.01 | 51.09 | 60.00 | -8.91 | QP |
| 8 | 6.5940 | 40.91 | 11.01 | 51.92 | 60.00 | -8.08 | QP |
| 9 | 7.3274 | 40.76 | 11.04 | 51.80 | 60.00 | -8.20 | QP |
| 10 | 8.6280 | 35.69 | 11.05 | 46.74 | 50.00 | -3.26 | AVG |
| 11 | 10.0680 | 33.53 | 11.00 | 44.53 | 50.00 | -5.47 | AVG |
| 12 | 27.3255 | 33.93 | 11.61 | 45.54 | 50.00 | -4.46 | AVG |

Remark: Correct Factor = Insertion loss of LISN + Cable loss + Insertion loss of Pulse Limiter;
 Measurement Result = Reading Level + Correct Factor;
 Margin = Measurement Result - Limit;

7 RADIATED EMISSION MEASUREMENT

| | | | | | |
|-----------------------|-----------------------------|------------|--------|---------|------------|
| Test Requirement: | FCC Part15 C Section 15.209 | | | | |
| Test Method: | ANSI C63.10:2013 | | | | |
| Test Frequency Range: | 9kHz to 1GHz | | | | |
| Test site: | Measurement Distance: 3m | | | | |
| Receiver setup: | Frequency | Detector | RBW | VBW | Value |
| | 9KHz-150KHz | Quasi-peak | 200Hz | 600Hz | Quasi-peak |
| | 150KHz-30MHz | Quasi-peak | 9KHz | 30KHz | Quasi-peak |
| | 30MHz-1GHz | Quasi-peak | 100KHz | 300KHz | Quasi-peak |
| | Above 1GHz | Peak | 1MHz | 3MHz | Peak |
| Peak | | 1MHz | 10Hz | Average | |

7.1 Radiated Emission Limits

Limits for frequency below 30MHz

| Frequency | Limit (uV/m) | Measurement Distance(m) | Remark |
|-------------|--------------|-------------------------|------------------|
| 0.009-0.490 | 2400/F(kHz) | 300 | Quasi-peak Value |
| 0.490-1.705 | 24000/F(kHz) | 30 | Quasi-peak Value |
| 1.705-30 | 30 | 30 | Quasi-peak Value |

Limits for frequency Above 30MHz

| Frequency | Limit (dBuV/m @3m) | Remark |
|---------------|--------------------|------------------|
| 30MHz-88MHz | 40.00 | Quasi-peak Value |
| 88MHz-216MHz | 43.50 | Quasi-peak Value |
| 216MHz-960MHz | 46.00 | Quasi-peak Value |
| 960MHz-1GHz | 54.00 | Quasi-peak Value |
| Above 1GHz | 54.00 | Average Value |
| | 74.00 | Peak Value |

7.2 Anechoic Chamber Test Setup Diagram

(A) Radiated Emission Test-Up Frequency Below 30MHz

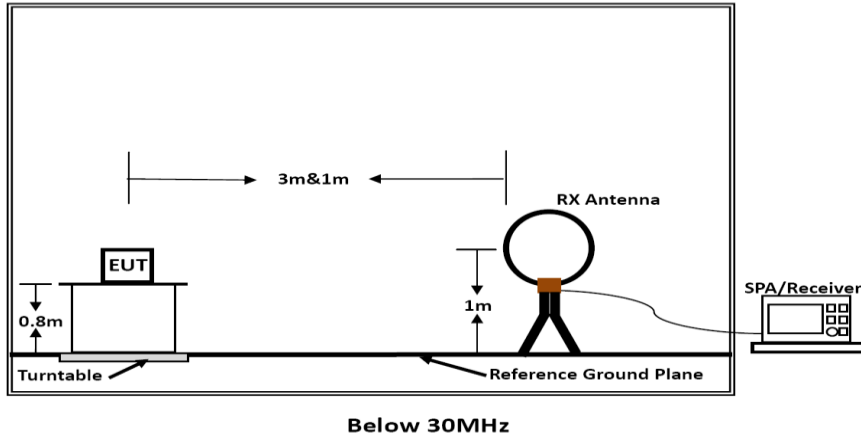

(B) Radiated Emission Test-Up Frequency 30MHz~1GHz

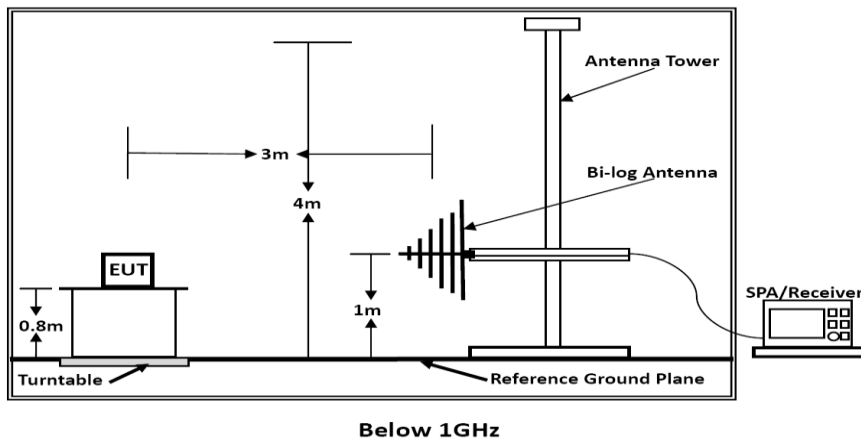

The radiated emission tests were performed in the 3 meters chamber test site, using the setup accordance with the ANSI C63.10-2013. The specification used was the FCC 15.209 and FCC 15.205 limits.

7.3 Test Procedure

The EUT is placed on a turn table which is 0.8 meter above ground. The turn table can rotate 360 degrees to determine the position of the maximum emission level. The EUT is set 3 meters away from the receiving antenna which is mounted on a antenna tower. The antenna can move up and down between 1 to 4 meters to find out the maximum emission level. Broadband antenna (calibrated by dipole antenna) are used as a receiving antenna. Both horizontal and vertical polarization of the antenna are set on measurement.

7.4 DEVIATION FROM TEST STANDARD

No deviation

7.5 Test Result

We pretest AC 120V and AC 230V in full load, half load and no load, the worst voltage was AC 120V in full load and the data recording in the report.

Mode1 :

9KHz-150KHz

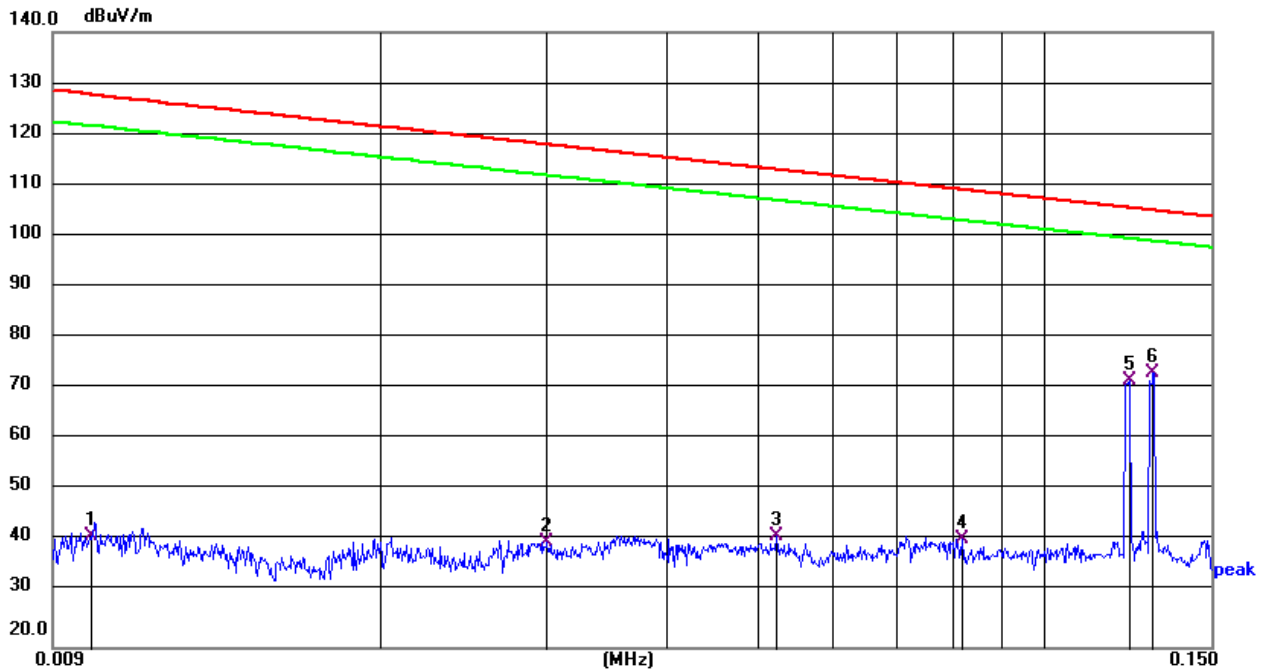

| No. | Frequency (MHz) | Reading (dBuV) | Factor (dB/m) | Level (dBuV/m) | Limit (dBuV/m) | Margin (dB) | Det. |
|-----|-----------------|----------------|---------------|----------------|----------------|-------------|------|
| 1 | 0.0100 | 20.28 | 21.43 | 41.71 | 127.60 | -85.89 | QP |
| 2 | 0.0300 | 19.37 | 21.40 | 40.77 | 118.06 | -77.29 | QP |
| 3 | 0.0522 | 19.30 | 22.61 | 41.91 | 113.25 | -71.34 | QP |
| 4 | 0.0820 | 18.52 | 22.67 | 41.19 | 109.33 | -68.14 | QP |
| 5 | 0.1231 | 49.92 | 22.17 | 72.09 | 105.80 | -33.71 | QP |
| 6 * | 0.1302 | 51.52 | 22.10 | 73.62 | 105.31 | -31.69 | QP |

150KHz-30MHz

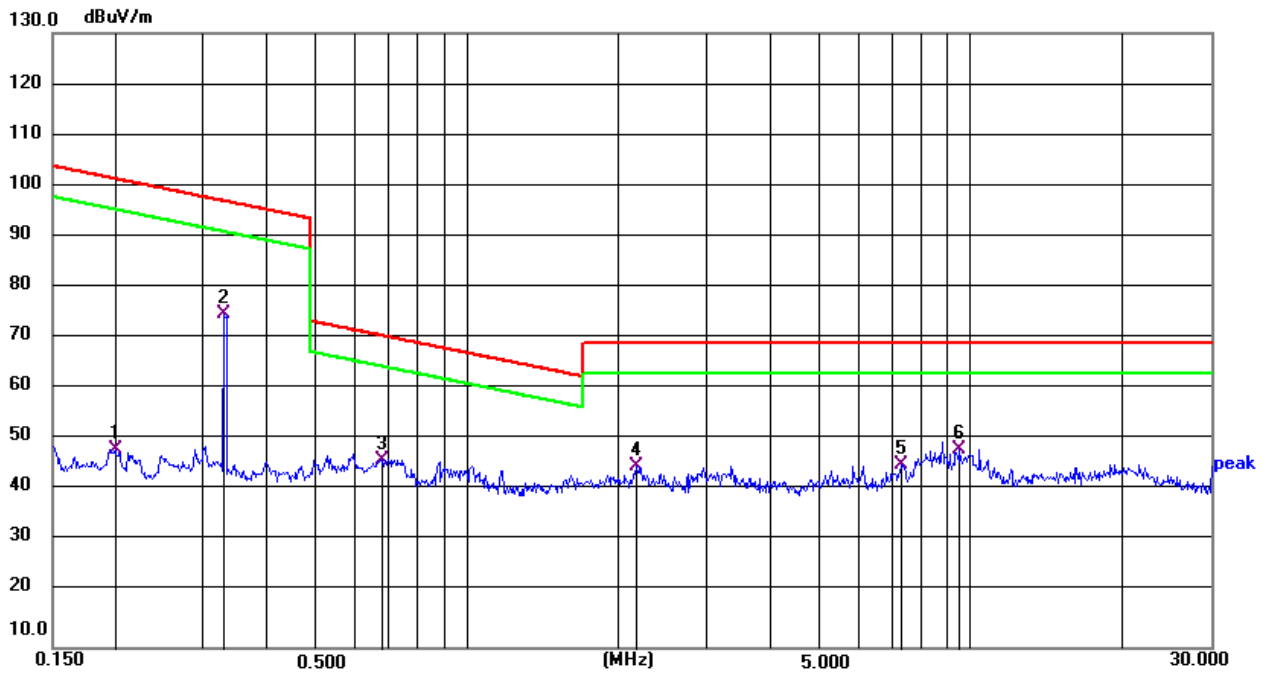

| No. | Frequency (MHz) | Reading (dBuV) | Factor (dB/m) | Level (dBuV/m) | Limit (dBuV/m) | Margin (dB) | Det. |
|-----|-----------------|----------------|---------------|----------------|----------------|-------------|------|
| 1 | 0.1995 | 27.17 | 21.65 | 48.82 | 101.61 | -52.79 | QP |
| 2 | 0.3285 | 53.54 | 21.53 | 75.07 | 97.27 | -22.20 | QP |
| 3 | 0.6790 | 24.43 | 22.30 | 46.73 | 70.97 | -24.24 | QP |
| 4 | 2.1667 | 23.06 | 22.43 | 45.49 | 69.54 | -24.05 | QP |
| 5 | 7.2903 | 22.94 | 22.98 | 45.92 | 69.54 | -23.62 | QP |
| 6 * | 9.5014 | 26.17 | 22.67 | 48.84 | 69.54 | -20.70 | QP |

Note:

Pre-scan in the all of mode, the worst case in of was recorded.

30MHz-1GHz

| | | | |
|---------------|--------------|--------------------|------------|
| Temperature: | 26°C | Relative Humidity: | 54% |
| Pressure: | 101 kPa | Polarization: | Horizontal |
| Test Voltage: | AC 120V/60Hz | | |

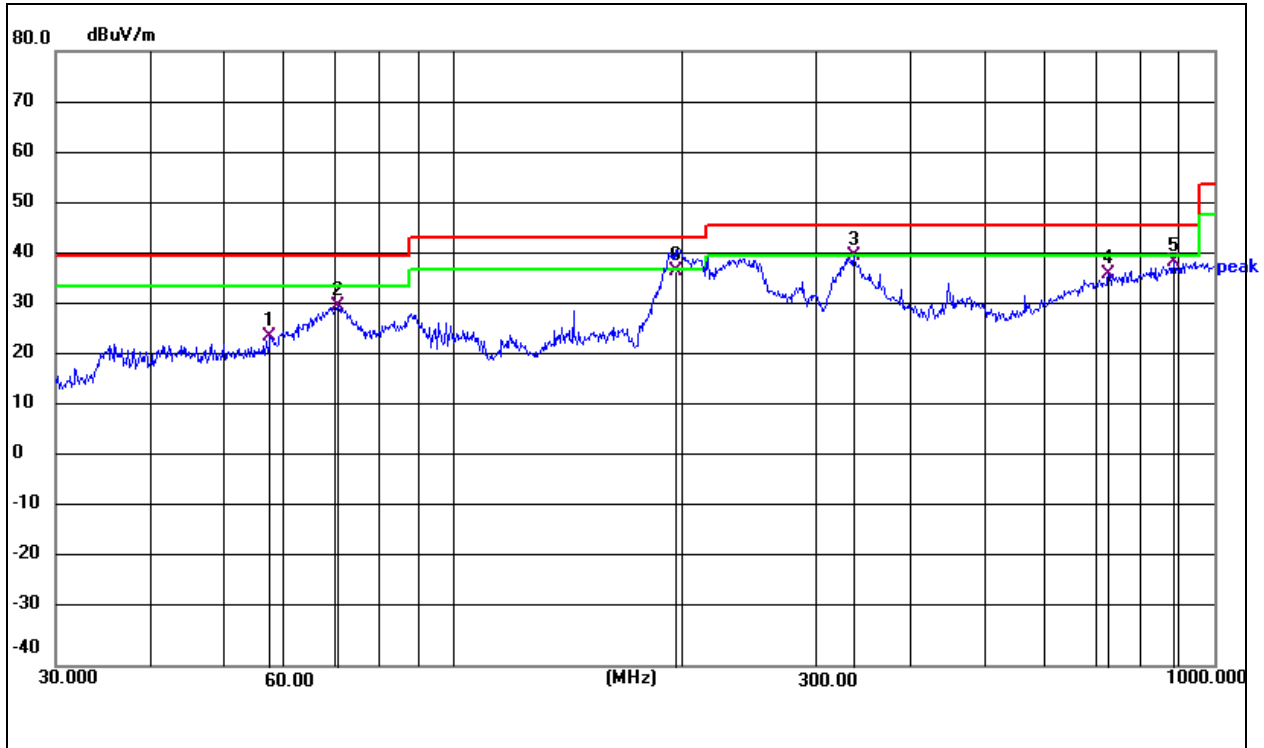

| No. | Frequency (MHz) | Reading (dBuV) | Factor (dB/m) | Level (dBuV/m) | Limit (dBuV/m) | Margin (dB) | Det. |
|-----|-----------------|----------------|---------------|----------------|----------------|-------------|------|
| 1 | 57.3923 | 37.44 | -13.04 | 24.40 | 40.00 | -15.60 | QP |
| 2 | 70.5836 | 44.15 | -13.89 | 30.26 | 40.00 | -9.74 | QP |
| 3 * | 336.0352 | 52.96 | -12.87 | 40.09 | 46.00 | -5.91 | QP |
| 4 | 726.8052 | 37.63 | -1.05 | 36.58 | 46.00 | -9.42 | QP |
| 5 | 884.5029 | 37.41 | 1.40 | 38.81 | 46.00 | -7.19 | QP |
| 6 | 195.8220 | 49.64 | -12.48 | 37.16 | 43.50 | -6.34 | QP |

| | | | |
|---------------|--------------|--------------------|----------|
| Temperature: | 26°C | Relative Humidity: | 54% |
| Pressure: | 101kPa | Polarization: | Vertical |
| Test Voltage: | AC 120V/60Hz | | |

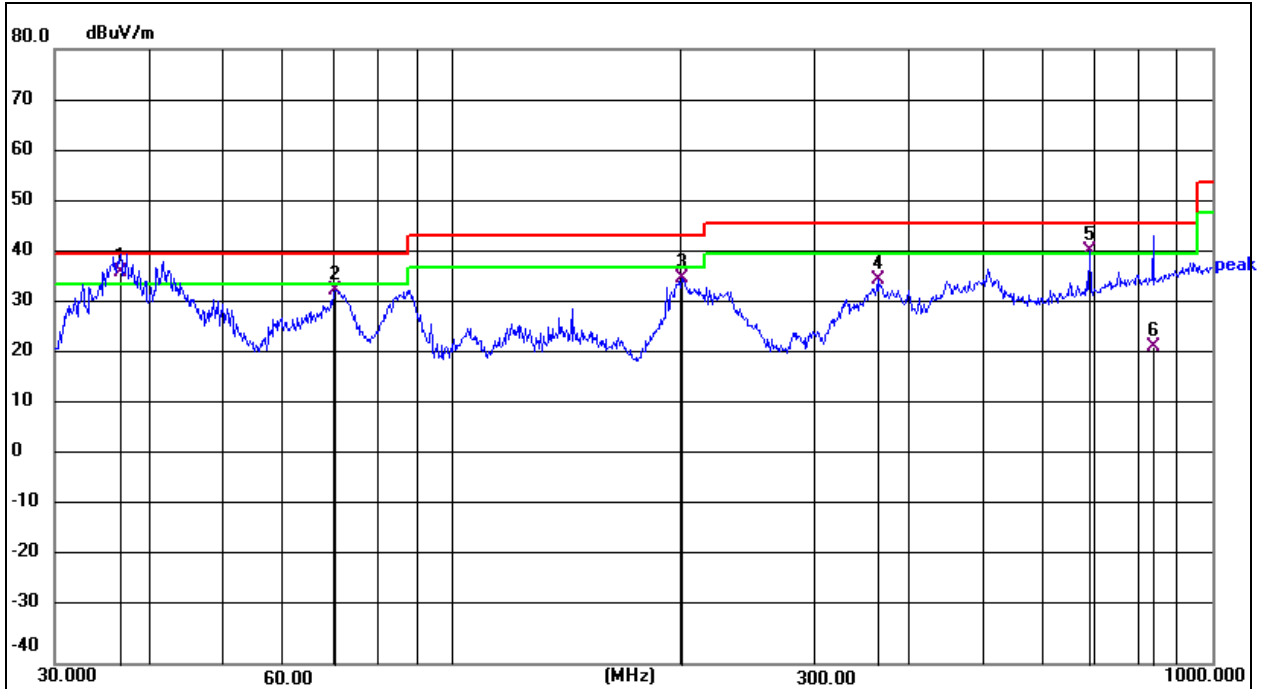

| No. | Frequency (MHz) | Reading (dBuV) | Factor (dB/m) | Level (dBuV/m) | Limit (dBuV/m) | Margin (dB) | Det. |
|-----|-----------------|----------------|---------------|----------------|----------------|-------------|------|
| 1 * | 36.6375 | 49.13 | -12.67 | 36.46 | 40.00 | -3.54 | QP |
| 2 | 70.3365 | 49.60 | -16.62 | 32.98 | 40.00 | -7.02 | QP |
| 3 | 200.6881 | 51.08 | -15.90 | 35.18 | 43.50 | -8.32 | QP |
| 4 | 362.9844 | 47.75 | -12.73 | 35.02 | 46.00 | -10.98 | QP |
| 5 | 689.5644 | 43.67 | -2.97 | 40.70 | 46.00 | -5.30 | QP |
| 6 | 836.2443 | 22.51 | -0.54 | 21.97 | 46.00 | -24.03 | QP |

Remarks:

1. Emission Level = Reading + Factor;
2. Factor = Antenna Factor + Cable Loss – Pre-amplifier;
3. Margin = Emission Level - Limit.
4. The emission levels of other frequencies are very lower than the limit and not show in test report.

8 BANDWIDTH TEST

8.1 Test Procedure

1. Set RBW = 30Hz.
2. Set the video bandwidth (VBW) $\geq 3 \times$ RBW.
3. Detector = Peak.
4. Trace mode = max hold.
5. Sweep = auto couple.
6. Allow the trace to stabilize.
7. Measure the maximum width of the emission that is constrained by the frequencies associated with the two outermost amplitude points (upper and lower frequencies) that are attenuated by 20 dB relative to the maximum level measured in the fundamental emission.

8.2 Test setup

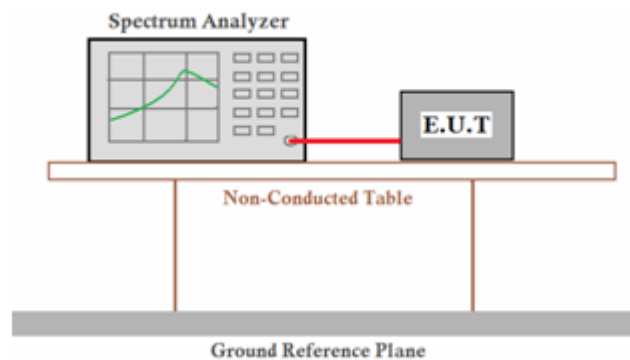

| | | | |
|--------------|--------|--------------------|-----|
| Temperature: | 20 °C | Relative Humidity: | 44% |
| Pressure: | 101kPa | | |

| Frequency (KHz) | 20dB bandwidth (KHz) | 99% bandwidth (KHz) | Result |
|-----------------|----------------------|---------------------|--------|
| 123.1 | 0.095 | - | Pass |
| 130.2 | 0.096 | - | Pass |
| 328.5 | 0.092 | - | Pass |

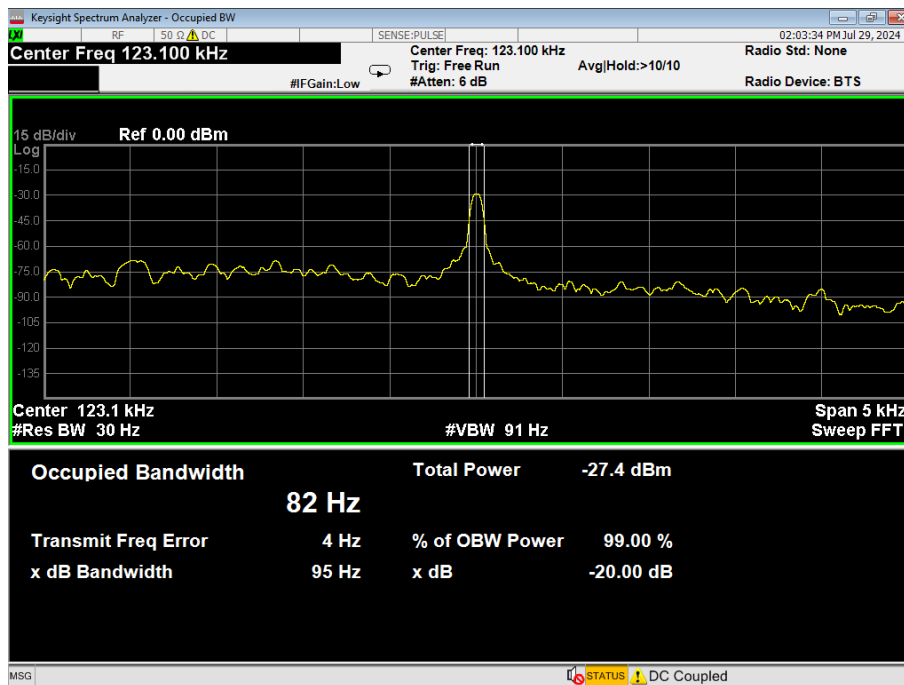

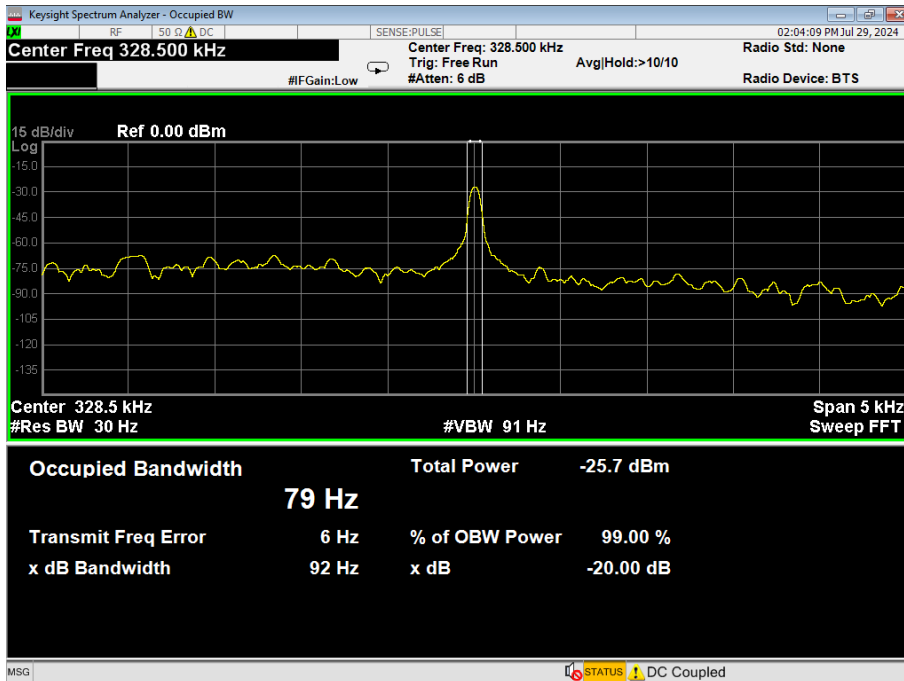
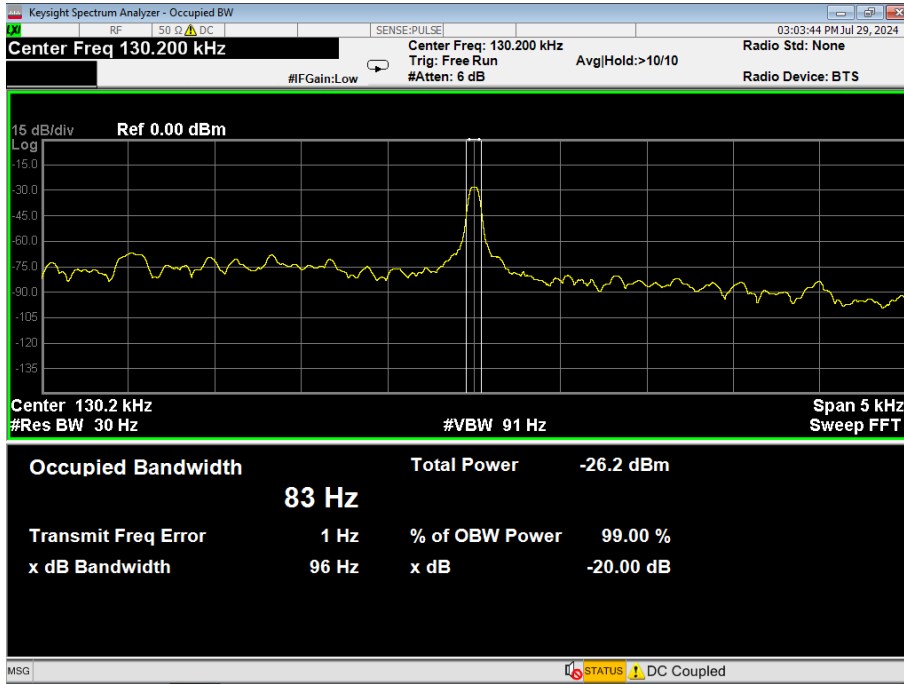

9 ANTENNA REQUIREMENT:

Standard requirement: FCC Part15 C Section 15.203

An intentional radiator shall be designed to ensure that no antenna other than that furnished by the responsible party shall be used with the device. The use of a permanently attached antenna or of an antenna that uses a unique coupling to the intentional radiator, the manufacturer may design the unit so that a broken antenna can be replaced by the user, but the use of a standard antenna jack or electrical connector is prohibited.

EUT Antenna:

The antenna is Inductive loop coil Antenna, the best case gain of the antenna is 0dBi, reference to the appendix for details.

10 Test Setup Photographs of EUT

Please refer to separated files for Test Setup Photos of the EUT.

11 External Photographs of EUT

Please refer to separated files for External Photos of the EUT.

12 Internal Photographs of EUT

Please refer to separated files for Internal Photos of the EUT.

**** End of report ****