



FCC TEST REPORT

FCC ID:2AV8I-R12

Report Number..... : **ZKT-230602066E-4**

Date of Test..... Jun. 02, 2023 to Jun. 10, 2023

Date of issue..... : Jun. 11, 2023

Total number of pages..... 37

Test Result : PASS

Testing Laboratory..... : **Shenzhen ZKT Technology Co., Ltd.**

Address : 1/F, No. 101, Building B, No. 6, Tangwei Community Industrial Avenue, Fuhai Street, Bao'an District, Shenzhen, China

Applicant's name : **Pacific Time Trading(Shenzhen)Limited**

Address : Unit 607,block A, Rong Chaoying Long building, 5 longfuRoad, Longcheng street, Longgang District, Shenzhen China

Manufacturer's name : **TFVC SHANGHAI CO.,LTD.**

Address : Rm 103,No.1 Lane 666 Xinhua Road,Changning District,Shanghai, China

Test specification:

Standard..... : FCC CFR Title 47 Part 15 Subpart E Section 15.407
ANSI C63.10:2013
KDB 789033 D02 v02r01

Test procedure..... : /

Non-standard test method : N/A

Test Report Form No..... : TRF-EL-113_V0**Test Report Form(s) Originator.....** : ZKT Testing**Master TRF** : Dated: 2020-01-06

This device described above has been tested by ZKT, and the test results show that the equipment under test (EUT) is in compliance with the FCC requirements. And it is applicable only to the tested sample identified in the report.

This report shall not be reproduced except in full, without the written approval of ZKT, this document may be altered or revised by ZKT, personal only, and shall be noted in the revision of the document.

Product name..... : **CARPLAY**Trademark : **Goral Vision**Model/Type reference..... : R12
D12, M12, S12Ratings..... : Input: 5V  2500mA



Testing procedure and testing location:

Testing Laboratory.....: Shenzhen ZKT Technology Co., Ltd.

Address.....: 1/F, No. 101, Building B, No. 6, Tangwei Community
Industrial Avenue, Fuhai Street, Bao'an District,
Shenzhen, China

Tested by (name + signature).....: Jim Liu

Reviewer (name + signature).....: Jackson Fang

Approved (name + signature).....: Lake Xie





Table of Contents

Page

1. VERSION	5
2.SUMMARY OF TEST RESULTS	6
2.1 TEST FACILITY	7
2.2 MEASUREMENT UNCERTAINTY	7
3. GENERAL INFORMATION	8
3.1 GENERAL DESCRIPTION OF EUT	8
3.3 BLOCK DIGRAM SHOWING THE CONFIGURATION OF SYSTEM TESTED	10
3.4 DESCRIPTION OF SUPPORT UNITS(CONDUCTED MODE)	10
3.5 EQUIPMENTS LIST FOR ALL TEST ITEMS	11
4.EMC EMISSION TEST	13
4.1 CONDUCTED EMISSION MEASUREMENT	13
4.1.1 POWER LINE CONDUCTED EMISSION Limits	13
4.1.2 TEST PROCEDURE	13
4.1.3 DEVIATION FROM TEST STANDARD	13
4.1.4 TEST SETUP	14
4.1.5 EUT OPERATING CONDITIONS	14
4.2 RADIATED EMISSION MEASUREMENT	15
4.2.1 APPLICABLE STANDARD	15
4.2.2 CONFORMANCE LIMIT	15
4.2.3 MEASURING INSTRUMENTS	15
4.2.4 TEST CONFIGURATION	16
4.2.5 TEST PROCEDURE	17
4.2.6 TEST RESULT	18
5.POWER SPECTRAL DENSITY TEST	22
5.1 APPLIED PROCEDURES / LIMIT	22
5.2 TEST PROCEDURE	23
5.3 DEVIATION FROM STANDARD	23
5.4 TEST SETUP	23
5.5 EUT OPERATION CONDITIONS	23
5.6 TEST RESULTS	24
6. 26DB EMISSION BANDWIDTH	25
6.1 APPLIED PROCEDURES / LIMIT	25
6.2 TEST PROCEDURE	25
6.3 EUT OPERATION CONDITIONS	25
6.4 TEST RESULTS	26
7.MAXIMUM CONDUCTED OUTPUT POWER	27



Table of Contents	Page
7.1 PPLIED PROCEDURES / LIMIT	27
7.2 TEST PROCEDURE	27
7.3 DEVIATION FROM STANDARD	28
7.4 TEST SETUP	28
7.5 EUT OPERATION CONDITIONS	28
7.6 TEST RESULTS	29
8.OUT OF BAND EMISSIONS	30
8.1 APPLICABLE STANDARD	30
8.2 TEST PROCEDURE	30
8.3 DEVIATION FROM STANDARD	30
8.4 TEST SETUP	30
8.5 EUT OPERATION CONDITIONS	31
8.6 TEST RESULTS	31
9.SPURIOUS RF CONDUCTED EMISSIONS	32
9.1 CONFORMANCE LIMIT	32
9.2 MEASURING INSTRUMENTS	32
9.3 TEST SETUP	32
9.4 TEST PROCEDURE	32
9.5 TEST RESULTS	32
10.FREQUENCY STABILITY MEASUREMENT	34
10.1 LIMIT	34
10.2 TEST PROCEDURES	34
10.3 TEST SETUP LAYOUT	34
10.4 EUT OPERATION DURING TEST	34
10.5 TEST RESULTS	34
11.ANTENNA REQUIREMENT	36
12. TEST SETUP PHOTO	37
13. EUT CONSTRUCTIONAL DETAILS	37



1. VERSION

Report No.	Version	Description	Approved
ZKT-230602066E-4	Rev.01	Initial issue of report	Jun. 11, 2023



2.SUMMARY OF TEST RESULTS

Test procedures according to the technical standards:

FCC Part15 (15.407) , Subpart E			
Standard Section	Test Item	Judgment	Remark
15.209(a), 15.407 (b)(1) 15.407 (b)(4) 15.407 (b)(8)	Spurious Radiated Emissions	PASS	
15.207	Conducted Emission	PASS	
15.407 (a)(12) 15.1049	26 dB Emission Bandwidth	PASS	
15.407(e)	-6 dB bandwidth	N/A	
15.407 (a)(1) 15.407 (a)(3)	Maximum Conducted Output Power	PASS	
2.1051, 15.407(b)(1) 15.407(b)(4)	Band Edge	PASS	
15.407 (a)(1) 15.407 (a)(3)	Power Spectral Density	PASS	
2.1051, 15.407(b)	Spurious Emissions at Antenna Terminals	PASS	
15.203	Antenna Requirement	PASS	

NOTE:

(1)" N/A" denotes test is not applicable in this Test Report



2.1 TEST FACILITY

Shenzhen ZKT Technology Co., Ltd.
Add. : 1/F, No. 101, Building B, No. 6, Tangwei Community Industrial Avenue, Fuhai Street, Bao'an District, Shenzhen, China

FCC Test Firm Registration Number: 692225
Designation Number: CN1299
IC Registered No.: 27033
CAB identifier: CN0110

2.2 MEASUREMENT UNCERTAINTY

The reported uncertainty of measurement $y \pm U$ where expanded uncertainty U is based on a standard uncertainty multiplied by a coverage factor of $k=2$ providing a level of confidence of approximately 95 %.

No.	Item	Uncertainty
1	3m chamber Radiated spurious emission(9KHz-30MHz)	U=4.5dB
2	3m chamber Radiated spurious emission(30MHz-1GHz)	U=4.8dB
3	3m chamber Radiated spurious emission(1GHz-6GHz)	U=4.9dB
4	3m chamber Radiated spurious emission(6GHz-40GHz)	U=5.0dB
5	Conducted disturbance	U=3.2dB
6	RF Band Edge	U=1.68dB
7	RF power conducted	U=1.86dB
8	RF conducted Spurious Emission	U=2.2dB
9	RF Occupied Bandwidth	U=1.8MHz
10	RF Power Spectral Density	U=1.75dB
11	humidity uncertainty	U=5.3%
12	Temperature uncertainty	U=0.59°C



3. GENERAL INFORMATION

3.1 GENERAL DESCRIPTION OF EUT

Product Name:	CARPLAY		
Model No.:	R12		
Model Different.:	Only the model name is different.		
Serial No.:	D12, M12, S12		
Sample ID	ZKT-230602066E-5		
Sample(s) Status:	Engineer sample		
Product Description	IEEE 802.11 WLAN Mode Supported	<input checked="" type="checkbox"/> 802.11a	
	Data Rate	<input checked="" type="checkbox"/> 802.11a	
	Modulation	OFDM with BPSK/QPSK/16QAM/64QAM/256QAM for 802.11a	
	Operating Frequency Range	<input checked="" type="checkbox"/> 5180-5240MHz for 802.11a	
	Number of Channels	<input checked="" type="checkbox"/> 4 channels for 802.11a in the 5180-5240MHz band ;	
Channel List	Please refer to the Note 2.		
Antenna Type:	FPCB Antenna		
Antenna gain:	2.49dBi		
Power supply:	Input: 5V 2500mA		
SWITCHING POWER ADAPTER:	N/A		

Note:

For a more detailed features description, please refer to the manufacturer's specifications or the User's Manual.

802.11a Frequency Channel							
Channel	Frequency (MHz)	Channel	Frequency (MHz)	Channel	Frequency (MHz)	Channel	Frequency (MHz)
36	5180	44	5220	-	-	-	-
40	5200	48	5240	-	-	-	-



3.2 DESCRIPTION OF TEST MODES

Transmitting mode	Keep the EUT in continuously transmitting mode
Remark: During the test, the duty cycle >98%, the test voltage was tuned from 85% to 115% of the nominal rated supply voltage, and found that the worst case was under the nominal rated supply condition. So the report just shows that condition's data.	

Test Software	REALTEK Test Tool
Power level setup	<15dBm

Pretest Mode	Description
Mode 1	802.11a CH36 / CH40 / CH 48

Conducted Emission	
Final Test Mode	Description
Mode 1	802.11a CH36 / CH40 / CH 48

For Radiated Emission	
Final Test Mode	Description
Mode 1	802.11a CH36 / CH40 / CH 48

Note:

(1) The measurements are performed at all Bit Rate of Transmitter, the worst data was reported.



3.3 BLOCK DIGRAM SHOWING THE CONFIGURATION OF SYSTEM TESTED

Radiated Emission

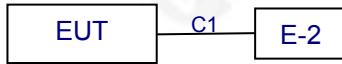

Conducted Spurious

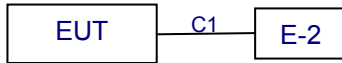

3.4 DESCRIPTION OF SUPPORT UNITS(CONDUCTED MODE)

The EUT has been tested as an independent unit together with other necessary accessories or support units. The following support units or accessories were used to form a representative test configuration during the tests.

Item	Equipment	Mfr/Brand	Model/Type No.	Series No.	Note
E-1	CARPLAY	Goral Vision	R12	See page 8	EUT
E-2	Storage Battery	Narada	ZKT-00	N/A	Auxiliary

Item	Shielded Type	Ferrite Core	Length	Note
C1	NO	NO	1.0 M	DC cable unshielded

Note:

- (1) The support equipment was authorized by Declaration of Confirmation.
- (2) For detachable type I/O cable should be specified the length in cm in 『Length』 column.



3.5 EQUIPMENTS LIST FOR ALL TEST ITEMS

Radiation Test equipment

Item	Equipment	Manufacturer	Type No.	Serial No.	Firmware Version	Last calibration	Calibrated until
1	Spectrum Analyzer (9kHz-26.5GHz)	KEYSIGHT	9020A	MY55370835	A.17.05	Oct. 28, 2022	Oct. 27, 2023
2	Spectrum Analyzer (10kHz-39.9GHz)	R&S	FSV40-N	100363	1.71 SP2	Oct. 28, 2022	Oct. 27, 2023
3	EMI Test Receiver (9kHz-7GHz)	R&S	ESCI7	101169	4.32	Oct. 28, 2022	Oct. 27, 2023
4	Bilog Antenna (30MHz-1500MHz)	Schwarzbeck	VULB9168	N/A	N/A	Nov. 02, 2022	Nov. 01, 2023
5	Horn Antenna (1GHz-18GHz)	Agilent	AH-118	071145	N/A	Nov. 01, 2022	Oct. 31, 2023
6	Horn Antenna (15GHz-40GHz)	A.H.System	SAS-574	588	N/A	Oct. 28, 2022	Oct. 27, 2023
7	Loop Antenna	TESEQ	HLA6121	58357	N/A	Nov. 01, 2022	Oct. 31, 2023
8	Amplifier (30-1000MHz)	EM Electronics	EM330 Amplifier	060747	N/A	Nov. 15, 2022	Nov. 14, 2023
9	Amplifier (1GHz-26.5GHz)	Agilent	8449B	3008A00315	N/A	Oct. 28, 2022	Oct. 27, 2023
10	Amplifier (500MHz-40GHz)	Quanjuda	DLE-161	097	N/A	Oct. 28, 2022	Oct. 27, 2023
11	Test Cable	N/A	R-01	N/A	N/A	Oct. 28, 2022	Oct. 27, 2023
12	Test Cable	N/A	R-02	N/A	N/A	Oct. 28, 2022	Oct. 27, 2023
13	Test Cable	N/A	R-03	N/A	N/A	Oct. 28, 2022	Oct. 27, 2023
14	Test Cable	N/A	RF-01	N/A	N/A	Oct. 28, 2022	Oct. 27, 2023
15	Test Cable	N/A	RF-02	N/A	N/A	Oct. 28, 2022	Oct. 27, 2023
16	Test Cable	N/A	RF-03	N/A	N/A	Oct. 28, 2022	Oct. 27, 2023
17	ESG Signal Generator	Agilent	E4421B	N/A	B.03.84	Oct. 21, 2022	Oct. 20, 2023
18	Signal Generator	Agilent	N5182A	N/A	A.01.87	Oct. 21, 2022	Oct. 20, 2023
19	Magnetic Field Probe Tester	Narda	ELT-400	0-0344	N/A	Nov. 15, 2022	Nov. 14, 2023
20	Wideband Radio Communication Test	R&S	CMW500	106504	V 3.7.22	Oct. 28, 2022	Oct. 27, 2023
21	RF Power Meter	KEYSIGHT	N1912A P	N/A	A.05.00	Oct. 21, 2022	Oct. 20, 2023
22	D.C. Power Supply	LongWei	TPR-6405D	N/A	N/A	\	\
23	EMC Software	Frad	EZ-EMC	Ver.EMC-CO N 3A1.1	N/A	\	\
24	RF Software	MW	MTS8310	V2.0.0.0	N/A	\	\
25	Turntable	MF	MF-7802BS	N/A	N/A	\	\
26	Antenna tower	MF	MF-7802BS	N/A	N/A	\	\



Conduction Test equipment

Item	Kind of Equipment	Manufacturer	Type No.	Serial No.	Firmware Version	Last calibration	Calibrated until
1	LISN	R&S	ENV216	101471	N/A	Oct. 21, 2022	Oct. 20, 2023
2	LISN	CYBERTEK	EM5040A	E1850400149	N/A	Oct. 21, 2022	Oct. 20, 2023
3	Test Cable	N/A	C-01	N/A	N/A	Oct. 21, 2022	Oct. 20, 2023
4	Test Cable	N/A	C-02	N/A	N/A	Oct. 21, 2022	Oct. 20, 2023
5	Test Cable	N/A	C-03	N/A	N/A	Oct. 21, 2022	Oct. 20, 2023
6	EMI Test Receiver	R&S	ESCI3	101393	4.42 SP3	Oct. 28, 2022	Oct. 27, 2023
7	Triple-Loop Antenna	N/A	RF300	N/A	N/A	Oct. 28, 2022	Oct. 27, 2023
8	Absorbing Clamp	DZ	ZN23201	15034	N/A	Oct. 31, 2022	Oct. 30, 2023
9	EMC Software	Frad	EZ-EMC	Ver.EMC-CON 3A1.1	N/A	\	\



4.EMC EMISSION TEST

4.1 CONDUCTED EMISSION MEASUREMENT

Test Requirement:	FCC Part15 C Section 15.207
Test Method:	ANSI C63.10:2013
Test Frequency Range:	150KHz to 30MHz
Receiver setup:	RBW=9KHz, VBW=30KHz, Sweep time=auto

4.1.1 POWER LINE CONDUCTED EMISSION Limits

FREQUENCY (MHz)	Limit (dBuV)		Standard
	Quasi-peak	Average	
0.15 -0.5	66 - 56 *	56 - 46 *	FCC
0.50 -5.0	56.00	46.00	FCC
5.0 -30.0	60.00	50.00	FCC

Note:

(1) *Decreases with the logarithm of the frequency.

4.1.2 TEST PROCEDURE

- a. The EUT was placed 0.8 meters from the horizontal ground plane with EUT being connected to the power mains through a line impedance stabilization network (LISN). All other support equipments powered from additional LISN(s). The LISN provide 50 Ohm/ 50uH of coupling impedance for the measuring instrument.
- b. Interconnecting cables that hang closer than 40 cm to the ground plane shall be folded back and forth in the center forming a bundle 30 to 40 cm long.
- c. I/O cables that are not connected to a peripheral shall be bundled in the center. The end of the cable may be terminated, if required, using the correct terminating impedance. The overall length shall not exceed 1 m.
- d. LISN at least 80 cm from nearest part of EUT chassis.
- e. For the actual test configuration, please refer to the related Item –EUT Test Photos.

4.1.3 DEVIATION FROM TEST STANDARD

No deviation



4.1.4 TEST SETUP

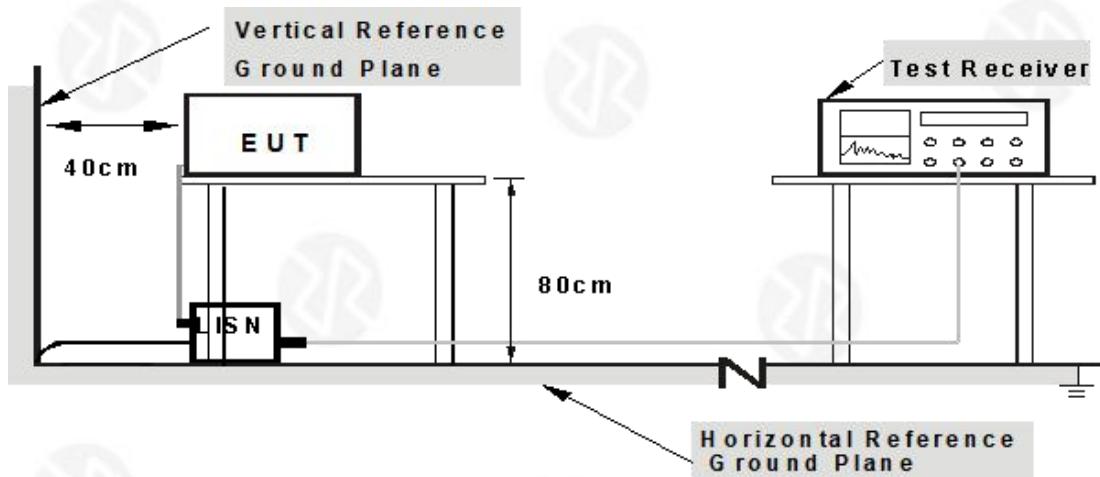

- Note:**
- 1.Support units were connected to second LISN.
 - 2.Both of LISNs (AMN) are 80 cm from EUT and at least 80 from other units and other metal planes

4.1.5 EUT OPERATING CONDITIONS

The EUT was configured for testing in a typical fashion (as a customer would normally use it). The EUT has been programmed to continuously transmit during test. This operating condition was tested and used to collect the included data.

4.1.6 Test Result

N/A

Remark: Only AC products need to test this item, DC products are not applicable to this item.



4.2 RADIATED EMISSION MEASUREMENT

4.2.1 APPLICABLE STANDARD

According to FCC Part 15.407(d) and 15.209

4.2.2 CONFORMANCE LIMIT

According to FCC Part 15.407(b)(7): radiated emissions which fall in the restricted bands, as defined in §15.205(a), must also comply with the radiated emission limits specified in §15.209(a) (see §15.205(c)).
According to FCC Part 15.205, Restricted bands

MHz	MHz	MHz	GHz
0.090-0.110	16.42-16.423	399.9-410	4.5-5.15
10.495-0.505	16.69475-16.69525	608-614	5.35-5.46
2.1735-2.1905	16.80425-16.80475	960-1240	7.25-7.75
4.125-4.128	25.5-25.67	1300-1427	8.025-8.5
4.17725-4.17775	37.5-38.25	1435-1626.5	9.0-9.2
4.20725-4.20775	73-74.6	1645.5-1646.5	9.3-9.5
6.215-6.218	74.8-75.2	1660-1710	10.6-12.7
6.26775-6.26825	123-138	2200-2300	14.47-14.5
8.291-8.294	149.9-150.05	2310-2390	15.35-16.2
8.362-8.366	156.52475-156.52525	2483.5-2500	17.7-21.4
8.37625-8.38675	156.7-156.9	2690-2900	22.01-23.12
8.41425-8.41475	162.0125-167.17	3260-3267	23.6-24.0
12.29-12.293	167.72-173.2	3332-3339	31.2-31.8
12.51975-12.52025	240-285	3345.8-3358	36.43-36.5
12.57675-12.57725	322-335.4	3600-4400	(2)
13.36-13.41			

Restricted Frequency(MHz)	Field Strength (μV/m)	Field Strength (dBμV/m)	Measurement Distance
0.009~0.490	2400/F(KHz)	20 log (uV/m)	300
0.490~1.705	2400/F(KHz)	20 log (uV/m)	30
1.705~30.0	30	29.5	30
30-88	100	40	3
88-216	150	43.5	3
216-960	200	46	3
Above 960	500	54	3

Limits of Radiated Emission Measurement(Above 1000MHz)

Frequency(MHz)	Class B (dBuV/m) (at 3M)	
	PEAK	AVERAGE
Above 1000	74	54

- Remark : 1. Emission level in dBuV/m=20 log (uV/m)
2. Measurement was performed at an antenna to the closed point of EUT distance of meters.
3. Distance extrapolation factor =40log(Specific distance/ test distance)(dB);
Limit line=Specific limits(dBuV) + distance extrapolation factor.

4.2.3 MEASURING INSTRUMENTS

The Measuring equipment is listed in the section 6.3 of this test report.



4.2.4 TEST CONFIGURATION

1. For radiated emissions below 30MHz

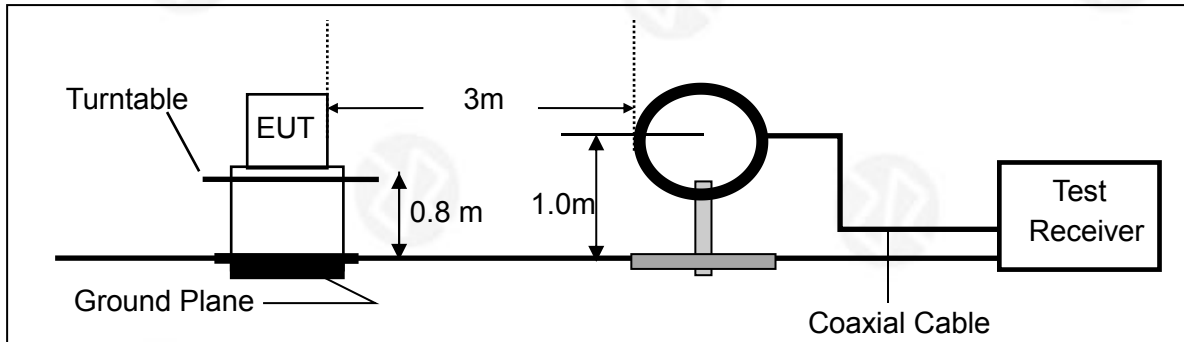

2. For radiated emissions from 30MHz to 1000MHz

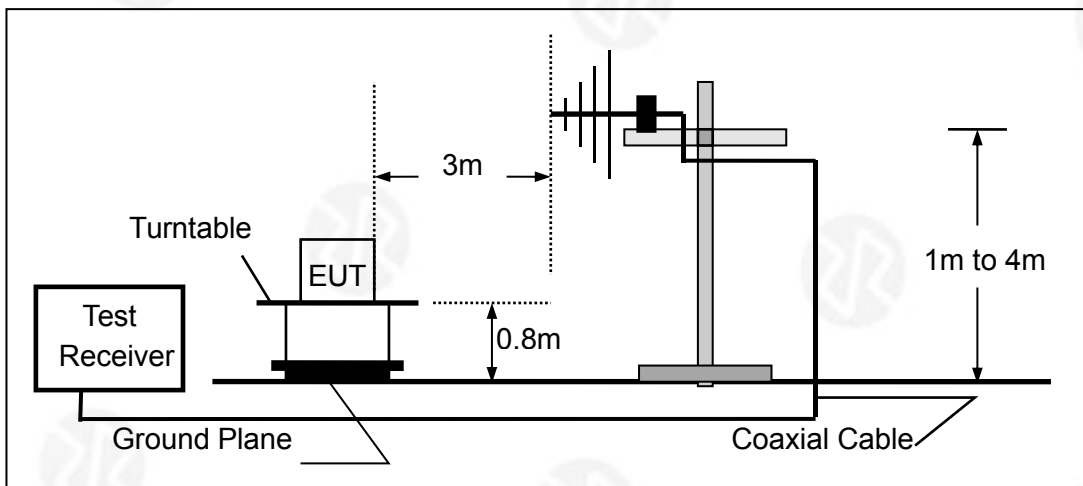

3. Radiated Emission Test-Up Frequency Above 1GHz

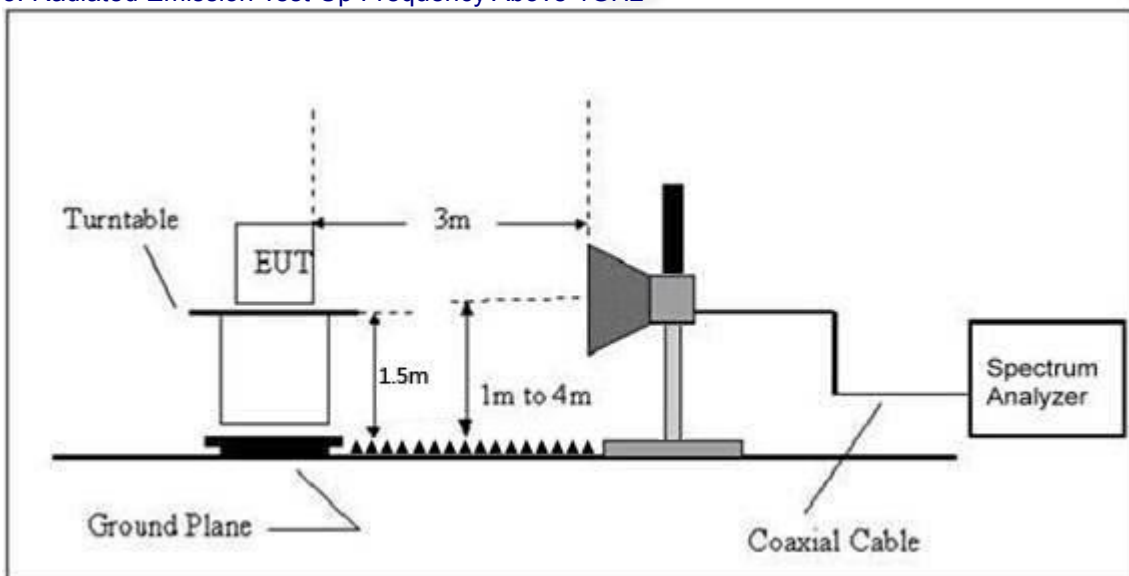



4.2.5 TEST PROCEDURE

The test site semi-anechoic chamber has met the requirement of NSA tolerance 4 dB according to the standards: ANSI C63.10-2013. The test distance is 3m. The setup is according to the requirements in Section 13.1.4.1 of ANSI C63.10-2013 and CAN/CSA-CEI/IEC CISPR 22.

This test is required for any spurious emission that falls in a Restricted Band, as defined in Section 15.205. It must be performed with the highest gain of each type of antenna proposed for use with the EUT. Use the following spectrum analyzer settings:

Spectrum Parameter	Setting
Attenuation	Auto
Start Frequency	1000 MHz
Stop Frequency	10th carrier harmonic
RB / VB (emission in restricted band)	1 MHz / 1 MHz for Peak, 1 MHz / 10Hz for Average

Receiver Parameter	Setting
Attenuation	Auto
Start ~ Stop Frequency	9kHz~150kHz / RB 200Hz for QP
Start ~ Stop Frequency	150kHz~30MHz / RB 9kHz for QP
Start ~ Stop Frequency	30MHz~1000MHz / RB 120kHz for QP

- The measuring distance of at 3 m shall be used for measurements at frequency up to 1GHz. For frequencies above 1GHz, any suitable measuring distance may be used.
- The EUT was placed on the top of a rotating table 0.8 m for below 1GHz and 1.5m for above 1GHz the ground at a 3 meter. The table was rotated 360 degrees to determine the position of the highest radiation.
- The height of the equipment or of the substitution antenna shall be 0.8 m for below 1GHz and 1.5m for above 1GHz; the height of the test antenna shall vary between 1 m to 4 m. Both horizontal and vertical polarizations of the antenna are set to make the measurement.
- The initial step in collecting conducted emission data is a spectrum analyzer peak detector mode pre-scanning the measurement frequency range. Significant peaks are then marked and then Quasi Peak detector mode re-measured.
- If the Peak Mode measured value compliance with and lower than Quasi Peak Mode Limit, the EUT shall be deemed to meet QP Limits and then no additional QP Mode measurement performed.
- For the actual test configuration, please refer to the related Item –EUT Test Photos.

Note:

Both horizontal and vertical antenna polarities were tested and performed pretest to three orthogonal axis. The worst case emissions were reported

During the radiated emission test, the Spectrum Analyzer was set with the following configurations:

Frequency Band (MHz)	Function	Resolution bandwidth	Video Bandwidth
30 to 1000	QP	120 kHz	300 kHz
Above 1000	Peak	1 MHz	1 MHz
	Average	1 MHz	10 Hz

Note: for the frequency ranges below 30 MHz, a narrower RBW is used for these ranges but the measured value should add a RBW correction factor (RBWCF) where $RBWCF [dB] = 10 \cdot \lg(100 [kHz] / \text{narrower RBW} [kHz])$. , the narrower RBW is 1 kHz and RBWCF is 20 dB for the frequency 9 kHz to 150 kHz, and the narrower RBW is 10 kHz and RBWCF is 10 dB for the frequency 150 kHz to 30 MHz.



4.2.6 TEST RESULT

Between 9KHz – 30MHz

The emission from 9 kHz to 30MHz was pre-tested and found the result was 20dB lower than the limit, and according to 15.31(o) & RSS-Gen 6.13, the test result no need to reported.

Between 30MHz – 1GHz

Temperature:	26°C	Relative Humidity:	54%
Pressure:	101 kPa	Polarization:	Horizontal
Test Voltage:	DC 5V	Test Mode :	TX - 5180MHz

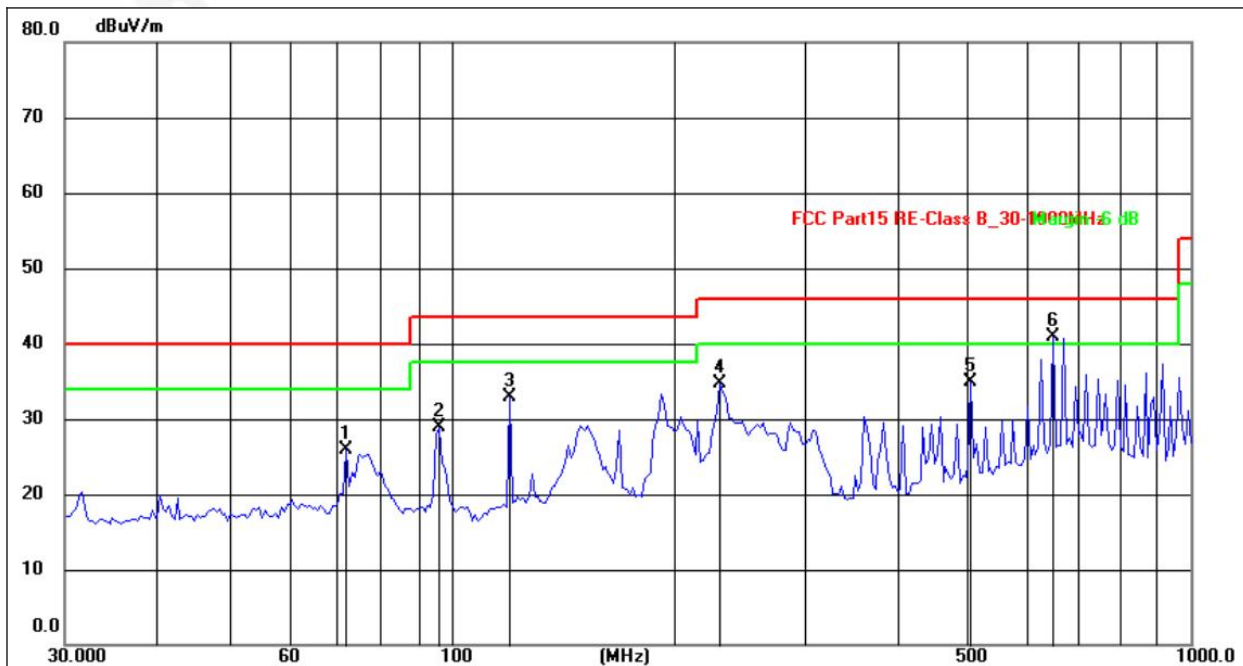

No.	Frequency (MHz)	Reading (dBuV)	Factor (dB/m)	Level (dBuV/m)	Limit (dBuV/m)	Margin (dB)	Detector
1	72.0841	43.24	-17.43	25.81	40.00	-14.19	QP
2	96.2672	48.80	-19.96	28.84	43.50	-14.66	QP
3	119.8555	51.41	-18.59	32.82	43.50	-10.68	QP
4	231.3119	51.61	-16.93	34.68	46.00	-11.32	QP
5	504.7062	46.38	-11.50	34.88	46.00	-11.12	QP
6	650.7997	48.70	-7.75	40.95	46.00	-5.05	QP



Temperature:	26°C	Relative Humidity:	54%
Pressure:	101kPa	Polarization:	Vertical
Test Voltage:	DC 5V	Test Mode :	TX - 5180MHz

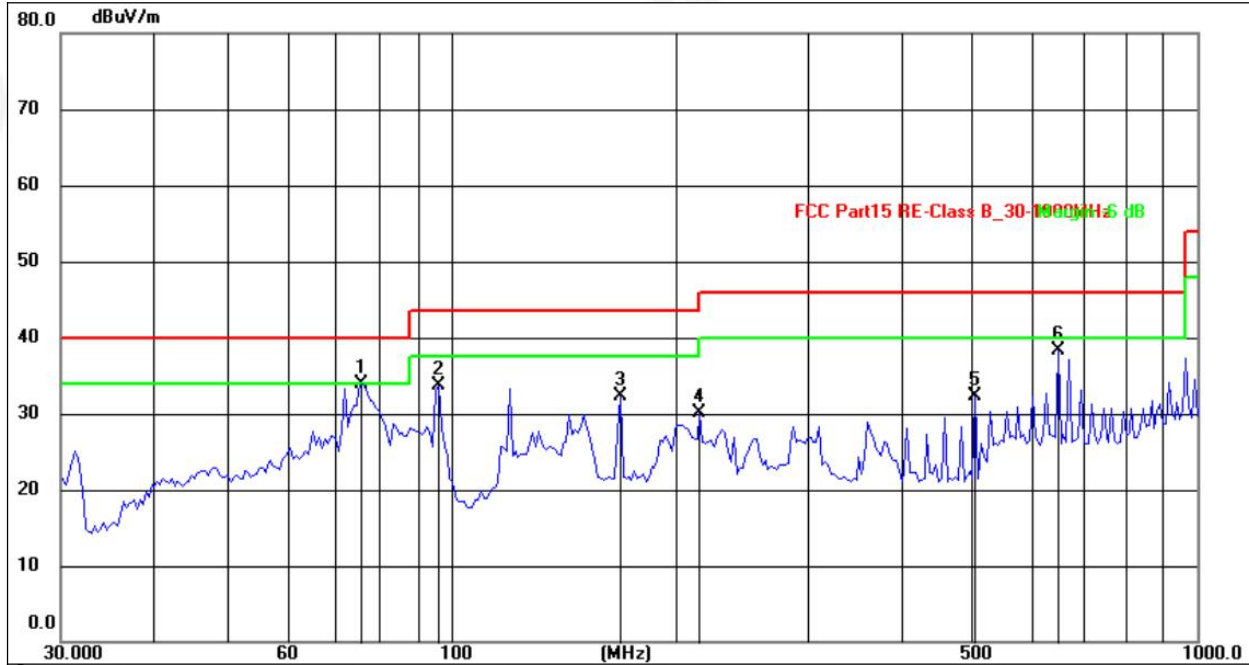

No.	Frequency (MHz)	Reading (dBuV)	Factor (dB/m)	Level (dBuV/m)	Limit (dBuV/m)	Margin (dB)	Detector
1	75.9770	54.74	-20.84	33.90	40.00	-6.10	QP
2	96.2672	55.02	-21.32	33.70	43.50	-9.80	QP
3	168.7093	52.31	-20.04	32.27	43.50	-11.23	QP
4	215.6451	50.50	-20.45	30.05	43.50	-13.45	QP
5	504.7062	43.78	-11.40	32.38	46.00	-13.62	QP
6	650.7997	45.97	-7.71	38.26	46.00	-7.74	QP

Remarks:

1. Final Level = Receiver Read level + Antenna Factor + Cable Loss – Preamplifier Factor
2. The emission levels of other frequencies are very lower than the limit and not show in test report.
3. The test data shows only the worst case TX - 5180MHz.



Between 1GHz – 40GHz

Temperature :	26°C	Relative Humidity :	54%
Pressure :	1010 hPa	Test Voltage :	DC 5V
Test Mode :	5.2G TX - 802.11a		

802.11a

Polar (H/V)	Frequency	Meter Reading	Pre-amplifier	Cable Loss	Antenna Factor	Emission Level	Limits	Margin	Detect or Type
	(MHz)	(dBuV)	(dB)	(dB)	(dB)	(dBuV/m)	(dBuV/m)	(dB)	
Low Channel:5180MHz									
V	5150.00	42.39	30.45	8.77	38.66	59.37	74.00	-14.63	PK
V	5150.00	32.74	30.45	8.77	38.66	49.72	54.00	-4.28	AV
V	10360.00	52.65	30.55	5.77	24.66	52.53	74.00	-21.47	PK
V	10360.00	43.36	30.55	5.77	24.66	43.24	54.00	-10.76	AV
V	15540.00	54.54	30.33	6.32	24.55	55.08	74.00	-18.92	PK
V	15540.00	43.85	30.33	6.32	24.55	44.39	54.00	-9.61	AV
V	20720.00	50.37	30.85	7.45	24.69	51.66	74.00	-22.34	PK
V	20720.00	43.61	30.85	7.45	24.69	44.90	54.00	-9.10	AV
V	25900.00	52.25	31.02	8.99	25.57	55.79	74.00	-18.21	PK
V	25900.00	43.45	31.02	8.99	25.57	46.99	54.00	-7.01	AV
H	5150.00	42.28	30.45	8.77	38.66	59.26	74.00	-14.74	PK
H	5150.00	32.39	30.45	8.77	38.66	49.37	54.00	-4.63	AV
H	10360.00	50.85	30.55	5.77	24.66	50.73	74.00	-23.27	PK
H	10360.00	43.14	30.55	5.77	24.66	43.02	54.00	-10.98	AV
H	15540.00	53.85	30.33	6.32	24.55	54.39	74.00	-19.61	PK
H	15540.00	43.69	30.33	6.32	24.55	44.23	54.00	-9.77	AV
H	20720.00	51.84	30.85	7.45	24.69	53.13	74.00	-20.87	PK
H	20720.00	43.74	30.85	7.45	24.69	45.03	54.00	-8.97	AV
H	25900.00	50.85	31.02	8.99	25.57	54.39	74.00	-19.61	PK
H	25900.00	43.53	31.02	8.99	25.57	47.07	54.00	-6.93	AV

Polar (H/V)	Frequency	Meter Reading	Pre-amplifier	Cable Loss	Antenna Factor	Emission Level	Limits	Margin	Detect or Type
	(MHz)	(dBuV)	(dB)	(dB)	(dB)	(dBuV/m)	(dBuV/m)	(dB)	
Middle Channel:5200MHz									
V	5150.00	52.62	31.02	8.99	25.57	56.16	74.00	-17.84	PK
V	5150.00	43.31	31.02	8.99	25.57	46.85	54.00	-7.15	AV
V	10400.00	42.41	30.45	8.77	38.66	59.39	74.00	-14.61	PK
V	10400.00	32.85	30.45	8.77	38.66	49.83	54.00	-4.17	AV
V	15600.00	50.66	30.55	5.77	24.66	50.54	74.00	-23.46	PK
V	15600.00	43.78	30.55	5.77	24.66	43.66	54.00	-10.34	AV
V	20800.00	50.25	30.85	7.45	24.69	51.54	74.00	-22.46	PK
V	20800.00	43.36	30.85	7.45	24.69	44.65	54.00	-9.35	AV
V	26000.00	52.28	31.02	8.99	25.57	55.82	74.00	-18.18	PK
V	26000.00	43.25	31.02	8.99	25.57	46.79	54.00	-7.21	AV
H	5150.00	42.37	30.45	8.77	38.66	59.35	74.00	-14.65	PK
H	5150.00	32.42	30.45	8.77	38.66	49.40	54.00	-4.60	AV
H	10400.00	50.46	30.55	5.77	24.66	50.34	74.00	-23.66	PK
H	10400.00	43.25	30.55	5.77	24.66	43.13	54.00	-10.87	AV
H	15600.00	53.32	30.33	6.32	24.55	53.86	74.00	-20.14	PK



H	15600.00	43.41	30.33	6.32	24.55	43.95	54.00	-10.05	AV
H	20800.00	51.58	30.85	7.45	24.69	52.87	74.00	-21.13	PK
H	20800.00	43.86	30.85	7.45	24.69	45.15	54.00	-8.85	AV
H	26000.00	50.95	31.02	8.99	25.57	54.49	74.00	-19.51	PK
H	26000.00	43.76	31.02	8.99	25.57	47.30	54.00	-6.70	AV

Polar (H/V)	Frequency	Meter Reading	Pre-amplifier	Cable Loss	Antenna Factor	Emission Level	Limits	Margin	Detect or Type
	(MHz)	(dBuV)	(dB)	(dB)	(dB)	(dBuV/m)	(dBuV/m)	(dB)	
High Channel:5240MHz									
V	5350.00	53.33	30.33	6.32	24.55	53.87	74.00	-20.13	PK
V	5350.00	43.22	30.33	6.32	24.55	43.76	54.00	-10.24	AV
V	10480.00	51.68	30.85	7.45	24.69	52.97	74.00	-21.03	PK
V	10480.00	43.87	30.85	7.45	24.69	45.16	54.00	-8.84	AV
V	15720.00	50.86	31.02	8.99	25.57	54.40	74.00	-19.60	PK
V	15720.00	43.93	31.02	8.99	25.57	47.47	54.00	-6.53	AV
V	20960.00	50.37	30.85	7.45	24.69	51.66	74.00	-22.34	PK
V	20960.00	43.32	30.85	7.45	24.69	44.61	54.00	-9.39	AV
V	26200.00	52.62	31.02	8.99	25.57	56.16	74.00	-17.84	PK
V	26200.00	43.31	31.02	8.99	25.57	46.85	54.00	-7.15	AV
H	5350.00	42.41	30.45	8.77	38.66	59.39	74.00	-14.61	PK
H	5350.00	32.85	30.45	8.77	38.66	49.83	54.00	-4.17	AV
H	10480.00	50.66	30.55	5.77	24.66	50.54	74.00	-23.46	PK
H	10480.00	43.78	30.55	5.77	24.66	43.66	54.00	-10.34	AV
H	15720.00	53.33	30.33	6.32	24.55	53.87	74.00	-20.13	PK
H	15720.00	43.22	30.33	6.32	24.55	43.76	54.00	-10.24	AV
H	20960.00	51.68	30.85	7.45	24.69	52.97	74.00	-21.03	PK
H	20960.00	43.87	30.85	7.45	24.69	45.16	54.00	-8.84	AV
H	26200.00	50.86	31.02	8.99	25.57	54.40	74.00	-19.60	PK
H	26200.00	43.93	31.02	8.99	25.57	47.47	54.00	-6.53	AV

Remark:

1. Emission Level = Meter Reading + Antenna Factor + Cable Loss – Pre-amplifier, Margin= Emission Level - Limit
2. If peak below the average limit, the average emission was no test.
3. The amplitude of spurious emissions which are attenuated by more than 20dB below the permissible value has no need to be reported.



5. POWER SPECTRAL DENSITY TEST

5.1 APPLIED PROCEDURES / LIMIT

According to FCC §15.407(3)

Power limits:

(1) For the band 5.15-5.25 GHz.

(i) For an outdoor access point operating in the band 5.15-5.25 GHz, the maximum power spectral density shall not exceed 17 dBm in any 1 megahertz band. If transmitting antennas of directional gain greater than 6 dBi are used, both the maximum conducted output power and the maximum power spectral density shall be reduced by the amount in dB that the directional gain of the antenna exceeds 6 dBi. The maximum e.i.r.p. at any elevation angle above 30 degrees as measured from the horizon must not exceed 125 mW (21 dBm).

(ii) For an indoor access point operating in the band 5.15-5.25 GHz, the maximum power spectral density shall not exceed 17 dBm in any 1 megahertz band. If transmitting antennas of directional gain greater than 6 dBi are used, both the maximum conducted output power and the maximum power spectral density shall be reduced by the amount in dB that the directional gain of the antenna exceeds 6 dBi.

(iii) For fixed point-to-point access points operating in the band 5.15-5.25 GHz, the maximum power spectral density shall not exceed 17 dBm in any 1 megahertz band. Fixed point-to-point U-NII devices may employ antennas with directional gain up to 23 dBi without any corresponding reduction in the maximum conducted output power or maximum power spectral density. For fixed point-to-point transmitters that employ a directional antenna gain greater than 23 dBi, a 1 dB reduction in maximum conducted output power and maximum power spectral density is required for each 1 dB of antenna gain in excess of 23 dBi. Fixed, point-to-point operations exclude the use of point-to-multipoint systems, omnidirectional applications, and multiple collocated transmitters transmitting the same information. The operator of the U-NII device, or if the equipment is professionally installed, the installer, is responsible for ensuring that systems employing high gain directional antennas are used exclusively for fixed, point-to-point operations.

(iv) For client devices in the 5.15-5.25 GHz band, the maximum power spectral density shall not exceed 11 dBm in any 1 megahertz band. If transmitting antennas of directional gain greater than 6 dBi are used, both the maximum conducted output power and the maximum power spectral density shall be reduced by the amount in dB that the directional gain of the antenna exceeds 6 dBi.

(2) For the 5.25-5.35 GHz and 5.47-5.725 GHz bands, the maximum conducted output power over the frequency bands of operation shall not exceed the lesser of 250 mW or $11 \text{ dBm} + 10 \log B$, where B is the 26 dB emission bandwidth in megahertz. In addition, the maximum power spectral density shall not exceed 11 dBm in any 1 megahertz band. If transmitting antennas of directional gain greater than 6 dBi are used, both the maximum conducted output power and the maximum power spectral density shall be reduced by the amount in dB that the directional gain of the antenna exceeds 6 dBi.

(3) For the band 5.725-5.85 GHz, the maximum conducted output power over the frequency band of operation shall not exceed 1 W. In addition, the maximum power spectral density shall not exceed 30 dBm in any 500-kHz band. If transmitting antennas of directional gain greater than 6 dBi are used, both the maximum conducted output power and the maximum power spectral density shall be reduced by the amount in dB that the directional gain of the antenna exceeds 6 dBi. However, fixed point-to-point U-NII devices operating in this band may employ transmitting antennas with directional gain greater than 6 dBi without any corresponding reduction in transmitter conducted power. Fixed, point-to-point operations exclude the use of point-to-multipoint systems, omnidirectional applications, and multiple collocated transmitters transmitting the same information. The operator of the U-NII device, or if the equipment is professionally installed, the installer, is responsible for ensuring that systems employing high gain directional antennas are used exclusively for fixed, point-to-point operations.



5.2 TEST PROCEDURE

For devices operating in the bands 5.15-5.25 GHz, 5.25-5.35 GHz, and 5.47-5.725 GHz, the above procedures make use of 1 MHz RBW to satisfy directly the 1 MHz reference bandwidth specified in § 15.407(a)(5). For devices operating in the band 5.725-5.85 GHz, the rules specify a measurement bandwidth of 500 kHz. Many spectrum analyzers do not have 500 kHz RBW, thus a narrower RBW may need to be used. The rules permit the use of a RBWs less than 1 MHz, or 500 kHz, “provided that the measured power is integrated over the full reference bandwidth” to show the total power over the specified measurement bandwidth (i.e., 1 MHz, or 500 kHz). If measurements are performed using a reduced resolution bandwidth (< 1 MHz, or < 500 kHz) and integrated over 1 MHz, or 500 KHz bandwidth, the following adjustments to the procedures apply:

- a) Set $RBW \geq 1/T$, where T is defined in section II.B.I.a).
- b) Set $VBW \geq 3 RBW$.
- c) Detector = RMS (i.e., PSD Average)
- d) If measurement bandwidth of Maximum PSD is specified in 500 kHz, add $10\log(500\text{kHz}/RBW)$ to the measured result, whereas RBW (< 500 KHz) is the reduced resolution bandwidth of the spectrum analyzer set during measurement.
- e) If measurement bandwidth of Maximum PSD is specified in 1 MHz, add $10\log(1\text{MHz}/RBW)$ to the measured result, whereas RBW (< 1 MHz) is the reduced resolution bandwidth of spectrum analyzer set during measurement.
- f) Care must be taken to ensure that the measurements are performed during a period of continuous transmission or are corrected upward for duty cycle.

Note: As a practical matter, it is recommended to use reduced RBW of 100 KHz for the sections 5.c) and 5.d) above, since RBW=100 KHZ is available on nearly all spectrum analyzers.

5.3 DEVIATION FROM STANDARD

No deviation.

5.4 TEST SETUP



5.5 EUT OPERATION CONDITIONS

The EUT tested system was configured as the statements of 2.1 Unless otherwise a special operating condition is specified in the follows during the testing.



5.6 TEST RESULTS

Temperature :	26 °C	Relative Humidity :	54%
Pressure :	1015 hPa	Test Voltage :	DC 5V
Test Mode :	TX		

5.2G				
Test mode	Test Channel (MHz)	PSD [dBm/MHz]	Limit (dBm/MHz)	Result
802.11a	5180	-0.965	11	Pass
	5200	-0.699	11	Pass
	5240	-0.850	11	Pass

(802.11a) PSD plot on channel 36(RMS)

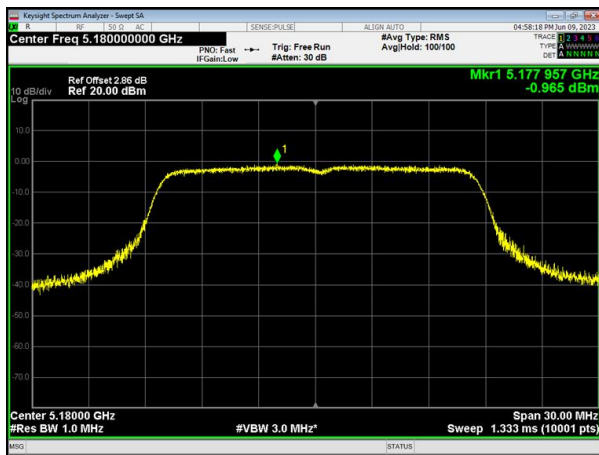

(802.11a) PSD plot on channel 40

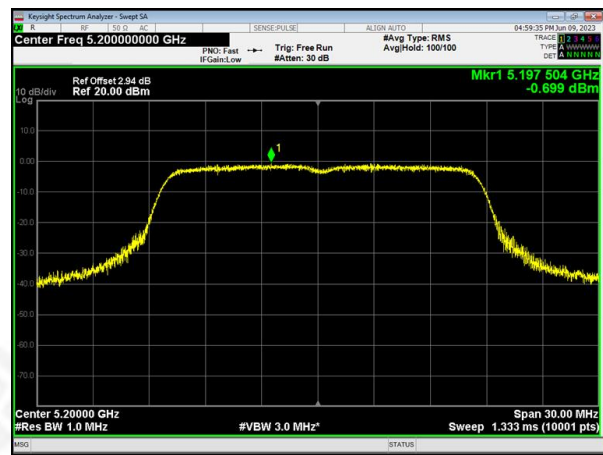

(802.11a) PSD plot on channel 48





6. 26DB EMISSION BANDWIDTH

6.1 APPLIED PROCEDURES / LIMIT

The maximum power spectral density is measured as a conducted emission by direct connection of a calibrated test instrument to the equipment under test. If the device cannot be connected directly, alternative techniques acceptable to the Commission may be used. Measurements in the 5.725-5.85 GHz band, the minimum bandwidth 6 dB bandwidth of U-NII devices shall be at least 500KHz. Measurements in the 5.15-5.25 GHz, 5.25-5.35 GHz, and the 5.47-5.725 GHz bands are made over a bandwidth of 1 MHz or the 26 dB emission bandwidth of the device, whichever is less. A narrower resolution bandwidth can be used, provided that the measured power is integrated over the full reference bandwidth.

6.2 TEST PROCEDURE

The following procedure shall be used for measuring 6dB bandwidth:

The procedure for this method is as follows:

- a) Set RBW = 100KHz.
- b) Set the VBW > RBW.
- c) Detector = Peak.
- d) Trace mode = max hold.
- e) Measure the maximum width of the emission that is constrained by the frequencies associated with the two outermost amplitude points (upper and lower frequencies) that are attenuated by 6 dB relative to the maximum level measured in the fundamental emission.

The following procedure shall be used for measuring 26dB bandwidth:

The procedure for this method is as follows:

- a) Set RBW = approximately 1% of the emission bandwidth.
- b) Set the VBW > RBW.
- c) Detector = peak.
- d) Trace mode = max hold.
- e) Measure the maximum width of the emission that is 26 dB down from the peak of the emission. Compare this with the RBW setting of the instrument. Readjust RBW and repeat measurement as needed until the RBW/EBW ratio is approximately 1%.



6.3 EUT OPERATION CONDITIONS

The EUT tested system was configured as the statements of 2.4 Unless otherwise a special operating condition is specified in the follows during the testing.



6.4 TEST RESULTS

Temperature :	26 °C	Relative Humidity :	54%
Pressure :	101kPa	Test Voltage :	DC 5V
Test Mode :	TX		

5.2G				
Test Channel	-26dB Channel Bandwidth (MHz)		Limit(KHz)	Result
	802.11a			
Lowest	20.58		N/A	Pass
Middle	22.14			
Highest	20.61			

5.2G Test plot

(802.11 a) 26dB Bandwidth plot on channel 36

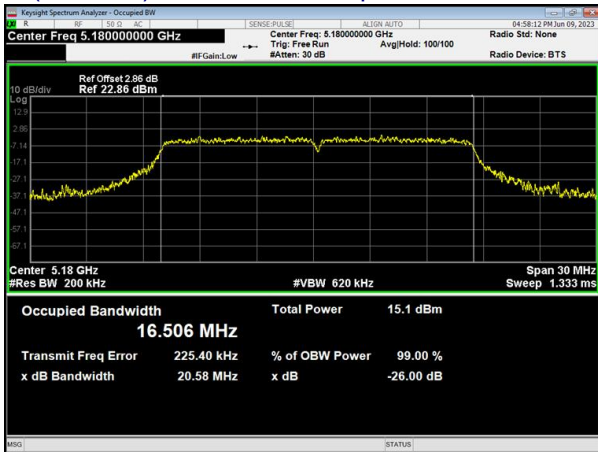

(802.11 a) 26dB Bandwidth plot on channel 40



(802.11 a) 26dB Bandwidth plot on channel 48

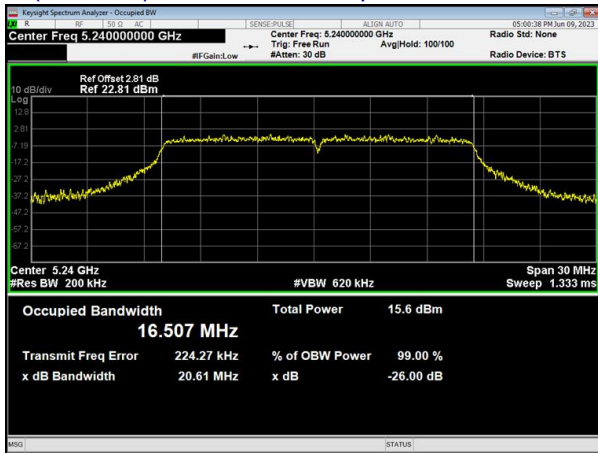



7. MAXIMUM CONDUCTED OUTPUT POWER

7.1 APPLIED PROCEDURES / LIMIT

According to FCC §15.407

The maximum conducted output power should not exceed:

Frequency Band(MHz)	Limit
5150~5250	250mW
5725~5850	1W

7.2 TEST PROCEDURE

The EUT was directly connected to the Power meter

1. Device Configuration

If possible, configure or modify the operation of the EUT so that it transmits continuously at its maximum power control level (see section II.B.).

a) The intent is to test at 100 percent duty cycle; however a small reduction in duty cycle (to no lower than 98 percent) is permitted if required by the EUT for amplitude control purposes. Manufacturers are expected to provide software to the test lab to permit such continuous operation.

b) If continuous transmission (or at least 98 percent duty cycle) cannot be achieved due to hardware limitations (e.g., overheating), the EUT shall be operated at its maximum power control level with the transmit duration as long as possible and the duty cycle as high as possible.

2. Measurement using a Spectrum Analyzer or EMI Receiver (SA)

Measurement of maximum conducted output power using a spectrum analyzer requires integrating the spectrum across a frequency span that encompasses, at a minimum, either the EBW or the 99-percent occupied bandwidth of the signal. However, the EBW must be used to determine bandwidth dependent limits on maximum conducted output power in accordance with § 15.407(a).

a) The test method shall be selected as follows: (i) Method SA-1 or SA-1 Alternative (averaging with the EUT transmitting at full power throughout each sweep) shall be applied if either of the following conditions can be satisfied:

- The EUT transmits continuously (or with a duty cycle ≥ 98 percent).
- Sweep triggering or gating can be implemented in a way that the device transmits at the maximum power control level throughout the duration of each of the instrument sweeps to be averaged. This condition can generally be achieved by triggering the instrument's sweep if the duration of the sweep (with the analyzer configured as in Method SA-1, below) is equal to or shorter than the duration T of each transmission from the EUT and if those transmissions exhibit full power throughout their durations.

(ii) Method SA-2 or SA-2 Alternative (averaging across on and off times of the EUT transmissions, followed by duty cycle correction) shall be applied if the conditions of (i) cannot be achieved and the transmissions exhibit a constant duty cycle during the measurement duration. Duty cycle will be considered to be constant if variations are less than ± 2 percent.

(iii) Method SA-3 (RMS detection with max hold) or SA-3 Alternative (reduced VBW with max hold) shall be applied if the conditions of (i) and (ii) cannot be achieved.

b) Method SA-1 (trace averaging with the EUT transmitting at full power throughout each sweep): (i) Set span to encompass the entire emission bandwidth (EBW) (or, alternatively, the entire 99% occupied bandwidth) of the signal.

(ii) Set RBW = 1 MHz.

(iii) Set VBW ≥ 3 MHz.

(iv) Number of points in sweep ≥ 2 Span / RBW. (This ensures that bin-to-bin spacing is \leq RBW/2, so that narrowband signals are not lost between frequency bins.)

(v) Sweep time = auto.

(vi) Detector = RMS (i.e., power averaging), if available. Otherwise, use sample detector mode.

(vii) If transmit duty cycle < 98 percent, use a video trigger with the trigger level set to enable triggering only on full power pulses. Transmitter must operate at maximum power control level for the entire duration of every sweep. If the EUT transmits continuously (i.e., with no off intervals) or at duty cycle ≥ 98 percent, and if each transmission is entirely at the maximum power control level, then the trigger shall be set to "free run".



- (viii) Trace average at least 100 traces in power averaging (i.e., RMS) mode.
- (ix) Compute power by integrating the spectrum across the EBW (or, alternatively, the entire 99% occupied bandwidth) of the signal using the instrument's band power measurement function with band limits set equal to the EBW (or occupied bandwidth) band edges. If the instrument does not have a band power function, sum the spectrum

7.3 DEVIATION FROM STANDARD

No deviation.

7.4 TEST SETUP



7.5 EUT OPERATION CONDITIONS

The EUT tested system was configured as the statements of 2.4 Unless otherwise a special operating condition is specified in the follows during the testing.



7.6 TEST RESULTS

Temperature :	26 °C	Relative Humidity :	54%
Pressure :	1012 hPa	Test Voltage :	DC 5V
Test Mode :	TX		

5.2G				
Test Channel	Frequency	Maximum output power	LIMIT	Result
	(MHz)	(dBm)	dBm	
TX 802.11 a Mode				
CH36	5180	11.632	23.98	Pass
CH40	5200	11.026	23.98	Pass
CH48	5240	11.359	23.98	Pass



8.OUT OF BAND EMISSIONS

8.1 APPLICABLE STANDARD

According to FCC §15.407(b)

Undesirable emission limits. Except as shown in paragraph (b)(7) of this section, the maximum emissions outside of the frequency bands of operation shall be attenuated in accordance with the following limits:

(1) For transmitters operating in the 5.15-5.25 GHz band: All emissions outside of the 5.15-5.35 GHz band shall not exceed an e.i.r.p. of -27 dBm/MHz.

(2)

(i) All emissions shall be limited to a level of -27 dBm/MHz at 75 MHz or more above or below the band edge increasing linearly to 10 dBm/MHz at 25 MHz above or below the band edge, and from 25 MHz above or below the band edge increasing linearly to a level of 15.6 dBm/MHz at 5 MHz above or below the band edge, and from 5 MHz above or below the band edge increasing linearly to a level of 27 dBm/MHz at the band edge.

8.2 TEST PROCEDURE

1. Check the calibration of the measuring instrument using either an internal calibrator or a known signal from an external generator.
2. Position the EUT without connection to measurement instrument. Turn on the EUT and connect its antenna terminal to measurement instrument via a low loss cable. Then set it to any one measured frequency within its operating range, and make sure the instrument is operated in its linear range.
3. Set RBW of spectrum analyzer to 1 MHz with a convenient frequency span.
4. Measure the highest amplitude appearing on spectral display and set it as a reference level. Plot the graph with marking the highest point and edge frequency.
5. Repeat above procedures until all measured frequencies were complete.

8.3 DEVIATION FROM STANDARD

No deviation.

8.4 TEST SETUP





8.5 EUT OPERATION CONDITIONS

The EUT tested system was configured as the statements of 2.4 Unless otherwise a special operating condition is specified in the follows during the testing.

8.6 TEST RESULTS

Temperature :	26 °C	Relative Humidity :	54%
Pressure :	1012 hPa	Test Voltage :	DC 5V
Test band :	5.2G	Antenna gain :	2.49dBi

5.180~5.240 GHz

(802.11a) Band Edge, Left Side

(802.11a) Band Edge, Right Side

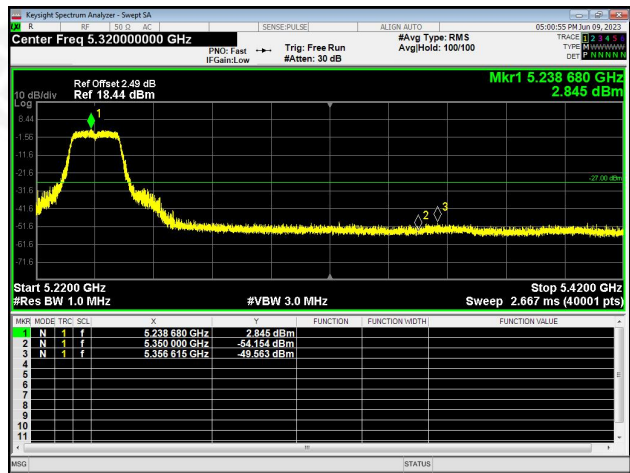
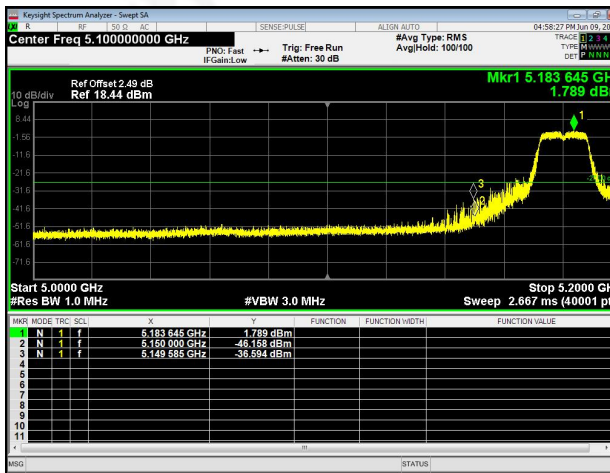



9.SPURIOUS RF CONDUCTED EMISSIONS

9.1 CONFORMANCE LIMIT

Frequency Band (MHz)	Limit
5150 - 5250	Outside of the 5.15-5.35 GHz band: e.i.r.p. -27 dBm
5250 - 5350	Outside of the 5.15-5.35 GHz band: e.i.r.p. -27 dBm
5470 - 5725	Outside of the 5.47-5.725 GHz band: e.i.r.p. -27 dBm
5725 - 5850	All emissions shall be limited to a level of -27 dBm/MHz at 75 MHz or more above or below the band edge increasing linearly to 10 dBm/MHz at 25 MHz above or below the band edge, and from 25 MHz above or below the band edge increasing linearly to a level of 15.6 dBm/MHz at 5 MHz above or below the band edge, and from 5 MHz above or below the band edge increasing linearly to a level of 27 dBm/MHz at the band edge.

9.2 MEASURING INSTRUMENTS

The Measuring equipment is listed in the section 6.3 of this test report.

9.3 TEST SETUP



9.4 TEST PROCEDURE

The Spurious RF conducted emissions compliance of RF radiated emission should be measured by following the guidance in ANSI C63.10-2013 with respect to maximizing the emission by rotating the EUT, measuring the emission while the EUT is situated in three orthogonal planes (if appropriate), adjusting the measurement antenna height and polarization etc. Set RBW=1MHz and VBW= 3MHz to measure the peak field strength, and measure frequency range from 30MHz to 26.5GHz.

9.5 TEST RESULTS

Remark: The measurement frequency range is from 30MHz to the 10th harmonic of the fundamental frequency. And above 26.5GHz of spurious emissions which are attenuated by more than 20dB below the permissible value has no need to be reported. The lowest, middle and highest channels are tested to verify the spurious emissions and band edge measurement data.



5.2G Test Plot

802.11a on channel 36

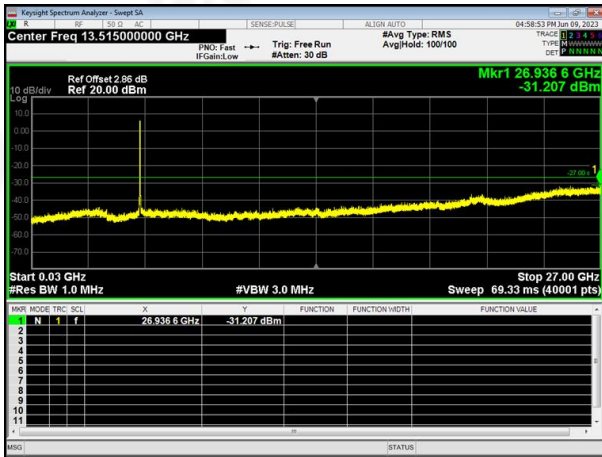

802.11a on channel 40

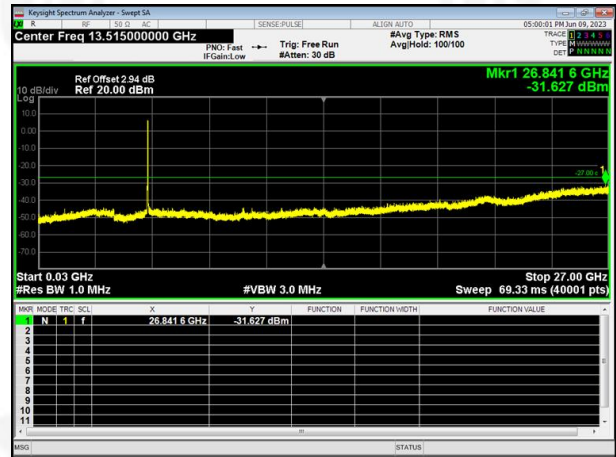

802.11a on channel 48

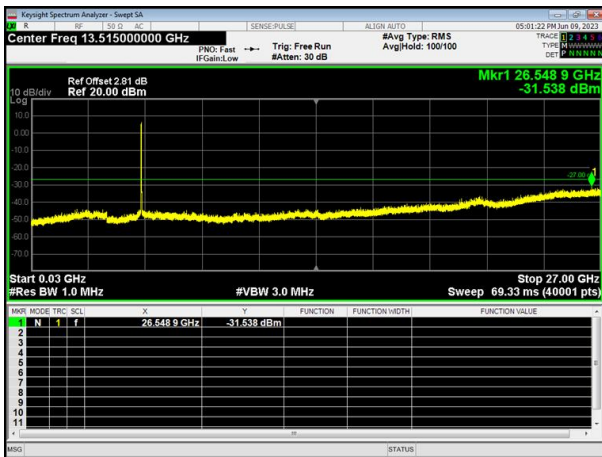



10.FREQUENCY STABILITY MEASUREMENT

10.1 LIMIT

Manufactures of U-NII devices are responsible for ensuring frequency stability such that an emission is maintained within the band of operation under all conditions of normal operation as specified in the user's manual.

The transmitter center frequency tolerance shall be ± 20 ppm maximum for the 5 GHz band (IEEE 802.11n specification).

10.2 TEST PROCEDURES

1. The transmitter output (antenna port) was connected to the spectrum analyzer.
2. EUT have transmitted absence of modulation signal and fixed channelize.
3. Set the spectrum analyzer span to view the entire absence of modulation emissions bandwidth.
4. Set RBW = 10 kHz, VBW = 10 kHz with peak detector and maxhold settings.
5. fc is declaring of channel frequency. Then the frequency error formula is $(f_c - f) / f_c \times 10^6$ ppm and the limit is less than ± 20 ppm (IEEE 802.11n specification).
6. The test extreme voltage is to change the primary supply voltage from 85 to 115 percent of the nominal value
7. Extreme temperature is $-20^{\circ}\text{C} \sim 70^{\circ}\text{C}$.

10.3 TEST SETUP LAYOUT



10.4 EUT OPERATION DURING TEST

The EUT was programmed to be in continuously un-modulation transmitting mode.

10.5 TEST RESULTS

Temperature :	26 °C	Relative Humidity :	54%
Pressure :	1012 hPa	Test Voltage :	DC 5V
Test Mode :	TX		



5.2G:

802.11a

Reference Frequency(Middle Channel): 5200MHz			
Environment Temperature (°C)	Power Supplied (VDC)	Frequency Measure with Time Elapsed	
		MCF	Error (ppm)
50	5	56	0.00969
40	5	45	0.00730
30	5	33	0.00582
20	5	28	0.00425
10	5	24	0.00393
0	5	15	0.00245
-10	5	14	0.00236
-20	5	24	0.00374
-30	5	37	0.00598

So, Frequency Stability Versus Input Voltage is:

802.11a

Reference Frequency(Middle Channel): 5200 MHz			
Environment Temperature (°C)	Power Supplied (VDC)	Frequency Measure with Time Elapsed	
		Frequency	Error (ppm)
20	5	56	0.00969
	5	45	0.00730
	5	37	0.00598

Note: The test data shows only the worst case Channel 5200 MHz.



11.ANTENNA REQUIREMENT

Standard requirement:	FCC Part15 C Section 15.203
15.203 requirement: An intentional radiator shall be designed to ensure that no antenna other than that furnished by the responsible party shall be used with the device. The use of a permanently attached antenna or of an antenna that uses a unique coupling to the intentional radiator, the manufacturer may design the unit so that a broken antenna can be replaced by the user, but the use of a standard antenna jack or electrical connector is prohibited.	
EUT Antenna:	
The antenna is FPCB Antenna, the best case gain of the antenna is 2.49dBi, reference to the appendix II for details	



12. TEST SETUP PHOTO

Reference to the appendix I for details.

13. EUT CONSTRUCTIONAL DETAILS

Reference to the appendix II for details.

***** END OF REPORT *****