

13. RESTRICTED BANDS OF OPERATION

13.1 LIMITS

Section 15.247(d) In addition, Radiated emissions which fall in the restricted bands, as defined in §15.205(a), must also comply with the radiated emission limits specified in §15.209(a) (see §15.205(c)).

| MHz | MHz | MHz | GHz |
|----------------------------|-----------------------|-----------------|---------------|
| 0.090 - 0.110 | 16.42 - 16.423 | 399.9 - 410 | 4.5 - 5.15 |
| ¹ 0.495 - 0.505 | 16.69475 - 16.69525 | 608 - 614 | 5.35 - 5.46 |
| 2.1735 - 2.1905 | 16.80425 - 16.80475 | 960 - 1240 | 7.25 - 7.75 |
| 4.125 - 4.128 | 25.5 - 25.67 | 1300 - 1427 | 8.025 - 8.5 |
| 4.17725 - 4.17775 | 37.5 - 38.25 | 1435 - 1626.5 | 9.0 - 9.2 |
| 4.20725 - 4.20775 | 73 - 74.6 | 1645.5 - 1646.5 | 9.3 - 9.5 |
| 6.215 - 6.218 | 74.8 - 75.2 | 1660 - 1710 | 10.6 - 12.7 |
| 6.26775 - 6.26825 | 108 - 121.94 | 1718.8 - 1722.2 | 13.25 - 13.4 |
| 6.31175 - 6.31225 | 123 - 138 | 2200 - 2300 | 14.47 - 14.5 |
| 8.291 - 8.294 | 149.9 - 150.05 | 2310 - 2390 | 15.35 - 16.2 |
| 8.362 - 8.366 | 156.52475 - 156.52525 | 2483.5 - 2500 | 17.7 - 21.4 |
| 8.37625 - 8.38675 | 156.7 - 156.9 | 2655 - 2900 | 22.01 - 23.12 |
| 8.41425 - 8.41475 | 162.0125 - 167.17 | 3260 - 3267 | 23.6 - 24.0 |
| 12.29 - 12.293 | 167.72 - 173.2 | 3332 - 3339 | 31.2 - 31.8 |
| 12.51975 - 12.52025 | 240 - 285 | 3345.8 - 3358 | 36.43 - 36.5 |
| 12.57675 - 12.57725 | 322 - 335.4 | 3600 - 4400 | |
| 13.36 - 13.41 | | | |

| Frequency (MHz) | Quasi-peak(μV/m) | Measurement distance(m) | Quasi-peak(dBμV/m)@distance 3m |
|-----------------|------------------|-------------------------|--------------------------------|
| 0.009-0.490 | 2400/F(kHz) | 300 | 128.5~93.8 |
| 0.490-1.705 | 24000/F(kHz) | 30 | 73.8~63 |
| 1.705-30.0 | 30 | 30 | 69.5 |
| 30 ~ 88 | 100 | 3 | 40 |
| 88~216 | 150 | 3 | 43.5 |
| 216 ~ 960 | 200 | 3 | 46 |
| Above 960 | 500 | 3 | 54 |

13.2 TEST PROCEDURES

- 1) The EUT is placed on a turntable, which is 1.5m above the ground plane.
- 2) The turntable shall be rotated for 360 degrees to determine the position of maximum emission level.
- 3) EUT is set 3m away from the receiving antenna, which is varied from 1m to 4m to find out the highest emission.
- 4) Set the spectrum analyzer in the following setting in order to capture the lower and upper band-edges of the emission:
 - a) PEAK: RBW=1MHz / VBW=1MHz / Sweep=AUTO.
 - b) AVERAGE: RBW=1MHz / VBW=1/T / Sweep=AUTO. Where T is defined in section 2.7.
- 5) Repeat the procedures until all the PEAK and AVERAGE versus polarization are measured.

13.3 TEST SETUP

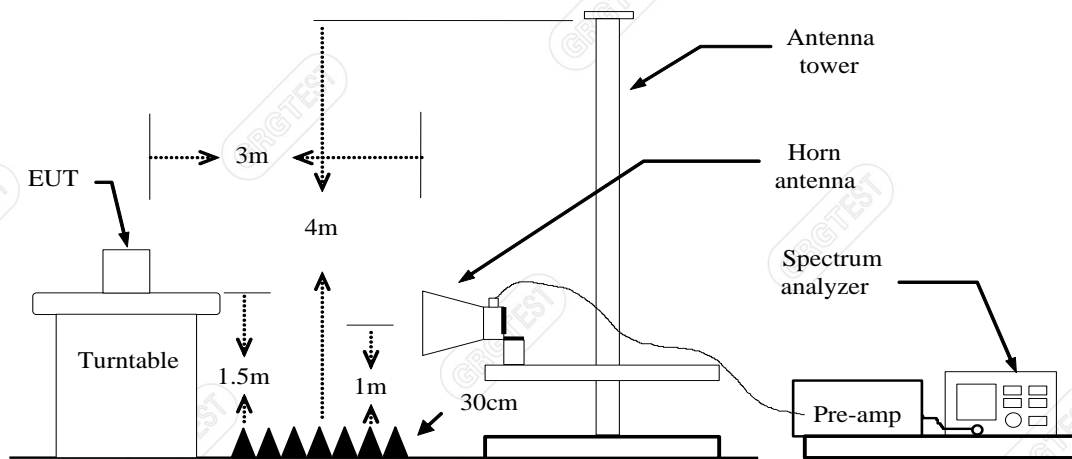

—Blank space below this page—

13.4 TEST RESULTS

| | | | |
|---------------|----------------------|--------------------------|-----------------------|
| Product | Donner OURA Piano | Model No. | R300 |
| Test Voltage: | AC 120V/60Hz | Test Engineer: | Jiang tao |
| Test Date | 2024-10-26 | Environmental Conditions | 25.3°C/54%RH/101.0kPa |
| Sample No: | E20240827121501-0002 | / | / |

Note: Pre-scan all modes, only the worst case(DH5 & 3DH5) test results were recorded in this report.

DH5

Lowest Channel

Frequency 2402MHz

Detector mode: Peak

Polarity: Horizontal

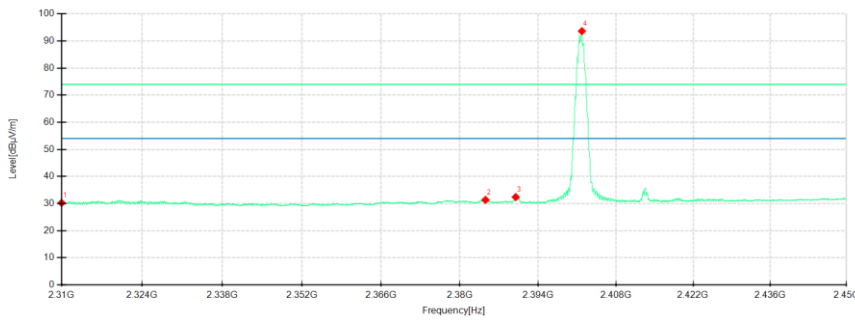

Detector mode: Peak

Polarity: Vertical

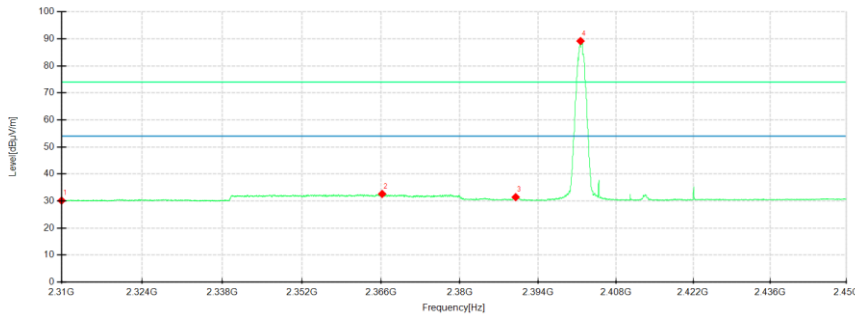

| No. | Frequency MHz | Reading dBμV/m | Level dBμV/m | Factor dB | Limit dBμV/m | Margin dB | Height cm | Angle ° | Pole | Remark |
|-----|---------------|----------------|--------------|-----------|--------------|-----------|-----------|---------|------------|----------|
| 1 | 2310.0000 | 36.14 | 30.24 | -5.90 | 74.00 | 43.76 | 200 | 28 | Horizontal | / |
| 2 | 2384.5850 | 37.16 | 31.34 | -5.82 | 74.00 | 42.66 | 200 | 293 | Horizontal | / |
| 3 | 2390.0000 | 38.11 | 32.38 | -5.73 | 74.00 | 41.62 | 200 | 284 | Horizontal | / |
| 4 | 2401.8925 | 99.13 | 93.61 | -5.52 | 74.00 | -19.61 | 200 | 85 | Horizontal | No limit |
| 1 | 2310.0000 | 35.45 | 30.15 | -5.30 | 74.00 | 43.85 | 100 | 251 | Vertical | / |
| 2 | 2366.1925 | 38.01 | 32.61 | -5.40 | 74.00 | 41.39 | 100 | 140 | Vertical | / |
| 3 | 2390.0000 | 36.88 | 31.43 | -5.45 | 74.00 | 42.57 | 100 | 140 | Vertical | / |
| 4 | 2401.6475 | 94.63 | 89.16 | -5.47 | 74.00 | -15.16 | 100 | 251 | Vertical | No limit |

Lowest Channel

Frequency 2402MHz

Detector mode: Average

Polarity: Horizontal

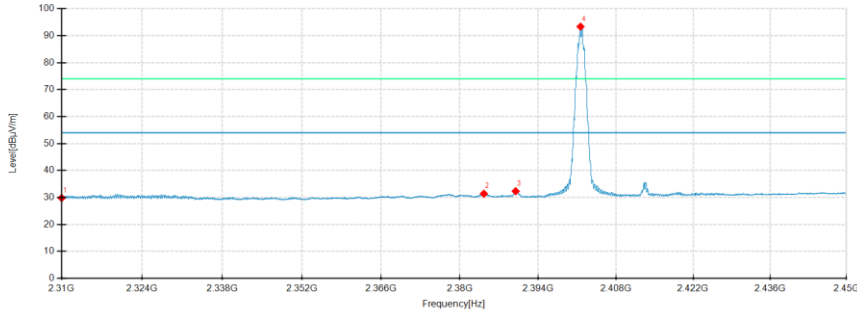

Detector mode: Average

Polarity: Vertical

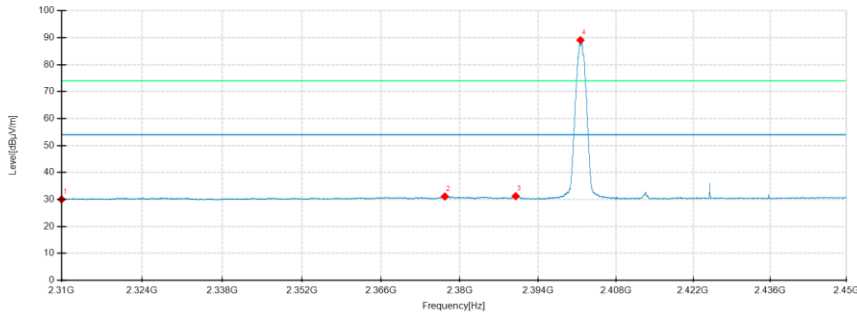

| No. | Frequency MHz | Reading dBμV/m | Level dBμV/m | Factor dB | Limit dBuV/m | Margin dB | Height cm | Angle ° | Pole | Remark |
|-----|---------------|----------------|--------------|-----------|--------------|-----------|-----------|---------|------------|----------|
| 1 | 2310.0000 | 35.69 | 29.79 | -5.90 | 54.00 | 24.21 | 200 | 191 | Horizontal | / |
| 2 | 2384.3050 | 37.21 | 31.39 | -5.82 | 54.00 | 22.61 | 200 | 205 | Horizontal | / |
| 3 | 2390.0000 | 38.05 | 32.32 | -5.73 | 54.00 | 21.68 | 200 | 205 | Horizontal | / |
| 4 | 2401.6475 | 98.90 | 93.36 | -5.54 | 54.00 | -39.36 | 200 | 205 | Horizontal | No limit |
| 1 | 2310.0000 | 35.31 | 30.01 | -5.30 | 54.00 | 23.99 | 100 | 204 | Vertical | / |
| 2 | 2377.3400 | 36.52 | 31.10 | -5.42 | 54.00 | 22.90 | 100 | 141 | Vertical | / |
| 3 | 2390.0000 | 36.67 | 31.22 | -5.45 | 54.00 | 22.78 | 100 | 253 | Vertical | / |
| 4 | 2401.6300 | 94.55 | 89.08 | -5.47 | 54.00 | -35.08 | 100 | 253 | Vertical | No limit |

DH5

Highest Channel

Frequency 2480MHz

Detector mode: Peak

Polarity: Horizontal

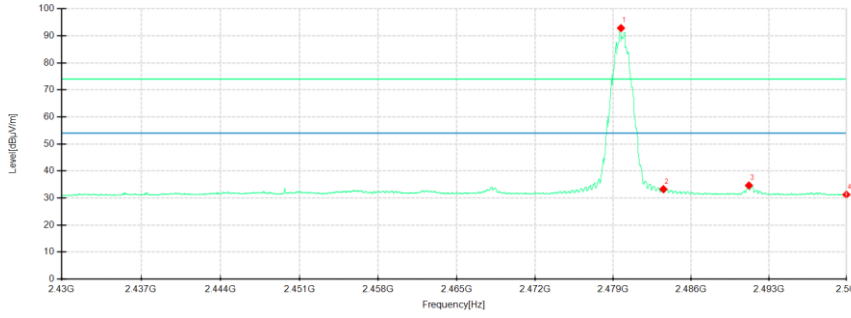

Detector mode: Peak

Polarity: Vertical

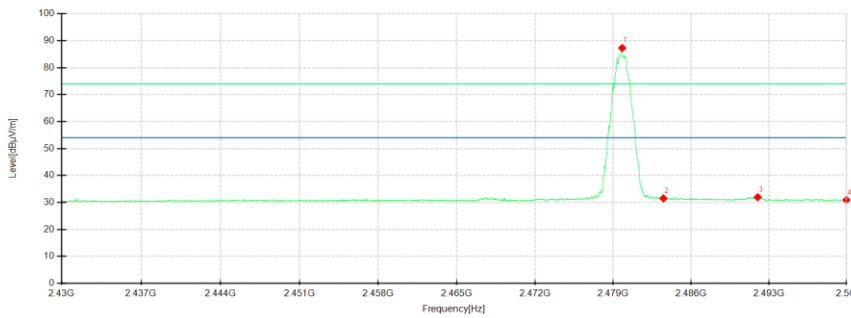

| No. | Frequency MHz | Reading dBµV/m | Level dBµV/m | Factor dB | Limit dBµV/m | Margin dB | Height cm | Angle ° | Pole | Remark |
|-----|---------------|----------------|--------------|-----------|--------------|-----------|-----------|---------|------------|----------|
| 1 | 2479.6913 | 97.49 | 92.84 | -4.65 | 74.00 | -18.84 | 200 | 198 | Horizontal | No limit |
| 2 | 2483.5000 | 37.93 | 33.26 | -4.67 | 74.00 | 40.74 | 200 | 212 | Horizontal | / |
| 3 | 2491.1975 | 39.37 | 34.64 | -4.73 | 74.00 | 39.36 | 200 | 212 | Horizontal | / |
| 4 | 2500.0000 | 36.02 | 31.23 | -4.79 | 74.00 | 42.77 | 200 | 212 | Horizontal | / |
| 1 | 2479.7963 | 92.43 | 87.28 | -5.15 | 74.00 | -13.28 | 100 | 260 | Vertical | No limit |
| 2 | 2483.5000 | 36.64 | 31.51 | -5.13 | 74.00 | 42.49 | 100 | 260 | Vertical | / |
| 3 | 2491.9850 | 37.08 | 31.96 | -5.12 | 74.00 | 42.04 | 200 | 211 | Vertical | / |
| 4 | 2500.0000 | 36.01 | 30.92 | -5.09 | 74.00 | 43.08 | 100 | 45 | Vertical | / |

Highest Channel

Frequency 2480MHz

Detector mode: Average

Polarity: Horizontal

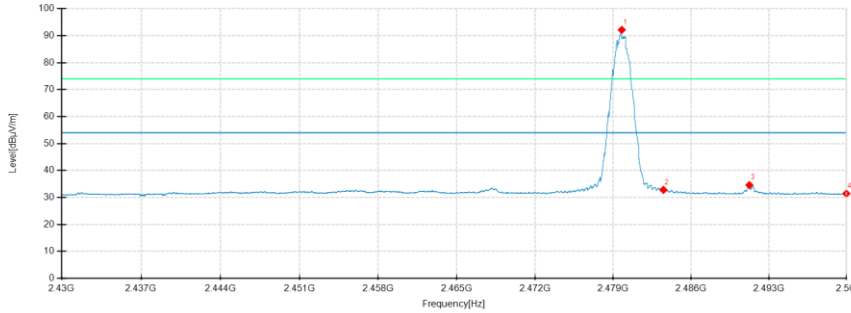

Detector mode: Average

Polarity: Vertical

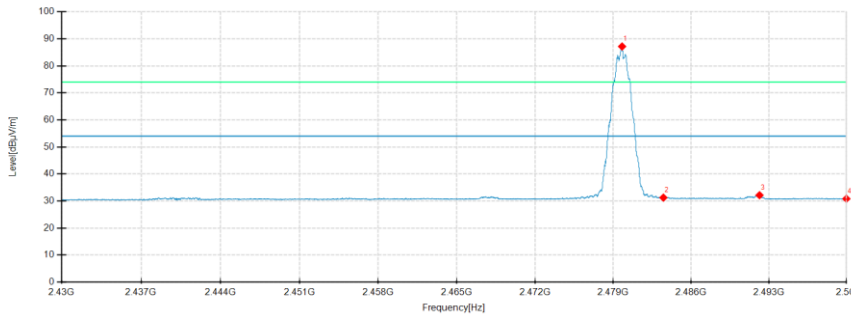

| No. | Frequency MHz | Reading dBµV/m | Level dBµV/m | Factor dB | Limit dBµV/m | Margin dB | Height cm | Angle ° | Pole | Remark |
|-----|---------------|----------------|--------------|-----------|--------------|-----------|-----------|---------|------------|----------|
| 1 | 2479.7613 | 96.80 | 92.15 | -4.65 | 54.00 | -38.15 | 200 | 206 | Horizontal | No limit |
| 2 | 2483.5000 | 37.47 | 32.80 | -4.67 | 54.00 | 21.20 | 200 | 206 | Horizontal | / |
| 3 | 2491.2413 | 39.32 | 34.59 | -4.73 | 54.00 | 19.41 | 200 | 206 | Horizontal | / |
| 4 | 2500.0000 | 36.21 | 31.42 | -4.79 | 54.00 | 22.58 | 200 | 206 | Horizontal | / |
| 1 | 2479.7875 | 92.31 | 87.16 | -5.15 | 54.00 | -33.16 | 100 | 257 | Vertical | No limit |
| 2 | 2483.5000 | 36.37 | 31.24 | -5.13 | 54.00 | 22.76 | 100 | 257 | Vertical | / |
| 3 | 2492.1513 | 37.26 | 32.14 | -5.12 | 54.00 | 21.86 | 200 | 227 | Vertical | / |
| 4 | 2500.0000 | 35.92 | 30.83 | -5.09 | 54.00 | 23.17 | 100 | 218 | Vertical | / |

3DH5

Lowest Channel

Frequency 2402MHz

Detector mode: Peak

Polarity: Horizontal

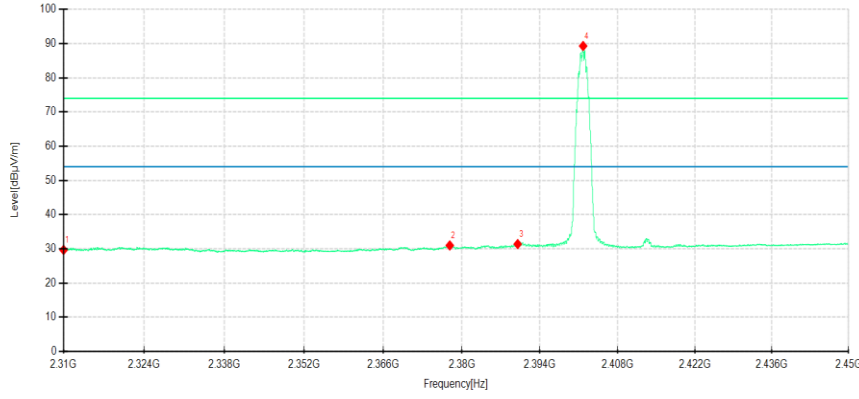

Detector mode: Peak

Polarity: Vertical

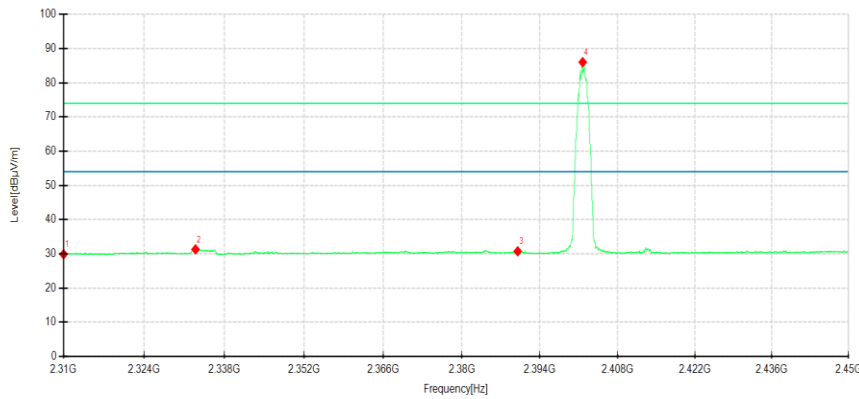

| No. | Frequency MHz | Reading dBµV/m | Level dBµV/m | Factor dB | Limit dBµV/m | Margin dB | Height cm | Angle ° | Pole | Remark |
|-----|---------------|----------------|--------------|-----------|--------------|-----------|-----------|---------|------------|----------|
| 1 | 2310.0000 | 35.57 | 29.67 | -5.90 | 74.00 | 44.33 | 100 | 240 | Horizontal | / |
| 2 | 2377.8650 | 36.90 | 30.98 | -5.92 | 74.00 | 43.02 | 200 | 250 | Horizontal | / |
| 3 | 2390.0000 | 37.11 | 31.38 | -5.73 | 74.00 | 42.62 | 200 | 250 | Horizontal | / |
| 4 | 2401.7525 | 94.80 | 89.27 | -5.53 | 74.00 | -15.27 | 100 | 201 | Horizontal | No limit |
| 1 | 2310.0000 | 35.16 | 29.86 | -5.30 | 74.00 | 44.14 | 100 | 273 | Vertical | / |
| 2 | 2332.9600 | 36.64 | 31.30 | -5.34 | 74.00 | 42.70 | 100 | 132 | Vertical | / |
| 3 | 2390.0000 | 36.19 | 30.74 | -5.45 | 74.00 | 43.26 | 200 | 138 | Vertical | / |
| 4 | 2401.6825 | 91.49 | 86.02 | -5.47 | 74.00 | -12.02 | 200 | 138 | Vertical | No limit |

Lowest Channel

Frequency 2402MHz

Detector mode: Average

Polarity: Horizontal

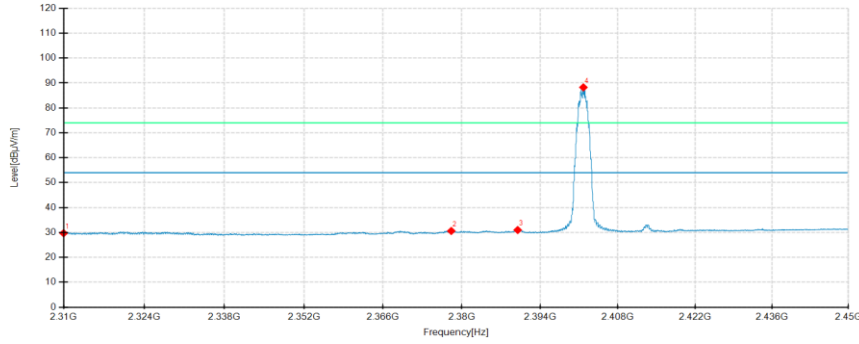

Detector mode: Average

Polarity: Vertical

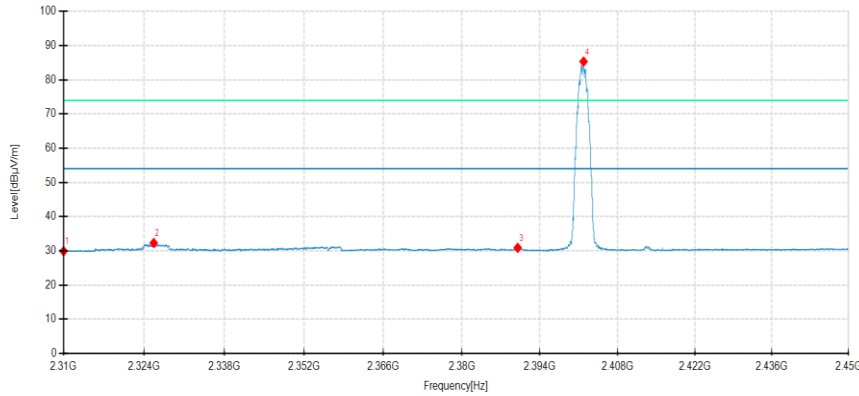

| No. | Frequency MHz | Reading dB μ V/m | Level dB μ V/m | Factor dB | Limit dB μ V/m | Margin dB | Height cm | Angle ° | Pole | Remark |
|-----|---------------|----------------------|--------------------|-----------|--------------------|-----------|-----------|---------|------------|----------|
| 1 | 2310.0000 | 35.59 | 29.69 | -5.90 | 54.00 | 24.31 | 100 | 226 | Horizontal | / |
| 2 | 2378.1275 | 36.52 | 30.60 | -5.92 | 54.00 | 23.40 | 200 | 170 | Horizontal | / |
| 3 | 2390.0000 | 36.70 | 30.97 | -5.73 | 54.00 | 23.03 | 100 | 239 | Horizontal | / |
| 4 | 2401.8050 | 93.78 | 88.26 | -5.52 | 54.00 | -34.26 | 100 | 200 | Horizontal | No limit |
| 1 | 2310.0000 | 35.18 | 29.88 | -5.30 | 54.00 | 24.12 | 200 | 126 | Vertical | / |
| 2 | 2325.6625 | 37.60 | 32.28 | -5.32 | 54.00 | 21.72 | 100 | 146 | Vertical | / |
| 3 | 2390.0000 | 36.31 | 30.86 | -5.45 | 54.00 | 23.14 | 100 | 134 | Vertical | / |
| 4 | 2401.8400 | 90.77 | 85.31 | -5.46 | 54.00 | -31.31 | 200 | 126 | Vertical | No limit |

3DH5

Highest Channel

Frequency 2480MHz

Detector mode: Peak

Polarity: Horizontal

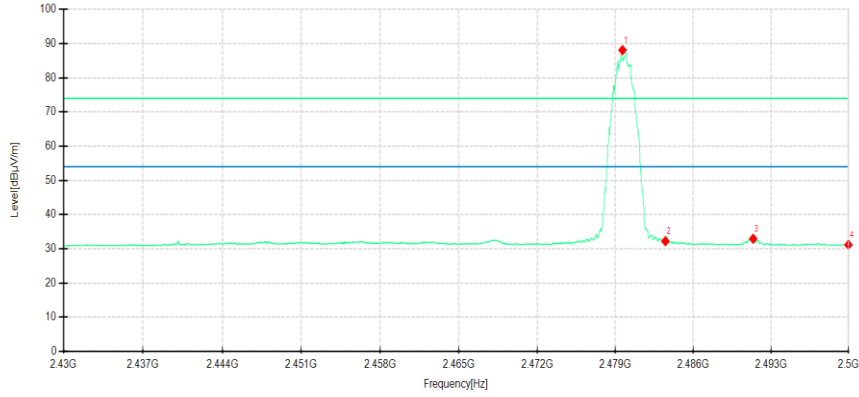

Detector mode: Peak

Polarity: Vertical

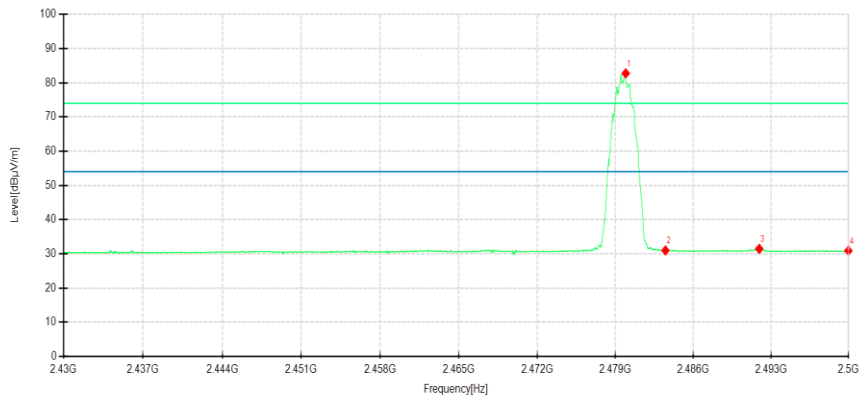

| No. | Frequency MHz | Reading dBμV/m | Level dBμV/m | Factor dB | Limit dBuV/m | Margin dB | Height cm | Angle ° | Pole | Remark |
|-----|---------------|----------------|--------------|-----------|--------------|-----------|-----------|---------|------------|----------|
| 1 | 2479.6475 | 92.73 | 88.08 | -4.65 | 74.00 | -14.08 | 200 | 210 | Horizontal | No limit |
| 2 | 2483.5000 | 36.89 | 32.22 | -4.67 | 74.00 | 41.78 | 200 | 210 | Horizontal | / |
| 3 | 2491.3988 | 37.66 | 32.93 | -4.73 | 74.00 | 41.07 | 200 | 210 | Horizontal | / |
| 4 | 2500.0000 | 35.96 | 31.17 | -4.79 | 74.00 | 42.83 | 200 | 233 | Horizontal | / |
| 1 | 2479.9363 | 87.90 | 82.75 | -5.15 | 74.00 | -8.75 | 100 | 261 | Vertical | No limit |
| 2 | 2483.5000 | 36.11 | 30.98 | -5.13 | 74.00 | 43.02 | 100 | 298 | Vertical | / |
| 3 | 2491.9500 | 36.57 | 31.45 | -5.12 | 74.00 | 42.55 | 200 | 227 | Vertical | / |
| 4 | 2500.0000 | 35.98 | 30.89 | -5.09 | 74.00 | 43.11 | 100 | 298 | Vertical | / |

Highest Channel

Frequency 2480MHz

Detector mode: Average

Polarity: Horizontal

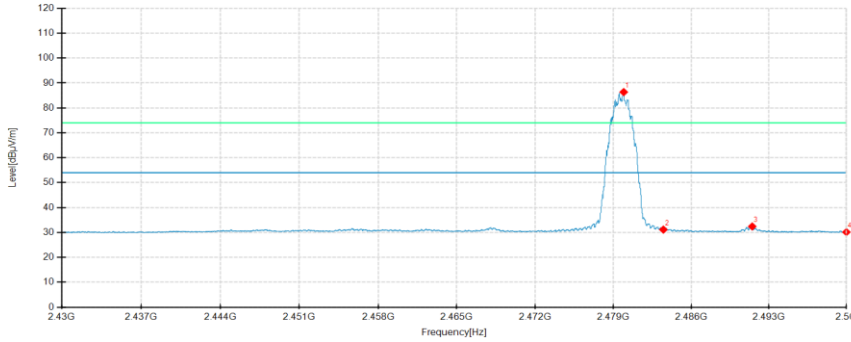

Detector mode: Average

Polarity: Vertical

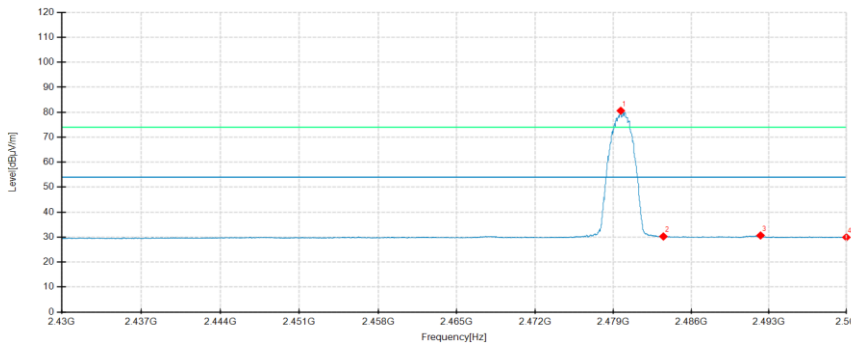

| No. | Frequency MHz | Reading dBµV/m | Level dBµV/m | Factor dB | Limit dBµV/m | Margin dB | Height cm | Angle ° | Pole | Remark |
|-----|---------------|----------------|--------------|-----------|--------------|-----------|-----------|---------|------------|----------|
| 1 | 2479.9363 | 91.03 | 86.38 | -4.65 | 54.00 | -32.38 | 200 | 208 | Horizontal | No limit |
| 2 | 2483.5000 | 35.81 | 31.14 | -4.67 | 54.00 | 22.86 | 100 | 240 | Horizontal | / |
| 3 | 2491.4950 | 37.14 | 32.41 | -4.73 | 54.00 | 21.59 | 200 | 208 | Horizontal | / |
| 4 | 2500.0000 | 34.93 | 30.14 | -4.79 | 54.00 | 23.86 | 100 | 289 | Horizontal | / |
| 1 | 2479.6738 | 85.76 | 80.61 | -5.15 | 54.00 | -26.61 | 100 | 259 | Vertical | No limit |
| 2 | 2483.5000 | 35.38 | 30.25 | -5.13 | 54.00 | 23.75 | 100 | 259 | Vertical | / |
| 3 | 2492.2475 | 35.78 | 30.66 | -5.12 | 54.00 | 23.34 | 200 | 228 | Vertical | / |
| 4 | 2500.0000 | 35.01 | 29.92 | -5.09 | 54.00 | 24.08 | 200 | 266 | Vertical | / |

Remark: Max field strength in 3m distance. No any other emission which falls in restricted bands can be detected and be reported.

14. CONDUCTED EMISSION

14.1 LIMITS

| Frequency range | Limits (dB μ V) | |
|-----------------|---------------------|---------|
| | Quasi-peak | Average |
| 150kHz~0.5MHz | 66~56 | 56~46 |
| 0.5MHz~5MHz | 56 | 46 |
| 5MHz~30MHz | 60 | 50 |

14.2 TEST PROCEDURES

Procedure of Preliminary Test

For measurement of the disturbance voltage the equipment under test (EUT) is connected to the power supply mains and any other extended network via one or more artificial network(s). An EUT, whether intended to be grounded or not, and which is to be used on a table is configured as follows:

– Either the bottom or the rear of the EUT shall be at a controlled distance of 40 cm from a reference ground plane. This ground plane is normally the wall or floor of a shielded room. It may also be a grounded metal plane of at least 2 m by 2 m. This is physically accomplished as follows:

1) Place the EUT on a table of non-conducting material which is at least 80 cm high. Place the EUT so that it is 40 cm from the wall of the shielded room, or

2) place the EUT on a table of non-conducting material which is 40 cm high so that the bottom of the EUT is 40 cm above the ground plane;

– All other conductive surfaces of the EUT shall be at least 80 cm from the reference ground plane;

– The EUT are placed on the floor that one side of the housings is 40 cm from the vertical reference ground plane and other metallic parts;

– Interconnecting cables that hang closer than 40 cm to the ground plane shall be folded back and forth forming a bundle 30 cm to 40 cm long, hanging approximately in the middle between the ground plane and the table.

– I/O cables that are connected to a peripheral shall be bundled in the centre. The end of the cable may be terminated if required using correct terminating impedance. The total length shall not exceed 1 m.

The test mode(s) described in Item 2.5 were scanned during the preliminary test. After the preliminary scan, we found the test mode described in Item 2.5 producing the highest emission level. The EUT configuration and cable configuration of the above highest emission levels were recorded for reference of the final test.

Procedure of Final Test

EUT and support equipment were set up on the test bench as per the configuration with highest emission level in the preliminary test. A scan was taken on both power lines, recording at least the six highest emissions.

Emission frequency and amplitude were recorded into a computer in which correction factors were used to calculate the emission level and compare reading to the applicable limit. The test data of the worst-case condition(s) was recorded.

14.3 TEST SETUP

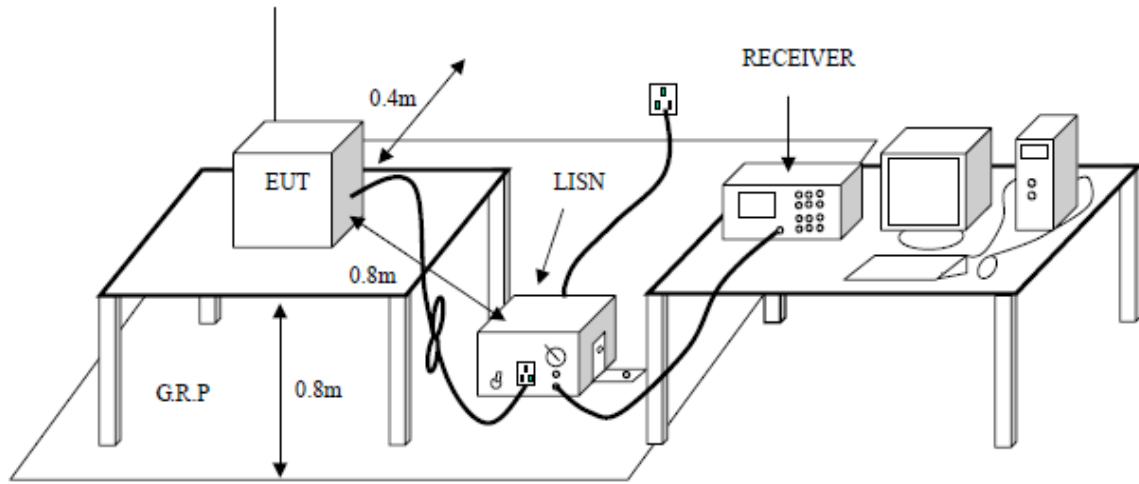

14.4 DATA SAMPLE

| Frequency (MHz) | QuasiPeak Reading (dBuV) | Average Reading (dBuV) | Correction Factor (dB) | QuasiPeak Result (dBuV) | Average Result (dBuV) | QuasiPeak Limit (dBuV) | Average Limit (dBuV) | QuasiPeak Margin (dB) | Average Margin (dB) | Remark (Pass/Fail) |
|-----------------|--------------------------|------------------------|------------------------|-------------------------|-----------------------|------------------------|----------------------|-----------------------|---------------------|--------------------|
| X.XXXX | 32.69 | 25.65 | 11.52 | 44.21 | 37.17 | 65.78 | 55.79 | -21.57 | -18.62 | Pass |

- Factor = Insertion loss of LISN + Cable Loss
- Result = Quasi-peak Reading/ Average Reading + Factor
- Limit = Limit stated in standard
- Margin = Result (dBuV) – Limit (dBuV)

—Blank space below this page—

14.5 TEST RESULTS

Note: Pre-scan all test mode, recorded the worst case (TX_3DH5_2402MHz) test results in the report.

| | | | |
|---------------------------------|-----------------------|---------------------|----------------------|
| Product | Donner OURA Piano | Model No. | R300 |
| Environmental Conditions | 25.1°C/45%RH/101.0kPa | Test Voltage | AC 120V/60Hz |
| Tested By | Wen wenwen | Line | L |
| Tested Date | 2024-10-11 | Sample No: | E20240827121501-0002 |

(The chart below shows the highest readings taken from the final data.)

REMARKS: L = Live Line

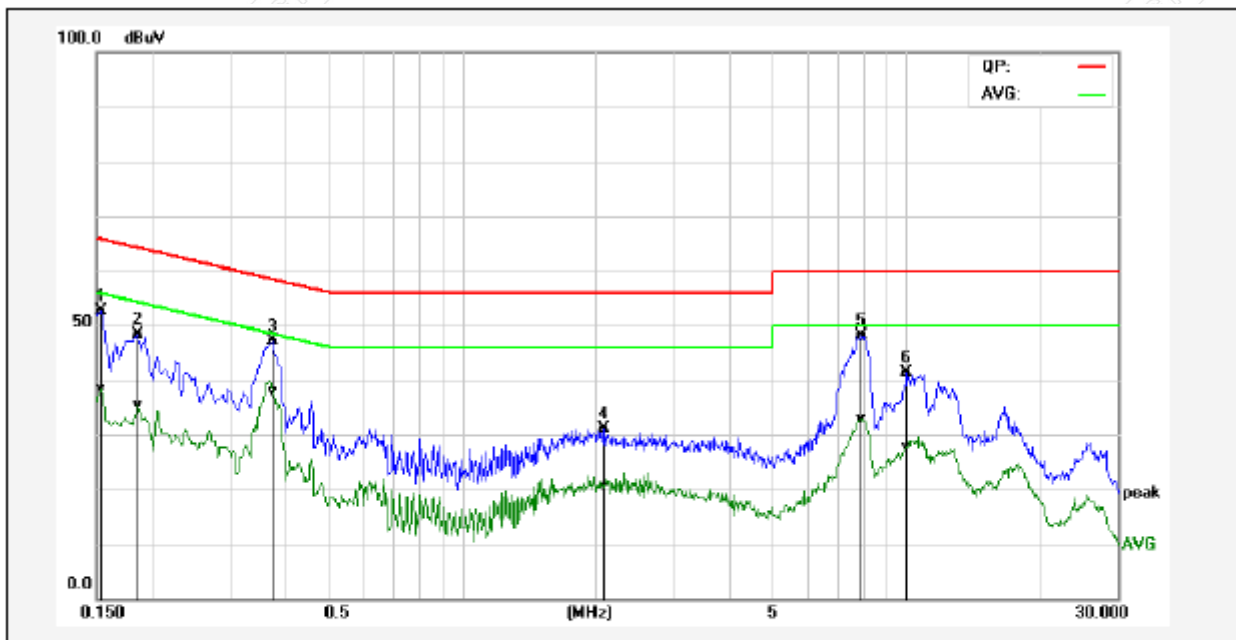

| No. | Frequency (MHz) | QuasiPeak reading (dBuV) | Average reading (dBuV) | Correction factor (dB) | QuasiPeak result (dBuV) | Average result (dBuV) | QuasiPeak limit (dBuV) | Average limit (dBuV) | QuasiPeak margin (dB) | Average margin (dB) | Remark |
|-----|-----------------|--------------------------|------------------------|------------------------|-------------------------|-----------------------|------------------------|----------------------|-----------------------|---------------------|--------|
| 1 | 0.1539 | 42.92 | 28.63 | 9.79 | 52.71 | 38.42 | 65.78 | 55.79 | -13.07 | -17.37 | Pass |
| 2 | 0.1860 | 38.70 | 25.81 | 9.65 | 48.35 | 35.46 | 64.21 | 54.21 | -15.86 | -18.75 | Pass |
| 3* | 0.3740 | 37.51 | 28.11 | 9.73 | 47.24 | 37.84 | 58.41 | 48.41 | -11.17 | -10.57 | Pass |
| 4 | 2.0940 | 21.27 | 10.81 | 9.80 | 31.07 | 20.61 | 56.00 | 46.00 | -24.93 | -25.39 | Pass |
| 5 | 7.9380 | 38.34 | 23.02 | 9.82 | 48.16 | 32.84 | 60.00 | 50.00 | -11.84 | -17.16 | Pass |
| 6 | 10.0659 | 31.36 | 17.75 | 9.90 | 41.26 | 27.65 | 60.00 | 50.00 | -18.74 | -22.35 | Pass |

| | | | |
|---------------------------------|-----------------------|---------------------|----------------------|
| Product | Donner OURA Piano | Model No. | R300 |
| Environmental Conditions | 25.1°C/45%RH/101.0kPa | Test Voltage | AC 120V/60Hz |
| Tested By | Wen wenwen | Line | N |
| Tested Date | 2024-10-11 | Sample No: | E20240827121501-0002 |

(The chart below shows the highest readings taken from the final data.)

REMARKS: N = Neutral Line.

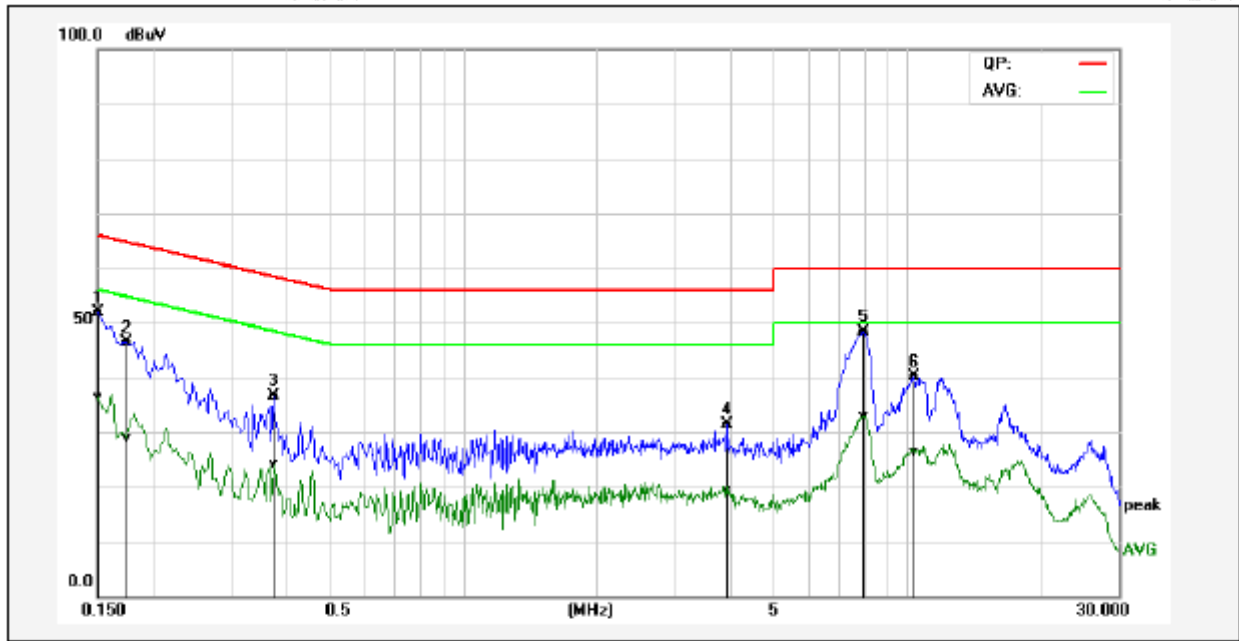

| No. | Frequency (MHz) | QuasiPeak reading (dBuV) | Average reading (dBuV) | Correction factor (dB) | QuasiPeak result (dBuV) | Average result (dBuV) | QuasiPeak limit (dBuV) | Average limit (dBuV) | QuasiPeak margin (dB) | Average margin (dB) | Remark |
|-----|-----------------|--------------------------|------------------------|------------------------|-------------------------|-----------------------|------------------------|----------------------|-----------------------|---------------------|--------|
| 1 | 0.1500 | 42.10 | 26.68 | 9.71 | 51.81 | 36.39 | 65.99 | 56.00 | -14.18 | -19.61 | Pass |
| 2 | 0.1740 | 36.83 | 19.34 | 9.61 | 46.44 | 28.95 | 64.76 | 54.77 | -18.32 | -25.82 | Pass |
| 3 | 0.3740 | 26.93 | 14.57 | 9.62 | 36.55 | 24.19 | 58.41 | 48.41 | -21.86 | -24.22 | Pass |
| 4 | 3.9620 | 21.71 | 9.53 | 9.73 | 31.44 | 19.26 | 56.00 | 46.00 | -24.56 | -26.74 | Pass |
| 5* | 7.9820 | 38.52 | 23.13 | 9.87 | 48.39 | 33.00 | 60.00 | 50.00 | -11.61 | -17.00 | Pass |
| 6 | 10.3780 | 30.28 | 16.48 | 9.88 | 40.16 | 26.36 | 60.00 | 50.00 | -19.84 | -23.64 | Pass |

APPENDIX A. PHOTOGRAPH OF THE TEST CONNECTION DIAGRAM

Please refer to the attached document E20240827121501-Test Photo-FCC&IC.

APPENDIX B. PHOTOGRAPH OF THE EUT

Please refer to the attached document E20240827121501-EUT photo.

----- End of Report -----