

FCC TEST REPORT

Report No. : NTC-ER2202032
Applicant's name : GUANGZHOU RANTION TECHNOLOGY CO., LTD.
Address : Room 432, Building 4, No. 50 Nanxiang 1st Road,
Huangpu District, Guangzhou, China.

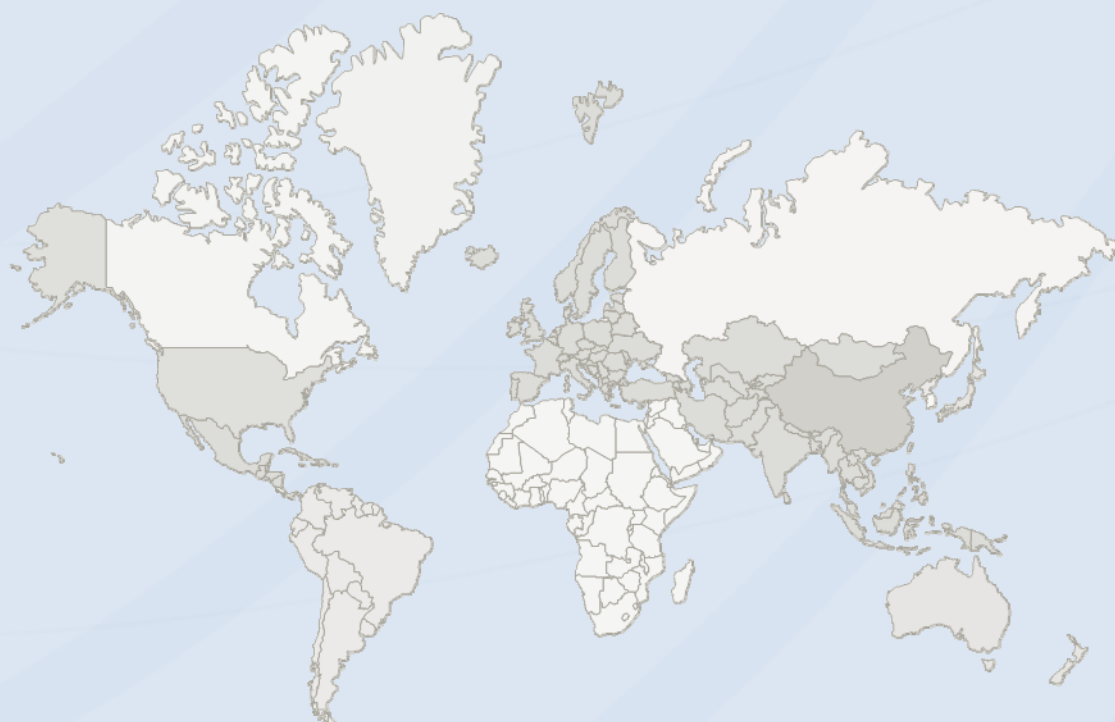

DONGGUAN NEW TESTING CENTRE CO., LTD

Ⓞ Address: 3F, No. 1 the 1st North Industry Road, Songshan Lake Science & Technology Park, Dongguan, Guangdong, China, 523808

☎ Tel: +86-769-22212079

🌐 Web: <http://www.ntc-cert.com>

✉ E-mail: dave@ntc-cert.com

TABLE OF CONTENTS

Test Report Declare	3
1. Summary of test results	5
2. General test information	5
2.1. Description of EUT	5
2.2. Detail models.....	6
2.3. Block diagram EUT configuration for test	6
2.4. Test environment conditions	7
2.5. Measurement uncertainty	8
2.6. Test Peripheral List.....	8
3. Power Line Conducted Emission Test	9
3.1. Test equipment	9
3.2. Block diagram of test setup.....	9
3.3. Power Line Conducted Emission Limits (Class B)	9
3.4. Test Procedure.....	10
3.5. Test Result.....	10
4. Radiated emission test.....	13
4.1. Test equipment	13
4.2. Block diagram of test setup.....	14
4.3. Limit	16
4.4. Test Procedure.....	17
4.5. Test result	17
5. Maximum Peak Output Power	24
5.1. Applied procedures / Limit.....	24
5.2. Test procedure	24
5.3. Deviation from standard.....	24
5.4. Test setup	24
5.5. TEST RESULTS	24
6. BANDWIDTH TEST	31
6.1. Applied procedures / Limit.....	31
6.2. Test procedure	31
6.3. Deviation from standard.....	31
6.4. Test setup	31
6.5. Test results	31

7.	Carrier Frequencies Separated	38
7.1.	Applied procedures / Limit.....	38
7.2.	Test procedure	38
7.3.	Deviation from standard.....	38
7.4.	Test setup	38
7.5.	Test results	38
8.	Hopping Channel Number.....	45
8.1.	Applied procedures / Limit.....	45
8.2.	Test procedure	45
8.3.	Deviation from standard.....	45
8.4.	Test setup	45
8.5.	Test result	45
9.	Dwell time	53
9.1.	Applied procedures / Limit.....	53
9.2.	Test procedure	53
9.3.	Deviation from standard.....	53
9.4.	Test setup	53
9.5.	Test result	54
10.	Band edge.....	59
10.1.	Applied procedures / Limit.....	59
10.2.	Test procedure	59
10.3.	Deviation from standard.....	59
10.4.	Test setup	59
10.5.	Test results	59
11.	Conducted Spurious Emissions.....	66
11.1.	Applied procedures / Limit.....	66
11.2.	Test procedure	66
11.3.	Deviation from standard.....	66
11.4.	Test setup	66
11.5.	Test results	66
12.	Antenna Requirement.....	77
12.1.	Standard requirement	77
12.2.	EUT Antenna	77
13.	Test setup photograph	78
14.	Photos of the EUT	80

TEST REPORT DECLARE

FCC ID	:	2AV7N-DDA35
Equipment under Test	:	Electric Drum Amplifier
Model /Type	:	DDA 35
Listed Models	:	Donner DA-35, EC1292, Donner DDA 35, DA-35
Trade Mark	:	DONNER
Applicant	:	GUANGZHOU RANTION TECHNOLOGY CO., LTD.
Address	:	Room 432, Building 4, No. 50 Nanxiang 1st Road, Huangpu District, Guangzhou, China.
Manufacturer	:	SHENZHEN COOLMUSIC TECH CO.,LTD.
Address	:	5F A Building 28th Longteng Road, Henggang Street Longgang District, Shenzhen, China
Test Laboratory	:	Dongguan New Testing Centre Co., Ltd
Address	:	3F, No. 1 the 1st North Industry Road, Songshan Lake Science & Technology Park, Dongguan, Guangdong, China, 523808

Test Standard Used:

FCC Part 15.247: Operation within the bands 902-928 MHz, 2400-2483.5 MHz and 5725-5850 MHz, ANSI C63.10:2020.

We Declare:

The equipment described above is tested by Dongguan New Testing Centre Co., Ltd and in the configuration tested the equipment complied with the standards specified above. The test results are contained in this test report and Dongguan New Testing Centre Co., Ltd is assumed of full responsibility for the accuracy and completeness of these tests.

After test and evaluation, our opinion is that the equipment provided for test compliance with the requirement of the above FCC standards.

Report No.:	NTC-ER2202032		
Date of Test:	Feb.24, 2022 to Mar.07, 2022	Date of Report.:	Mar.07, 2022

Prepared By:



Jack Liu/Engineer



Dave Gao/LAB Manager

Note: This report applies to above tested sample only. This report shall not be reproduced in parts without written approval of Dongguan New Testing Centre Co., Ltd

1. Summary of test results

Description of Test Item	Standard	Results
Antenna Requirement	Section 15.247(c)	PASS
Conduction Emissions	Section 15.207(a)	PASS
Radiated Emissions	Section 15.247(d)	PASS
Carrier Frequencies Separated	Section 15.247(a)(1)	PASS
Hopping Channel Number	Section 15.247(a)(1) (iii)	PASS
Dwell Time	Section 15.247(a)(1) (iii)	PASS
Maximum Peak Output Power	Section 15.247(b)	PASS
Band edge	Section 15.247(d)	PASS
Conducted Spurious Emissions	Section 15.247(d)	PASS

2. General test information

2.1. Description of EUT

Product Name:	Electric Drum Amplifier
Model/Type reference:	DDA 35
Power supply:	AC 120V 60Hz
Bluetooth :	
Supported type:	Bluetooth BR/EDR
Modulation:	GFSK, $\pi/4$ DQPSK, 8DPSK
Operation frequency:	2402MHz~2480MHz
Channel number:	79
Channel separation:	1MHz
Antenna type:	PCB Antenna
Antenna gain:	-0.58dBi

Note1: For more details, please refer to the user's manual of the EUT.

Note2: Antenna gain provided by the applicant.

2.2. Detail models

Model	Rating	Note
DDA 35	AC 120V 60Hz	N/A

2.3. Block diagram EUT configuration for test

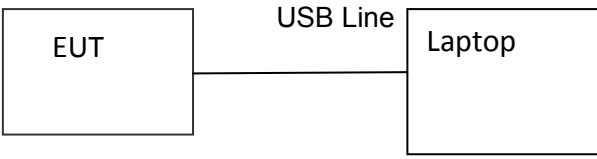
1. Block diagram of EUT configuration (TX Mode)	
 <pre> graph LR EUT[EUT] --- USB[USB Line] --- Laptop[Laptop] </pre>	
<p>Note:</p> <ol style="list-style-type: none"> 1.Connect the EUT as above block diagram of configuration, Run the software, set the transmit serial port/power/channel/packet type/data type/hopping or not, send configuration, than EUT enter the TX mode. 2.Set EUT in continuous transmission signal mode. 3.Using the laptop and the transform board to control the fixed transmitting frequency and other test mode. After finishing the test setting, the notebook and the transform board will be removed during measurements. 	

2.4. Test environment conditions

During the measurement the environmental conditions were within the listed ranges:

(1) E.U.T. test conditions:

15.31(e): For intentional radiators, measurements of the variation of the input power or the radiated signal level of the fundamental frequency component of the emission, as appropriate, shall be performed with the supply voltage varied between 85% and 115% of the nominal rated supply voltage. For battery operated equipment, the equipment tests shall be performed using a new battery.

(2) Test frequencies:

According to the 15.31(m) Measurements on intentional radiators or receivers, other than TV broadcast receivers, shall be performed and. If required reported for each band in which the device can be operated with the device operating at the number of frequencies in each band specified in the following table:

Frequency range over which device operates	Number of frequencies	Location in the range of operation
1 MHz or less	1	Middle
1 to 10 MHz	2	1 near top and 1 near bottom
More than 10 MHz	3	1 near top, 1 near middle and 1 near bottom

(3) Frequency range of radiated measurements:

According to the 15.33, the test range will be up to the tenth harmonic of the highest fundamental frequency.

(4) Pre-test the EUT in all transmitting mode at the lowest (2402 MHz), middle (2441 MHz) and highest (2480 MHz) channel with different data packet and conducted to determine the worst-case mode,

The radiation measurements are performed in X, Y, Z axis positioning. And found the X axis positioning which it is worse case, only the test worst case mode is recorded in the report.

2.5. Measurement uncertainty

Test Item	Uncertainty
Uncertainty for Conduction emission test	2.44dB
Uncertainty for Radiation Emission test (30MHz – 1GHz)	3.14 dB (Polarize: V)
	3.16 dB (Polarize: H)
Uncertainty for Radiation Emission test (1GHz – 18GHz)	4.27 dB (Polarize: V)
	4.51 dB (Polarize: H)
Uncertainty for conducted RF Power	0.63dB
Stop Transmitting Time Test	±0.5%
Uncertainty for frequency error	5.8 x 10 ⁻⁸

Note: This uncertainty represents an expanded uncertainty expressed at approximately the 95% confidence level using a coverage factor of k=2.

2.6. Test Peripheral List

No.	Equipment	Manufacturer	FCC approved	Model No.	Serial No.	signal cable
1	Lap top	lenovo	DOC	7457	7457A82	N/A

3. Power Line Conducted Emission Test

3.1. Test equipment

Item	Equipment	Manufacturer	Model No.	Serial No.	Last Cal.	Cal. Interval
1	Test Receiver	R&S	ESPI	100146	2021-05-21	1 Year
2	LISN	R&S	ENV216	3650.6550.06	2021-05-21	1 Year
3	8-WIRE ISN for CAT6	R&S	ENY81-CA6	101862	2021-05-21	1 Year
4	RF Cable	HUBER	SUCOFLEX100	30722/4E	2021-05-21	2 Year
5	MEASUREMENT SOFTWARE	FARAD	EZ-EMC(VER:1.1.4.2)	N/A	N/A	N/A

3.2. BLOCK DIAGRAM OF TEST SETUP

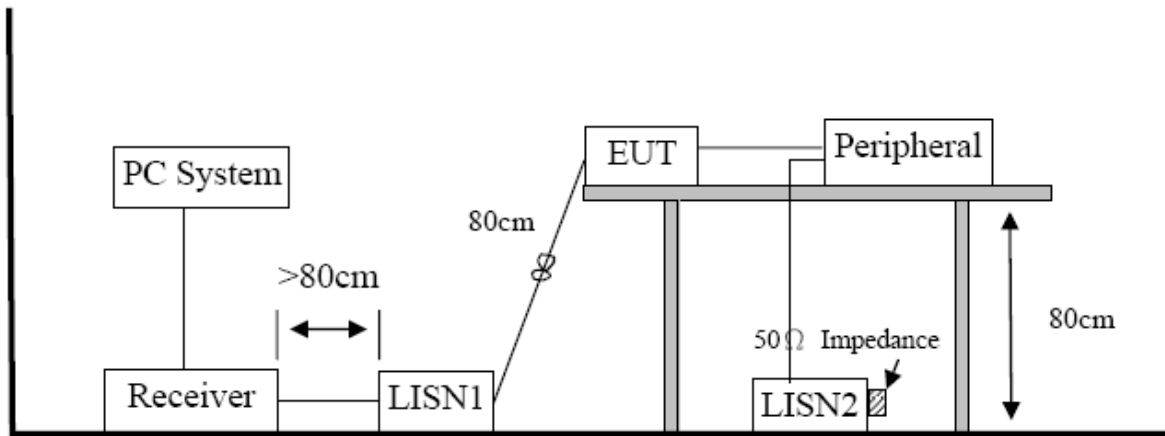

3.3. Power Line Conducted Emission Limits (Class B)

Frequency	Quasi-Peak Level dB(μV)	Average Level dB(μV)
150kHz ~ 500kHz	66 ~ 56*	56 ~ 46*
500kHz ~ 5MHz	56	46
5MHz ~ 30MHz	60	50

Note 1: * Decreasing linearly with logarithm of frequency.

Note 2: The lower limit shall apply at the transition frequencies.

3.4. Test Procedure

The EUT and Support equipment, if needed, were put placed on a non-metallic table, 80cm above the ground plane.

Configuration EUT to simulate typical usage as described in clause 2.3 and test equipment as described in clause 3.2 of this report.

All I/O cables were positioned to simulate typical actual usage as per ANSI C63.10.

All support equipment power received from a second LISN.

Emissions were measured on each current carrying line of the EUT using an EMI Test Receiver connected to the LISN powering the EUT.

The Receiver scanned from 150 kHz to 30MHz for emissions in each of the test modes.

During the above scans, the emissions were maximized by cable manipulation.

The test mode(s) described in clause 2.3 were scanned during the preliminary test.

After the preliminary scan, we found the test mode producing the highest emission level.

The EUT configuration and worse cable configuration of the above highest emission levels were recorded for reference of the final test.

EUT and support equipment were set up on the test bench as per the configuration with highest emission level in the preliminary test.

A scan was taken on both power lines, Neutral and Line, recording at least the six highest emissions. Emission frequency and amplitude were recorded into a computer in which correction factors were used to calculate the emission level and compare reading to the applicable limit.

The test data of the worst-case condition(s) was recorded.

The bandwidth of test receiver is set at 9 KHz.

3.5. Test Result

PASS. (See below detailed test result)

Note1: All emissions not reported below are too low against the prescribed limits.

Note2: "-----" means Peak detection; "-----" means Average detection

Note3: Measurement = Reading Level + Factor, Margin= Measurement-Limit

Note4: All modes of GFSK, Pi/4 DQPSK, and 8DPSK were test at Low, Middle, and High channel; only the worst result of GFSK Middle Channel was reported as below:

Conducted Emission Test Result

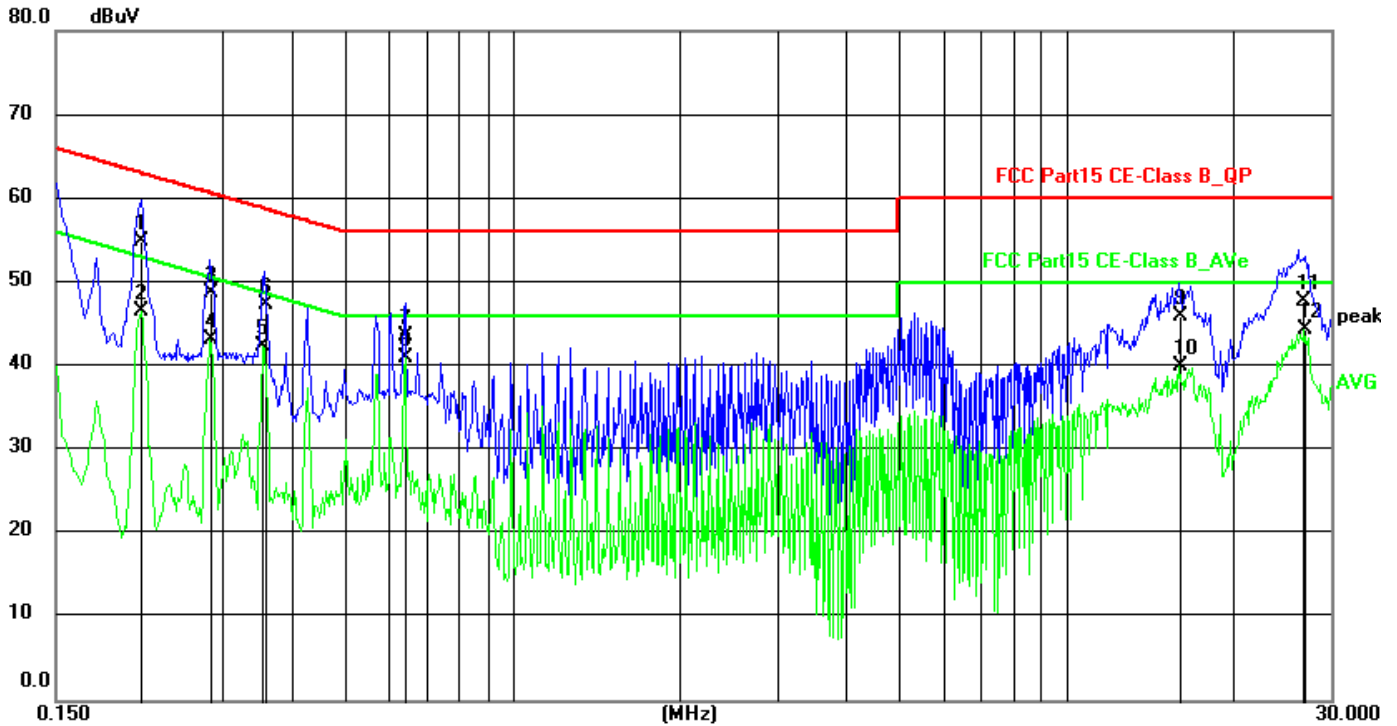

Site:	844 LAB	Phase:	L1
Limit:	FCC Part15 CE-Class B_QP	Temperature(C):	24(C)
EUT:	Electric Drum Amplifier	Humidity(%):	63%
M/N.:	DDA 35	Test Time:	2022/3/3 9:24:45
Mode:	BT	Power Rating:	AC120/60Hz
Note:		Test Engineer:	Taylor Chen

No.	Frequency (MHz)	Reading Level(dBuV)	Factor (dB)	Measure-ment(dBuV)	Limit (dBuV)	Margin (dB)	Detector	Comment
1	0.2139	44.53	10.31	54.84	63.05	-8.21	QP	N/A
2	0.2139	36.22	10.31	46.53	53.05	-6.52	AVG	N/A
3	0.2858	38.31	10.33	48.64	60.65	-12.01	QP	N/A
4	0.2858	32.85	10.33	43.18	50.65	-7.47	AVG	N/A
5	0.3537	32.03	10.35	42.38	48.88	-6.50	AVG	N/A
6	0.3578	36.92	10.35	47.27	58.78	-11.51	QP	N/A
7	0.6419	33.13	10.38	43.51	56.00	-12.49	QP	N/A
8 *	0.6419	30.66	10.38	41.04	46.00	-4.96	AVG	N/A
9	15.9977	35.53	10.47	46.00	60.00	-14.00	QP	N/A
10	15.9977	29.57	10.47	40.04	50.00	-9.96	AVG	N/A
11	26.7300	37.29	10.45	47.74	60.00	-12.26	QP	N/A
12	26.9378	33.84	10.45	44.29	50.00	-5.71	AVG	N/A

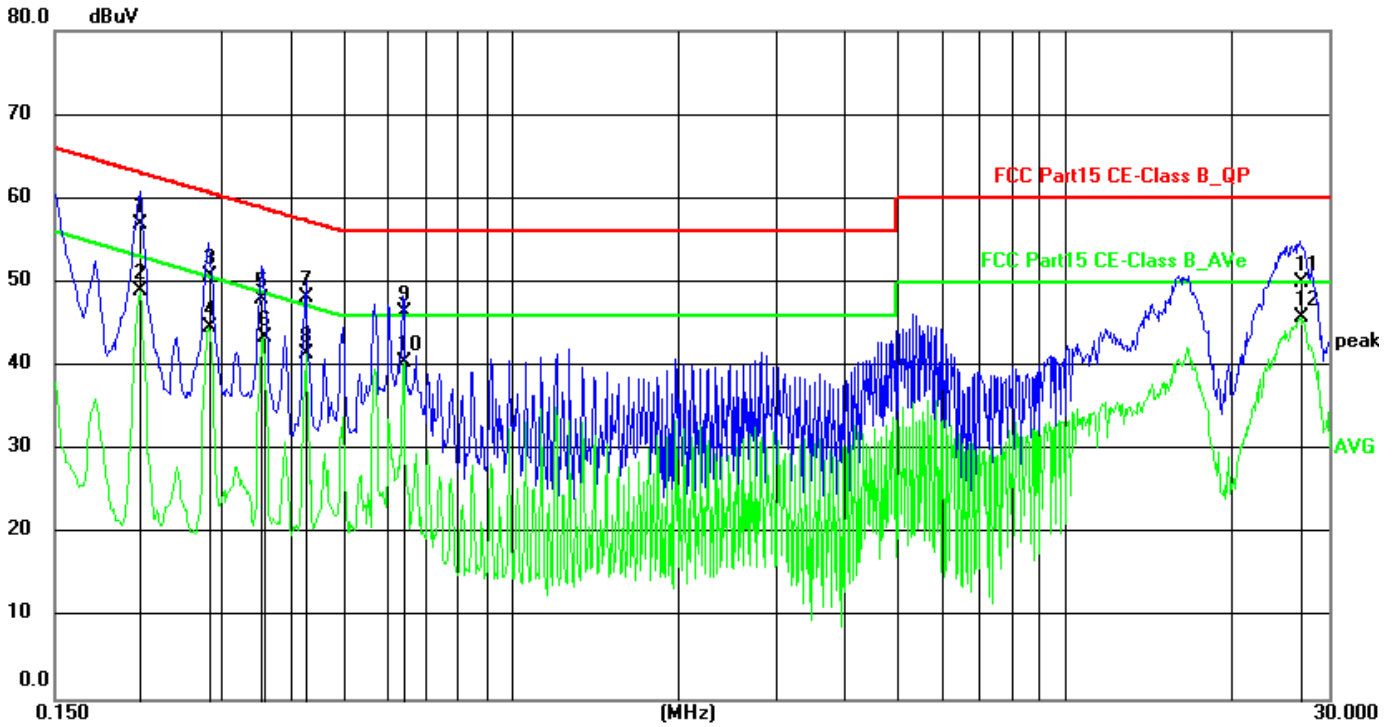

Site:	844 LAB	Phase:	N	Temperature(C):	24(C)
Limit:	FCC Part15 CE-Class B_QP			Humidity(%):	63%
EUT:	Electric Drum Amplifier	Test Time:	2022/3/3 9:28:23		
M/N.:	DDA 35	Power Rating:	AC120/60Hz		
Mode:	BT	Test Engineer:	Taylor Chen		
Note:					

No.	Frequency (MHz)	Reading Level(dBuV)	Factor (dB)	Measurement(dBuV)	Limit (dBuV)	Margin (dB)	Detector	Comment
1	0.2139	47.18	9.63	56.81	63.05	-6.24	QP	N/A
2 *	0.2139	39.25	9.63	48.88	53.05	-4.17	AVG	N/A
3	0.2858	41.06	9.64	50.70	60.65	-9.95	QP	N/A
4	0.2858	34.99	9.64	44.63	50.65	-6.02	AVG	N/A
5	0.3537	38.25	9.65	47.90	58.88	-10.98	QP	N/A
6	0.3578	33.70	9.65	43.35	48.78	-5.43	AVG	N/A
7	0.4259	38.55	9.65	48.20	57.33	-9.13	QP	N/A
8	0.4259	31.76	9.65	41.41	47.33	-5.92	AVG	N/A
9	0.6380	36.65	9.65	46.30	56.00	-9.70	QP	N/A
10	0.6419	30.75	9.65	40.40	46.00	-5.60	AVG	N/A
11	26.6938	39.76	10.11	49.87	60.00	-10.13	QP	N/A
12	26.8380	35.68	10.11	45.79	50.00	-4.21	AVG	N/A

4. Radiated emission test

4.1. Test equipment

Item	Equipment	Manufacturer	Model No.	Serial No.	Last Cal.	Cal. Interval
1	EMI Test Receiver	R&S	ESR	7250-30406 7528	2021-05-21	1Year
2	Trilog Broadband Antenna	Schwarzbeck	VULB9168	00969	2021-05-21	2 Year
3	Horn antenna	Schwarzbeck	BBHA9120D	453	2021-05-21	2Year
4	Pre-amplifier	Agilent	8449B	3008A04721	2021-05-26	1Year
5	Double Ridged Horn Antenna	A.H. System	SAS-574	584	2021-05-21	1Year
6	Active Loop antenna	Schwarzbeck	FMZB-1519	1519-038	2021-05-21	1Year
7	Pre-amplifier	R&S	8447F	3113A04553	2021-05-21	1Year
8	RF Cable	GORE	OSQ01Q010 78.7	SN1545847 3	2021-05-21	2Year
9	RF Cable	ESCO	ETS-LINGR EN	RFC-SMS-1 00-SMS-340 -IN	2021-05-21	2Year
10	Measurement software	Farad	EZ-EMC(VE R:1.1.4.2)	N/A	N/A	N/A

4.2. Block diagram of test setup

In 3m Anechoic Chamber Test Setup Diagram for 9KHz to 30MHz:

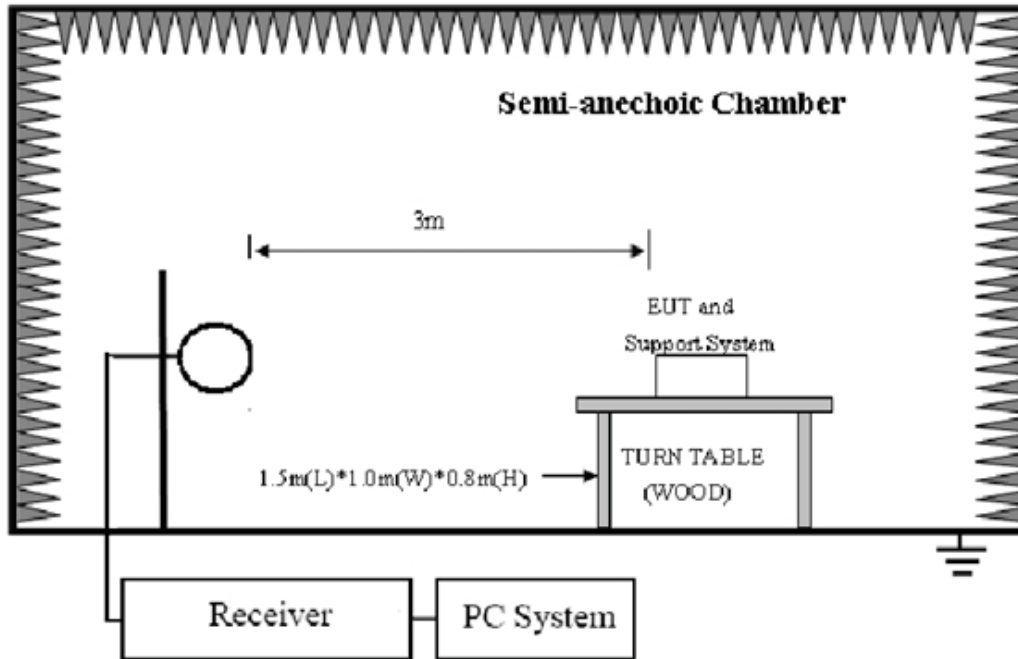

In 3m Anechoic Chamber Test Setup Diagram for 30MHz to 1GHz:

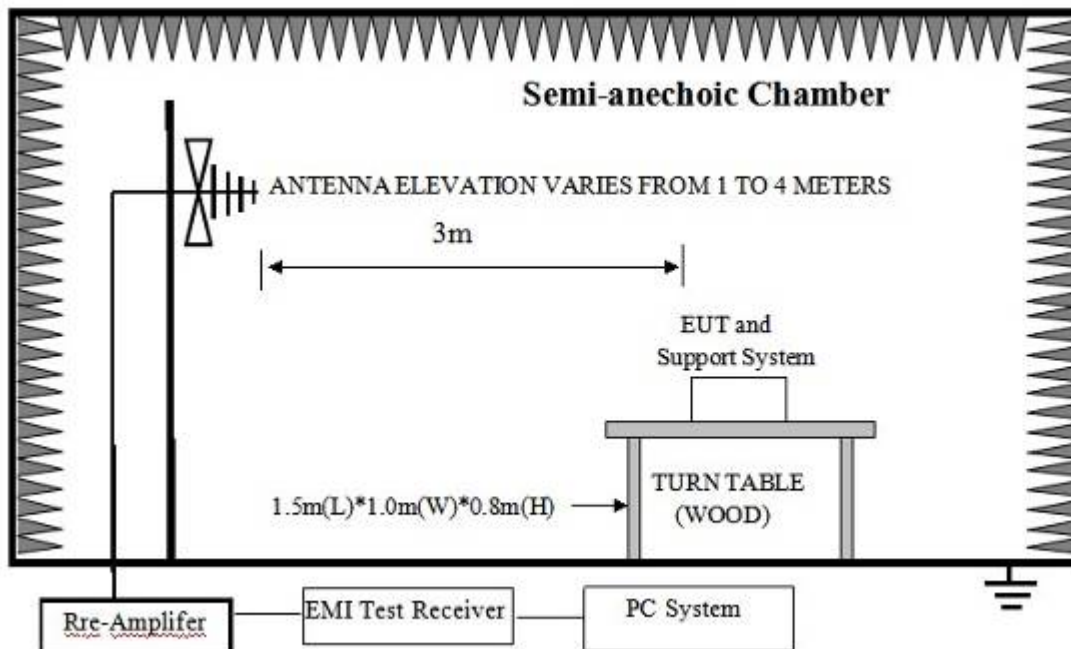

In 3m Anechoic Chamber Test Setup Diagram for frequency above 1GHz:

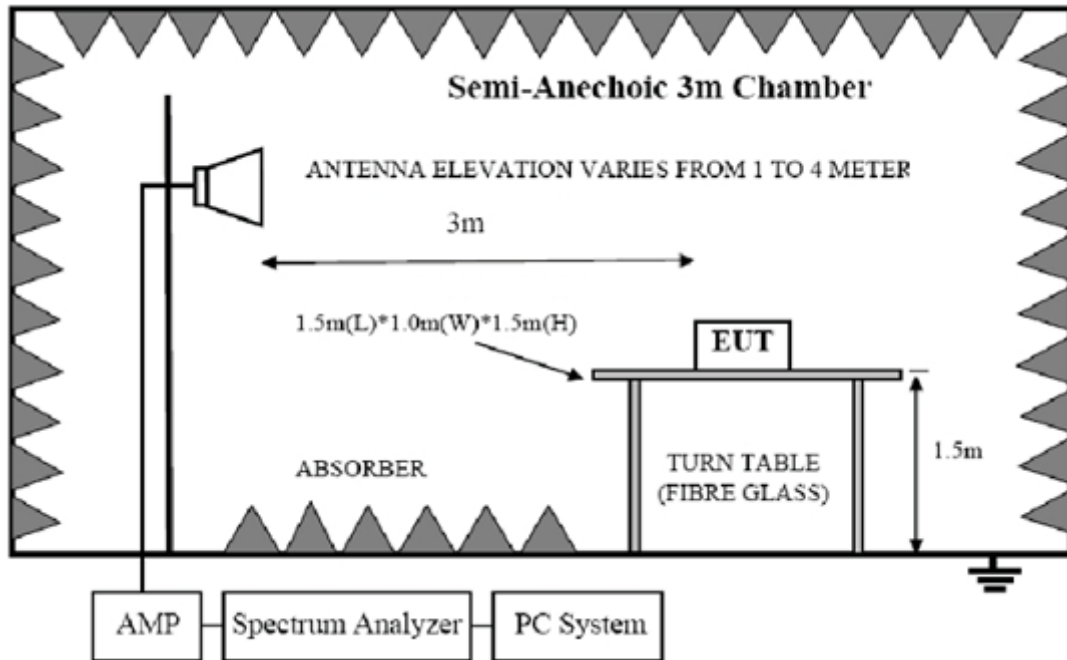

4.3. Limit

FCC 15.205 Restricted frequency band:

MHz	MHz	MHz	GHz
0.090 - 0.110	16.42 - 16.423	399.9 - 410	4.5 - 5.15
¹ 0.495 - 0.505	16.69475 - 16.69525	608 - 614	5.35 - 5.46
2.1735 - 2.1905	16.80425 - 16.80475	960 - 1240	7.25 - 7.75
4.125 - 4.128	25.5 - 25.67	1300 - 1427	8.025 - 8.5
4.17725 - 4.17775	37.5 - 38.25	1435 - 1626.5	9.0 - 9.2
4.20725 - 4.20775	73 - 74.6	1645.5 - 1646.5	9.3 - 9.5
6.215 - 6.218	74.8 - 75.2	1660 - 1710	10.6 - 12.7
6.26775 - 6.26825	108 - 121.94	1718.8 - 1722.2	13.25 - 13.4
6.31175 - 6.31225	123 - 138	2200 - 2300	14.47 - 14.5
8.291 - 8.294	149.9 - 150.05	2310 - 2390	15.35 - 16.2
8.362 - 8.366	156.52475 - 156.52525	2483.5 - 2500	17.7 - 21.4
8.37625 - 8.38675	156.7 - 156.9	2690 - 2900	22.01 - 23.12
8.41425 - 8.41475	162.0125 - 167.17	3260 - 3267	23.6 - 24.0
12.29 - 12.293	167.72 - 173.2	3332 - 3339	31.2 - 31.8
12.51975 - 12.52025	240 - 285	3345.8 - 3358	36.43 - 36.5
12.57675 - 12.57725	322 - 335.4	3600 - 4400	(²)

FCC 15.109 Limit

Frequency (MHz)	Distance (Meters)	Field Strengths Limits dB(μV)/m
30--88	3	40.0
88--216	3	43.5
216--960	3	46.0
960--1000	3	54.0
Above 1GHz	3	Peak: 74.0
	3	Average:54.0

Note: (1) The smaller limit shall apply at the cross point between two frequency bands.

(2)Distance is the distance in meters between the measuring instrument, antenna and the closest point of any part of the device or system.

(3)The emission limits shown in the above table are based on measurements employing a CISPR QP detector except for the frequency bands 9-90KHz, 110-490KHz and above 1000MHz.Radiated emissions limits in these three bands are based on measurements employing an average detector.

(4) At frequencies below 30MHz, measurement may be performed at a distance closer then that specified, and the limit at closer measurement distance can be extrapolated by below formula:

$$\text{Limit}_{3m}(\text{dBuV/m}) = \text{Limit}_{30m}(\text{dBuV/m}) + 40\text{Log}(30m/3m)$$

(5)All the emissions appearing within 15.205 restricted frequency bands shall not exceed the limits shown in 15.109, all the other emissions shall be at least 20dB below the fundamental emissions, or comply with 15.109 limits.

4.4. Test Procedure

Procedure of Preliminary Test

Configuration EUT to simulate typical usage as described in clause 2.3 and test equipment as described in clause 4.2 of this report.

Mains cables, telephone lines or other connections to auxiliary equipment located outside the test are shall drape to the floor, be fitted with ferrite clamps or ferrite tubes placed on the floor at the point where the cable reaches the floor and then routed to the place where they leave the turntable. No extension cords shall be used to mains receptacle.

EUT height should be 0.8m for below 1GHz and 1.5m for above 1GHz at ground with absorbers.

The antenna was placed at 3 meter away from the EUT as stated in ANSI C63.10. The antenna connected to the Spectrum Analyzer via a cable and at times a pre-amplifier would be used.

The Analyzer / Receiver quickly scanned from 30MHz to 18GHz. The EUT test program was started. Emissions were scanned and measured rotating the EUT to 360 degrees and positioning the antenna 1 to 4 meters above the ground plane, in both the vertical and the horizontal polarization, to maximize the emission reading level.

The X, Y, Z three axial are tested and the report only the worst case.

The emissions from 9KHz to 1GHz, QP or average values were measured with EMI receiver with below RBW:

Frequency band	RBW
9KHz-150KHz	200Hz
150KHz-30MHz	9KHz
30MHz-1GHz	120KHz

For emissions above 1GHz, both Peak and Average level were measured with Spectrum Analyzer, and the RBW is set at 1MHz, VBW is set at 3MHz for Peak measure; RMS detector RBW 1MHz VBW 3MHz for Average measure.

4.5. Test result

PASS. (See below detailed test result)

All the emissions except fundamental emission from 9 KHz to 40GHz were comply with FCC PART 15.109 limits limit.

Note1: For emissions above 1GHz. If peak results comply with AV limit,
AV Result is deemed to comply with AV limit.

Note2: Level = Reading Level + Factor, Margin= Level-Limit

Note3: We measured Radiated Emission at GFSK, $\pi/4$ DQPSK and 8DPSK mode
from 9 KHz to 25GHz and recorded worst case at GFSK DH5 mode.

Note4: For below 1GHz testing recorded worst at GFSK DH5 low channel.

Radiated Emission Test Result

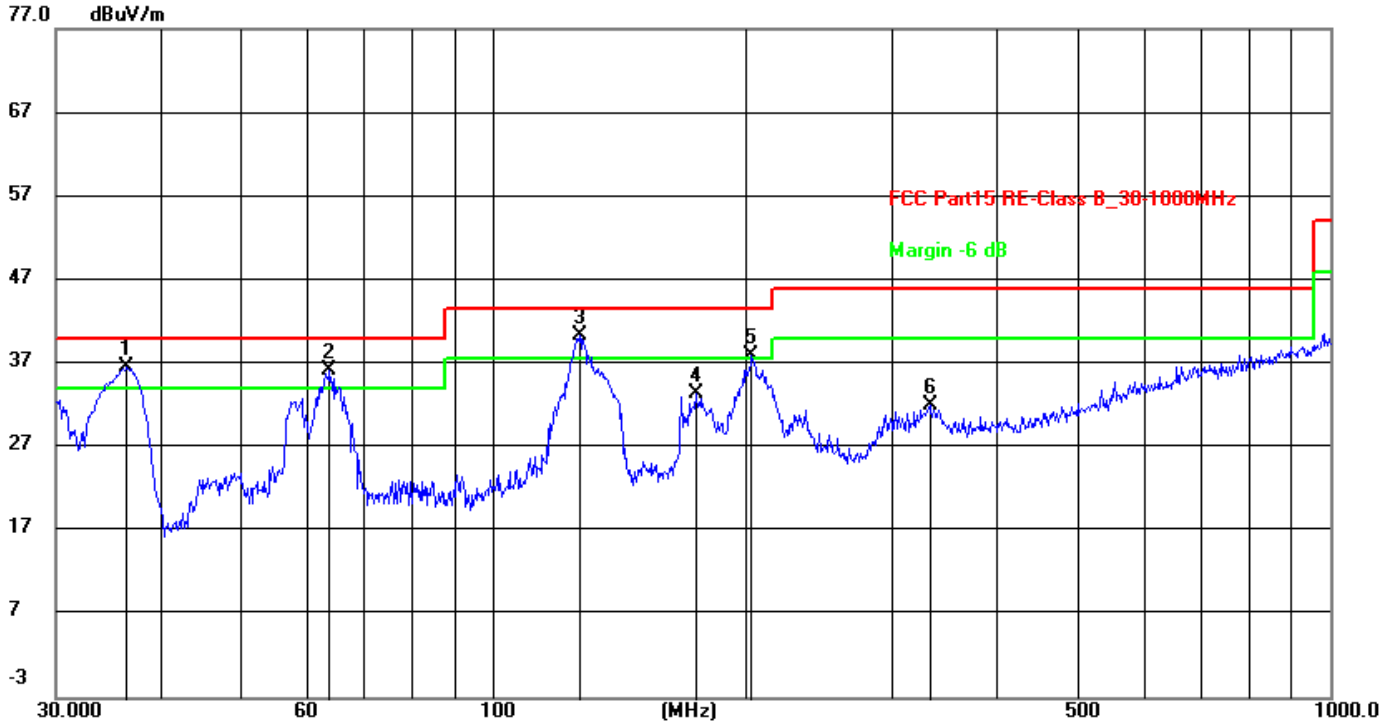

Site:	966 LAB	Antenna::Horizontal	Temperature(C):24(C)
Limit:	FCC Part15 RE-Class B_30-1000MHz		Humidity(%):60%
EUT:	Electric Drum Amplifier	Test Time:	2022/3/3 9:09:30
M/N.:	DDA 35	Power Rating:	AC 120V/60Hz
Mode:	BT	Test Engineer:	
Note:			

No.	Frequency (MHz)	Reading (dBuV)	Factor (dB/m)	Level (dBuV/m)	Limit (dBuV/m)	Margin (dB)	Det.	Height (cm)	Azimuth (deg)	Remark
1	35.4992	16.27	16.97	33.24	40.00	-6.76	QP	100	230	N/A
2	56.0007	20.63	15.39	36.02	40.00	-3.98	peak	100	42	N/A
3	89.5899	20.20	11.43	31.63	43.50	-11.87	peak	100	156	N/A
4*	128.1127	25.16	14.86	40.02	43.50	-3.48	peak	100	189	N/A
5	201.3930	24.96	12.37	37.33	43.50	-6.17	peak	200	48	N/A
6	300.3672	17.07	15.63	32.70	46.00	-13.30	peak	200	146	N/A

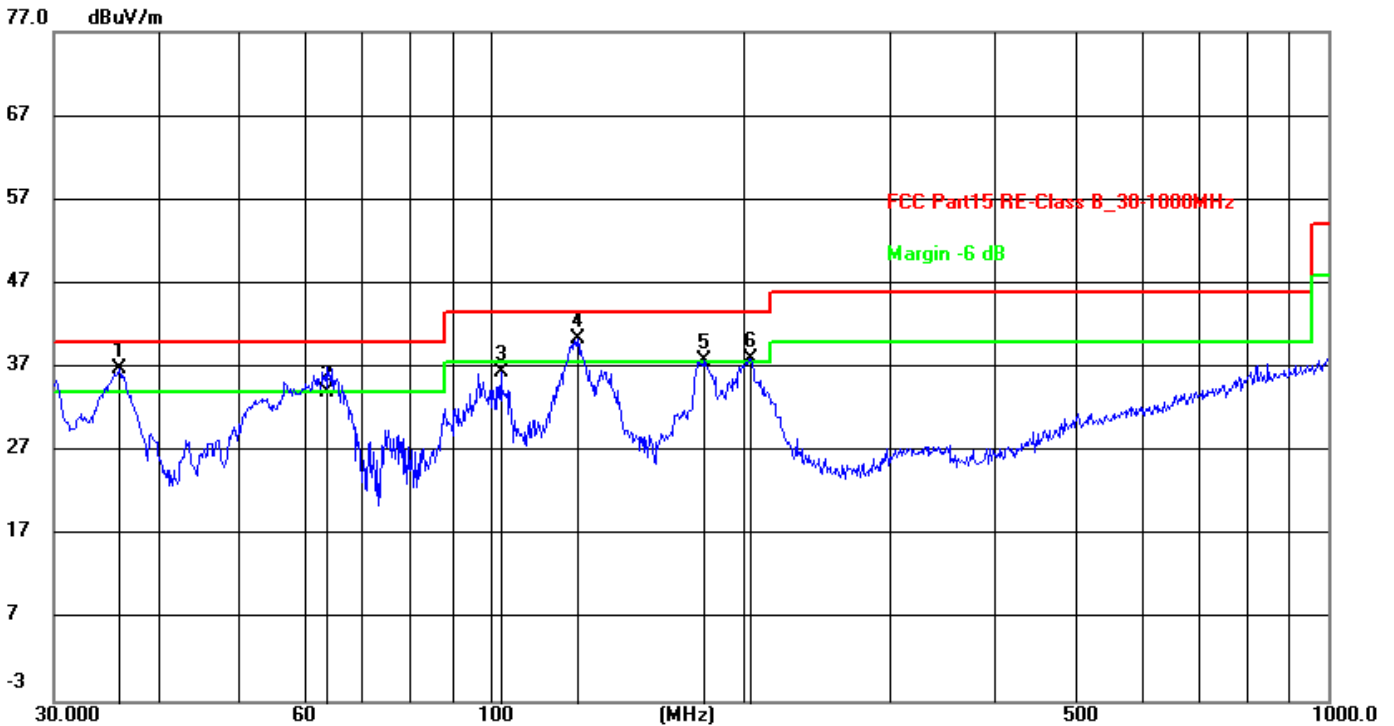

Site:	966 LAB	Antenna::	Vertical	Temperature(C):	24(C)
Limit:	FCC Part15 RE-Class B_30-1000MHz			Humidity(%):	60%
EUT:	Electric Drum Amplifier	Test Time:	2022/3/2 18:01:43		
M/N.:	DDA 35	Power Rating:	AC 120V/60Hz		
Mode:	BT	Test Engineer:			
Note:					

No.	Frequency (MHz)	Reading (dBuV)	Factor (dB/m)	Level (dBuV/m)	Limit (dBuV/m)	Margin (dB)	Det.	Height (cm)	Azimuth (deg)	Remark
1	36.0007	21.46	15.30	36.76	40.00	-3.24	peak	100	26	N/A
2	63.7588	21.21	12.81	34.02	40.00	-5.98	QP	100	321	N/A
3	102.7192	24.71	11.76	36.47	43.50	-7.03	peak	100	69	N/A
4*	126.7723	27.69	12.74	40.43	43.50	-3.07	peak	200	79	N/A
5	179.3863	25.09	12.79	37.88	43.50	-5.62	peak	200	289	N/A
6	204.2375	24.24	13.76	38.00	43.50	-5.50	peak	200	165	N/A

For 1GHz to 25GHz

Note: 1. GFSK, Pi/4 DQPSK and 8DPSK all have been tested, only worse case GFSK is reported.
 2. 8~25GHz at least have 20dB margin. No recording in the test report.

GFSK (above 1GHz)

Frequency(MHz):			2402		Polarity:			HORIZONTAL	
Frequency (MHz)	Emission Level (dBuV/m)		Limit (dBuV/m)	Margin (dB)	Raw Value (dBuV)	Antenna Factor (dB/m)	Cable Factor (dB)	Pre-amplifier (dB)	Correction Factor (dB/m)
4804.00	52.36	PK	74.00	21.64	47.85	33.49	6.91	35.89	4.51
4804.00	43.62	AV	54.00	10.38	39.11	33.49	6.91	35.89	4.51
5010.00	45.45	PK	74.00	28.55	38.59	34.06	7.04	34.24	6.86
5010.00	--	AV	54.00	--	--	--	--	--	--
7206.00	44.36	PK	74.00	29.64	33.26	36.95	9.18	35.03	11.10
7206.00	--	AV	54.00	--	--	--	--	--	--

Frequency(MHz):			2402		Polarity:			VERTICAL	
Frequency (MHz)	Emission Level (dBuV/m)		Limit (dBuV/m)	Margin (dB)	Raw Value (dBuV)	Antenna Factor (dB/m)	Cable Factor (dB)	Pre-amplifier (dB)	Correction Factor (dB/m)
4804.00	51.25	PK	74.00	22.75	46.74	33.49	6.91	35.89	4.51
4804.00	43.63	AV	54.00	10.37	39.12	33.49	6.91	35.89	4.51
5128.00	44.69	PK	74.00	29.31	37.83	34.06	7.04	34.24	6.86
5128.00	--	AV	54.00	--	--	--	--	--	--
7206.00	43.48	PK	74.00	30.52	32.38	36.95	9.18	35.03	11.10
7206.00	--	AV	54.00	--	--	--	--	--	--

Frequency(MHz):			2441		Polarity:			HORIZONTAL	
Frequency (MHz)	Emission Level (dBuV/m)		Limit (dBuV/m)	Margin (dB)	Raw Value (dBuV)	Antenna Factor (dB/m)	Cable Factor (dB)	Pre-amplifier (dB)	Correction Factor (dB/m)
4882.00	50.39	PK	74.00	23.61	44.03	33.60	6.95	34.19	6.36
4882.00	41.75	AV	54.00	12.25	35.39	33.60	6.95	34.19	6.36
5369.00	45.12	PK	74.00	28.88	37.52	34.56	7.15	34.11	7.60
5369.00	--	AV	54.00	--	--	--	--	--	--
7323.00	43.85	PK	74.00	30.15	32.15	37.46	9.23	35.00	11.70
7323.00	--	AV	54.00	--	--	--	--	--	--

Frequency(MHz):			2441		Polarity:			VERTICAL	
Frequency (MHz)	Emission Level (dBuV/m)		Limit (dBuV/m)	Margin (dB)	Raw Value (dBuV)	Antenna Factor (dB/m)	Cable Factor (dB)	Pre-amplifier (dB)	Correction Factor (dB/m)
4882.00	48.96	PK	74.00	25.04	42.6	33.60	6.95	34.19	6.36
4882.00	42.75	AV	54.00	11.25	36.39	33.60	6.95	34.19	6.36
5450.00	44.63	PK	74.00	29.37	37.03	34.56	7.15	34.11	7.60
5450.00	--	AV	54.00	--	--	--	--	--	--
7323.00	48.25	PK	74.00	25.75	36.55	37.46	9.23	35.00	11.70
7323.00	--	AV	54.00	--	--	--	--	--	--

Frequency(MHz):			2480		Polarity:			HORIZONTAL	
Frequency (MHz)	Emission Level (dBuV/m)		Limit (dBuV/m)	Margin (dB)	Raw Value (dBuV)	Antenna Factor (dB/m)	Cable Factor (dB)	Pre-amplifier (dB)	Correction Factor (dB/m)
4960.00	49.68	PK	74.00	24.32	44.76	33.84	7.00	35.92	4.92
4960.00	40.24	AV	54.00	13.76	35.32	33.84	7.00	35.92	4.92
5998.00	44.36	PK	74.00	29.64	37.08	34.45	7.12	34.29	7.28
5998.00	--	AV	54.00	--	--	--	--	--	--
7440.00	42.86	PK	74.00	31.14	30.91	37.64	9.28	34.97	11.95
7440.00	--	AV	54.00	--	--	--	--	--	--

Frequency(MHz):			2480		Polarity:			VERTICAL	
Frequency (MHz)	Emission Level (dBuV/m)		Limit (dBuV/m)	Margin (dB)	Raw Value (dBuV)	Antenna Factor (dB/m)	Cable Factor (dB)	Pre-amplifier (dB)	Correction Factor (dB/m)
4960.00	51.62	PK	74.00	22.38	46.7	33.84	7.00	35.92	4.92
4960.00	41.36	AV	54.00	12.64	36.44	33.84	7.00	35.92	4.92
5649.00	43.85	PK	74.00	30.15	36.57	34.45	7.12	34.29	7.28
5649.00	--	AV	54.00	--	--	--	--	--	--
7440.00	42.36	PK	74.00	31.64	30.41	37.64	9.28	34.97	11.95
7440.00	--	AV	54.00	--	--	--	--	--	--

REMARKS:

1. Emission level (dBuV/m) =Raw Value (dBuV)+Correction Factor (dB/m)
2. Correction Factor (dB/m) = Antenna Factor (dB/m)+Cable Factor (dB)-Pre-amplifier Factor
3. Margin value = Limit value- Emission level.
4. -- Mean the PK detector measured value is below average limit.
5. The other emission levels were very low against the limit.
6. RBW1MHz VBW3MHz Peak detector is for PK value; RBW 1MHz VBW10Hz Peak detector is for AV value.

Results of Band Edges Test (Radiated)

Note: All modulations have been tested, only worse case GFSK is reported.

Frequency(MHz):			2402		Polarity:			HORIZONTAL	
Frequency (MHz)	Emission Level (dBuV/m)		Limit (dBuV/m)	Margin (dB)	Raw Value (dBuV)	Antenna Factor (dB/m)	Cable Factor (dB)	Pre-amplifier (dB)	Correction Factor (dB/m)
2402.00	103.63	PK	--	--	70.24	28.78	4.61	0	33.39
2402.00	93.85	AV	--	--	60.46	28.78	4.61	0	33.39
2362.00	43.96	PK	74.00	30.04	10.88	28.52	4.56	0	33.08
2362.00	--	AV	54.00	--	--	--	--	--	--
2390.00	51.36	PK	74.00	22.64	18.04	28.72	4.60	0	33.32
2390.00	--	AV	54.00	--	--	--	--	--	--
2400.00	51.62	PK	74.00	22.38	18.23	28.78	4.61	0	33.39
2400.00	--	AV	54.00	--	--	--	--	--	--

Frequency(MHz):			2402		Polarity:			VERTICAL	
Frequency (MHz)	Emission Level (dBuV/m)		Limit (dBuV/m)	Margin (dB)	Raw Value (dBuV)	Antenna Factor (dB/m)	Cable Factor (dB)	Pre-amplifier (dB)	Correction Factor (dB/m)
2402.00	99.68	PK	--	--	66.29	28.78	4.61	0	33.39
2402.00	91.82	AV	--	--	58.43	28.78	4.61	0	33.39
2378.00	43.35	PK	74.00	30.65	10.27	28.52	4.56	0	33.08
2378.00	--	AV	54.00	--	--	--	--	--	--
2390.00	46.69	PK	74.00	27.31	13.37	28.72	4.60	0	33.32
2390.00	--	AV	54.00	--	--	--	--	--	--
2400.00	49.75	PK	74.00	24.25	16.36	28.78	4.61	0	33.39
2400.00	--	AV	54.00	--	--	--	--	--	--

Frequency(MHz):			2480		Polarity:			HORIZONTAL	
Frequency (MHz)	Emission Level (dBuV/m)		Limit (dBuV/m)	Margin (dB)	Raw Value (dBuV)	Antenna Factor (dB/m)	Cable Factor (dB)	Pre-amplifier (dB)	Correction Factor (dB/m)
2480.00	101.87	PK	--	--	68.25	28.92	4.70	0.00	33.62
2480.00	92.36	AV	--	--	58.74	28.92	4.70	0.00	33.62
2483.50	46.95	PK	74.00	27.05	13.32	28.93	4.70	0.00	33.63
2483.50	--	AV	54.00	--	--	--	--	--	--
2485.00	46.42	PK	74.00	27.58	12.76	28.95	4.71	0.00	33.66
2485.00	--	AV	54.00	--	--	--	--	--	--
2500.00	45.12	PK	74.00	28.88	11.44	28.96	4.72	0.00	33.68
2500.00	--	AV	54.00	--	--	--	--	--	--

Frequency(MHz):			2480		Polarity:			VERTICAL	
Frequency (MHz)	Emission Level (dBuV/m)		Limit (dBuV/m)	Margin (dB)	Raw Value (dBuV)	Antenna Factor (dB/m)	Cable Factor (dB)	Pre-amplifier (dB)	Correction Factor (dB/m)
2480.00	99.36	PK	--	--	65.74	28.92	4.70	0.00	33.62
2480.00	91.12	AV	--	--	57.5	28.92	4.70	0.00	33.62
2483.50	50.35	PK	74.00	23.65	16.72	28.93	4.70	0.00	33.63
2483.50	--	AV	54.00	--	--	--	--	--	--
2494.00	48.68	PK	74.00	25.32	15.02	28.95	4.71	0.00	33.66
2494.00	--	AV	54.00	--	--	--	--	--	--
2500.00	44.42	PK	74.00	29.58	10.74	28.96	4.72	0.00	33.68
2500.00	--	AV	54.00	--	--	--	--	--	--

REMARKS:

1. Emission level (dBuV/m) = Raw Value (dBuV) + Correction Factor (dB/m)
2. Correction Factor (dB/m) = Antenna Factor (dB/m) + Cable Factor (dB) - Pre-amplifier Factor
3. Margin value = Limit value - Emission level.
4. -- Mean the PK detector measured value is below average limit.
5. The other emission levels were very low against the limit.
6. RBW 1MHz VBW 3MHz Peak detector is for PK value; RBW 1MHz VBW 10Hz Peak detector is for AV value.
7. For fundamental frequency, RBW 3MHz VBW 3MHz Peak detector is for PK Value; RMS detector is for AV value.

5. Maximum Peak Output Power

5.1. Applied procedures / Limit

15.247(a) (1) Frequency hopping systems shall have hopping channel carrier frequencies separated by a minimum of 25 kHz or the 20 dB bandwidth of the hopping channel, whichever is greater. Alternatively, frequency hopping systems operating in the 2400–2483.5 MHz band may have hopping channel carrier frequencies that are separated by 25 kHz or two-thirds of the 20 dB bandwidth of the hopping channel, whichever is greater, provided the systems operate with an output power no greater than 125 mW.

15.247(b) (1) For frequency hopping systems operating in the 2400-2483.5 MHz band employing at least 75 non-overlapping hopping channels, and all frequency hopping systems in the 5725-5850 MHz band: 1watt. For all other frequency hopping systems in the 2400-2483.5 MHz band: 0.125 watts.

5.2. Test procedure

- (1) Connected the antenna port to the Spectrum Analyzer, set the Spectrum Analyzer as
Span = approximately 5 times the 20 dB bandwidth, centered on a hopping channel
RBW > the 20 dB bandwidth of the emission being measured, VBW ≥ RBW, Sweep = auto
Detector function = peak, Trace = max hold
- (2) The EUT should be transmitting at its maximum data rate. Allow the trace to stabilize. Use the marker-to-peak function to set the marker to the peak of the emission. The indicated level is the peak output power.
- (3) The above procedure shall be repeated at the lowest, the middle, and the highest frequency of the stated frequency range with modulated mode. Also shall be performed at different modes of operation.

5.3. Deviation from standard

No deviation.

5.4. Test setup



5.5. TEST RESULTS

Condition	Mode	Frequency (MHz)	Antenna	Conducted Power (dBm)	Duty Factor (dB)	Total Power (dBm)	Limit (dBm)	Verdict
NVNT	1-DH5	2402	Ant 1	-0.71	0	-0.71	21	Pass
NVNT	1-DH5	2441	Ant 1	-2.41	0	-2.41	21	Pass
NVNT	1-DH5	2480	Ant 1	-3.66	0	-3.66	21	Pass

Power NVNT 1-DH5 2402MHz Ant1

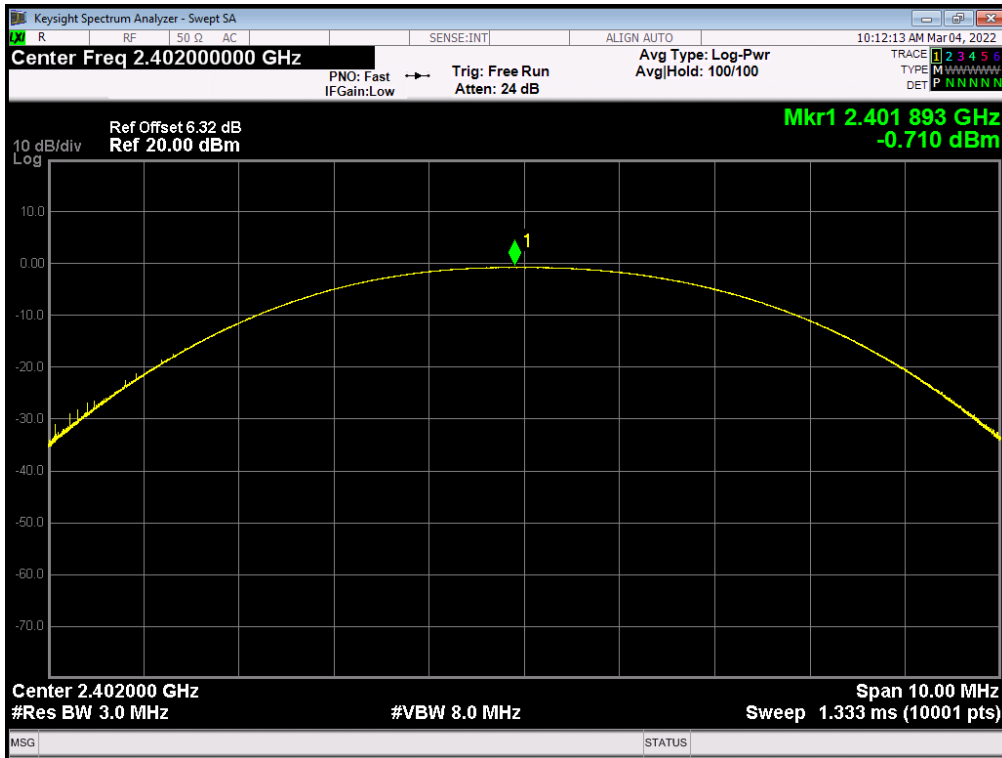

Power NVNT 1-DH5 2441MHz Ant1

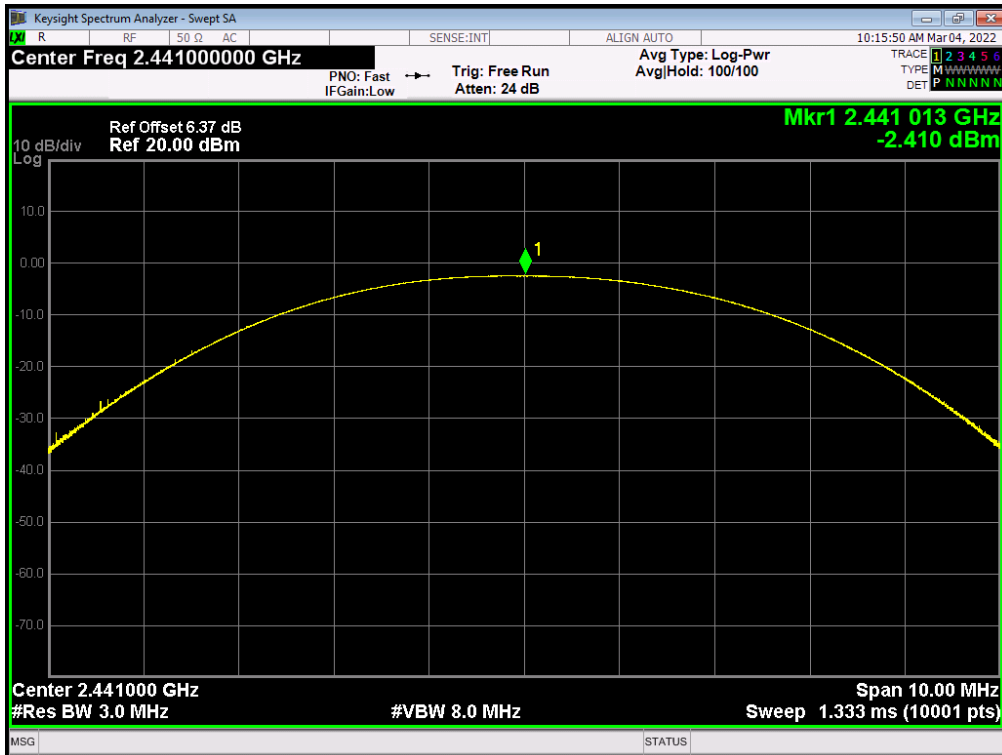

Power NVNT 1-DH5 2480MHz Ant1

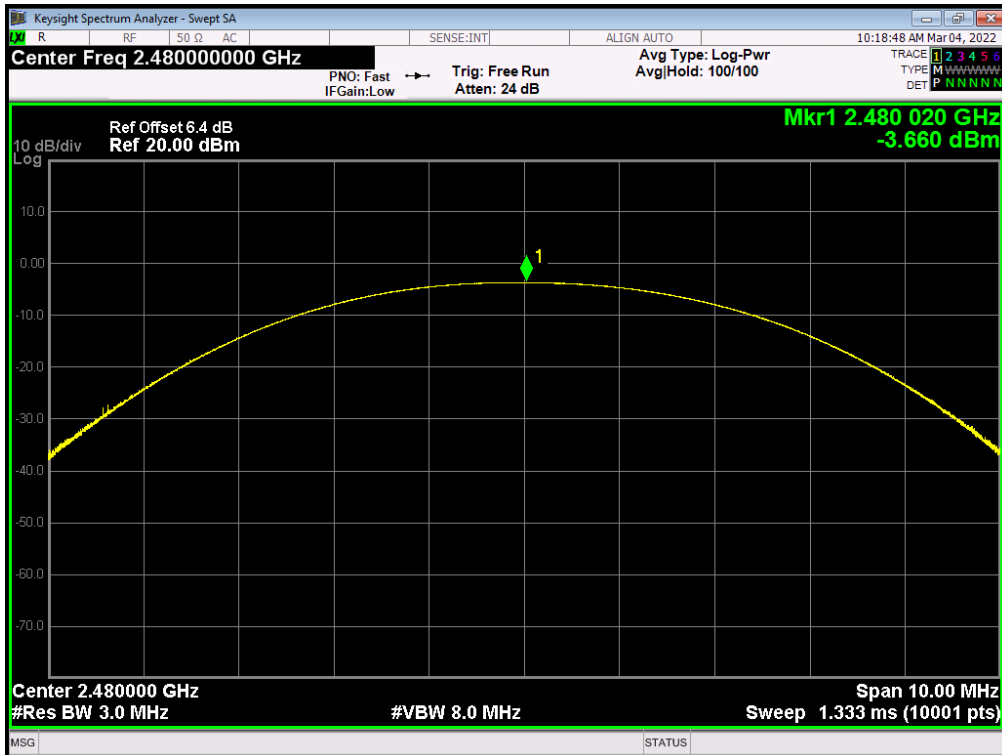

Condition	Mode	Frequency (MHz)	Antenna	Conducted Power (dBm)	Duty Factor (dB)	Total Power (dBm)	Limit (dBm)	Verdict
NVNT	2-DH5	2402	Ant 1	1.277	0	1.277	21	Pass
NVNT	2-DH5	2441	Ant 1	0.085	0	0.085	21	Pass
NVNT	2-DH5	2480	Ant 1	-1.122	0	-1.122	21	Pass

Power NVNT 2-DH5 2402MHz Ant1

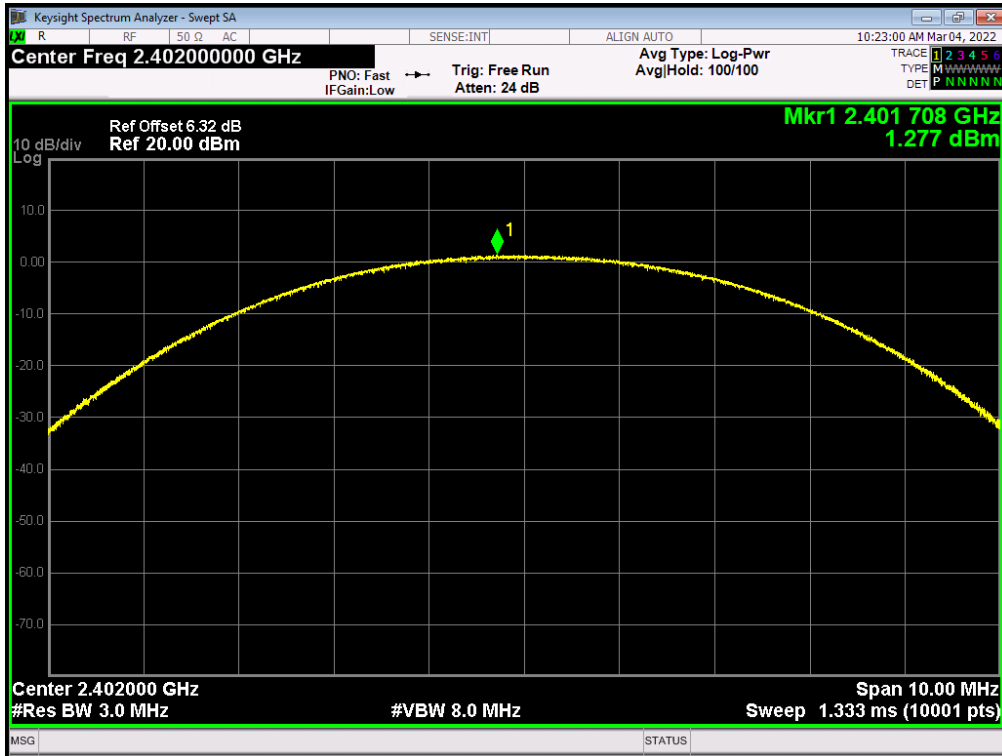

Power NVNT 2-DH5 2441MHz Ant1

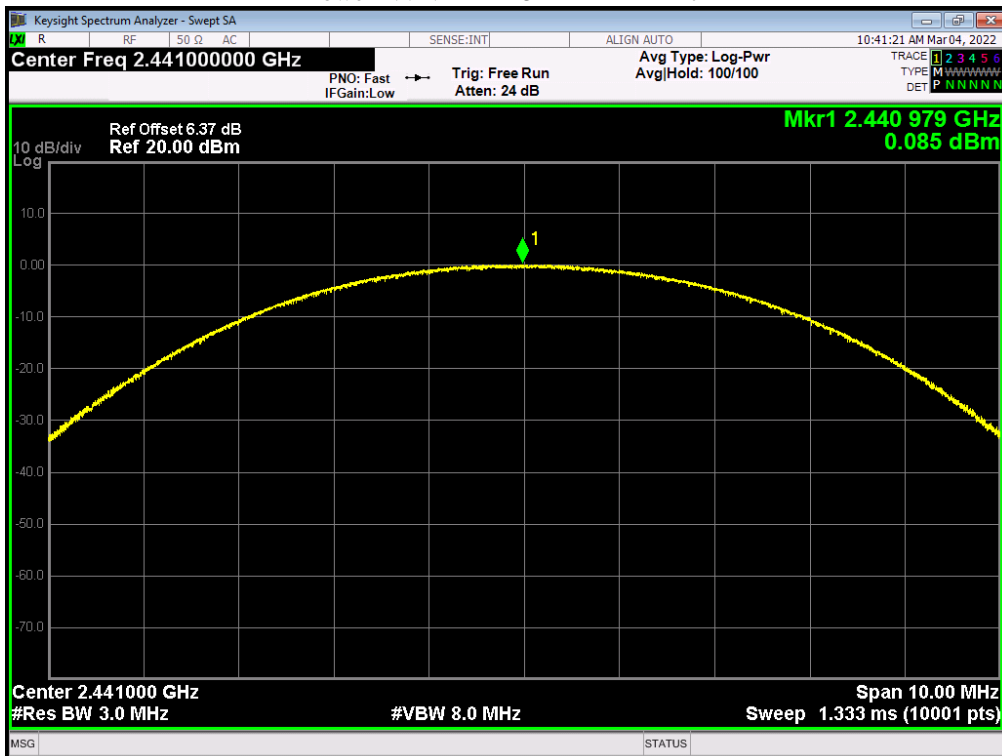

Power NVNT 2-DH5 2480MHz Ant1

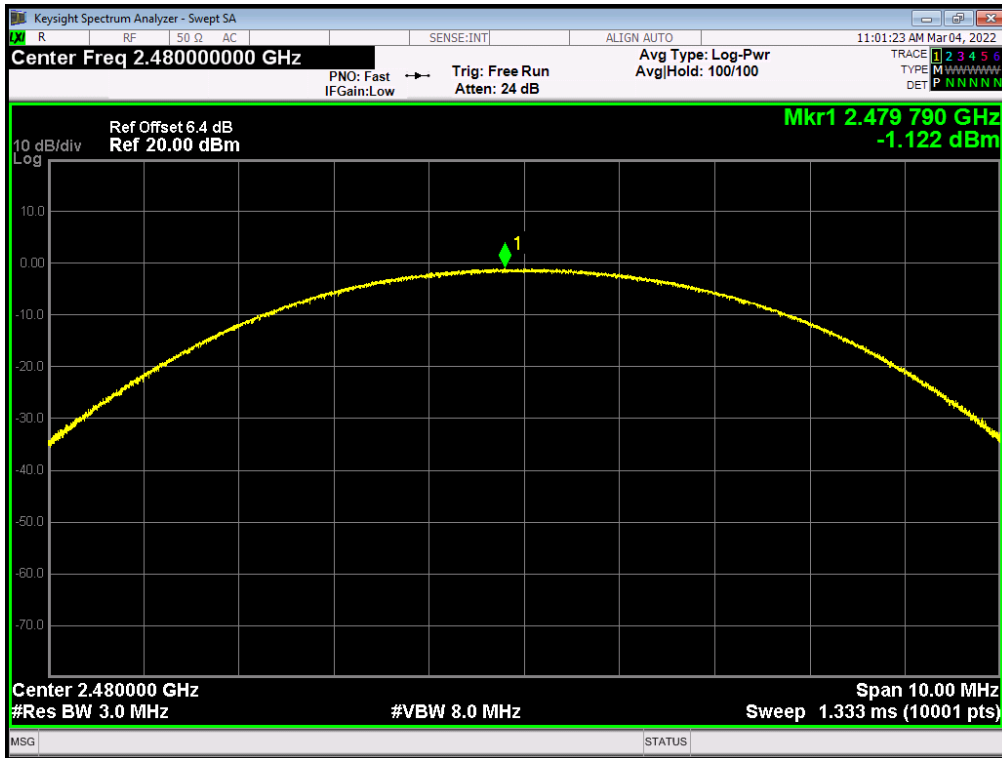

Condition	Mode	Frequency (MHz)	Antenna	Conducted Power (dBm)	Duty Factor (dB)	Total Power (dBm)	Limit (dBm)	Verdict
NVNT	3-DH5	2402	Ant 1	2.209	0	2.209	21	Pass
NVNT	3-DH5	2441	Ant 1	0.6	0	0.6	21	Pass
NVNT	3-DH5	2480	Ant 1	-0.532	0	-0.532	21	Pass

Power NVNT 3-DH5 2402MHz Ant1

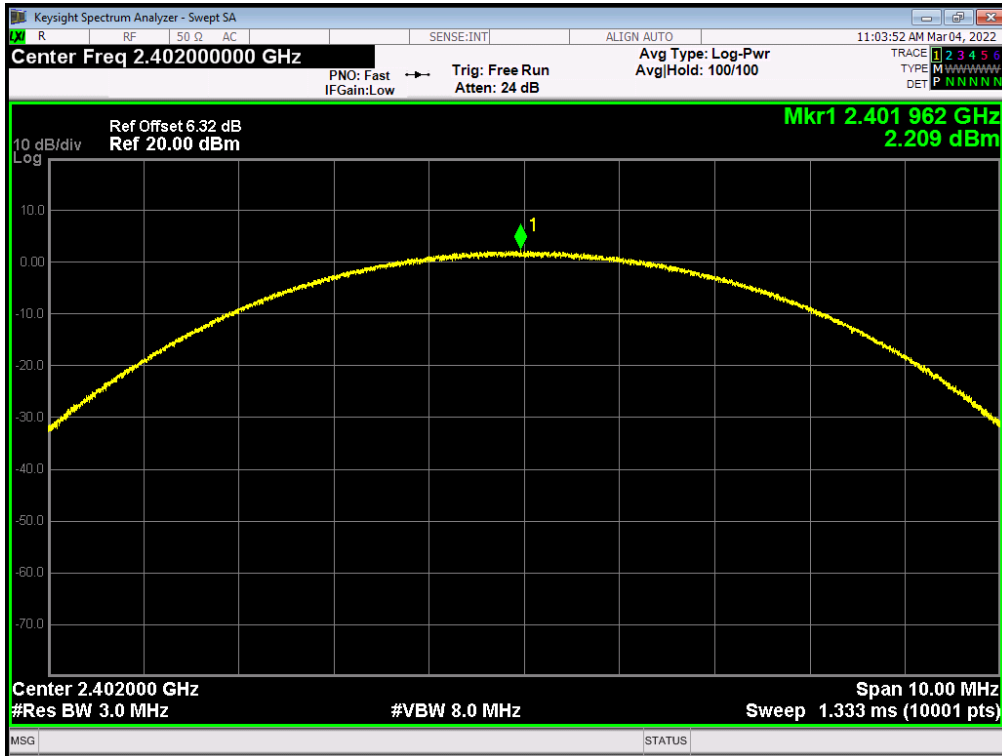

Power NVNT 3-DH5 2441MHz Ant1

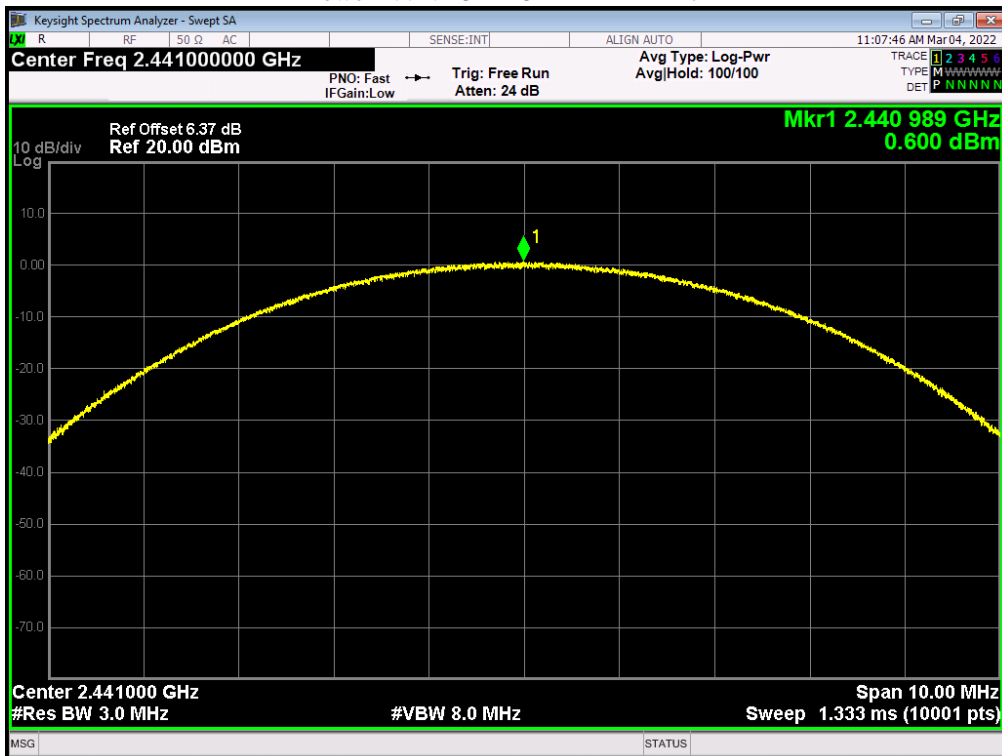

Power NVNT 3-DH5 2480MHz Ant1

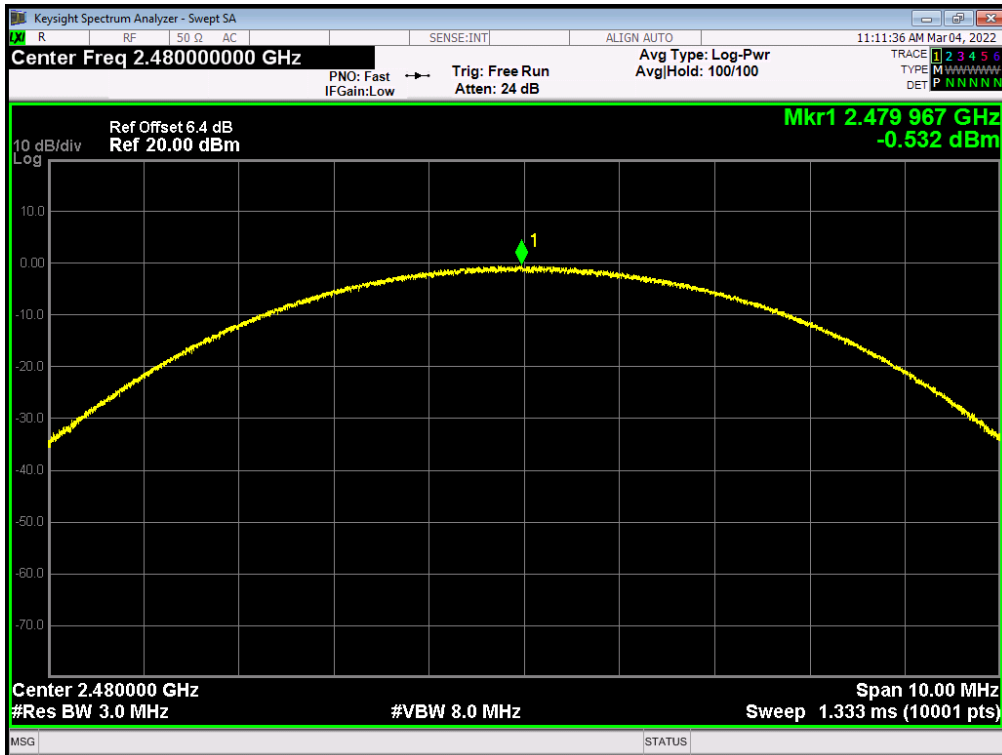

Note: All the modes (1-DH1, 1-DH3,1-DH5,2-DH1,2-DH3,2-DH5,3-DH1,3-DH3,3-DH5) had been test, but only the worst data (1-DH5,2-DH5,3-DH5) record in the report.

6. BANDWIDTH TEST

6.1. Applied procedures / Limit

For frequency hopping system operating in the 2400-2483.5MHz, If the 20dB bandwidth of hopping channel is greater than 25kHz, two-thirds 20dB bandwidth of hopping channel shall be a minimum limit for the hopping channel separation.

6.2. Test procedure

- a. The EUT was directly connected to the spectrum analyzer and antenna output port as show in the block diagram below.
- b. Span = approximately 2 to 3 times the 20 dB bandwidth, centered on a hopping channel
RBW \geq 1% of the 20 dB bandwidth, VBW \geq RBW, Sweep = auto, Detector function = peak
Trace = max hold

6.3. Deviation from standard

No deviation.

6.4. Test setup

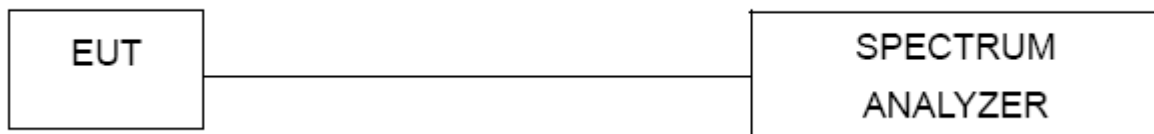

6.5. Test results

Condition	Mode	Frequency (MHz)	Antenna	99% OBW (MHz)	-20 dB Bandwidth (MHz)	Limit -20 dB Bandwidth (MHz)	Verdict
NVNT	1-DH5	2402	Ant 1	0.8268	0.9375	0	Pass
NVNT	1-DH5	2441	Ant 1	0.8274	0.9459	0	Pass
NVNT	1-DH5	2480	Ant 1	0.8337	0.9404	0	Pass

OBW NVNT 1-DH5 2402MHz Ant1

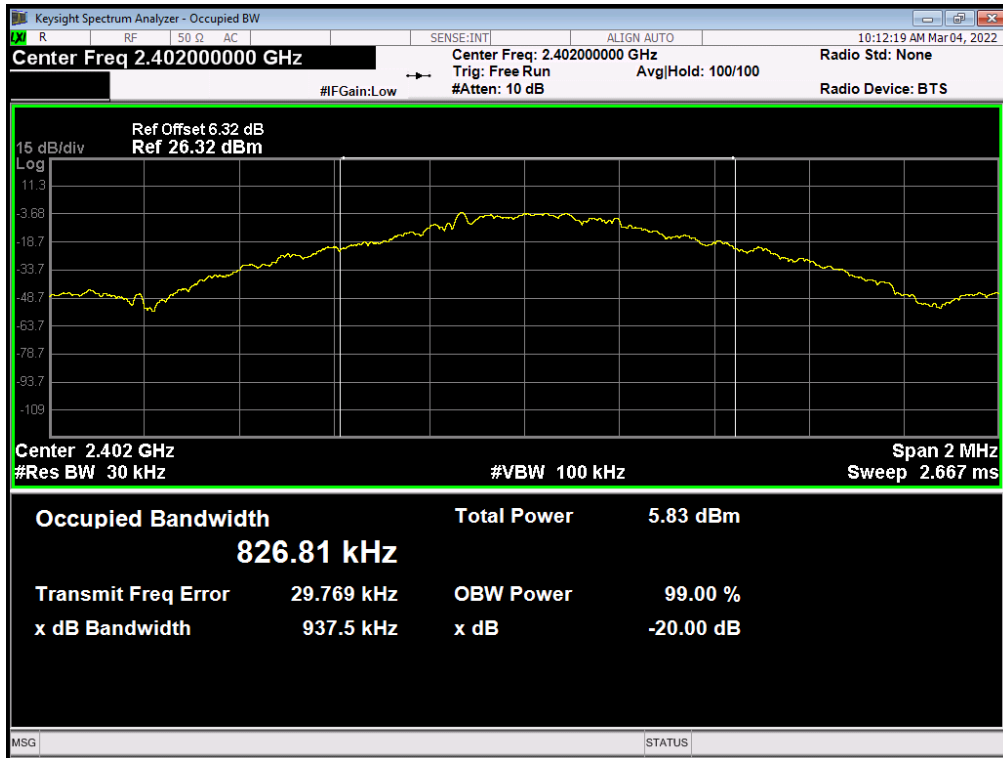

OBW NVNT 1-DH5 2441MHz Ant1

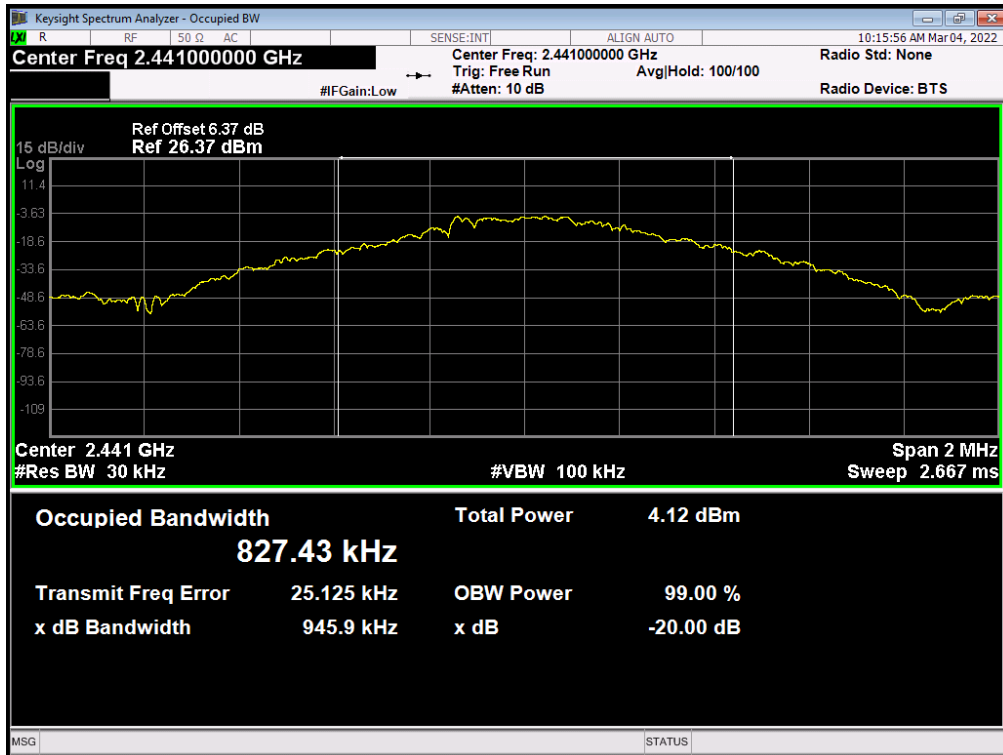

OBW NVNT 1-DH5 2480MHz Ant1

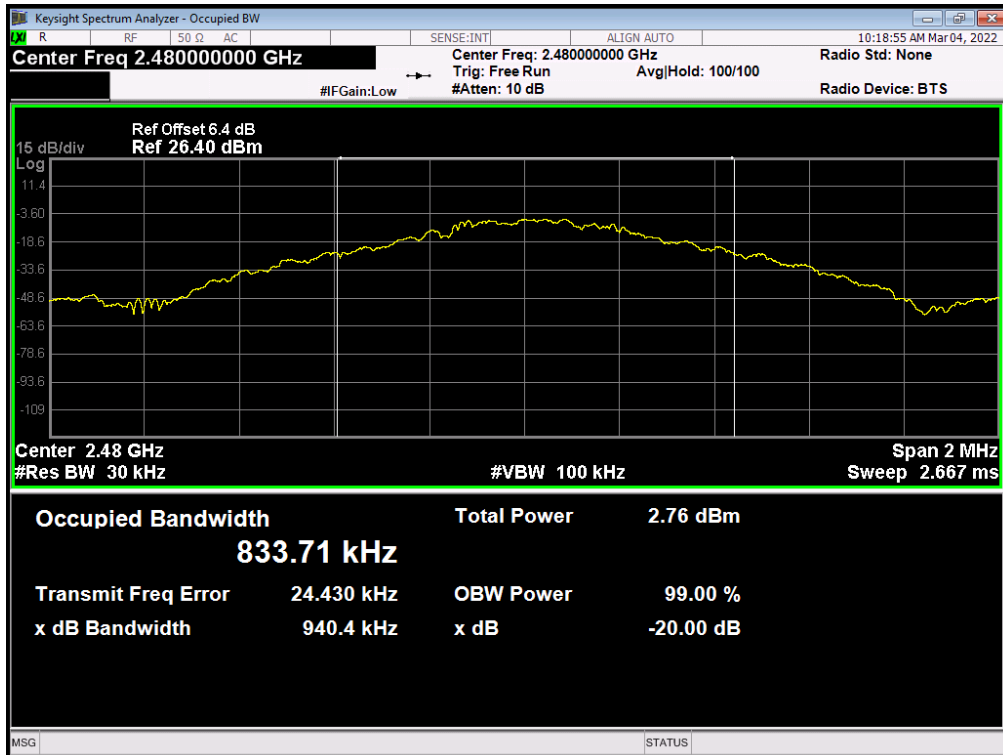

Condition	Mode	Frequency (MHz)	Antenna	99% OBW (MHz)	-20 dB Bandwidth (MHz)	Limit -20 dB Bandwidth (MHz)	Verdict
NVNT	2-DH5	2402	Ant 1	1.1851	1.3352	0	Pass
NVNT	2-DH5	2441	Ant 1	1.1798	1.2736	0	Pass
NVNT	2-DH5	2480	Ant 1	1.1893	1.3386	0	Pass

OBW NVNT 2-DH5 2402MHz Ant1

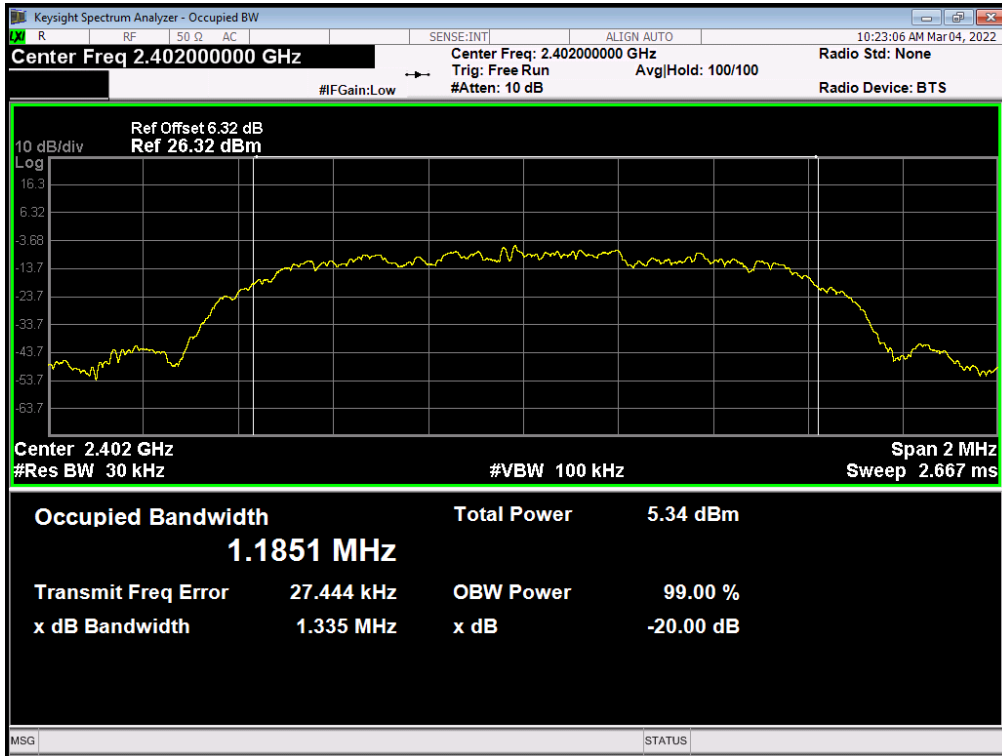

OBW NVNT 2-DH5 2441MHz Ant1

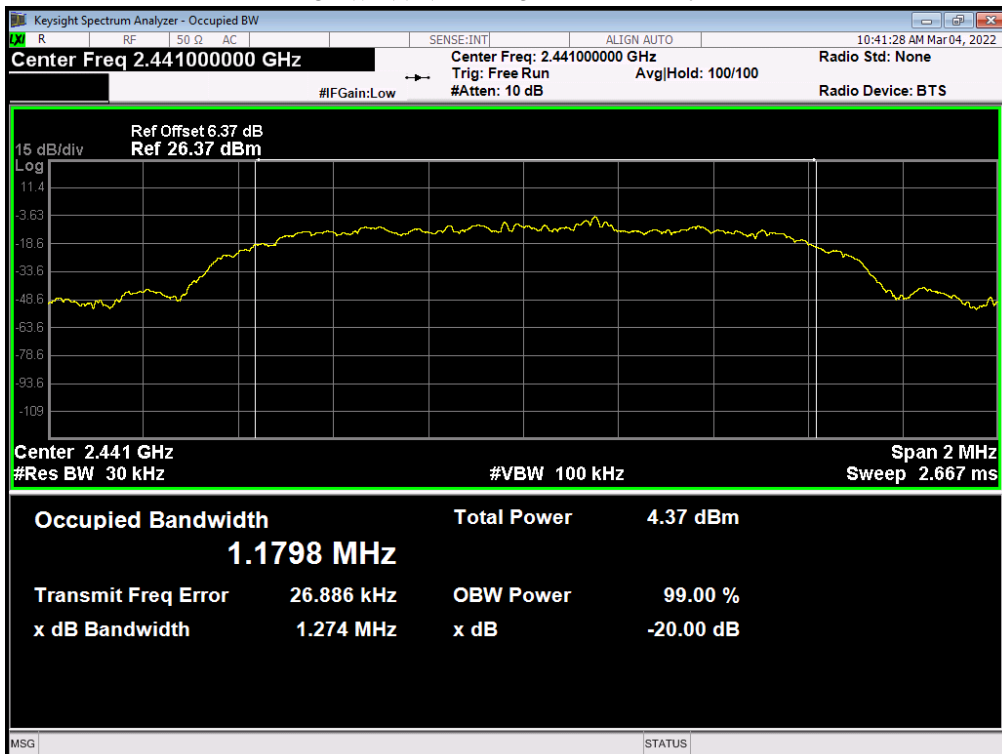

OBW NVNT 2-DH5 2480MHz Ant1

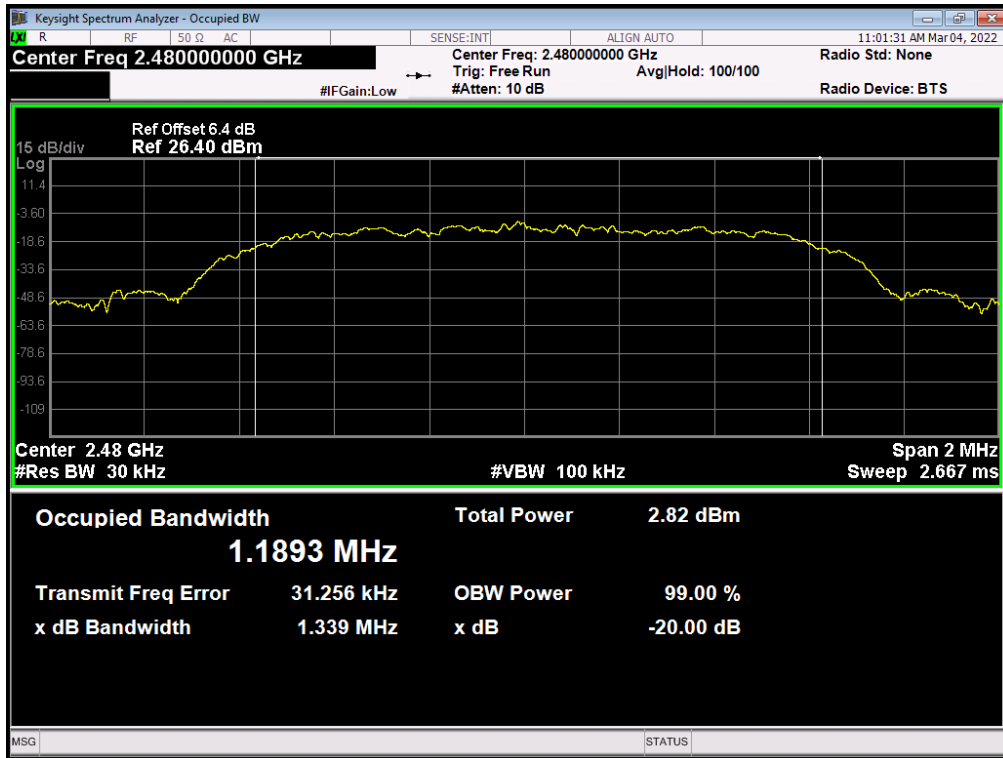

Condition	Mode	Frequency (MHz)	Antenna	99% OBW (MHz)	-20 dB Bandwidth (MHz)	Limit -20 dB Bandwidth (MHz)	Verdict
NVNT	3-DH5	2402	Ant 1	1.18	1.2915	0	Pass
NVNT	3-DH5	2441	Ant 1	1.1849	1.3024	0	Pass
NVNT	3-DH5	2480	Ant 1	1.1899	1.3054	0	Pass

OBW NVNT 3-DH5 2402MHz Ant1

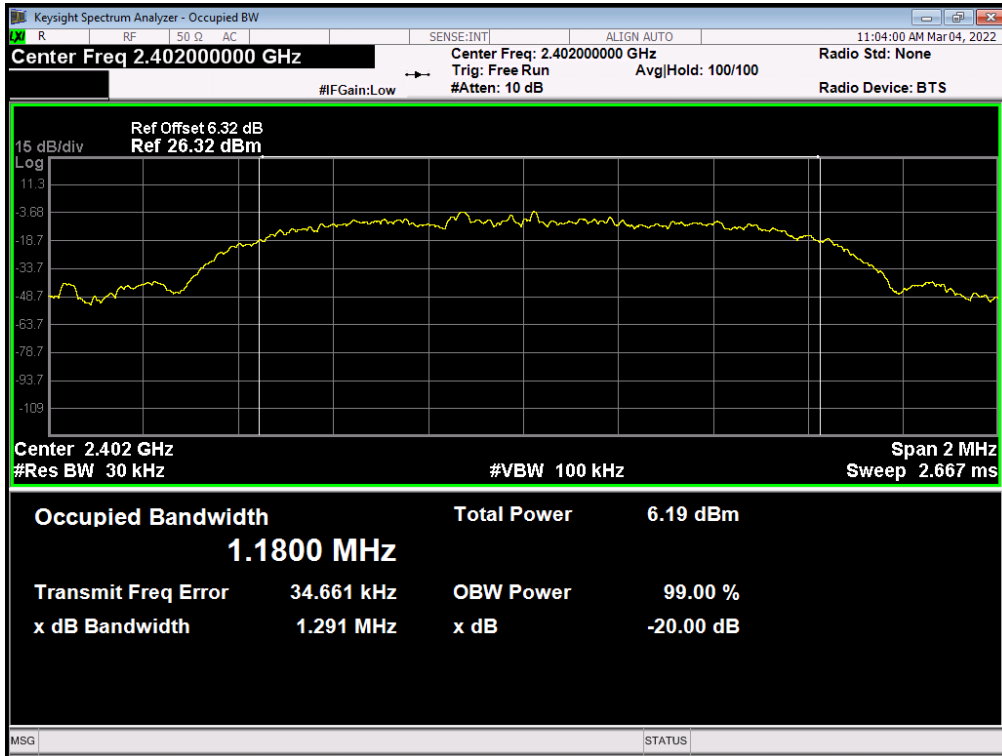

OBW NVNT 3-DH5 2441MHz Ant1

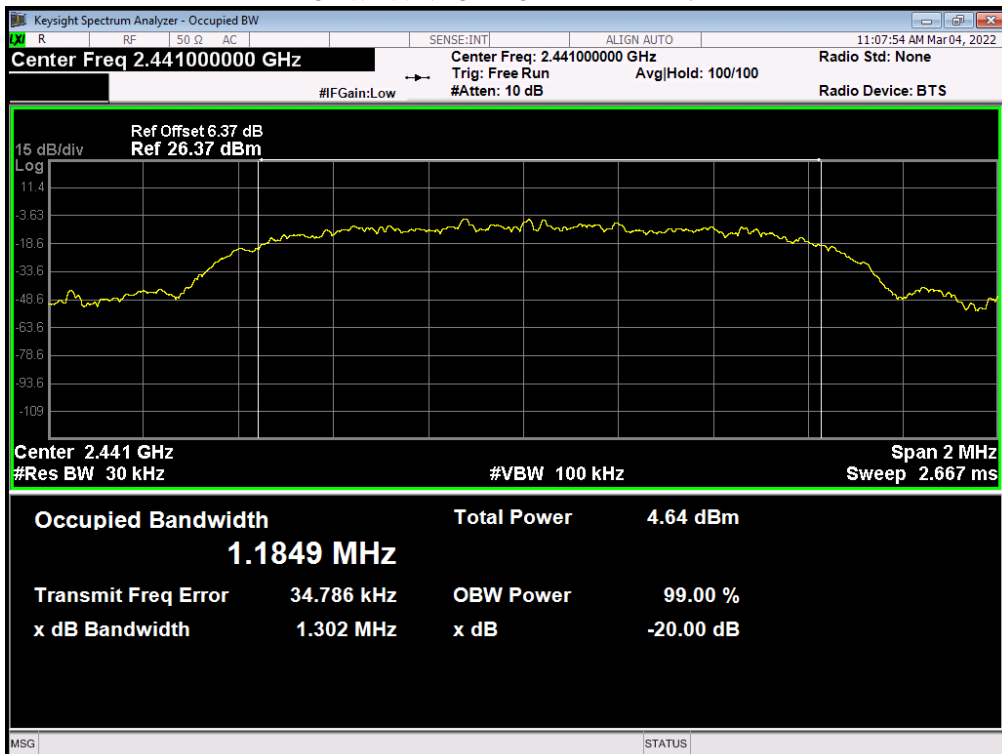

OBW NVNT 3-DH5 2480MHz Ant1

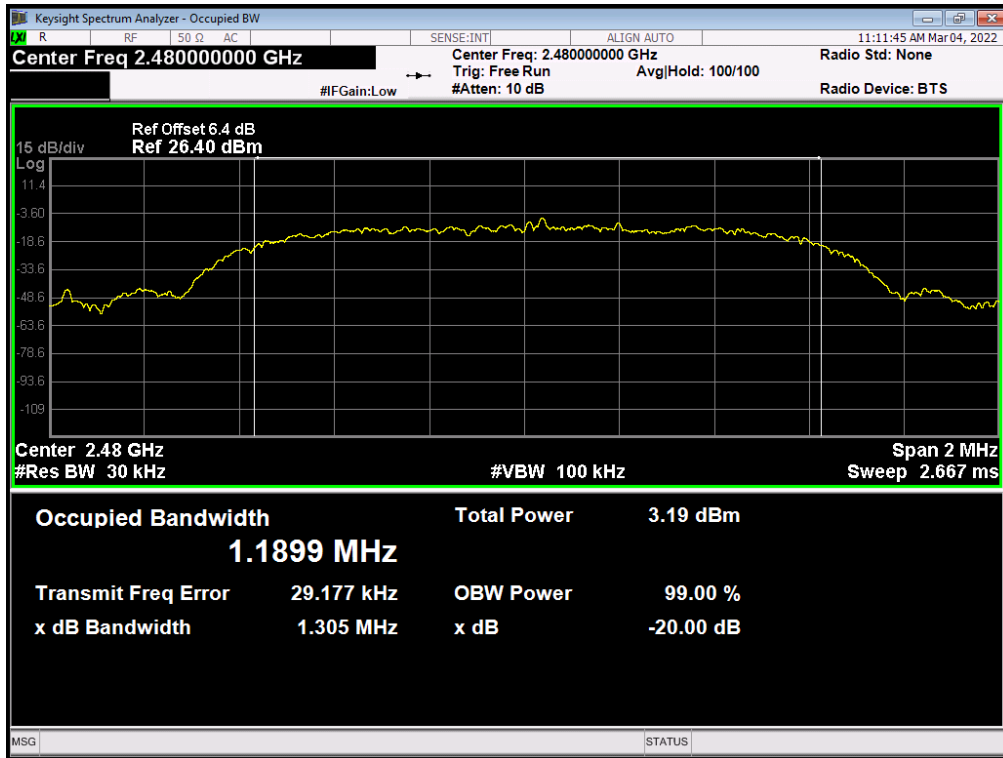

Note: All the modes (1-DH1, 1-DH3,1-DH5,2-DH1,2-DH3,2-DH5,3-DH1,3-DH3,3-DH5) had been test, but only the worst data (1-DH5,2-DH5,3-DH5) record in the report.

7. Carrier Frequencies Separated

7.1. Applied procedures / Limit

15.247(a) (1) Frequency hopping systems shall have hopping channel carrier frequencies separated by a minimum of 25 kHz or the 20 dB bandwidth of the hopping channel, whichever is greater. Alternatively, frequency hopping systems operating in the 2400-2483.5 MHz band may have hopping channel carrier frequencies that are separated by 25 kHz or two-thirds of the 20 dB bandwidth of the hopping channel, whichever is greater, provided the systems operate with an output power no greater than 125 mW.

7.2. Test procedure

- (1) Connected the antenna port to the Spectrum Analyzer, set the Spectrum Analyzer as Span = wide enough to capture the peaks of two adjacent channels, Resolution (or IF) Bandwidth (RBW) \geq 1% of the span, Video (or Average) Bandwidth (VBW) \geq RBW Sweep = auto, Detector function = peak, Trace = max hold
- (2) The EUT should be transmitting at its maximum data rate. Use the marker-delta function to determine the separation between the peaks of the adjacent channels.
- (3) The above procedure shall be repeated at the lowest, the middle, and the highest frequency of the stated frequency range with modulated mode. also shall be performed at different modes of operation.

7.3. Deviation from standard

No deviation.

7.4. Test setup

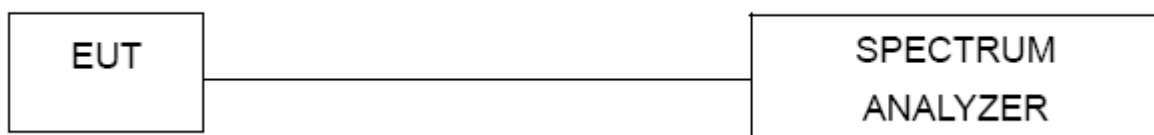

7.5. Test results

Condition	Mode	Hopping Freq1 (MHz)	Hopping Freq2 (MHz)	HFS (MHz)	Limit (MHz)	Verdict
NVNT	1-DH5	2402.185	2402.977	0.792	0.625	Pass
NVNT	1-DH5	2440.978	2442.187	1.209	0.631	Pass
NVNT	1-DH5	2478.963	2480.178	1.215	0.627	Pass

CFS NVNT 1-DH5 2402MHz



CFS NVNT 1-DH5 2441MHz

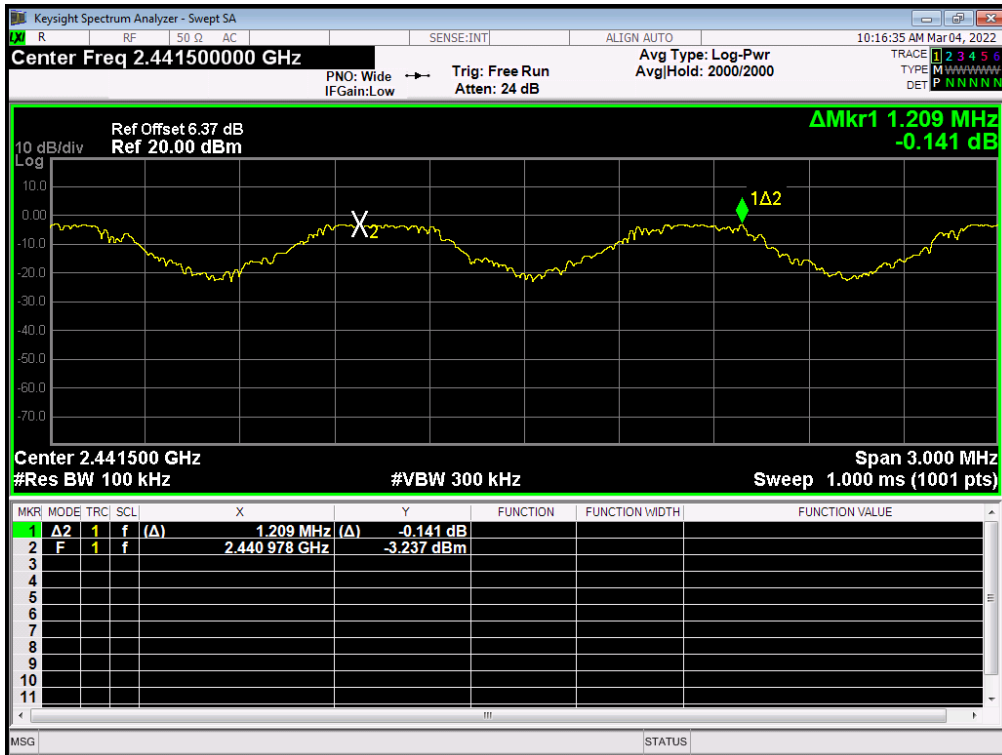

CFS NVNT 1-DH5 2480MHz



Condition	Mode	Hopping Freq1 (MHz)	Hopping Freq2 (MHz)	HFS (MHz)	Limit (MHz)	Verdict
NVNT	2-DH5	2401.852	2403.082	1.230	0.889	Pass
NVNT	2-DH5	2441.008	2442.163	1.155	0.848	Pass
NVNT	2-DH5	2478.873	2480.046	1.173	0.892	Pass

CFS NVNT 2-DH5 2402MHz

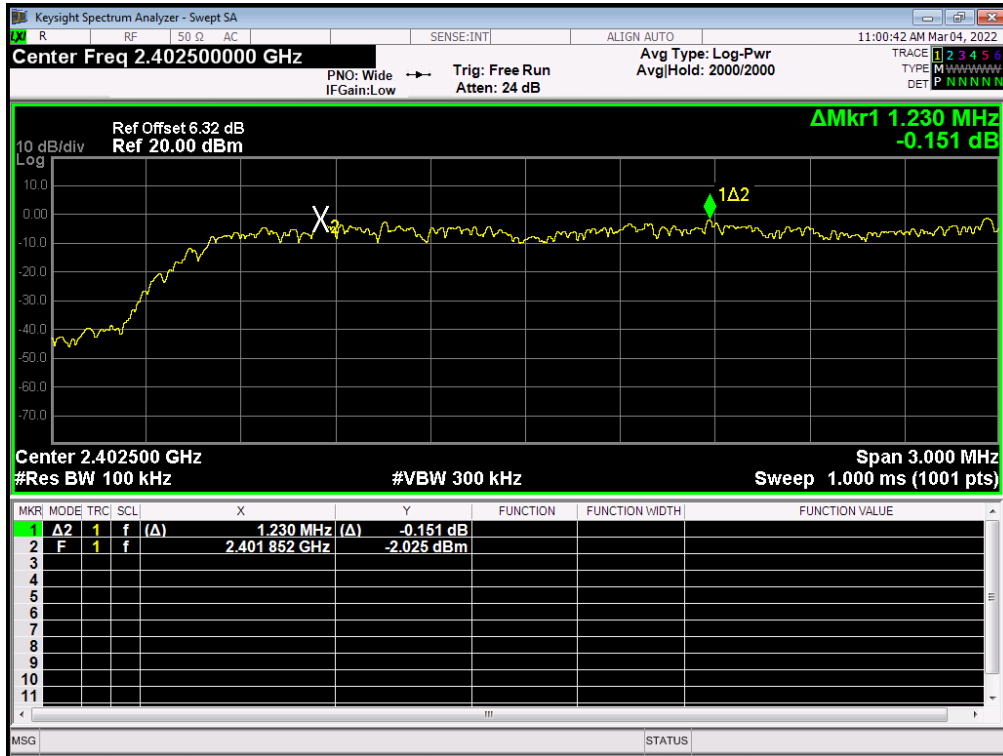

CFS NVNT 2-DH5 2441MHz

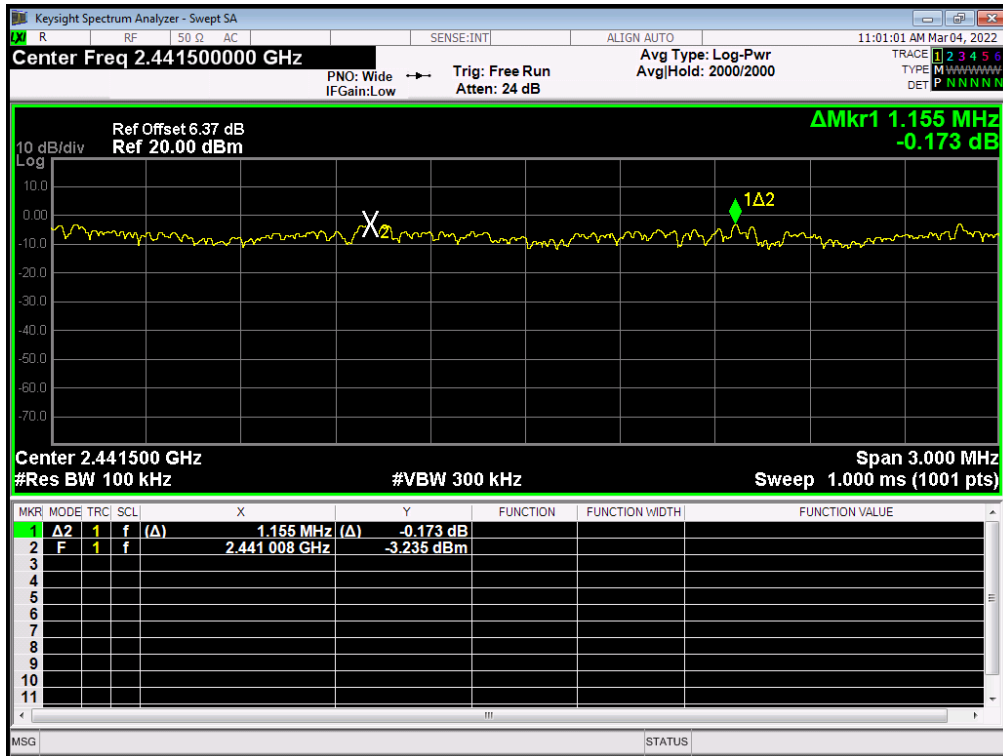

CFS NVNT 2-DH5 2480MHz

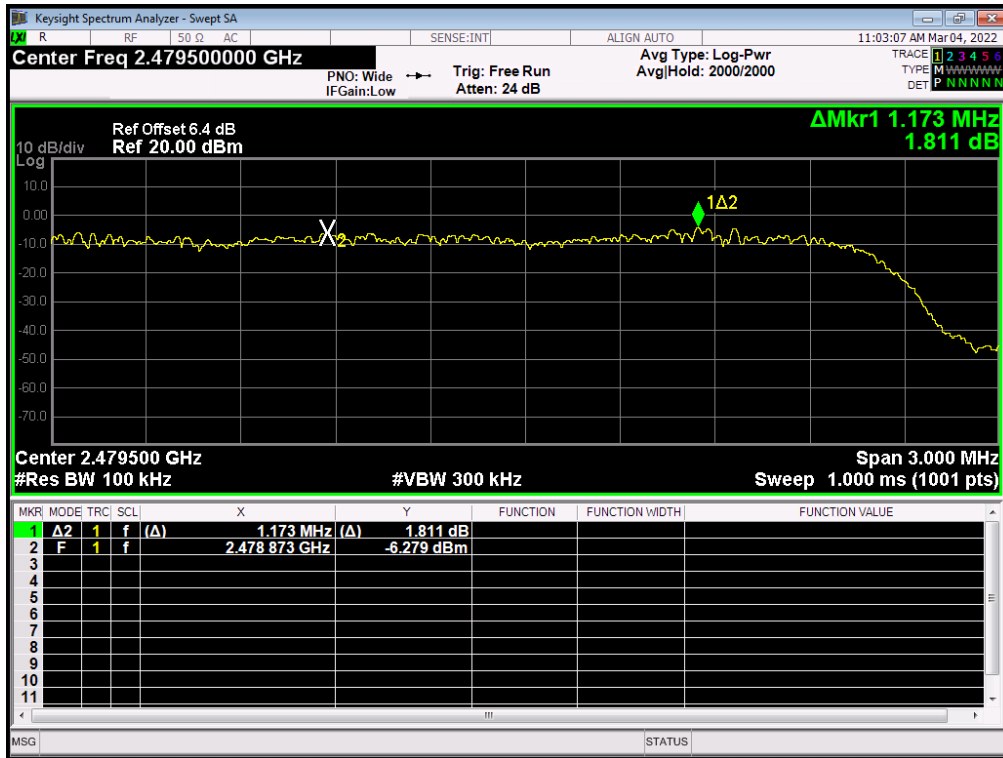

Condition	Mode	Hopping Freq1 (MHz)	Hopping Freq2 (MHz)	HFS (MHz)	Limit (MHz)	Verdict
NVNT	3-DH5	2402.08	2403.184	1.104	0.861	Pass
NVNT	3-DH5	2441.002	2442.028	1.026	0.868	Pass
NVNT	3-DH5	2479.011	2480.190	1.179	0.870	Pass

CFS NVNT 3-DH5 2402MHz

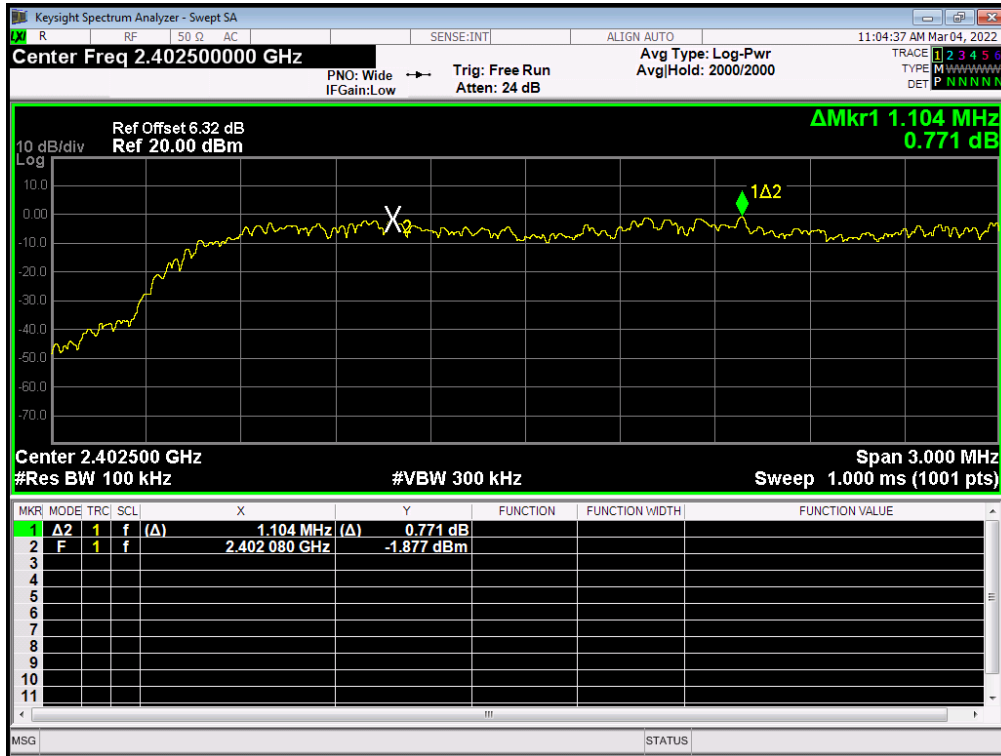

CFS NVNT 3-DH5 2441MHz

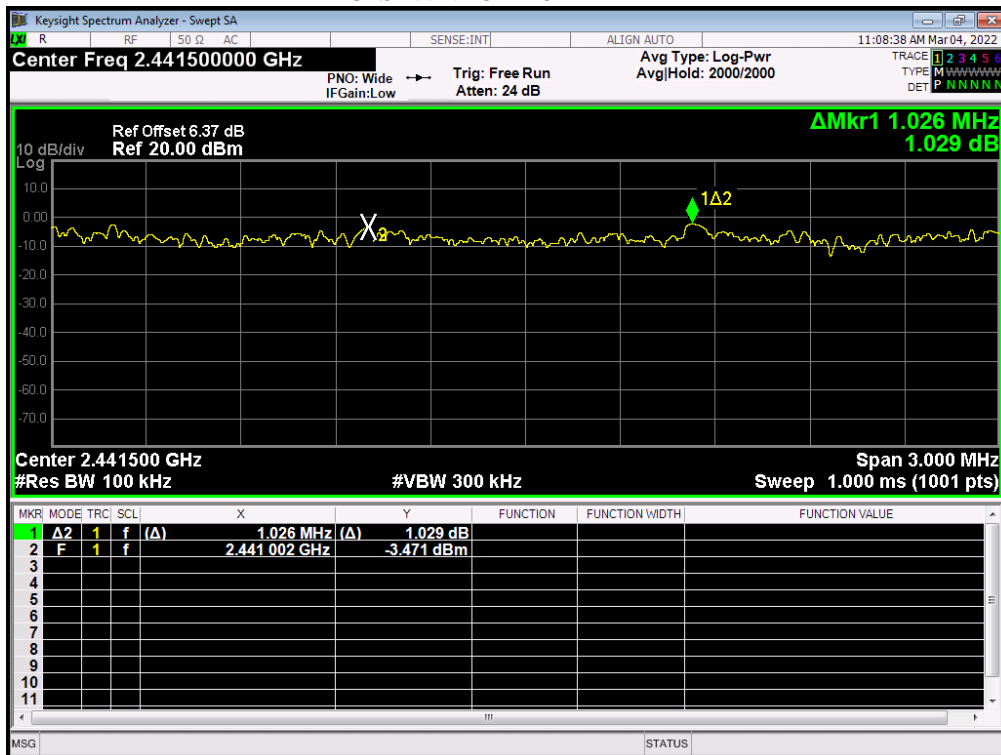

CFS NVNT 3-DH5 2480MHz

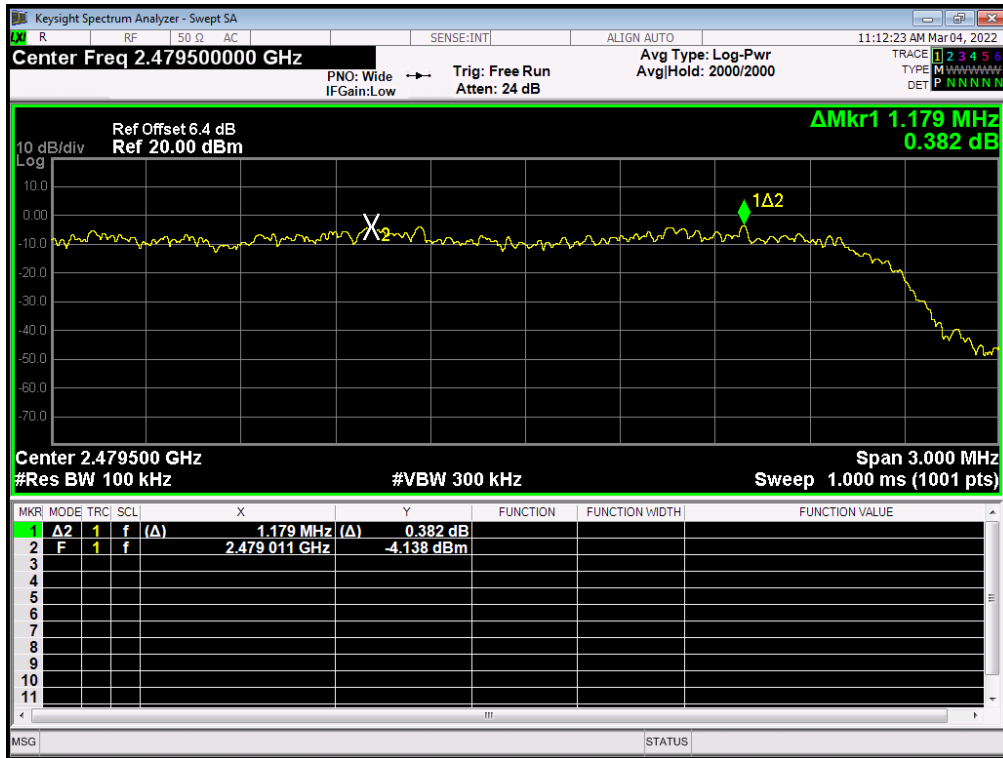

Note: All the modes (1-DH1, 1-DH3,1-DH5,2-DH1,2-DH3,2-DH5,3-DH1,3-DH3,3-DH5) had been test, but only the worst data (1-DH5,2-DH5,3-DH5) record in the report

8. Hopping Channel Number

8.1. Applied procedures / Limit

15.247(a) (1) (iii) Frequency hopping systems in the 2400-2483.5 MHz band shall use at least 15 channels. The average time of occupancy on any channel shall not be greater than 0.4 seconds within a period of 0.4 seconds multiplied by the number of hopping channels employed. Frequency hopping systems may avoid or suppress transmissions on a particular hopping frequency provided that a minimum of 15 channels are used.

8.2. Test procedure

- (1) Connected the antenna port to the Spectrum Analyzer , set the Spectrum Analyzer as
Span = the frequency band of operation, RBW \geq 1% of the span, VBW \geq RBW Sweep = auto
Detector function = peak, Trace = max hold
- (2) The EUT should be have its hopping function enabled. Maxhold and record hopping channels
It may prove necessary to break the span up to sections, in order to clearly show all of the hopping frequencies.

8.3. Deviation from standard

No deviation.

8.4. Test setup

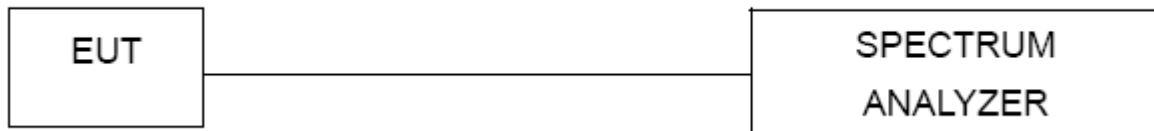

8.5. Test result

Number of Hopping Channel

Description of Channel:					
Channel	Frequency (MHz)	Channel	Frequency (MHz)	Channel	Frequency (MHz)
00	2402	27	2429	54	2456
01	2403	28	2430	55	2457
02	2404	29	2431	56	2458
03	2405	30	2432	57	2459
04	2406	31	2433	58	2460
05	2407	32	2434	59	2461
06	2408	33	2435	60	2462
07	2409	34	2436	61	2463
08	2410	35	2437	62	2464
09	2411	36	2438	63	2465
10	2412	37	2439	64	2466
11	2413	38	2440	65	2467
12	2414	39	2441	66	2468
13	2415	40	2442	67	2469
14	2416	41	2443	68	2470
15	2417	42	2444	69	2471
16	2418	43	2445	70	2472
17	2419	44	2446	71	2473
18	2420	45	2447	72	2474
19	2421	46	2448	73	2475
20	2422	47	2449	74	2476
21	2423	48	2450	75	2477
22	2424	49	2451	76	2478
23	2425	50	2452	77	2479
24	2426	51	2453	78	2480
25	2427	52	2454		
26	2428	53	2455		

Condition	Mode	Hopping Number	Limit	Verdict
NVNT	1-DH5	79	15	Pass
NVNT	1-DH5	79	15	Pass
NVNT	1-DH5	79	15	Pass

Hopping No. NVNT 1-DH5 2402MHz

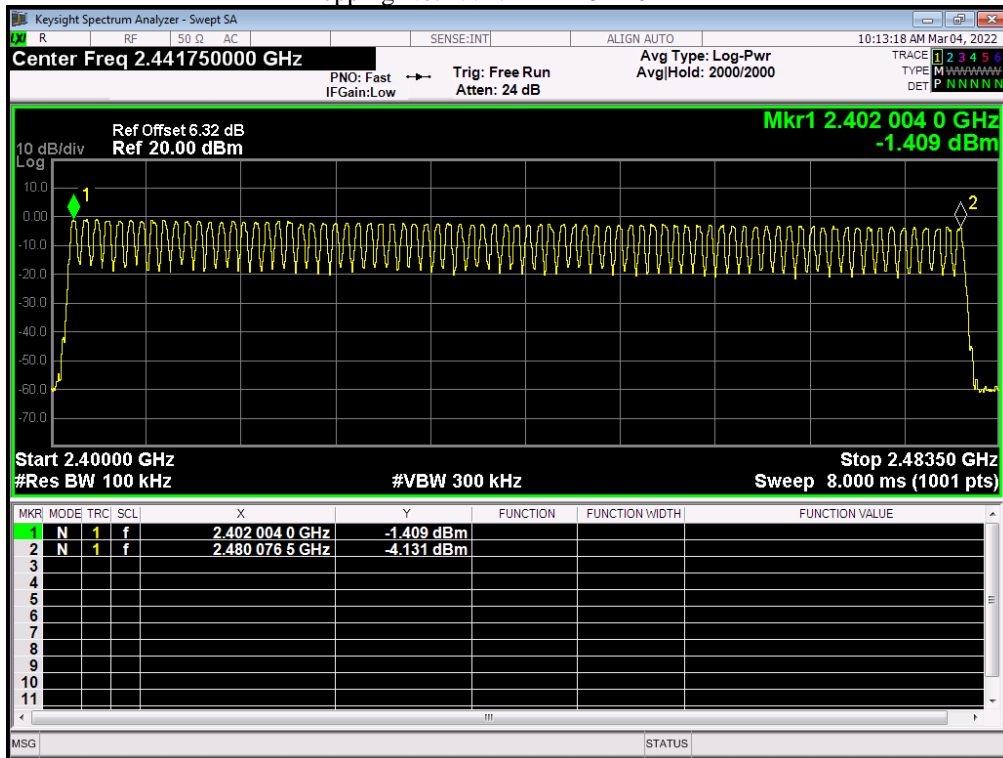

Hopping No. NVNT 1-DH5 2441MHz

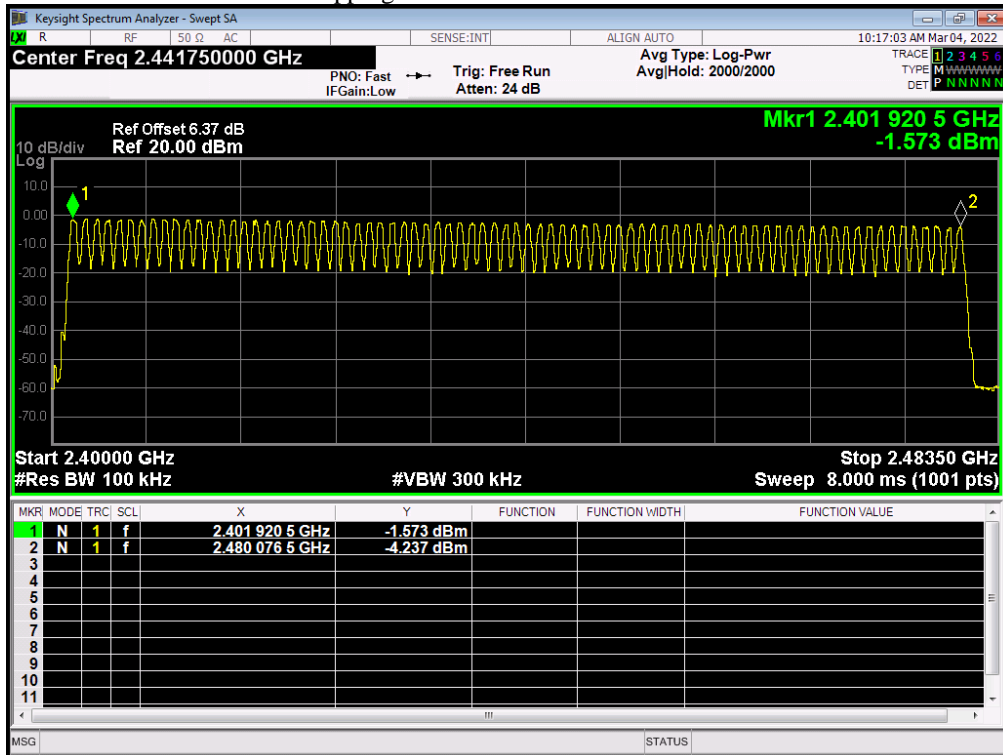

Hopping No. NVNT 1-DH5 2480MHz

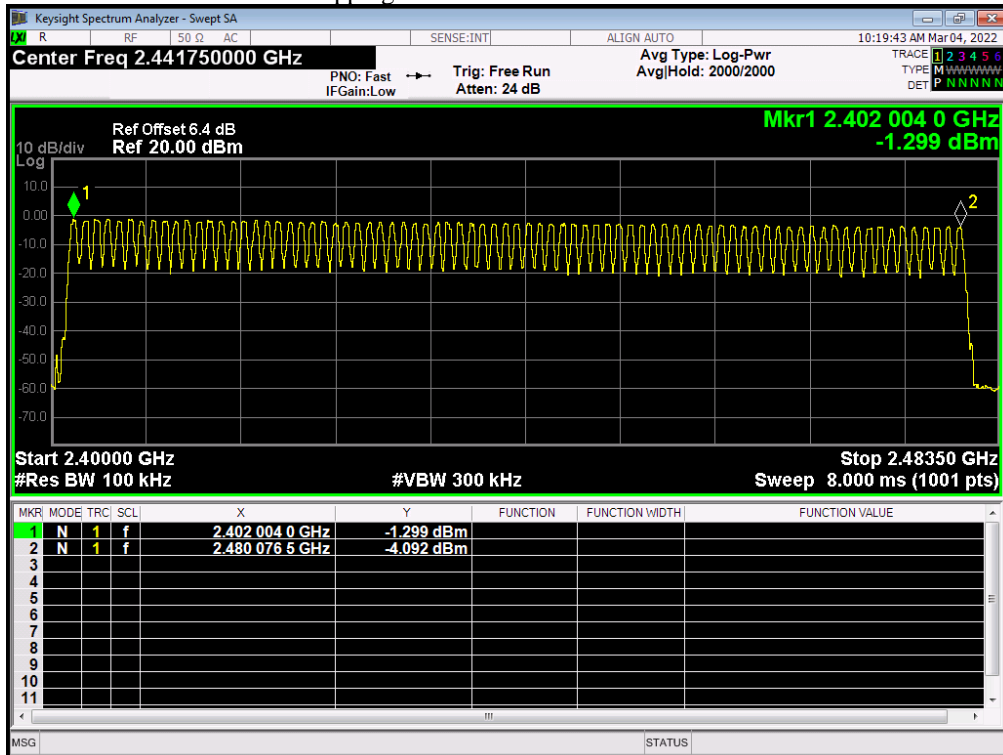

Condition	Mode	Hopping Number	Limit	Verdict
NVNT	2-DH5	79	15	Pass
NVNT	2-DH5	79	15	Pass
NVNT	2-DH5	79	15	Pass

Hopping No. NVNT 2-DH5 2402MHz

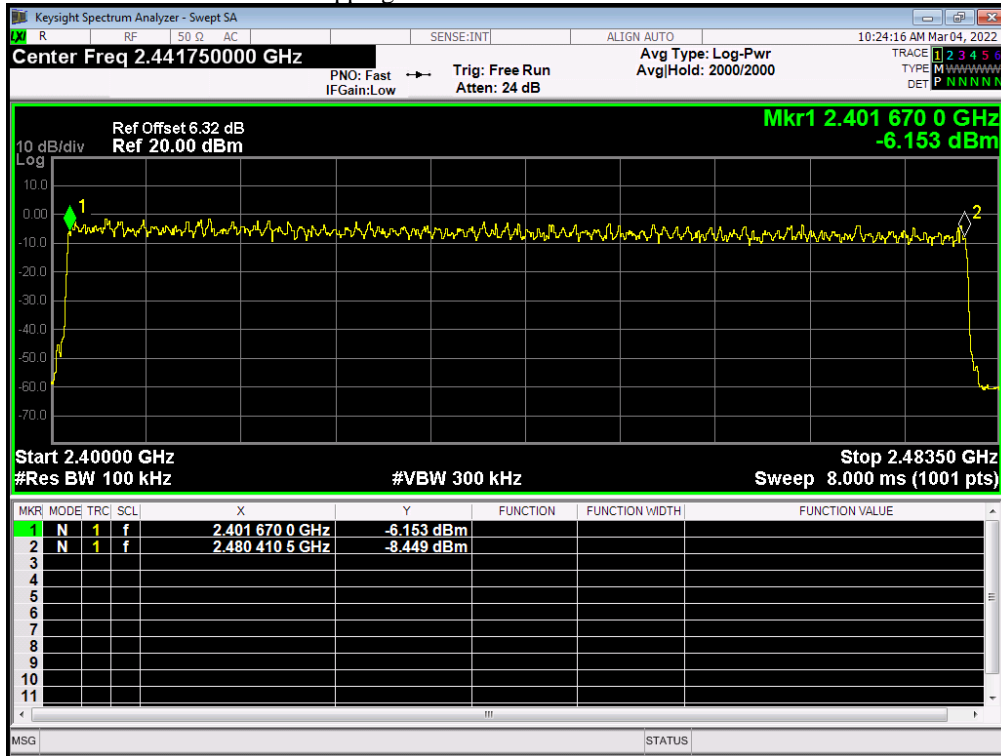

Hopping No. NVNT 2-DH5 2441MHz

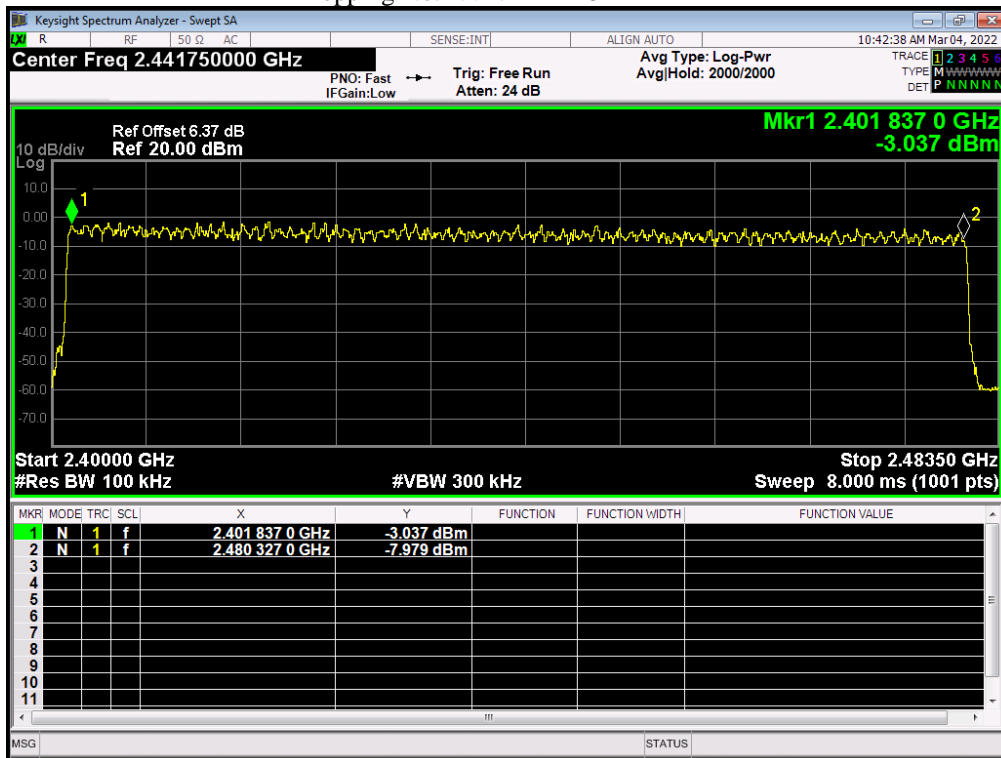

Hopping No. NVNT 2-DH5 2480MHz

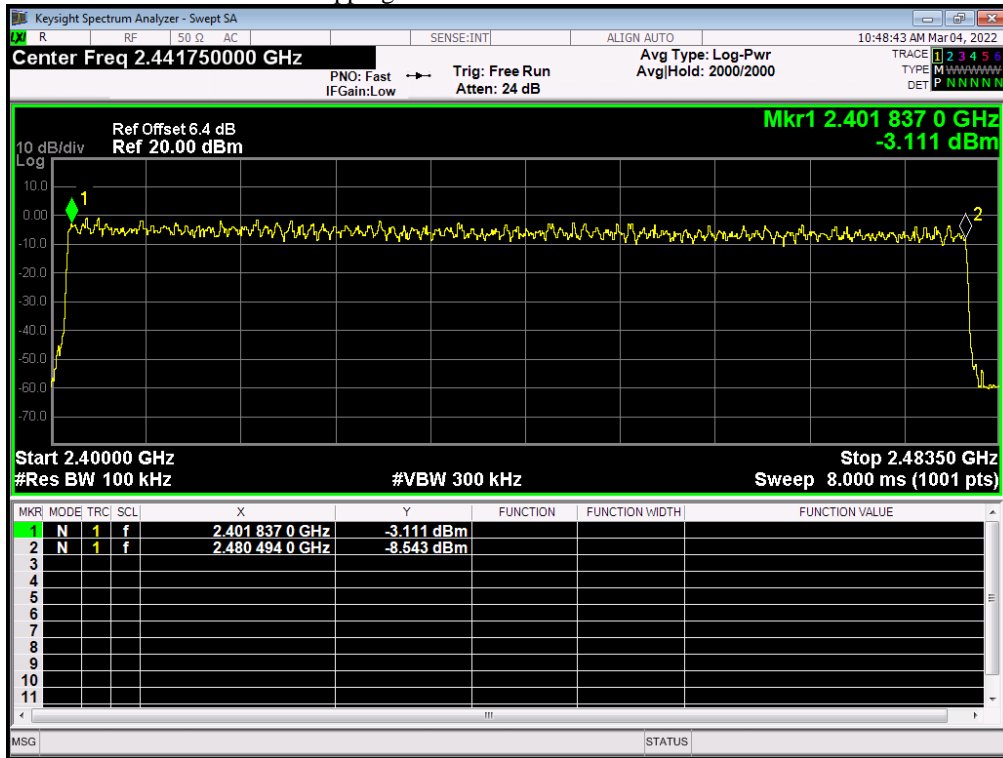

Condition	Mode	Hopping Number	Limit	Verdict
NVNT	3-DH5	79	15	Pass
NVNT	3-DH5	79	15	Pass
NVNT	3-DH5	79	15	Pass

Hopping No. NVNT 3-DH5 2402MHz

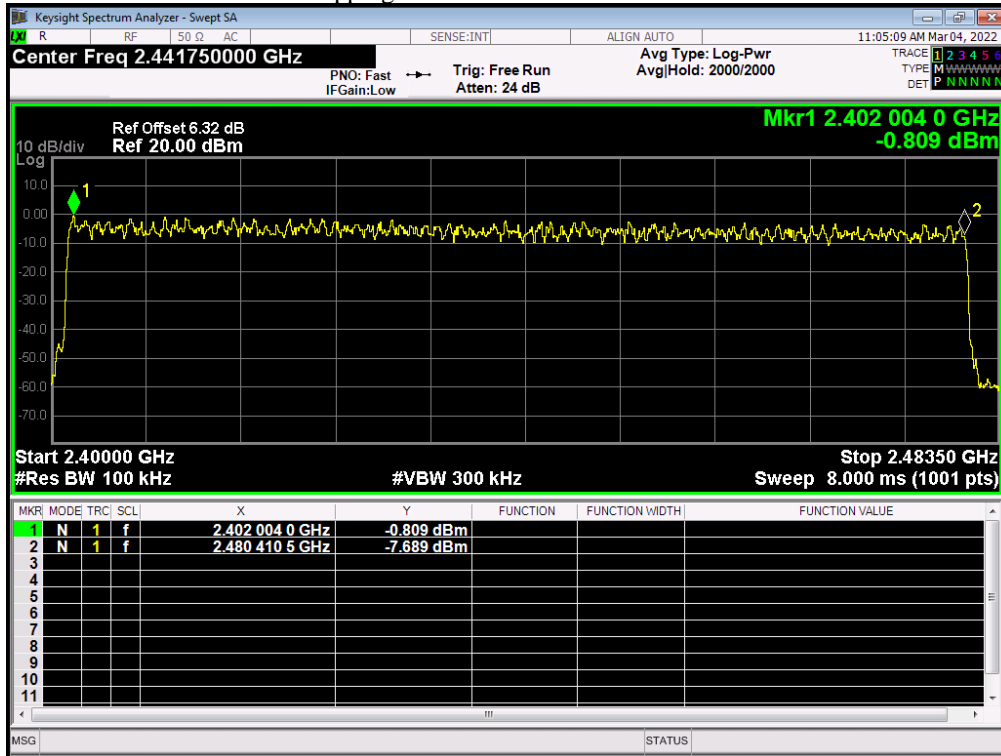

Hopping No. NVNT 3-DH5 2441MHz

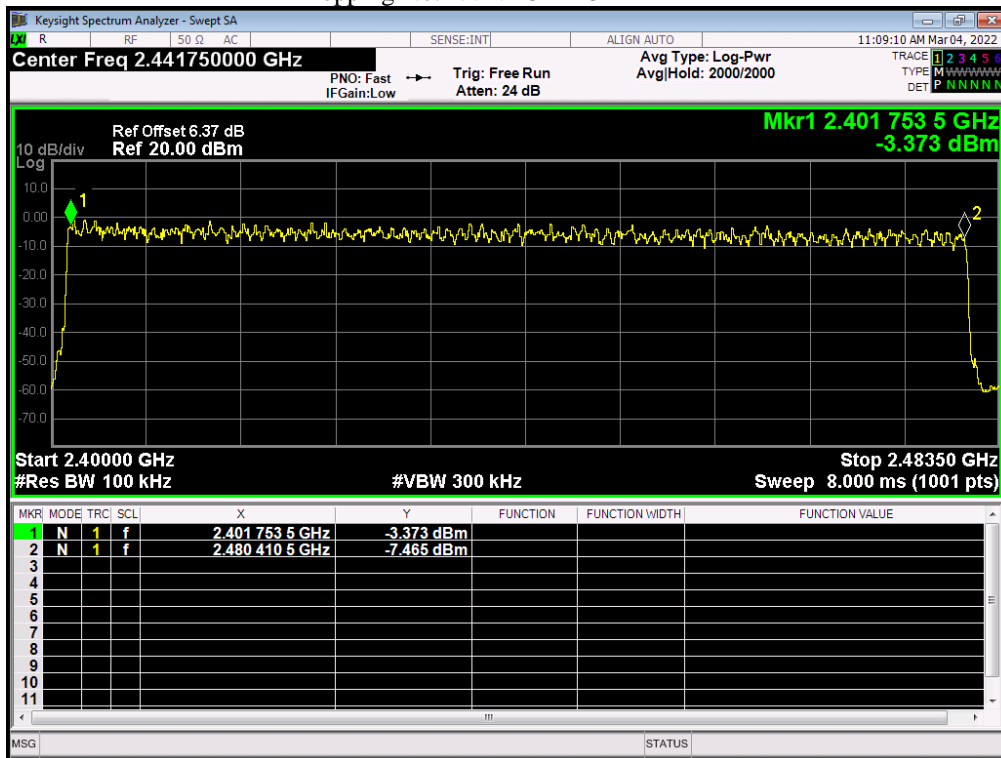

Hopping No. NVNT 3-DH5 2480MHz

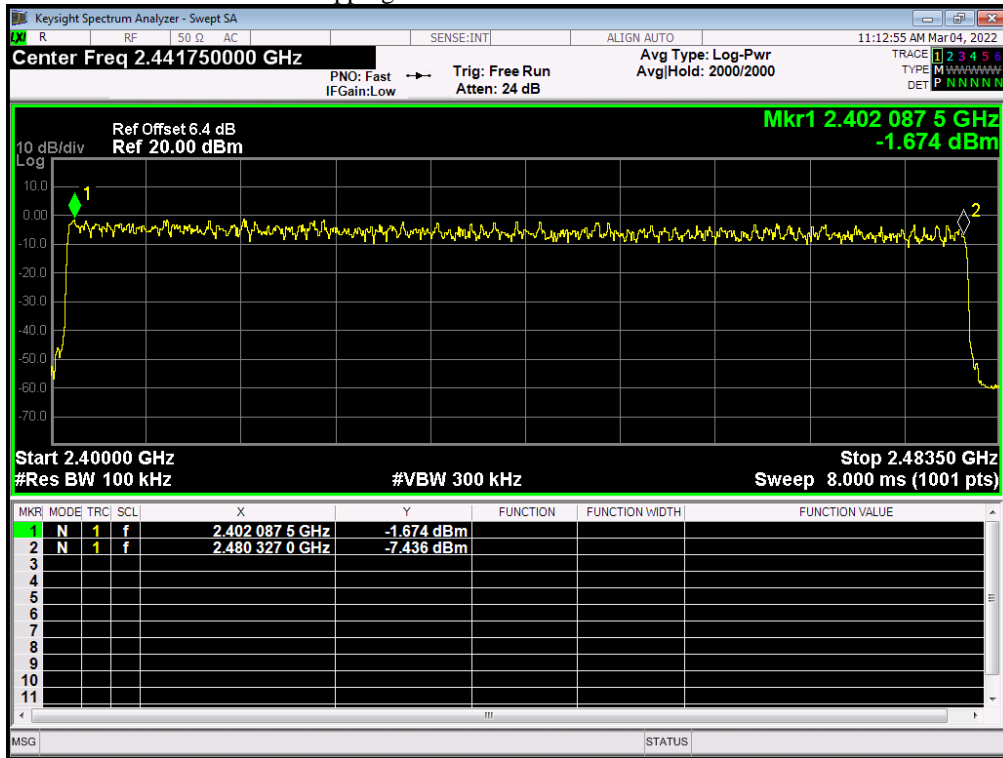

Note: All the modes (1-DH1, 1-DH3,1-DH5,2-DH1,2-DH3,2-DH5,3-DH1,3-DH3,3-DH5) had been test, but only the worst data (1-DH5,2-DH5,3-DH5) record in the report.

9. Dwell time

9.1. Applied procedures / Limit

15.247(a) (1) (iii) Frequency hopping systems in the 2400-2483.5 MHz band shall use at least 15 channels. The average time of occupancy on any channel shall not be greater than 0.4 seconds within a period of 0.4 seconds multiplied by the number of hopping channels employed. Frequency hopping systems may avoid or suppress transmissions on a particular hopping frequency provided that a minimum of 15 channels are used.

9.2. Test procedure

- (1) Place the EUT on the table in the chamber or connect the antenna port of the EUT to spectrum analyzer and set it in transmitting mode.
- (2) Set RBW of spectrum analyzer to 1MHz, $VBW \geq RBW$
- (3) Use a video trigger with the trigger level set to enable triggering only on full pulses.
- (4) Sweep Time is more than once pulse time.
- (5) Set the center frequency on any frequency would be measure and set the frequency span to zero span.
- (6) Measure the maximum time duration of one single pulse.
- (7) Set the EUT for DH5, DH3 and DH1 packet transmitting.
- (8) Measure the maximum time duration of one single pulse.
- (9) A Period Time = $79 \times 0.4 = 31.6$ S
DH1 Time Slot: Reading * $(1600/2) \times 31.6/79$
DH3 Time Slot: Reading * $(1600/4) \times 31.6/79$
DH5 Time Slot: Reading * $(1600/6) \times 31.6/79$

9.3. Deviation from standard

No deviation.

9.4. Test setup



Test result

Condition	Mode	Frequency (MHz)	Pulse Time (ms)	Total Dwell Time (ms)	Period Time (ms)	Limit (ms)	Verdict
NVNT	1-DH1	2441	0.385	123.2	31600	400	Pass

Dwell NVNT 1-DH1 2441MHz

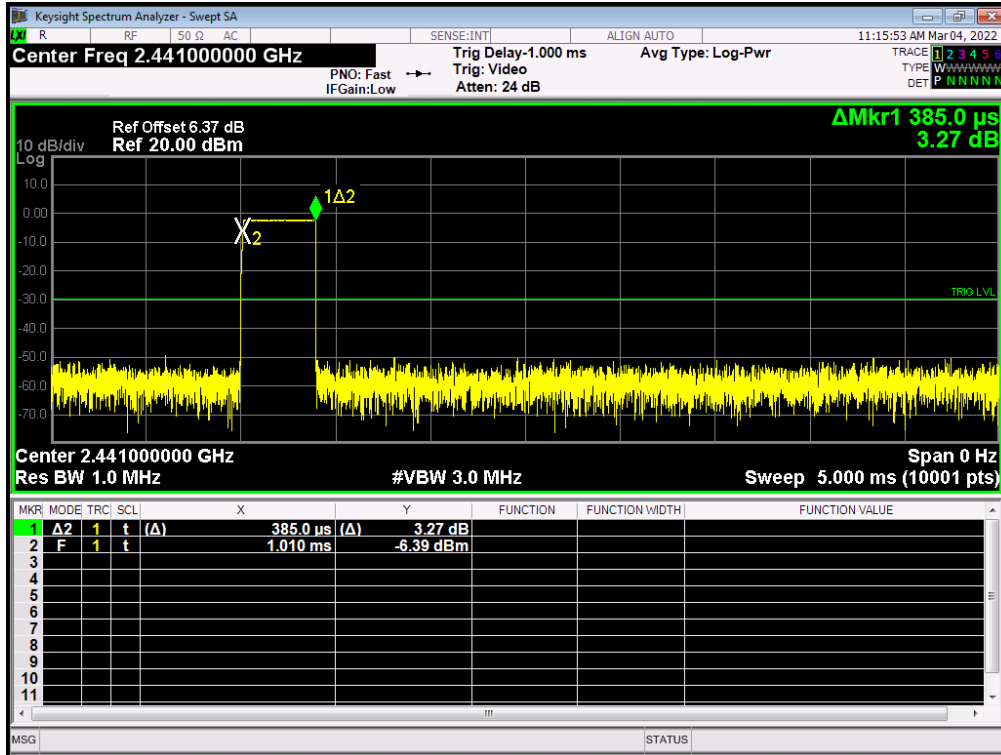

Condition	Mode	Frequency (MHz)	Pulse Time (ms)	Total Dwell Time (ms)	Period Time (ms)	Limit (ms)	Verdict
NVNT	1-DH3	2441	1.641	262.56	31600	400	Pass

Dwell NVNT 1-DH3 2441MHz

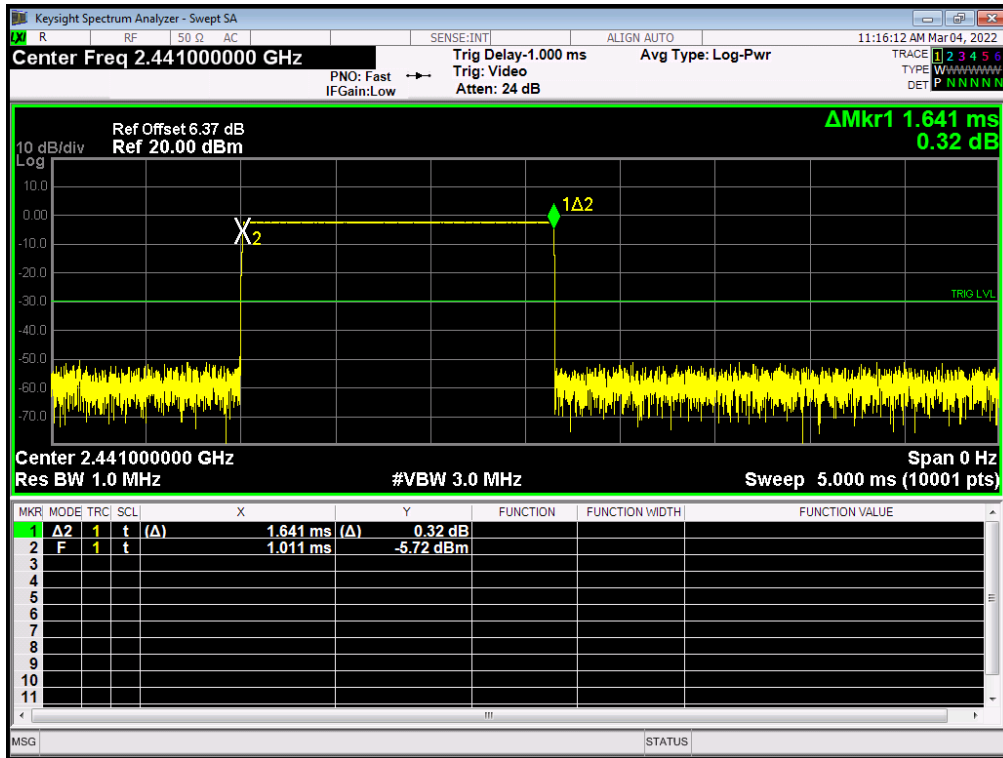

Condition	Mode	Frequency (MHz)	Pulse Time (ms)	Total Dwell Time (ms)	Period Time (ms)	Limit (ms)	Verdict
NVNT	1-DH5	2441	2.887	307.947	31600	400	Pass

Dwell NVNT 1-DH5 2441MHz

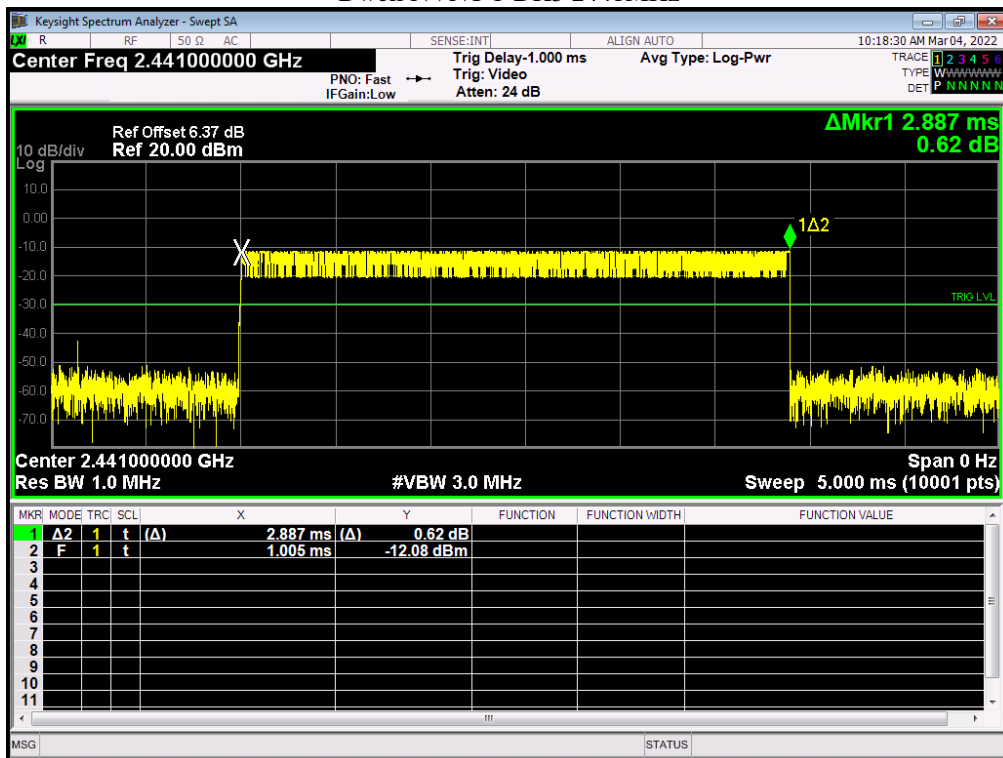

Condition	Mode	Frequency (MHz)	Pulse Time (ms)	Total Dwell Time (ms)	Period Time (ms)	Limit (ms)	Verdict
NVNT	2-DH1	2441	0.393	125.76	31600	400	Pass

Dwell NVNT 2-DH1 2441MHz

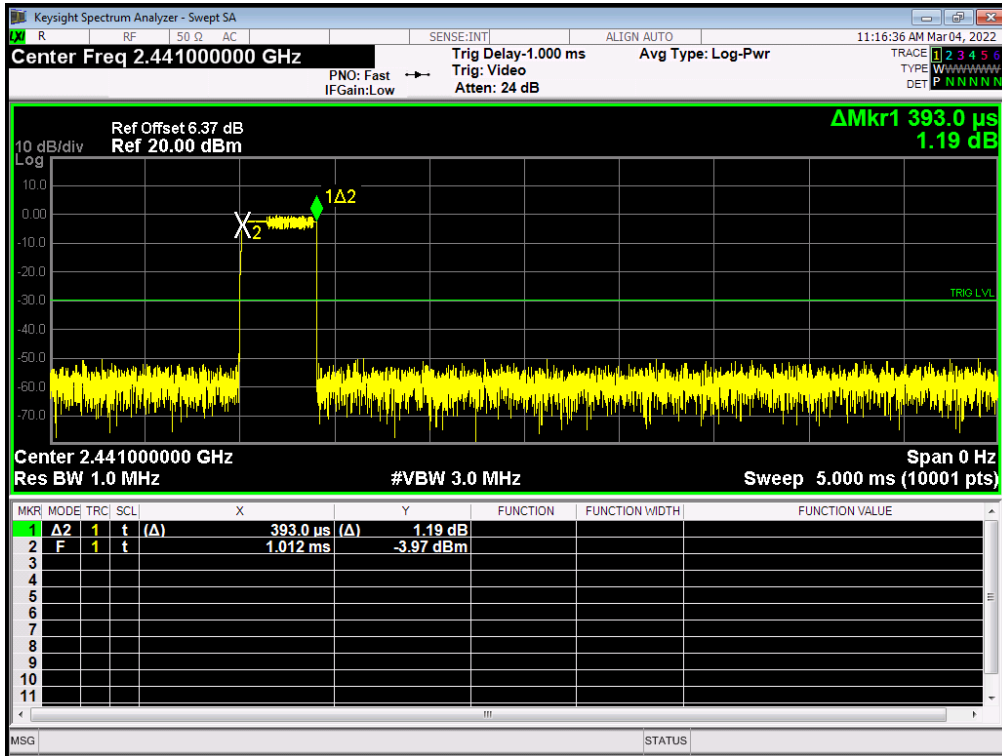

Condition	Mode	Frequency (MHz)	Pulse Time (ms)	Total Dwell Time (ms)	Period Time (ms)	Limit (ms)	Verdict
NVNT	2-DH3	2441	1.643	262.88	31600	400	Pass

Dwell NVNT 2-DH3 2441MHz

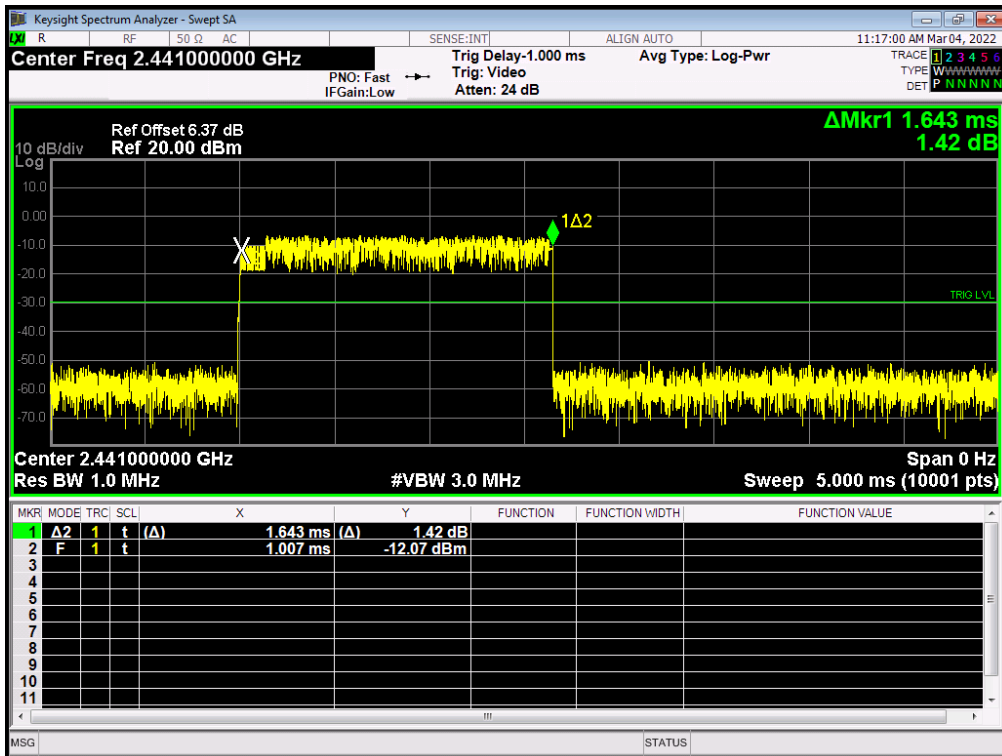

Condition	Mode	Frequency (MHz)	Pulse Time (ms)	Total Dwell Time (ms)	Period Time (ms)	Limit (ms)	Verdict
NVNT	2-DH5	2441	2.894	308.693	31600	400	Pass

Dwell NVNT 2-DH5 2441MHz

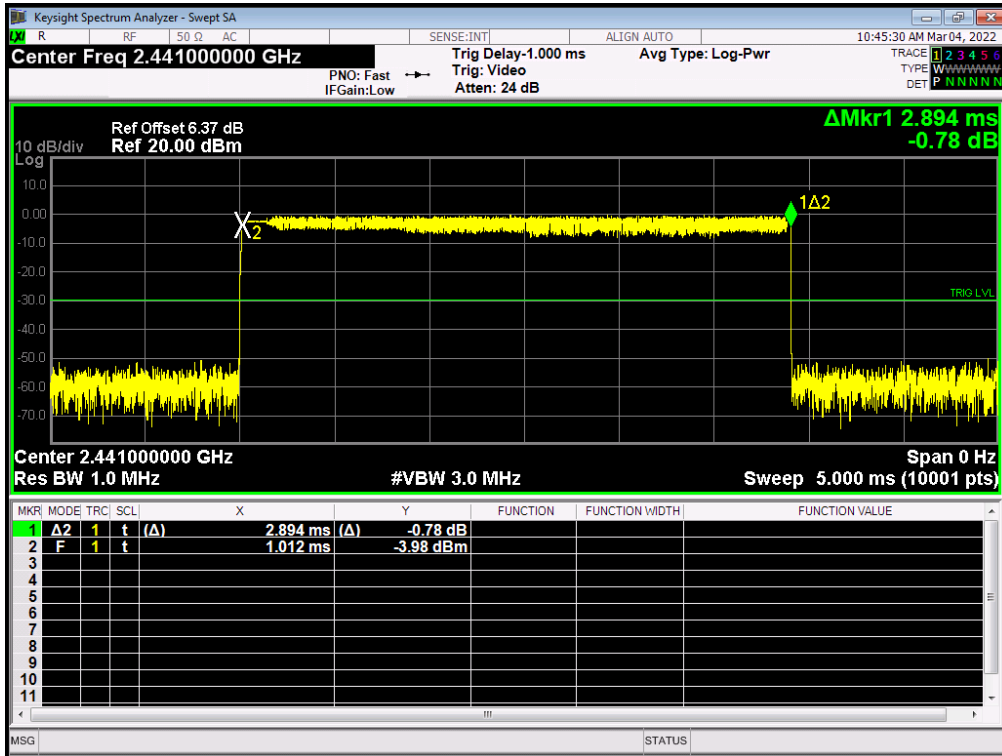

Condition	Mode	Frequency (MHz)	Pulse Time (ms)	Total Dwell Time (ms)	Period Time (ms)	Limit (ms)	Verdict
NVNT	3-DH1	2441	0.395	126.4	31600	400	Pass

Dwell NVNT 3-DH1 2441MHz

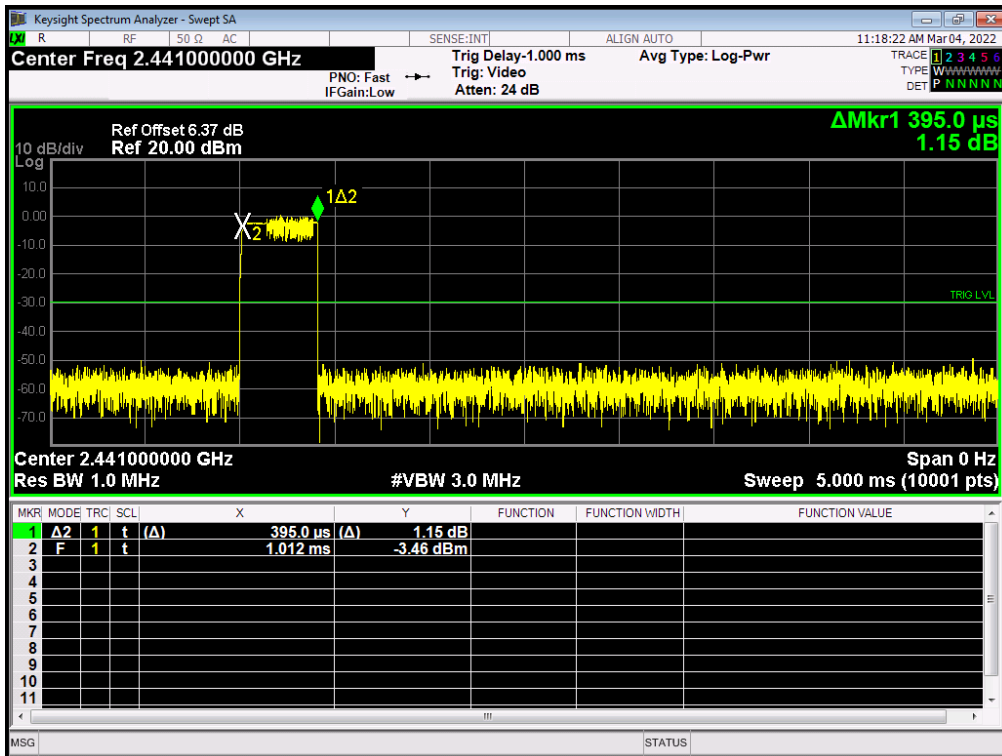

Condition	Mode	Frequency (MHz)	Pulse Time (ms)	Total Dwell Time (ms)	Period Time (ms)	Limit (ms)	Verdict
NVNT	3-DH3	2441	1.624	259.84	31600	400	Pass

Dwell NVNT 3-DH3 2441MHz

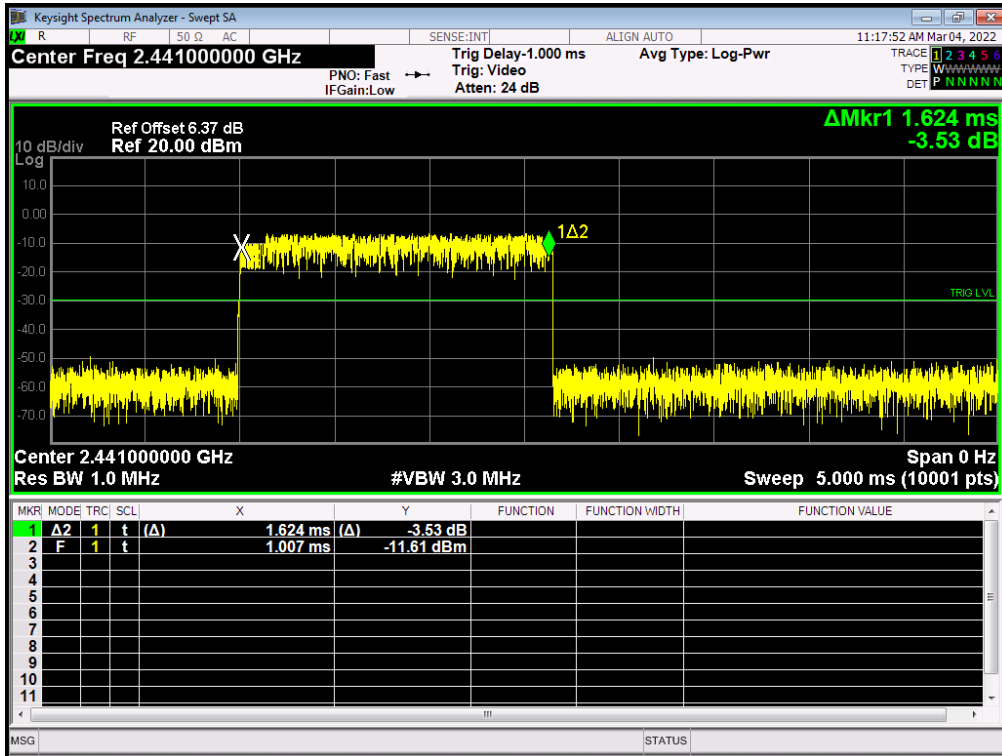

Condition	Mode	Frequency (MHz)	Pulse Time (ms)	Total Dwell Time (ms)	Period Time (ms)	Limit (ms)	Verdict
NVNT	3-DH5	2441	2.896	308.907	31600	400	Pass

Dwell NVNT 3-DH5 2441MHz

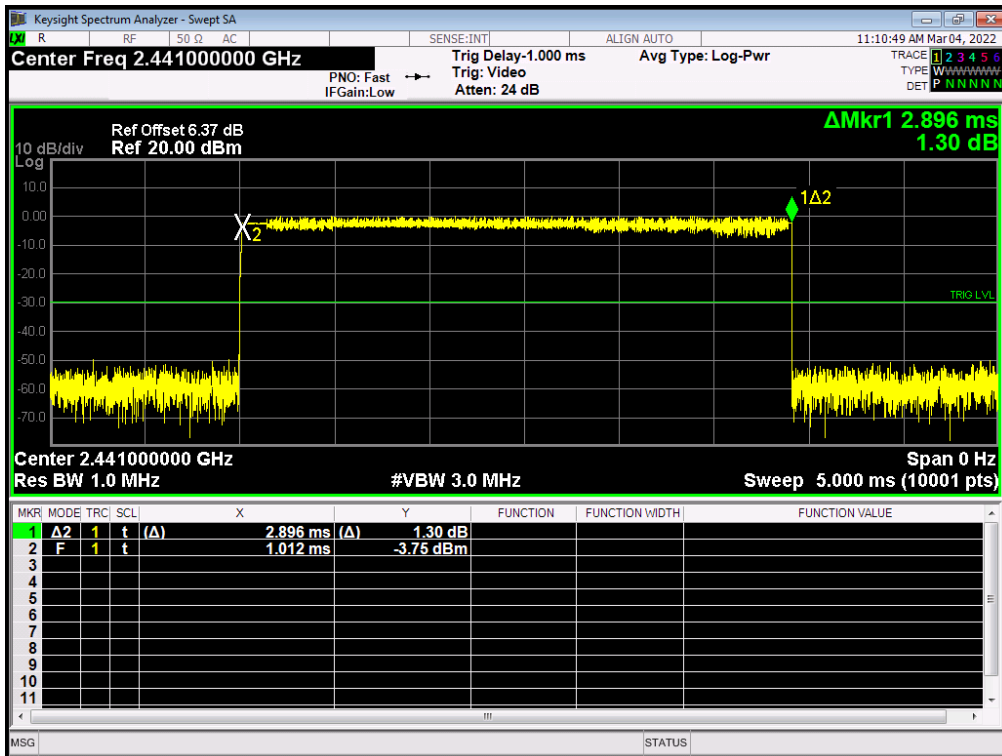

Note: All the modes (1-DH1, 1-DH3,1-DH5,2-DH1,2-DH3,2-DH5,3-DH1,3-DH3,3-DH5) had been test.

10. Band edge

10.1. Applied procedures / Limit

15.247(d) In any 100 kHz bandwidth outside the frequency band in which the spread spectrum or digitally modulated intentional radiator is operating, the radio frequency power that is produced by the intentional radiator shall be at least 20 dB below that in the 100 kHz bandwidth within the band that contains the highest level of the desired power, based on either an RF conducted or a radiated measurement, provided the transmitter demonstrates compliance with the peak conducted power limits. If the transmitter complies with the conducted power limits based on the use of RMS averaging over a time interval, as permitted under paragraph (b)(3) of this section, the attenuation required under this paragraph shall be 30 dB instead of 20 dB. Attenuation below the general limits specified in Section 15.209(a) is not required. In addition, radiated emissions which fall in the restricted bands, as defined in Section 15.205(a), must also comply with the radiated emission limits specified in Section 15.209(a) (see Section 15.205(c)).

10.2. Test procedure

- a. The EUT was directly connected to the spectrum analyzer and antenna output port as show in the block diagram below.
- b. Span = wide enough to capture the peak level of the emission operating on the channel closest to the band edge, as well as any modulation products which fall outside of the authorized band of operation, $RBW \geq 1\%$ of the span, $VBW \geq RBW$, Sweep = auto, Detector function = peak, Trace = max hold

10.3. Deviation from standard

No deviation.

10.4. Test setup

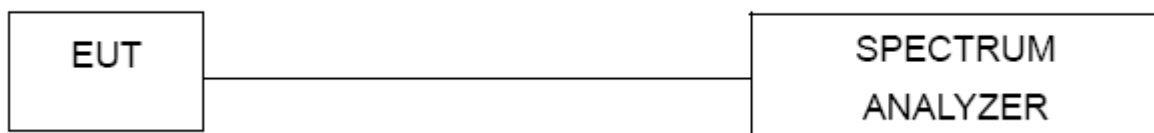

10.5. Test results

Condition	Mode	Frequency (MHz)	Antenna	Hopping Mode	Max Value (dBc)	Limit (dBc)	Verdict
NVNT	1-DH5	2402	Ant 1	No-Hopping	-56.374	-20	Pass
NVNT	1-DH5	2480	Ant 1	No-Hopping	-53.695	-20	Pass

Band Edge NVNT 1-DH5 2402MHz Ant1 No-Hopping Ref

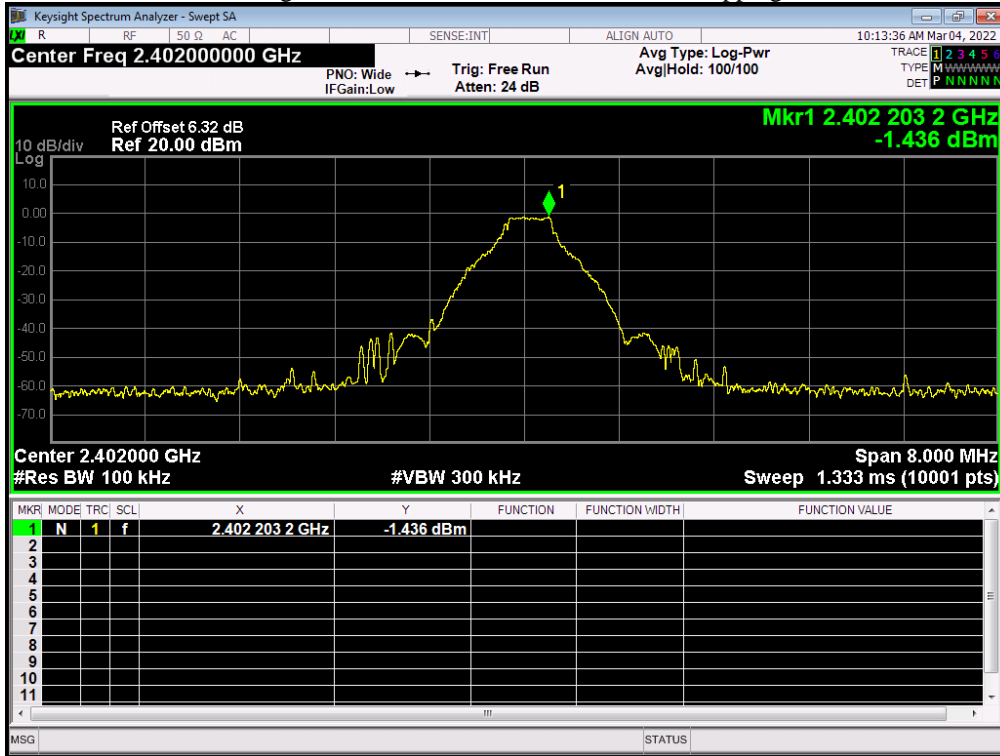

Band Edge NVNT 1-DH5 2402MHz Ant1 No-Hopping Emission

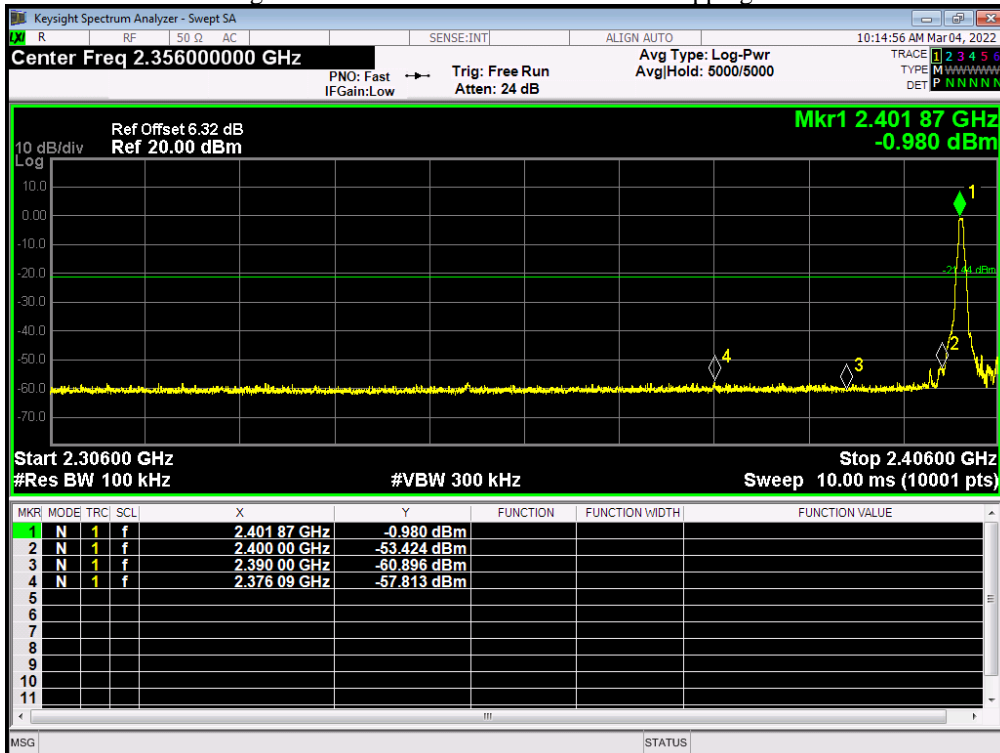

Band Edge NVNT 1-DH5 2480MHz Ant1 No-Hopping Ref

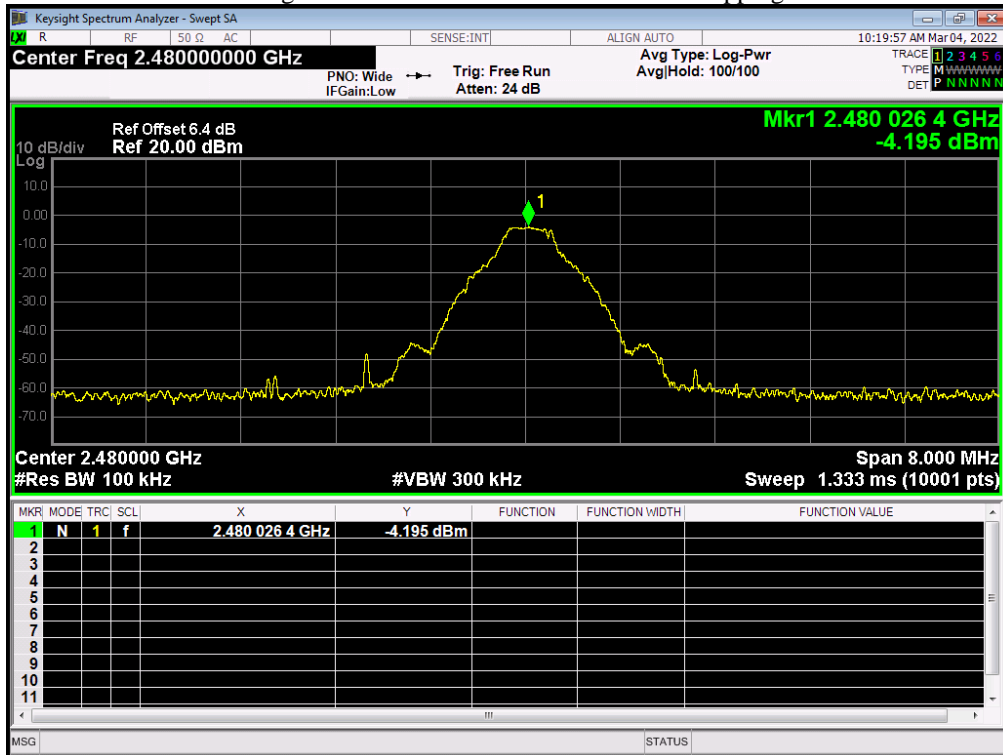

Band Edge NVNT 1-DH5 2480MHz Ant1 No-Hopping Emission

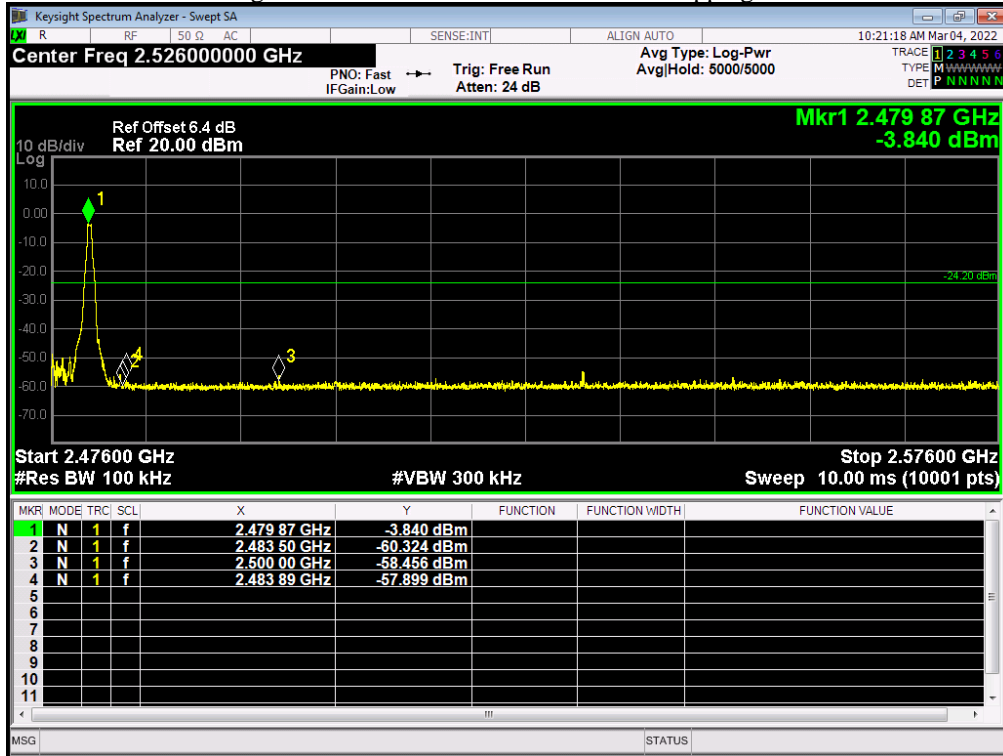

Condition	Mode	Frequency (MHz)	Antenna	Hopping Mode	Max Value (dBc)	Limit (dBc)	Verdict
NVNT	2-DH5	2402	Ant 1	No-Hopping	-50.686	-20	Pass
NVNT	2-DH5	2480	Ant 1	No-Hopping	-53.397	-20	Pass

Band Edge NVNT 2-DH5 2402MHz Ant1 No-Hopping Ref

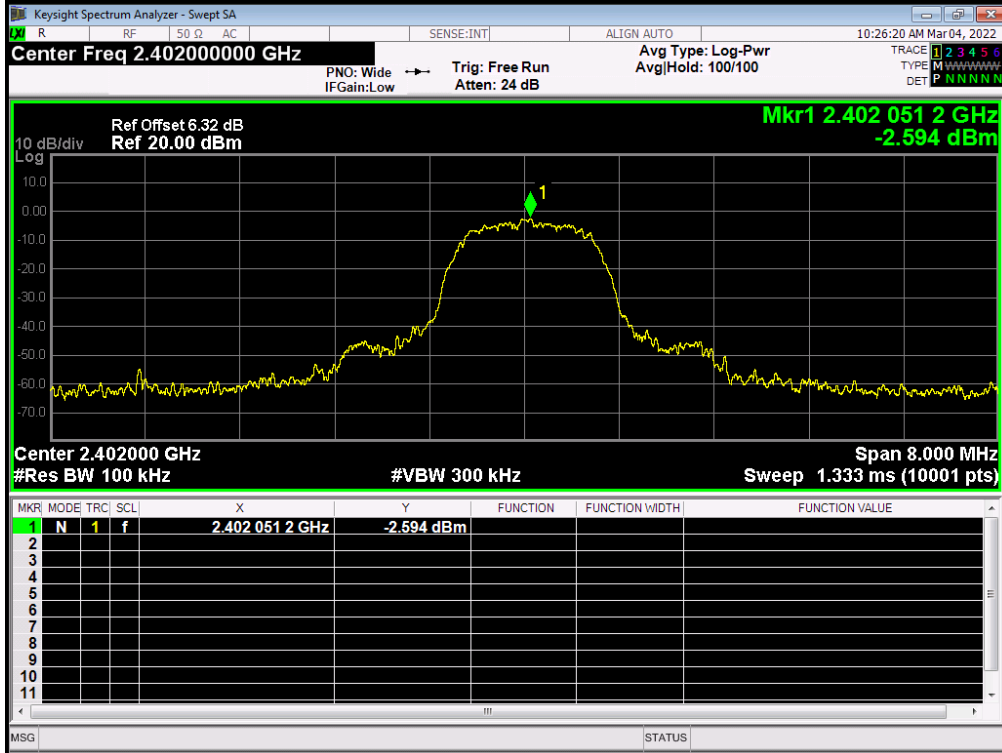

Band Edge NVNT 2-DH5 2402MHz Ant1 No-Hopping Emission

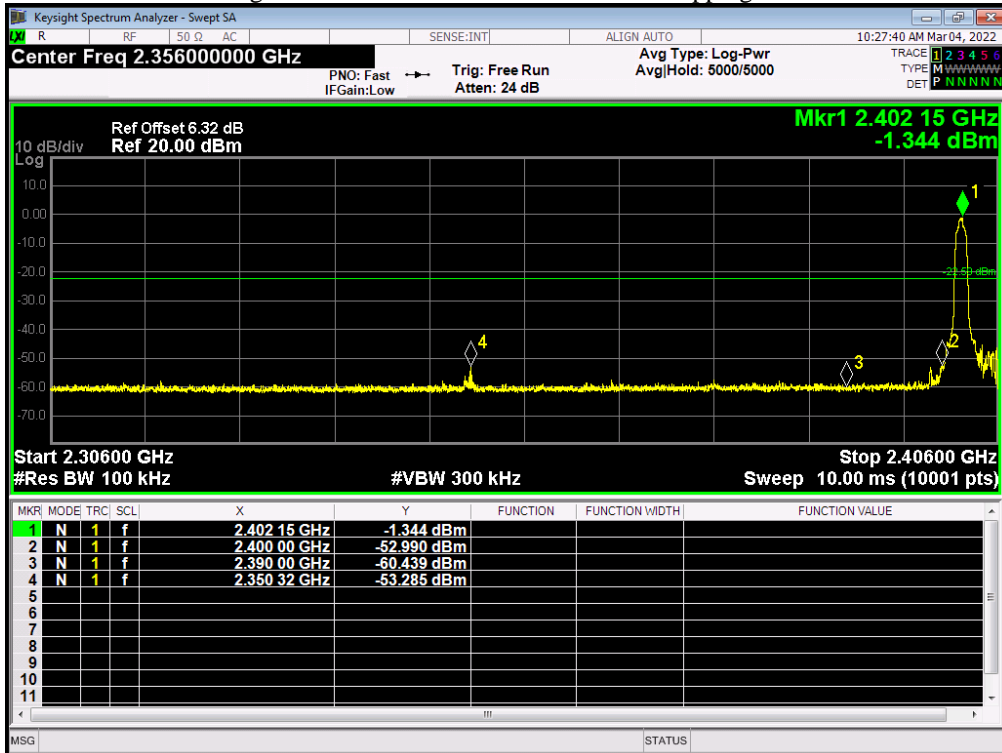

Band Edge NVNT 2-DH5 2480MHz Ant1 No-Hopping Ref

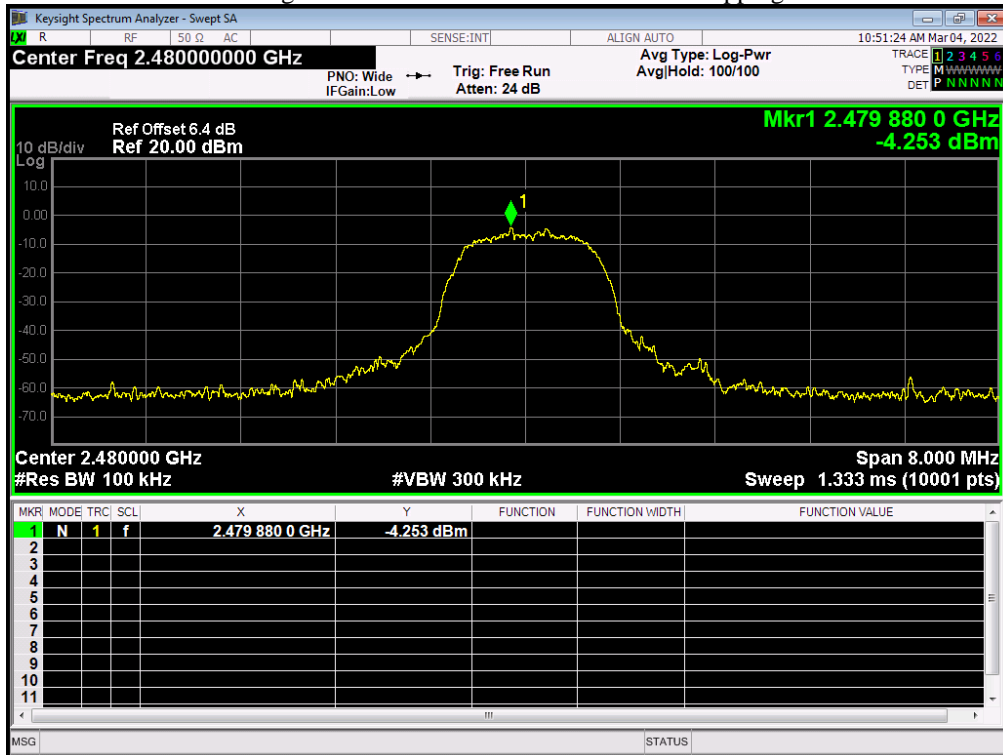

Band Edge NVNT 2-DH5 2480MHz Ant1 No-Hopping Emission

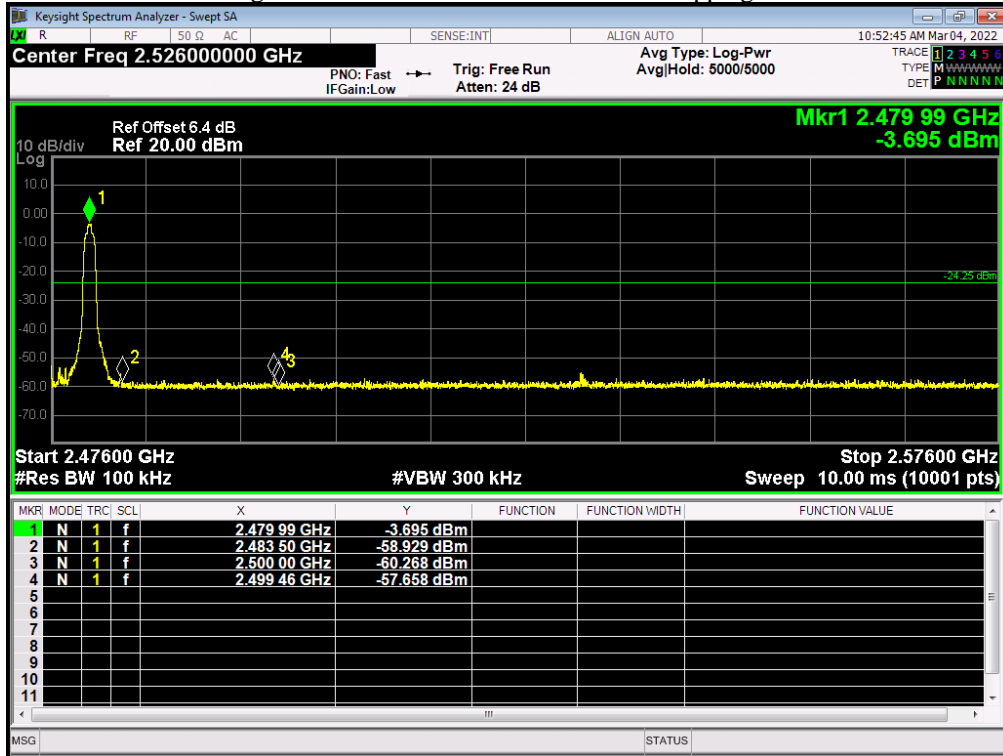

Condition	Mode	Frequency (MHz)	Antenna	Hopping Mode	Max Value (dBc)	Limit (dBc)	Verdict
NVNT	3-DH5	2402	Ant 1	No-Hopping	-54.803	-20	Pass
NVNT	3-DH5	2480	Ant 1	No-Hopping	-54.138	-20	Pass

Band Edge NVNT 3-DH5 2402MHz Ant1 No-Hopping Ref

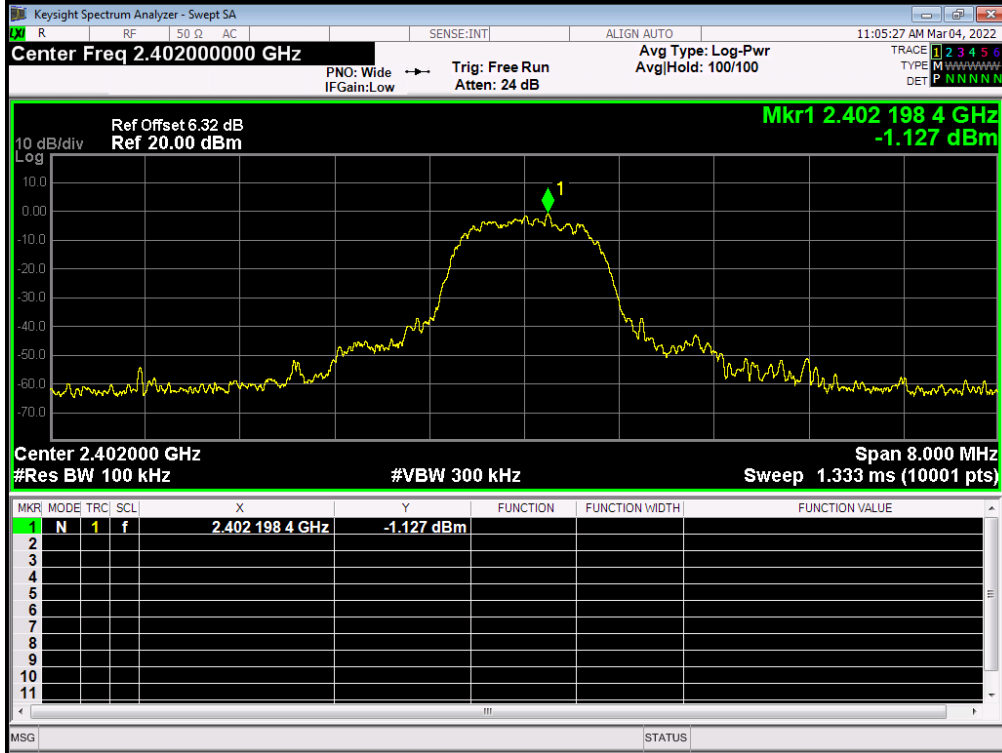

Band Edge NVNT 3-DH5 2402MHz Ant1 No-Hopping Emission

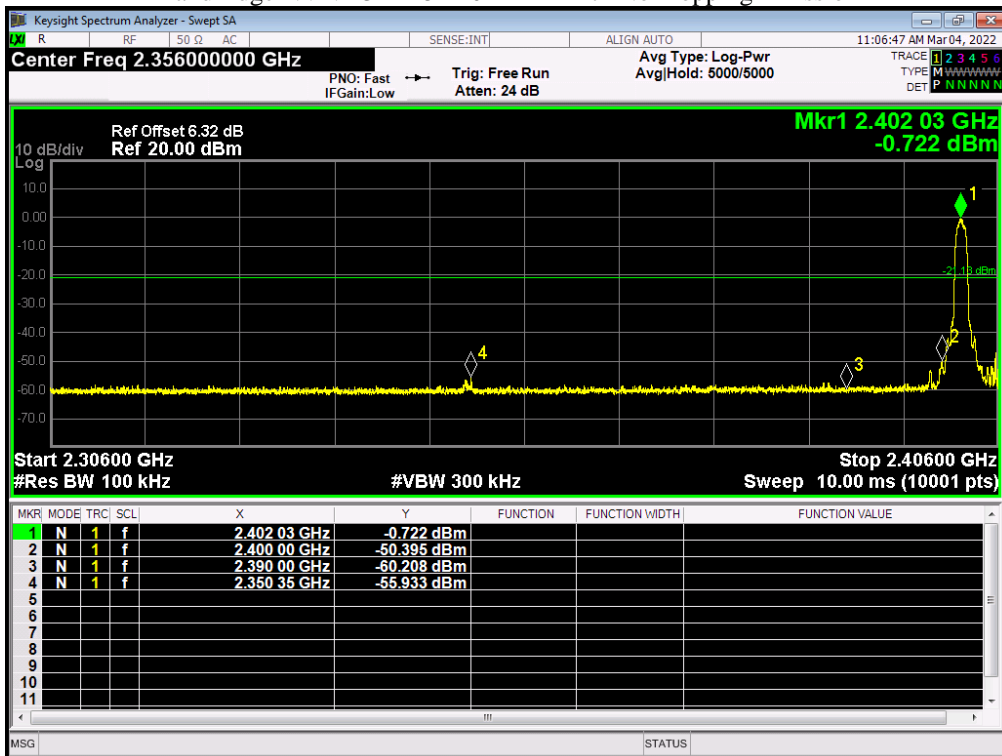

Band Edge NVNT 3-DH5 2480MHz Ant1 No-Hopping Ref

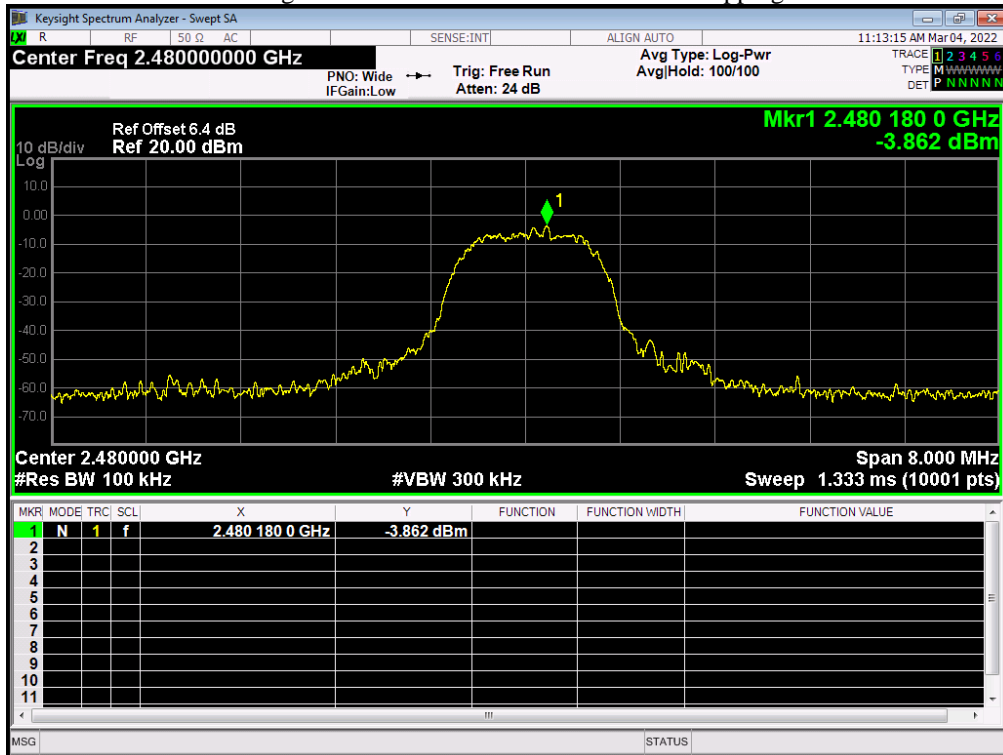

Band Edge NVNT 3-DH5 2480MHz Ant1 No-Hopping Emission

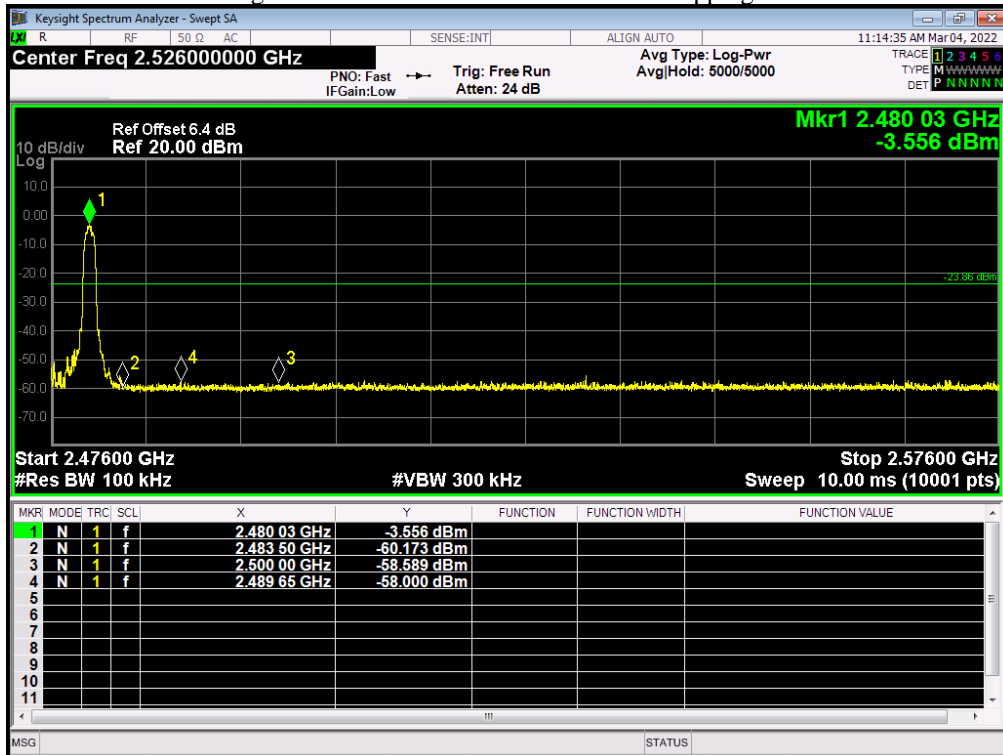

Note: All the modes (1-DH1, 1-DH3,1-DH5,2-DH1,2-DH3,2-DH5,3-DH1,3-DH3,3-DH5) had been test, but only the worst data (1-DH5,2-DH5,3-DH5) record in the report.

11. Conducted Spurious Emissions

11.1. Applied procedures / Limit

15.247(d) In any 100 kHz bandwidth outside the frequency band in which the spread spectrum or digitally modulated intentional radiator is operating, the radio frequency power that is produced by the intentional radiator shall be at least 20 dB below that in the 100 kHz bandwidth within the band that contains the highest level of the desired power, based on either an RF conducted or a radiated measurement, provided the transmitter demonstrates compliance with the peak conducted power limits. If the transmitter complies with the conducted power limits based on the use of RMS averaging over a time interval, as permitted under paragraph (b)(3) of this section, the attenuation required under this paragraph shall be 30 dB instead of 20 dB. Attenuation below the general limits specified in Section 15.209(a) is not required. In addition, radiated emissions which fall in the restricted bands, as defined in Section 15.205(a), must also comply with the radiated emission limits specified in Section 15.209(a) (see Section 15.205(c)).

11.2. Test procedure

- a. The EUT was directly connected to the spectrum analyzer and antenna output port as show in the block diagram below.
- b. Span = wide enough to capture the peak level of the in-band emission and all spurious emissions (e.g., harmonics) from the lowest frequency generated in the EUT up through the 10th harmonic. Typically, several plots are required to cover this entire span. RBW = 100 kHz
VBW ≥ RBW, Sweep = auto, Detector function = peak, Trace = max hold
sweep points ≥ investigated frequency range/RBW.

11.3. Deviation from standard

No deviation.

11.4. Test setup



11.5. Test results

Condition	Mode	Frequency (MHz)	Antenna	Max Value (dBc)	Limit (dBc)	Verdict
NVNT	1-DH5	2402	Ant 1	-47.688	-20	Pass
NVNT	1-DH5	2441	Ant 1	-42.722	-20	Pass
NVNT	1-DH5	2480	Ant 1	-47.762	-20	Pass

Tx. Spurious NVNT 1-DH5 2402MHz Ant1 Ref

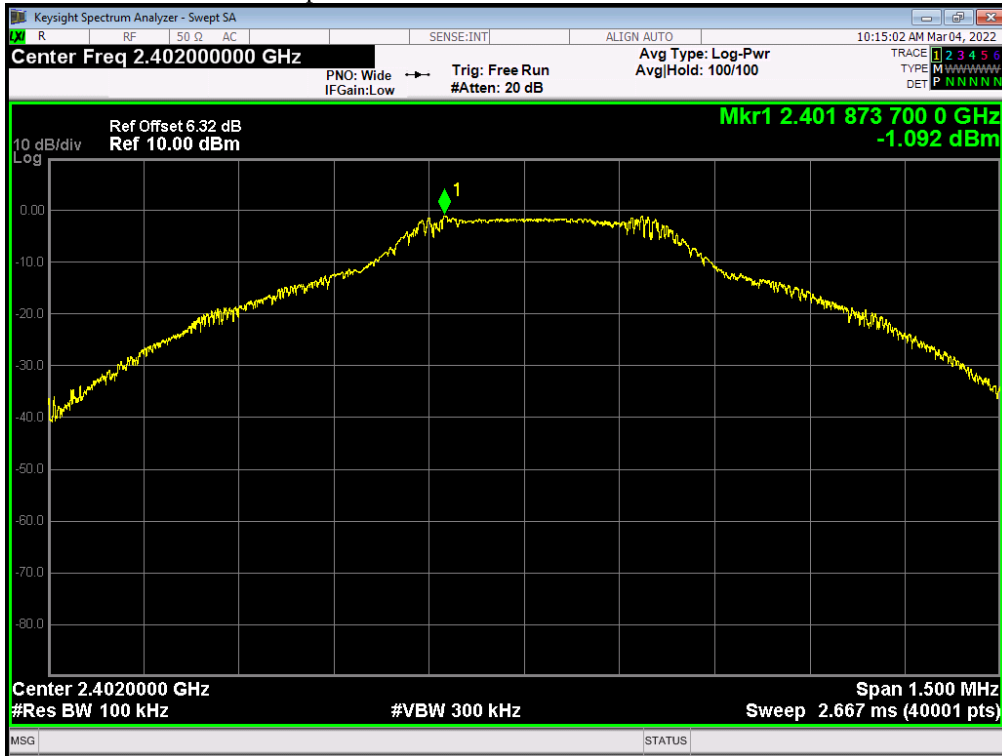

Tx. Spurious NVNT 1-DH5 2402MHz Ant1 Emission

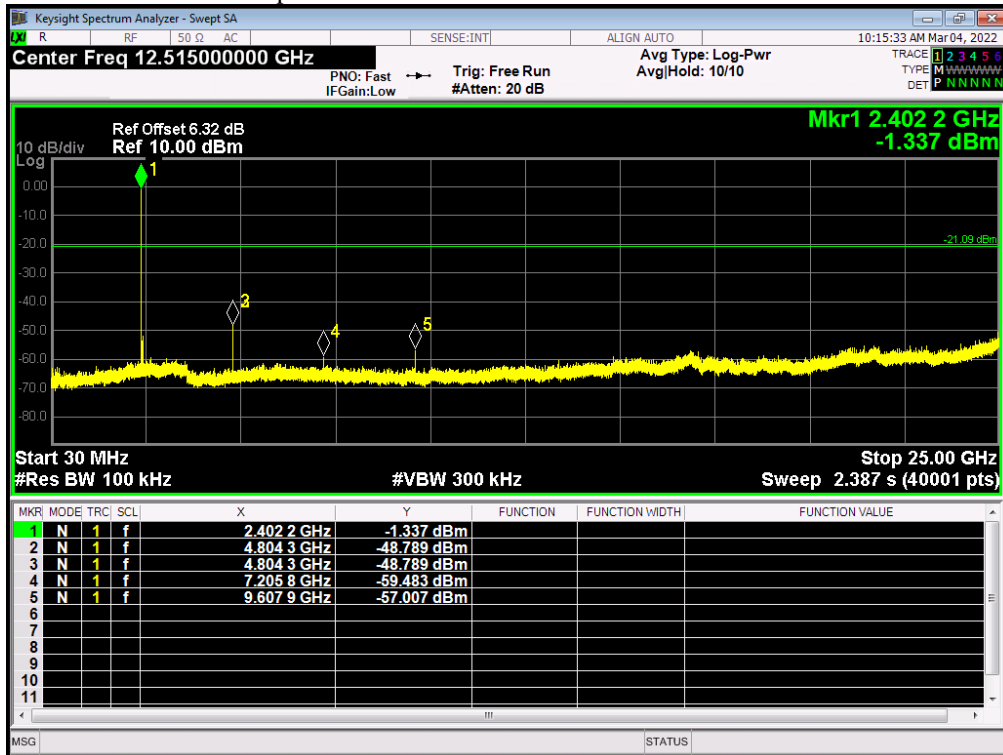

Tx. Spurious NVNT 1-DH5 2441MHz Ant1 Ref

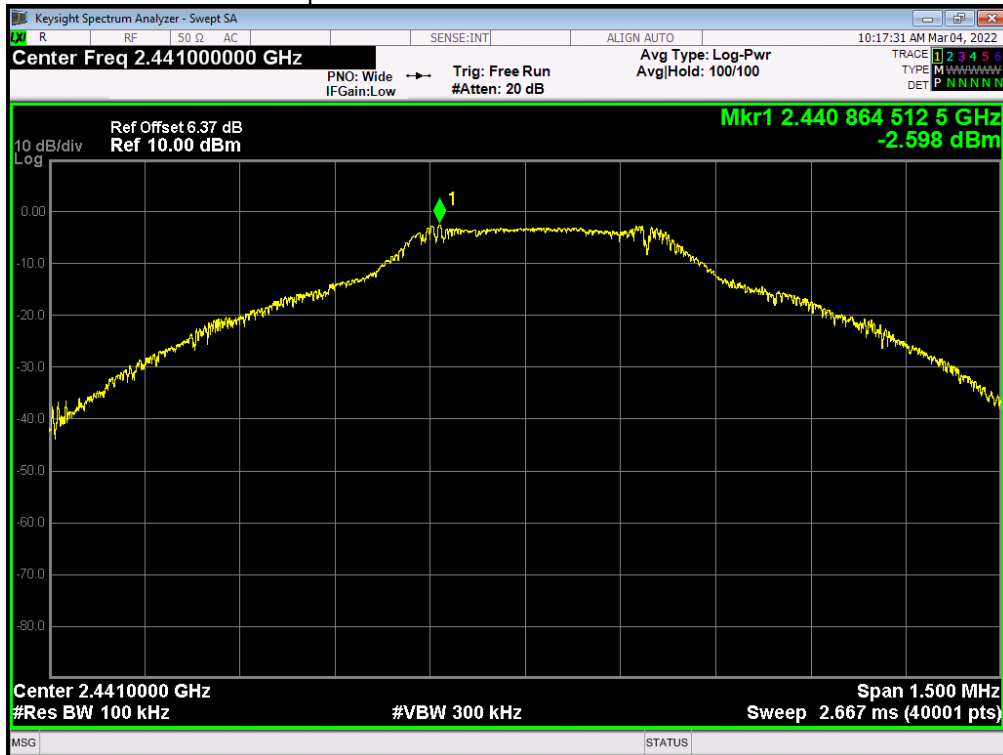

Tx. Spurious NVNT 1-DH5 2441MHz Ant1 Emission

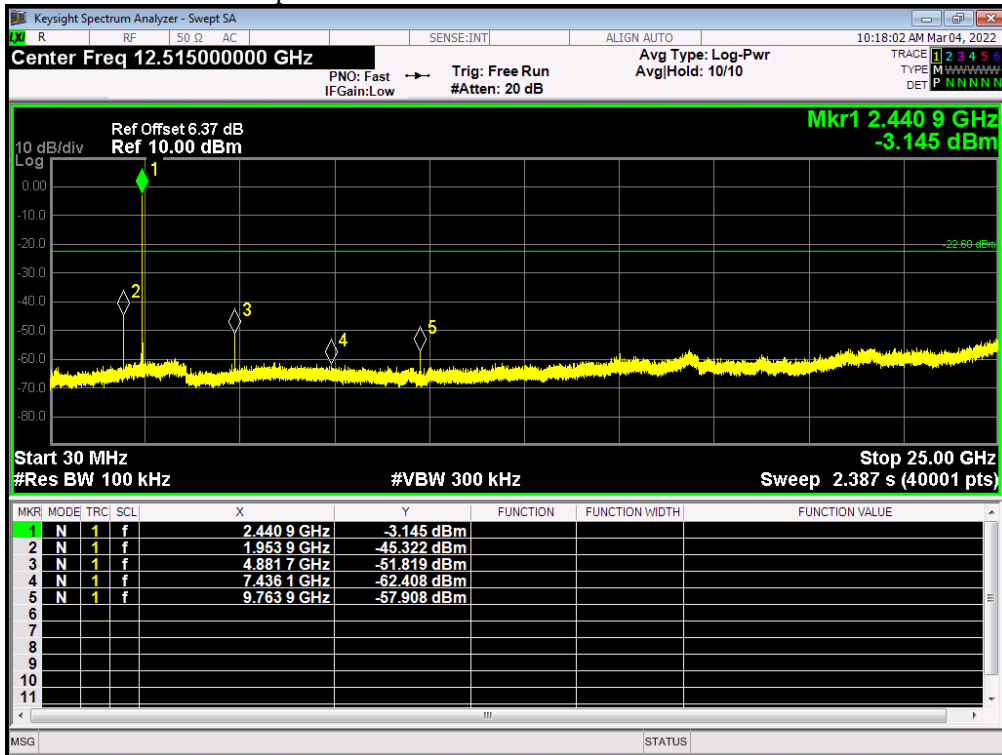

Tx. Spurious NVNT 1-DH5 2480MHz Ant1 Ref

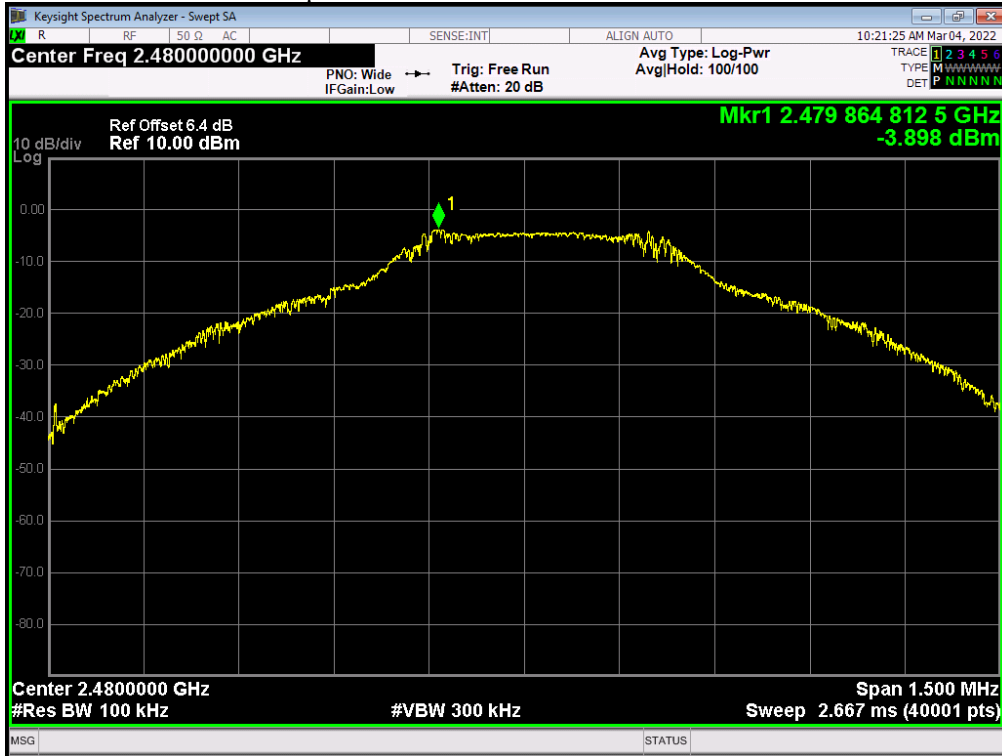

Tx. Spurious NVNT 1-DH5 2480MHz Ant1 Emission

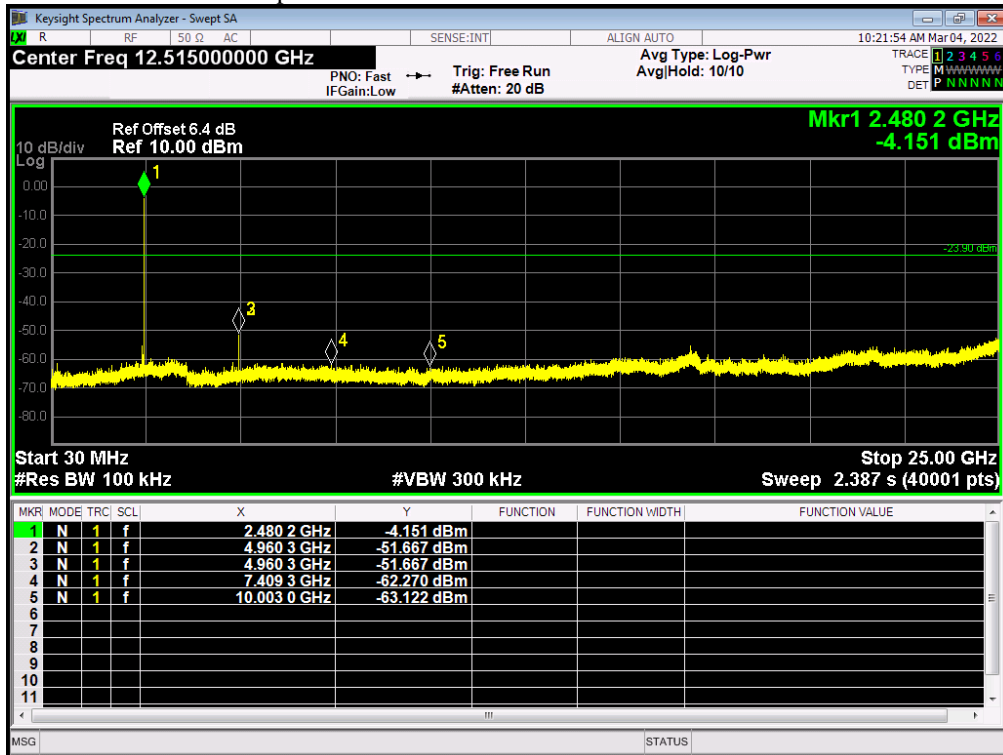

Condition	Mode	Frequency (MHz)	Antenna	Max Value (dBc)	Limit (dBc)	Verdict
NVNT	2-DH5	2402	Ant 1	-48.036	-20	Pass
NVNT	2-DH5	2441	Ant 1	-49.77	-20	Pass
NVNT	2-DH5	2480	Ant 1	-47.311	-20	Pass

Tx. Spurious NVNT 2-DH5 2402MHz Ant1 Ref

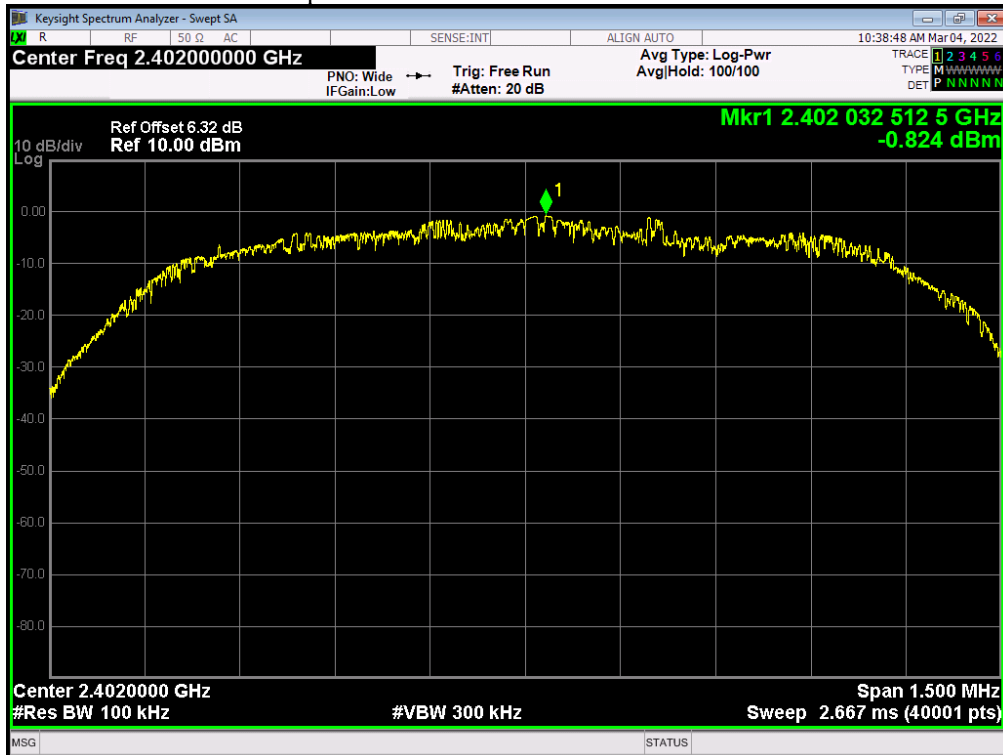

Tx. Spurious NVNT 2-DH5 2402MHz Ant1 Emission

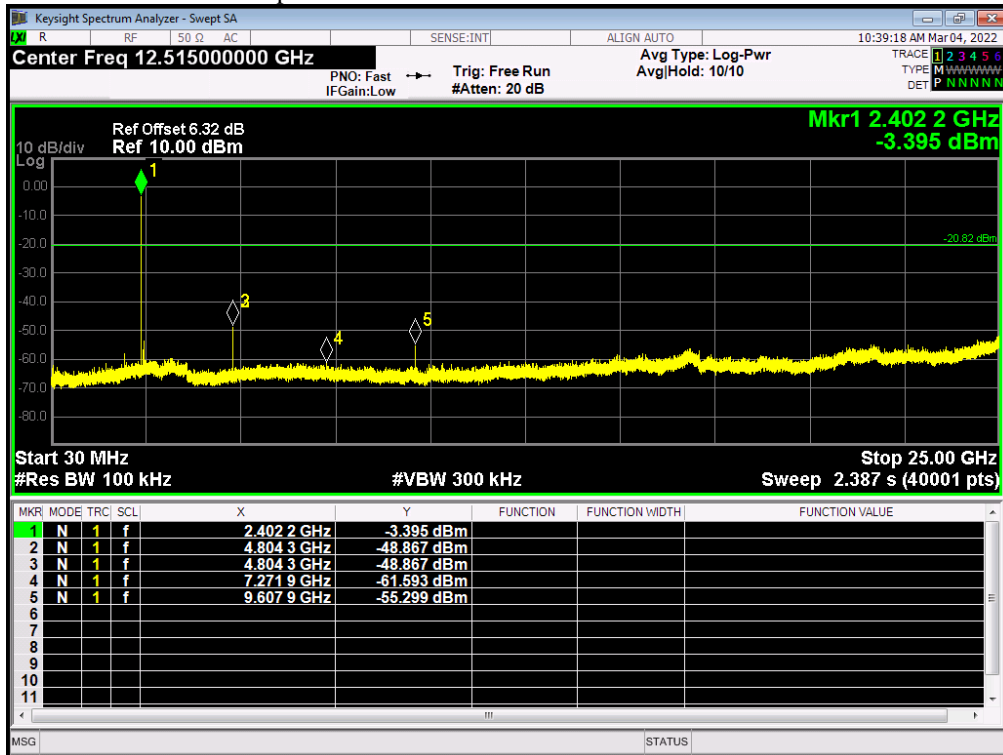

Tx. Spurious NVNT 2-DH5 2441MHz Ant1 Ref

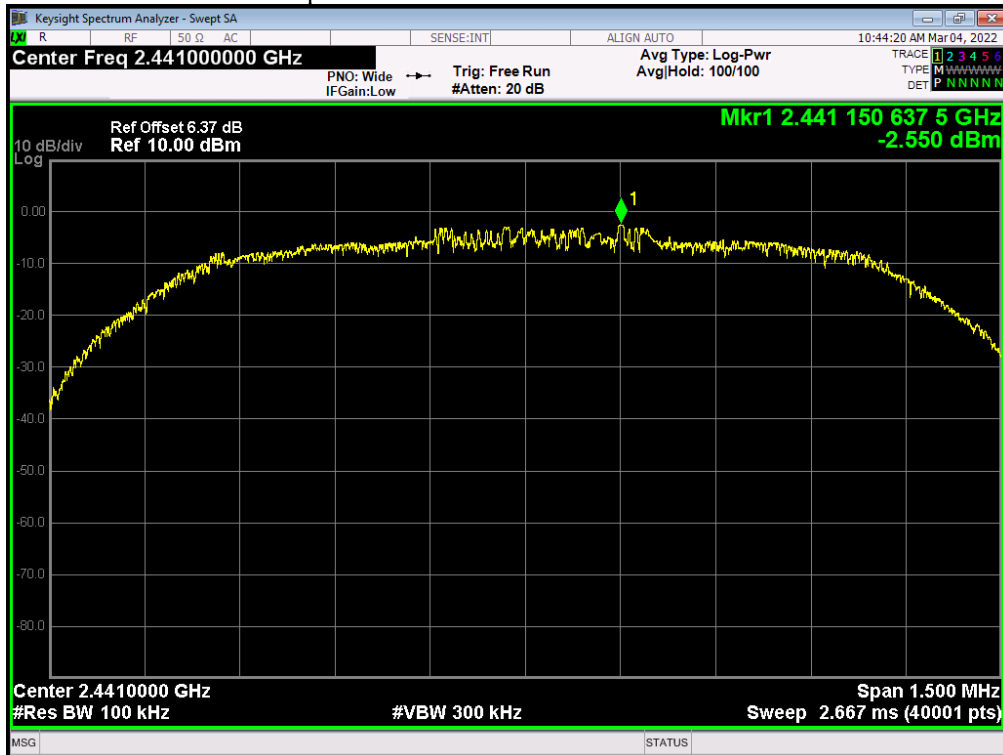

Tx. Spurious NVNT 2-DH5 2441MHz Ant1 Emission

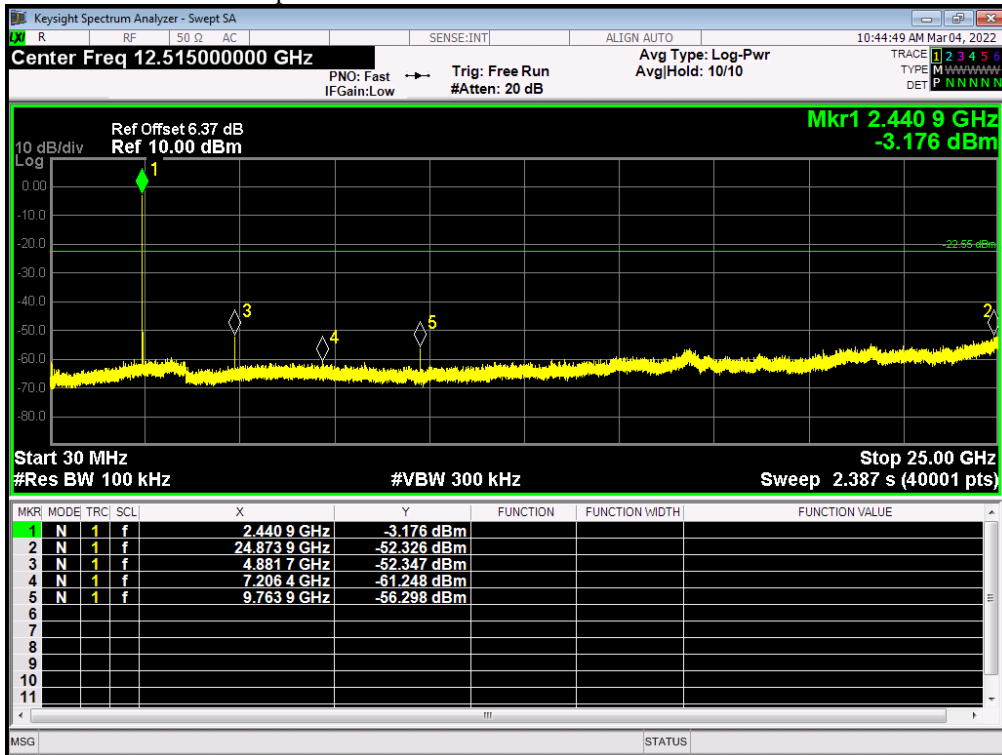

Tx. Spurious NVNT 2-DH5 2480MHz Ant1 Ref

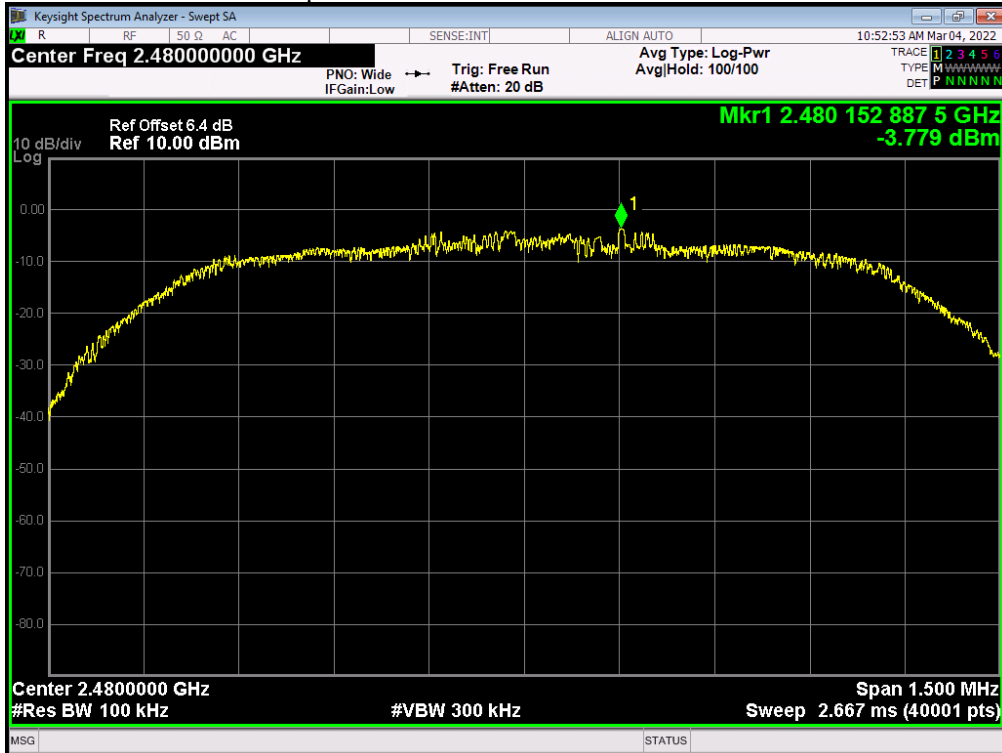

Tx. Spurious NVNT 2-DH5 2480MHz Ant1 Emission

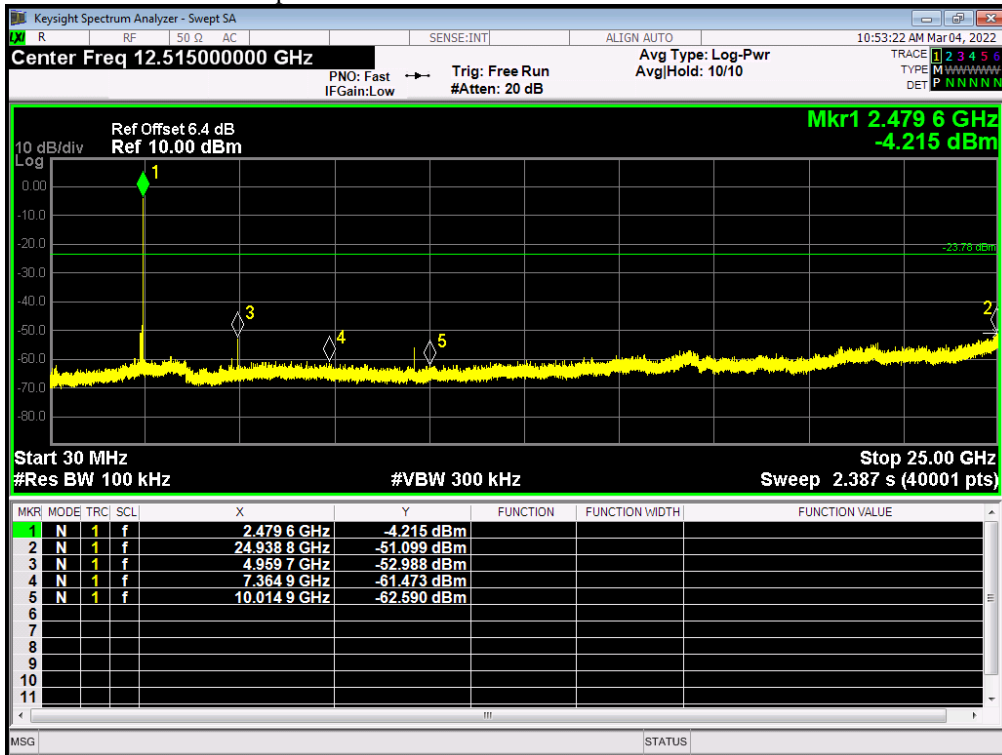

Condition	Mode	Frequency (MHz)	Antenna	Max Value (dBc)	Limit (dBc)	Verdict
NVNT	3-DH5	2402	Ant 1	-49.49	-20	Pass
NVNT	3-DH5	2441	Ant 1	-48.929	-20	Pass
NVNT	3-DH5	2480	Ant 1	-47.896	-20	Pass

Tx. Spurious NVNT 3-DH5 2402MHz Ant1 Ref

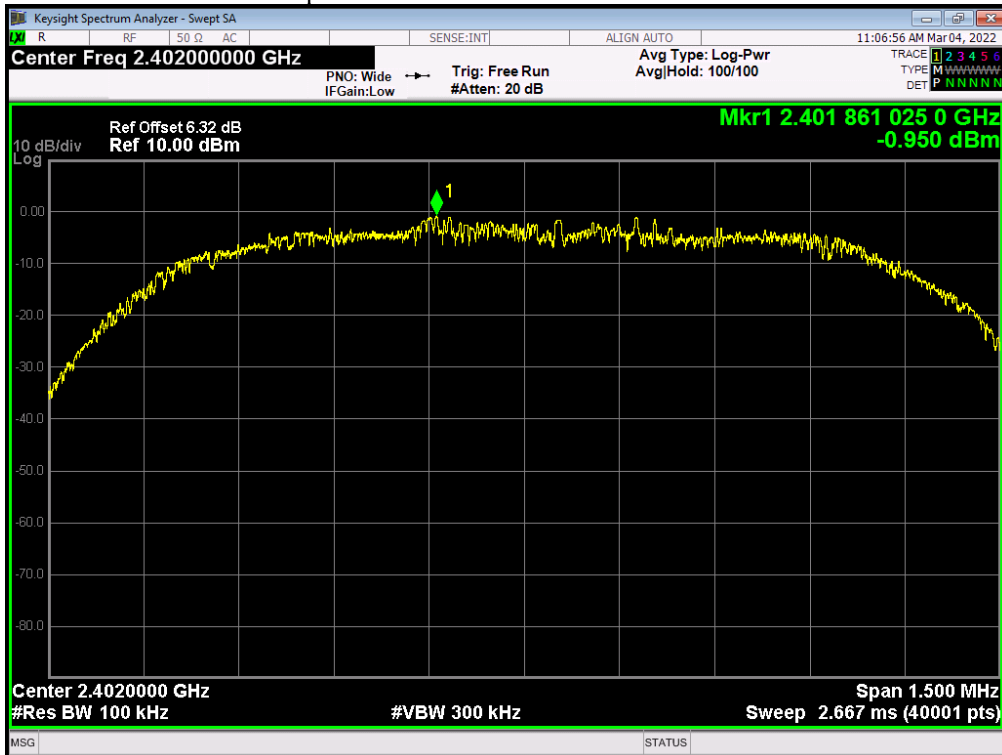

Tx. Spurious NVNT 3-DH5 2402MHz Ant1 Emission

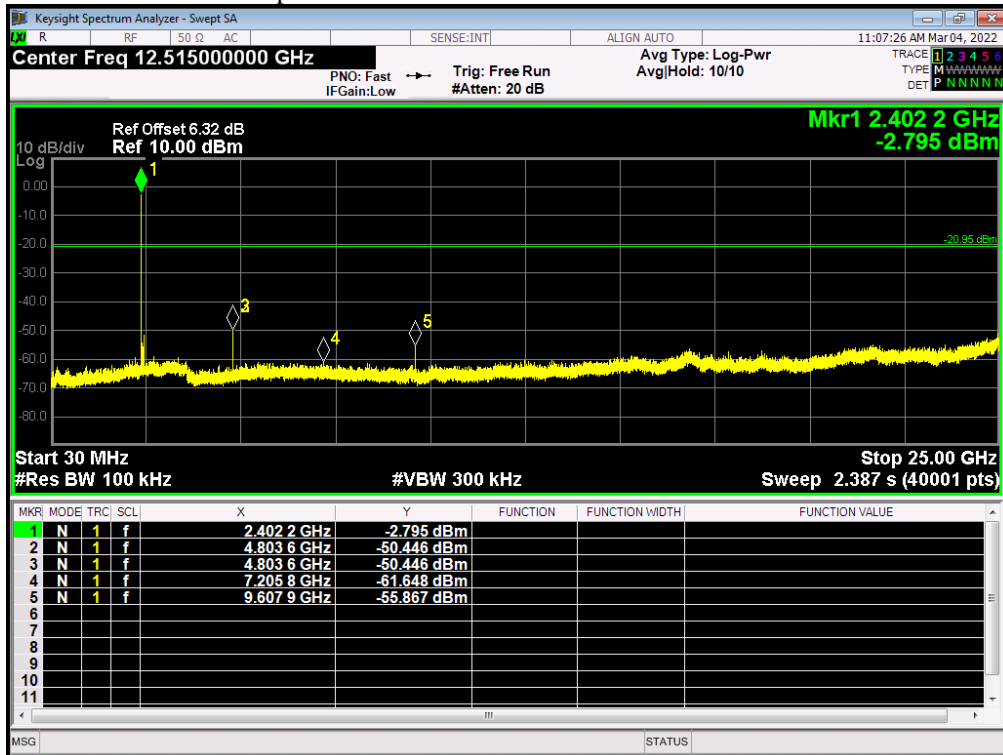

Tx. Spurious NVNT 3-DH5 2441MHz Ant1 Ref

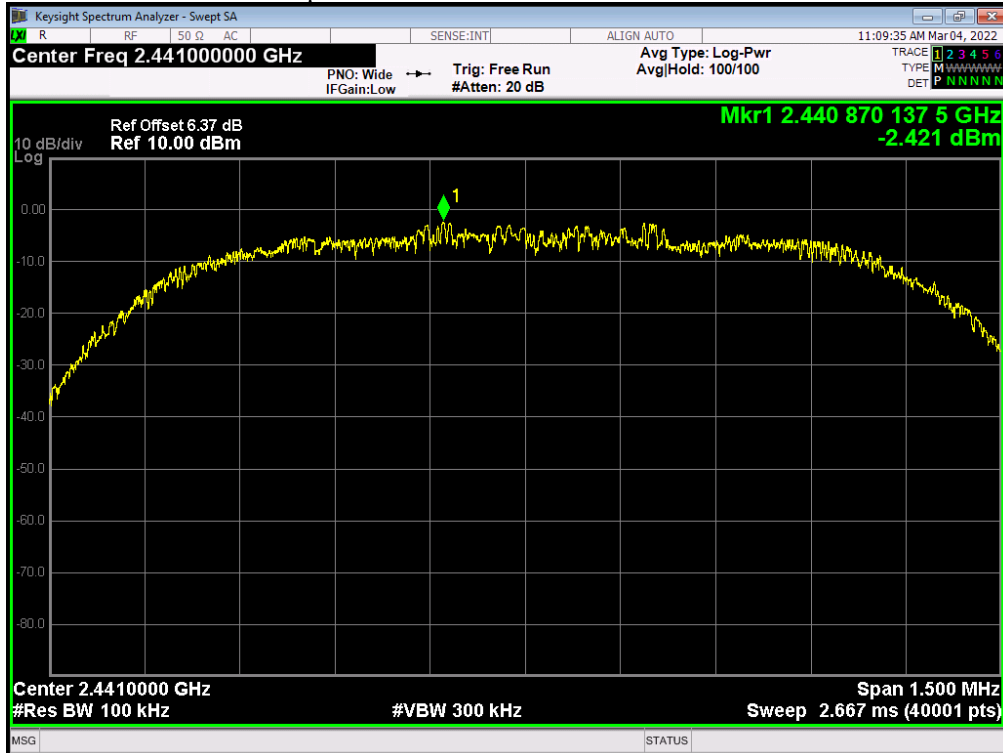

Tx. Spurious NVNT 3-DH5 2441MHz Ant1 Emission

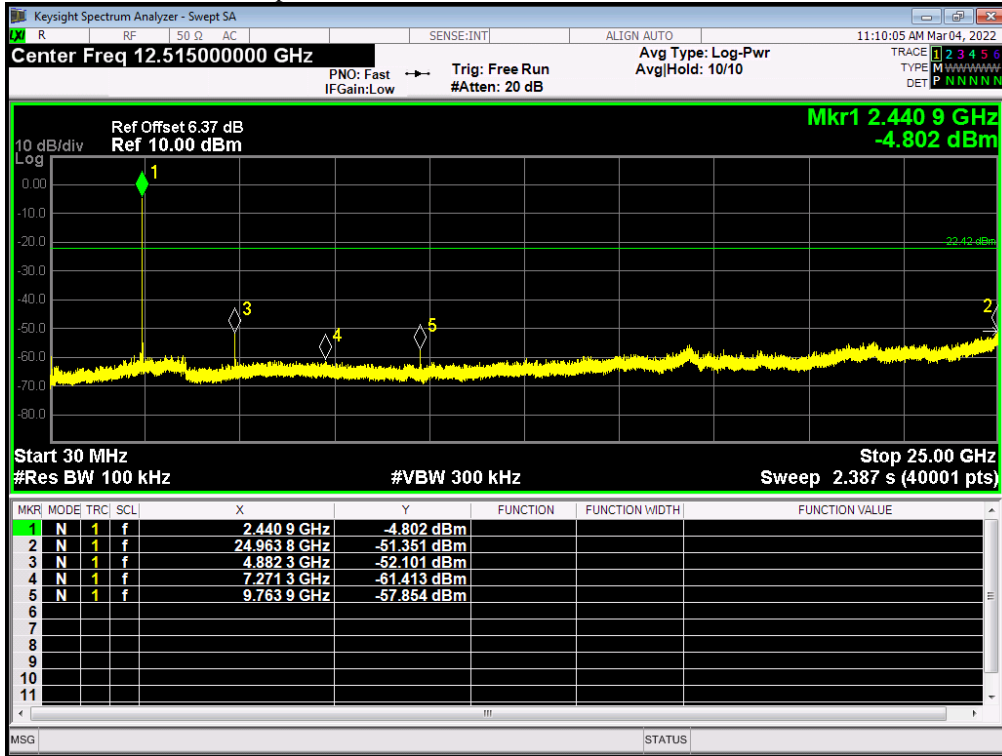

Tx. Spurious NVNT 3-DH5 2480MHz Ant1 Ref

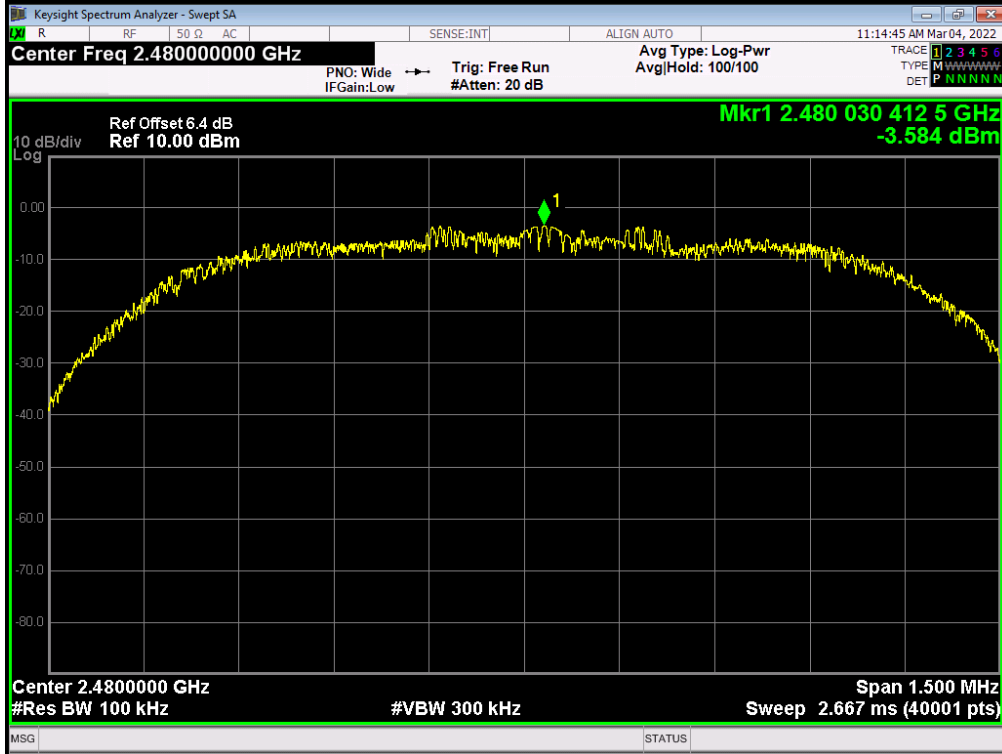

Tx. Spurious NVNT 3-DH5 2480MHz Ant1 Emission

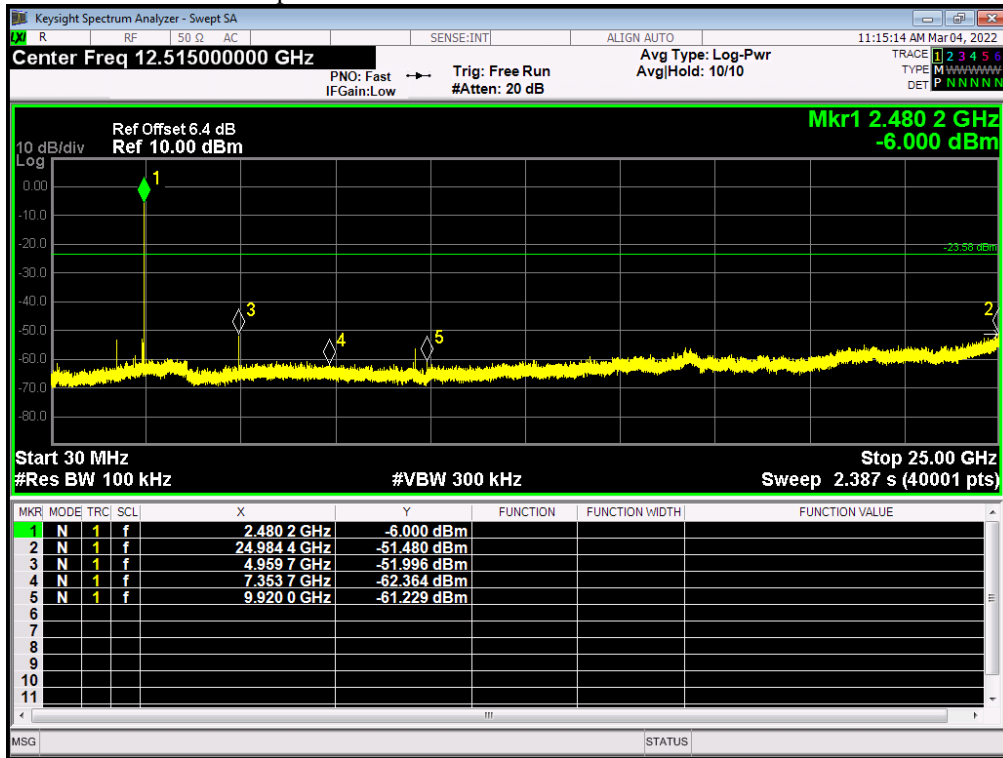

Note: All the modes (1-DH1, 1-DH3,1-DH5,2-DH1,2-DH3,2-DH5,3-DH1,3-DH3,3-DH5) had been test, but only the worst data (1-DH5,2-DH5,3-DH5) record in the report.

12. Antenna Requirement

12.1. Standard requirement

15.203 requirement: For intentional device, according to 15.203: an intentional radiator shall be designed to ensure that no antenna other than that furnished by the responsible party shall be used with the device. 15.247(c) (1)(i) requirement: (i) Systems operating in the 2400-2483.5 MHz band that is used exclusively for fixed. Point-to-point operations may employ transmitting antennas with directional gain greater than 6dBi provided the maximum conducted output power of the intentional radiator is reduced by 1 dB for every 3 dB that the directional gain of the antenna exceeds 6dBi.

12.2. EUT Antenna

The antenna is Integral Antenna and no consideration of replacement. Antenna gain is Maximum -0.58dBi from 2.4GHz to 2.5GHz.

13. Test setup photograph

Photos of power line conducted emission test



Photos of radiated emission test
30MHz – 1GHz



Photos of radiated emission test
Above 1GHz



14. Photos of the EUT







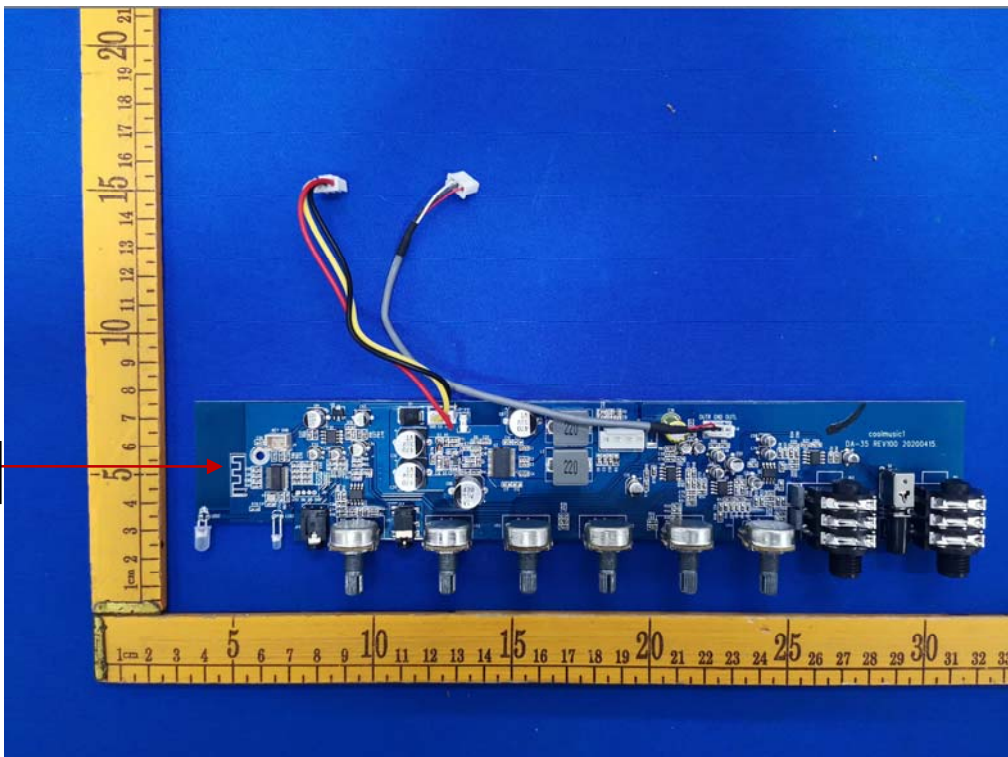

BT Antenna

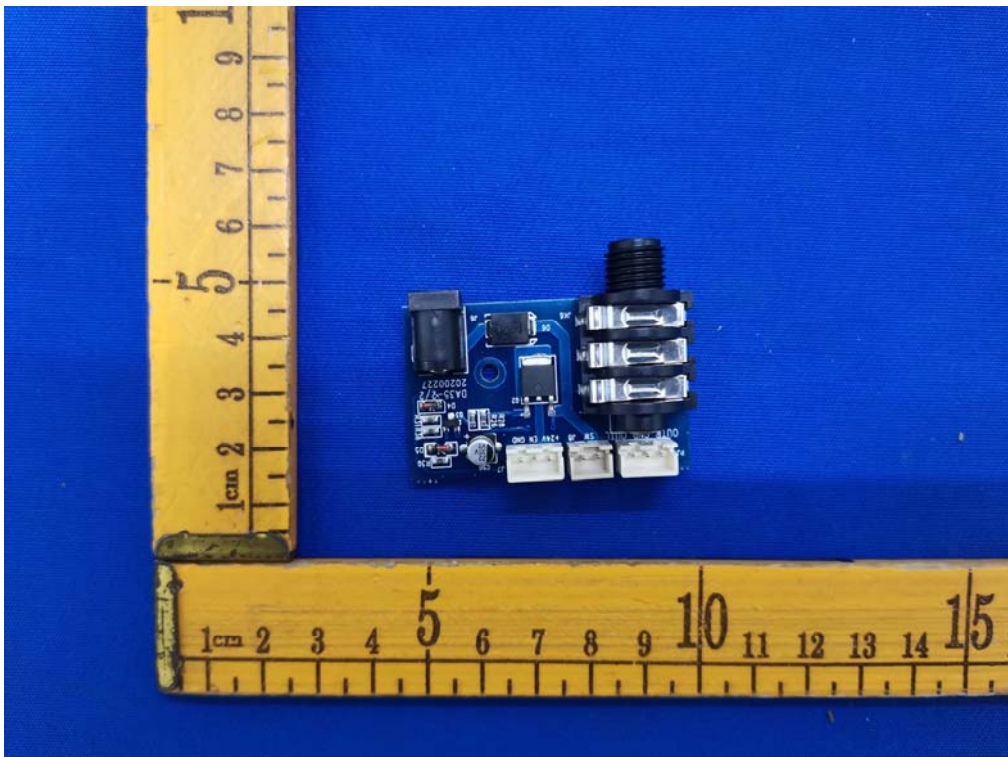
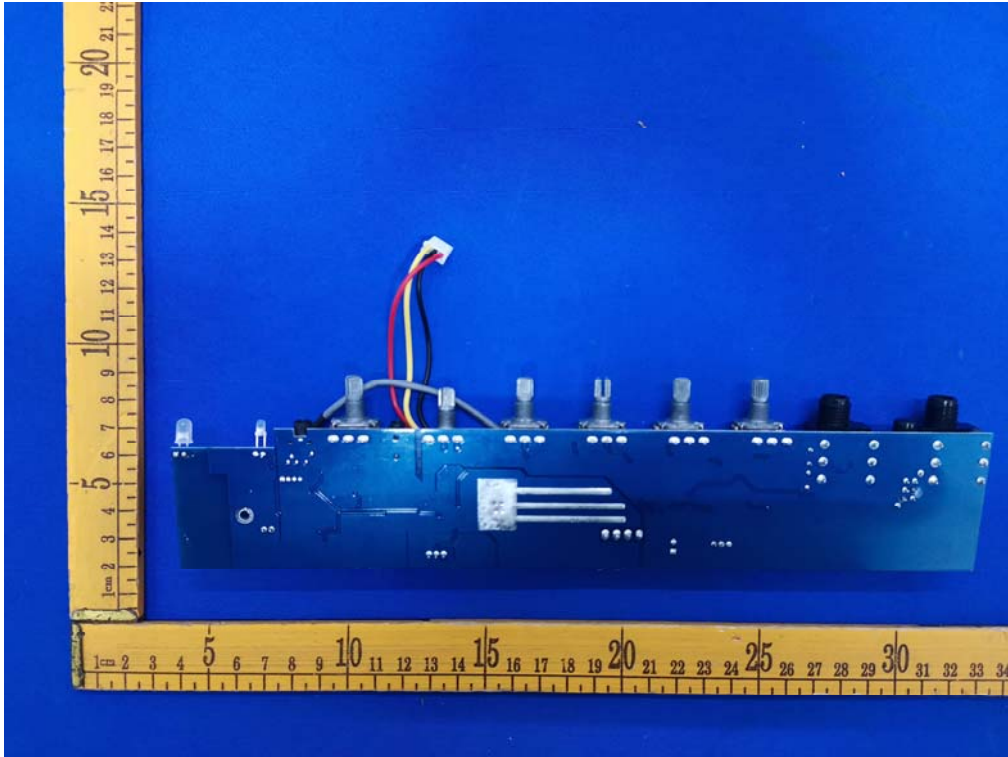

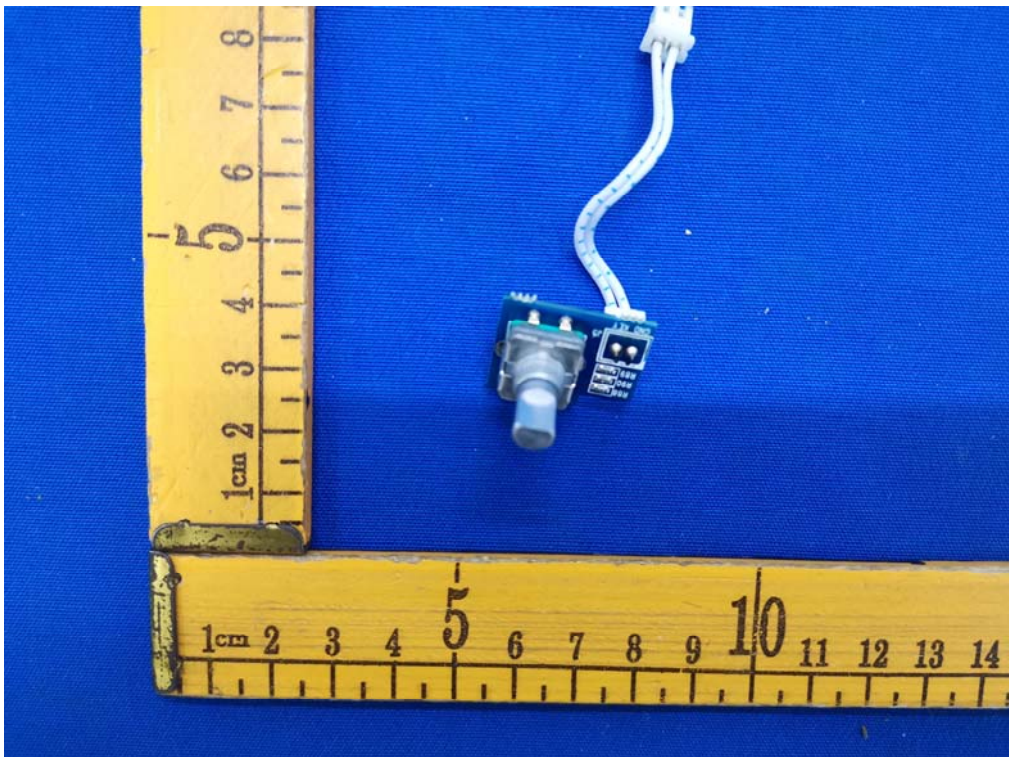
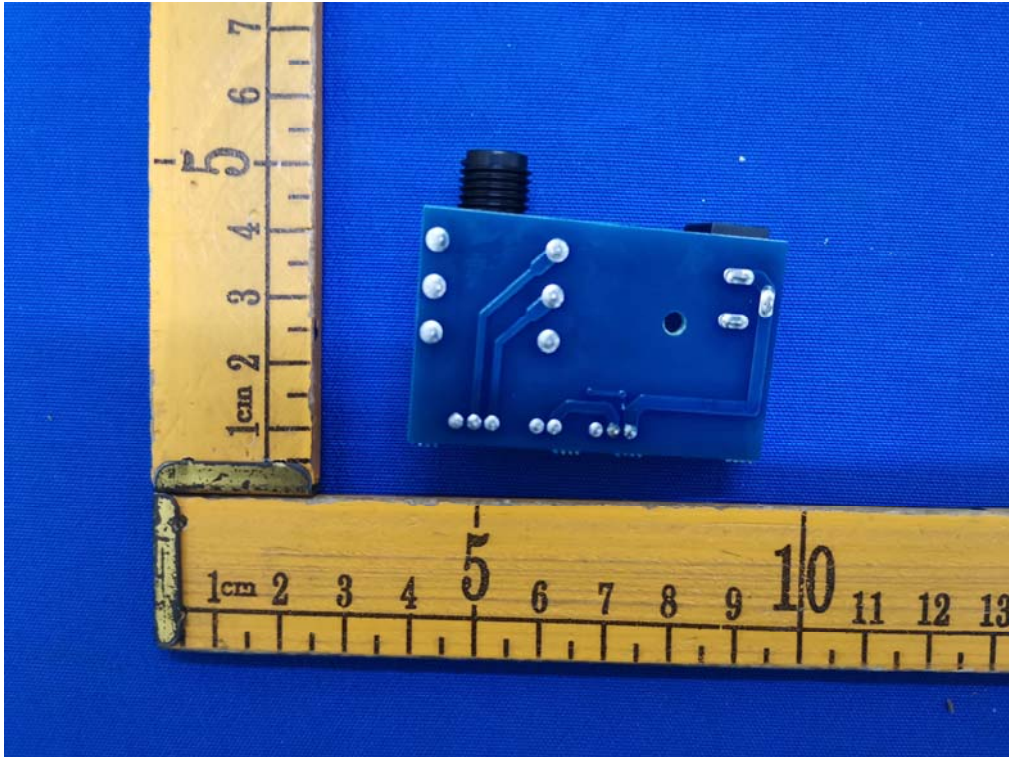



--END OF REPORT--