

tineco

PURE ONE S15 PRO SERIES

Smart Vacuum Cleaner

Instruction Manual

Manual De Uso

Mode D'emploi



*Actual product may differ from illustration.

TINECO IS HERE TO HELP.

We'll get back to you within 1 business day.



 www.tineco.com

 **1-855-292-8864**
Mon. - Fri. 9am - 6pm (CST)

CONTENTS

Important Safety Instructions.....	1
Specifications	3
Overview.....	11
Accessories.....	11
Assembly	11
Operation.....	12
Maintenance	14
Troubleshooting.....	15
Warranty	16

IMPORTANT SAFETY INSTRUCTIONS

SAVE THESE INSTRUCTIONS Household use only.

When using an electrical appliance, basic precautions should always be followed, including the following:

READ ALL INSTRUCTIONS BEFORE USING (THIS APPLIANCE). Failure to follow the warnings and instructions may result in electric shock, fire and/or serious injury.

WARNING – To reduce the risk of fire, electric shock, or injury:

1. This appliance can be used by children aged from 8 years and above and persons with reduced physical, sensory or mental capabilities or lack of experience and knowledge if they have been given supervision or instruction concerning use of the appliance in a safe way and understand the hazards involved. Children should not play with the appliance. Cleaning and user maintenance shall not be performed by children without supervision.
2. The appliance is not to be used by persons (including children) with reduced physical, sensory or mental capabilities, or lack of experience and knowledge, unless they have been given supervision or instruction.
3. For **INDOOR** use **ONLY**. Do not use the appliance outdoors, nor in commercial or industrial environments. Do not use the appliance on wet surfaces or surfaces with standing water.
4. Do not allow to be used as a toy. Close attention is necessary when used by or near children, pets or plants.
5. Use only as described in this manual. Use only manufacturer's recommended attachments.
6. Do not use with a damaged cord or plug. If appliance has been dropped, damaged, left outdoors, dropped into water, or is not working as it should, return it to a service center.
7. Do not handle charger, including charger plug, and charger terminals with wet hands.
8. Do not put any object into openings. Do not use with any opening blocked; keep free of dust, lint, hair, and anything that may reduce air flow.
9. Keep hair, loose clothing, fingers, and all parts of your body away from openings and moving parts.
10. Use extra care when cleaning on stairs.
11. Do not use to pick up flammable or combustible liquids, such as gasoline, or use in areas where they may be present.
12. Do not pick up anything that is burning or smoking, such as cigarettes, matches, or hot ashes.
13. Do not use without filter.
14. Prevent unintentional activation. Ensure the switch is in the off-position before picking up or carrying the appliance. Carrying the appliance with your finger on the switch or energizing appliance that have the switch on invites accidents.
15. Disconnect the battery pack from the appliance before making any adjustments, changing accessories, storing the appliance. Such preventive

- safety measures reduce the risk of starting the appliance accidentally.
16. For the purposes of recharging the battery, only use the detachable supply unit provided with this appliance. A charger that is suitable for one type of battery pack may create a risk of fire when used with another battery pack.
 17. Use appliances only with specifically designated Tineco battery packs. Use of any other battery packs may create a risk of injury and fire.
 18. When battery pack is not in use, keep it away from other metal objects, like paper clips, coins, keys, nails, screws or other small metal objects, that can make a connection from one terminal to another. Shorting the battery terminals together may cause burns or a fire.
 19. Under improper usage, liquid may be ejected from the battery; avoid contact. If contact accidentally occurs, flush with water. If liquid comes into eye contact, seek medical help. Liquid ejected from the battery may cause irritation or burns.
 20. Do not use a battery pack or appliance that is damaged or modified. Damaged or modified batteries may exhibit unpredictable behavior resulting in fire, explosion or risk of injury.
 21. Do not expose a battery pack or appliance to fire or excessive temperature. Exposure to fire or temperature above 266°F (130°C) may cause an explosion.
 22. Follow all charging instructions and do not charge the battery pack or appliance outside of the temperature range specified in the instructions. Charging improperly or at temperatures outside of the specified range may damage the battery and increase the risk of fire.
 23. Have servicing performed by a qualified repair person using only identical replacement parts. This will ensure that the safety of the product is maintained.
 24. This appliance contains battery cells that are non-replaceable. Do not modify or attempt to repair the appliance or the battery pack except as indicated in the instructions for use and care.
 25. Always turn off this appliance before connecting or disconnecting the motorized nozzle.
 26. Brush may start unexpectedly. Disconnect battery pack before cleaning or servicing.
 27. Do not charge or store the appliance outdoors or inside the car. Only charge, store or use the battery in a dry indoor area where the temperature is higher than 39.2°F (4°C) but lower than 104°F (40°C). The charger is for indoor use only.
 28. Do not unplug by pulling on cord. To unplug, grasp the charger, not the cord.

FCC Supplier's Declaration of Conformity

TINECO / PURE ONE S15 PRO SERIES

This appliance complies with part 15 of the FCC Rules. Operation is subject to the following two conditions:

(1) This appliance may not cause harmful interference, and (2) this appliance must accept any interference received, including interference that may cause undesired operation.

TINECO INTELLIGENT, INC.

1700 WESTLAKE AVENUE N., SUITE 200,

SEATTLE, WA, 98109, USA

WWW.TINECO.COM

1-855-292-8864

Changes or modifications not expressly approved by the party responsible for compliance could void the user's authority to operate the equipment.

Note: This equipment has been tested and found to comply with the limits for a Class B digital appliance, pursuant to Part 15 of the FCC Rules. These limits are

designed to provide reasonable protection against harmful interference in a residential installation. This equipment generates uses and can radiate radio frequency energy and, if not installed and used in accordance with the instructions, may cause harmful interference to radio communications. However, there is no guarantee that interference will not occur in a particular installation. If this equipment does cause harmful interference to radio or television reception, which can be determined by turning the equipment off and on, the user is encouraged to try to correct the interference by one or more of the following measures:

- (1) Reorient or relocate the receiving antenna.
- (2) Increase the separation between the equipment and receiver.
- (3) Connect the equipment into an outlet on a circuit different from that to which the receiver is connected.
- (4) Consult the dealer or an experienced radio/TV technician for help.
- (5) This device can be used in portable mode without restriction.

FCC Radiation Exposure Statement

This equipment complies with FCC radiation exposure limits set forth for an uncontrolled environment.

Note

The manufacturer is not responsible for any radio or TV interference caused by unauthorized modifications to this equipment, such modifications could void the user's authority to operate this equipment.







IC Note

This appliance contains licence-exempt transmitter(s)/receiver(s) that comply with Innovation, Science and Economic

Development Canada's licence-exempt RSS(s). Operation is subject to the following two conditions:

- (1) this appliance may not cause interference.
 - (2) this appliance must accept any interference, including interference that may cause undesired operation of the appliance.
- This Class B digital apparatus complies with Canadian ICES-003.
 - This equipment complies with ISED RSS-102 radiation exposure limits set forth for an uncontrolled environment.

Symbols

	Read the instruction manual
	For indoor use only
	Direct current
	Alternating current
	Power On/Off
	Mode button

SPECIFICATIONS

Product	PURE ONE S15 PRO SERIES
Voltage	21.6V $\overline{=}$
Rated Power	500W
Dustbin Capacity	0.47L
Charging Time	3-4 hrs for one battery
AC Input	100-240V \sim

WiFi Frequency Bands	2.4G
WiFi Maximum Output Power	17dB

- Only use the Tineco-provided battery pack VS15-01 or VS15-02.
- Only use the Tineco-provided charger YLS0241A-T260080 or S030-1B260080HU.

Disposal





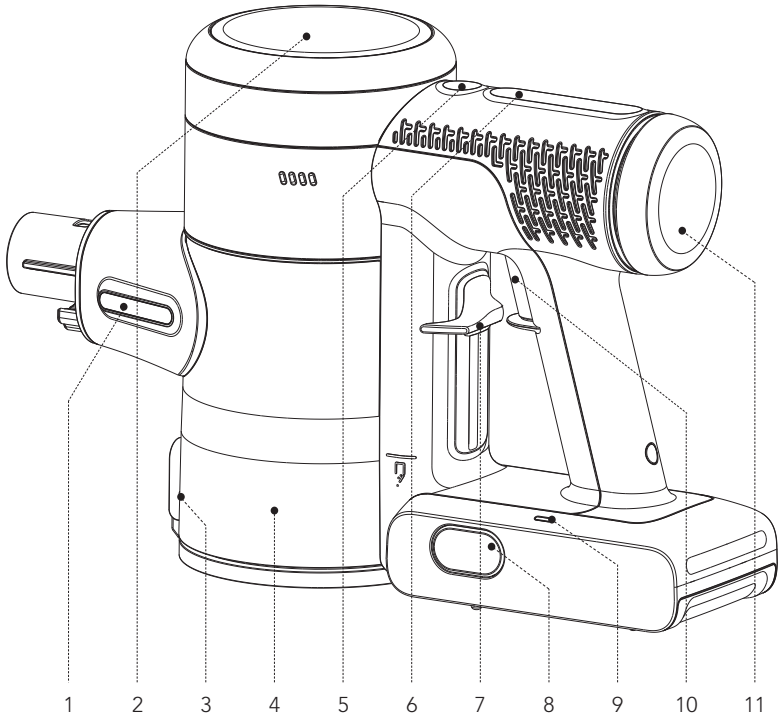



- The battery contains materials that are harmful to the environment and must be removed from the appliance before it is discarded.
- When removing the battery, the appliance must be powered off.
- Batteries, chargers, accessories and packaging should be sorted for environmental friendly recycling. Do not put them into fire, water or soil. Do not dispose of batteries and chargers into household waste! 
- If battery leakage contacts skin or clothing, immediately flush with water to avoid irritation and seek medical help.

A

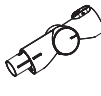

B

*The accessories you received may vary by market, please refer to the "Included Accessories" located on the packaging box.

 1	 2	 3	 4	 5
 6	 7	 8	 9	

C-1

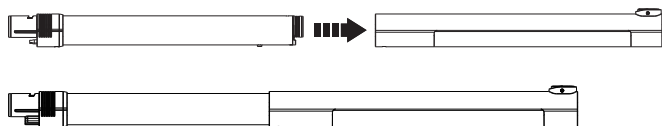

C-2

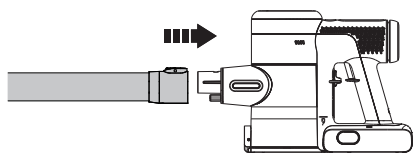

C-3

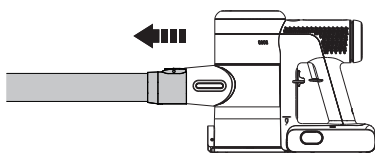

C-4

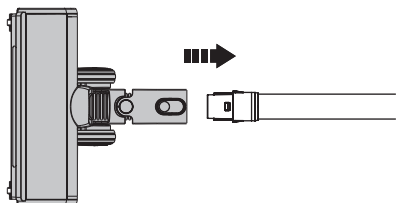

C-5

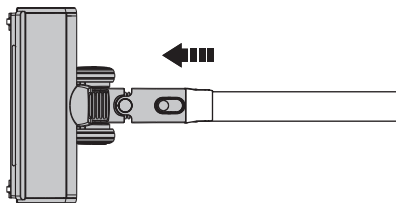

C-6

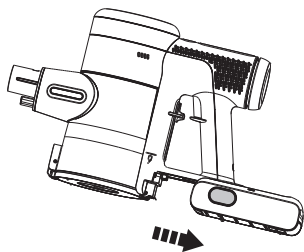

C-7

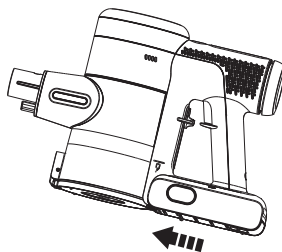

C-8

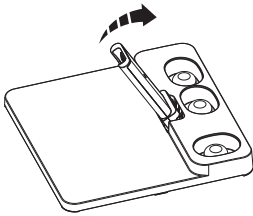

C-9

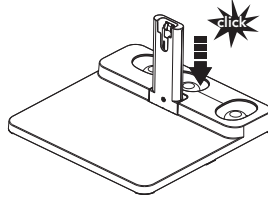

C-10

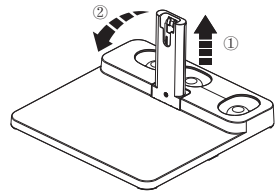

D-1

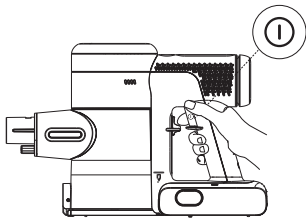

D-2

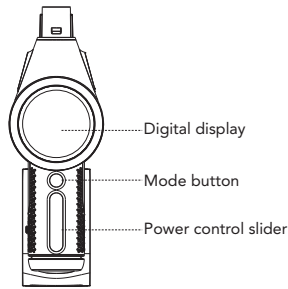

D-3

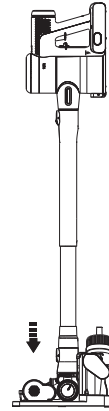

D-4



D-5

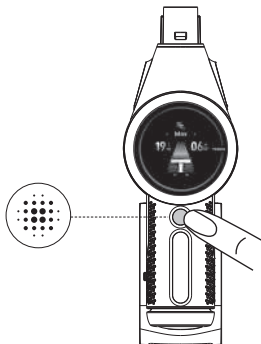

D-6

