



**FCC 47 CFR PART 15 SUBPART C
ISED RSS-247 Issue 3**

TEST REPORT

For

Smart Cordless Steam Floor Washer

FCC MODEL NUMBER: SW110100US

FCC ADDITIONAL MODEL NUMBER: SW11*****

("*" = 0-9, A-Z or blank used to denote different countries, customers, colors or minor cosmetic changes, or for indicate factory identification)

IC MODEL NUMBER: SW110100US

PROJECT NUMBER: 4790935097

REPORT NUMBER: 4790935097-1

FCC ID: 2AV7A-SW11

IC: 26039-SW11

ISSUE DATE: Sep. 26, 2023

Prepared for

Tineco Intelligent Technology Co., Ltd.

Prepared by

UL-CCIC COMPANY LIMITED

No. 2, Chengwan Road, Suzhou Industrial Park, Suzhou 215122, China

Tel: +86 512-6808 6400

Fax: +86 512-6808 4099

Website: www.ul.com

Form-ULID-008536-9 V3.0

The results reported herein have been performed in accordance with the laboratory's terms of accreditation. This report shall not be reproduced except in full without the written approval of the Laboratory. The results in this report apply to the test sample(s) mentioned above at the time of the testing period only and are not to be used to indicate applicability to other similar products.

Revision History

<u>Rev.</u>	<u>Issue Date</u>	<u>Revisions</u>	<u>Revised By</u>
V0	09/26/2023	Initial Issue	

TABLE OF CONTENTS

1. APPLICANT INFORMATION	4
2. TEST METHODOLOGY	6
3. FACILITIES AND ACCREDITATION	6
4. CALIBRATION AND UNCERTAINTY	7
4.1. <i>MEASURING INSTRUMENT CALIBRATION.....</i>	<i>7</i>
4.2. <i>MEASUREMENT UNCERTAINTY</i>	<i>7</i>
5. EQUIPMENT UNDER TEST.....	8
5.1. <i>DESCRIPTION OF EUT.....</i>	<i>8</i>
5.2. <i>MAXIMUM OUTPUT POWER.....</i>	<i>9</i>
5.3. <i>CHANNEL LIST.....</i>	<i>9</i>
5.4. <i>TEST CHANNEL CONFIGURATION.....</i>	<i>10</i>
5.5. <i>THE WORSE CASE POWER SETTING PARAMETER.....</i>	<i>10</i>
5.6. <i>DESCRIPTION OF AVAILABLE ANTENNAS</i>	<i>11</i>
5.7. <i>THE WORSE CASE CONFIGURATIONS.....</i>	<i>11</i>
5.8. <i>TEST ENVIRONMENT.....</i>	<i>11</i>
5.9. <i>DESCRIPTION OF TEST SETUP</i>	<i>12</i>
5.10. <i>MEASURING INSTRUMENT AND SOFTWARE USED.....</i>	<i>14</i>
6. MEASUREMENT METHODS.....	15
7. ANTENNA PORT TEST RESULTS.....	16
7.1. <i>ON TIME AND DUTY CYCLE</i>	<i>16</i>
7.2. <i>6 dB BANDWIDTH AND 99% OCCUPIED BANDWIDTH</i>	<i>19</i>
7.3. <i>CONDUCTED OUTPUT POWER.....</i>	<i>33</i>
7.4. <i>POWER SPECTRAL DENSITY.....</i>	<i>35</i>
7.5. <i>CONDUCTED BANDEDGE AND SPURIOUS EMISSIONS</i>	<i>43</i>
8. RADIATED TEST RESULTS.....	69
8.1. <i>LIMITS AND PROCEDURE.....</i>	<i>69</i>
8.2. <i>TEST ENVIRONMENT.....</i>	<i>76</i>
8.3. <i>RESTRICTED BANDEDGE.....</i>	<i>76</i>
8.4. <i>SPURIOUS EMISSIONS</i>	<i>93</i>
9. AC POWER LINE CONDUCTED EMISSIONS	149
10. ANTENNA REQUIREMENTS.....	152

1. APPLICANT INFORMATION

Applicant Information

Company Name: Tineco Intelligent Technology Co., Ltd.
Address: No. 108 Shihu Road West, Wuzhong Zone Suzhou, Jiangsu, China 215128

Manufacturer Information

Company Name: Tineco Intelligent Technology Co., Ltd.
Address: No. 108 Shihu Road West, Wuzhong Zone Suzhou, Jiangsu, China 215128

EUT Description

Product Name: Smart Cordless Steam Floor Washer
FCC Model Name: SW110100US
FCC Additional No.: SW11*****

(* = 0-9, A-Z or blank used to denote different countries, customers, colors or minor cosmetic changes, or for indicate factory identification)

IC Model Name: SW110100US
IC Additional No.: /

Model Difference: Their electrical circuit design, layout, components used and internal wiring are identical, only the color and model name is different. The model SW110100US was selected as the representative model for compliance test.

Sample Number: 6268076
Data of Receipt Sample: Jul. 14, 2023
Test Date: Jul. 14, 2023~ Aug. 14, 2023

APPLICABLE STANDARDS	
STANDARD	TEST RESULTS
CFR 47 Part 15 Subpart C	PASS
ISED RSS-247 Issue 3	PASS
ISED RSS-GEN Issue 5	PASS

Summary of Test Results			
Clause	Test Items	FCC&ISED Rules	Test Results
1	6 dB Bandwidth and 99% Occupied Bandwidth	FCC 15.247 (a) (2) RSS-247 Clause 5.2 (a) RSS-Gen Clause 6.7	PASS
2	Conducted Power	FCC 15.247 (b) (3) RSS-247 Clause 5.4 (d) RSS-Gen Clause 6.12	PASS
3	Power Spectral Density	FCC 15.247 (e) RSS-247 Clause 5.2 (b)	PASS
4	Conducted Band edge And Spurious emission	FCC 15.247 (d) RSS-247 Clause 5.5 RSS-GEN Clause 6.13	PASS
5	Radiated Band edges and Spurious emission	FCC 15.247 (d) FCC 15.209 FCC 15.205 RSS-247 Clause 5.5 RSS-GEN Clause 6.13 RSS-GEN Clause 8.9 RSS-GEN Clause 8.10	PASS
6	Conducted Emission Test for AC Power Port	FCC 15.207 RSS-GEN Clause 8.8	PASS
7	Antenna Requirement	FCC 15.203 RSS-GEN Clause 6.8	PASS
<p>Note: The measurement result for the sample received is <Pass> according to < ANSI C63.10-2013, FCC 47 CFR Part 2, FCC 47 CFR Part 15C, ISED RSS-247, ISED RSS-Gen > when <Accuracy Method> decision rule is applied.</p>			

Prepared By:

Tom Tang

Tom Tang

Reviewed By:

Kevin Shen

Kevin Shen

Authorized By:

Leon Wu

Leon Wu

2. TEST METHODOLOGY

The tests documented in this report were performed in accordance with KDB 558074 D01 15.247 Meas Guidance v05r02, 414788 D01 Radiated Test Site v01r01, CFR 47 FCC Part 2, CFR 47 FCC Part 15, ANSI C63.10-2013, ISED RSS-247 Issue 3 and ISED RSS-GEN Issue 5.

3. FACILITIES AND ACCREDITATION

Accreditation Certificate	<p>A2LA (Certificate No.: 4829.01) UL-CCIC COMPANY LIMITED has been assessed and proved to be in compliance with A2LA.</p> <p>FCC (FCC Designation No.: CN1247) UL-CCIC COMPANY LIMITED has been recognized to perform compliance testing on equipment subject to the Commission's Declaration of Conformity (DoC) and Certification rules.</p> <p>IC (IC Designation No.: 25056; CAB No.: CN0073) UL-CCIC COMPANY LIMITED has been recognized to perform compliance testing on equipment subject to the Commission's Declaration of Conformity (DoC) and Certification rules.</p>
---------------------------	---

Note 1: All tests measurement facilities use to collect the measurement data are located at No. 2, Chengwan Road, Suzhou Industrial Park, Suzhou 215122, China.

Note 2: For below 30MHz, lab had performed measurements at test anechoic chamber and comparing to measurements obtained on an open field site. These measurements below 30MHz had been correlated to measurements performed on an OFS.

Note 3: The test anechoic chamber in UL-CCIC COMPANY LIMITED had been calibrated and compared to the open field sites and the test anechoic chamber is shown to be equivalent to or worst case from the open field site.

4. CALIBRATION AND UNCERTAINTY

4.1. MEASURING INSTRUMENT CALIBRATION

The measuring equipment utilized to perform the tests documented in this report has been calibrated in accordance with the manufacturer's recommendations and is traceable to recognized national standards.

4.2. MEASUREMENT UNCERTAINTY

Where relevant, the following measurement uncertainty levels have been estimated for tests performed on the apparatus:

Test Item	Uncertainty
Conduction emission	3.1dB
Maximum Conduct Output Power	± 1.3dB
DTS Bandwidth	±1.9 %
Maximum Conducted Output Power	± 0.69dB
Maximum Power Spectral Density Level	±1.5 dB
Band-edge Compliance	± 1.9%
Unwanted Emissions in Non-restricted Freq Bands	9kHz-30MHz: ±0.90dB 30MHz-1GHz: ±1.5 dB 1GHz-12.75GHz: ±1.9dB 12.75GHz-26.5GHz: ±2.1dB
Radiation Emission test (include Fundamental emission) (9kHz-30MHz)	3.4dB
Radiation Emission test (include Fundamental emission) (30MHz-1GHz)	3.4dB
Radiation Emission test (1GHz to 26GHz) (include Fundamental emission)	3.5dB (1GHz-18GHz)
	3.9dB (18GHz-26.5GHz)
Note: This uncertainty represents an expanded uncertainty expressed at approximately the 95% confidence level using a coverage factor of k=2.	

5. EQUIPMENT UNDER TEST

5.1. DESCRIPTION OF EUT

Product Name:	Smart Cordless Steam Floor Washer
Model No.:	SW110100US
Operating Frequency:	IEEE 802.11B/G/N(HT20): 2412MHz to 2462MHz IEEE 802.11N(HT40): 2422MHz to 2452MHz
Type of Modulation:	IEEE for 802.11B: DSSS (CCK, DQPSK, DBPSK) IEEE for 802.11G: OFDM (64QAM, 16QAM, QPSK, BPSK) IEEE for 802.11N(HT20 and HT40): OFDM (64QAM, 16QAM, QPSK, BPSK)
Channels Step:	Channels with 5MHz step
Test software of EUT:	EspRFTestTool (manufacturer declare)
Antenna Type:	PCB Antenna
Antenna Gain:	2.87 dBi
	Note: This data is provided by customer and our lab isn't responsible for this data.
Power Supply:	Adapter 1: Model: YLJX2I-T300100 INPUT: 100-240V~ 50/60Hz 1.0A Max OUTPUT:30.0V=1.0A
	Adapter 2: Model: KL-WA300100-X INPUT: 100-240V~ 50/60Hz 1.2A OUTPUT:30.0V=1.0A
	Note: Two models of adapter will be collocated to the EUT, both of them have been test, the model KL-WA300100-X is the worse case and recorded in this test report.

5.2. MAXIMUM OUTPUT POWER

Number of Transmit Chains (NTX)	IEE Std. 802.11	Channel Number	Max AVG Conducted Power (dBm)
1	IEEE 802.11B	1-11[11]	17.82
1	IEEE 802.11G	1-11[11]	16.04
1	IEEE 802.11N HT20	1-11[11]	15.87
1	IEEE 802.11N HT40	3-9[7]	15.44

5.3. CHANNEL LIST

Channel List for 802.11B/G/N(20 MHz)							
Channel	Frequency (MHz)	Channel	Frequency (MHz)	Channel	Frequency (MHz)	Channel	Frequency (MHz)
1	2412	4	2427	7	2442	10	2457
2	2417	5	2432	8	2447	11	2462
3	2422	6	2437	9	2452		

Channel List for 802.11N(40 MHz)							
Channel	Frequency (MHz)	Channel	Frequency (MHz)	Channel	Frequency (MHz)	Channel	Frequency (MHz)
3	2422	5	2432	7	2442	9	2452
4	2427	6	2437	8	2447		

5.4. TEST CHANNEL CONFIGURATION

Test Mode	Test Channel (MHz)
IEEE 802.11B	LCH: CH01 2412
	MCH: CH06 2437
	HCH: CH11 2462
IEEE 802.11G	LCH: CH01 2412
	MCH: CH06 2437
	HCH: CH11 2462
IEEE 802.11N HT20	LCH: CH01 2412
	MCH: CH06 2437
	HCH: CH11 2462
IEEE 802.11N HT40	LCH: CH03 2422
	MCH: CH06 2437
	HCH: CH09 2452

5.5. THE WORSE CASE POWER SETTING PARAMETER

The Worse Case Power Setting Parameter under 2400 ~ 2483.5MHz Band							
Test Software		EspRFTTestTool					
Modulation Mode	Transmit Antenna Number	Test Channel					
		NCB: 20MHz			NCB: 40MHz		
		CH 1	CH 6	CH 11	CH 3	CH 6	CH 9
802.11B	1	default	default	default	/		
802.11G	1	default	default	default			
802.11N HT20	1	default	default	default			
802.11N HT40	1	/			default	default	default

5.6. DESCRIPTION OF AVAILABLE ANTENNAS

Ant.	Frequency (MHz)	Antenna Type	Antenna Gain (dBi)
1	2400-2483.5	PCB Antenna	2.87

Note: This data is provided by customer and our lab isn't responsible for this data.

Test Mode	Transmit and Receive Mode	Description
IEEE 802.11B	<input checked="" type="checkbox"/> 1TX, 1RX	Antenna1 can be used as transmitting/receiving antenna independently.
IEEE 802.11G	<input checked="" type="checkbox"/> 1TX, 1RX	Antenna1 can be used as transmitting/receiving antenna independently.
IEEE 802.11N HT20	<input checked="" type="checkbox"/> 1TX, 1RX	Antenna1 can be used as transmitting/receiving antenna independently.
IEEE 802.11N HT40	<input checked="" type="checkbox"/> 1TX, 1RX	Antenna1 can be used as transmitting/receiving antenna independently.

5.7. THE WORSE CASE CONFIGURATIONS

For WIFI module, the worst-case data rates as provided by the client were:

802.11B mode: 1 Mbps

802.11G mode: 6 Mbps

802.11N HT20 mode: MCS0

802.11N HT40 mode: MCS0

5.8. TEST ENVIRONMENT

Environment Parameter	Selected Values During Tests	
Relative Humidity:	55 ~ 65%	
Atmospheric Pressure:	1025Pa	
Temperature:	TN	23 ~ 28°C
Voltage:	VL	N/A
	VN	AC 120V
	VH	N/A

Note: VL= Lower Extreme Test Voltage

VN= Nominal Voltage

VH= Upper Extreme Test Voltage

TN= Normal Temperature

5.9. DESCRIPTION OF TEST SETUP

SUPPORT EQUIPMENT

Item	Equipment	Brand Name	Model Name	Description
1	Laptop	ThinkPad	E590	/

I/O PORT

Cable No	Port	Connector Type	Cable Type	Cable Length(m)	Remarks
1	USB	USB to TTL	USB	100cm Length	/
2	USB	USB	USB	100cm Length	/

ACCESSORY

Item	Accessory	Brand Name	Model Name	Description
1	AC/DC ADAPTOR	Yinli	YLJX21-T300100	INPUT: 100-240V~ 50/60Hz 1.0A Max OUTPUT:30.0V=1.0A
2	AC/DC ADAPTOR	KELI	KL-WA300100-X	INPUT: 100-240V~ 50/60Hz 1.2A OUTPUT:30.0V=1.0A

TEST SETUP

The EUT can work in an engineer mode with a software through a laptop.

SETUP DIAGRAM FOR TESTS

For Antenna Port test and Radiated Test:

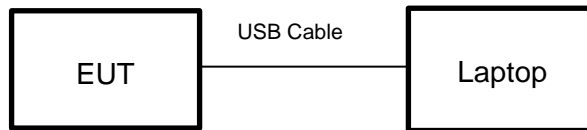

For Conducted Emission Test:

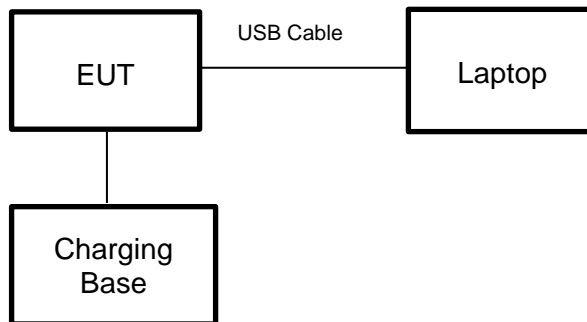

5.10. MEASURING INSTRUMENT AND SOFTWARE USED

Conducted Emissions (Instrument)							
Used	Equipment	Manufacturer	Model No.	Serial No.	Upper Last Cal.	Last Cal.	Next Cal.
<input checked="" type="checkbox"/>	EMI Test Receiver	R&S	ESR3	126700	2021-12-04	2022-12-03	2023-12-02
<input checked="" type="checkbox"/>	Two-Line V-Network	R&S	ENV216	126701	2021-12-04	2022-12-03	2023-12-02
<input checked="" type="checkbox"/>	Artificial Mains Networks	R&S	ENY81	126712	2021-10-12	2022-10-09	2023-10-08
Software							
Used	Description		Manufacturer	Name	Version		
<input checked="" type="checkbox"/>	Test Software for Conducted disturbance		R&S	EMC32	Ver. 9.25		
Radiated Emissions (Instrument)							
Used	Equipment	Manufacturer	Model No.	Serial No.	Upper Last Cal.	Last Cal.	Next Cal.
<input checked="" type="checkbox"/>	EMI test receiver	R&S	ESR7	222993	2022-05-20	2023-04-08	2024-04-07
<input checked="" type="checkbox"/>	EMI test receiver	R&S	ESR26	126703	2021-12-04	2022-12-03	2023-12-02
<input checked="" type="checkbox"/>	Spectrum Analyzer	R&S	FSV3044	222992	2022-05-20	2023-04-08	2024-04-07
<input checked="" type="checkbox"/>	Receiver Antenna (9kHz-30MHz)	Schwarzbeck	FMZB 1513	155456	2018-06-04	2021-06-03	2024-06-02
<input checked="" type="checkbox"/>	Receiver Antenna (30MHz-1GHz)	Schwarzbeck	VULB 9163	126704	2019-01-19	2022-01-18	2025-01-17
<input checked="" type="checkbox"/>	Receiver Antenna (1GHz-18GHz)	R&S	HF907	126705	2019-01-27	2022-02-28	2025-02-27
<input checked="" type="checkbox"/>	Receiver Antenna (18GHz-26.5GHz)	Schwarzbeck	BBHA9170	126706	2019-02-29	2022-02-28	2025-02-27
<input checked="" type="checkbox"/>	Pre-amplification (To 18GHz)	Tonscnd	TAP01018050	224539	/	2022-10-20	2023-10-19
<input checked="" type="checkbox"/>	Pre-amplification (To 18GHz)	R&S	SCU-18D	134667	2021-12-04	2022-12-03	2023-12-02
<input checked="" type="checkbox"/>	Pre-amplification (To 26.5GHz)	R&S	SCU-26D	135391	2021-12-04	2022-12-03	2023-12-02
<input checked="" type="checkbox"/>	Band Reject Filter	Wainwright	WRCGV12-2375-2400-2485-2510-40SS	1	2022-05-20	2023-04-08	2024-04-07
<input checked="" type="checkbox"/>	High Pass Filter	COM-MW	ZBF13-3-18G-01	2	2022-05-20	2023-04-08	2024-04-07
Software							
Used	Description		Manufacturer	Name	Version		
<input checked="" type="checkbox"/>	Test Software for Radiated disturbance		Tonscnd	TS+	Ver. 2.5		
<input checked="" type="checkbox"/>	Test Software for Radiated disturbance		Chinese-EMC	RE_RSE	Ver. 3.03		
Other instruments							
Used	Equipment	Manufacturer	Model No.	Serial No.	Upper Last Cal.	Last Cal.	Next Cal.
<input checked="" type="checkbox"/>	Spectrum Analyzer	Keysight	N9010B	155368	2022-05-20	2023-04-08	2024-04-07
<input checked="" type="checkbox"/>	Power Meter	MWT	MW100-RFCB	221694	2022-05-23	2023-04-08	2024-04-07
<input checked="" type="checkbox"/>	Attenuator	PASTERNAK	PE7087-6	1624	2022-05-23	2023-04-08	2024-04-07

6. MEASUREMENT METHODS

No.	Test Item	KDB Name	Section
1	6dB Bandwidth and 99% Occupied Bandwidth	KDB 558074 D01 15.247 Meas Guidance v05r02	8.2
2	Output Power	KDB 558074 D01 15.247 Meas Guidance v05r02	8.3.2.3 (Method PM)
3	Power Spectral Density	KDB 558074 D01 15.247 Meas Guidance v05r02	8.4 (Method PKPSD)
4	Out-of-band emissions in non-restricted bands	KDB 558074 D01 15.247 Meas Guidance v05r02	8.5
5	Out-of-band emissions in restricted bands	KDB 558074 D01 15.247 Meas Guidance v05r02	8.6
6	Band-edge	KDB 558074 D01 15.247 Meas Guidance v05r02	8.7
7	Conducted Emission Test for AC Power Port	ANSI C63.10-2013	6.2

7. ANTENNA PORT TEST RESULTS

7.1. ON TIME AND DUTY CYCLE

LIMITS

None; for reporting purposes only

PROCEDURE

FCC KDB 558074 Zero-Span Spectrum Analyzer Method

TEST SETUP

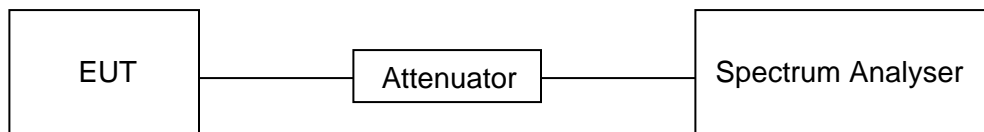

TEST ENVIRONMENT

Temperature	22°C	Relative Humidity	56%
Atmosphere Pressure	101kPa	Test Voltage	AC 120V

TEST RESULTS TABLE

Mode	On Time (msec)	Period (msec)	Duty Cycle x (Linear)	Duty Cycle (%)	Duty Cycle Correction Factor (db)	1/T Minimum VBW (kHz)	Final VBW (kHz)
11B	100	100	1	100%	0	0.01	0.01
11G	100	100	1	100%	0	0.01	0.01
802.11N HT20	100	100	1	100%	0	0.01	0.01
802.11N HT40	100	100	1	100%	0	0.01	0.01

- Note: 1) Duty Cycle Correction Factor=10log(1/x).
 2) Where: x is Duty Cycle (Linear)
 3) Where: T is On Time (transmit duration)
 4) If the duty cycle is above 98%, the Final VBW is 10Hz.

TEST GRAPHS

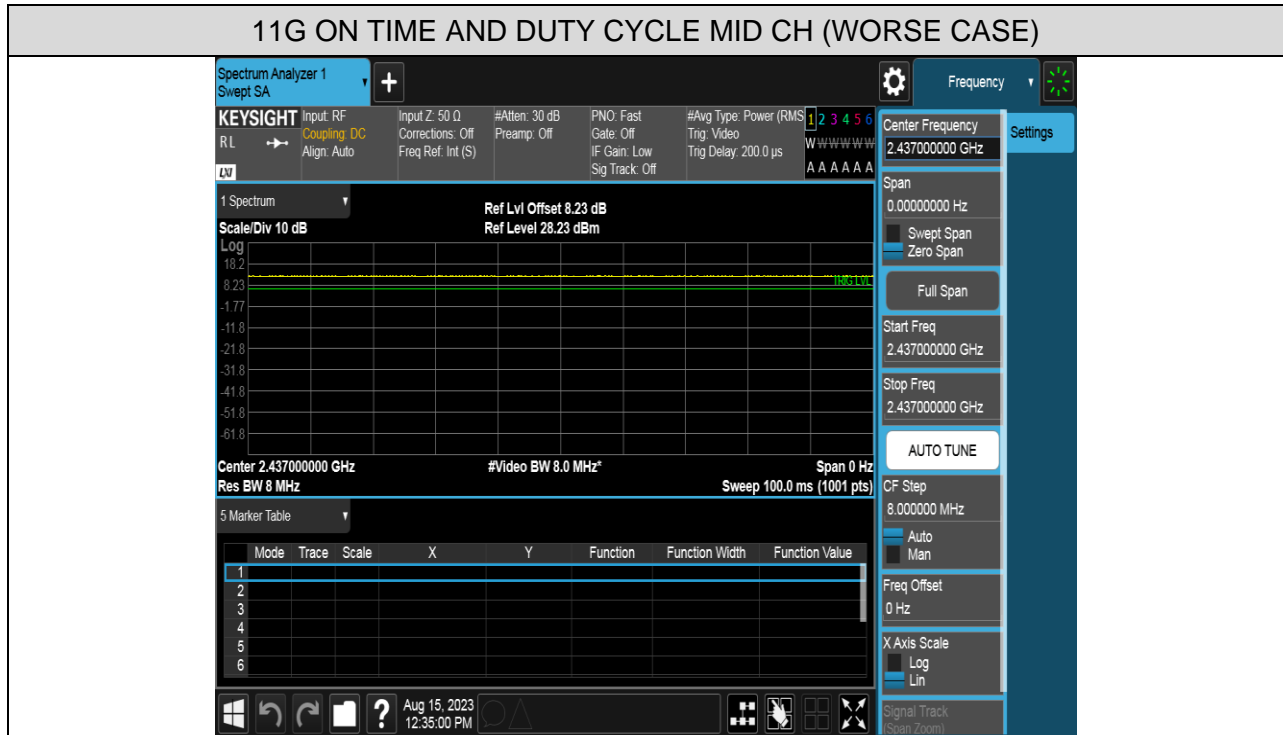
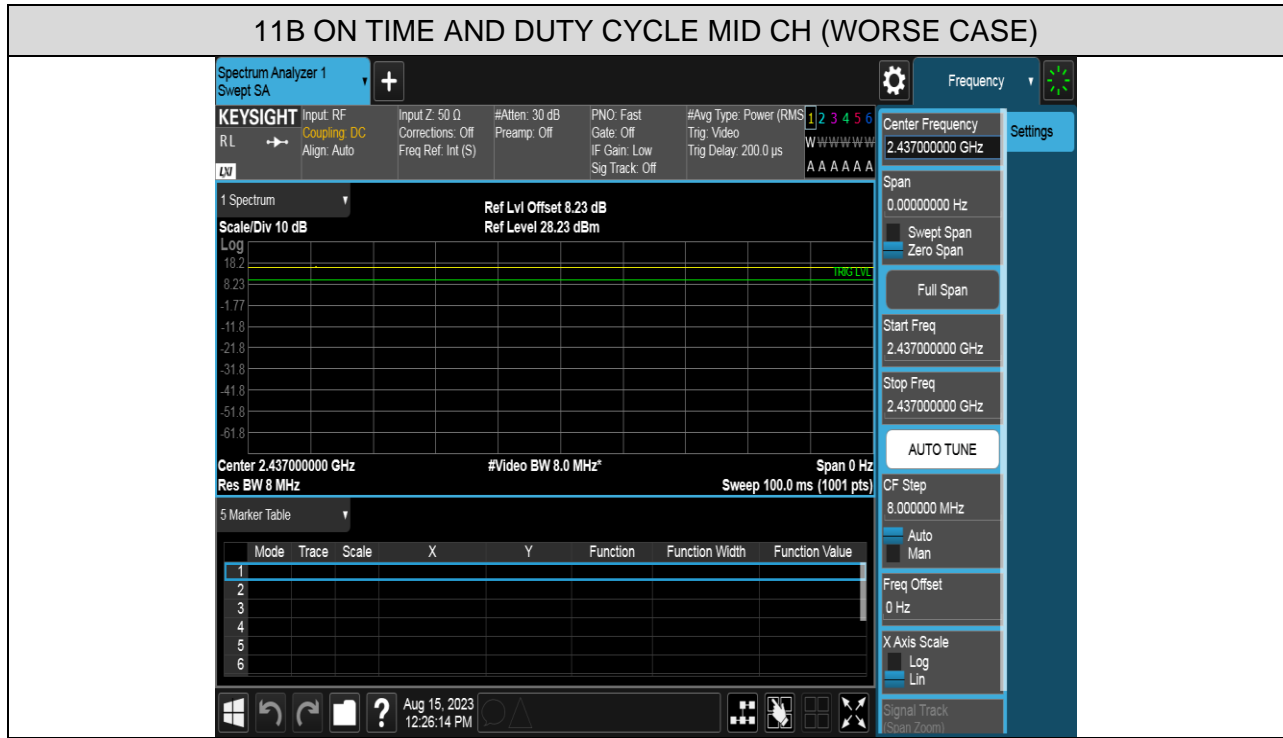

11N HT20 ON TIME AND DUTY CYCLE MID CH (WORSE CASE)

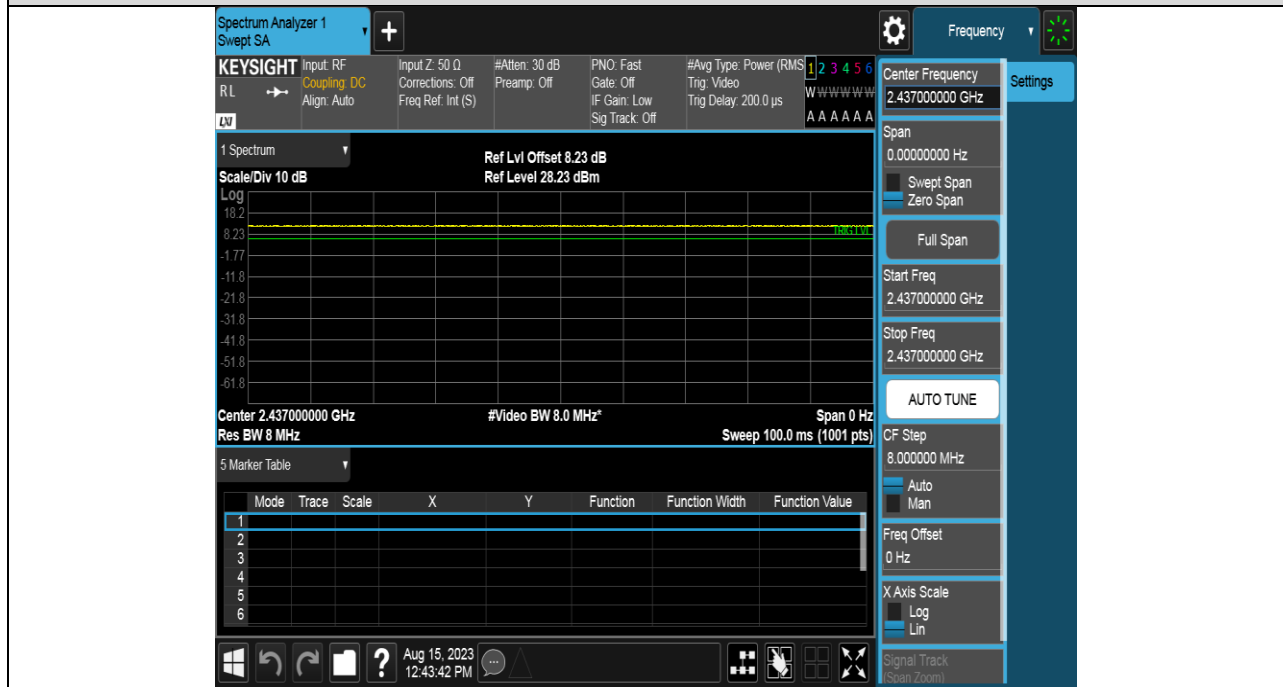

11N HT40 ON TIME AND DUTY CYCLE MID CH (WORSE CASE)

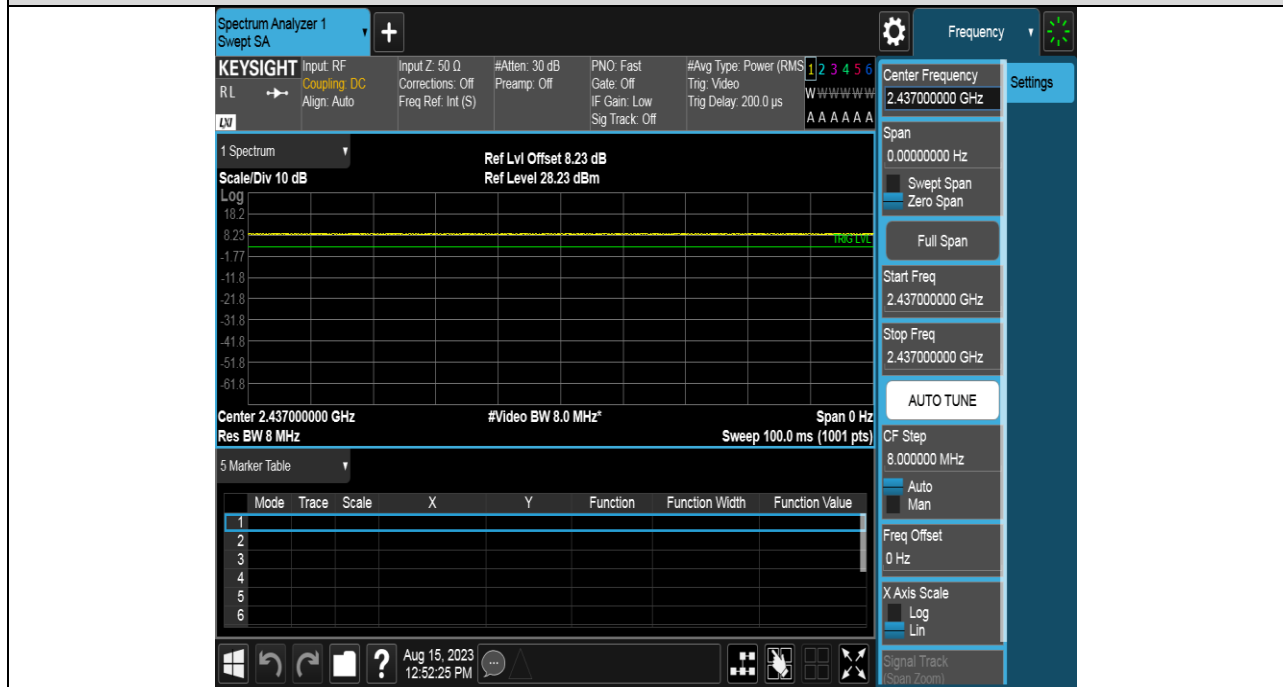

7.2. 6 dB BANDWIDTH AND 99% OCCUPIED BANDWIDTH

LIMITS

FCC Part15 (15.247), Subpart C			
Section	Test Item	Limit	Frequency Range (MHz)
CFR 47 FCC 15.247(a)(2) ISED RSS-247 5.2 (a)	6dB Bandwidth	$\geq 500\text{kHz}$	2400-2483.5
ISED RSS-Gen Clause 6.7	99 % Occupied Bandwidth	For reporting purposes only	2400-2483.5

TEST PROCEDURE

Refer to ANSI C63.10-2013 clause 11.8 for DTS bandwidth and clause 6.9 for Occupied Bandwidth.

Connect the EUT to the spectrum analyser and use the following settings:

Center Frequency	The centre frequency of the channel under test
Detector	Peak
RBW	For 6 dB Bandwidth: 100 kHz For 99 % Occupied Bandwidth: 1 % to 5 % of the occupied bandwidth
VBW	For 6 dB Bandwidth: $\geq 3 \times \text{RBW}$ For 99 % Occupied Bandwidth: $\geq 3 \times \text{RBW}$
Trace	Max hold
Sweep	Auto couple

a) Use the 99 % power bandwidth function of the instrument, allow the trace to stabilize and report the measured bandwidth.

b) Allow the trace to stabilize and measure the maximum width of the emission that is constrained by the frequencies associated with the two outermost amplitude points (upper and lower frequencies) that are attenuated by 6 dB relative to the maximum level measured in the fundamental emission.

TEST SETUP

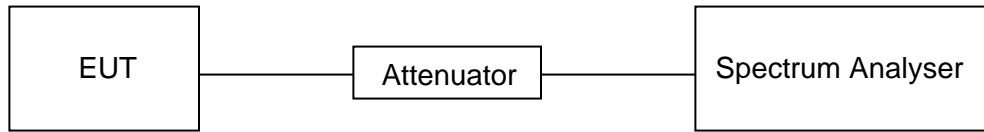

TEST ENVIRONMENT

Temperature	22°C	Relative Humidity	56%
Atmosphere Pressure	101kPa	Test Voltage	AC 120V

TEST RESULTS TABLE

Test Mode	Test Channel	6dB bandwidth (MHz)	99% bandwidth (MHz)	Result
11B	LCH	9.1120	13.205	Pass
	MCH	9.0680	13.148	Pass
	HCH	9.3307	13.158	Pass
11G	LCH	16.4093	16.532	Pass
	MCH	16.4120	16.533	Pass
	HCH	16.4080	16.529	Pass
11N HT20	LCH	17.0347	17.413	Pass
	MCH	17.3133	17.427	Pass
	HCH	17.3093	17.430	Pass
11N HT40	LCH	33.3093	34.569	Pass
	MCH	32.9280	34.576	Pass
	HCH	33.4880	34.609	Pass

TEST GRAPHS

6dB Bandwidth

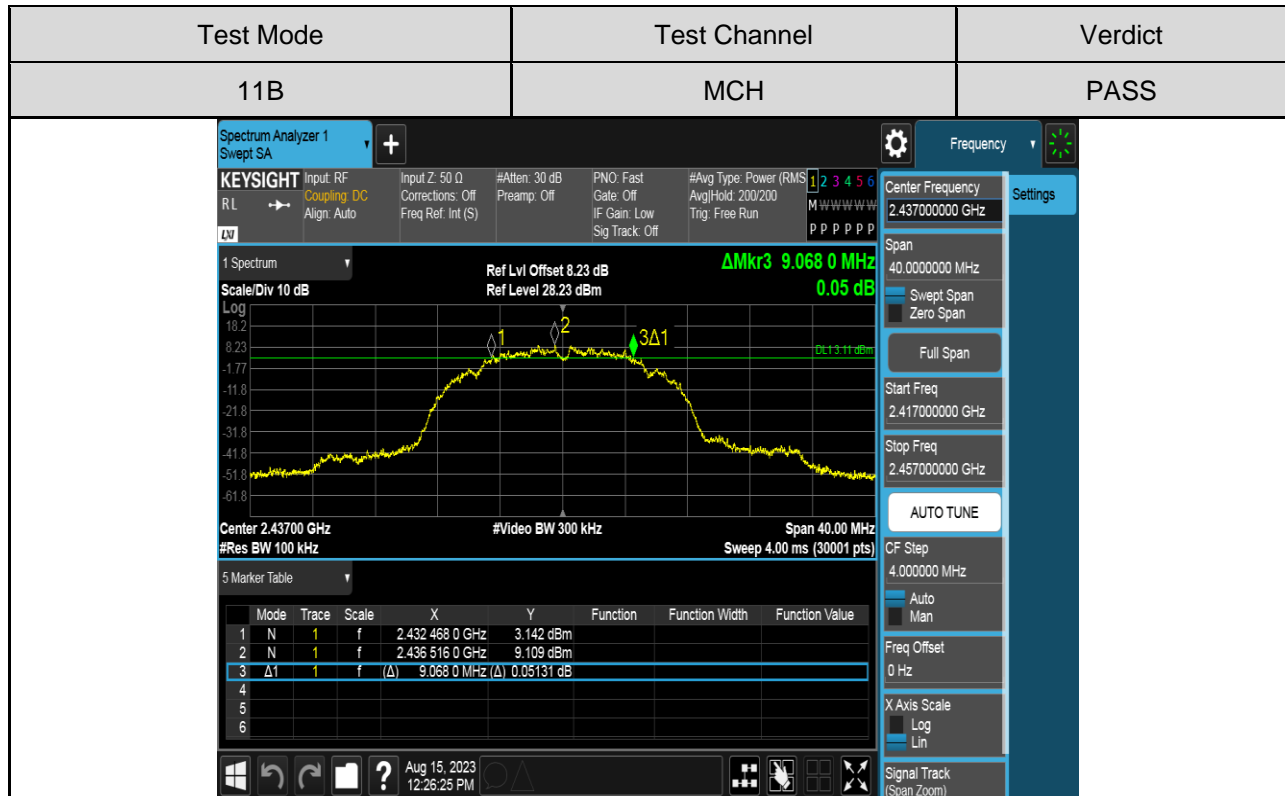
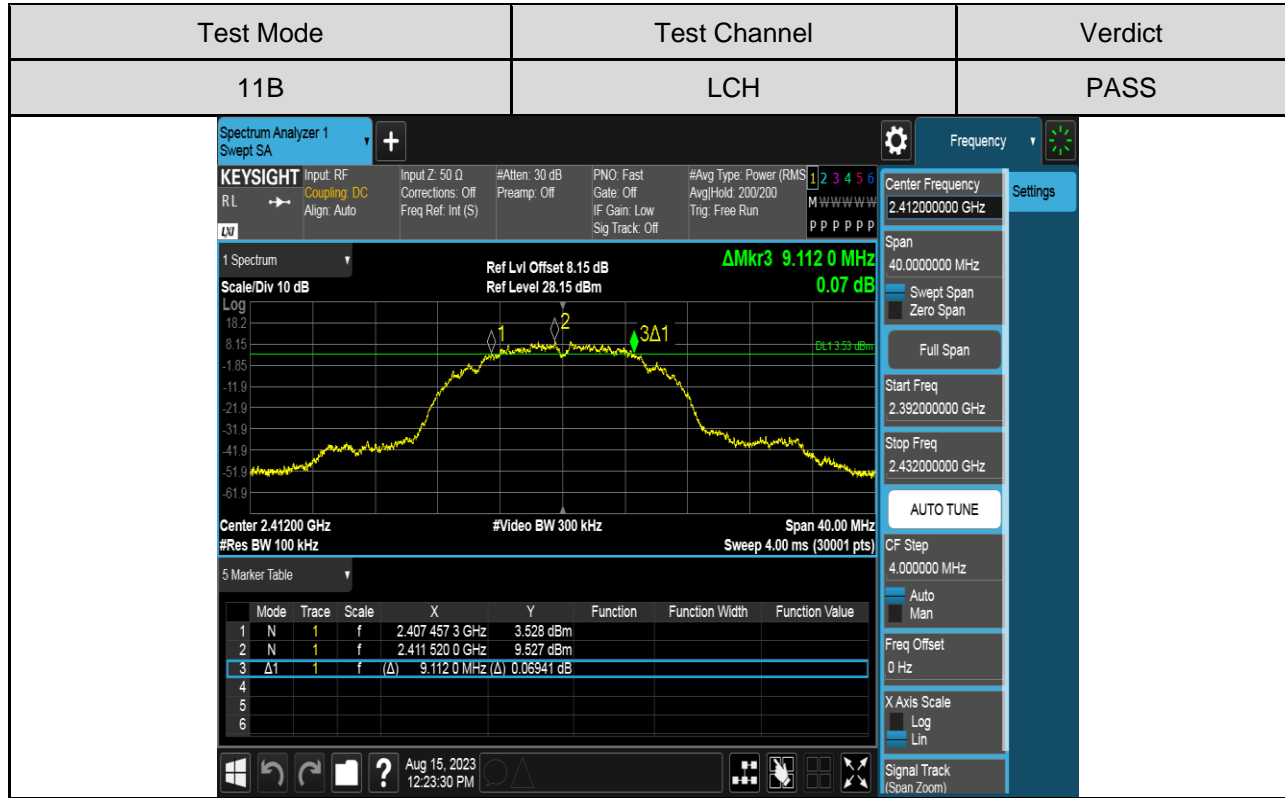

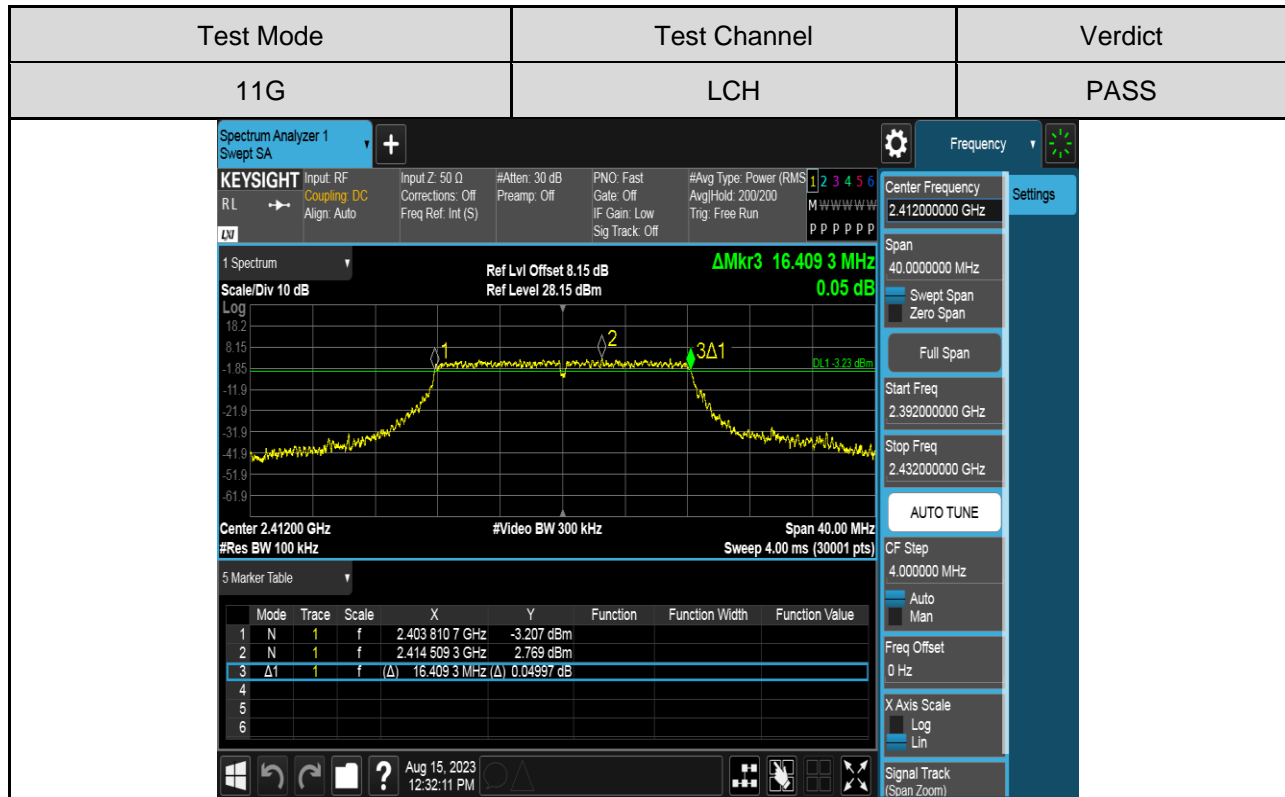
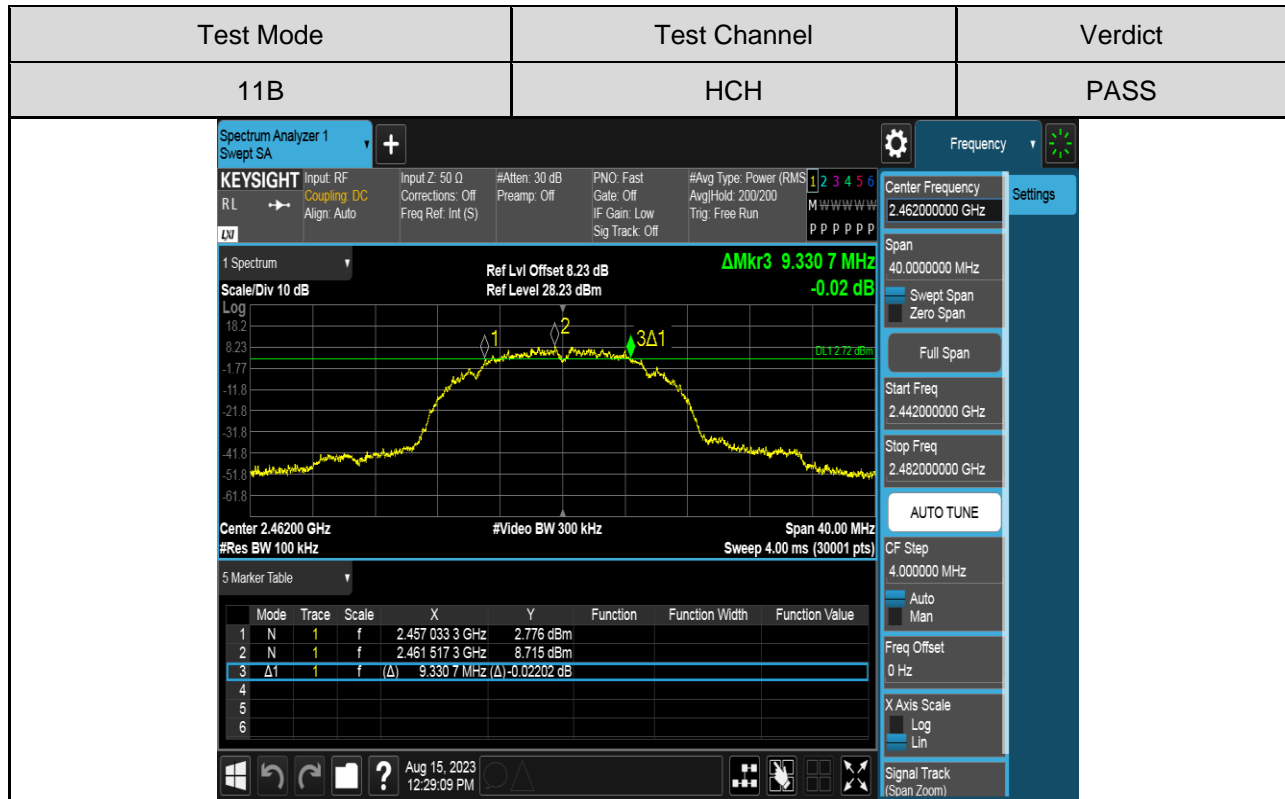

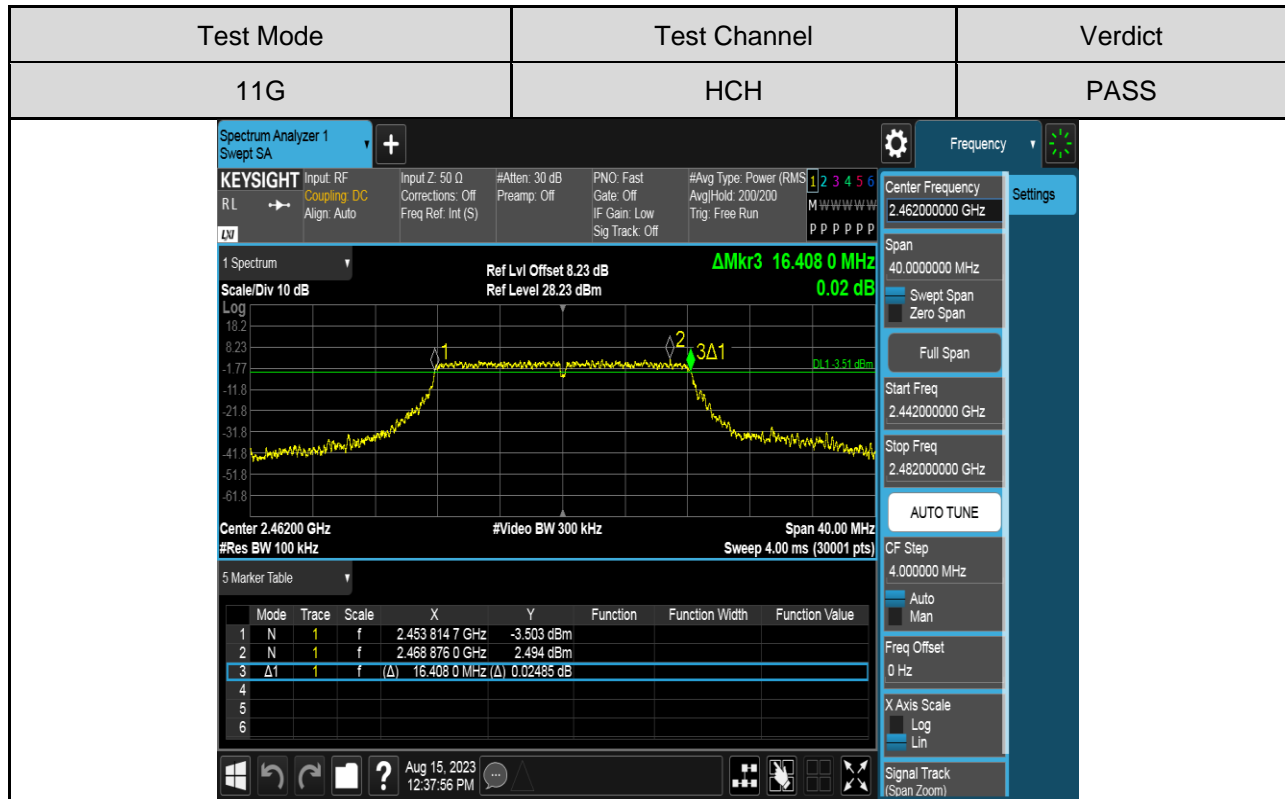
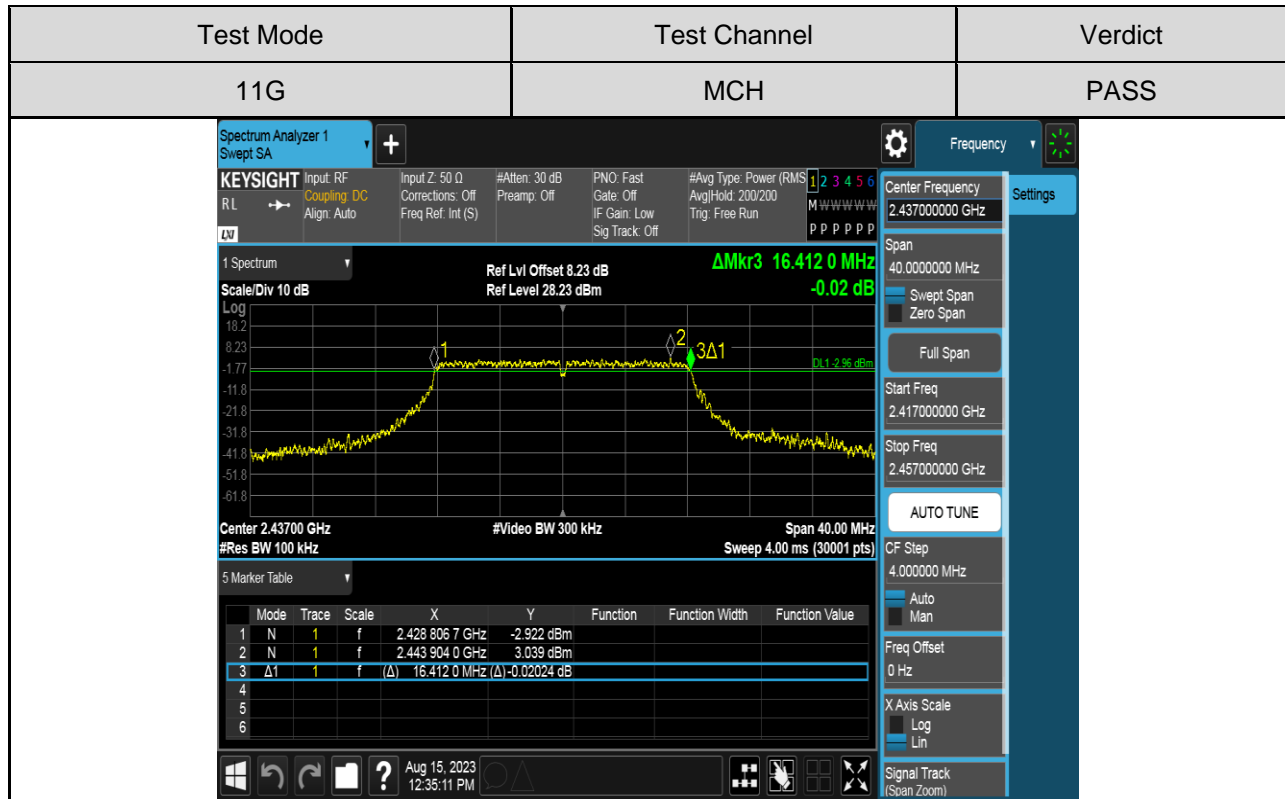

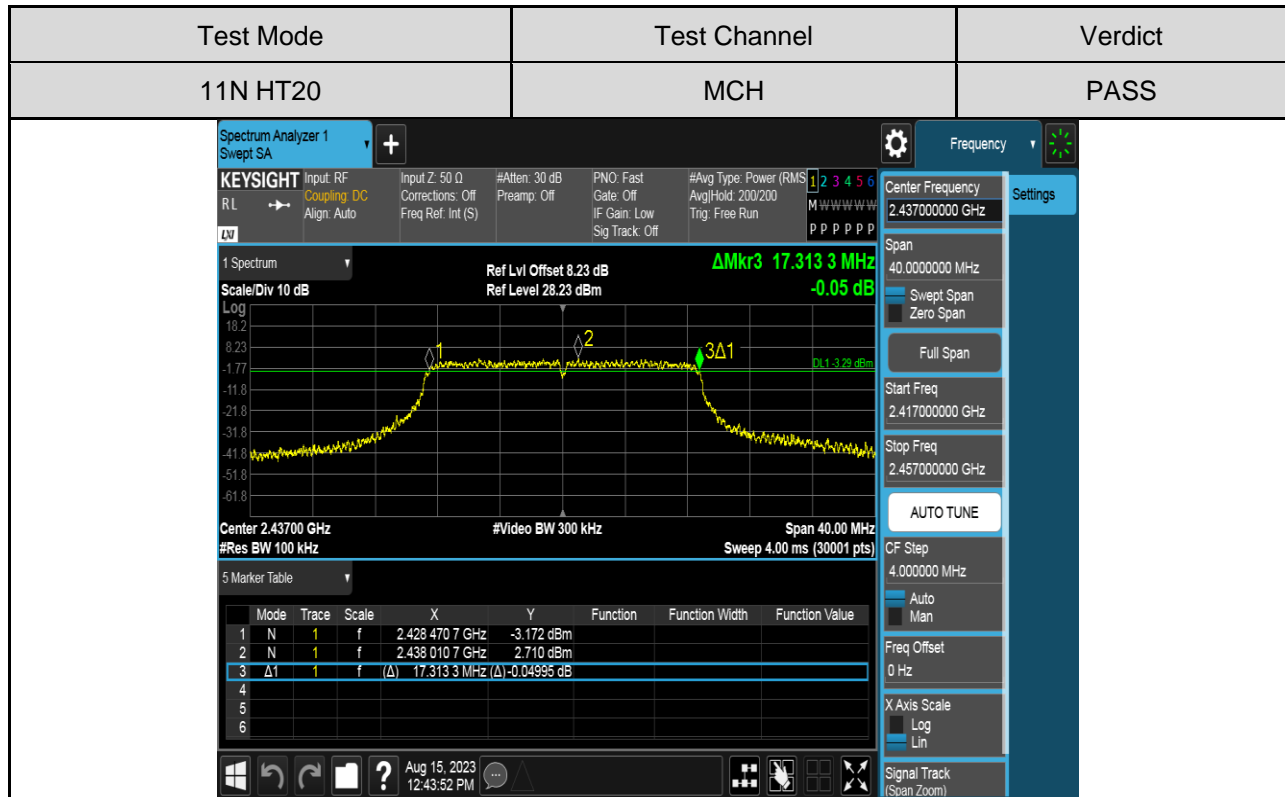
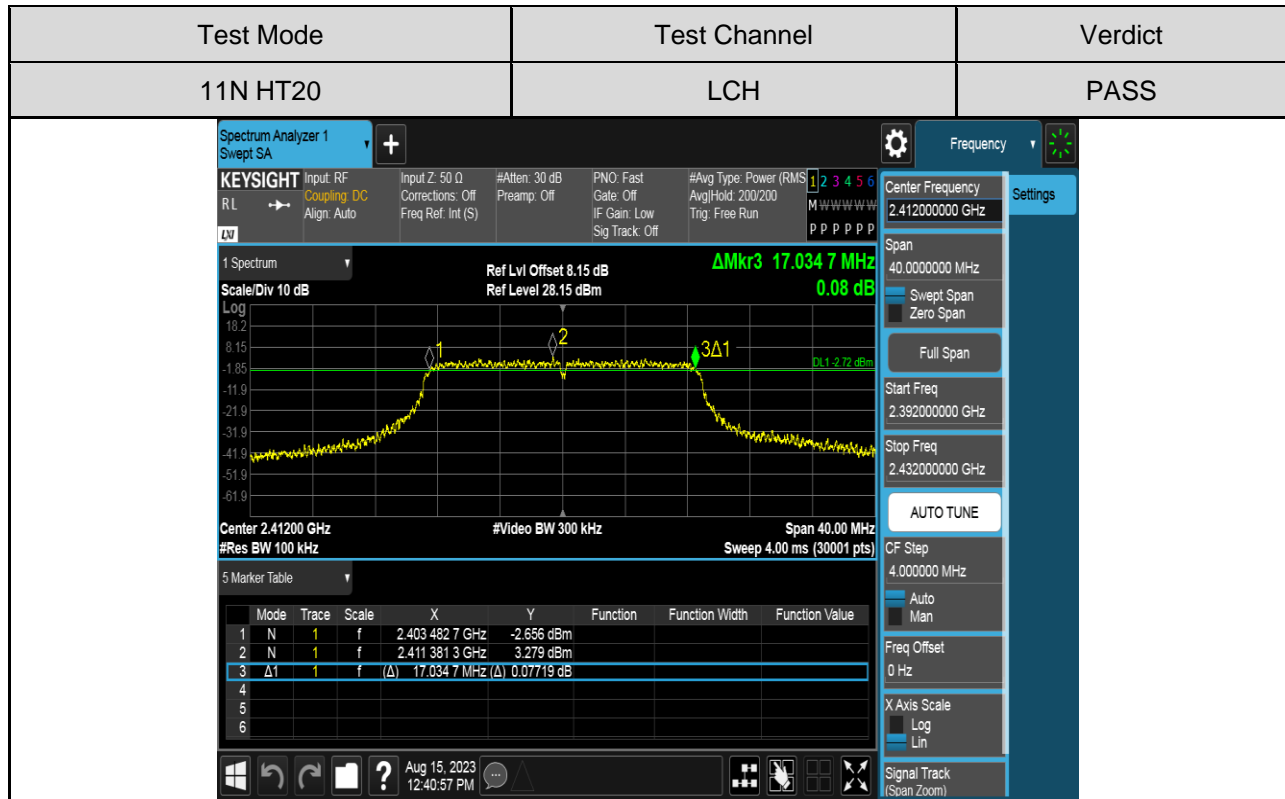

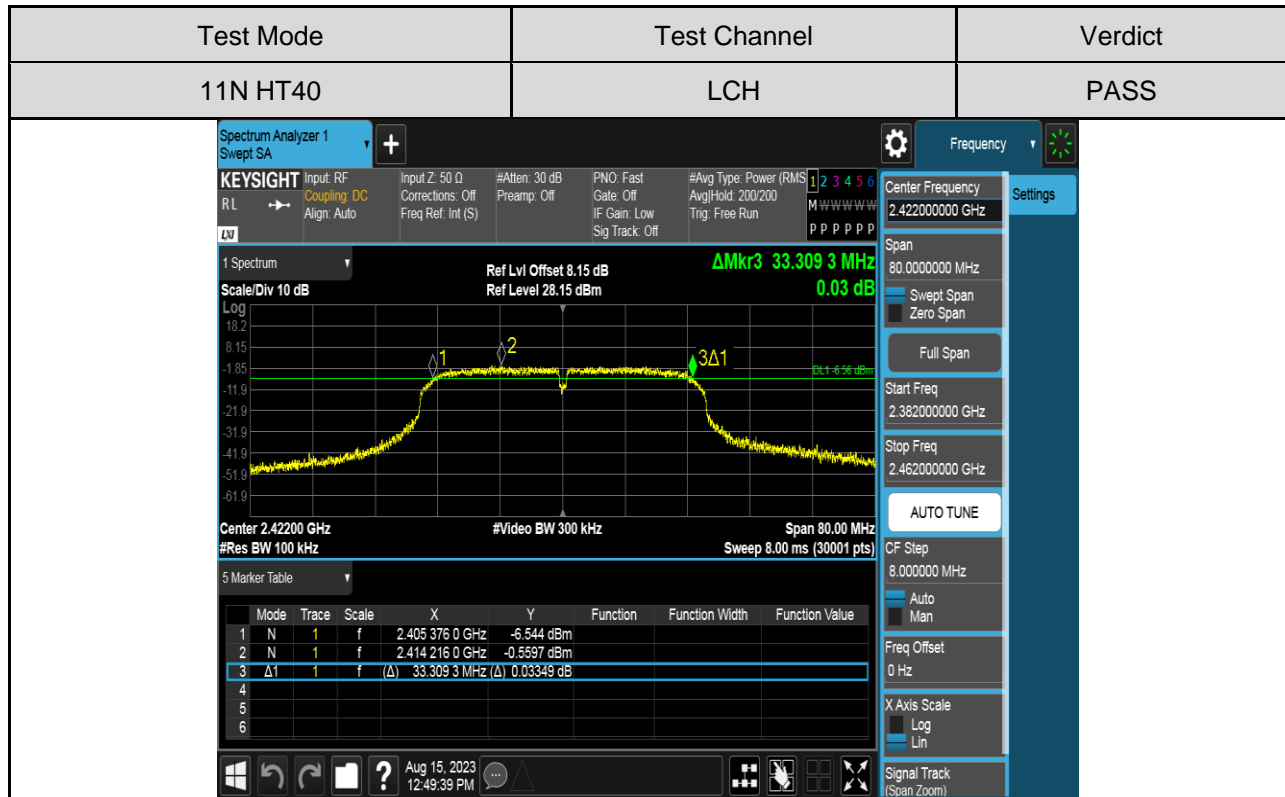
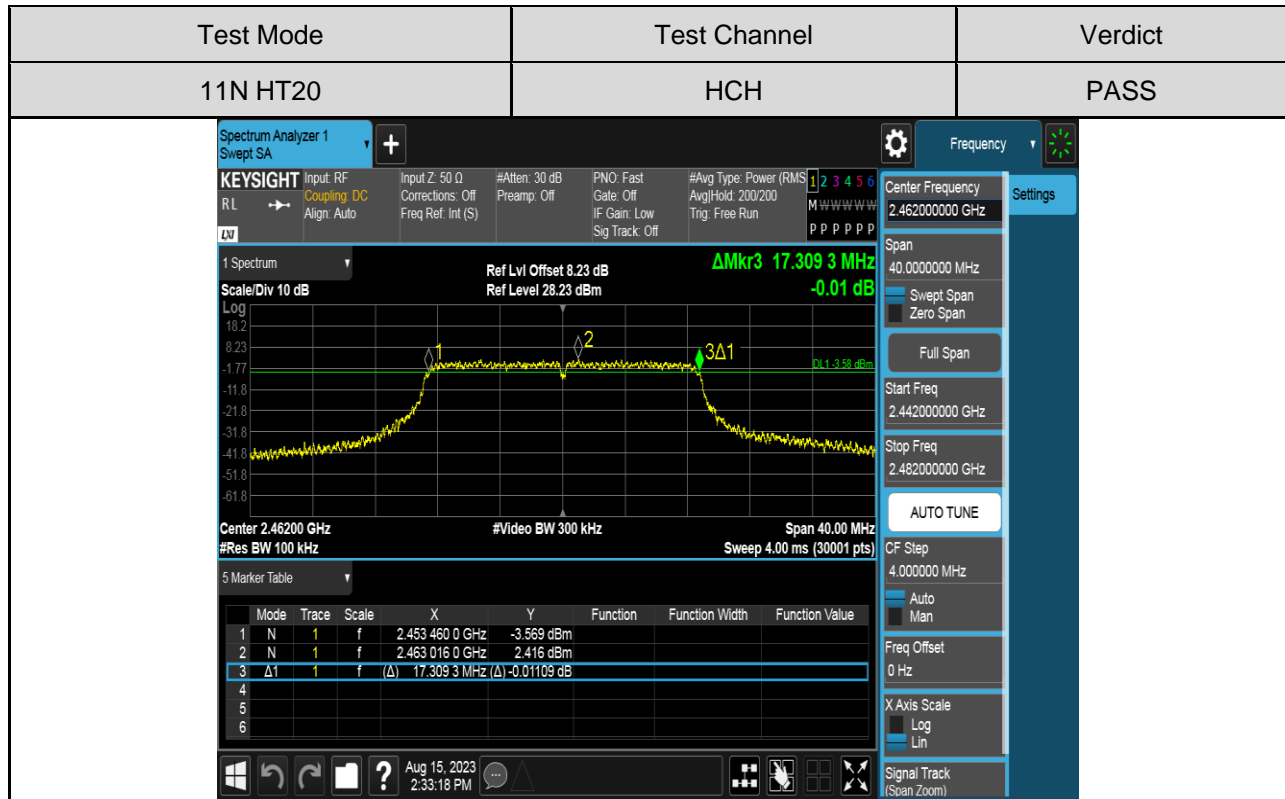

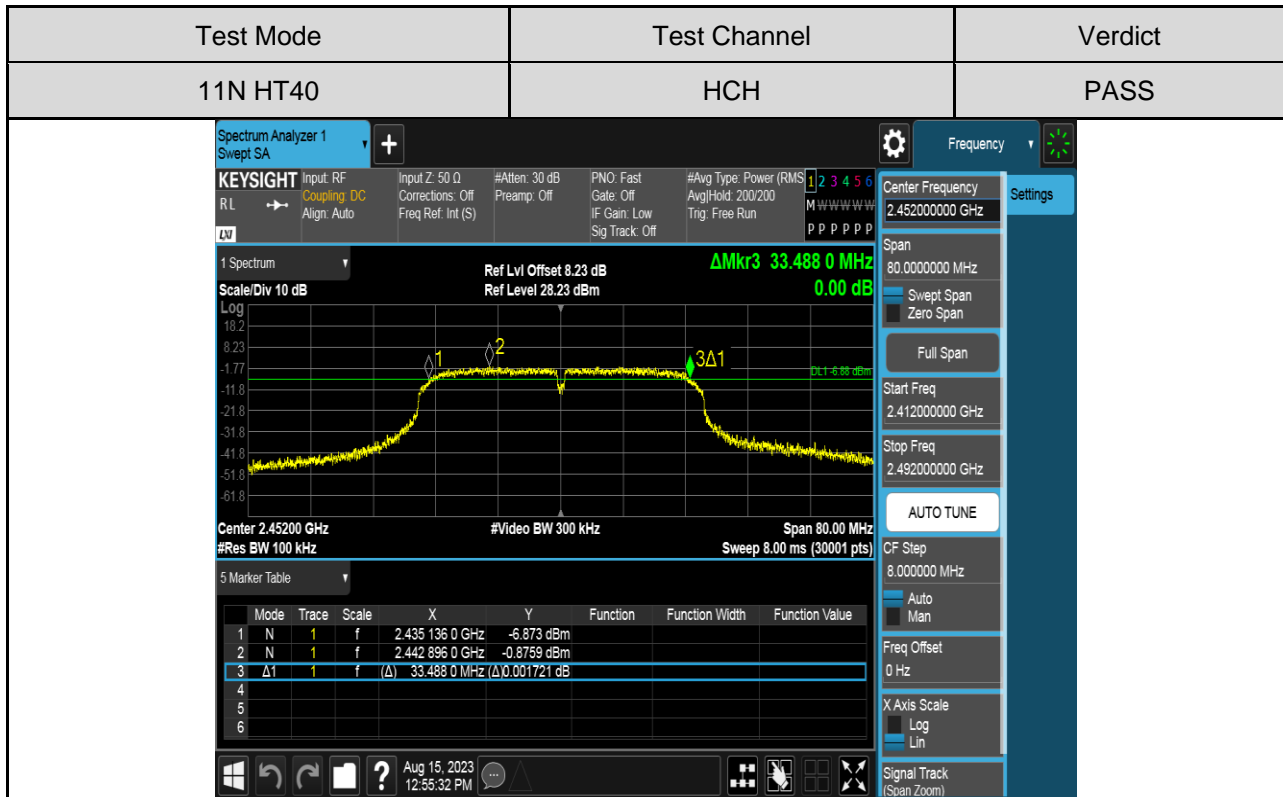
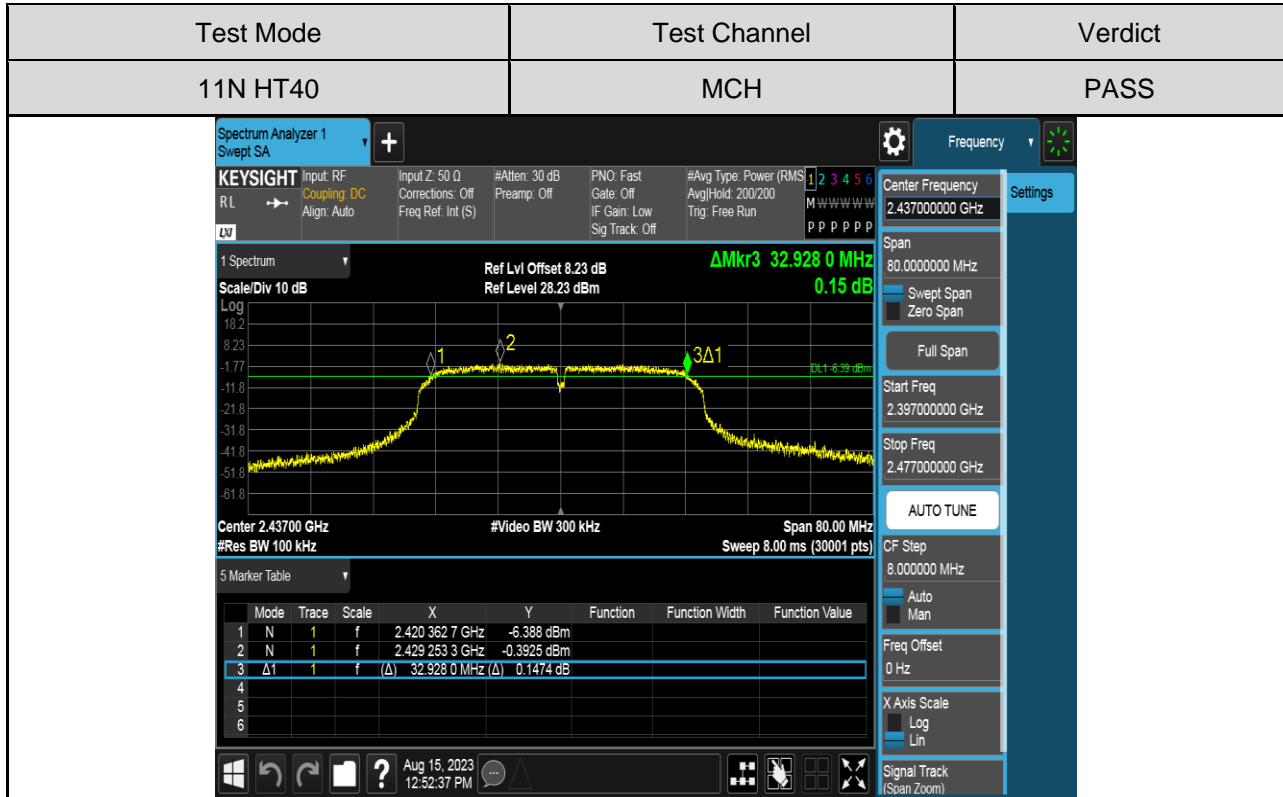

99% Bandwidth

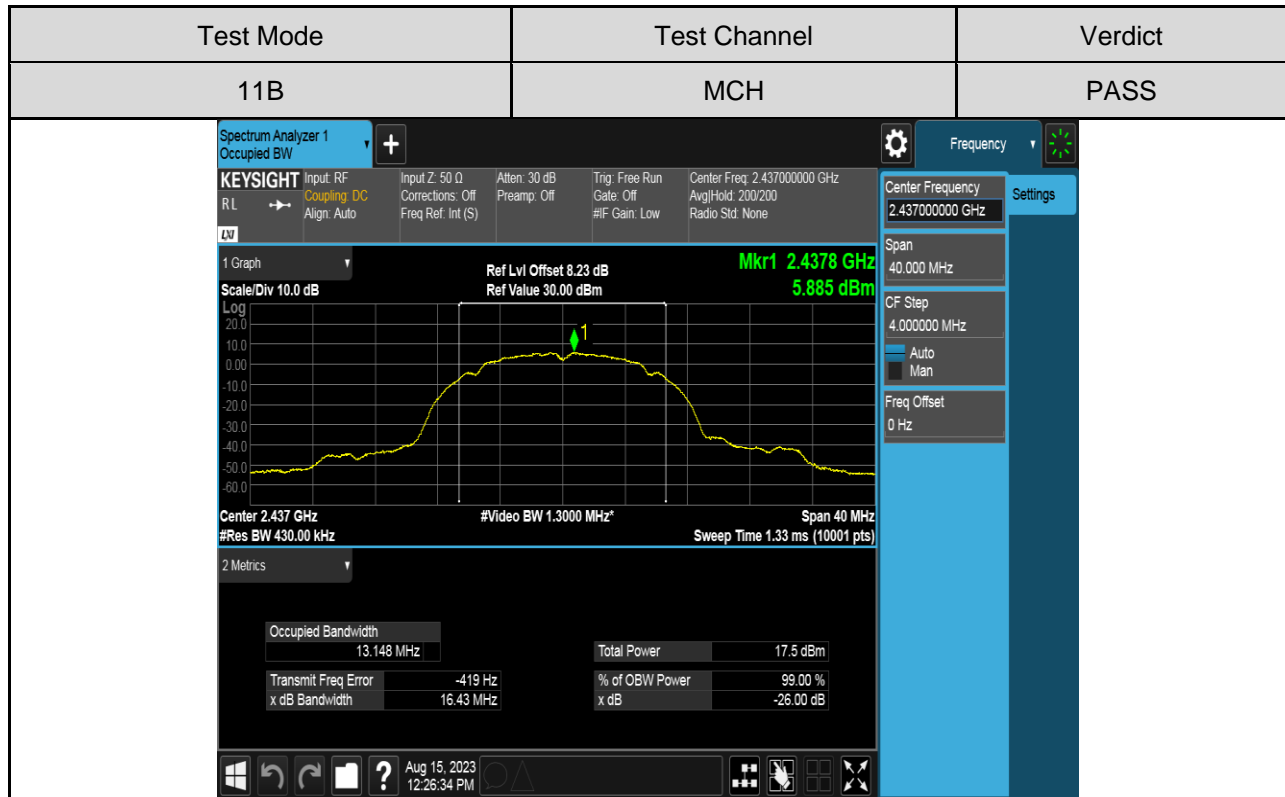
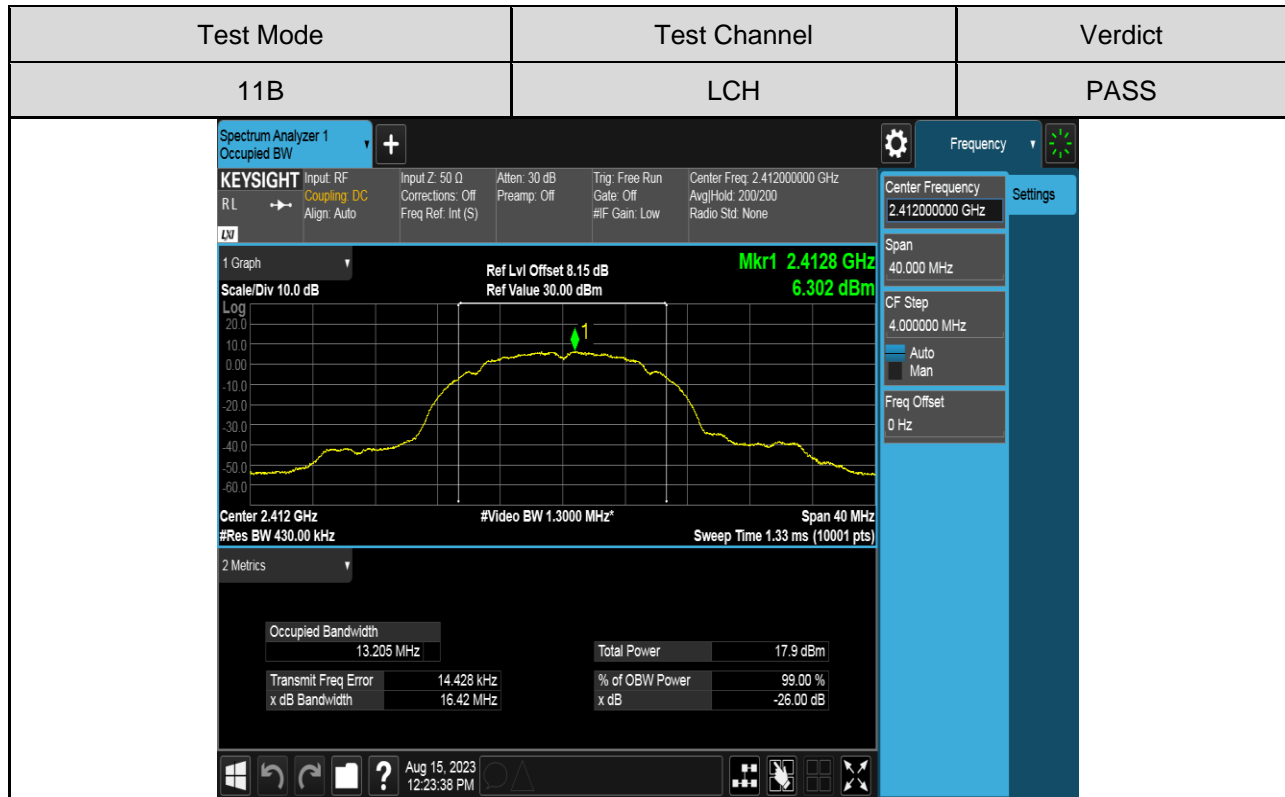

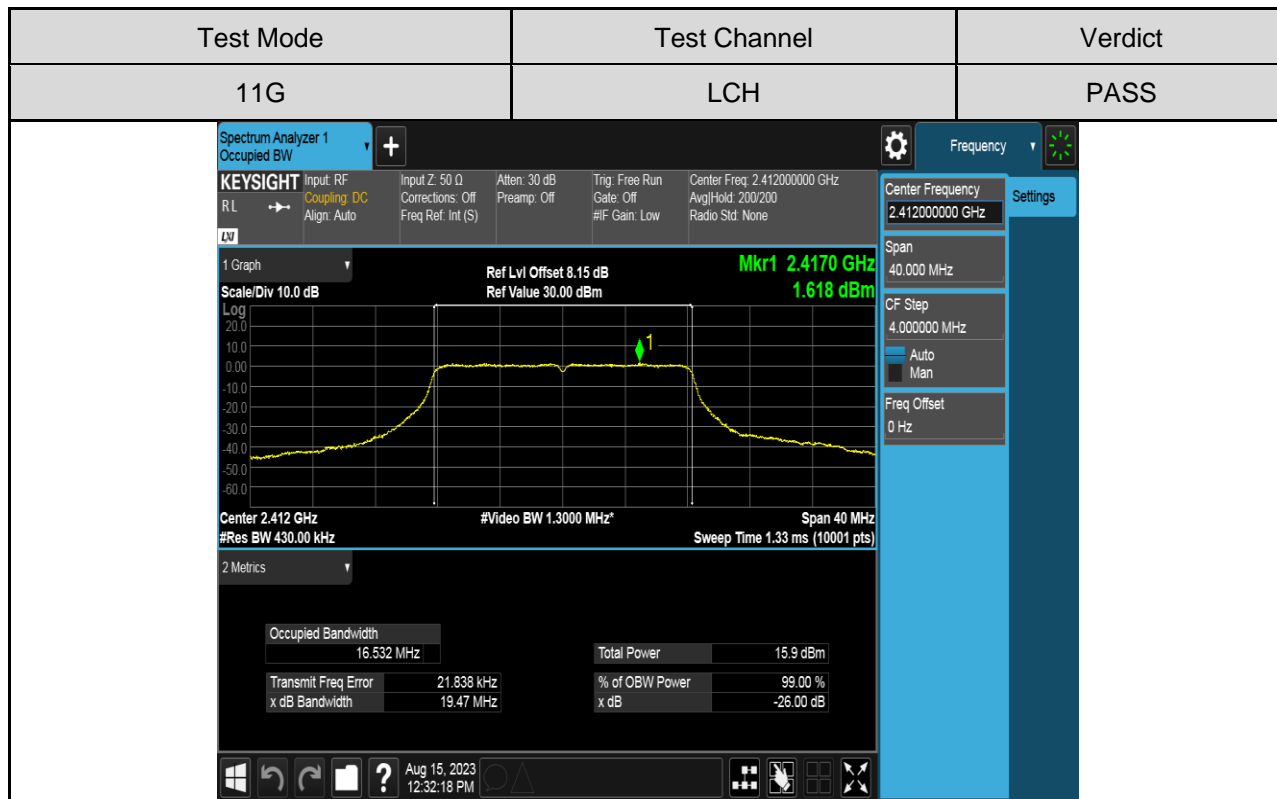
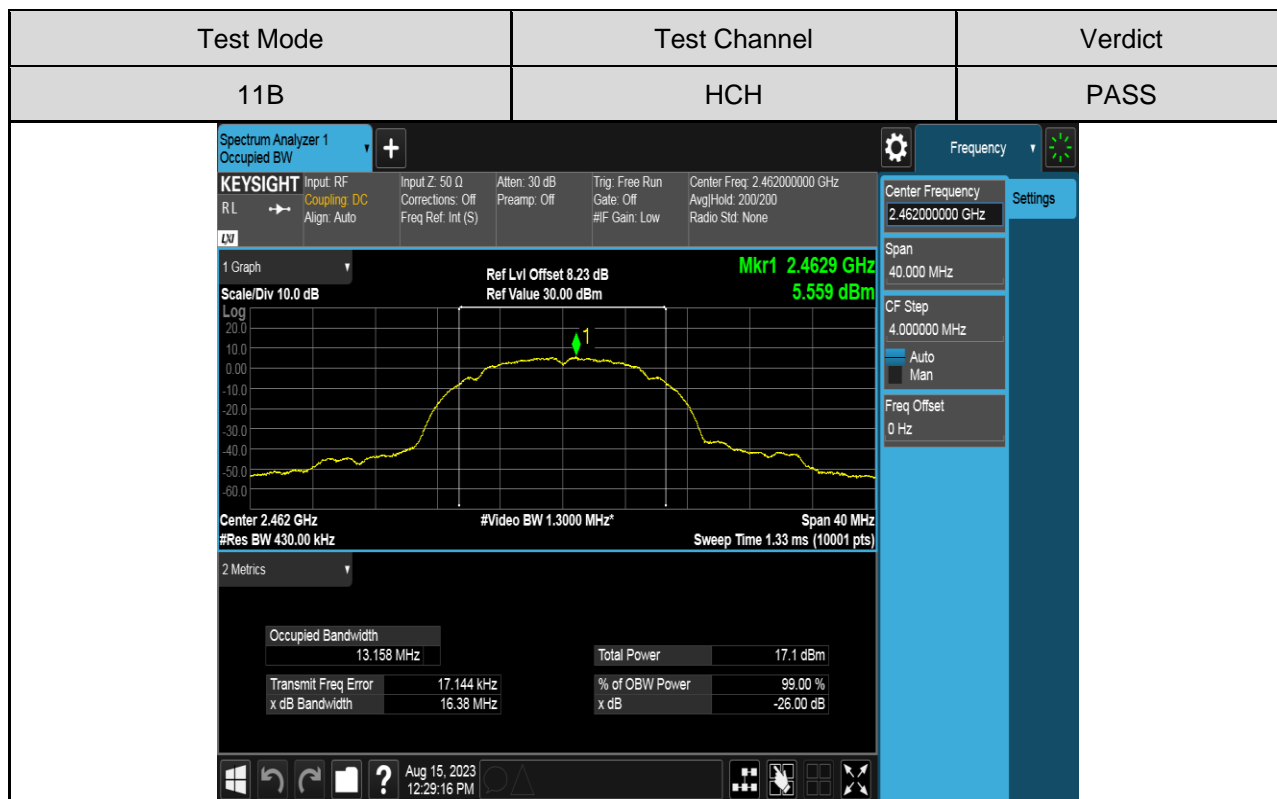

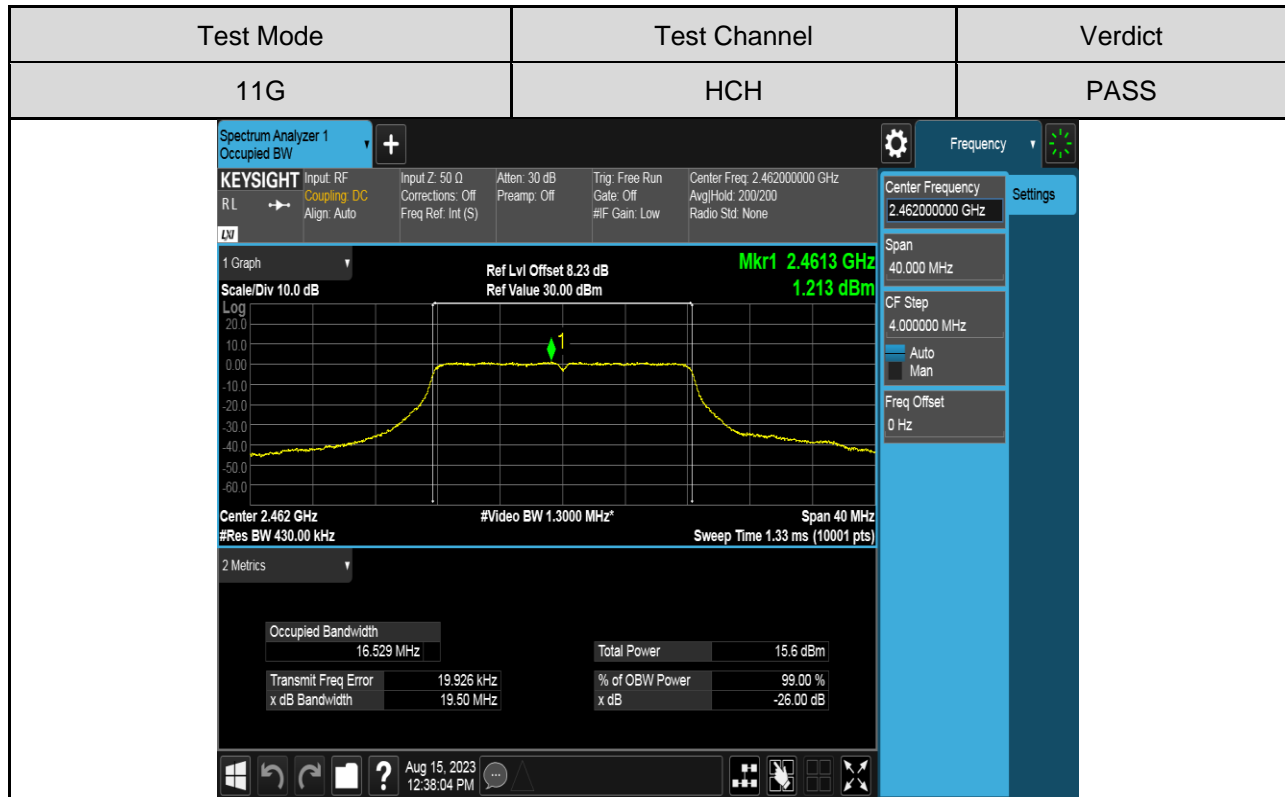
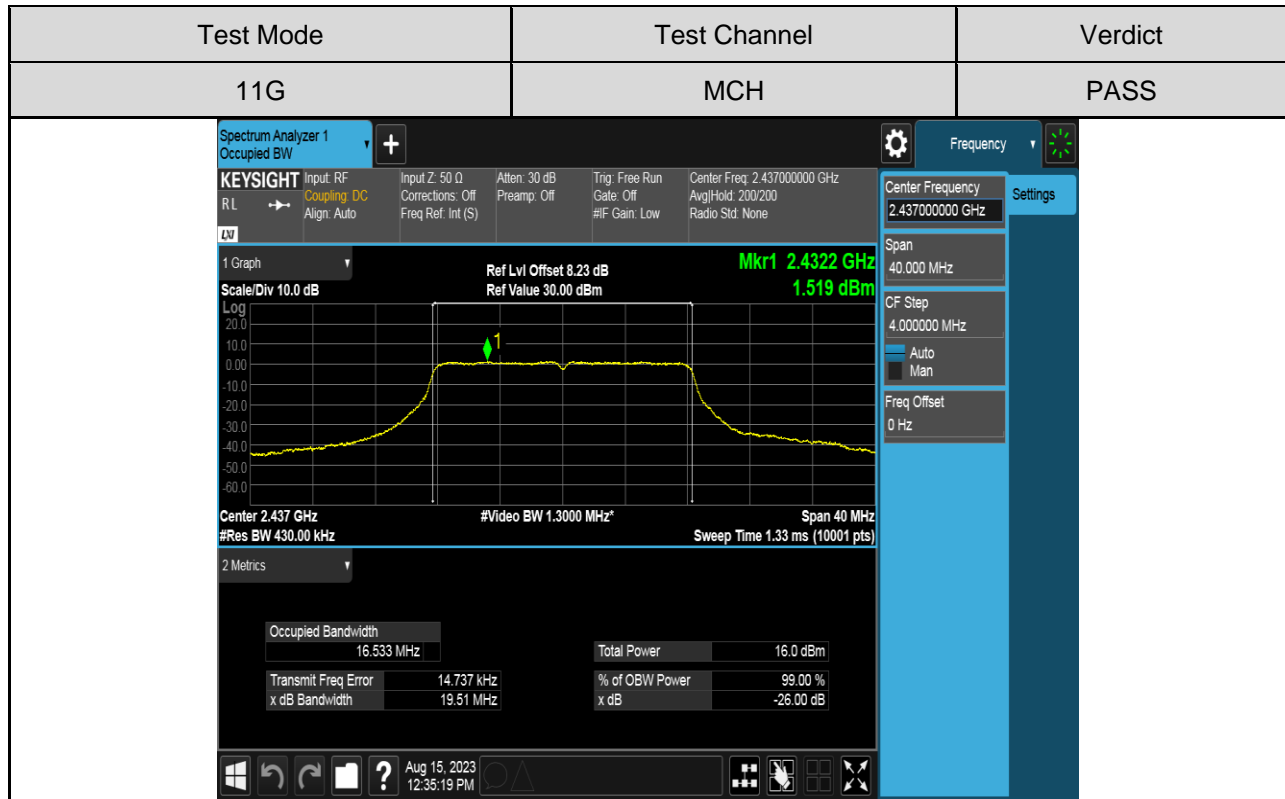

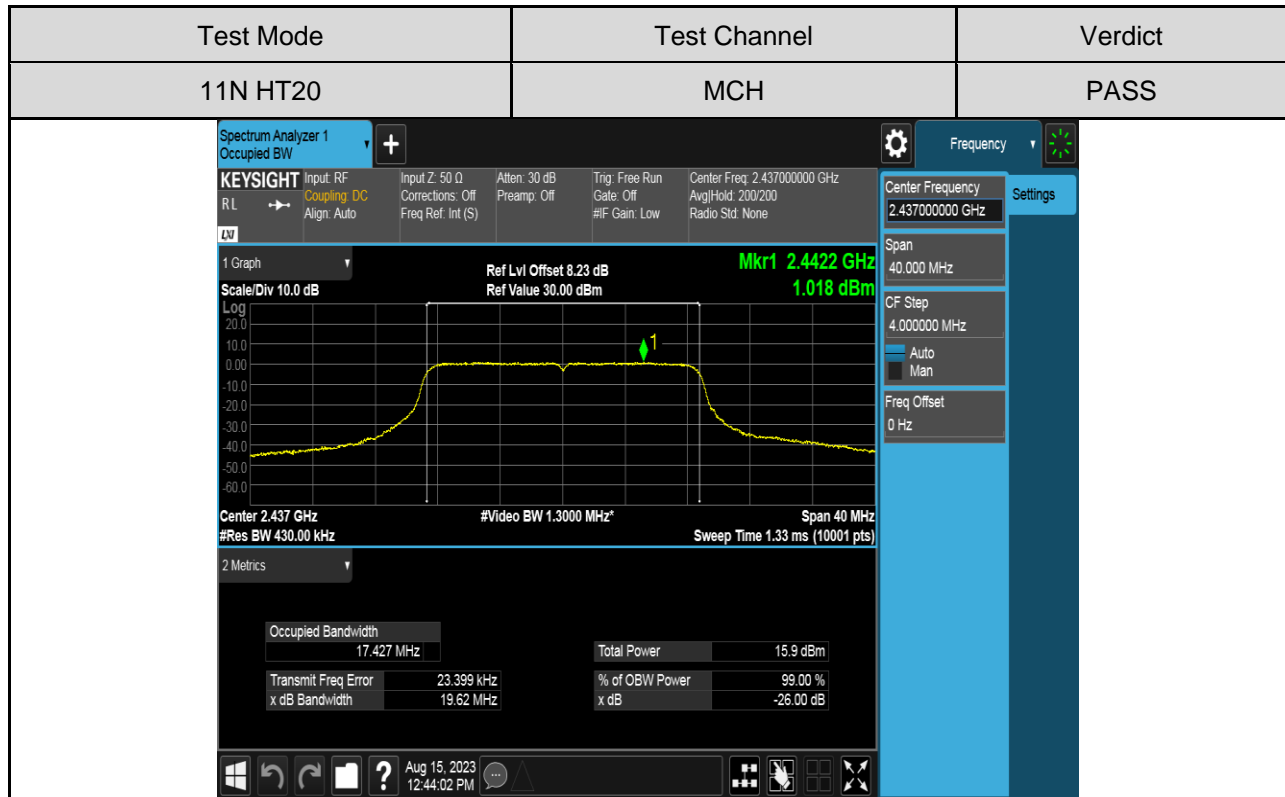
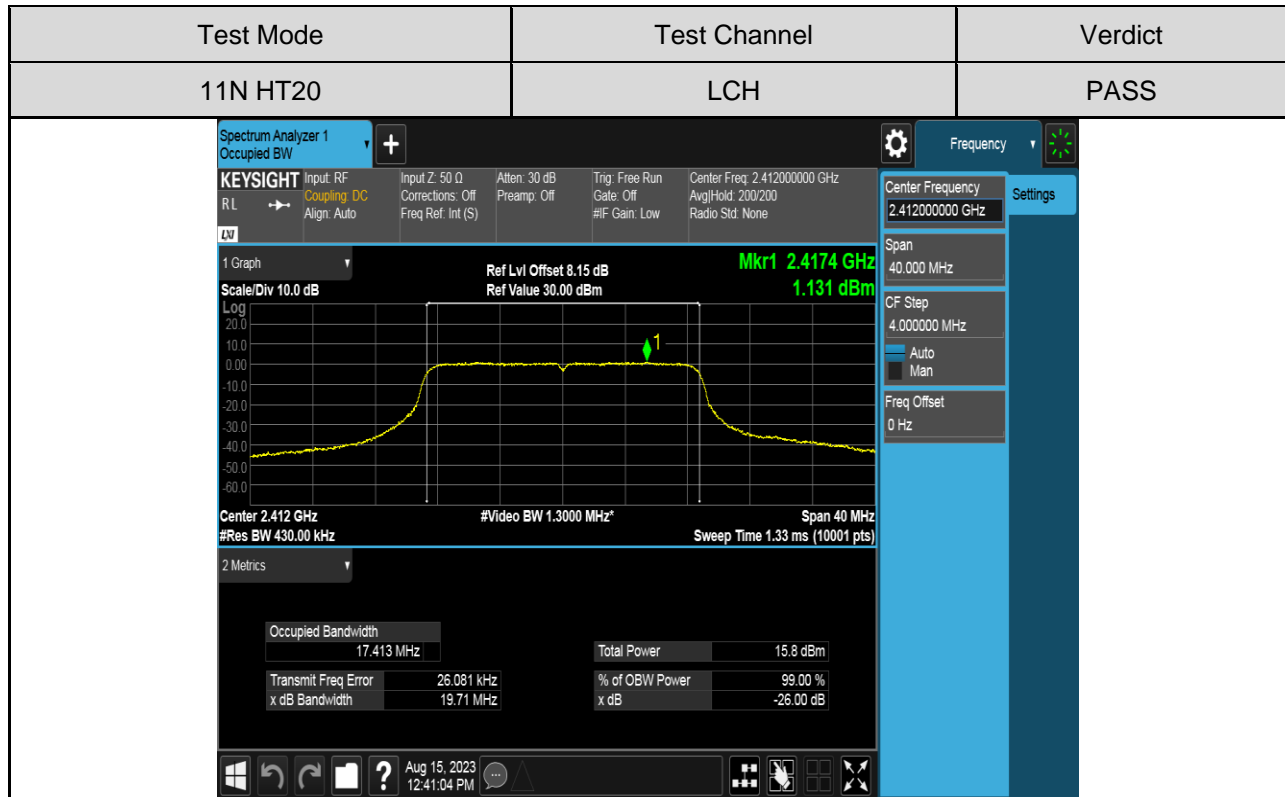

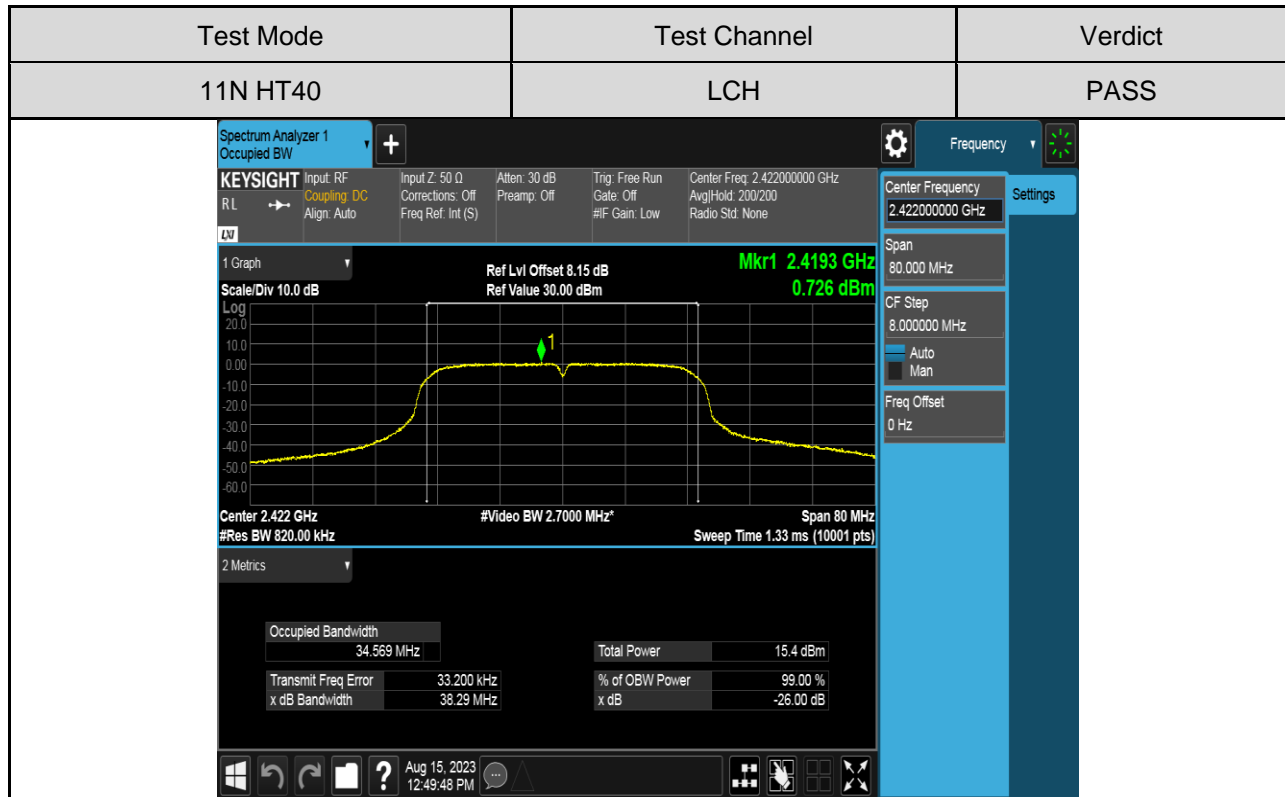
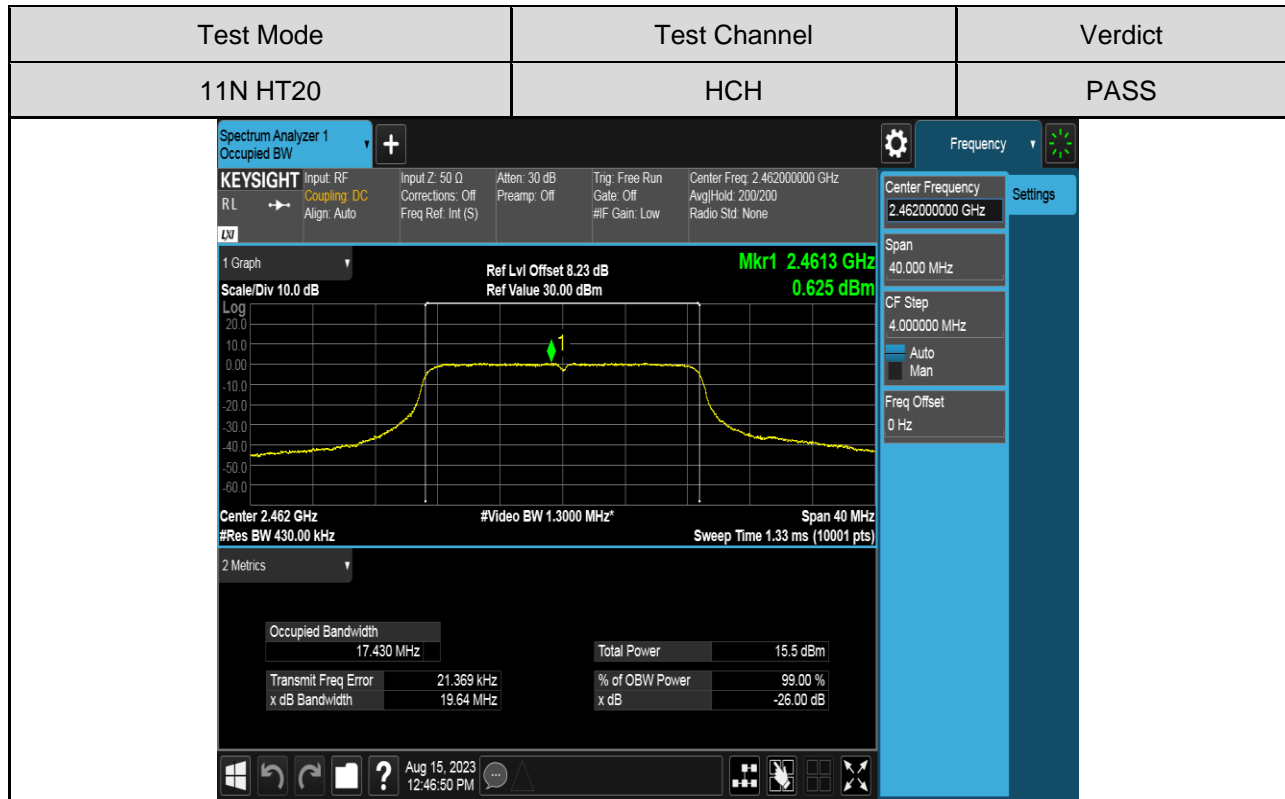

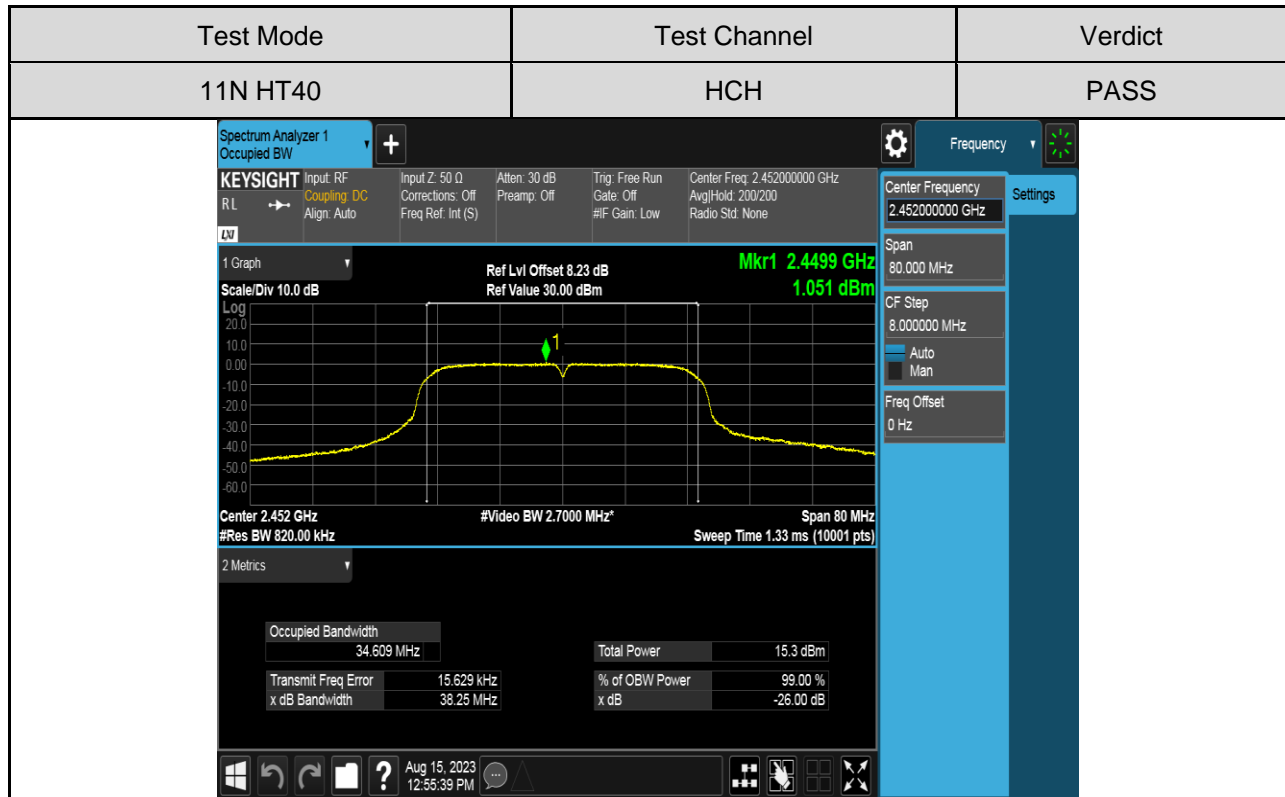
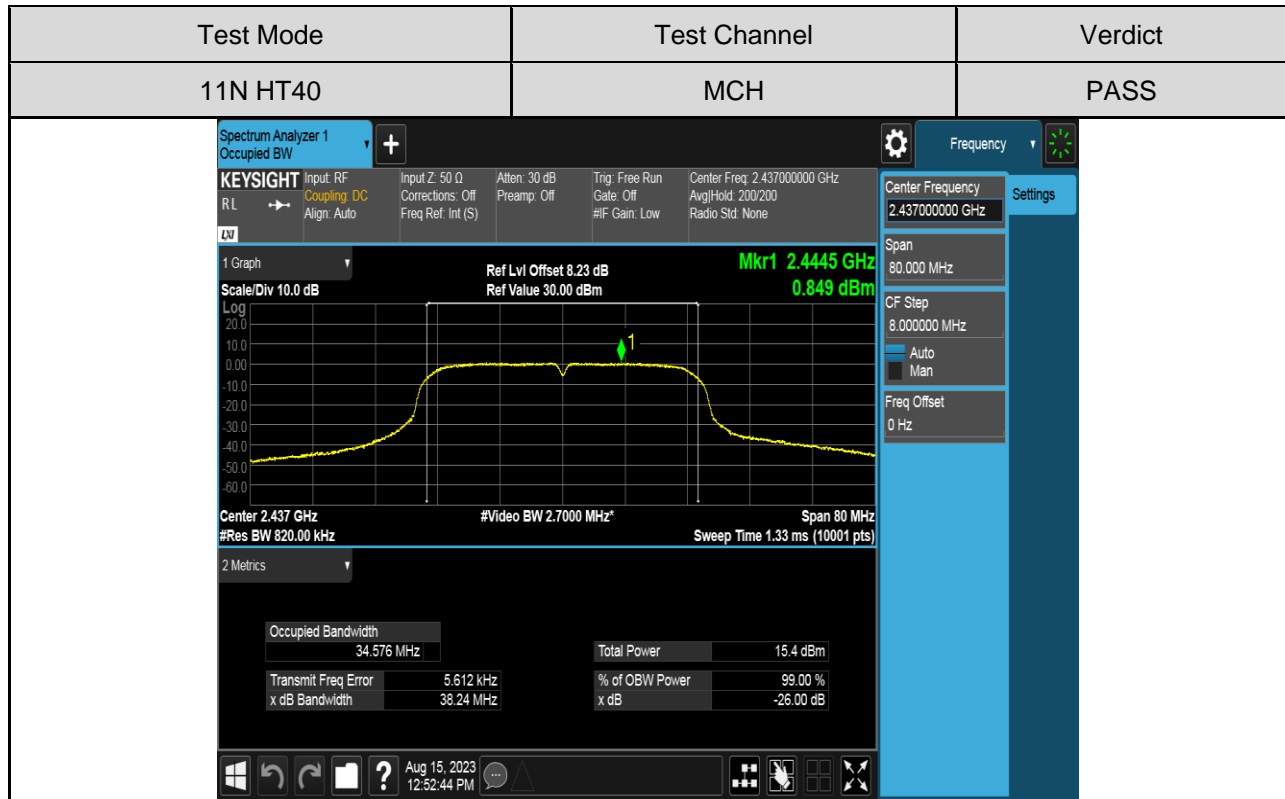

7.3. CONDUCTED OUTPUT POWER

LIMITS

FCC Part15 (15.247), Subpart C			
Section	Test Item	Limit	Frequency Range (MHz)
FCC 15.247(b)(3) ISED RSS-247 5.4 (d) RSS-Gen Clause 6.12	Output Power	1 watt or 30dBm	2400-2483.5

TEST PROCEDURE

Place the EUT on the table and set it in the transmitting mode.
Remove the antenna from the EUT and then connect a low loss RF cable from the antenna port to the Power sensor.
Measure the power of each channel.
AVG Detector used for AVG result.

TEST SETUP

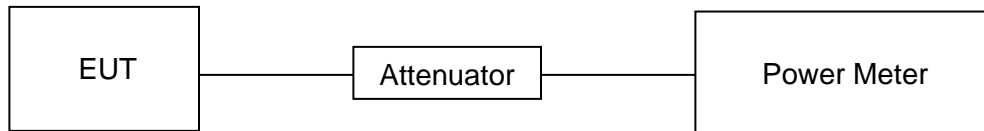

TEST ENVIRONMENT

Temperature	22°C	Relative Humidity	56%
Atmosphere Pressure	101kPa	Test Voltage	AC 120V

TEST RESULTS TABLE

Test Mode	Test Channel	Measurement Output Power (AV)	10log(1/x) Factor	Maximum Conducted Output Power (AV)	LIMIT
		dBm	dBm	dBm	dBm
11B	LCH	17.82	0	17.82	30
	MCH	17.43	0	17.43	30
	HCH	17.05	0	17.05	30
11G	LCH	15.93	0	15.93	30
	MCH	16.04	0	16.04	30
	HCH	15.65	0	15.65	30
11N HT20	LCH	15.80	0	15.80	30
	MCH	15.87	0	15.87	30
	HCH	15.48	0	15.48	30
11N HT40	LCH	15.38	0	15.38	30
	MCH	15.44	0	15.44	30
	HCH	15.29	0	15.29	30

7.4. POWER SPECTRAL DENSITY

LIMITS

FCC Part15 (15.247), Subpart C			
Section	Test Item	Limit	Frequency Range (MHz)
FCC §15.247 (e) ISED RSS-247 5.2 (b)	Power Spectral Density	8 dBm/3 kHz	2400-2483.5

TEST PROCEDURE

Refer to FCC KDB 558074, connect the UUT to the spectrum analyser and use the following settings:

Center Frequency	The centre frequency of the channel under test
Detector	Peak
RBW	$3 \text{ kHz} \leq \text{RBW} \leq 100 \text{ kHz}$
VBW	$\geq 3 \times \text{RBW}$
Span	1.5 x DTS bandwidth
Trace	Max hold
Sweep time	Auto couple.

Allow trace to fully stabilize and use the peak marker function to determine the maximum amplitude level within the RBW.

If measured value exceeds limit, reduce RBW (no less than 3 kHz) and repeat.

TEST SETUP

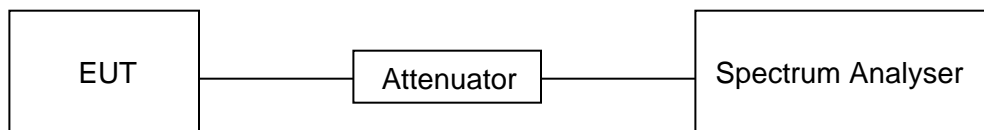

TEST ENVIRONMENT

Temperature	22°C	Relative Humidity	56%
Atmosphere Pressure	101kPa	Test Voltage	AC 120V

TEST RESULTS TABLE

Test Mode	Test Channel	Maximum Peak power spectral density (dBm/30kHz)	Result
11B	LCH	3.53	Pass
	MCH	3.31	Pass
	HCH	2.91	Pass
11G	LCH	-0.55	Pass
	MCH	-0.50	Pass
	HCH	-0.84	Pass
11N HT20	LCH	-0.89	Pass
	MCH	-0.87	Pass
	HCH	-1.16	Pass
11N HT40	LCH	-3.87	Pass
	MCH	-3.87	Pass
	HCH	-4.01	Pass

TEST GRAPHS

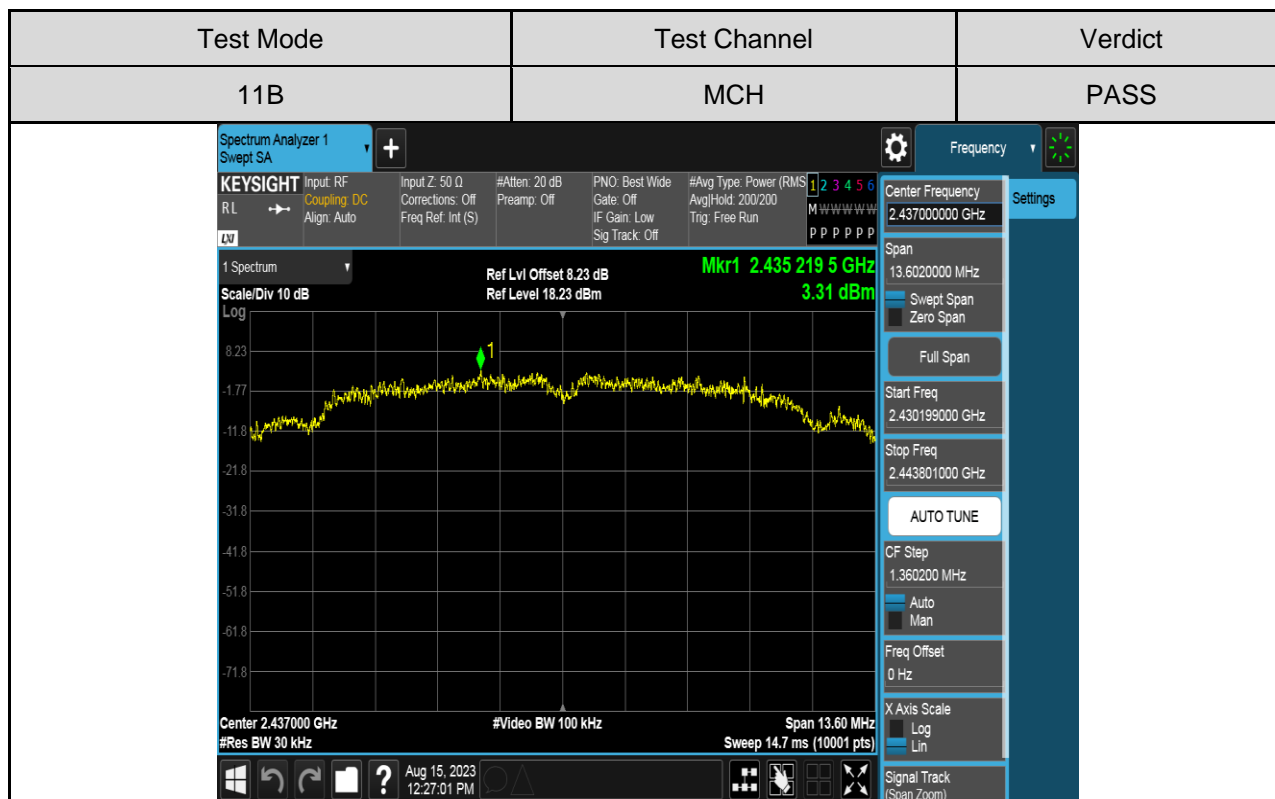
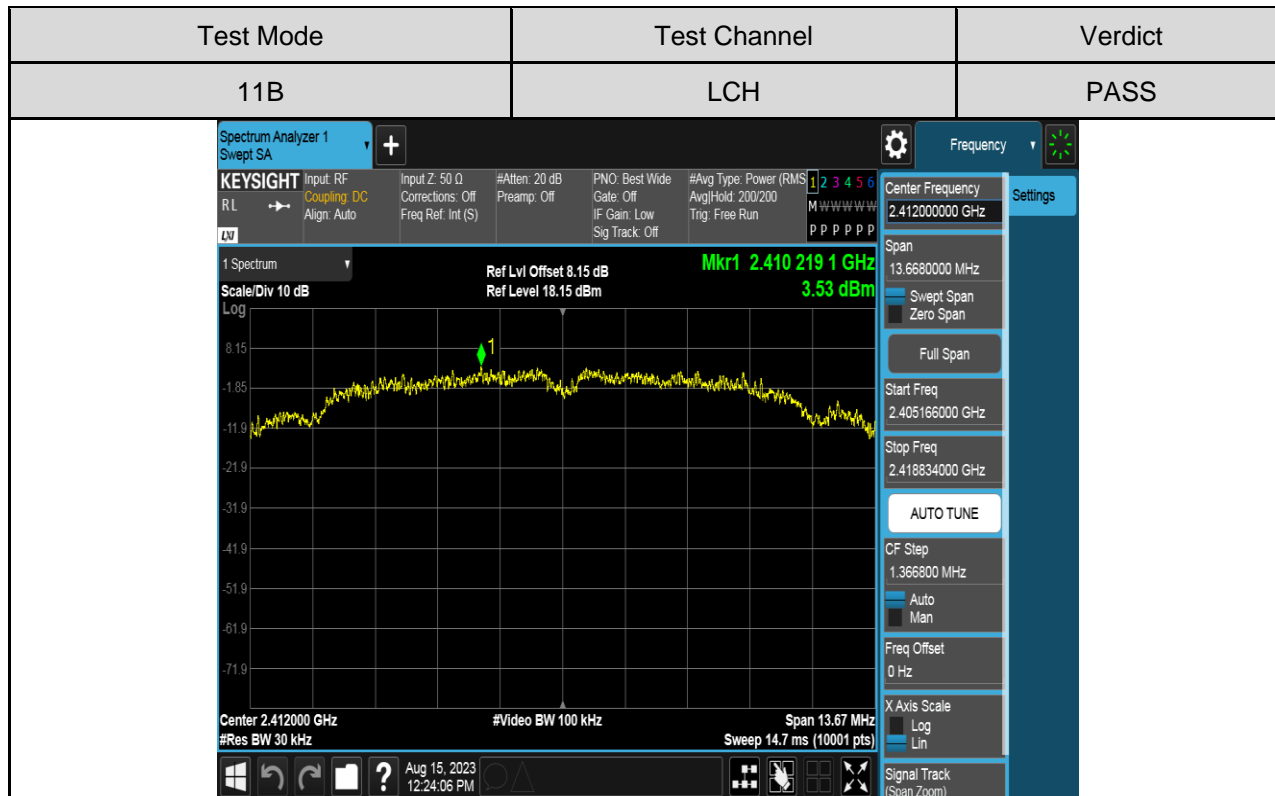

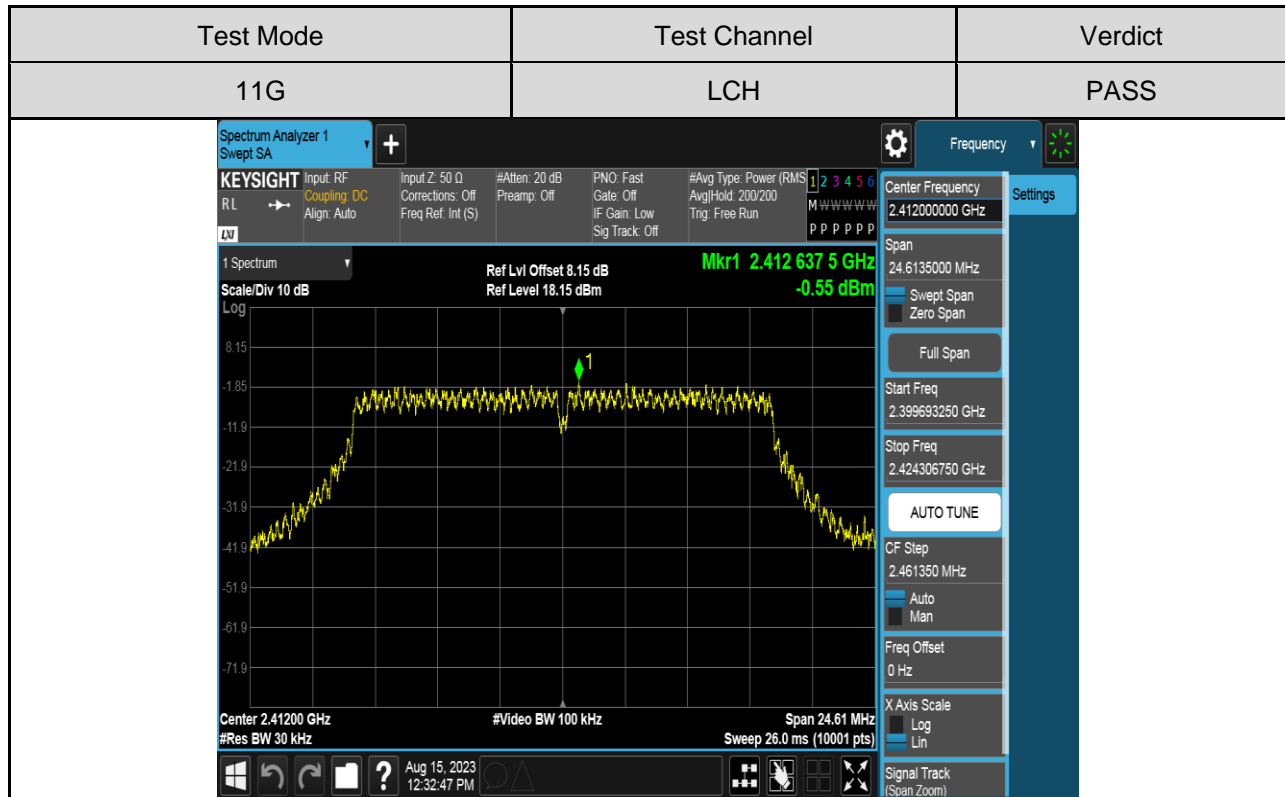
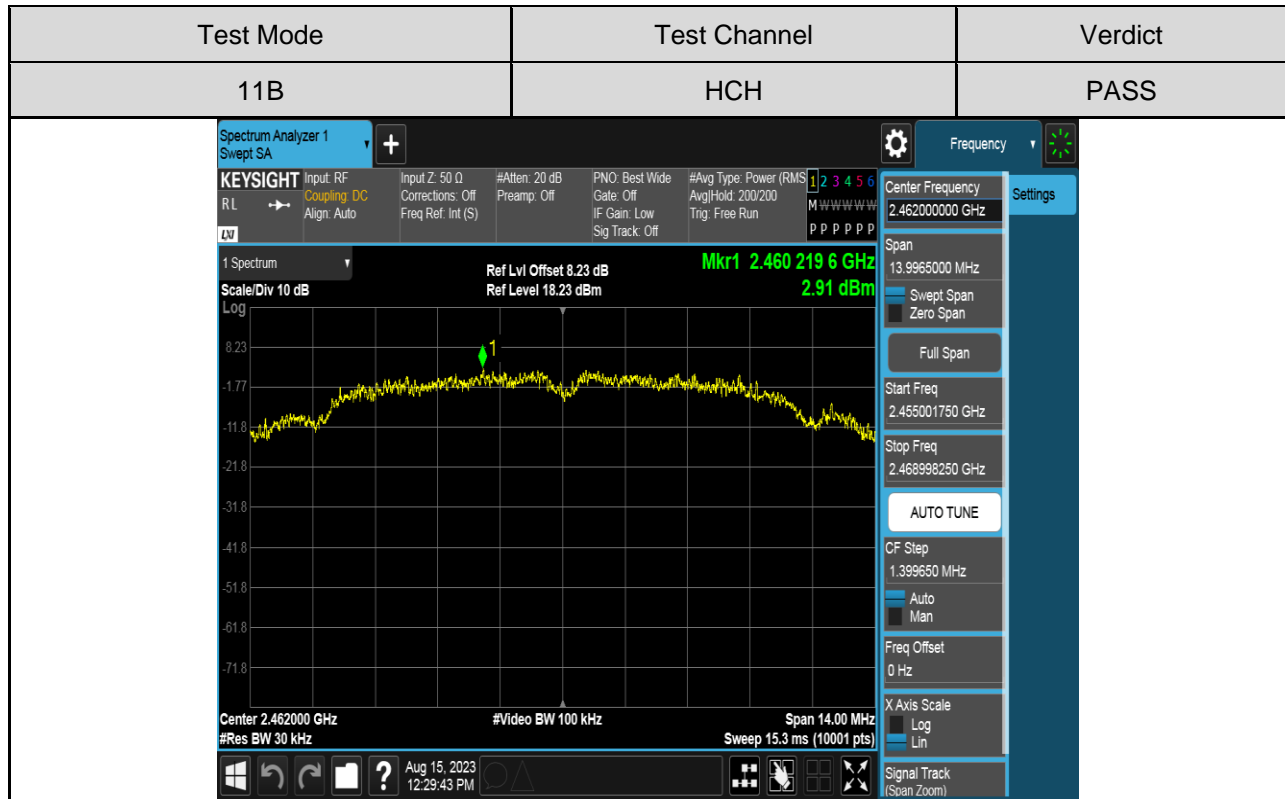

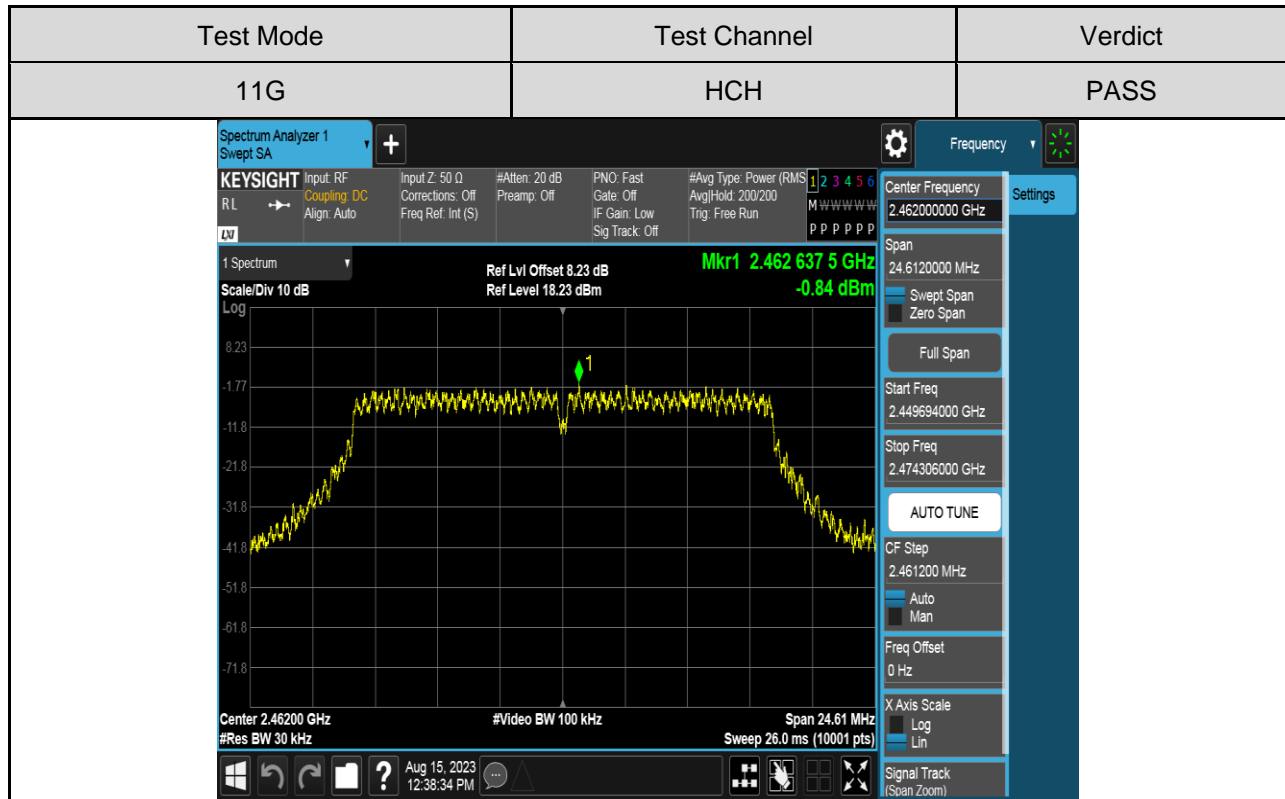
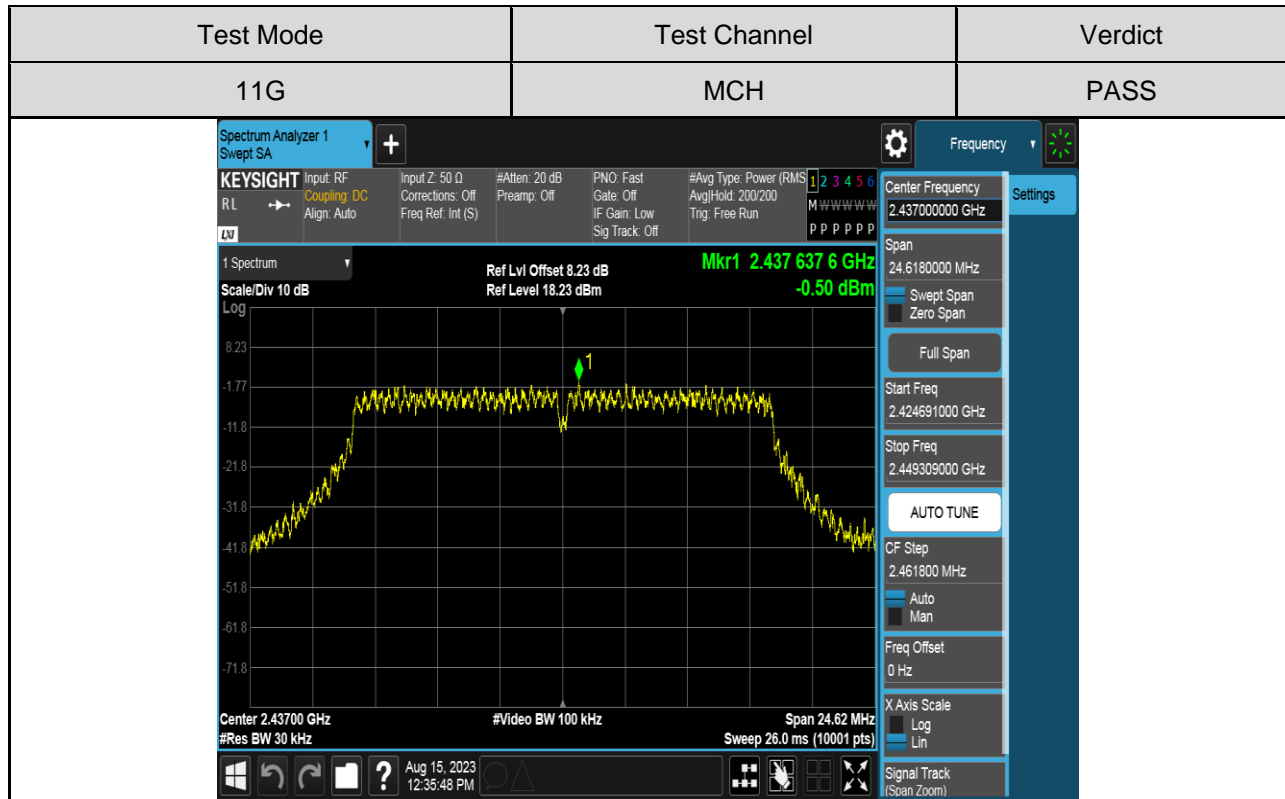

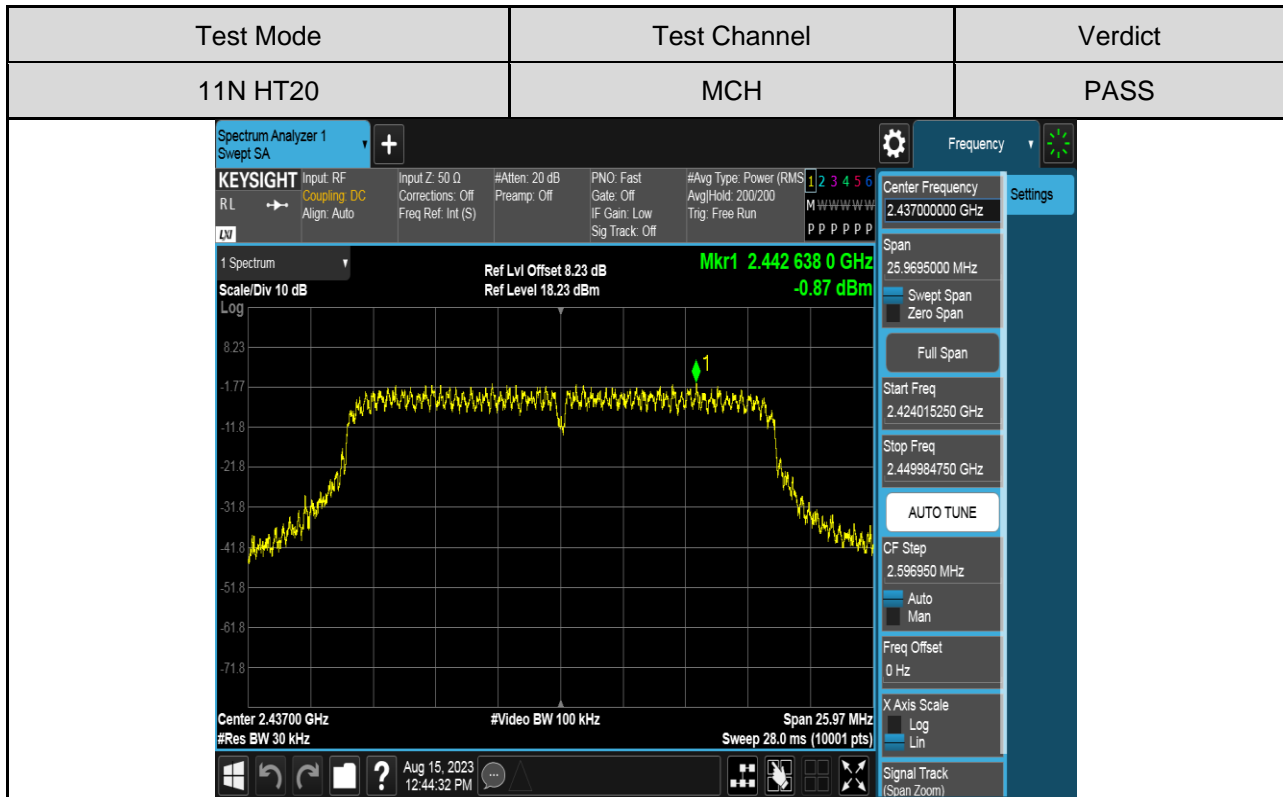
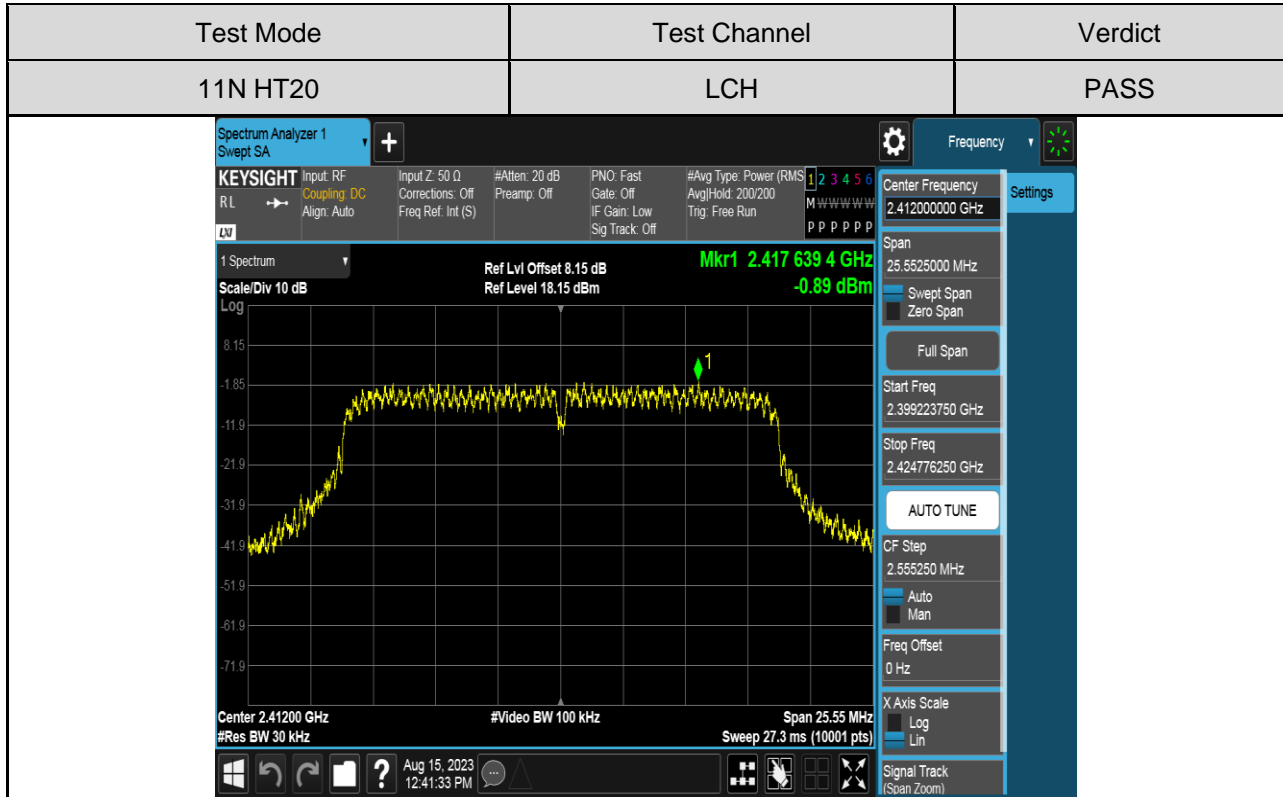

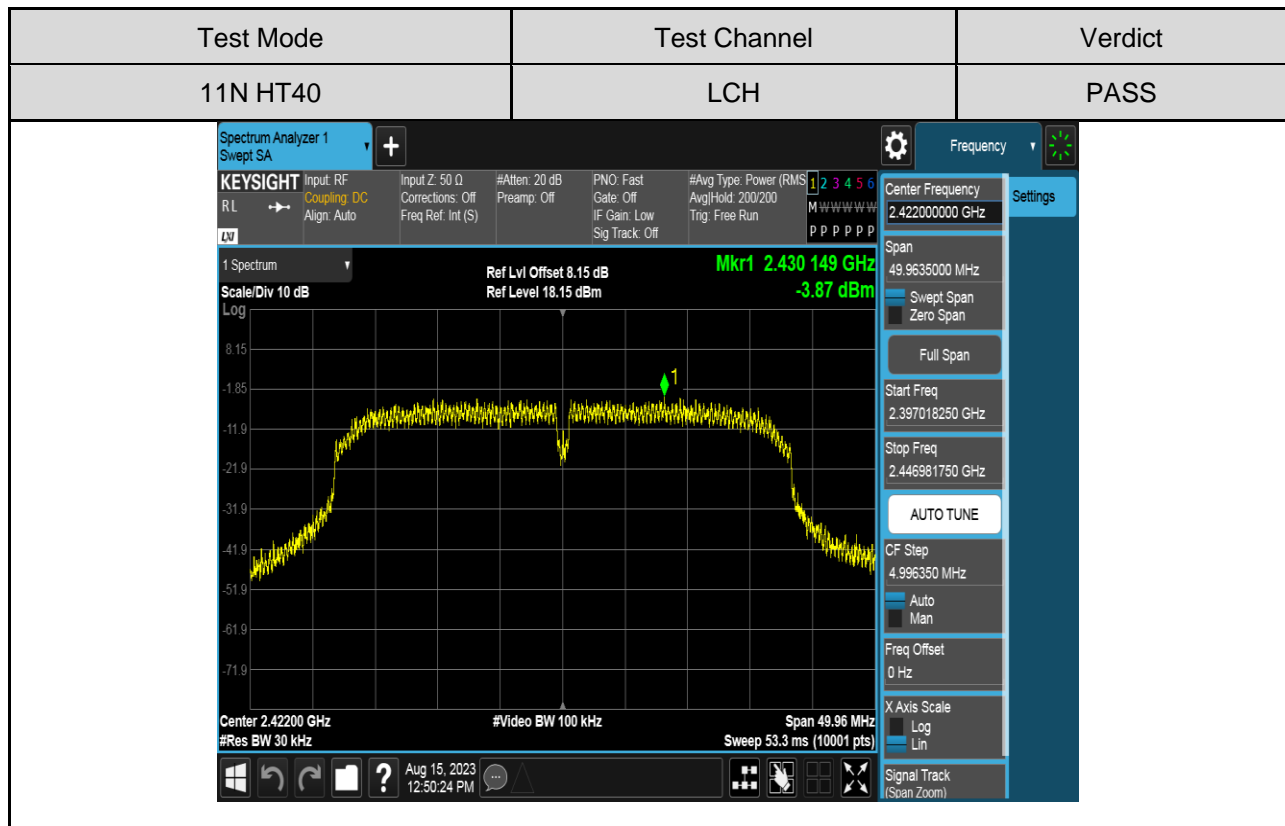
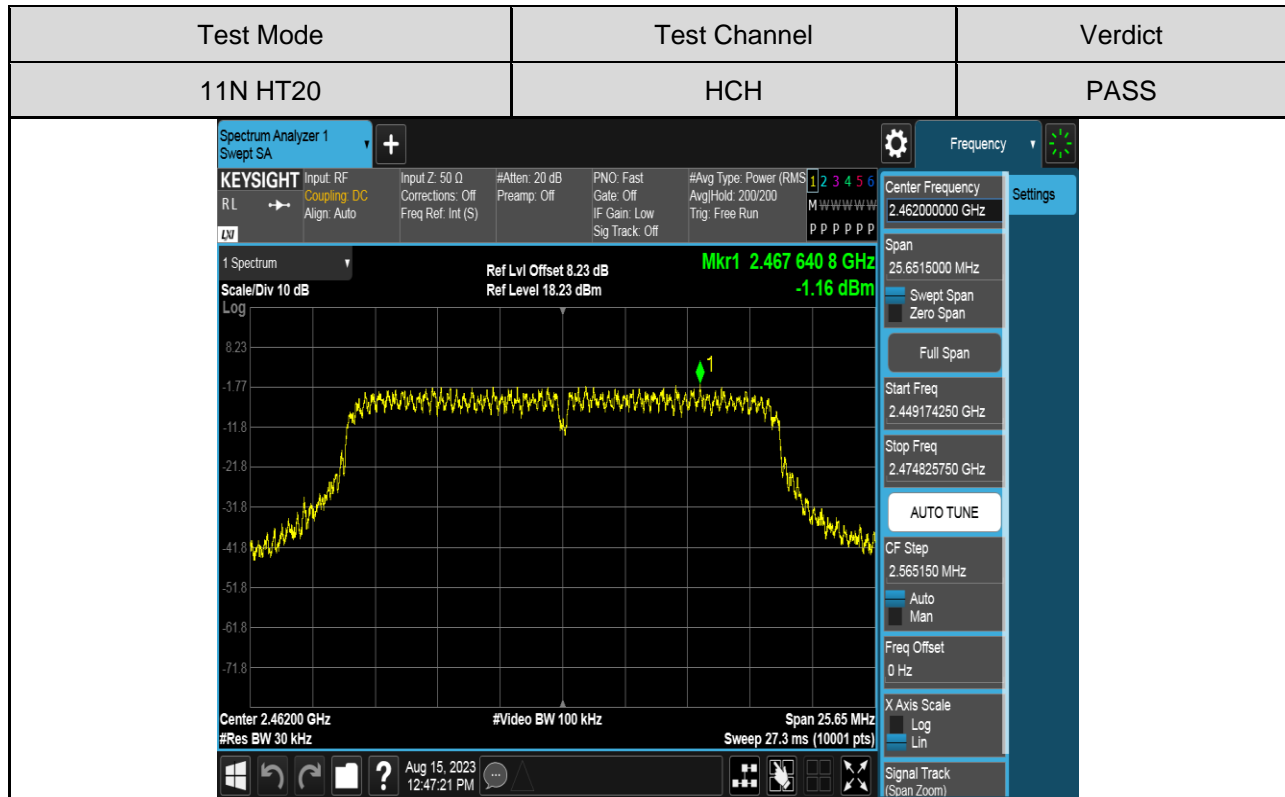

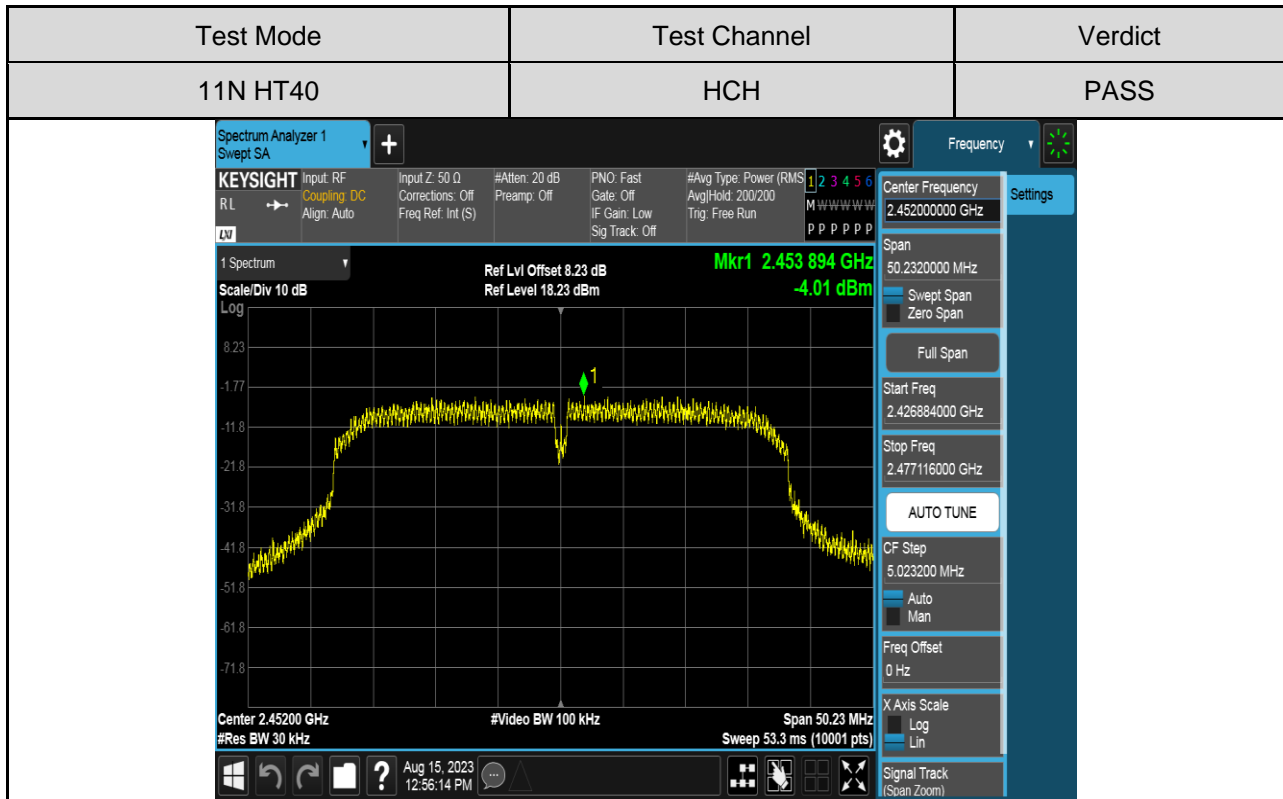
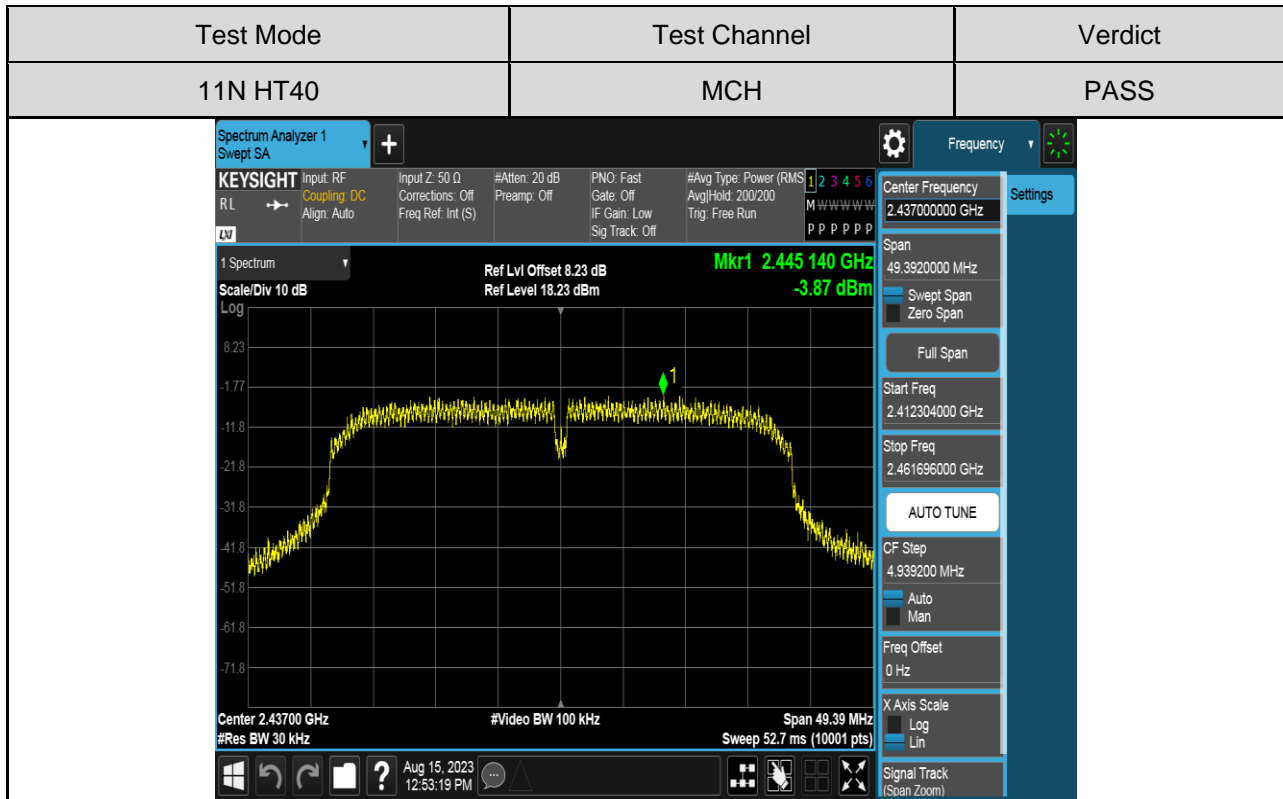

7.5. CONDUCTED BANDEGE AND SPURIOUS EMISSIONS

LIMITS

FCC Part15 (15.247), Subpart C		
Section	Test Item	Limit
FCC §15.247 (d) RSS-247 Clause 5.5 RSS-GEN Clause 6.13	Conducted Bandedge and Spurious Emissions	30 dB below that in the 100 kHz bandwidth within the band that contains the highest level of the desired power

TEST PROCEDURE

Refer to FCC KDB 558074, connect the UUT to the spectrum analyser and use the following settings:

Center Frequency	The centre frequency of the channel under test
Detector	Peak
RBW	100K
VBW	$\geq 3 \times \text{RBW}$
Span	1.5 x DTS bandwidth
Trace	Max hold
Sweep time	Auto couple.

Use the peak marker function to determine the maximum PSD level.

Span	Set the center frequency and span to encompass frequency range to be measured
Detector	Peak
RBW	100K
VBW	$\geq 3 \times \text{RBW}$
measurement points	$\geq \text{span}/\text{RBW}$
Trace	Max hold
Sweep time	Auto couple.

Use the peak marker function to determine the maximum amplitude level.

TEST SETUP

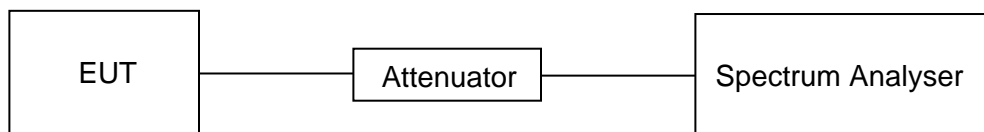

TEST ENVIRONMENT

Temperature	22°C	Relative Humidity	56%
Atmosphere Pressure	101kPa	Test Voltage	AC 120V

PART 1: REFERENCE LEVEL MEASUREMENT**TEST RESULTS TABLE**

Test Mode	Test Channel	Result[dBm]
11B	LCH	9.13
	MCH	8.87
	HCH	8.59
11G	LCH	2.81
	MCH	2.98
	HCH	2.65
11N HT20	LCH	2.81
	MCH	2.67
	HCH	2.07
11N HT40	LCH	-0.77
	MCH	-0.37
	HCH	-0.79

TEST GRAPHS

