



**CFR 47 FCC PART 15 SUBPART C
ISED RSS-247 Issue 2**

CERTIFICATION TEST REPORT

For

Carpet One Spot

MODEL NUMBER: SC100100US

PROJECT NUMBER: 4790446015

REPORT NUMBER: 4790446015-3

FCC ID: 2AV7A-SC10

IC: 26039-SC10

ISSUE DATE: Jul. 23, 2022

Prepared for

Tineco Intelligent Technology Co., Ltd.

Prepared by

UL-CCIC COMPANY LIMITED

No. 2, Chengwan Road, Suzhou Industrial Park, People's Republic of China

Tel: + 86-512-6808 6400

Fax: + 86-512-6808 4099

Website: www.ul.com

Form-ULID-008536-9 V1.0

The results reported herein have been performed in accordance with the laboratory's terms of accreditation. This report shall not be reproduced except in full without the written approval of the Laboratory. The results in this report apply to the test sample(s) mentioned above at the time of the testing period only and are not to be used to indicate applicability to other similar products. This report does not imply that the product(s) has met the criteria for certification.



Revision History

<u>Rev.</u>	<u>Issue Date</u>	<u>Revisions</u>	<u>Revised By</u>
V0	07/23/2022	Initial Issue	



TABLE OF CONTENTS

1. ATTESTATION OF TEST RESULTS	4
2. TEST METHODOLOGY	6
3. FACILITIES AND ACCREDITATION	6
4. CALIBRATION AND UNCERTAINTY	7
4.1. <i>MEASURING INSTRUMENT CALIBRATION</i>	<i>7</i>
4.2. <i>MEASUREMENT UNCERTAINTY.....</i>	<i>7</i>
5. EQUIPMENT UNDER TEST	8
5.1. <i>DESCRIPTION OF EUT</i>	<i>8</i>
5.2. <i>MAXIMUM OUTPUT POWER</i>	<i>9</i>
5.3. <i>CHANNEL LIST.....</i>	<i>9</i>
5.4. <i>TEST CHANNEL CONFIGURATION.....</i>	<i>10</i>
5.5. <i>THE WORSE CASE POWER SETTING PARAMETER.....</i>	<i>10</i>
5.6. <i>DESCRIPTION OF AVAILABLE ANTENNAS.....</i>	<i>11</i>
5.7. <i>THE WORSE CASE CONFIGURATIONS.....</i>	<i>11</i>
5.8. <i>DESCRIPTION OF TEST SETUP</i>	<i>12</i>
5.9. <i>MEASURING INSTRUMENT AND SOFTWARE USED</i>	<i>13</i>
6. MEASUREMENT METHODS	14
7. ANTENNA PORT TEST RESULTS	15
7.1. <i>TEST ENVIRONMENT</i>	<i>15</i>
7.2. <i>ON TIME AND DUTY CYCLE.....</i>	<i>16</i>
7.3. <i>6 dB BANDWIDTH AND 99% BANDWIDTH.....</i>	<i>19</i>
7.4. <i>CONDUCTED POWER</i>	<i>30</i>
7.5. <i>POWER SPECTRAL DENSITY.....</i>	<i>32</i>
7.6. <i>CONDUCTED BANDEDGE AND SPURIOUS EMISSIONS</i>	<i>39</i>
7.7. <i>RADIATED TEST RESULTS.....</i>	<i>63</i>
7.7.1. <i>LIMITS AND PROCEDURE</i>	<i>63</i>
7.7.2. <i>RESTRICTED BANDEDGE</i>	<i>69</i>
7.7.3. <i>SPURIOUS EMISSIONS</i>	<i>82</i>
8. AC POWER LINE CONDUCTED EMISSIONS	127
9. ANTENNA REQUIREMENTS.....	131



1. ATTESTATION OF TEST RESULTS

Company Name:	Tineco Intelligent Technology Co., Ltd.
Address:	No.108Shihu Road West,Wuzhong Zone,Suzhou,215168 P.R.China
Factory Information	
Company Name:	Tineco Intelligent Technology Co., Ltd.
Address:	No.108Shihu Road West,Wuzhong Zone,Suzhou,215168 P.R.China
EUT Description	
Product Name:	Carpet One Spot
Model Number:	SC100100US
Sample Number:	5055687
Data of Receipt Sample:	Jun.15, 2022
Date Tested:	Jun.15, 2022 – Jul. 22, 2022

APPLICABLE STANDARDS	
STANDARD	TEST RESULTS
CFR 47 Part 15 Subpart C	PASS
ISED RSS-247 Issue 2	PASS
ISED RSS-GEN Issue 5	PASS



Summary of Test Results			
Clause	Test Items	FCC/IC Rules	Test Results
1	6db DTS Bandwidth and 99% Bandwidth	FCC 15.247 (a) (2) RSS-247 Clause 5.2 (a) RSS-Gen Clause 6.7	Complied
2	Conducted Power	FCC 15.247 (b) (3) RSS-247 Clause 5.4 (d) RSS-Gen Clause 6.12	Complied
3	Power Spectral Density	FCC 15.247 (e) RSS-247 Clause 5.2 (b)	Complied
4	Conducted Band edge And Spurious emission	FCC 15.247 (d) RSS-247 Clause 5.5 RSS-GEN Clause 6.13	Complied
5	Radiated Band edges and Spurious emission	FCC 15.247 (d) FCC 15.209 FCC 15.205 RSS-247 Clause 5.5 RSS-GEN Clause 8.9 RSS-GEN Clause 6.13	Complied
6	Conducted Emission Test For AC Power Port	FCC 15.207 RSS-GEN Clause 8.8	Complied
7	Antenna Requirement	FCC 15.203 RSS-GEN Clause 6.8	Complied
Remark: 1) The measurement result for the sample received is <Pass> according to < ANSI C63.10-2013, FCC CFR 47 Part 2, FCC CFR 47 Part 15C, ISED RSS-GEN, ISED RSS-247> when <Accuracy Method> decision rule is applied.			

Prepared By:

Tom Tang

Tom Tang

Reviewed By:

Leon Wu

Leon Wu

Authorized By:

Chris Zhong

Chris Zhong
Laboratory Leader



2. TEST METHODOLOGY

The tests documented in this report were performed in accordance with FCC KDB 558074 D01 15.247 Meas Guidance v05r02, KDB 414788 D01 Radiated Test Site v01r01, ANSI C63.10-2013, FCC CFR 47 Part 2, FCC CFR 47 Part 15, ISED RSS-GEN ISSUE5, ISED RSS-247 ISSUE2.

3. FACILITIES AND ACCREDITATION

Test Location	UL-CCIC Company Limited, EMC&RF Lab
Address	No. 2, Chengwan Road, Suzhou Industrial Park, Suzhou 215122 ,China
Accreditation Certificate	A2LA (Certificate No.: 4829.01) UL-CCIC COMPANY LIMITED has been assessed and proved to be in compliance with A2LA. FCC (FCC Designation No.: CN1247) UL-CCIC COMPANY LIMITED has been recognized to perform compliance testing on equipment subject to the Commission's Declaration of Conformity (DoC) and Certification rules. IC (IC Designation No.: 25056; CAB No.:CN0073) UL-CCIC COMPANY LIMITED has been recognized to perform compliance testing on equipment subject to the Commission's Declaration of Conformity (DoC) and Certification rules.

Note 1: All tests measurement facilities use to collect the measurement data are located at No. 2, Chengwan Road, Suzhou Industrial Park, Suzhou 215122, People’s Republic of China

Note 2: For below 30MHz, lab had performed measurements at test anechoic chamber and comparing to measurements obtained on an open field site. These measurements below 30MHz had been correlated to measurements performed on an OFS.

Note 3: The test anechoic chamber in UL-CCIC COMPANY LIMITED had been calibrated and compared to the open field sites and the test anechoic chamber is shown to be equivalent to or worst case from the open field site.



4. CALIBRATION AND UNCERTAINTY

4.1. MEASURING INSTRUMENT CALIBRATION

The measuring equipment utilized to perform the tests documented in this report has been calibrated in accordance with the manufacturer's recommendations, and is traceable to recognized national standards.

4.2. MEASUREMENT UNCERTAINTY

Where relevant, the following measurement uncertainty levels have been estimated for tests performed on the apparatus:

Test Item	Uncertainty
Conduction emission	3.1dB
Radiation Emission test(include Fundamental emission) (9KHz-30MHz)	3.4dB
Radiation Emission test(include Fundamental emission) (30MHz-1GHz)	3.4dB
Radiation Emission test (1GHz to 26GHz)(include Fundamental emission)	3.7dB (1GHz-18Gz)
	4.0dB (18GHz-26.5Gz)
Note: This uncertainty represents an expanded uncertainty expressed at approximately the 95% confidence level using a coverage factor of k=2.	



5. EQUIPMENT UNDER TEST

5.1. DESCRIPTION OF EUT

Product Name:	Carpet One Spot
Model No.:	SC100100US
Operating Frequency:	IEEE 802.11b/g/n(HT20): 2412MHz to 2462MHz
Type of Modulation:	IEEE for 802.11b: DSSS (CCK, DQPSK, DBPSK) IEEE for 802.11g: OFDM (64QAM, 16QAM, QPSK, BPSK) IEEE for 802.11n (HT20): OFDM (64QAM, 16QAM, QPSK, BPSK)
Channels Step:	Channels with 5MHz step
Test software of EUT:	EspRFtestTool_2.0 (manufacturer declare)
Antenna Type:	PCB antenna
Antenna Gain:	Antenna1: 2.87 dBi Remark: This data is provided by customer and our lab isn't responsible for this data
Test Voltage	AC120V/ 60Hz



5.2. MAXIMUM OUTPUT POWER

Number of Transmit Chains (NTX)	IEE Std. 802.11	Channel Number	Max AV Conducted Power (dBm)
1	IEEE 802.11B SISO	1-11[11]	16.88
1	IEEE 802.11G SISO	1-11[11]	15.04
1	IEEE 802.11nHT20	1-11[11]	14.64

5.3. CHANNEL LIST

Channel List for 802.11b/g/n (20 MHz)							
Channel	Frequency (MHz)	Channel	Frequency (MHz)	Channel	Frequency (MHz)	Channel	Frequency (MHz)
1	2412	4	2427	7	2442	10	2457
2	2417	5	2432	8	2447	11	2462
3	2422	6	2437	9	2452		



5.4. TEST CHANNEL CONFIGURATION

Test Mode	Test Channel	Frequency
WiFi TX(802.11b)	CH 1, CH 6, CH 11	2412MHz, 2437MHz, 2462MHz
WiFi TX(802.11g)	CH 1, CH 6, CH 11	2412MHz, 2437MHz, 2462MHz
WiFi TX(802.11n HT20)	CH 1, CH 6, CH 11	2412MHz, 2437MHz, 2462MHz

5.5. THE WORSE CASE POWER SETTING PARAMETER

The Worse Case Power Setting Parameter under 2400 ~ 2483.5MHz Band							
Test Software		EspRFtestTool					
Modulation Mode	Transmit Antenna Number	Test Channel					
		NCB: 20MHz			NCB: 40MHz		
		CH 1	CH 6	CH 11	CH 3	CH 6	CH 9
802.11b	1	N/A	N/A	N/A	/		
802.11g	1	N/A	N/A	N/A			
802.11n HT20	1	N/A	N/A	N/A			

Remark: The value list above are the setting of att in the software.



5.6. DESCRIPTION OF AVAILABLE ANTENNAS

Ant.	Frequency (MHz)	Antenna Type	Antenna Gain (dBi)
1	2400-2483.5	PCB antenna	2.87

Test Mode	Transmit and Receive Mode	Description
IEEE 802.11b	<input checked="" type="checkbox"/> 1TX, 1RX	Antenna1 can be used as transmitting/receiving antenna independently.
IEEE 802.11g	<input checked="" type="checkbox"/> 1TX, 1RX	Antenna1 can be used as transmitting/receiving antenna independently.
IEEE 802.11N (HT20)	<input checked="" type="checkbox"/> 1TX, 1RX	Antenna1 can be used as transmitting/receiving antenna independently.

5.7. THE WORSE CASE CONFIGURATIONS

- 1) For the product, there only one transmission antennas.
- 2) This EUT can working with and without charger modes, pre-testing both test modes, but only the data of worse case is record in this report.
- 3) Worst-case data rates as provided by the client were:
 - 802.11b mode: 1 Mbps
 - 802.11b mode: 6 Mbps
 - 802.11n HT20 mode: MCS0

5.8. DESCRIPTION OF TEST SETUP

SUPPORT EQUIPMENT

Item	Equipment	Brand Name	Model Name	Description
1	Laptop	ThinkPad	E590	N/A
2	Fixed Frequency Board	N/A	N/A	Supply by Customer
3	USB Cable	N/A	N/A	Supply by UL Lab(100cm length)

I/O PORT

Cable No	Port	Connector Type	Cable Type	Cable Length(m)	Remarks
1	N/A	N/A	N/A	N/A	N/A

ACCESSORY

Item	Accessory	Brand Name	Model Name	Description
1	Power Supply	Tineco	KL-WA260060-J	INPUT: 100-240V~ 50/60Hz, 0.5A OUTPUT: 26.0V = 0.6A

TEST SETUP

The EUT can work in an engineer mode with a software through a table PC.

SETUP DIAGRAM FOR TESTS

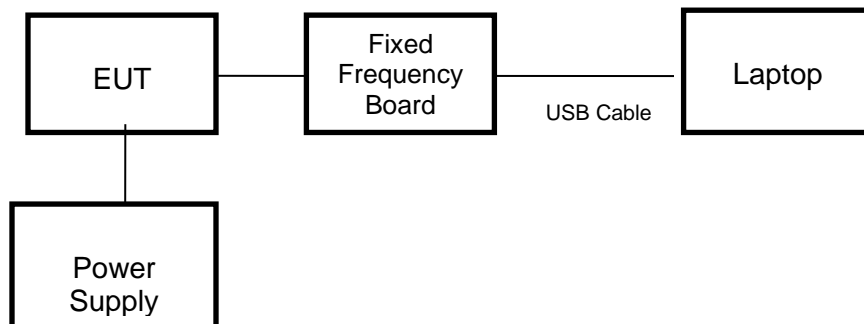



5.9. MEASURING INSTRUMENT AND SOFTWARE USED

Conducted Emissions (Instrument)							
Used	Equipment	Manufacturer	Model No.	Serial No.	Upper Last Cal.	Last Cal.	Next Cal.
<input checked="" type="checkbox"/>	EMI Test Receiver	R&S	ESR3	126700	2020-12-05	2021-12-04	2022-12-03
<input checked="" type="checkbox"/>	Two-Line V- Network	R&S	ENV216	126701	2020-12-05	2021-12-04	2022-12-03
Software							
Used	Description		Manufacturer	Name	Version		
<input checked="" type="checkbox"/>	Test Software for Conducted disturbance		R&S	EMC32	Ver. 9.25		
Radiated Emissions (Instrument)							
Used	Equipment	Manufacturer	Model No.	Serial No.	Upper Last Cal.	Last Cal.	Next Cal.
<input checked="" type="checkbox"/>	Spectrum Analyzer	Keysight	N9010B	155727	2021-05-09	2022-04-09	2023-04-08
<input checked="" type="checkbox"/>	EMI test receiver	R&S	ESR26	126703	2020-12-05	2021-12-04	2022-12-03
<input checked="" type="checkbox"/>	Receiver Antenna (9kHz-30MHz)	Schwarzbeck	FMZB 1513	155456	2018-06-15	2021-06-03	2024-06-02
<input checked="" type="checkbox"/>	Receiver Antenna (30MHz-1GHz)	SunAR RF Motion	JB1	177821	2019-01-28	2022-01-18	2025-01-17
<input checked="" type="checkbox"/>	Receiver Antenna (1GHz-18GHz)	R&S	HF907	126705	2018-01-29	2022-02-28	2025-02-27
<input checked="" type="checkbox"/>	Receiver Antenna (18GHz-26.5GHz)	ETS	3160-10	155565	2019-01-05	2021-07-15	2024-07-14
<input checked="" type="checkbox"/>	Pre-amplification (To 18GHz)	Compliance Direction System Inc.	PAP-1G18-50	177825	2021-03-18	2022-03-01	2023-02-28
<input checked="" type="checkbox"/>	Pre-amplification (To 26.5GHz)	R&S	SCU-26D	135391	2021-12-05	2022-12-04	2022-12-03
<input checked="" type="checkbox"/>	Band Reject Filter	Wainwright	WRCJV8-2350-2400-2483.5-2533.5-40SS	1	2021-05-09	2022-04-09	2023-04-08
<input checked="" type="checkbox"/>	Highpass Filter	Wainwright	WHKX10-2700-3000-18000-40SS	2	2021-05-09	2022-04-09	2023-04-08
Software							
Used	Description		Manufacturer	Name	Version		
<input checked="" type="checkbox"/>	Test Software for Radiated disturbance		Tonscend	JS36-RSE	4.0.0.1		
Other instruments							
Used	Equipment	Manufacturer	Model No.	Serial No.	Upper Last Cal.	Last Cal.	Next Cal.
<input checked="" type="checkbox"/>	Spectrum Analyzer	Keysight	N9010B	155368	2021-05-09	2022-04-09	2023-04-08
<input checked="" type="checkbox"/>	Power Meter	Keysight	U2021XA	155370	2021-05-09	2022-04-09	2023-04-08



6. MEASUREMENT METHODS

No.	Test Item	KDB Name	Section
1	6dB Bandwidth and 99% Bandwidth	KDB 558074 D01 15.247 Meas Guidance v05r02	8.2
2	Conducted Output Power	KDB 558074 D01 15.247 Meas Guidance v05r02	8.3.2.3 (Method AVGPM)
3	Power Spectral Density	KDB 558074 D01 15.247 Meas Guidance v05r02	8.4 (Method PKPSD)
4	Out-of-band emissions in non-restricted bands	KDB 558074 D01 15.247 Meas Guidance v05r02	8.5
5	Out-of-band emissions in restricted bands	KDB 558074 D01 15.247 Meas Guidance v05r02	8.6
6	Band-edge	KDB 558074 D01 15.247 Meas Guidance v05r02	8.7
7	Conducted Emission Test For AC Power Port	ANSI C63.10-2013	6.2



7. ANTENNA PORT TEST RESULTS

7.1. TEST ENVIRONMENT

Environment Parameter	Selected Values During Tests
Relative Humidity	59.7%
Atmospheric Pressure:	101kPa
Temperature	21.3°C



7.2. ON TIME AND DUTY CYCLE

LIMITS

None; for reporting purposes only

PROCEDURE

FCC KDB 558074 Zero-Span Spectrum Analyzer Method

TEST SETUP

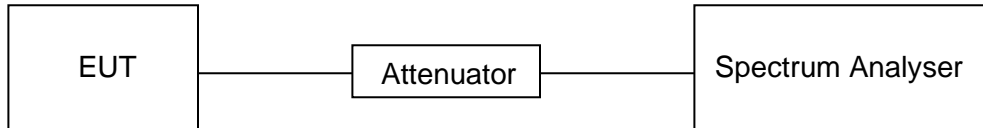

RESULTS

Mode	On Time (msec)	Period (msec)	Duty Cycle x (Linear)	Duty Cycle (%)	Duty Cycle Correction Factor (db)	Final Minimum VBW (KHz)
11B	100	100	1	100	0	0.01(Note4)
11G	100	100	1	100	0	0.01(Note4)
11N HT20	100	100	1	100	0	0.01(Note4)

Note: 1) Duty Cycle Correction Factor= $10\log(1/x)$.

2) Where: x is Duty Cycle(Linear)

3) Where: T is On Time (transmit duration)

4) The minimum VBW should be 10Hz if the duty cycle is over 98%.



11B ON TIME AND DUTY CYCLE MID CH (WORSE CASE)



11G ON TIME AND DUTY CYCLE MID CH (WORSE CASE)

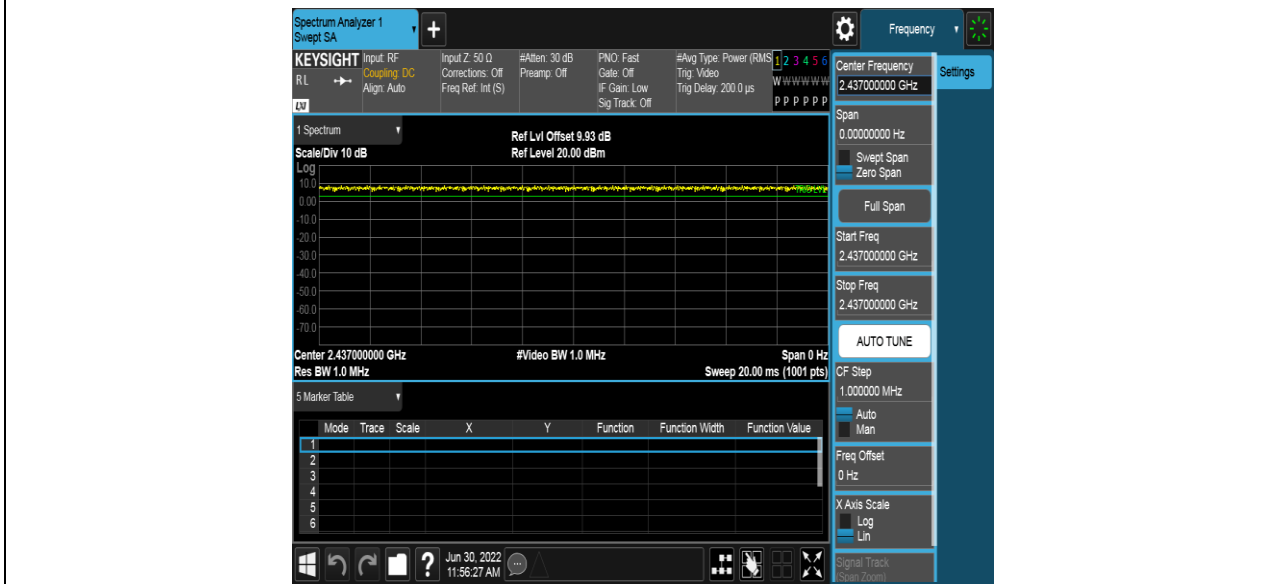



11N HT20 ON TIME AND DUTY CYCLE MID CH (WORSE CASE)

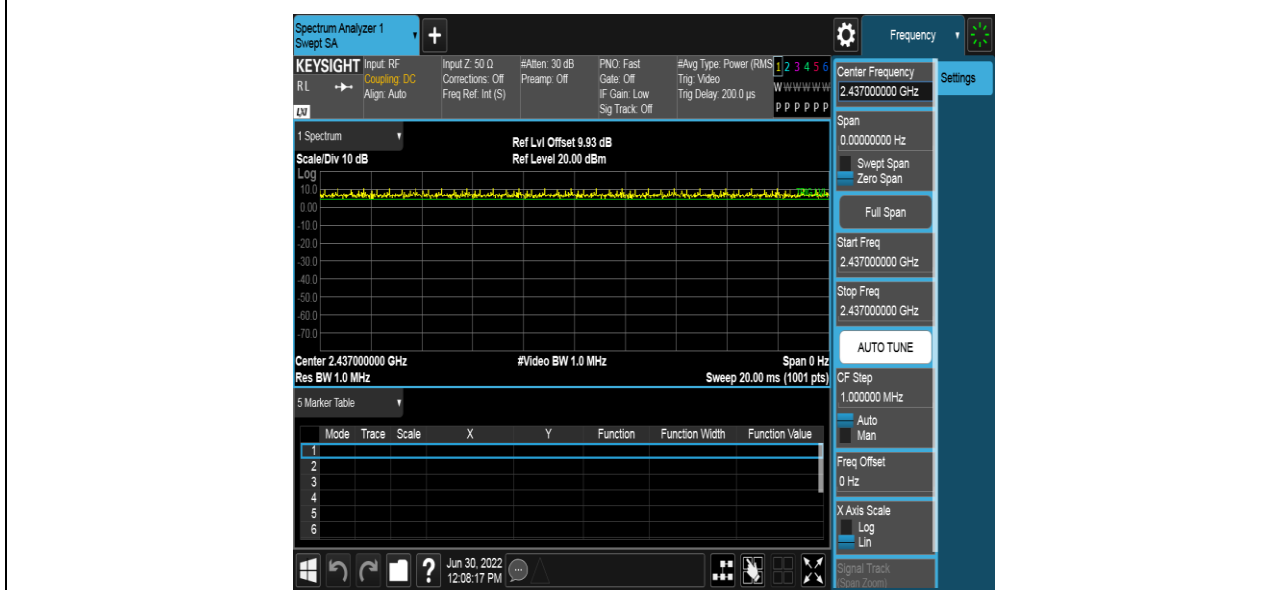

7.3. 6 dB BANDWIDTH AND 99% BANDWIDTH

LIMITS

FCC Part15 (15.247) Subpart C, ISED RSS-247 Issue 2			
Section	Test Item	Limit	Frequency Range (MHz)
FCC 15.247(a)(2)	6dB Bandwidth	$\geq 500\text{KHz}$	2400-2483.5
ISED RSS-Gen Clause 6.7	99% Occupied Bandwidth	For reporting purposes only.	2400-2483.5

TEST PROCEDURE

Refer to FCC KDB 558074, connect the UUT to the spectrum analyzer and use the following settings:

Center Frequency	The centre frequency of the channel under test
Detector	Peak
RBW	For 6dB Bandwidth :100K For 99% Occupied Bandwidth :1% to 5% of the occupied bandwidth
VBW	For 6dB Bandwidth : $\geq 3 \times \text{RBW}$ For 99% Occupied Bandwidth : approximately $3 \times \text{RBW}$
Trace	Max hold
Sweep	Auto couple

Allow the trace to stabilize and measure the maximum width of the emission that is constrained by the frequencies associated with the two outermost amplitude points (upper and lower frequencies) that are attenuated by 6 dB relative to the maximum level measured in the fundamental emission.

TEST SETUP

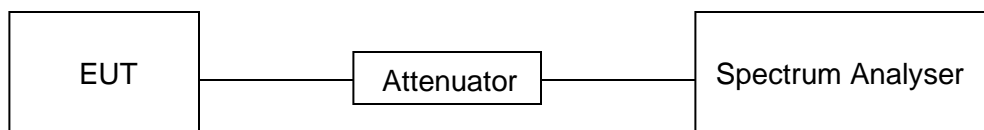



RESULTS

Test Mode	Test Channel	6dB bandwidth (MHz)	99% bandwidth (MHz)	Result
11B	LCH	9.080	13.056	Pass
	MCH	9.080	13.060	Pass
	HCH	9.040	13.131	Pass
11G	LCH	16.280	16.334	Pass
	MCH	16.320	16.354	Pass
	HCH	16.360	16.367	Pass
11N HT20	LCH	16.800	17.031	Pass
	MCH	16.560	17.002	Pass
	HCH	16.800	17.060	Pass

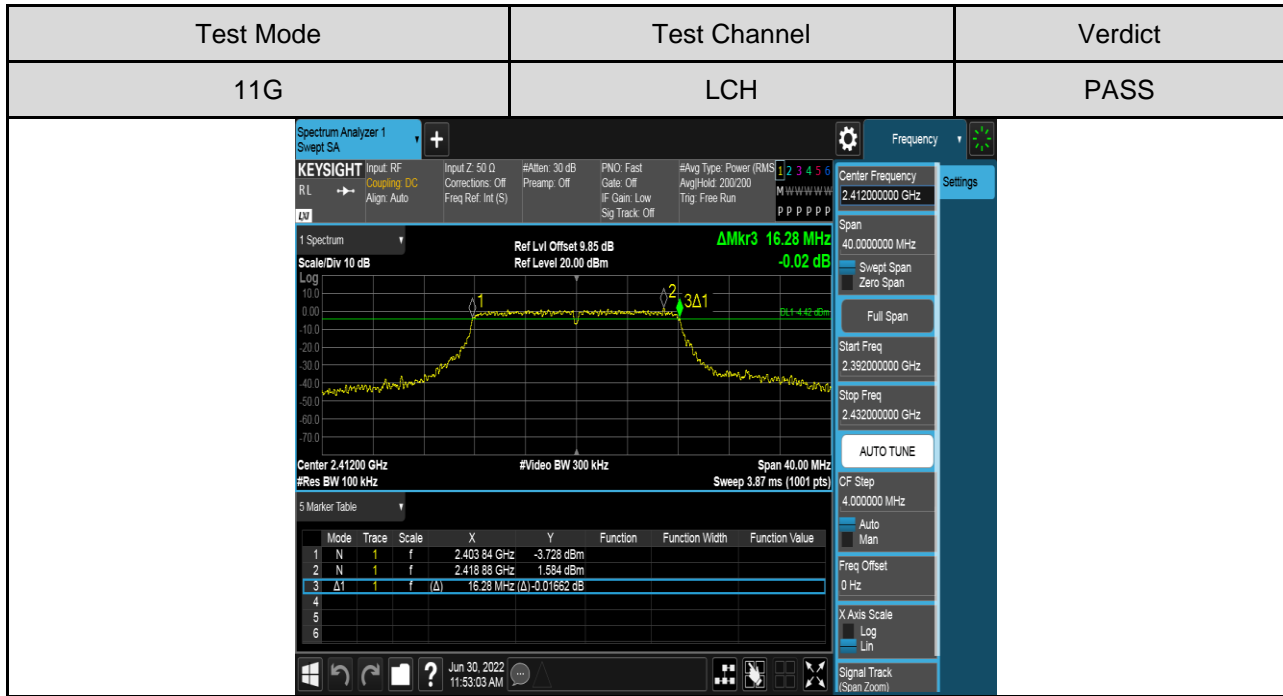
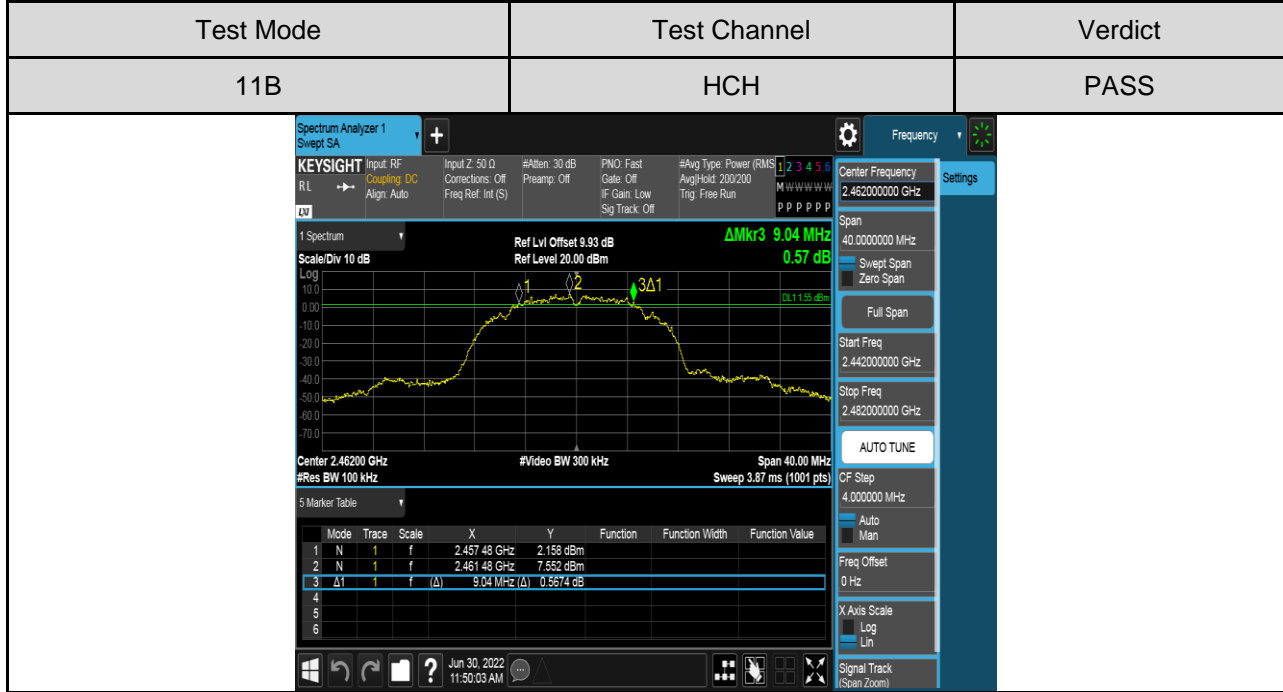

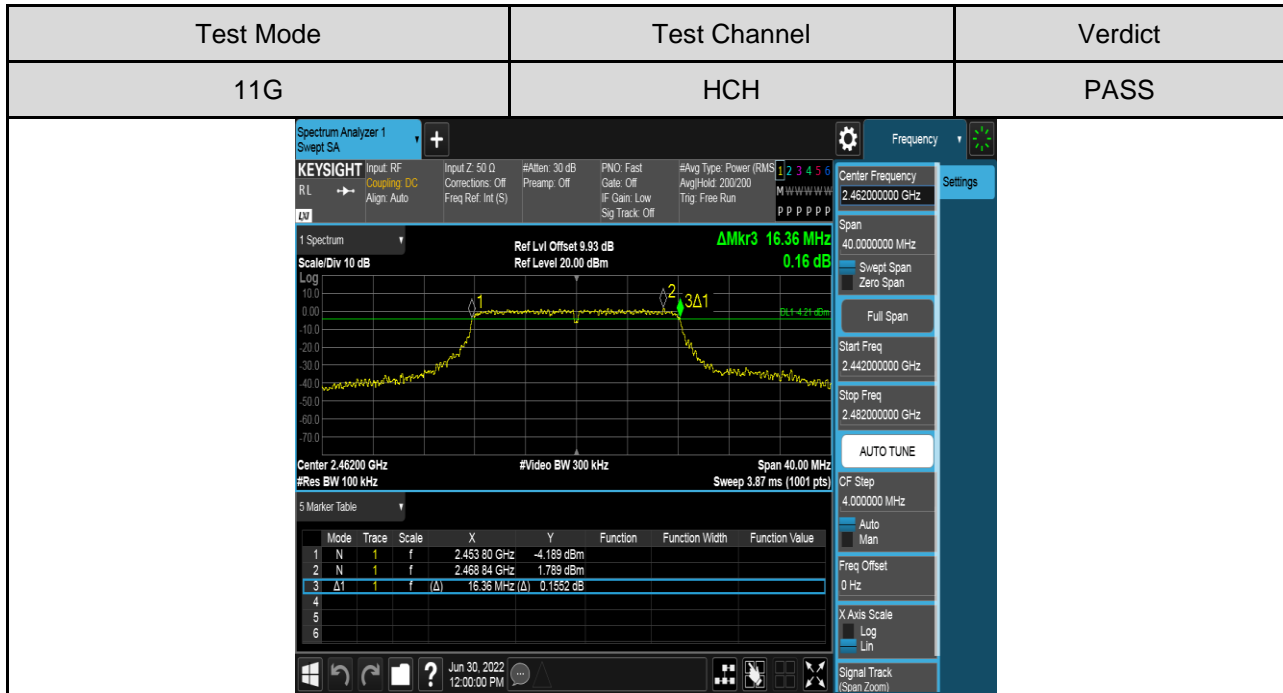
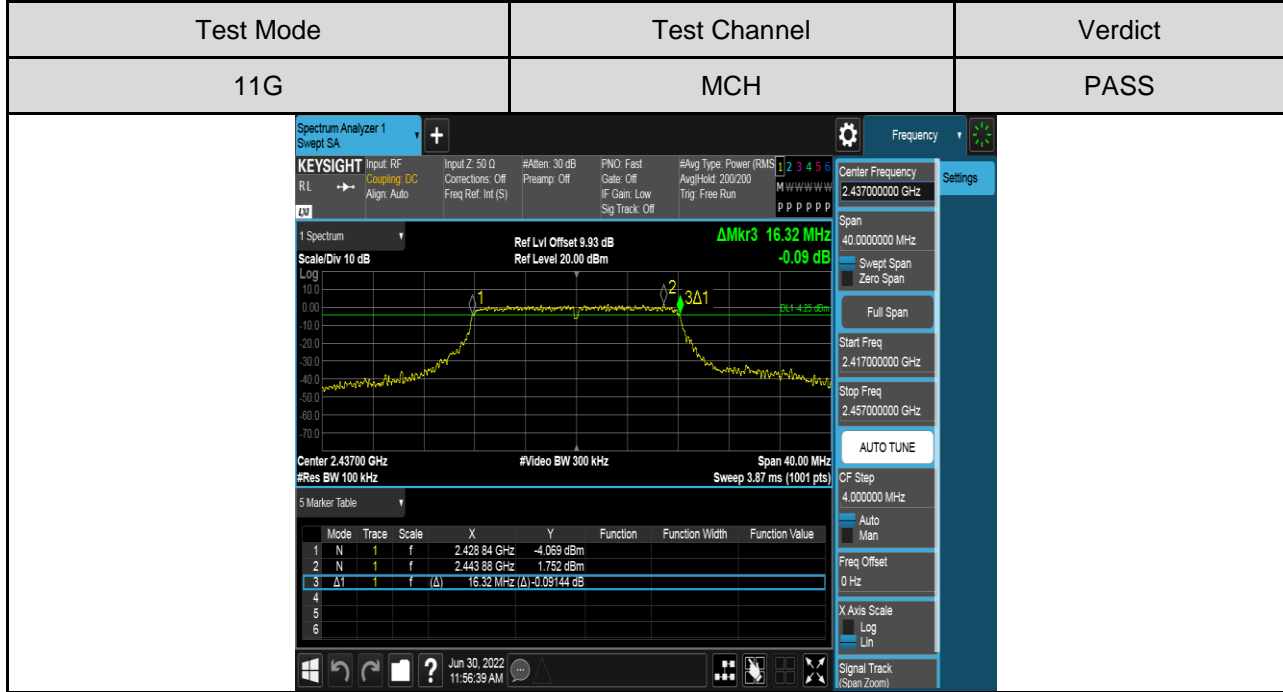



Test Mode	Test Channel	Verdict
11N HT20	LCH	PASS



Test Mode	Test Channel	Verdict
11N HT20	MCH	PASS



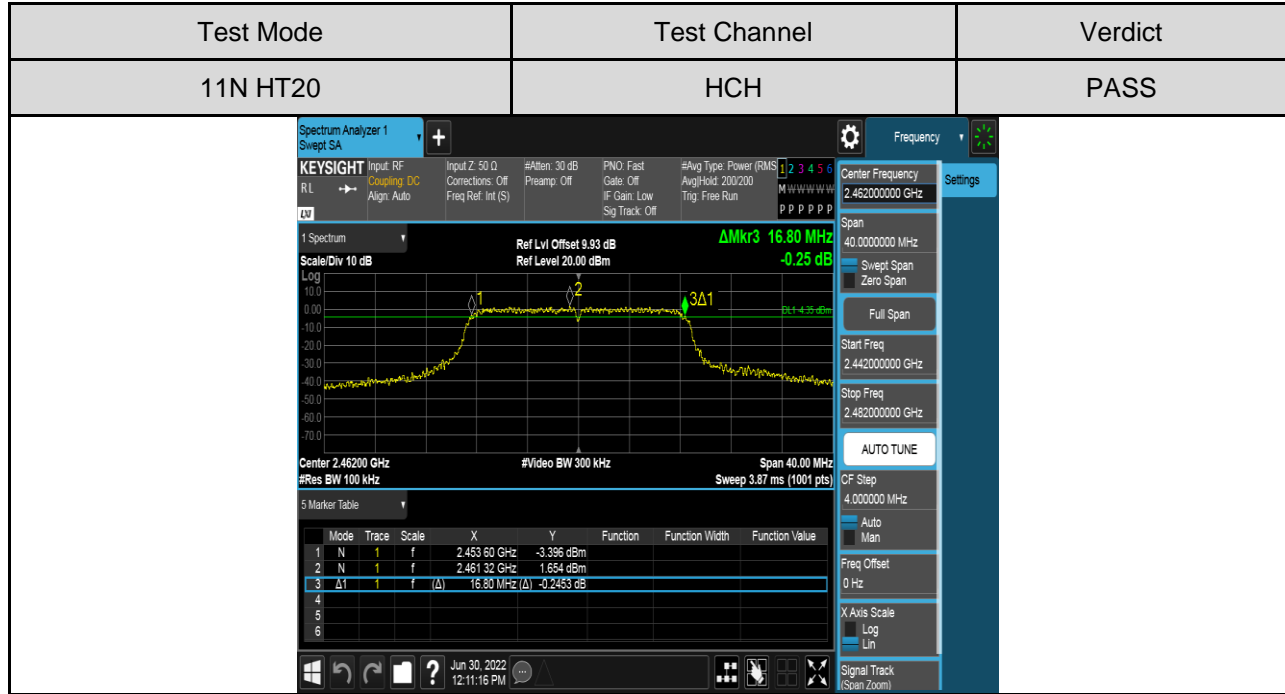

For 99% Bandwidth part:

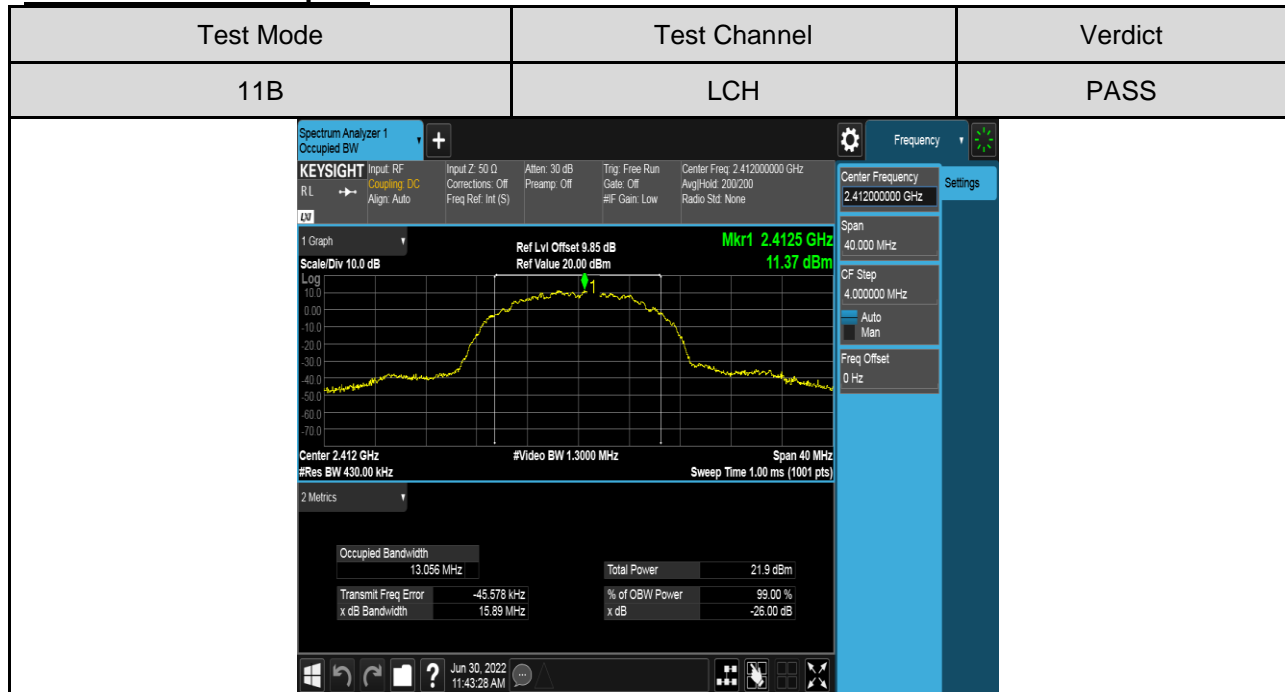



Test Mode	Test Channel	Verdict
11B	MCH	PASS
<p>Keysight Spectrum Analyzer 1 screenshot for Test Channel MCH. The display shows a signal centered at 2.437 GHz with a video bandwidth of 1.3000 MHz and a span of 40 MHz. A marker is placed at 2.4355 GHz, indicating a power level of 11.62 dBm. The occupied bandwidth is measured as 13.060 MHz, and the total power is 21.9 dBm. The transmit frequency error is -67.819 kHz, and the percentage of occupied bandwidth power is 99.00%.</p>		

Test Mode	Test Channel	Verdict
11B	HCH	PASS
<p>Keysight Spectrum Analyzer 1 screenshot for Test Channel HCH. The display shows a signal centered at 2.462 GHz with a video bandwidth of 1.3000 MHz and a span of 40 MHz. A marker is placed at 2.4625 GHz, indicating a power level of 11.33 dBm. The occupied bandwidth is measured as 13.131 MHz, and the total power is 22.0 dBm. The transmit frequency error is -96.198 kHz, and the percentage of occupied bandwidth power is 99.00%.</p>		



Test Mode	Test Channel	Verdict												
11G	LCH	PASS												
<p>Keysight Spectrum Analyzer 1 Occupied BW</p> <p>Center Freq: 2.41200000 GHz Span: 40.000 MHz Mkr1: 2.4139 GHz, 7.31 dBm</p> <table border="1"> <tr> <td>Occupied Bandwidth</td> <td>16.334 MHz</td> <td>Total Power</td> <td>20.5 dBm</td> </tr> <tr> <td>Transmit Freq Error</td> <td>5.096 kHz</td> <td>% of OBW Power</td> <td>99.00 %</td> </tr> <tr> <td>x dB Bandwidth</td> <td>18.91 MHz</td> <td>x dB</td> <td>-26.00 dB</td> </tr> </table>			Occupied Bandwidth	16.334 MHz	Total Power	20.5 dBm	Transmit Freq Error	5.096 kHz	% of OBW Power	99.00 %	x dB Bandwidth	18.91 MHz	x dB	-26.00 dB
Occupied Bandwidth	16.334 MHz	Total Power	20.5 dBm											
Transmit Freq Error	5.096 kHz	% of OBW Power	99.00 %											
x dB Bandwidth	18.91 MHz	x dB	-26.00 dB											

Test Mode	Test Channel	Verdict												
11G	MCH	PASS												
<p>Keysight Spectrum Analyzer 1 Occupied BW</p> <p>Center Freq: 2.43700000 GHz Span: 40.000 MHz Mkr1: 2.4390 GHz, 7.34 dBm</p> <table border="1"> <tr> <td>Occupied Bandwidth</td> <td>16.354 MHz</td> <td>Total Power</td> <td>20.6 dBm</td> </tr> <tr> <td>Transmit Freq Error</td> <td>18.619 kHz</td> <td>% of OBW Power</td> <td>99.00 %</td> </tr> <tr> <td>x dB Bandwidth</td> <td>19.33 MHz</td> <td>x dB</td> <td>-26.00 dB</td> </tr> </table>			Occupied Bandwidth	16.354 MHz	Total Power	20.6 dBm	Transmit Freq Error	18.619 kHz	% of OBW Power	99.00 %	x dB Bandwidth	19.33 MHz	x dB	-26.00 dB
Occupied Bandwidth	16.354 MHz	Total Power	20.6 dBm											
Transmit Freq Error	18.619 kHz	% of OBW Power	99.00 %											
x dB Bandwidth	19.33 MHz	x dB	-26.00 dB											



Test Mode	Test Channel	Verdict												
11G	HCH	PASS												
<p>The screenshot shows a Keysight Spectrum Analyzer interface. At the top, it displays 'Spectrum Analyzer 1' and 'Occupied BW'. The main display area shows a graph with a signal peak at 2.4638 GHz and a power level of 8.16 dBm. The graph settings include a center frequency of 2.462 GHz, a span of 40 MHz, and a resolution bandwidth of 430.0 kHz. A metrics table at the bottom provides the following data:</p> <table border="1"> <tr> <td>Occupied Bandwidth</td> <td>16.367 MHz</td> <td>Total Power</td> <td>20.9 dBm</td> </tr> <tr> <td>Transmit Freq Error</td> <td>11.955 kHz</td> <td>% of OBW Power</td> <td>99.00 %</td> </tr> <tr> <td>x dB Bandwidth</td> <td>18.80 MHz</td> <td>x dB</td> <td>-26.00 dB</td> </tr> </table>			Occupied Bandwidth	16.367 MHz	Total Power	20.9 dBm	Transmit Freq Error	11.955 kHz	% of OBW Power	99.00 %	x dB Bandwidth	18.80 MHz	x dB	-26.00 dB
Occupied Bandwidth	16.367 MHz	Total Power	20.9 dBm											
Transmit Freq Error	11.955 kHz	% of OBW Power	99.00 %											
x dB Bandwidth	18.80 MHz	x dB	-26.00 dB											

Test Mode	Test Channel	Verdict												
11N HT20	LCH	PASS												
<p>The screenshot shows a Keysight Spectrum Analyzer interface. At the top, it displays 'Spectrum Analyzer 1' and 'Occupied BW'. The main display area shows a graph with a signal peak at 2.4160 GHz and a power level of 6.96 dBm. The graph settings include a center frequency of 2.412 GHz, a span of 40 MHz, and a resolution bandwidth of 430.0 kHz. A metrics table at the bottom provides the following data:</p> <table border="1"> <tr> <td>Occupied Bandwidth</td> <td>17.031 MHz</td> <td>Total Power</td> <td>20.3 dBm</td> </tr> <tr> <td>Transmit Freq Error</td> <td>4.823 kHz</td> <td>% of OBW Power</td> <td>99.00 %</td> </tr> <tr> <td>x dB Bandwidth</td> <td>19.32 MHz</td> <td>x dB</td> <td>-26.00 dB</td> </tr> </table>			Occupied Bandwidth	17.031 MHz	Total Power	20.3 dBm	Transmit Freq Error	4.823 kHz	% of OBW Power	99.00 %	x dB Bandwidth	19.32 MHz	x dB	-26.00 dB
Occupied Bandwidth	17.031 MHz	Total Power	20.3 dBm											
Transmit Freq Error	4.823 kHz	% of OBW Power	99.00 %											
x dB Bandwidth	19.32 MHz	x dB	-26.00 dB											



Test Mode	Test Channel	Verdict												
11N HT20	MCH	PASS												
<p>The screenshot shows a Keysight Spectrum Analyzer interface. The main display is a graph with a yellow signal trace. A marker is placed at 2.4380 GHz with a power level of 7.65 dBm. The graph settings include a scale of 10.0 dB and a video bandwidth of 1.3000 MHz. The center frequency is 2.437 GHz. The metrics table at the bottom shows an occupied bandwidth of 17.002 MHz, total power of 20.6 dBm, and a transmit frequency error of -12.537 kHz.</p> <table border="1"> <tr> <td>Occupied Bandwidth</td> <td>17.002 MHz</td> <td>Total Power</td> <td>20.6 dBm</td> </tr> <tr> <td>Transmit Freq Error</td> <td>-12.537 kHz</td> <td>% of OBW Power</td> <td>99.00 %</td> </tr> <tr> <td>x dB Bandwidth</td> <td>19.33 MHz</td> <td>x dB</td> <td>-26.00 dB</td> </tr> </table>			Occupied Bandwidth	17.002 MHz	Total Power	20.6 dBm	Transmit Freq Error	-12.537 kHz	% of OBW Power	99.00 %	x dB Bandwidth	19.33 MHz	x dB	-26.00 dB
Occupied Bandwidth	17.002 MHz	Total Power	20.6 dBm											
Transmit Freq Error	-12.537 kHz	% of OBW Power	99.00 %											
x dB Bandwidth	19.33 MHz	x dB	-26.00 dB											

Test Mode	Test Channel	Verdict												
11N HT20	HCH	PASS												
<p>The screenshot shows a Keysight Spectrum Analyzer interface. The main display is a graph with a yellow signal trace. A marker is placed at 2.4609 GHz with a power level of 7.09 dBm. The graph settings include a scale of 10.0 dB and a video bandwidth of 1.3000 MHz. The center frequency is 2.462 GHz. The metrics table at the bottom shows an occupied bandwidth of 17.060 MHz, total power of 20.7 dBm, and a transmit frequency error of -7.911 kHz.</p> <table border="1"> <tr> <td>Occupied Bandwidth</td> <td>17.060 MHz</td> <td>Total Power</td> <td>20.7 dBm</td> </tr> <tr> <td>Transmit Freq Error</td> <td>-7.911 kHz</td> <td>% of OBW Power</td> <td>99.00 %</td> </tr> <tr> <td>x dB Bandwidth</td> <td>19.60 MHz</td> <td>x dB</td> <td>-26.00 dB</td> </tr> </table>			Occupied Bandwidth	17.060 MHz	Total Power	20.7 dBm	Transmit Freq Error	-7.911 kHz	% of OBW Power	99.00 %	x dB Bandwidth	19.60 MHz	x dB	-26.00 dB
Occupied Bandwidth	17.060 MHz	Total Power	20.7 dBm											
Transmit Freq Error	-7.911 kHz	% of OBW Power	99.00 %											
x dB Bandwidth	19.60 MHz	x dB	-26.00 dB											

7.4. CONDUCTED POWER

LIMITS

FCC Part15 (15.247) Subpart C, , ISED RSS-247 ISSUE 2			
Section	Test Item	Limit	Frequency Range (MHz)
FCC 15.247(b)(3) ISED RSS-247 5.4 (d) RSS-Gen Clause 6.12	Output Power	1 watt or 30dBm	2400-2483.5

TEST PROCEDURE

Place the EUT on the table and set it in the transmitting mode.
Remove the antenna from the EUT and then connect a low loss RF cable from the antenna port to the Power Meter.
Measure the power of each channel.
AVG Detector use for AVG result.

TEST SETUP

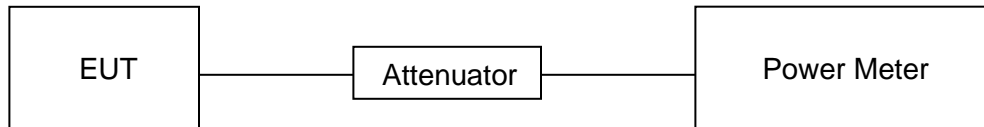



RESULTS

For Normal Testing Part:

Test Mode	Test Channel	Maximum Conducted Output Power (AV)	Result
		dBm	
11B	LCH	16.88	Pass
	MCH	16.41	Pass
	HCH	16.38	Pass
11G	LCH	14.71	Pass
	MCH	14.87	Pass
	HCH	15.04	Pass
11N HT20	LCH	14.41	Pass
	MCH	14.50	Pass
	HCH	14.64	Pass

Remark:

- 1) For all the test results has been adjusted the duty cycle factor.
- 2) For Correction Factor is refer to the result in section 7.2

7.5. POWER SPECTRAL DENSITY

LIMITS

FCC Part15 (15.247) Subpart C, ISED RSS-247 ISSUE 2			
Section	Test Item	Limit	Frequency Range (MHz)
FCC §15.247 (e) ISED RSS-247 5.2 (b)	Power Spectral Density	8 dBm in any 3 kHz band	2400-2483.5

TEST PROCEDURE

Refer to FCC KDB 558074, connect the UUT to the spectrum analyser and use the following settings:

Center Frequency	The centre frequency of the channel under test
Detector	Peak
RBW	$3 \text{ kHz} \leq \text{RBW} \leq 100 \text{ kHz}$
VBW	$\geq 3 \times \text{RBW}$
Span	1.5 x DTS bandwidth
Trace	Max hold
Sweep time	Auto couple.

Allow trace to fully stabilize and use the peak marker function to determine the maximum amplitude level within the RBW.

If measured value exceeds limit, reduce RBW (no less than 3 kHz) and repeat.

TEST SETUP

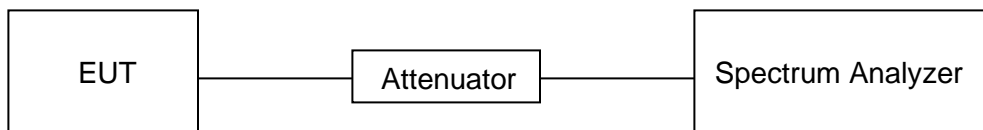



RESULTS

For Normal Testing Part:

Test Mode	Test Channel	Maximum Peak power spectral density (dBm/30kHz)	Result
11B	LCH	1.19	Pass
	MCH	1.56	Pass
	HCH	1.71	Pass
11G	LCH	-2.11	Pass
	MCH	-1.94	Pass
	HCH	-1.79	Pass
11N HT20	LCH	-2.47	Pass
	MCH	-2.47	Pass
	HCH	-2.25	Pass



Test Graphs:

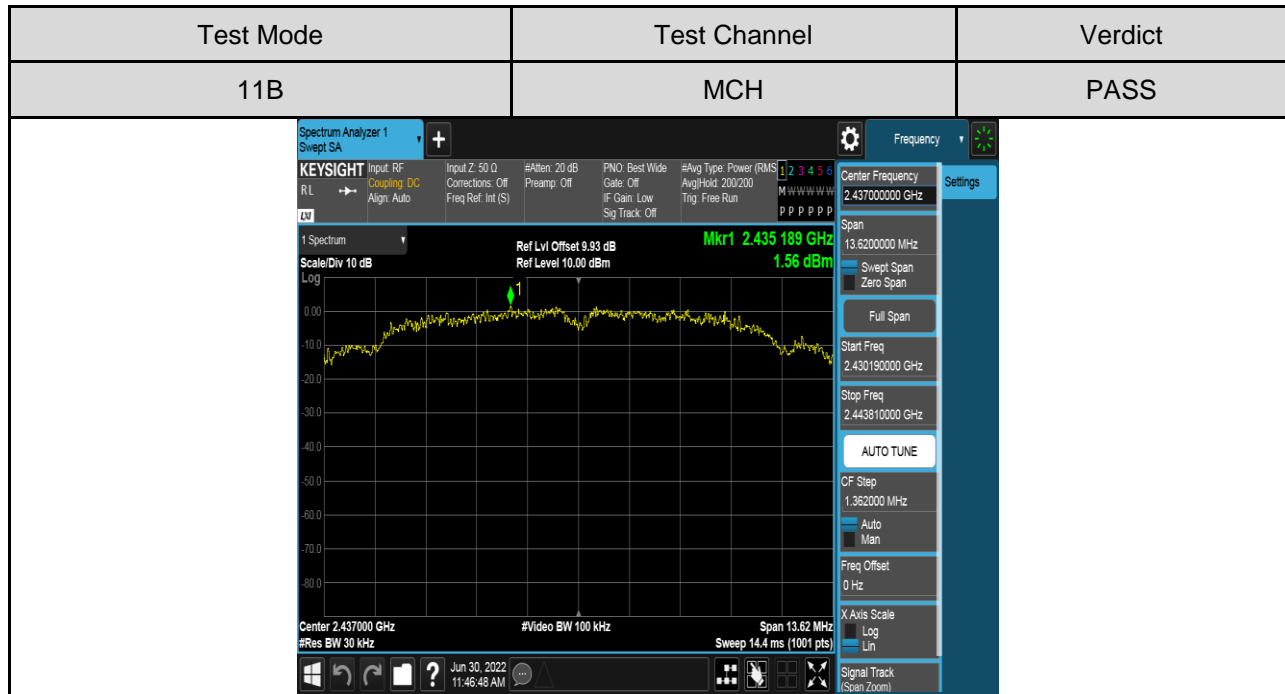
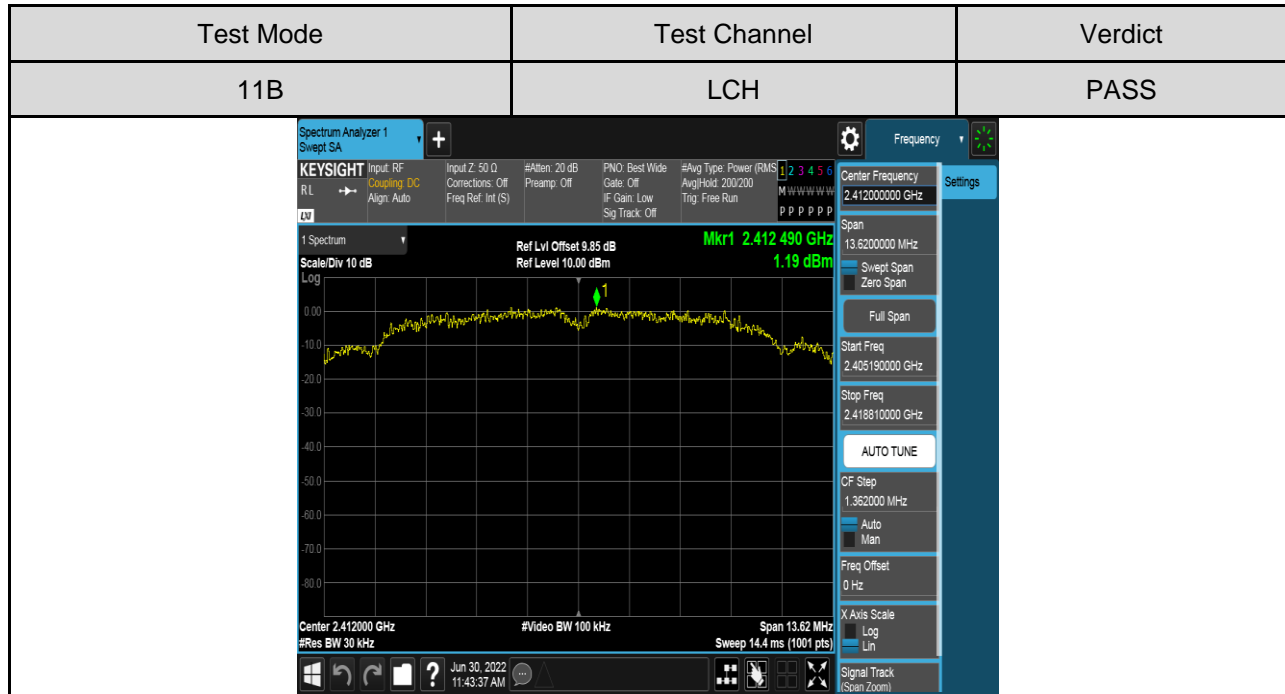



Test Mode	Test Channel	Verdict
11B	HCH	PASS

Test Mode	Test Channel	Verdict
11G	LCH	PASS

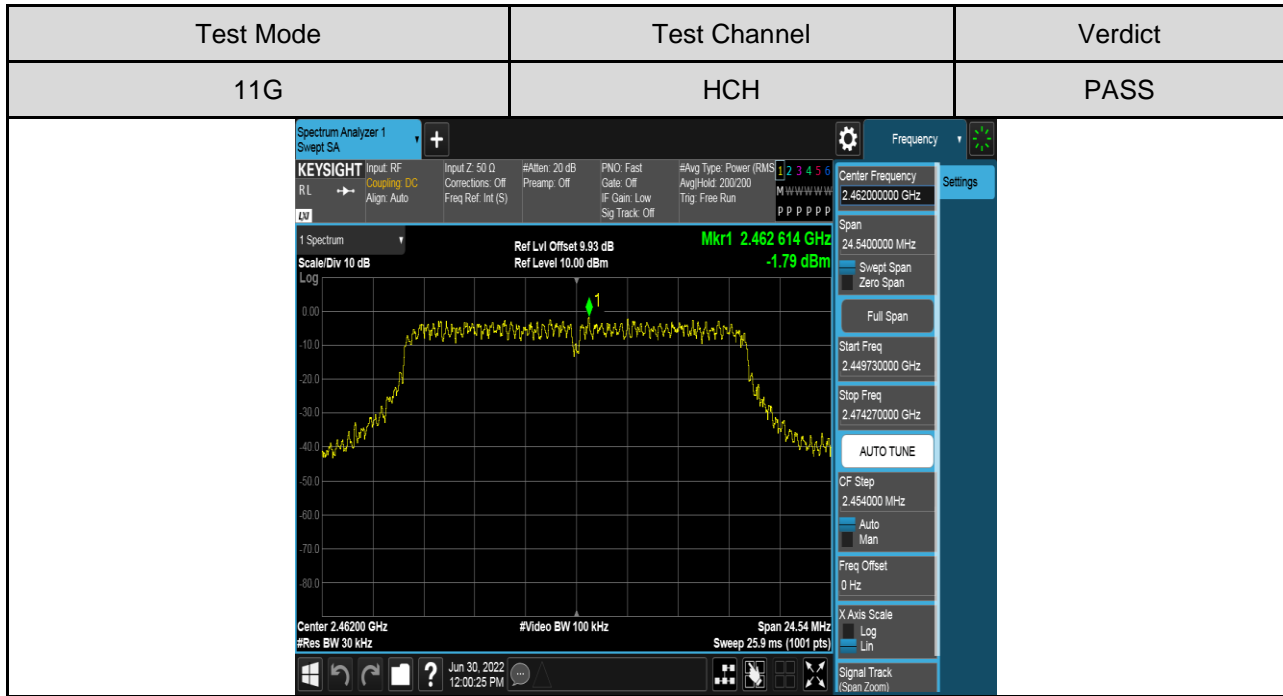
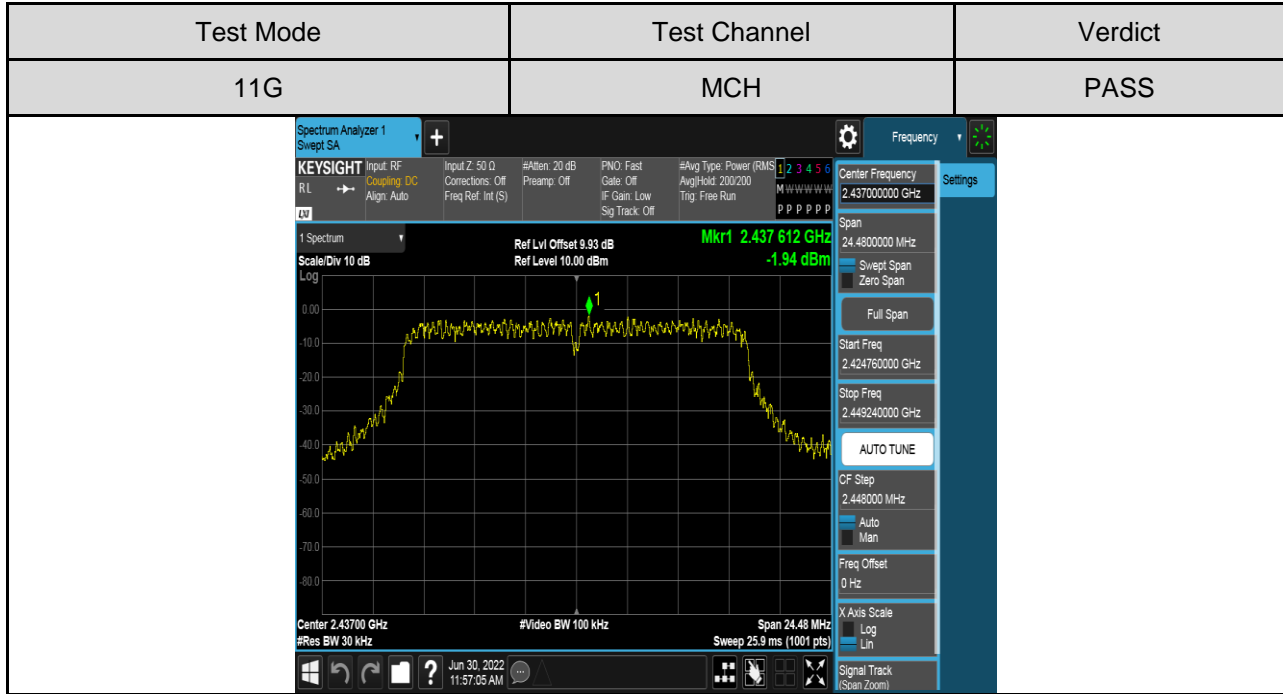



Test Mode	Test Channel	Verdict
11N HT20	LCH	PASS

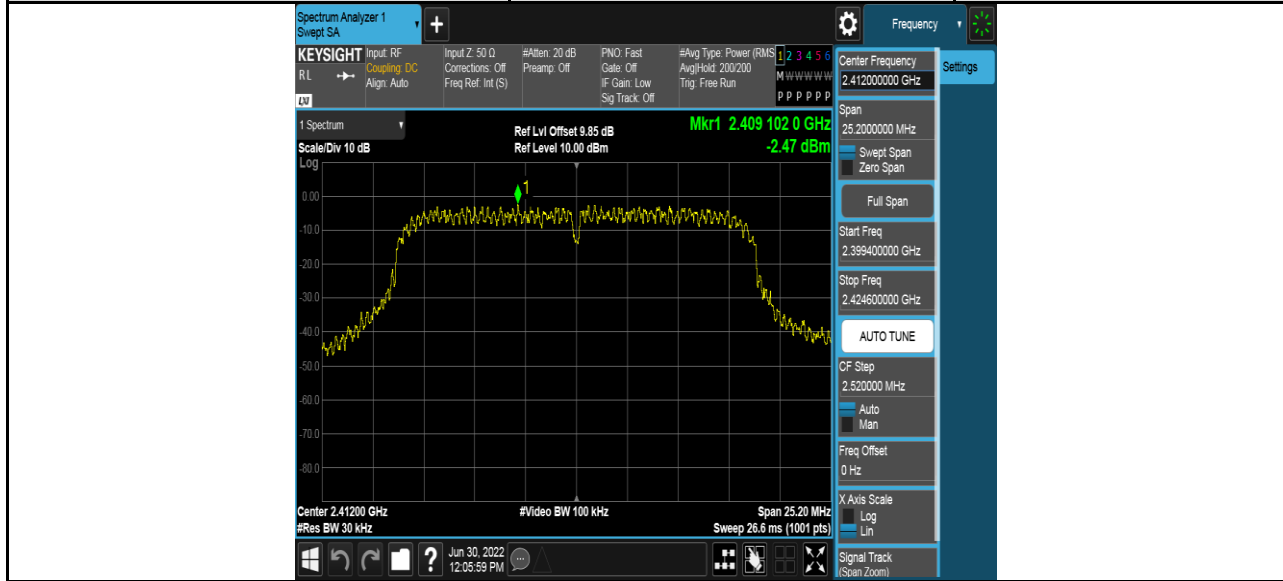

Test Mode	Test Channel	Verdict
11N HT20	MCH	PASS

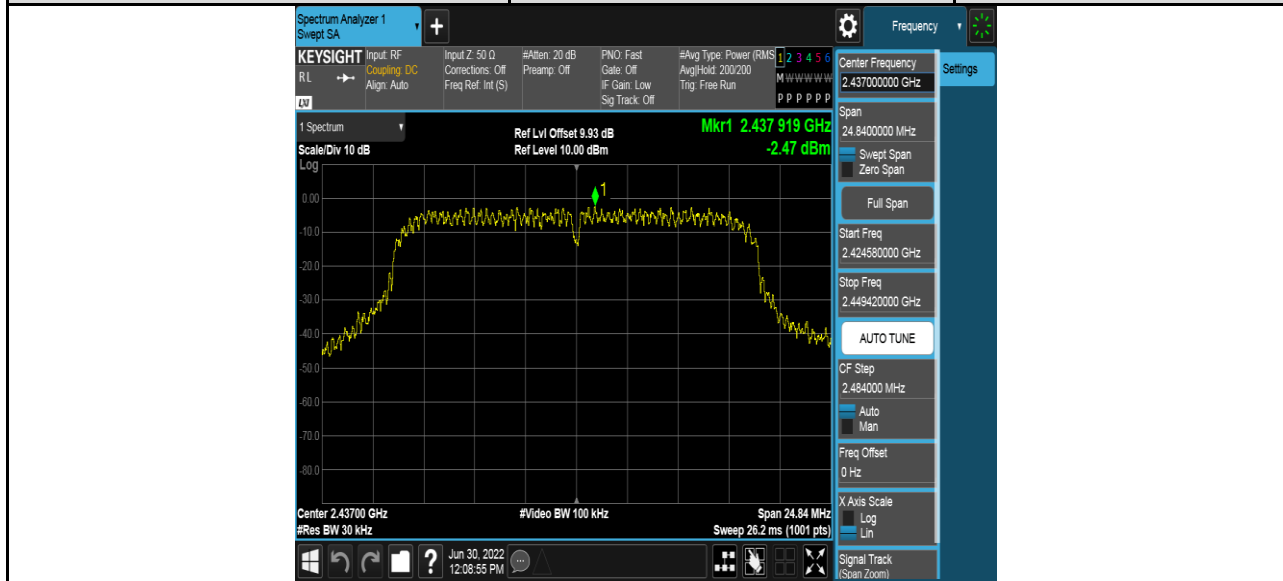

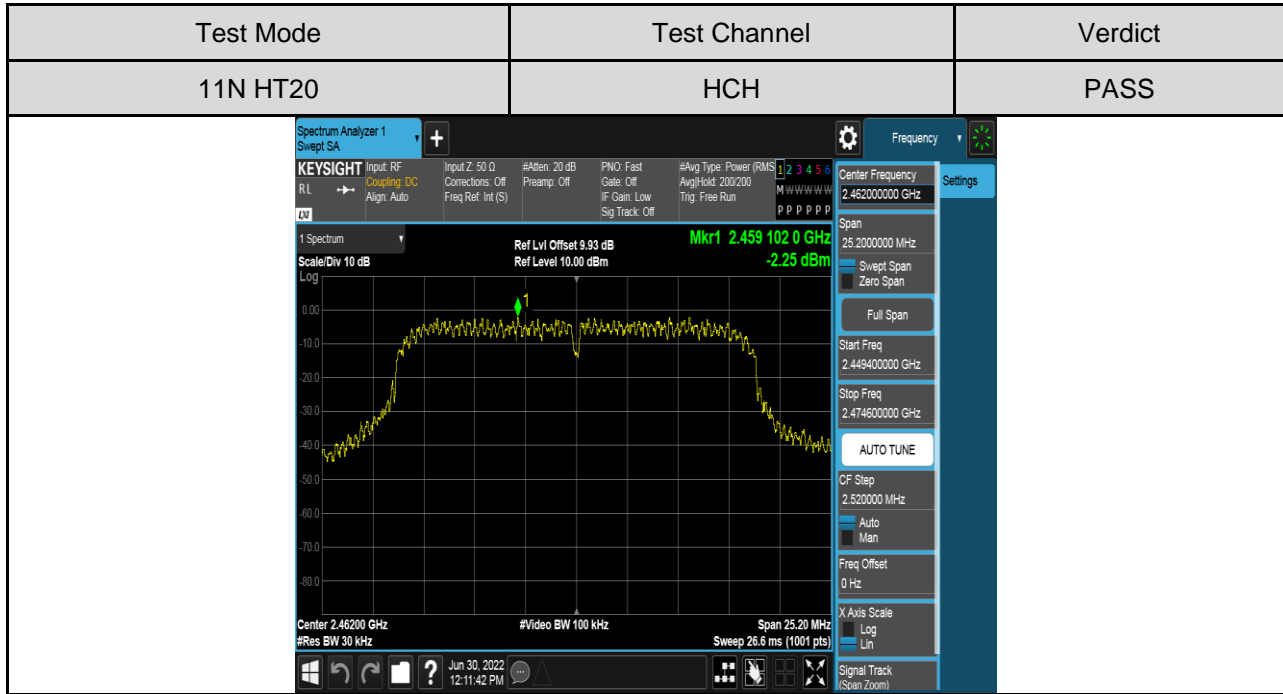

7.6. CONDUCTED BANDEDGE AND SPURIOUS EMISSIONS

LIMITS

FCC Part15 (15.247) Subpart C, ISED RSS-247 ISSUE 2		
Section	Test Item	Limit
FCC §15.247 (d) RSS-247 Clause 5.5 RSS-GEN Clause 6.13	Conducted Bandedge and Spurious Emissions	At least 30 dB below that in the 100 kHz bandwidth within the band that contains the highest level of the desired power

TEST PROCEDURE

Refer to FCC KDB 558074, connect the UUT to the spectrum analyser and use the following

Center Frequency	The centre frequency of the channel under test
Detector	Peak
RBW	100K
VBW	$\geq 3 \times \text{RBW}$
Span	1.5 x DTS bandwidth
Trace	Max hold
Sweep time	Auto couple.

settings:

Use the peak marker function to determine the maximum PSD level.

Span	Set the center frequency and span to encompass frequency range to be measured
Detector	Peak
RBW	100K
VBW	$\geq 3 \times \text{RBW}$
measurement points	$\geq \text{span}/\text{RBW}$
Trace	Max hold
Sweep time	Auto couple.

Use the peak marker function to determine the maximum amplitude level.

TEST SETUP

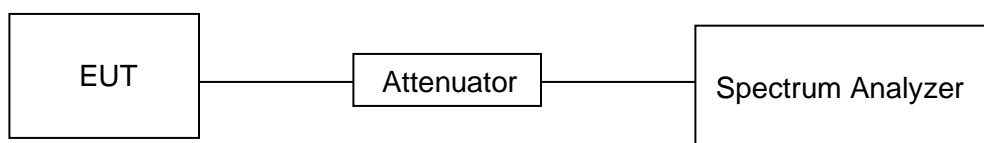



Part I :Conducted Bandedge

RESULTS TABLE

Test Mode	Test Antenna	Test Channel	Test Result	Verdict
11B	Antenna 1	LCH	See the test graphs	PASS
		HCH	See the test graphs	PASS
11G	Antenna 1	LCH	See the test graphs	PASS
		HCH	See the test graphs	PASS
11N HT20	Antenna 1	LCH	See the test graphs	PASS
		HCH	See the test graphs	PASS



TEST GRAPHS

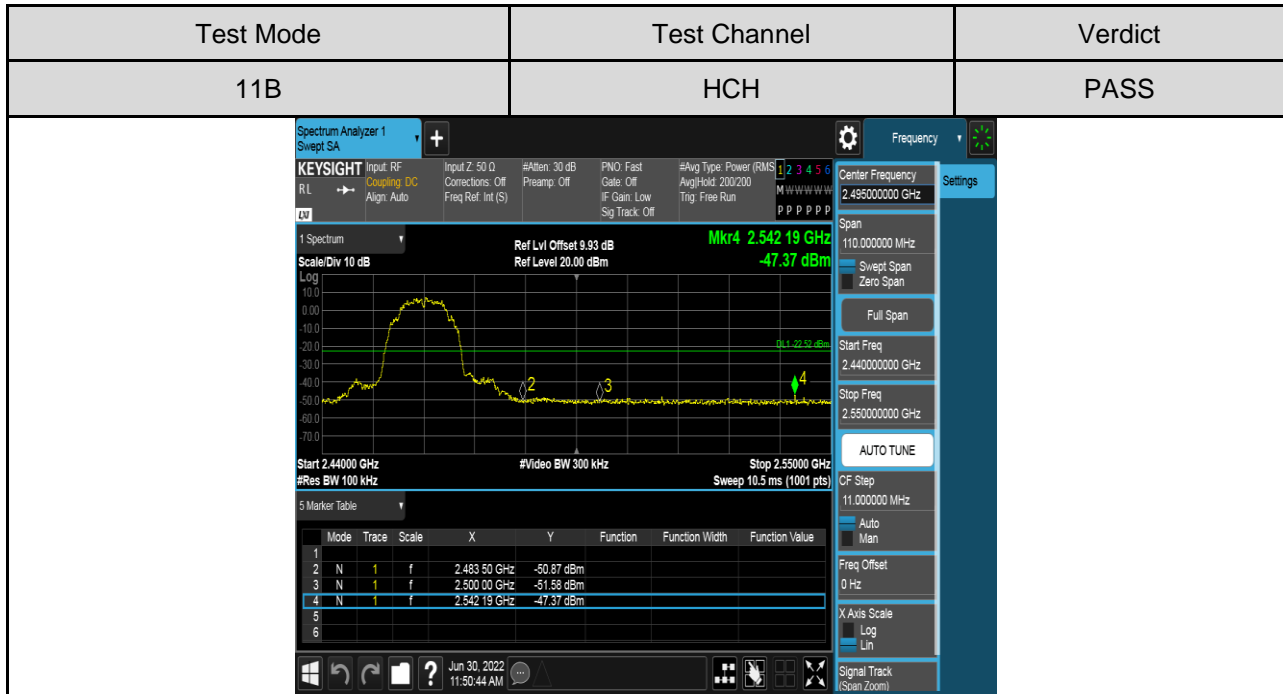
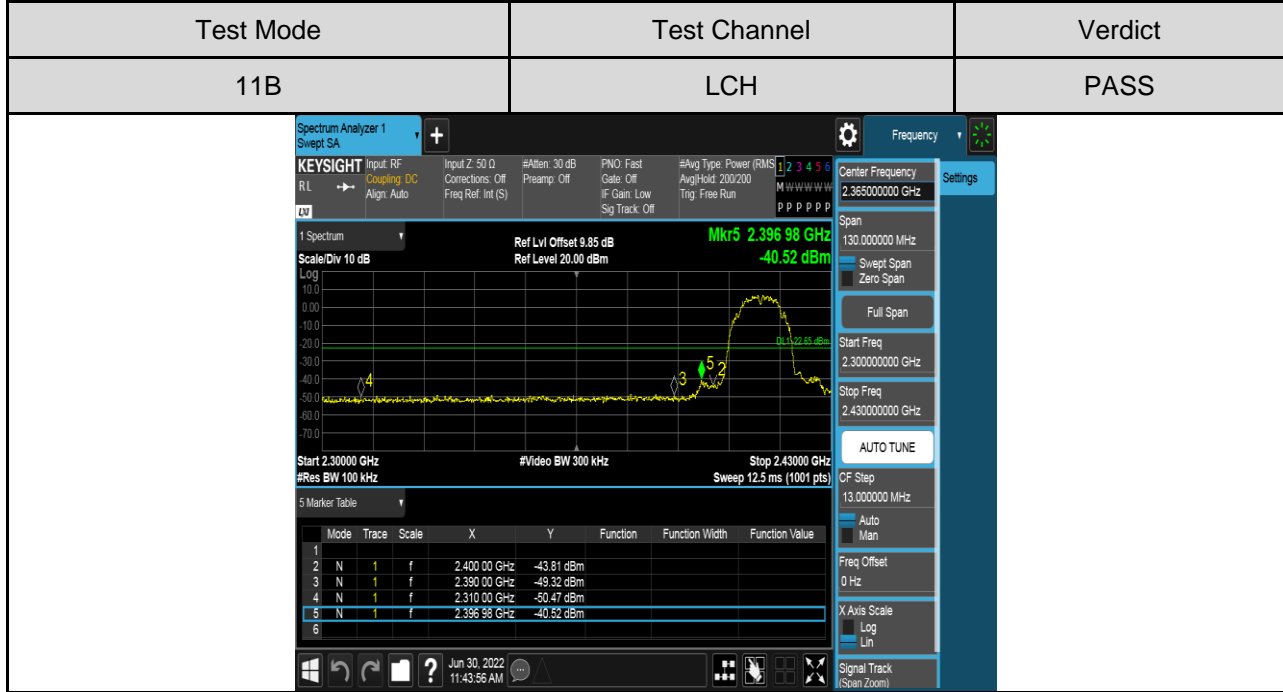

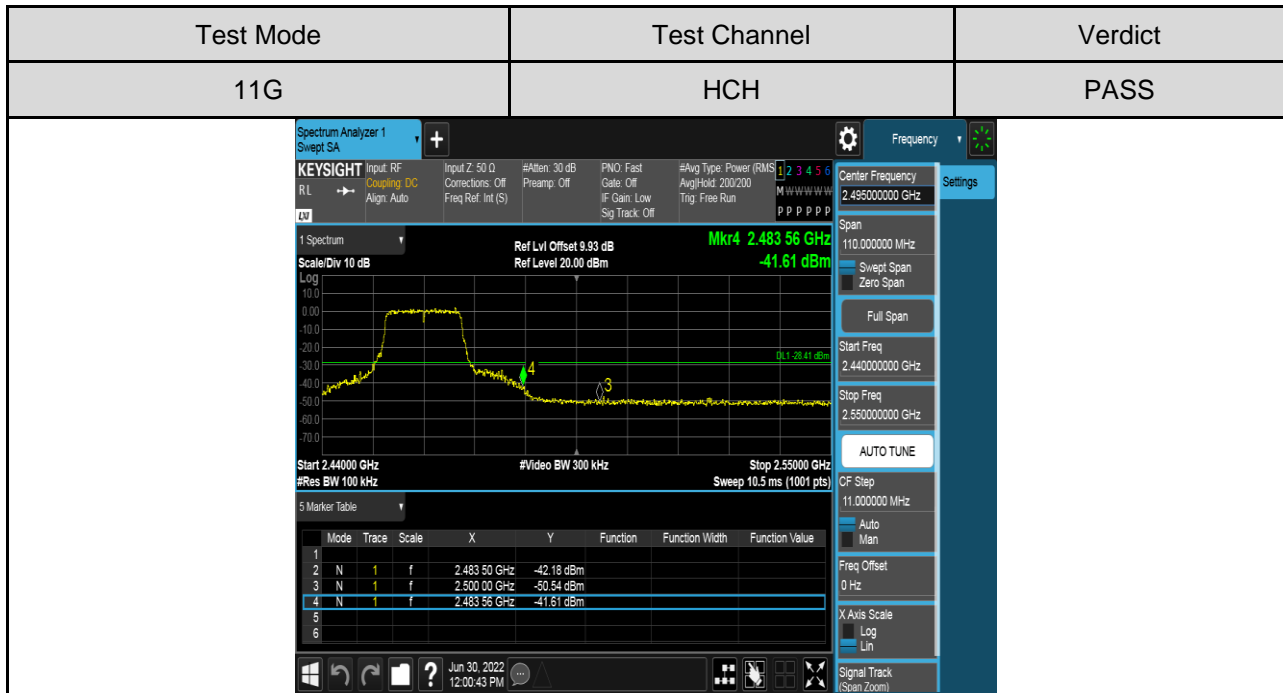
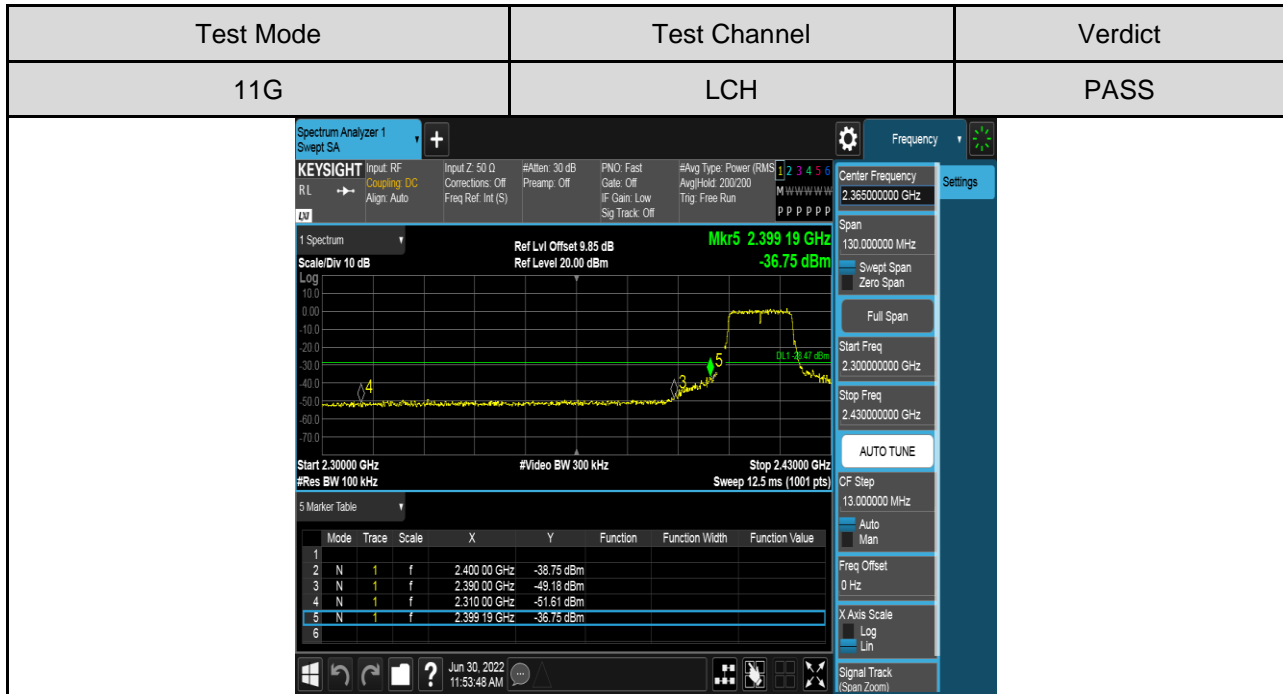

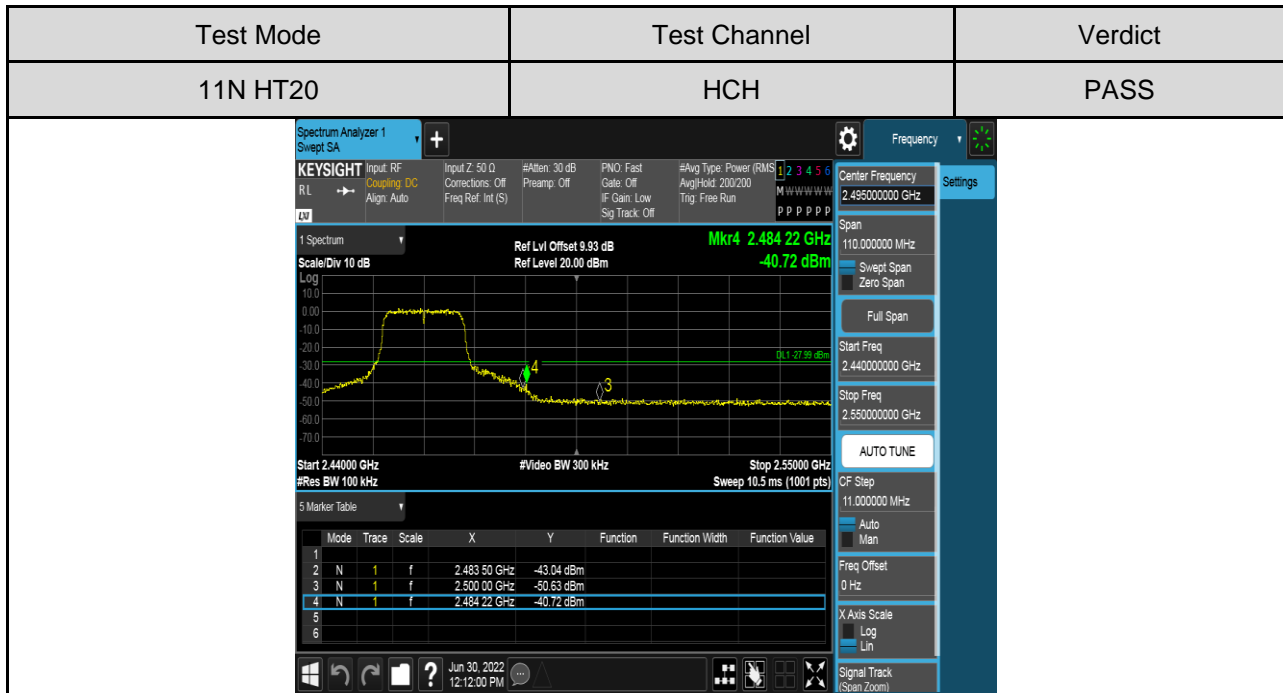
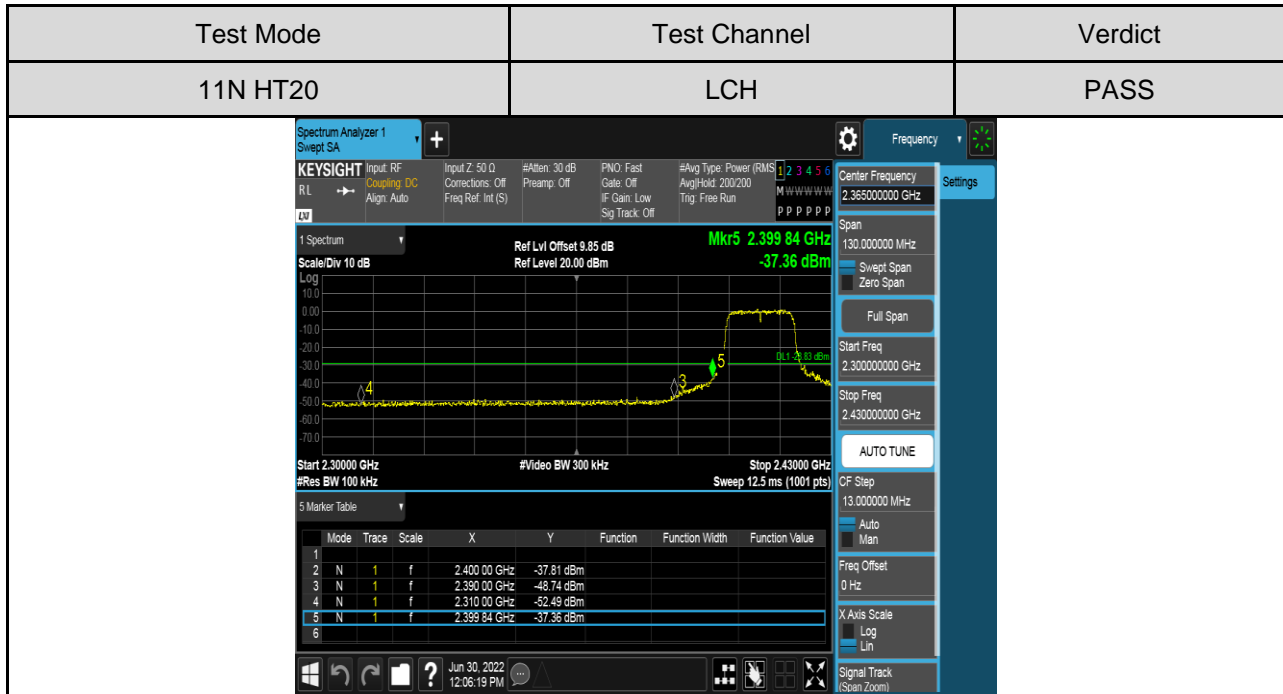



Part II :Conducted Emission

Test Result Table

Test Mode	Test Antenna	Channel	Pref(dBm)	Puw(dBm)	Verdict
11B SISO	Antenna 1	LCH	See the test graphs	<Limit	PASS
		MCH	See the test graphs	<Limit	PASS
		HCH	See the test graphs	<Limit	PASS
11G SISO	Antenna 1	LCH	See the test graphs	<Limit	PASS
		MCH	See the test graphs	<Limit	PASS
		HCH	See the test graphs	<Limit	PASS
11N HT20	Antenna 1	LCH	See the test graphs	<Limit	PASS
		MCH	See the test graphs	<Limit	PASS
		HCH	See the test graphs	<Limit	PASS



Test Plots

Test Mode	Channel	Verdict
11B	LCH	PASS

Pref test Plot





Puw test Plot

LCH SPURIOUS EMISSION_30MHz~1GHz

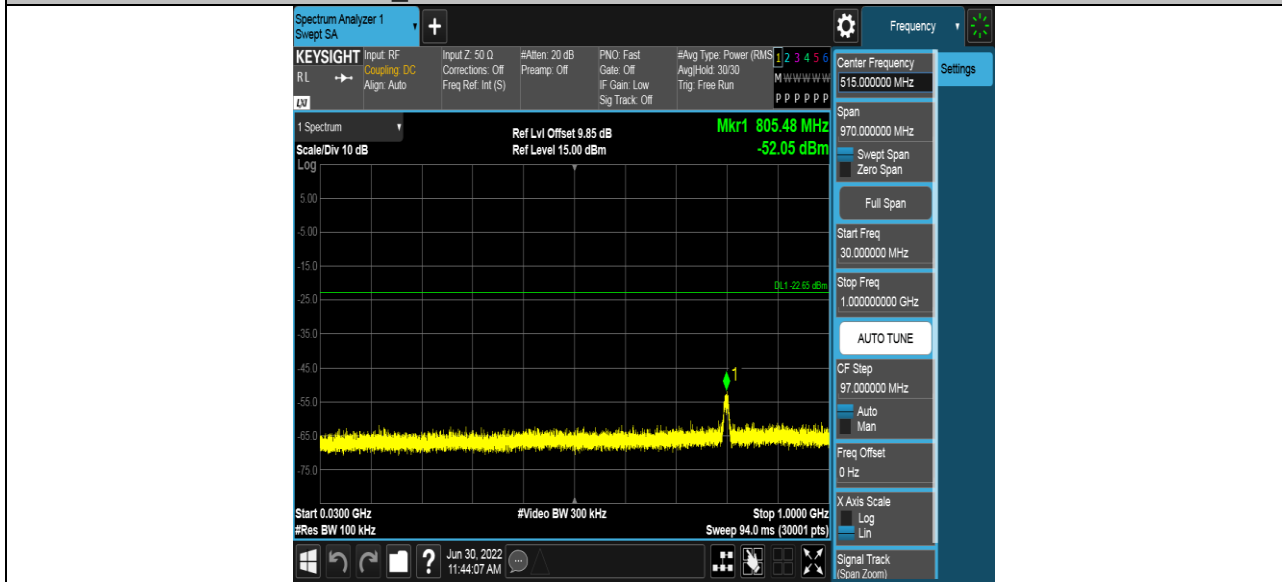

LCH SPURIOUS EMISSION_1GHz~26GHz





Test Mode	Channel	Verdict
11B	MCH	PASS

Pref test Plot





Puw test Plot

MCH SPURIOUS EMISSION_30MHz~1GHz

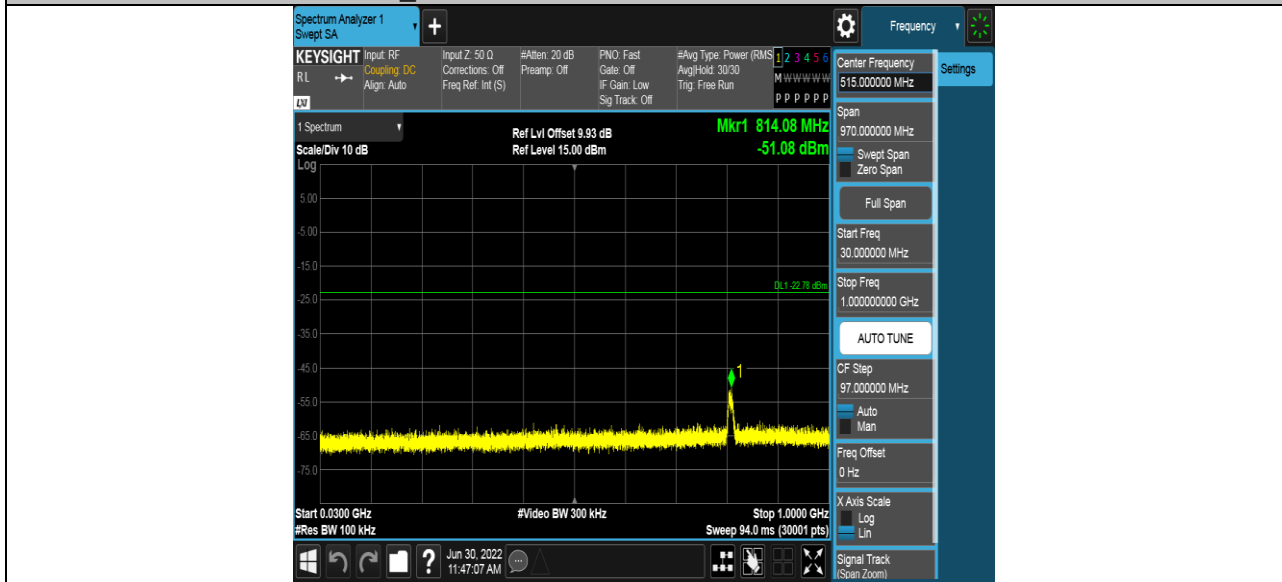

MCH SPURIOUS EMISSION_1GHz~26GHz





Test Mode	Channel	Verdict
11B	HCH	PASS

Pref test Plot





Puw test Plot

HCH SPURIOUS EMISSION_30MHz~1GHz

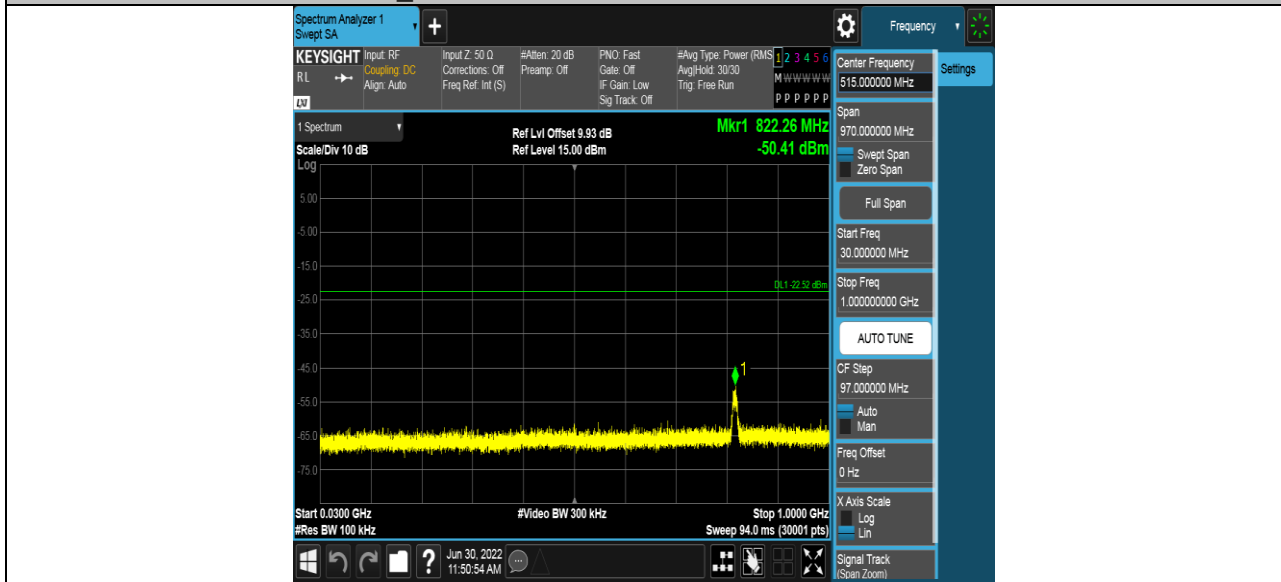

HCH SPURIOUS EMISSION_1GHz~26GHz

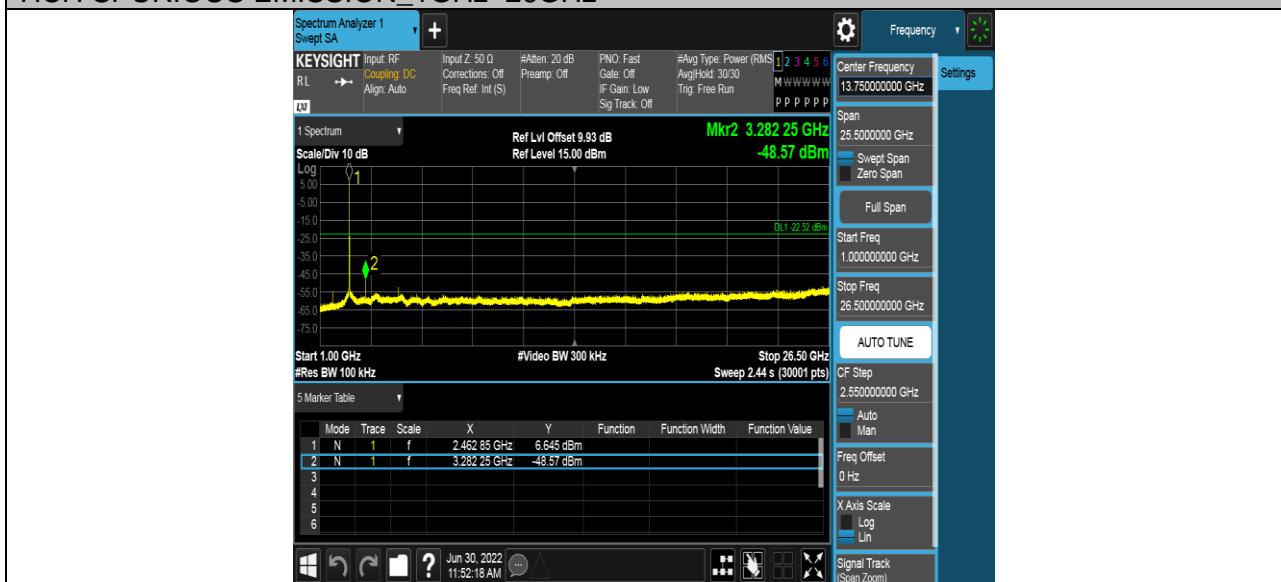



Test Mode	Channel	Verdict
11G	LCH	PASS

Pref test Plot

