



**FCC 47 CFR PART 15 SUBPART C  
ISED RSS-247 Issue 2**

**CERTIFICATION TEST REPORT**

*For*

**SMART VACUUM CLEANER**

**MODEL NUMBER: VS1B0100US**

**PROJECT NUMBER: 4790804070**

**REPORT NUMBER: 4790804070-1**

**FCC ID: 2AV7A-S1A**

**IC: 26039-S1A**

**ISSUE DATE: May 29, 2023**

*Prepared for*

**Tineco Intelligent Technology Co.,Ltd.**

*Prepared by*

**UL-CCIC COMPANY LIMITED**

**No. 2, Chengwan Road, Suzhou Industrial Park, Suzhou 215122, China**

**Tel: +86 512-6808 6400**

**Fax: +86 512-6808 4099**

**Website: [www.ul.com](http://www.ul.com)**

Form-ULID-008536-9 V3.0

The results reported herein have been performed in accordance with the laboratory's terms of accreditation. This report shall not be reproduced except in full without the written approval of the Laboratory. The results in this report apply to the test sample(s) mentioned above at the time of the testing period only and are not to be used to indicate applicability to other similar products.

## Revision History

Rev.	Issue Date	Revisions	Revised By
V0	05/29/2023	Initial Issue	

## TABLE OF CONTENTS

1.	ATTESTATION OF TEST RESULTS .....	4
2.	TEST METHODOLOGY .....	6
3.	FACILITIES AND ACCREDITATION.....	6
4.	CALIBRATION AND UNCERTAINTY.....	7
4.1.	MEASURING INSTRUMENT CALIBRATION.....	7
4.2.	MEASUREMENT UNCERTAINTY .....	7
5.	EQUIPMENT UNDER TEST .....	8
5.1.	DESCRIPTION OF EUT.....	8
5.2.	MAXIMUM OUTPUT POWER.....	9
5.3.	CHANNEL LIST .....	9
5.4.	TEST CHANNEL CONFIGURATION .....	10
5.5.	THE WORSE CASE POWER SETTING PARAMETER .....	10
5.6.	DESCRIPTION OF AVAILABLE ANTENNAS .....	11
5.7.	THE WORSE CASE CONFIGURATIONS.....	11
5.8.	DESCRIPTION OF TEST SETUP .....	12
5.9.	MEASURING INSTRUMENT AND SOFTWARE USED .....	14
6.	MEASUREMENT METHODS.....	16
7.	ANTENNA PORT TEST RESULTS .....	17
7.1.	ON TIME AND DUTY CYCLE .....	17
7.2.	6 dB BANDWIDTH AND 99% OCCUPIED BANDWIDTH.....	21
7.3.	CONDUCTED OUTPUT POWER .....	39
7.4.	POWER SPECTRAL DENSITY .....	49
7.5.	CONDUCTED BANDEDGE AND SPURIOUS EMISSIONS .....	59
8.	RADIATED TEST RESULTS.....	91
8.1.	LIMITS AND PROCEDURE .....	91
8.2.	TEST ENVIRONMENT.....	98
8.3.	RESTRICTED BANDEDGE .....	98
8.4.	SPURIOUS EMISSIONS.....	119
9.	AC POWER LINE CONDUCTED EMISSIONS.....	188
10.	ANTENNA REQUIREMENTS.....	191

# 1. ATTESTATION OF TEST RESULTS

## Applicant Information

Company Name: Tineco Intelligent Technology Co.,Ltd.  
Address: No. 108 Shihu Road West, Wuzhong Zone Suzhou ,Jiangsu,China  
215128

## Manufacturer Information

Company Name: Tineco Intelligent Technology Co.,Ltd.  
Address: No. 108 Shihu Road West, Wuzhong Zone Suzhou ,Jiangsu,China  
215128

## EUT Description

Product Name: SMART VACUUM CLEANER  
Model Number: VS1B0100US  
Sample Number: 5947707  
Data of Receipt Sample: Apr. 04, 2023  
Date Tested: Apr. 04, 2023~ May 28, 2023

APPLICABLE STANDARDS	
STANDARD	TEST RESULTS
CFR 47 Part 15 Subpart C	PASS
ISED RSS-247 Issue 2	PASS
ISED RSS-GEN Issue 5	PASS

Summary of Test Results			
Clause	Test Items	FCC Rules	Test Results
1	6dB Bandwidth and 99% Occupied Bandwidth	FCC 15.247 (a) (2) RSS-247 Clause 5.2 (a) RSS-Gen Clause 6.7	PASS
2	Conducted Power	FCC 15.247 (b) (3) RSS-247 Clause 5.4 (d) RSS-Gen Clause 6.12	PASS
3	Power Spectral Density	FCC 15.247 (e) RSS-247 Clause 5.2 (b)	PASS
4	Conducted Band edge And Spurious emission	FCC 15.247 (d) RSS-247 Clause 5.5 RSS-GEN Clause 6.13	PASS
5	Radiated Band edges and Spurious emission	FCC 15.247 (d) FCC 15.209 FCC 15.205 RSS-247 Clause 5.5 RSS-GEN Clause 8.9 RSS-GEN Clause 6.13	PASS
6	Conducted Emission Test for AC Power Port	FCC 15.207 RSS-GEN Clause 8.8	PASS
7	Antenna Requirement	FCC 15.203 RSS-GEN Clause 6.8	PASS
<p>Note: The measurement result for the sample received is &lt;Pass&gt; according to &lt; ANSI C63.10-2013, FCC CFR 47 Part 2, FCC CFR 47 Part 15C, RSS-Gen and RSS 247&gt; when &lt;Accuracy Method&gt; decision rule is applied.</p>			

Prepared By:

*Tom Tang*

Tom Tang

Reviewed By:

*Leon Wu*

Leon Wu

Authorized By:

*Chris Zhong*

Chris Zhong  
EMC&RF Lab Operations Manager

## 2. TEST METHODOLOGY

The tests documented in this report were performed in accordance with KDB 558074 D01 15.247 Meas Guidance v05r02, 414788 D01 Radiated Test Site v01r01, CFR 47 FCC Part 2, CFR 47 FCC Part 15, ANSI C63.10-2013, ISED RSS-247 Issue 2 and ISED RSS-GEN Issue 5.

## 3. FACILITIES AND ACCREDITATION

Accreditation Certificate	<p><b>A2LA (Certificate No.: 4829.01)</b>  <b>UL-CCIC COMPANY LIMITED has been assessed and proved to be in compliance with A2LA.</b></p> <p><b>FCC (FCC Designation No.: CN1247)</b>  <b>UL-CCIC COMPANY LIMITED has been recognized to perform compliance testing on equipment subject to the Commission's Declaration of Conformity (DoC) and Certification rules.</b></p> <p><b>IC (IC Designation No.: 25056; CAB No.: CN0073)</b>  <b>UL-CCIC COMPANY LIMITED has been recognized to perform compliance testing on equipment subject to the Commission's Declaration of Conformity (DoC) and Certification rules.</b></p>
---------------------------	---

Note 1: All tests measurement facilities use to collect the measurement data are located at No. 2, Chengwan Road, Suzhou Industrial Park, Suzhou 215122, China

Note 2: For below 30MHz, lab had performed measurements at test anechoic chamber and comparing to measurements obtained on an open field site. These measurements below 30MHz had been correlated to measurements performed on an OFS.

Note 3: The test anechoic chamber in UL-CCIC COMPANY LIMITED had been calibrated and compared to the open field sites and the test anechoic chamber is shown to be equivalent to or worst case from the open field site.

## 4. CALIBRATION AND UNCERTAINTY

### 4.1. MEASURING INSTRUMENT CALIBRATION

The measuring equipment utilized to perform the tests documented in this report has been calibrated in accordance with the manufacturer's recommendations and is traceable to recognized national standards.

### 4.2. MEASUREMENT UNCERTAINTY

Where relevant, the following measurement uncertainty levels have been estimated for tests performed on the apparatus:

Test Item	Uncertainty
Conduction emission	3.1dB
Radiation Emission test(include Fundamental emission) (9KHz-30MHz)	3.4dB
Radiation Emission test(include Fundamental emission) (30MHz-1GHz)	3.4dB
Radiation Emission test (1GHz to 26GHz)( include Fundamental emission)	3.5dB (1GHz-18Gz)
	3.9dB (18GHz-26.5Gz)
Note: This uncertainty represents an expanded uncertainty expressed at approximately the 95% confidence level using a coverage factor of k=2.	

## 5. EQUIPMENT UNDER TEST

### 5.1. DESCRIPTION OF EUT

Product Name:	SMART VACUUM CLEANER
Model No.:	VS1B0100US
Operating Frequency:	IEEE 802.11B/G/N/AX(HT20): 2412MHz to 2462MHz IEEE 802.11N(HT40): 2422MHz to 2452MHz
Type of Modulation:	IEEE for 802.11B: DSSS (CCK, DQPSK, DBPSK) IEEE for 802.11G: OFDM (64QAM, 16QAM, QPSK, BPSK) IEEE for 802.11N(HT20 and HT40): OFDM (64QAM, 16QAM, QPSK, BPSK) IEEE for 802.11AX20: OFDMA (BPSK, QPSK, 16QAM, 64QAM, 256QAM, 1024QAM)
Channels Step:	Channels with 5MHz step
Test software of EUT:	RD Tool
Antenna Type:	PCB antenna
Antenna Gain:	-0.66 dBi
	Note: This data is provided by customer and our lab isn't responsible for this data.



## 5.2. MAXIMUM OUTPUT POWER

Number of Transmit Chains (NTX)	IEE Std. 802.11	Channel Number	Max AVG Conducted Power (dBm)
1	IEEE 802.11B	1-11[11]	12.15
1	IEEE 802.11G	1-11[11]	14.75
1	IEEE 802.11N HT20	1-11[11]	14.54
1	IEEE 802.11N HT40	3-9[7]	13.48
1	IEEE 802.11AX20	1-11[11]	12.33

## 5.3. CHANNEL LIST

Channel List for 802.11B/G/N/AX(20 MHz)							
Channel	Frequency (MHz)	Channel	Frequency (MHz)	Channel	Frequency (MHz)	Channel	Frequency (MHz)
1	2412	4	2427	7	2442	10	2457
2	2417	5	2432	8	2447	11	2462
3	2422	6	2437	9	2452		

Channel List for 802.11N(40 MHz)							
Channel	Frequency (MHz)	Channel	Frequency (MHz)	Channel	Frequency (MHz)	Channel	Frequency (MHz)
3	2422	5	2432	7	2442	9	2452
4	2427	6	2437	8	2447		

#### 5.4. TEST CHANNEL CONFIGURATION

Test Mode	Test Channel (MHz)
IEEE 802.11B	LCH: CH01 2412
	MCH: CH06 2437
	HCH: CH11 2462
IEEE 802.11G	LCH: CH01 2412
	MCH: CH06 2437
	HCH: CH11 2462
IEEE 802.11N HT20	LCH: CH01 2412
	MCH: CH06 2437
	HCH: CH11 2462
IEEE 802.11N HT40	LCH: CH03 2422
	MCH: CH06 2437
	HCH: CH09 2452
IEEE 802.11AX20	LCH: CH01 2412
	MCH: CH06 2437
	HCH: CH11 2462

#### 5.5. THE WORSE CASE POWER SETTING PARAMETER

The Worse Case Power Setting Parameter under 2400 ~ 2483.5MHz Band							
Test Software		RD Tool					
Modulation Mode	Transmit Antenna Number	Test Channel					
		NCB: 20MHz			NCB: 40MHz		
		CH 1	CH 6	CH 11	CH 3	CH 6	CH 9
802.11B	1	default	default	default	/		
802.11G	1	default	default	default			
802.11N HT20	1	default	default	default			
802.11N HT40	1	/			default	default	default
802.11AX20	1	default	default	default	/		

### 5.6. DESCRIPTION OF AVAILABLE ANTENNAS

Ant.	Frequency (MHz)	Antenna Type	Antenna Gain (dBi)
1	2400-2483.5	PCB antenna	-0.66

Note: This data is provided by customer and our lab isn't responsible for this data.

Test Mode	Transmit and Receive Mode	Description
IEEE 802.11B	<input checked="" type="checkbox"/> 1TX, 1RX	Antenna1 can be used as transmitting/receiving antenna independently.
IEEE 802.11G	<input checked="" type="checkbox"/> 1TX, 1RX	Antenna1 can be used as transmitting/receiving antenna independently.
IEEE 802.11N HT20	<input checked="" type="checkbox"/> 1TX, 1RX	Antenna1 can be used as transmitting/receiving antenna independently.
IEEE 802.11N HT40	<input checked="" type="checkbox"/> 1TX, 1RX	Antenna1 can be used as transmitting/receiving antenna independently.
IEEE 802.11AX20	<input checked="" type="checkbox"/> 1TX, 1RX	Antenna1 can be used as transmitting/receiving antenna independently.

### 5.7. THE WORSE CASE CONFIGURATIONS

For WIFI module, the worst-case data rates as provided by the client were:

802.11B mode: 1 Mbps

802.11G mode: 6 Mbps

802.11N HT20 mode: MCS0

802.11N HT40 mode: MCS0

802.11AX20 mode: MCS0

## 5.8. DESCRIPTION OF TEST SETUP

### SUPPORT EQUIPMENT

Item	Equipment	Brand Name	Model Name	Description
1	Laptop	ThinkPad	E590	N/A
2	Fixed Frequency Board	N/A	N/A	Supply by Customer
3	USB Cable	N/A	N/A	Supply by UL Lab(100cm length)
4	AC Adapter	Class 2 Power Supply	KL-WA180100-V	Supply by Customer

### I/O PORT

Cable No	Port	Connector Type	Cable Type	Cable Length(m)	Remarks
1	N/A	N/A	N/A	N/A	N/A

### ACCESSORY

Item	Accessory	Brand Name	Model Name	Description
1	CLEAN STATION	CLEAN STATION	AA2237	AC120V, 60Hz, 4.2A
2	CLEAN STATION	CLEAN STATION	AA2311	AC120V, 60Hz, 4.2A

Remark: Pre-testing with these accessories and AC adapter, only the data of the worst case (Charging with AA2237 model CLEAN STATION) is included in this report.

**TEST SETUP**

The EUT can work in an engineer mode with a software through a table PC.

**SETUP DIAGRAM FOR TESTS**

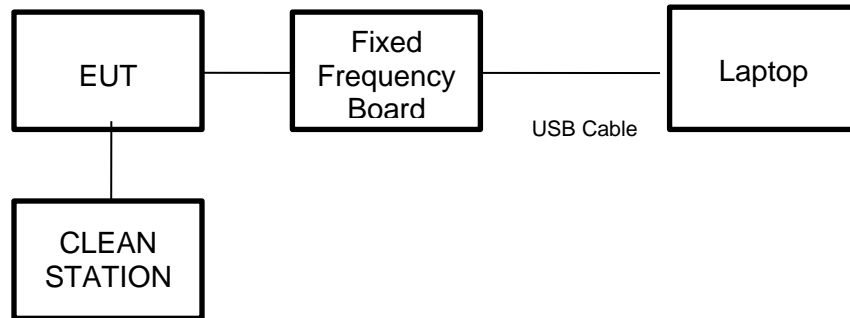

### 5.9. MEASURING INSTRUMENT AND SOFTWARE USED

Conducted Emissions (Instrument)							
Used	Equipment	Manufacturer	Model No.	Serial No.	Upper Last Cal.	Last Cal.	Next Cal.
<input checked="" type="checkbox"/>	EMI Test Receiver	R&S	ESR3	126700	2021-12-04	2022-12-19	2023-12-18
<input checked="" type="checkbox"/>	Two-Line V-Network	R&S	ENV216	126701	2021-12-04	2022-12-03	2023-12-02
Software							
Used	Description		Manufacturer	Name	Version		
<input checked="" type="checkbox"/>	Test Software for Conducted disturbance		R&S	EMC32	Ver. 9.25		
Radiated Emissions (Instrument)							
Used	Equipment	Manufacturer	Model No.	Serial No.	Upper Last Cal.	Last Cal.	Next Cal.
<input checked="" type="checkbox"/>	Spectrum Analyzer	Keysight	N9010B	155727	2022-04-09	2023-04-08	2024-04-07
<input checked="" type="checkbox"/>	EMI test receiver	R&S	ESR7	221694	2022-05-20	2023-04-08	2024-04-07
<input checked="" type="checkbox"/>	EMI test receiver	R&S	ESR26	126703	2020-12-05	2022-12-03	2023-12-02
<input checked="" type="checkbox"/>	Receiver Antenna (9kHz-30MHz)	Schwarzbeck	FMZB 1513	155456	2018-06-15	2021-06-03	2024-06-02
<input checked="" type="checkbox"/>	Receiver Antenna (30MHz-1GHz)	Schwarzbeck	VULB 9163	126704	2019-02-15	2022-01-18	2025-01-17
<input checked="" type="checkbox"/>	Receiver Antenna (1GHz-18GHz)	R&S	HF907	126705	2018-01-29	2022-02-28	2025-02-27
<input checked="" type="checkbox"/>	Receiver Antenna (18GHz-26.5GHz)	ETS	3160-10	155565	2019-01-05	2021-07-15	2024-07-14
<input checked="" type="checkbox"/>	Pre-amplification (To 18GHz)	R&S	SCU-18D	134667	2021-12-04	2022-12-03	2023-12-02
<input checked="" type="checkbox"/>	Pre-amplification (To 18GHz)	Tonsend	TAP01018050	224539	/	2022-10-20	2023-10-19
<input checked="" type="checkbox"/>	Pre-amplification (To 26.5GHz)	R&S	SCU-26D	135391	2021-12-05	2022-12-03	2023-12-02
<input checked="" type="checkbox"/>	Band Reject Filter	Wainwright	WRCJV8-2350-2400-2483.5-2533.5-40SS	1	2022-04-09	2023-04-08	2024-04-07
<input checked="" type="checkbox"/>	Highpass Filter	Wainwright	WHKX10-2700-3000-18000-40SS	2	2022-04-09	2023-04-08	2024-04-07
<input checked="" type="checkbox"/>	Attenuator	Wainwright	BW-N1-W5+	3	2022-04-09	2023-04-08	2024-04-07
<input checked="" type="checkbox"/>	Chamber A	Albatross	9*6*6	126721	2019-05-31	2022-05-30	2025-05-29
<input checked="" type="checkbox"/>	Chamber B	SAEMC	9*6*6	220350	/	2022-07-03	2025-06-01
<input checked="" type="checkbox"/>	Temperature and Humidity Datalogger	Omega Engineering Inc.	iTHX-SD-5	183135	/	2022-07-20	2023-07-19
Software							
Used	Description		Manufacturer	Name	Version		
<input checked="" type="checkbox"/>	Test Software for Radiated disturbance		Tonscend	JS36-RSE	4.0.0.1		

**Other instruments**

Used	Equipment	Manufacturer	Model No.	Serial No.	Upper Last Cal.	Last Cal.	Next Cal.
<input checked="" type="checkbox"/>	Spectrum Analyzer	Keysight	N9010B	155368	2022-04-09	2023-04-08	2024-04-07
<input checked="" type="checkbox"/>	Attenuator	PASTERNAK	PE7087-6	1624	2022-05-23	2023-04-08	2024-04-07
<input checked="" type="checkbox"/>	Shielding Room	Albatross	/	126723	2019-12-27	2022-05-30	2025-05-29
<input checked="" type="checkbox"/>	Temperature and Humidity Datalogger	Omega Engineering Inc.	iTHX-SD-5	199847	2021-10-15	2022-10-14	2023-10-13

## 6. MEASUREMENT METHODS

No.	Test Item	KDB Name	Section
1	6dB Bandwidth	KDB 558074 D01 15.247 Meas Guidance v05r02	8.2
2	Conducted Output Power	KDB 558074 D01 15.247 Meas Guidance v05r02	8.3.2.2 (Method AVGSA-2)
3	Power Spectral Density	KDB 558074 D01 15.247 Meas Guidance v05r02	8.4 (Method PKPSD)
4	Out-of-band emissions in non-restricted bands	KDB 558074 D01 15.247 Meas Guidance v05r02	8.5
5	Out-of-band emissions in restricted bands	KDB 558074 D01 15.247 Meas Guidance v05r02	8.6
6	Band-edge	KDB 558074 D01 15.247 Meas Guidance v05r02	8.7
7	Conducted Emission Test For AC Power Port	ANSI C63.10-2013	6.2



## 7. ANTENNA PORT TEST RESULTS

### 7.1. ON TIME AND DUTY CYCLE

#### LIMITS

None; for reporting purposes only

#### PROCEDURE

FCC KDB 558074 Zero-Span Spectrum Analyzer Method

#### TEST SETUP

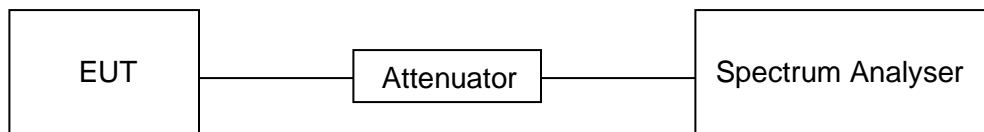

#### TEST ENVIRONMENT

Temperature	22.3°C	Relative Humidity	47.8%
Atmosphere Pressure	102.1kpa	Test Voltage	AC120V/60Hz

#### TEST RESULTS TABLE

Mode	On Time (msec)	Period (msec)	Duty Cycle x (Linear)	Duty Cycle (%)	Duty Cycle Correction Factor (db)	1/T Minimum VBW (kHz)	Final VBW (kHz)
11B	100	100	1	100	0	0.01	0.01
11G	100	100	1	100	0	0.01	0.01
802.11N HT20	100	100	1	100	0	0.01	0.01
802.11N HT40	100	100	1	100	0	0.01	0.01
802.11AX20	100	100	1	100	0	0.01	0.01

- Note: 1) Duty Cycle Correction Factor=10log(1/x).  
 2) Where: x is Duty Cycle (Linear)  
 3) Where: T is On Time (transmit duration)  
 4) If the duty cycle is above 98%, the Final VBW is 10Hz.

**TEST GRAPHS**

**11B ON TIME AND DUTY CYCLE MID CH (WORSE CASE)**

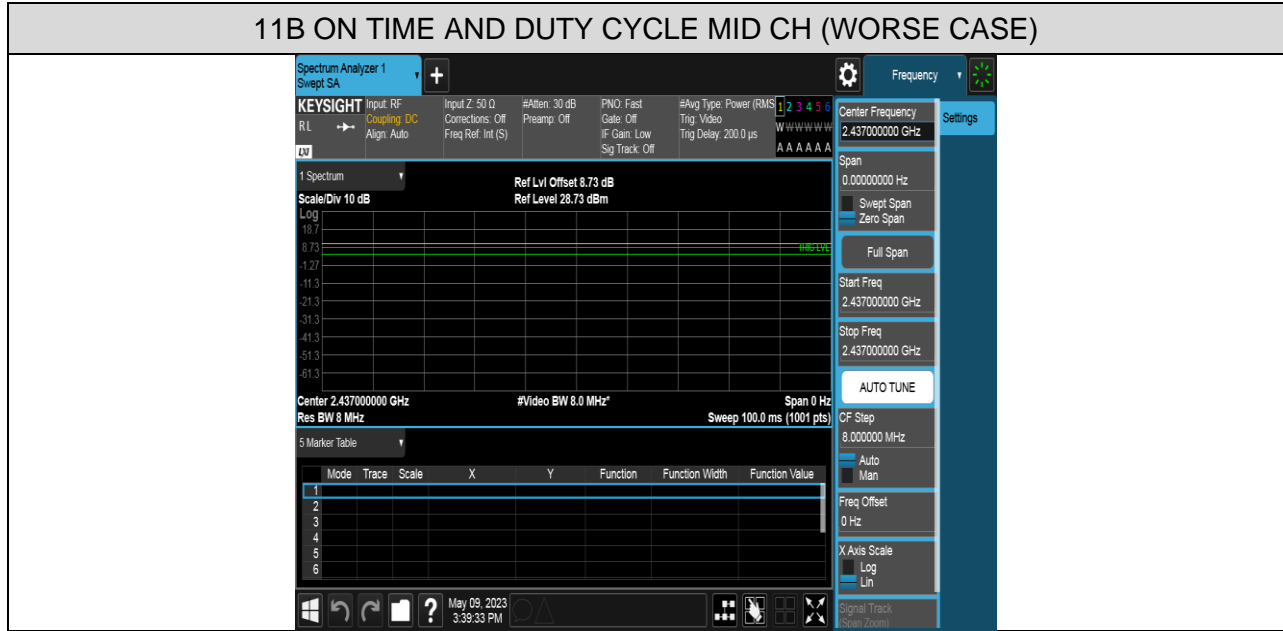

**11G ON TIME AND DUTY CYCLE MID CH (WORSE CASE)**

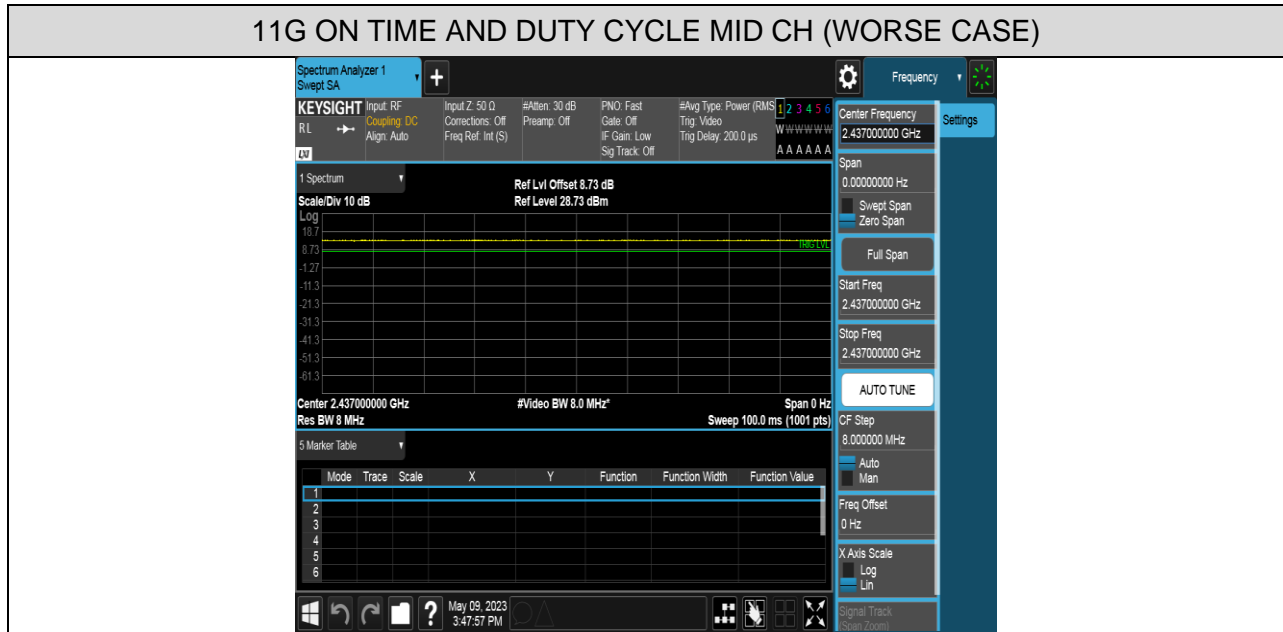

### 11N HT20 ON TIME AND DUTY CYCLE MID CH (WORSE CASE)



### 11N HT40 ON TIME AND DUTY CYCLE MID CH (WORSE CASE)

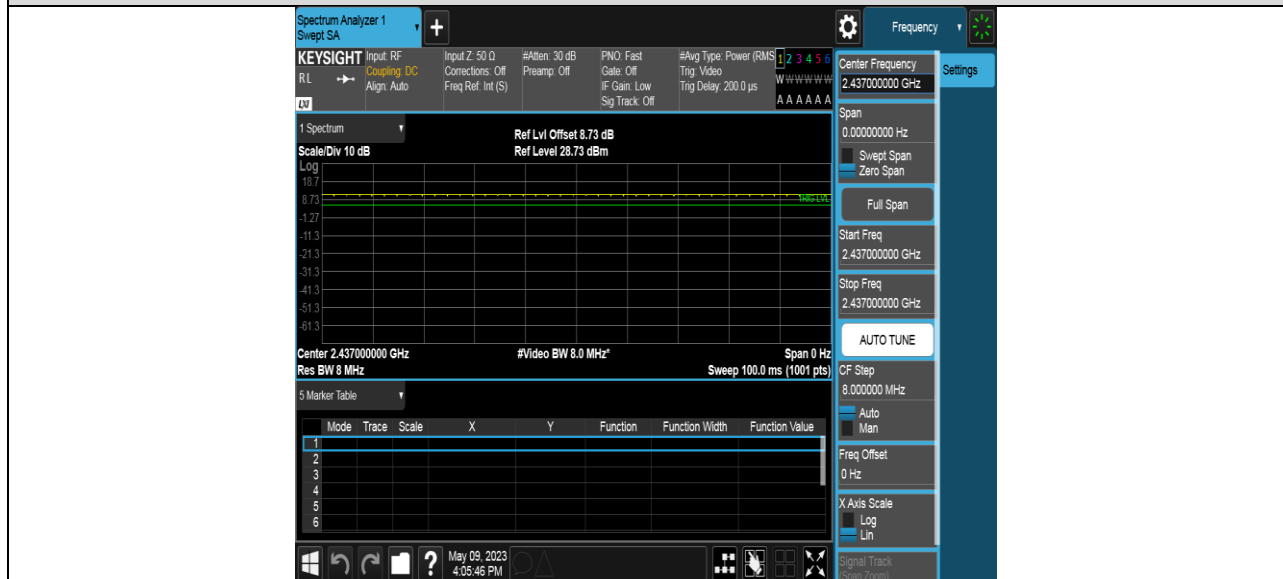

11AX20 ON TIME AND DUTY CYCLE MID CH (WORSE CASE)

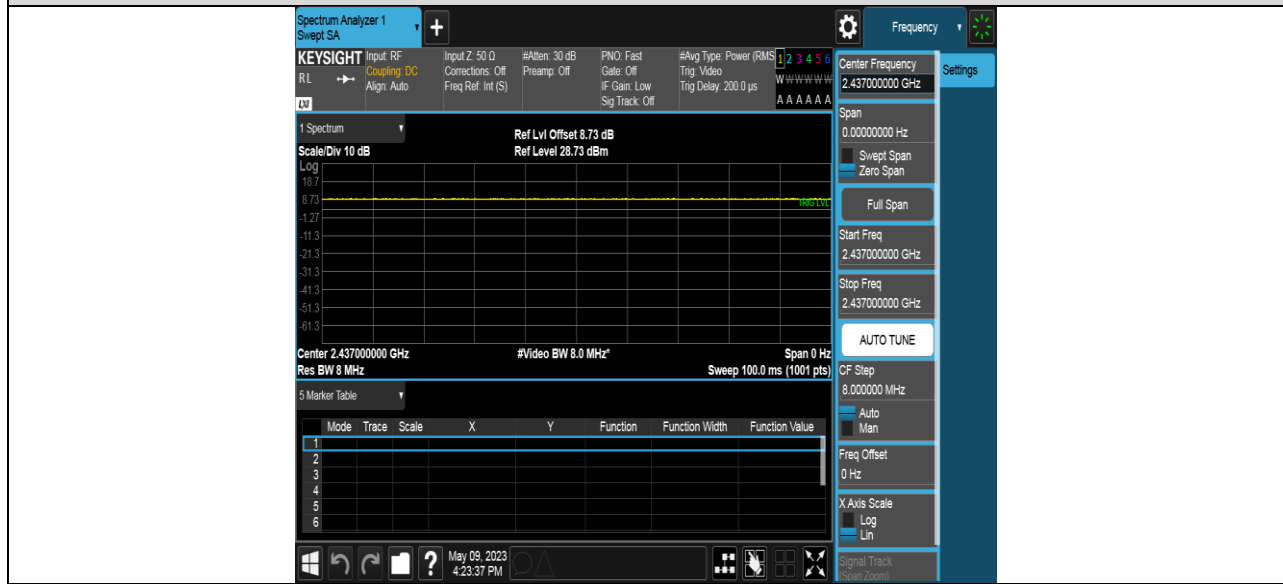

## 7.2. 6 dB BANDWIDTH AND 99% OCCUPIED BANDWIDTH

### LIMITS

FCC Part15 (15.247) Subpart C, ISED RSS-Gen			
Section	Test Item	Limit	Frequency Range (MHz)
CFR 47 FCC 15.247(a)(2) ISED RSS-247 5.2 (a)	6dB Bandwidth	$\geq 500\text{kHz}$	2400-2483.5
ISED RSS-Gen Clause 6.7	99 % Occupied Bandwidth	For reporting purposes only	2400-2483.5

### TEST PROCEDURE

Refer to ANSI C63.10-2013 clause 11.8 for DTS bandwidth and clause 6.9 for Occupied Bandwidth.

Connect the EUT to the spectrum analyser and use the following settings:

Center Frequency	The centre frequency of the channel under test
Detector	Peak
RBW	For 6 dB Bandwidth: 100 kHz For 99 % Occupied Bandwidth: 1 % to 5 % of the occupied bandwidth
VBW	For 6 dB Bandwidth: $\geq 3 \times \text{RBW}$ For 99 % Occupied Bandwidth: $\geq 3 \times \text{RBW}$
Trace	Max hold
Sweep	Auto couple

a) Use the 99 % power bandwidth function of the instrument, allow the trace to stabilize and report the measured bandwidth.

b) Allow the trace to stabilize and measure the maximum width of the emission that is constrained by the frequencies associated with the two outermost amplitude points (upper and lower frequencies) that are attenuated by 6 dB relative to the maximum level measured in the fundamental emission.

**TEST SETUP**

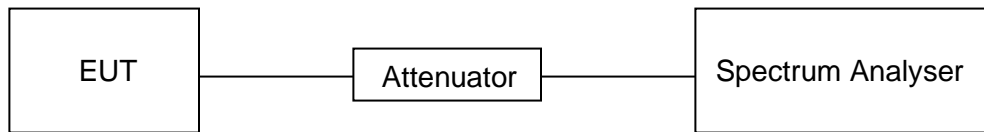

**TEST ENVIRONMENT**

Temperature	22.3°C	Relative Humidity	47.8%
Atmosphere Pressure	102.1kpa	Test Voltage	AC120V/60Hz

**TEST RESULTS TABLE**

Test Mode	Test Channel	6dB bandwidth (MHz)	99% bandwidth (MHz)	Result
11B	LCH	9.103	15.149	Pass
	MCH	9.095	15.040	Pass
	HCH	9.100	15.045	Pass
11G	LCH	5.263	15.387	Pass
	MCH	5.063	15.297	Pass
	HCH	5.032	15.294	Pass
11N HT20	LCH	5.001	16.462	Pass
	MCH	5.781	16.372	Pass
	HCH	6.929	16.375	Pass
11N HT40	LCH	7.536	33.067	Pass
	MCH	10.091	32.824	Pass
	HCH	8.560	33.123	Pass
11AX20	LCH	16.177	18.897	Pass
	MCH	15.473	18.870	Pass
	HCH	17.573	18.860	Pass

**TEST GRAPHS**

**For 6dB Bandwidth Part:**

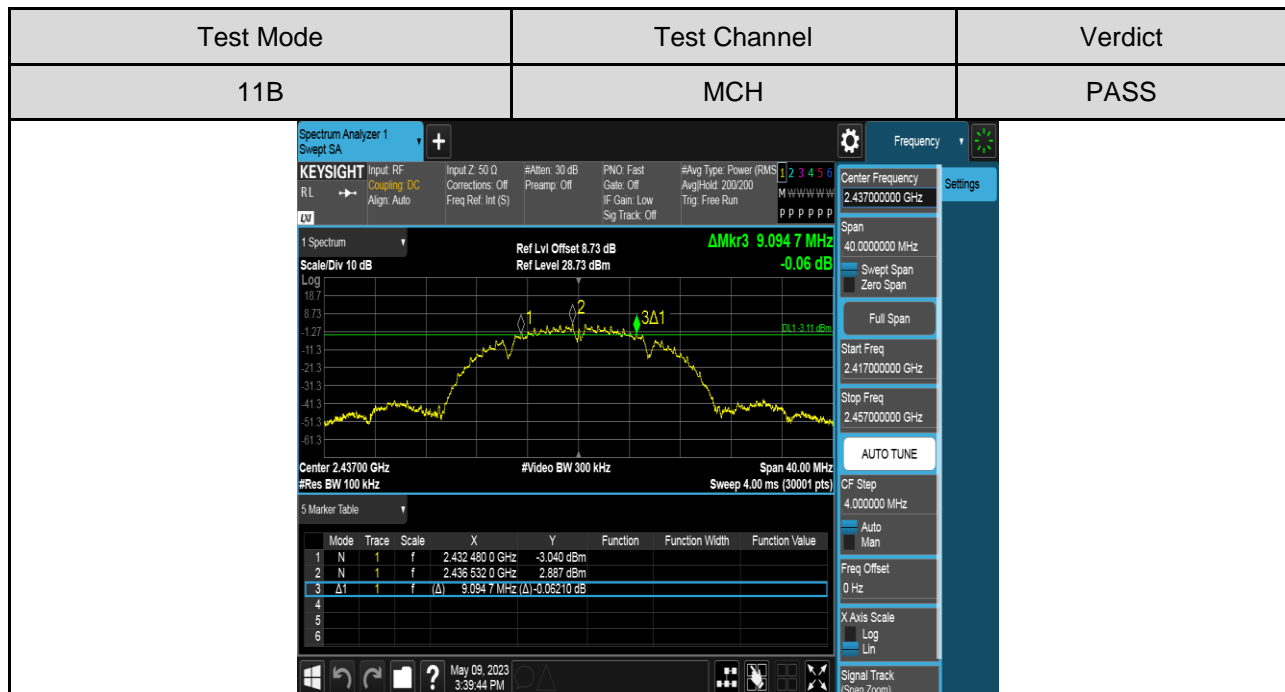
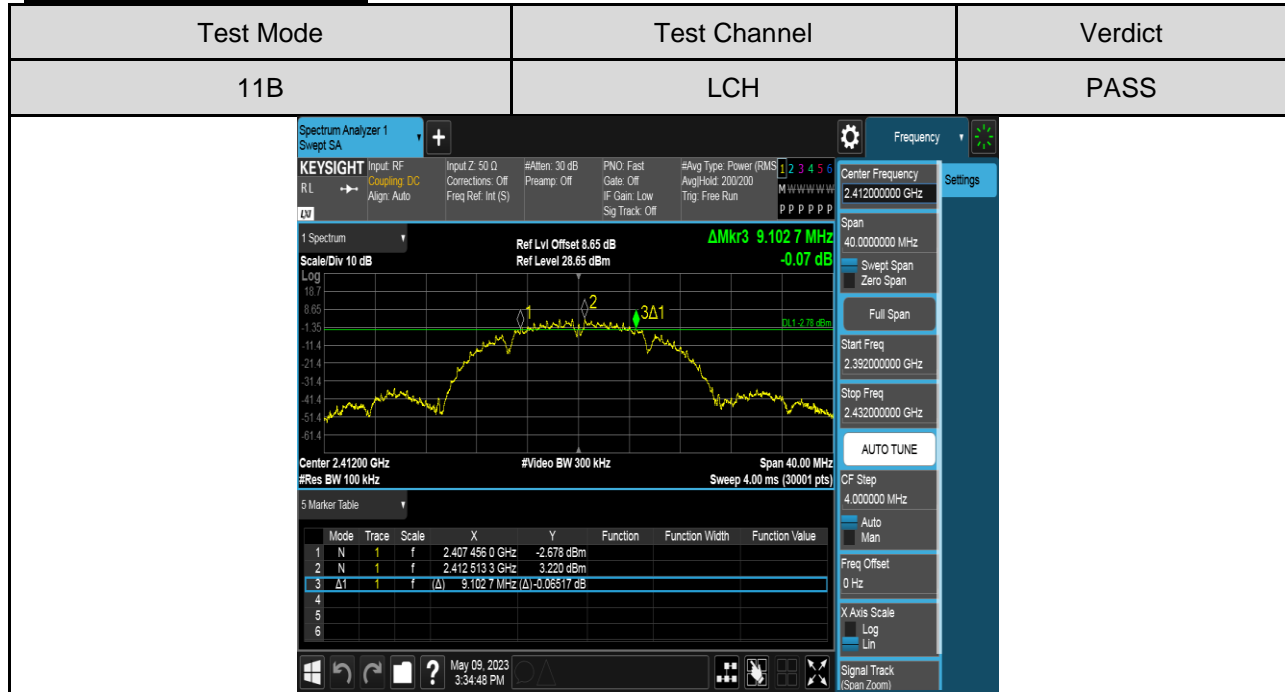

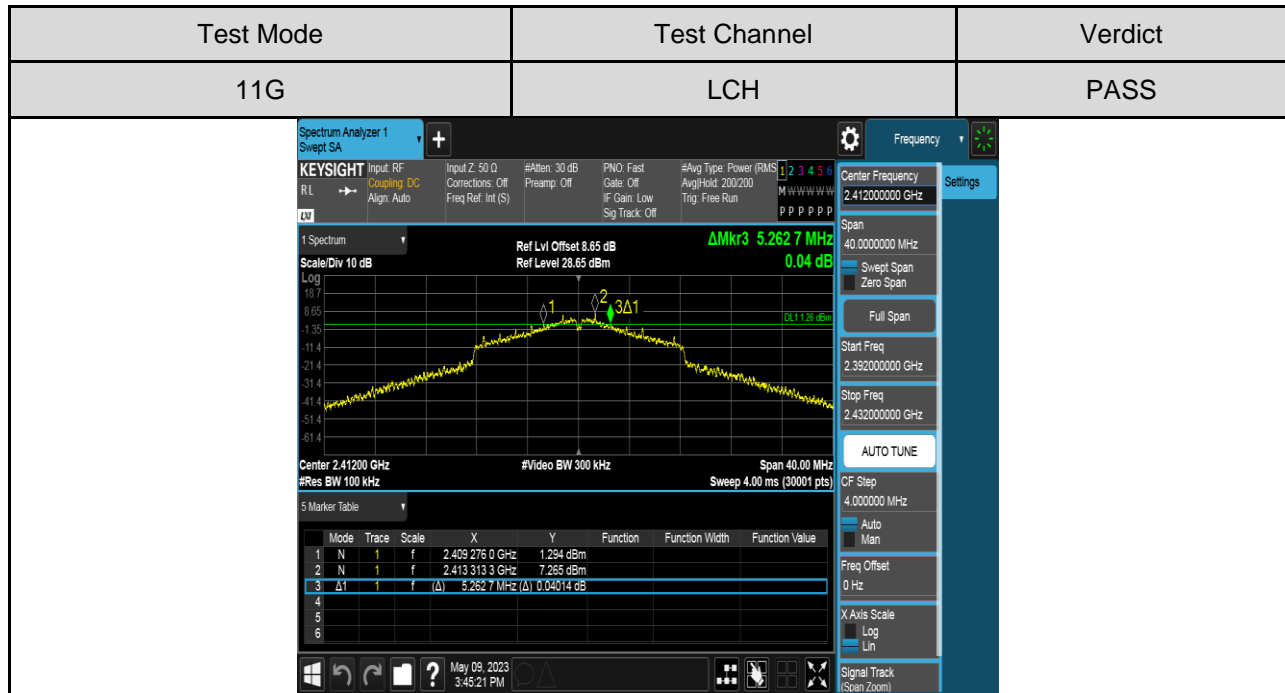
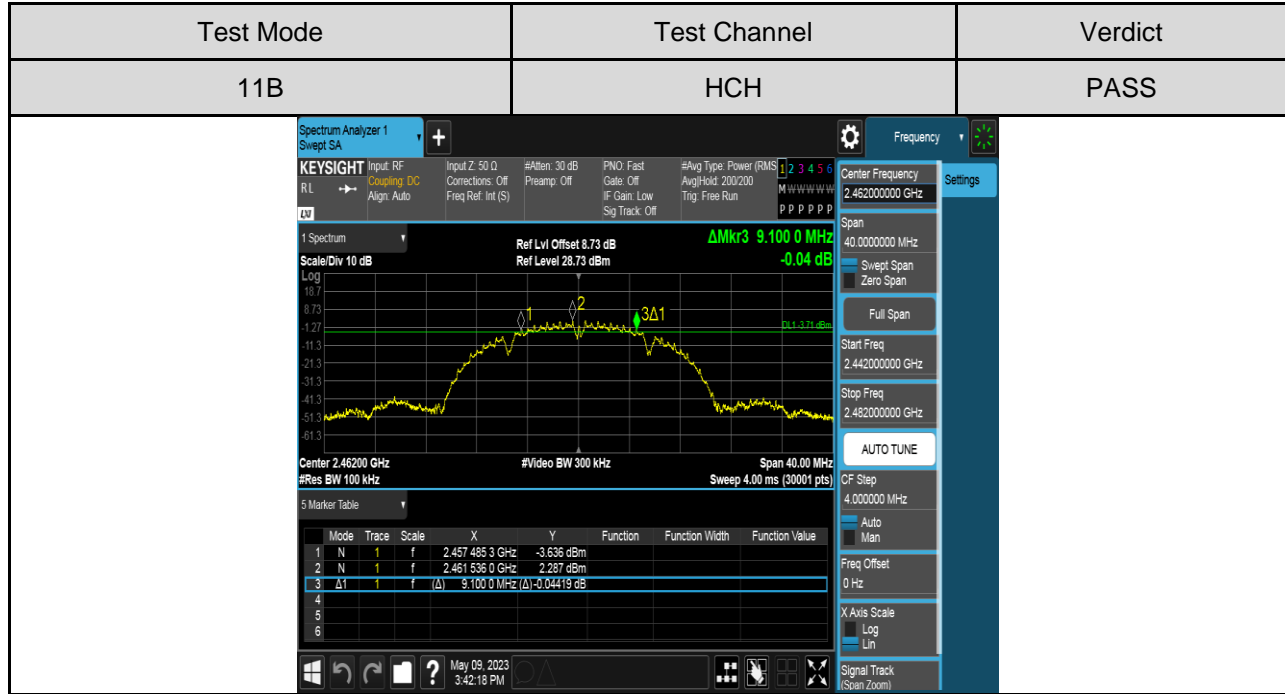



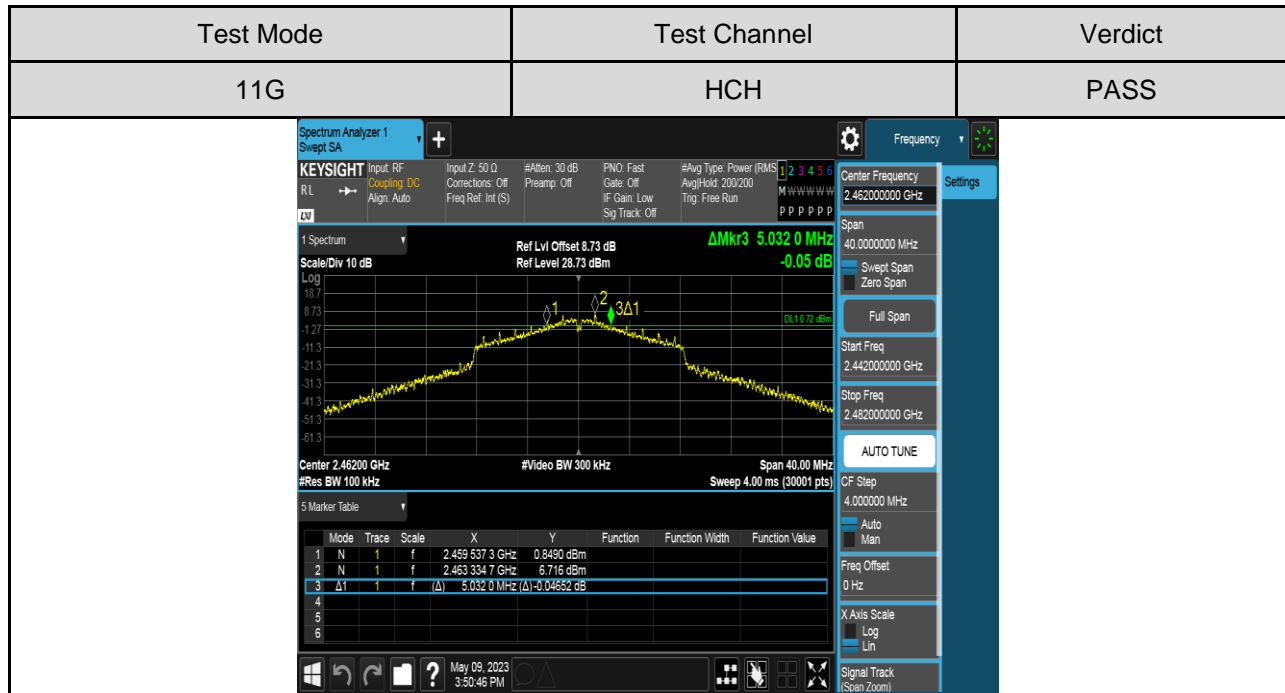
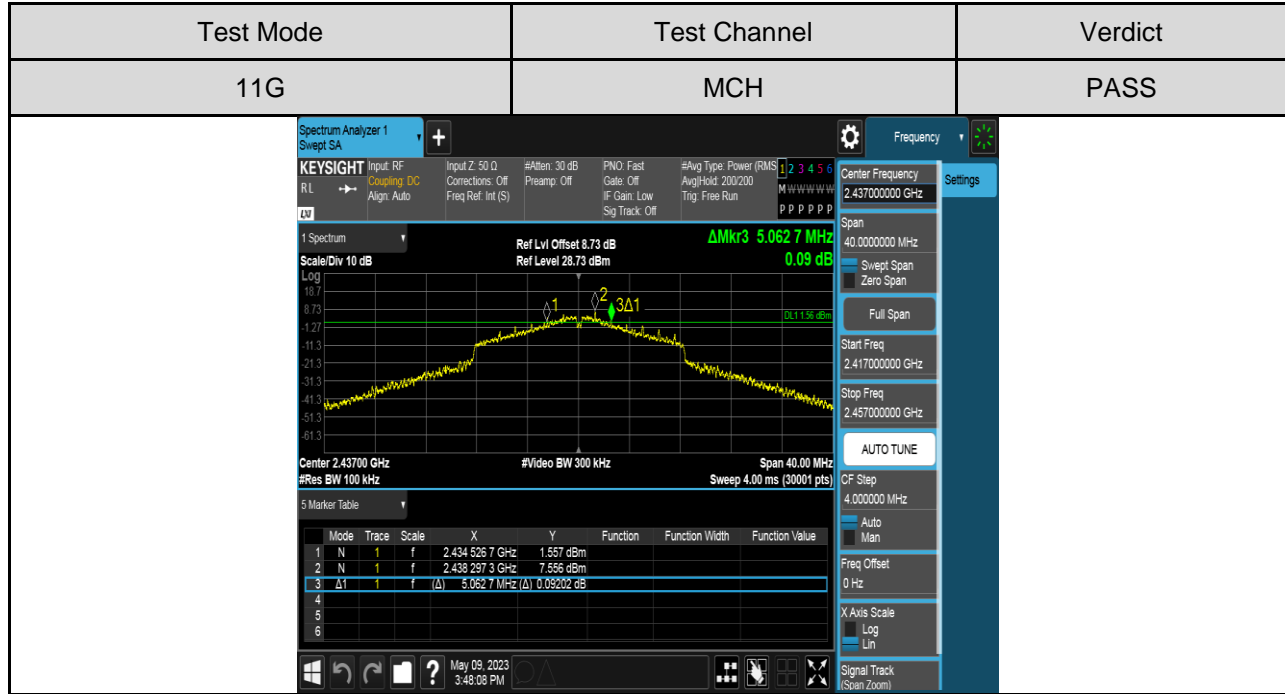

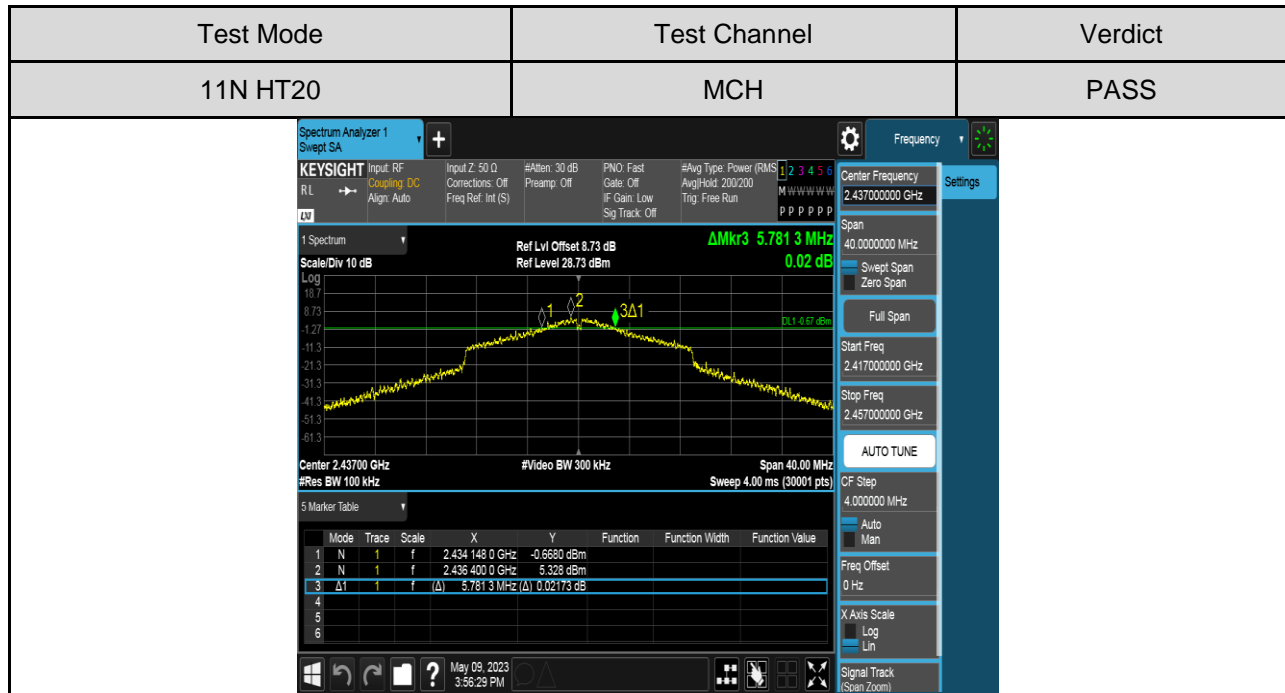
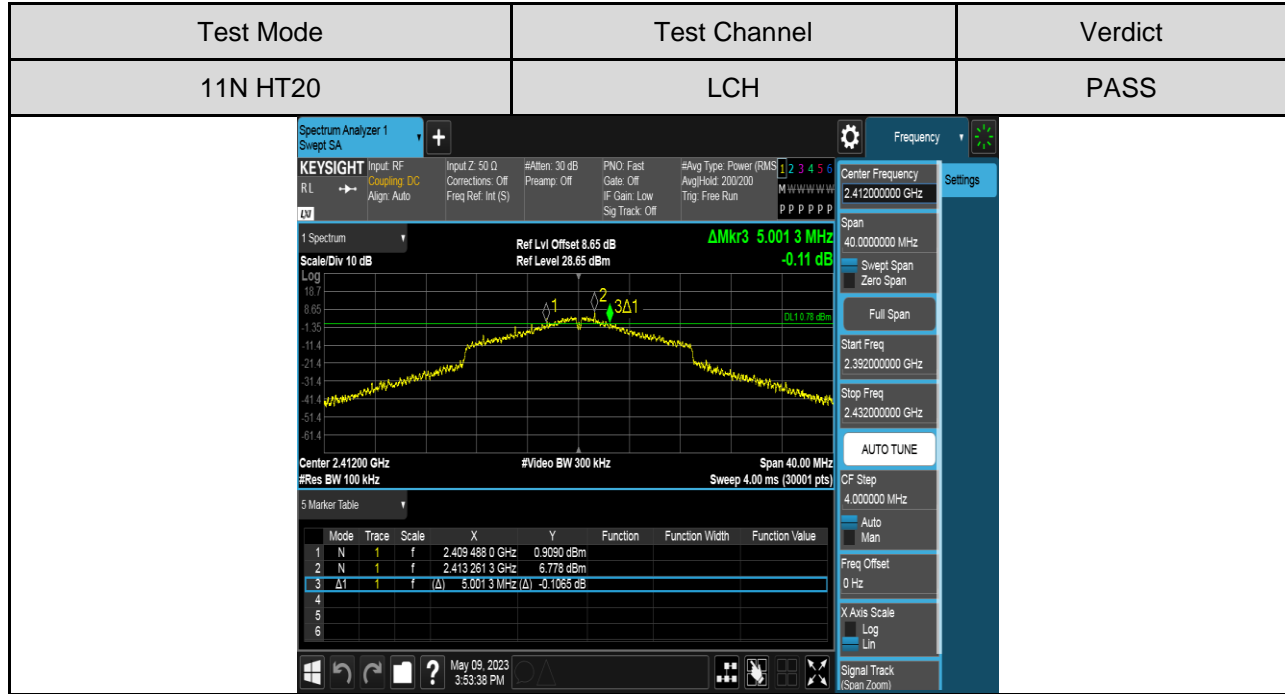

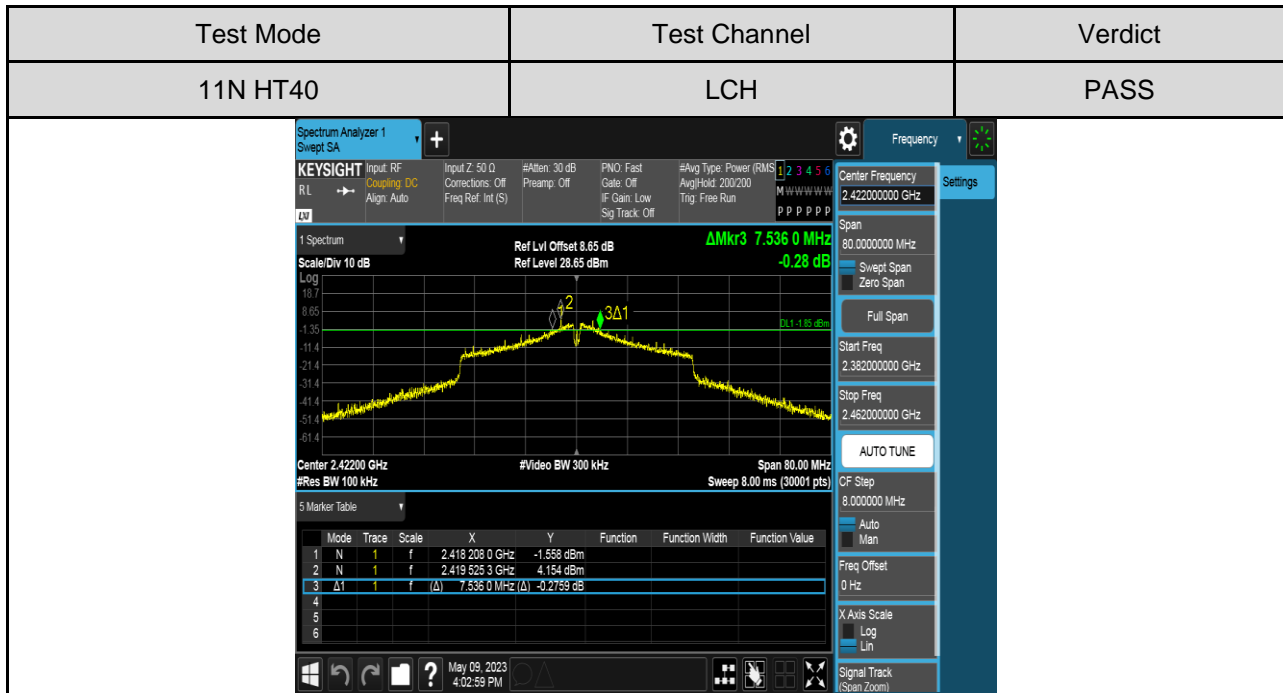
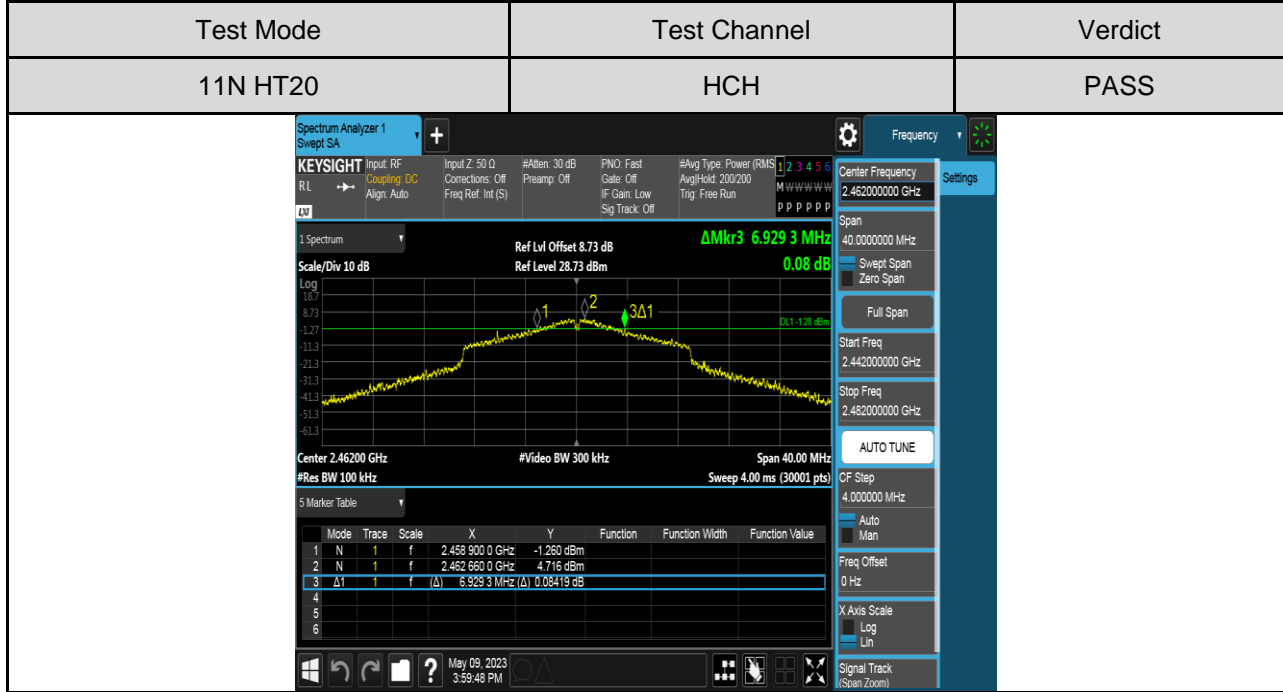



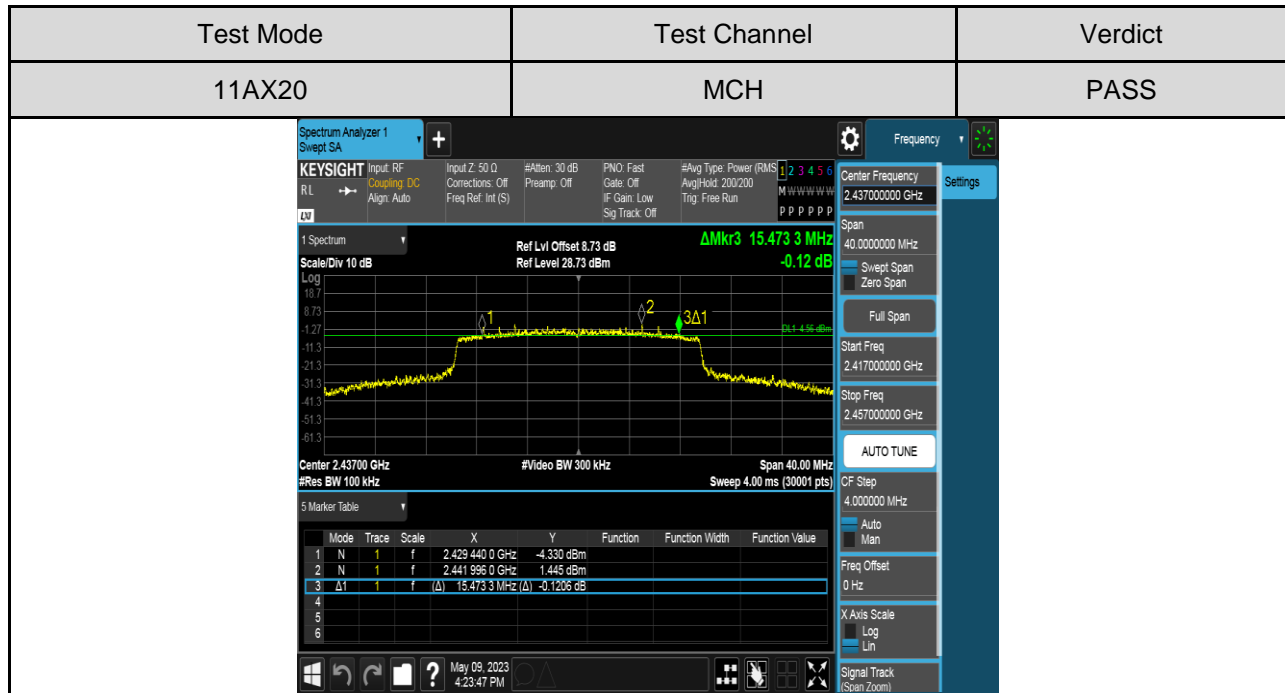
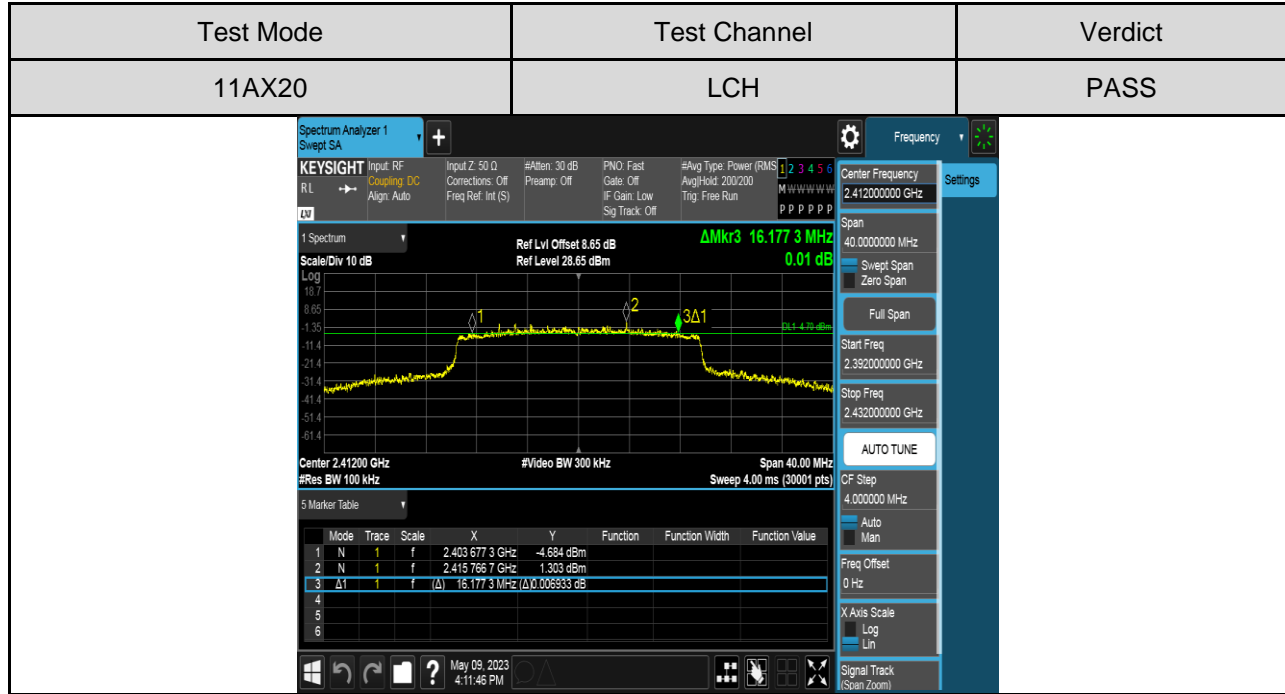

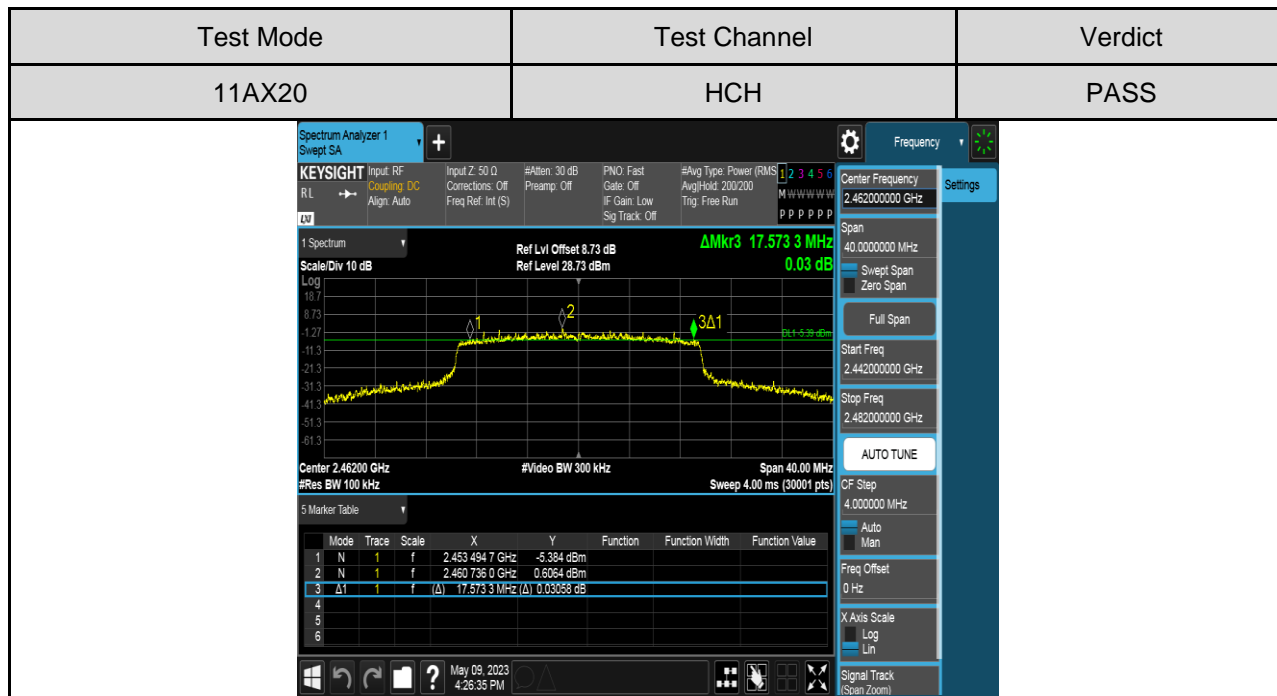

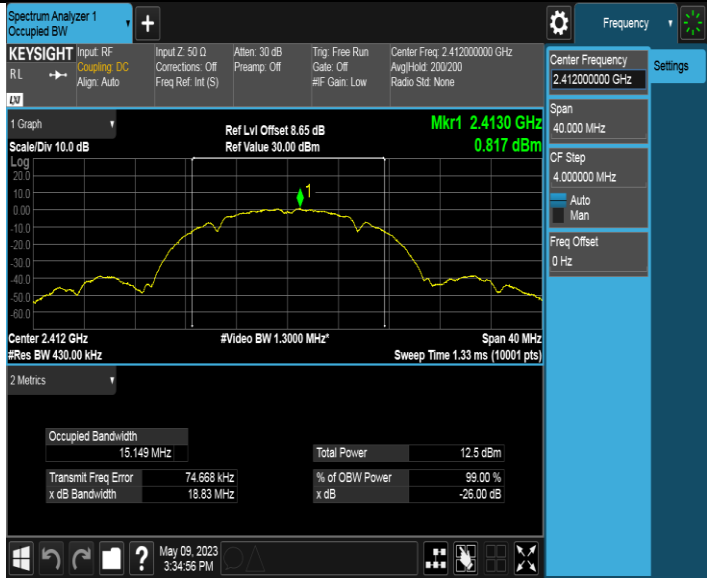

**For 99% Bandwidth Part:**

Test Mode	Test Channel	Verdict
11B	LCH	PASS
		

Test Mode	Test Channel	Verdict
11B	MCH	PASS
		

Test Mode	Test Channel	Verdict
11B	HCH	PASS
 <p><b>Keysight Spectrum Analyzer 1</b>  <b>Occupied BW</b>          Input: RF, Input Z: 50 Ω, Atten: 30 dB, Trig: Free Run, Center Freq: 2.46200000 GHz          R/L → Coupling: DC, Corrections: Off, Preamp: Off, Gate: Off, Avg/Hold: 200/200          Align: Auto, Freq Ref: Int (S), #F Gain: Low, Radio Std: None</p> <p>Center Frequency: 2.46200000 GHz          Span: 40.000 MHz          CF Step: 4.000000 MHz          Freq Offset: 0 Hz</p> <p>1 Graph          Scale Div: 10.0 dB          Log          Ref Lvl Offset: 8.73 dB          Ref Value: 30.00 dBm          Mkr1: 2.4612 GHz          -0.027 dBm</p> <p>Center: 2.462 GHz #Video BW: 1.3000 MHz* Span: 40 MHz          #Res BW: 430.00 kHz Sweep Time: 1.33 ms (10001 pts)</p> <p>2 Metrics          Occupied Bandwidth: 15.045 MHz Total Power: 11.7 dBm          Transmit Freq Error: 52.172 kHz % of OBW Power: 99.00 %          x dB Bandwidth: 18.81 MHz x dB: -26.00 dB</p> <p>May 09, 2023 3:42:27 PM</p>		

Test Mode	Test Channel	Verdict
11G	LCH	PASS
 <p><b>Keysight Spectrum Analyzer 1</b>  <b>Occupied BW</b>          Input: RF, Input Z: 50 Ω, Atten: 30 dB, Trig: Free Run, Center Freq: 2.41200000 GHz          R/L → Coupling: DC, Corrections: Off, Preamp: Off, Gate: Off, Avg/Hold: 200/200          Align: Auto, Freq Ref: Int (S), #F Gain: Low, Radio Std: None</p> <p>Center Frequency: 2.41200000 GHz          Span: 40.000 MHz          CF Step: 4.000000 MHz          Freq Offset: 0 Hz</p> <p>1 Graph          Scale Div: 10.0 dB          Log          Ref Lvl Offset: 8.65 dB          Ref Value: 30.00 dBm          Mkr1: 2.4114 GHz          4.519 dBm</p> <p>Center: 2.412 GHz #Video BW: 1.3000 MHz* Span: 40 MHz          #Res BW: 430.00 kHz Sweep Time: 1.33 ms (10001 pts)</p> <p>2 Metrics          Occupied Bandwidth: 15.387 MHz Total Power: 14.5 dBm          Transmit Freq Error: 48.176 kHz % of OBW Power: 99.00 %          x dB Bandwidth: 17.33 MHz x dB: -26.00 dB</p> <p>May 09, 2023 3:46:28 PM</p>		



Test Mode	Test Channel	Verdict
11G	MCH	PASS
		

Test Mode	Test Channel	Verdict
11G	HCH	PASS
		

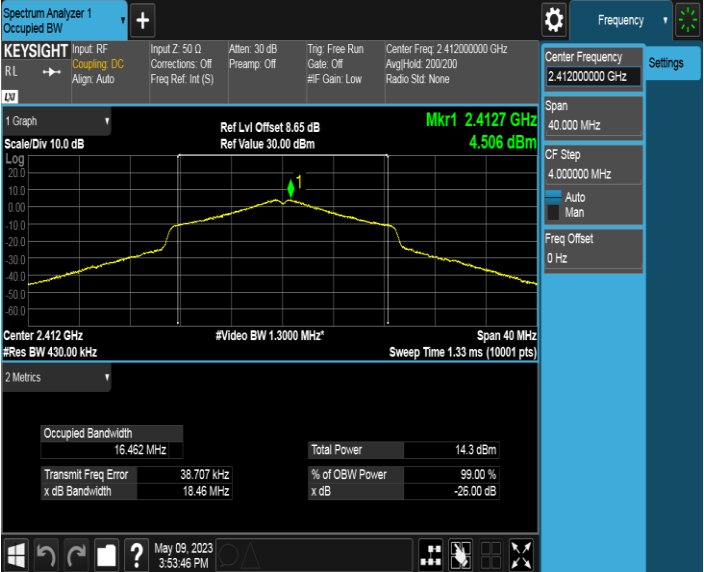
Test Mode	Test Channel	Verdict
11N HT20	LCH	PASS
		

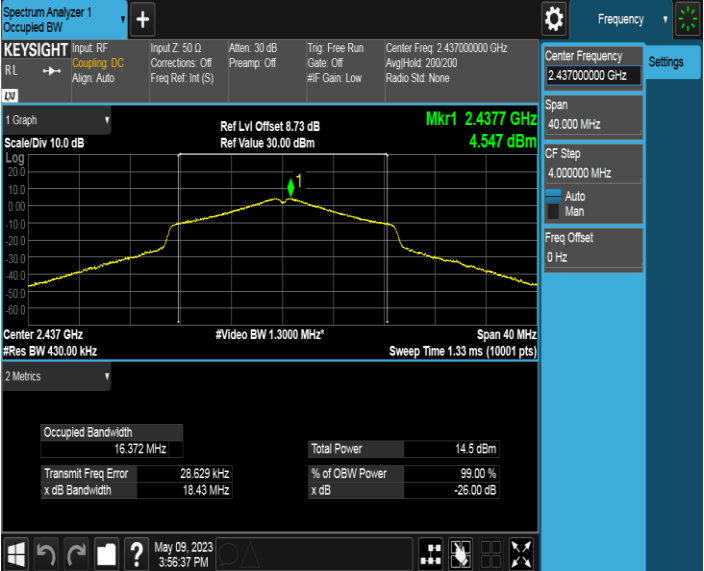
Test Mode	Test Channel	Verdict
11N HT20	MCH	PASS
		

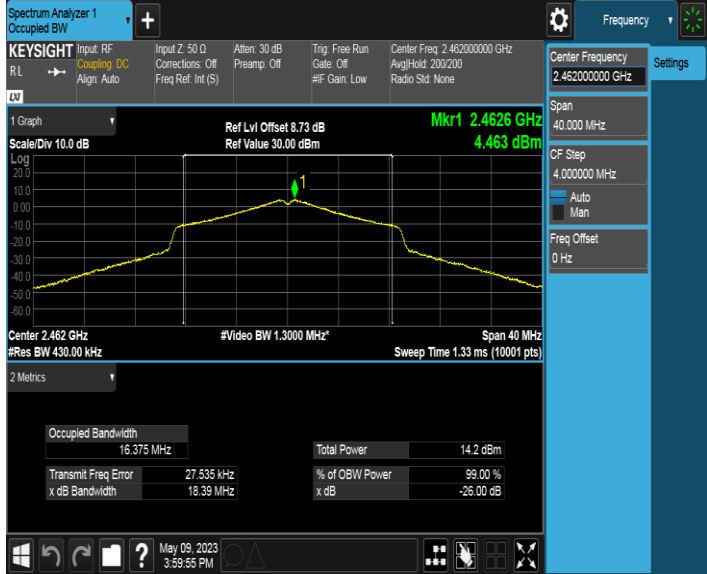
Test Mode	Test Channel	Verdict
11N HT20	HCH	PASS
		

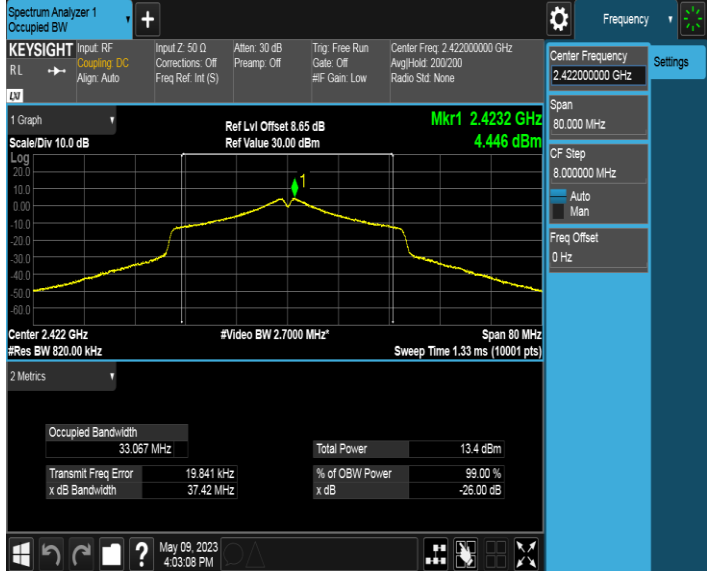
Test Mode	Test Channel	Verdict
11N HT40	LCH	PASS
		

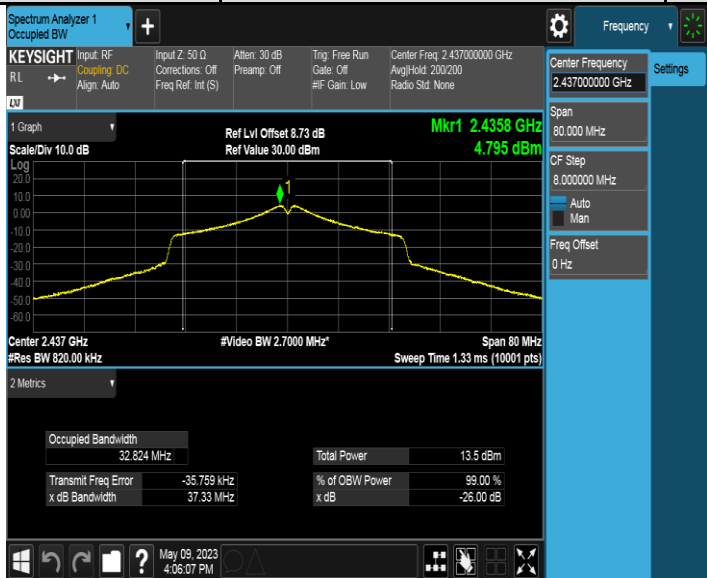
Test Mode	Test Channel	Verdict
11N HT40	MCH	PASS
		

Test Mode	Test Channel	Verdict
11N HT40	HCH	PASS
		

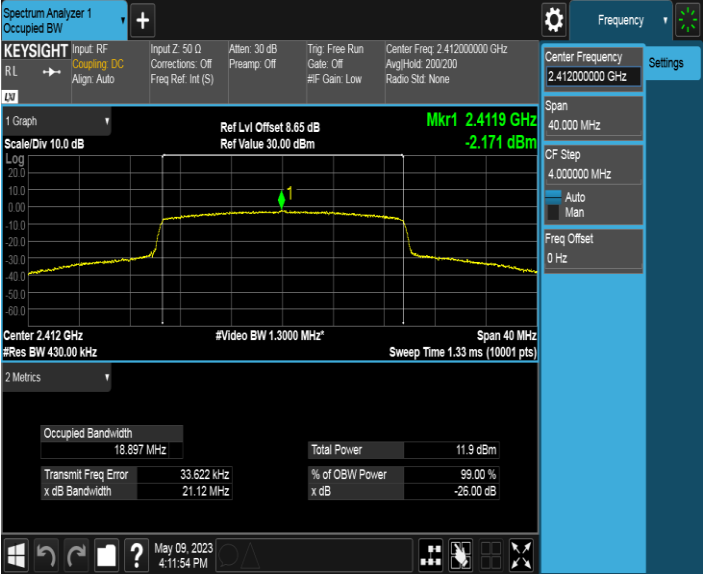
Test Mode	Test Channel	Verdict
11AX20	LCH	PASS
		

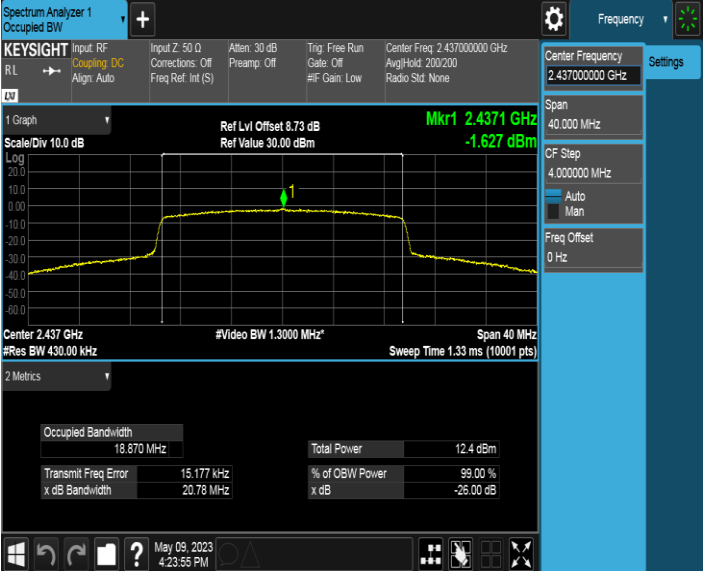
Test Mode	Test Channel	Verdict
11AX20	MCH	PASS
		

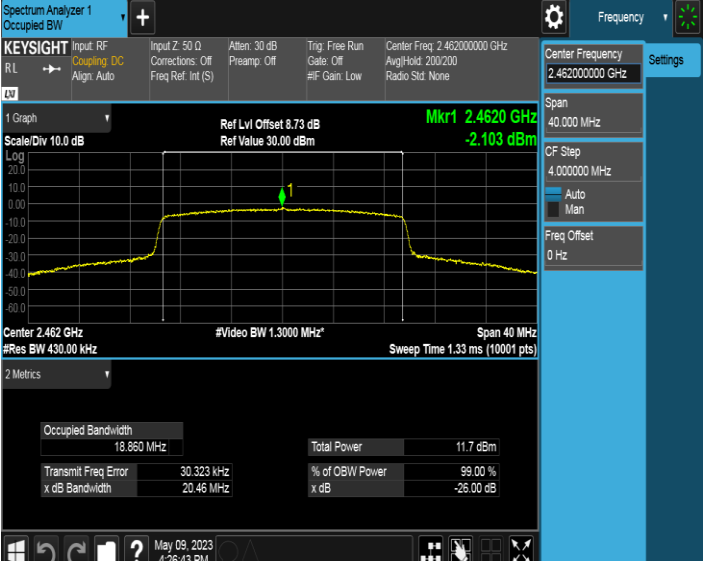
Test Mode	Test Channel	Verdict
11AX20	HCH	PASS
 <p>The screenshot displays the Keysight Spectrum Analyzer 1 interface. The main display shows a spectrum plot with a yellow trace. A marker is placed at 2.462 GHz, showing a power level of -2.103 dBm. The plot has a center frequency of 2.462 GHz, a span of 40 MHz, and a video bandwidth of 1.3000 MHz. The interface also shows various settings and metrics, including Occupied Bandwidth (18.860 MHz), Total Power (11.7 dBm), and Transmitt Freq Error (30.323 kHz).</p>		

### 7.3. CONDUCTED OUTPUT POWER

#### LIMITS

FCC Part15 (15.247) Subpart C, RSS-Gen			
Section	Test Item	Limit	Frequency Range (MHz)
FCC 15.247(b)(3) ISED RSS-247 5.4 (d) RSS-Gen Clause 6.12	Output Power	1 watt or 30dBm	2400-2483.5

#### TEST PROCEDURE

Method AVGSA-2 uses trace averaging across ON and OFF times of the EUT transmissions, followed by

duty cycle correction. The procedure for this method is as follows:

- a) Measure the duty cycle D of the transmitter output signal as described in 11.6.
- b) Set span to at least 1.5 times the OBW.
- c) Set RBW = 1% to 5% of the OBW, not to exceed 1 MHz.
- d) Set VBW  $\geq$  [3 x RBW].
- e) Number of points in sweep  $\geq$  [2 x span / RBW]. (This gives bin-to-bin spacing  $\leq$  RBW / 2, so that narrowband signals are not lost between frequency bins.)
- f) Sweep time = auto.
- g) Detector = RMS (i.e., power averaging), if available. Otherwise, use the sample detector mode.
- h) Do not use sweep triggering. Allow the sweep to “free run.”
- i) Trace average at least 100 traces in power averaging (rms) mode; however, the number of traces to be averaged shall be increased above 100 as needed such that the average accurately represents the true average over the ON and OFF periods of the transmitter.
- j) Compute power by integrating the spectrum across the OBW of the signal using the instrument’s band power measurement function with band limits set equal to the OBW band edges. If the instrument does not have a band power function, then sum the spectrum levels (in power units) at intervals equal to the RBW extending across the entire OBW of the spectrum.
- k) Add [10 log (1 / D)], where D is the duty cycle, to the measured power to compute the average power during the actual transmission times (because the measurement represents an average over both the ON and OFF times of the transmission). For example, add [10 log (1/0.25)] = 6 dB if the duty cycle is 25%.

**TEST SETUP**

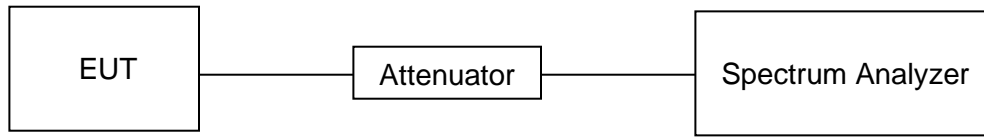

**TEST ENVIRONMENT**

Temperature	22.3°C	Relative Humidity	47.8%
Atmosphere Pressure	102.1kpa	Test Voltage	AC120V/60Hz

**TEST RESULTS TABLE**

Test Mode	Test Channel	Maximum Conducted Output Power (AV)	LIMIT
		dBm	dBm
11B	LCH	12.15	30
	MCH	12.12	30
	HCH	11.63	30
11G	LCH	14.49	30
	MCH	14.75	30
	HCH	14.35	30
11N HT20	LCH	14.27	30
	MCH	14.54	30
	HCH	14.18	30
11N HT40	LCH	13.35	30
	MCH	13.48	30
	HCH	13.19	30
11AX20	LCH	11.88	30
	MCH	12.33	30
	HCH	11.66	30

Remark:

- 1) For all the test results has been adjusted the duty cycle factor.
- 2) For Correction Factor is refer to the result in section 7.1



**TEST GRAPHS**

Test Mode	Test Channel	Verdict
11B	LCH	PASS
		

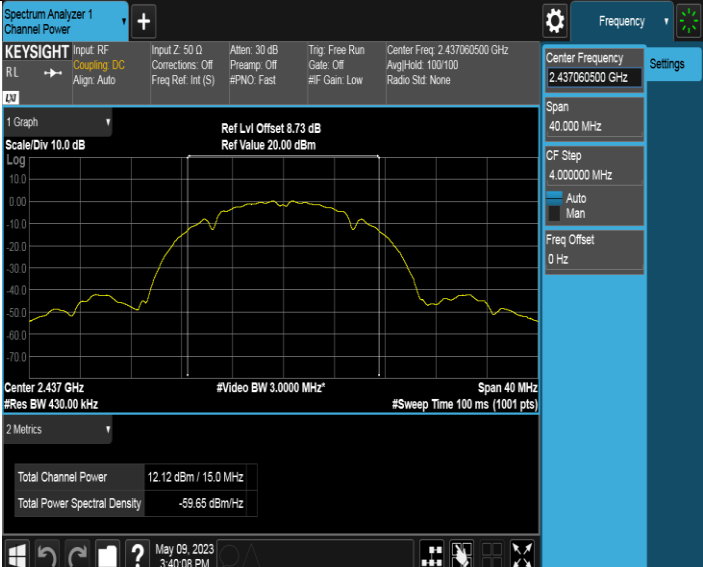
Test Mode	Test Channel	Verdict
11B	MCH	PASS
		

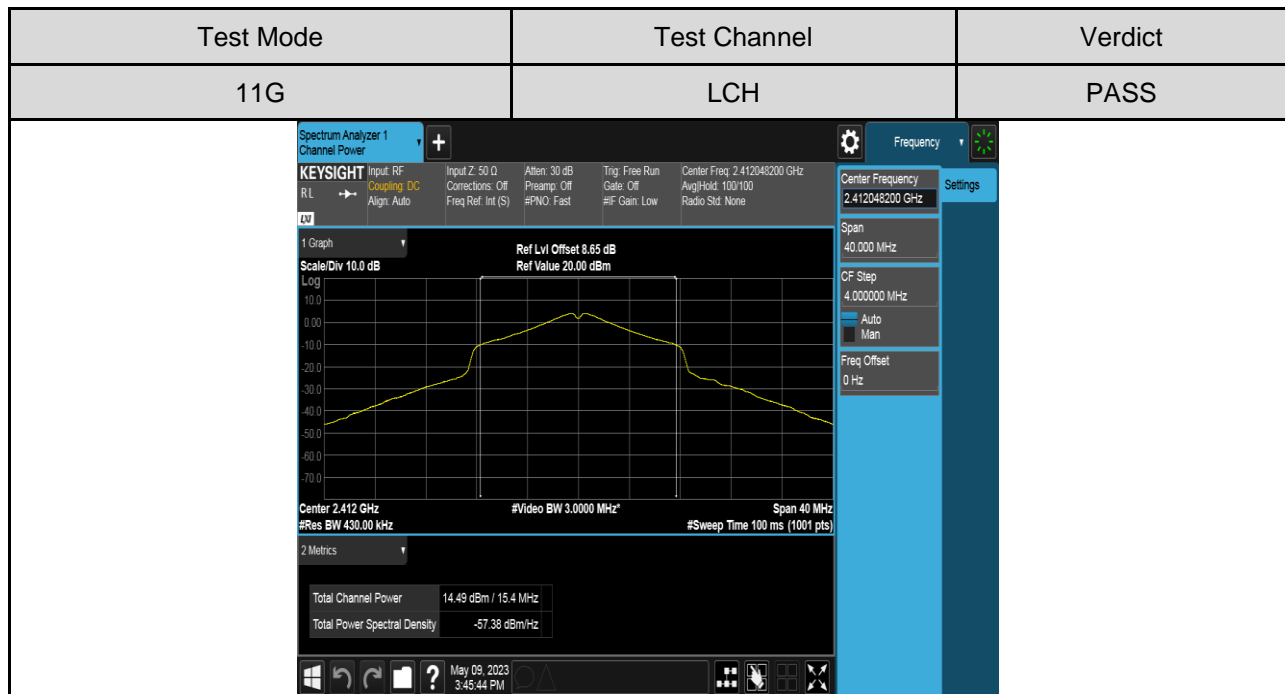
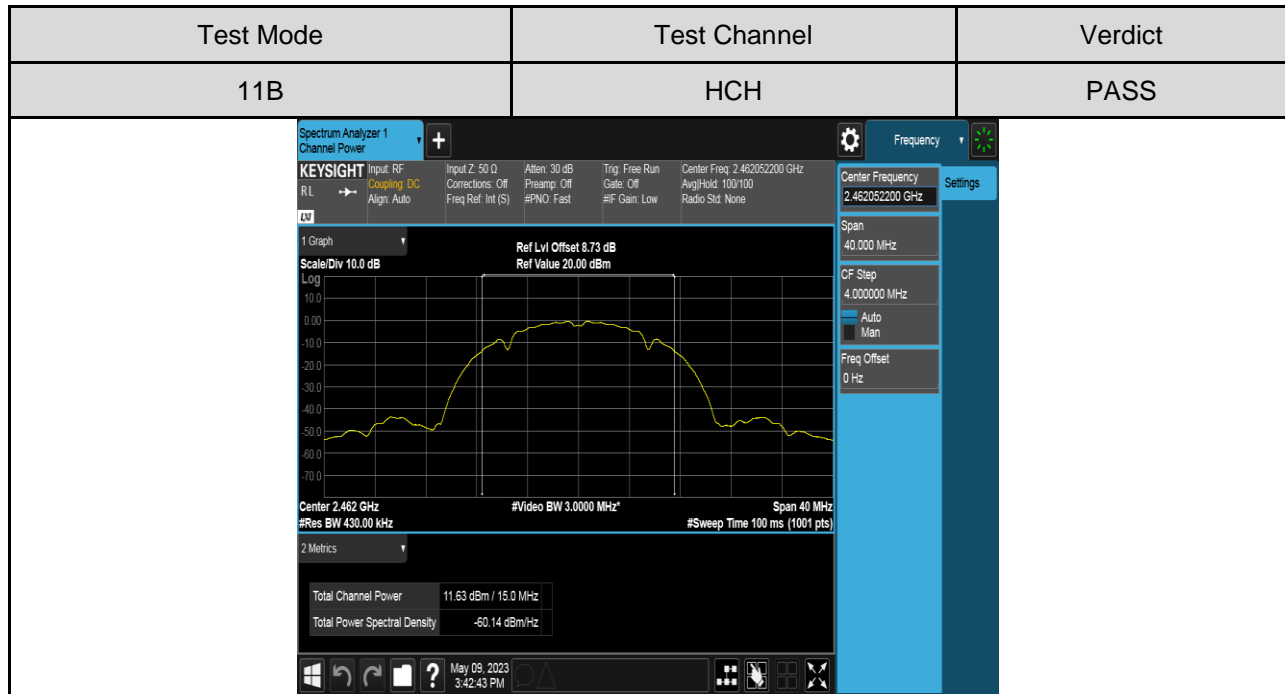



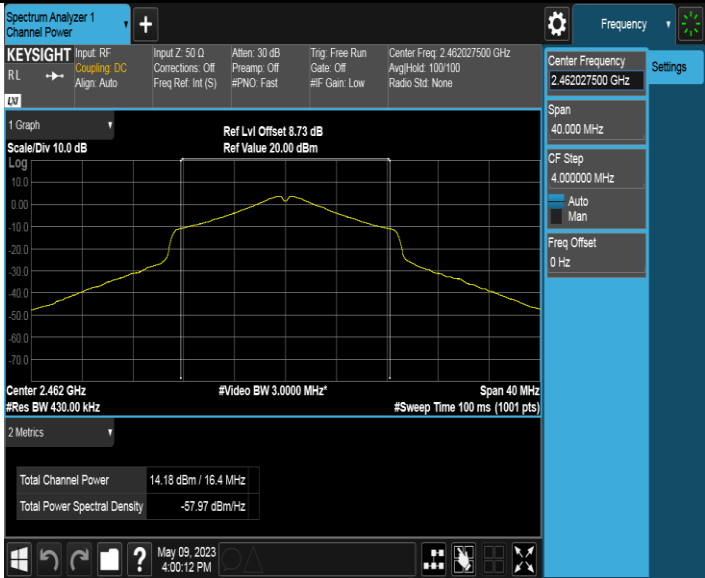

Test Mode	Test Channel	Verdict
11N HT20	HCH	PASS
		

Test Mode	Test Channel	Verdict
11N HT40	LCH	PASS
		

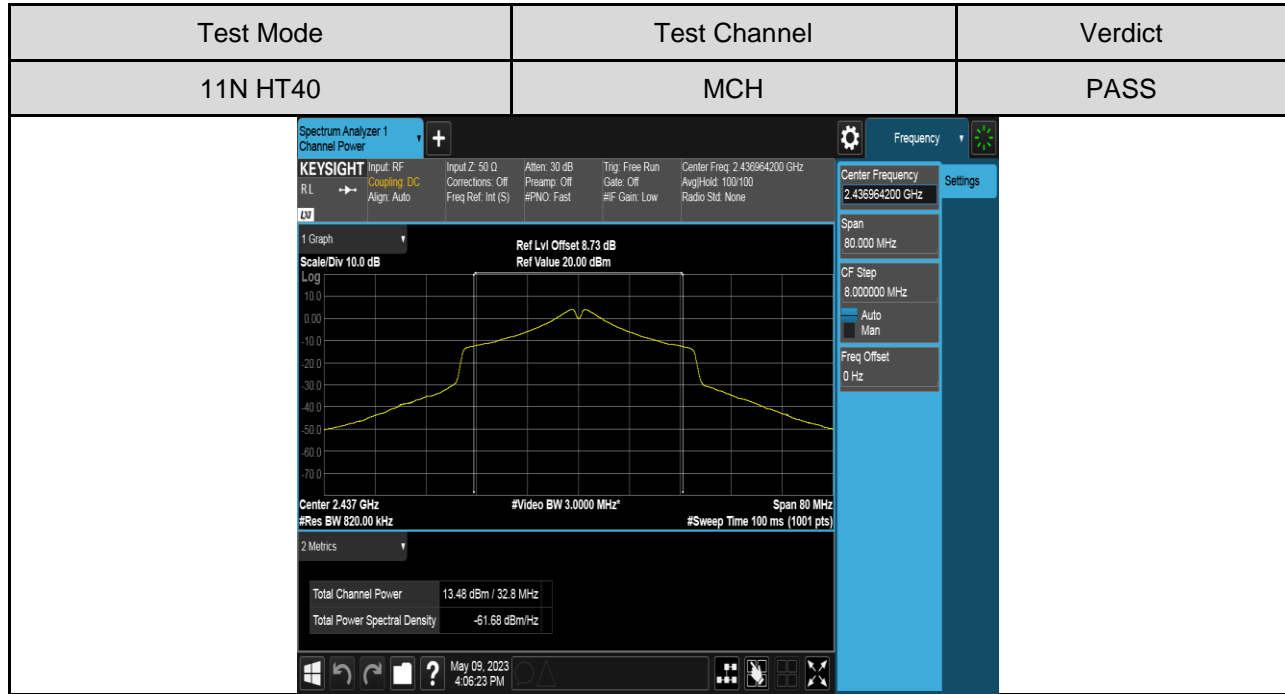

Test Mode	Test Channel	Verdict
11AX20	LCH	PASS
		

Test Mode	Test Channel	Verdict
11AX20	MCH	PASS
		