



**FCC 47 CFR PART 15 SUBPART C
ISED RSS-247 ISSUE 2**

CERTIFICATION TEST REPORT

For

SMART VACUUM CLEANER

MODEL NUMBER: VS1B0100US

PROJECT NUMBER: 4790804070

REPORT NUMBER: 4790804070-2

FCC ID: 2AV7A-S1A

IC: 26039-S1A

ISSUE DATE: May 29, 2023

Prepared for

Tineco Intelligent Technology Co.,Ltd.

Prepared by

UL-CCIC COMPANY LIMITED

No. 2, Chengwan Road, Suzhou Industrial Park, Suzhou 215122, China

Tel: +86 512-6808 6400

Fax: +86 512-6808 4099

Website: www.ul.com

Form-ULID-008536-14 V3.0

The results reported herein have been performed in accordance with the laboratory's terms of accreditation. This report shall not be reproduced except in full without the written approval of the Laboratory. The results in this report apply to the test sample(s) mentioned above at the time of the testing period only and are not to be used to indicate applicability to other similar products.

Revision History

Rev.	Issue Date	Revisions	Revised By
V0	05/29/2023	Initial Issue	

TABLE OF CONTENTS

1. ATTESTATION OF TEST RESULTS	4
2. TEST METHODOLOGY	6
3. FACILITIES AND ACCREDITATION	6
4. CALIBRATION AND UNCERTAINTY	7
4.1. <i>MEASURING INSTRUMENT CALIBRATION</i>	<i>7</i>
4.2. <i>MEASUREMENT UNCERTAINTY.....</i>	<i>7</i>
5. EQUIPMENT UNDER TEST.....	8
5.1. <i>DESCRIPTION OF EUT</i>	<i>8</i>
5.2. <i>MAXIMUM OUTPUT POWER.....</i>	<i>9</i>
5.3. <i>CHANNEL LIST.....</i>	<i>9</i>
5.4. <i>TEST CHANNEL CONFIGURATION.....</i>	<i>9</i>
5.5. <i>THE WORSE CASE POWER SETTING PARAMETER.....</i>	<i>9</i>
5.6. <i>DESCRIPTION OF AVAILABLE ANTENNAS</i>	<i>10</i>
5.7. <i>DESCRIPTION OF TEST SETUP.....</i>	<i>11</i>
5.8. <i>MEASURING INSTRUMENT AND SOFTWARE USED.....</i>	<i>12</i>
6. MEASUREMENT METHODS	14
7. ANTENNA PORT TEST RESULTS.....	15
7.1. <i>ON TIME AND DUTY CYCLE.....</i>	<i>15</i>
7.2. <i>6 dB BANDWIDTH AND 99% OCCUPIED BANDWIDTH</i>	<i>17</i>
7.3. <i>CONDUCTED OUTPUT POWER.....</i>	<i>25</i>
7.4. <i>POWER SPECTRAL DENSITY.....</i>	<i>30</i>
7.5. <i>CONDUCTED BANDEDGE AND SPURIOUS EMISSIONS.....</i>	<i>35</i>
8. RADIATED TEST RESULTS.....	50
8.1. <i>LIMITS AND PROCEDURE.....</i>	<i>50</i>
8.2. <i>TEST ENVIRONMENT</i>	<i>57</i>
8.3. <i>RESTRICTED BANDEDGE.....</i>	<i>57</i>
8.4. <i>SPURIOUS EMISSIONS</i>	<i>66</i>
9. AC POWER LINE CONDUCTED EMISSIONS.....	99
10. ANTENNA REQUIREMENTS.....	102

1. ATTESTATION OF TEST RESULTS

Applicant Information

Company Name: Tineco Intelligent Technology Co.,Ltd.
Address: No. 108 Shihu Road West, Wuzhong Zone Suzhou ,Jiangsu,China
215128

Manufacturer Information

Company Name: Tineco Intelligent Technology Co.,Ltd.
Address: No. 108 Shihu Road West, Wuzhong Zone Suzhou ,Jiangsu,China
215128

EUT Description

Product Name: SMART VACUUM CLEANER
Model Number: VS1B0100US
Sample Number: 5947707
Data of Receipt Sample: Apr. 04, 2023
Date Tested: Apr. 04, 2023~ May 28, 2023

APPLICABLE STANDARDS	
STANDARD	TEST RESULTS
CFR 47 Part 15 Subpart C	PASS
ISED RSS-247 Issue 2	PASS
ISED RSS-GEN Issue 5	PASS

Summary of Test Results			
Clause	Test Items	FCC and ISED Rules	Test Results
1	6dB Bandwidth and 99% Occupied Bandwidth	FCC 15.247 (a) (2) RSS-247 Clause 5.2 (a) RSS-Gen Clause 6.7	PASS
2	Conducted Power	FCC 15.247 (b) (3) RSS-247 Clause 5.4 (d) RSS-Gen Clause 6.12	PASS
3	Power Spectral Density	FCC 15.247 (e) RSS-247 Clause 5.2 (b)	PASS
4	Conducted Band edge And Spurious emission	FCC 15.247 (d) RSS-247 Clause 5.5 RSS-GEN Clause 6.13	PASS
5	Radiated Band edges and Spurious emission	FCC 15.247 (d) FCC 15.209 FCC 15.205 RSS-247 Clause 5.5 RSS-GEN Clause 8.9 RSS-GEN Clause 6.13	PASS
6	Conducted Emission Test for AC Power Port	FCC 15.207 RSS-GEN Clause 8.8	PASS
7	Antenna Requirement	FCC 15.203 RSS-GEN Clause 6.8	PASS
<p>Note: The measurement result for the sample received is <Pass> according to < ANSI C63.10-2013, FCC CFR 47 Part 2, FCC CFR 47 Part 15C, RSS-Gen and RSS 247> when <Accuracy Method> decision rule is applied.</p>			

Prepared By:

Tom Tang

Tom Tang

Reviewed By:

Leon Wu

Leon Wu

Authorized By:

Chris Zhong

Chris Zhong
EMC&RF Lab Operations Manager

2. TEST METHODOLOGY

The tests documented in this report were performed in accordance with KDB 558074 D01 15.247 Meas Guidance v05r02, 414788 D01 Radiated Test Site v01r01, CFR 47 FCC Part 2, CFR 47 FCC Part 15, ANSI C63.10-2013, ISED RSS-247 Issue 2 and ISED RSS-GEN Issue 5.

3. FACILITIES AND ACCREDITATION

Accreditation Certificate	<p>A2LA (Certificate No.: 4829.01) UL-CCIC COMPANY LIMITED has been assessed and proved to be in compliance with A2LA.</p> <p>FCC (FCC Designation No.: CN1247) UL-CCIC COMPANY LIMITED has been recognized to perform compliance testing on equipment subject to the Commission's Declaration of Conformity (DoC) and Certification rules.</p> <p>IC (IC Designation No.: 25056; CAB No.: CN0073) UL-CCIC COMPANY LIMITED has been recognized to perform compliance testing on equipment subject to the Commission's Declaration of Conformity (DoC) and Certification rules.</p>
---------------------------	---

Note 1: All tests measurement facilities use to collect the measurement data are located at No. 2, Chengwan Road, Suzhou Industrial Park, Suzhou 215122, China

Note 2: For below 30MHz, lab had performed measurements at test anechoic chamber and comparing to measurements obtained on an open field site. These measurements below 30MHz had been correlated to measurements performed on an OFS.

Note 3: The test anechoic chamber in UL-CCIC COMPANY LIMITED had been calibrated and compared to the open field sites and the test anechoic chamber is shown to be equivalent to or worst case from the open field site.

4. CALIBRATION AND UNCERTAINTY

4.1. MEASURING INSTRUMENT CALIBRATION

The measuring equipment utilized to perform the tests documented in this report has been calibrated in accordance with the manufacturer's recommendations and is traceable to recognized national standards.

4.2. MEASUREMENT UNCERTAINTY

Where relevant, the following measurement uncertainty levels have been estimated for tests performed on the apparatus:

Test Item	Uncertainty
Conduction emission	3.1dB
Radiation Emission test(include Fundamental emission) (9KHz-30MHz)	3.4dB
Radiation Emission test(include Fundamental emission) (30MHz-1GHz)	3.4dB
Radiation Emission test (1GHz to 26GHz)(include Fundamental emission)	3.5dB (1GHz-18Gz)
	3.9dB (18GHz-26.5Gz)
Note: This uncertainty represents an expanded uncertainty expressed at approximately the 95% confidence level using a coverage factor of k=2.	

5. EQUIPMENT UNDER TEST

5.1. DESCRIPTION OF EUT

Equipment	SMART VACUUM CLEANER		
Model Name	VS1B0100US		
Product Description	Operation Frequency	2402 MHz ~ 2480 MHz	
	Modulation Type	Data Rate	
	GFSK	1Mbps, 2Mbps	
Test software of EUT:	RD Tool		
Antenna Type:	PCB antenna		
Antenna Gain:	-0.66 dBi		
	Note: This data is provided by customer and our lab isn't responsible for this data.		

5.2. MAXIMUM OUTPUT POWER

Bluetooth Mode	Frequency (MHz)	Channel Number	Max Output Power(dBm)
BLE-1M	2402-2480	0-39[40]	11.62
BLE-2M	2402-2480	0-39[40]	11.58

Remark: For this product can support both BLE-1M and BLE-2M modes.

5.3. CHANNEL LIST

Channel	Frequency (MHz)	Channel	Frequency (MHz)	Channel	Frequency (MHz)	Channel	Frequency (MHz)
0	2402	11	2424	22	2446	33	2468
1	2404	12	2426	23	2448	34	2470
2	2406	13	2428	24	2450	35	2472
3	2408	14	2430	25	2452	36	2474
4	2410	15	2432	26	2454	37	2476
5	2412	16	2434	27	2456	38	2478
6	2414	17	2436	28	2458	39	2480
7	2416	18	2438	29	2460		
8	2418	19	2440	30	2462		
9	2420	20	2442	31	2464		
10	2422	21	2444	32	2468		

5.4. TEST CHANNEL CONFIGURATION

Test Mode	Test Channel		Frequency
GFSK	Low Channel	CH 0	2402MHz
	Middle Channel	CH 19	2440MHz
	High Channel	CH 39	2480MHz

5.5. THE WORSE CASE POWER SETTING PARAMETER

The Worst Case Power Setting Parameter under 2400 ~ 2483.5MHz Band				
Test Software		RD Tool		
Modulation Type	Transmit Antenna Number	Test Channel		
		LCH	MCH	HCH
GFSK(1M)	1	3	3	3
GFSK(2M)	1	3	3	3

5.6. DESCRIPTION OF AVAILABLE ANTENNAS

Ant.	Frequency (MHz)	Antenna Type	Antenna Gain (dBi)
1	2400-2483.5	PCB antenna	-0.66

Note: This data is provided by customer and our lab isn't responsible for this data.

Test Mode	Transmit and Receive Mode	Description
BLE-1M	<input checked="" type="checkbox"/> 1TX, 1RX	Antenna1 can be used as transmitting/receiving antenna independently.
BLE-2M	<input checked="" type="checkbox"/> 1TX, 1RX	Antenna1 can be used as transmitting/receiving antenna independently.

5.7. DESCRIPTION OF TEST SETUP

SUPPORT EQUIPMENT

Item	Equipment	Brand Name	Model Name	Description
1	Laptop	ThinkPad	E590	N/A
2	Fixed Frequency Board	N/A	N/A	Supply by Customer
3	USB Cable	N/A	N/A	Supply by UL Lab(100cm length)
4	AC Adapter	Class 2 Power Supply	KL-WA180100-V	Supply by Customer

I/O PORT

Cable No	Port	Connector Type	Cable Type	Cable Length(m)	Remarks
1	N/A	N/A	N/A	N/A	N/A

ACCESSORY

Item	Accessory	Brand Name	Model Name	Description
1	CLEAN STATION	CLEAN STATION	AA2237	AC120V, 60Hz, 4.2A
2	CLEAN STATION	CLEAN STATION	AA2311	AC120V, 60Hz, 4.2A

Remark: Pre-testing with these accessories and AC adapter, only the data of the worst case (Charging with AA2237 model CLEAN STATION) is included in this report.

TEST SETUP

The EUT can work in an engineer mode with a software through a table PC.

SETUP DIAGRAM FOR TESTS

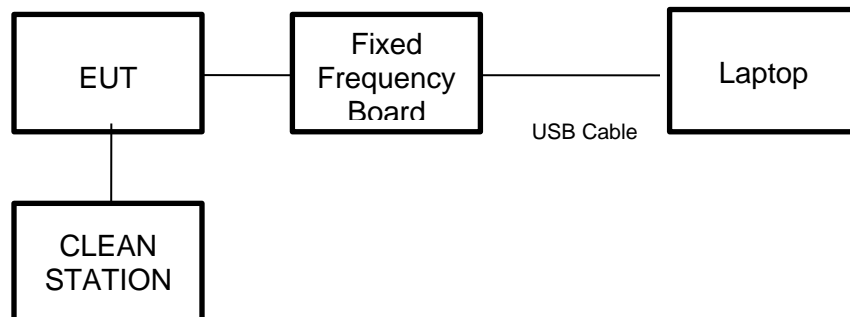

5.8. MEASURING INSTRUMENT AND SOFTWARE USED

Conducted Emissions (Instrument)							
Used	Equipment	Manufacturer	Model No.	Serial No.	Upper Last Cal.	Last Cal.	Next Cal.
<input checked="" type="checkbox"/>	EMI Test Receiver	R&S	ESR3	126700	2021-12-04	2022-12-19	2023-12-18
<input checked="" type="checkbox"/>	Two-Line V-Network	R&S	ENV216	126701	2021-12-04	2022-12-03	2023-12-02
Software							
Used	Description		Manufacturer	Name	Version		
<input checked="" type="checkbox"/>	Test Software for Conducted disturbance		R&S	EMC32	Ver. 9.25		
Radiated Emissions (Instrument)							
Used	Equipment	Manufacturer	Model No.	Serial No.	Upper Last Cal.	Last Cal.	Next Cal.
<input checked="" type="checkbox"/>	Spectrum Analyzer	Keysight	N9010B	155727	2022-04-09	2023-04-08	2024-04-07
<input checked="" type="checkbox"/>	EMI test receiver	R&S	ESR7	221694	2022-05-20	2023-04-08	2024-04-07
<input checked="" type="checkbox"/>	EMI test receiver	R&S	ESR26	126703	2020-12-05	2022-12-03	2023-12-02
<input checked="" type="checkbox"/>	Receiver Antenna (9kHz-30MHz)	Schwarzbeck	FMZB 1513	155456	2018-06-15	2021-06-03	2024-06-02
<input checked="" type="checkbox"/>	Receiver Antenna (30MHz-1GHz)	Schwarzbeck	VULB 9163	126704	2019-02-15	2022-01-18	2025-01-17
<input checked="" type="checkbox"/>	Receiver Antenna (1GHz-18GHz)	R&S	HF907	126705	2018-01-29	2022-02-28	2025-02-27
<input checked="" type="checkbox"/>	Receiver Antenna (18GHz-26.5GHz)	ETS	3160-10	155565	2019-01-05	2021-07-15	2024-07-14
<input checked="" type="checkbox"/>	Pre-amplification (To 18GHz)	R&S	SCU-18D	134667	2021-12-04	2022-12-03	2023-12-02
<input checked="" type="checkbox"/>	Pre-amplification (To 18GHz)	Tonsend	TAP01018050	224539	/	2022-10-20	2023-10-19
<input checked="" type="checkbox"/>	Pre-amplification (To 26.5GHz)	R&S	SCU-26D	135391	2021-12-05	2022-12-03	2023-12-02
<input checked="" type="checkbox"/>	Band Reject Filter	Wainwright	WRCJV8-2350-2400-2483.5-2533.5-40SS	1	2022-04-09	2023-04-08	2024-04-07
<input checked="" type="checkbox"/>	Highpass Filter	Wainwright	WHKX10-2700-3000-18000-40SS	2	2022-04-09	2023-04-08	2024-04-07
<input checked="" type="checkbox"/>	Attenuator	Wainwright	BW-N1-W5+	3	2022-04-09	2023-04-08	2024-04-07
<input checked="" type="checkbox"/>	Chamber A	Albatross	9*6*6	126721	2019-05-31	2022-05-30	2025-05-29
<input checked="" type="checkbox"/>	Chamber B	SAEMC	9*6*6	220350	/	2022-07-03	2025-06-01
<input checked="" type="checkbox"/>	Temperature and Humidity Datalogger	Omega Engineering Inc.	iTHX-SD-5	183135	/	2022-07-20	2023-07-19
Software							
Used	Description		Manufacturer	Name	Version		
<input checked="" type="checkbox"/>	Test Software for Radiated disturbance		Tonscend	JS36-RSE	4.0.0.1		

Other instruments

Used	Equipment	Manufacturer	Model No.	Serial No.	Upper Last Cal.	Last Cal.	Next Cal.
<input checked="" type="checkbox"/>	Spectrum Analyzer	Keysight	N9010B	155368	2022-04-09	2023-04-08	2024-04-07
<input checked="" type="checkbox"/>	Attenuator	PASTERNAK	PE7087-6	1624	2022-05-23	2023-04-08	2024-04-07
<input checked="" type="checkbox"/>	Shielding Room	Albatross	/	126723	2019-12-27	2022-05-30	2025-05-29
<input checked="" type="checkbox"/>	Temperature and Humidity Datalogger	Omega Engineering Inc.	iTHX-SD-5	199847	2021-10-15	2022-10-14	2023-10-13

6. MEASUREMENT METHODS

No.	Test Item	KDB Name	Section
1	6dB Bandwidth	KDB 558074 D01 15.247 Meas Guidance v05r02	8.2
2	Output Power	KDB 558074 D01 15.247 Meas Guidance v05r02	8.3.1.1
3	Power Spectral Density	KDB 558074 D01 15.247 Meas Guidance v05r02	8.4 (Method PKPSD)
4	Out-of-band emissions in non-restricted bands	KDB 558074 D01 15.247 Meas Guidance v05r02	8.5
5	Out-of-band emissions in restricted bands	KDB 558074 D01 15.247 Meas Guidance v05r02	8.6
6	Band-edge	KDB 558074 D01 15.247 Meas Guidance v05r02	8.7
7	Conducted Emission Test for AC Power Port	ANSI C63.10-2013	6.2

7. ANTENNA PORT TEST RESULTS

7.1. ON TIME AND DUTY CYCLE

LIMITS

None; for reporting purposes only

PROCEDURE

FCC KDB 558074 Zero-Span Spectrum Analyzer Method

TEST SETUP

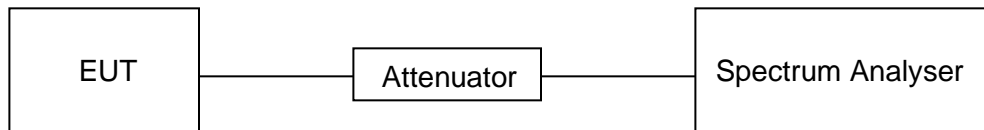

TEST ENVIRONMENT

Temperature	22.3°C	Relative Humidity	47.8%
Atmosphere Pressure	102.1kpa	Test Voltage	AC120V/60Hz

TEST RESULTS TABLE

Mode	On Time (msec)	Period (msec)	Duty Cycle x (Linear)	Duty Cycle (%)	Duty Cycle Correction Factor (db)	1/T Minimum VBW (kHz)	Final VBW (kHz)
BLE-1M	0.38	0.63	0.603	60.3	2.20	2.63	3
BLE-2M	0.20	0.63	0.318	31.8	4.98	5	5

Note: 1) Duty Cycle Correction Factor=10log(1/x).
 2) Where: x is Duty Cycle (Linear)
 3) Where: T is On Time (transmit duration)

TEST GRAPHS

BLE-1M ON TIME AND DUTY CYCLE MID CH (WORSE CASE)

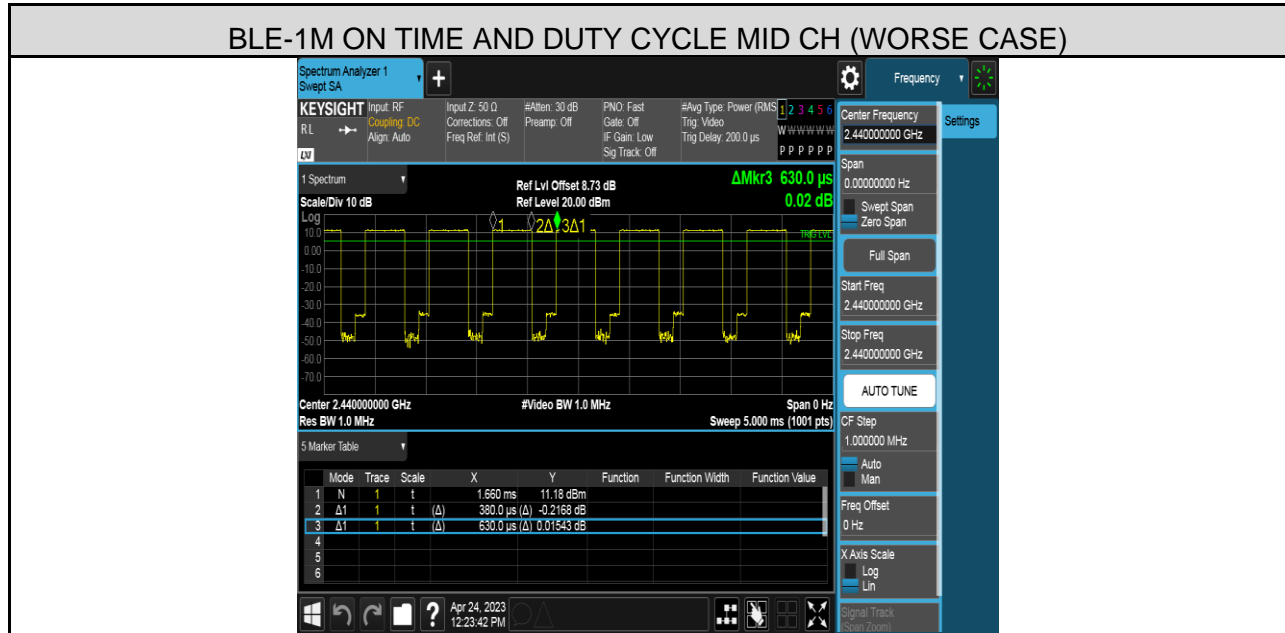

BLE-2M ON TIME AND DUTY CYCLE MID CH (WORSE CASE)

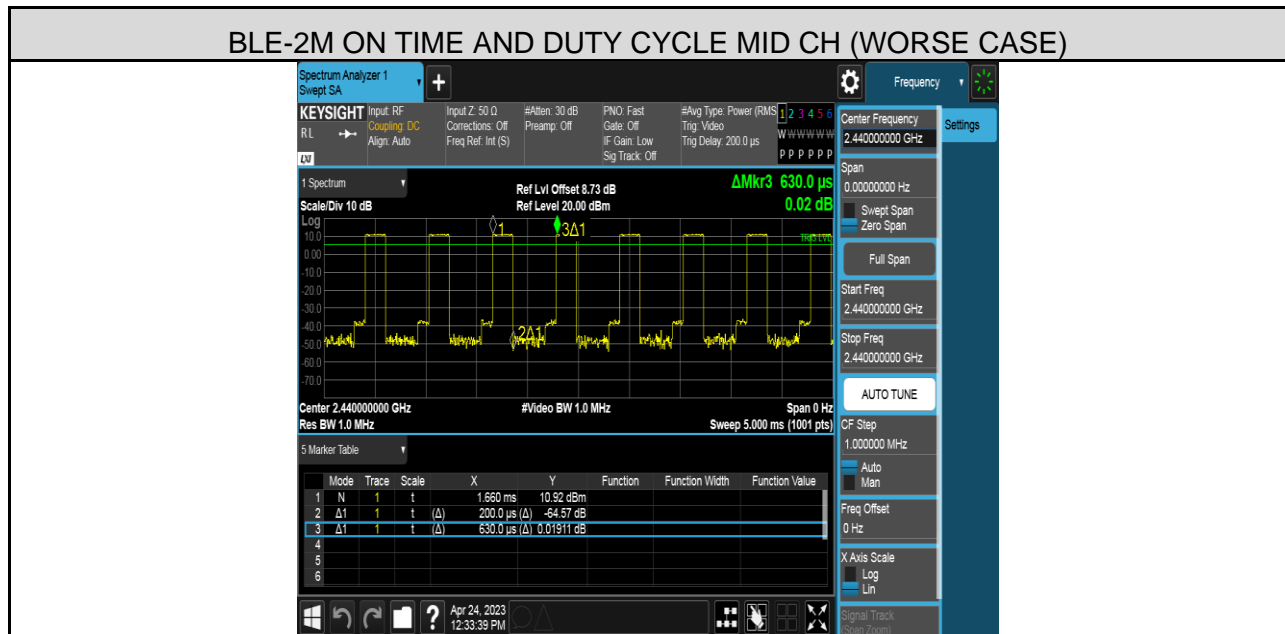

7.2. 6 dB BANDWIDTH AND 99% OCCUPIED BANDWIDTH

LIMITS

FCC Part15 (15.247), Subpart C			
Section	Test Item	Limit	Frequency Range (MHz)
CFR 47 FCC 15.247(a)(2) ISED RSS-247 5.2 (a)	6dB Bandwidth	$\geq 500\text{kHz}$	2400-2483.5
ISED RSS-Gen Clause 6.7	99 % Occupied Bandwidth	For reporting purposes only	2400-2483.5

TEST PROCEDURE

Refer to ANSI C63.10-2013 clause 11.8 for DTS bandwidth and clause 6.9 for Occupied Bandwidth.

Connect the EUT to the spectrum analyser and use the following settings:

Center Frequency	The centre frequency of the channel under test
Frequency Span	For 6 dB Bandwidth: enough to capture all products of the modulation carrier emission For 99 % Occupied Bandwidth: Between 1.5 times and 5 times the OBW
Detector	Peak
RBW	For 6 dB Bandwidth: 100 kHz For 99 % Occupied Bandwidth: 1 % to 5 % of the occupied bandwidth
VBW	For 6 dB Bandwidth: $\geq 3 \times \text{RBW}$ For 99 % Occupied Bandwidth: $\geq 3 \times \text{RBW}$
Trace	Max hold
Sweep	Auto couple

a) Use the 99 % power bandwidth function of the instrument, allow the trace to stabilize and report the measured bandwidth.

b) Allow the trace to stabilize and measure the maximum width of the emission that is constrained by the frequencies associated with the two outermost amplitude points (upper and lower frequencies) that are attenuated by 6 dB relative to the maximum level measured in the fundamental emission.

TEST SETUP

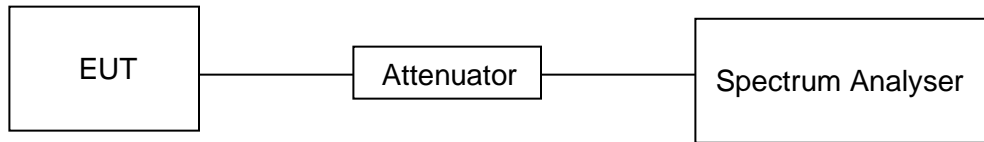

TEST ENVIRONMENT

Temperature	22.3°C	Relative Humidity	47.8%
Atmosphere Pressure	102.1kpa	Test Voltage	AC120V/60Hz

TEST RESULTS TABLE

Test Mode	Test Channel	6dB bandwidth (MHz)	99% bandwidth (MHz)	Result
BLE-1M	LCH	0.696	1.0233	Pass
	MCH	0.700	1.0245	Pass
	HCH	0.696	1.0244	Pass
BLE-2M	LCH	1.164	2.0187	Pass
	MCH	1.180	2.0172	Pass
	HCH	1.184	2.0167	Pass

TEST GRAPHS

6dB Bandwidth_For 1M Part:

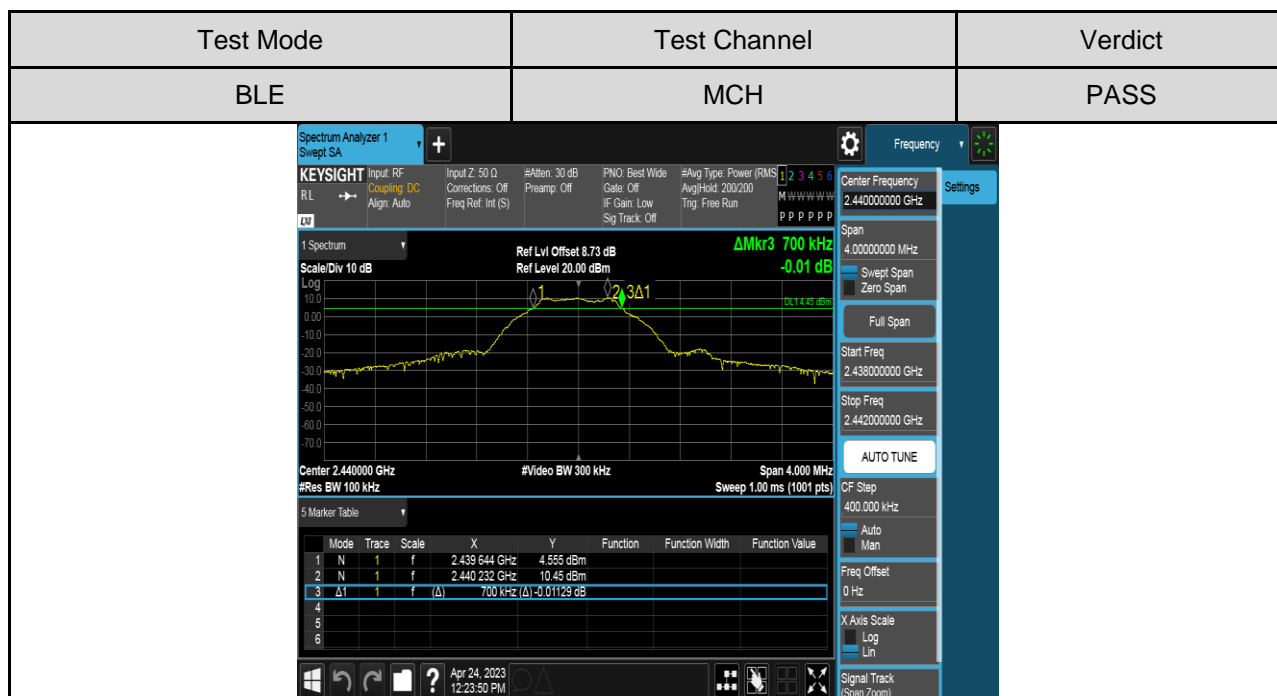
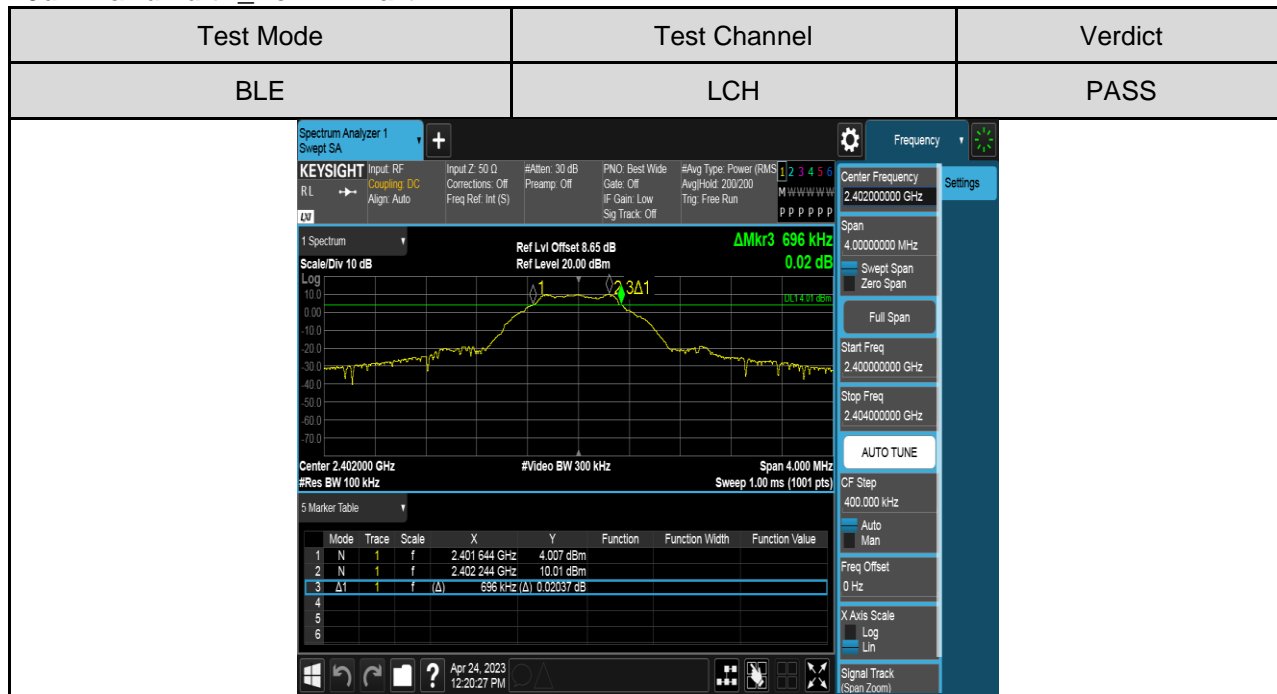

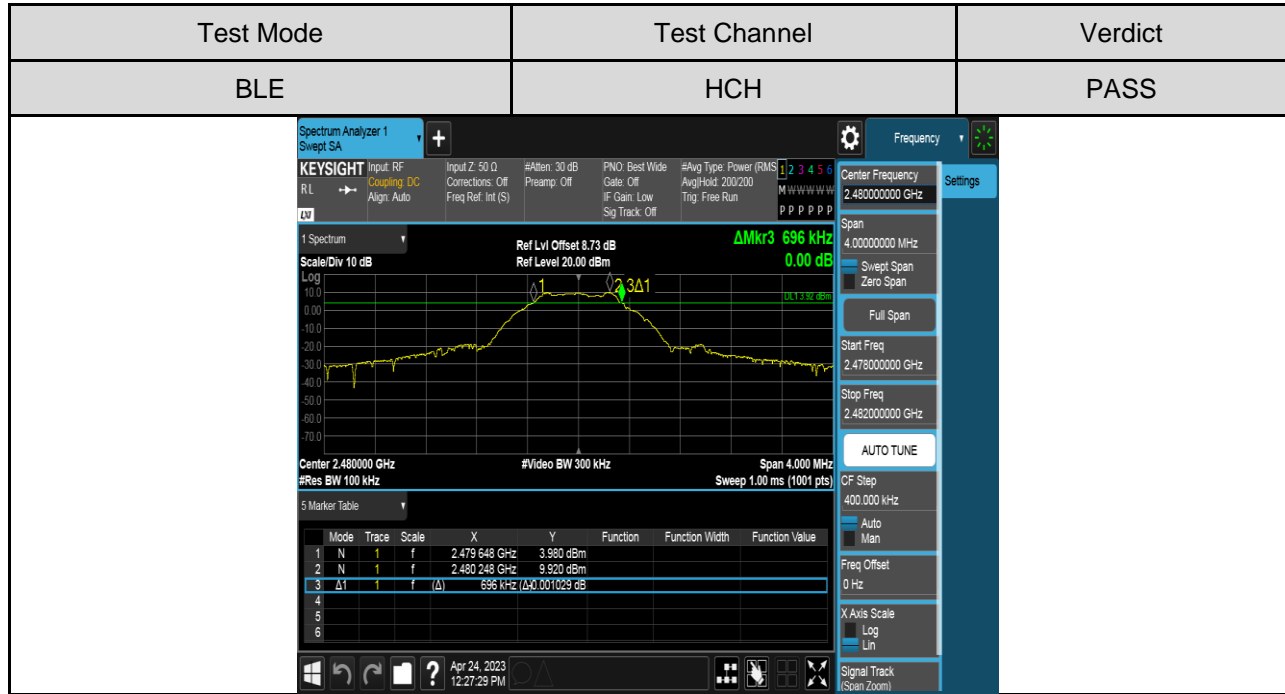

6dB Bandwidth_For 2M Part:

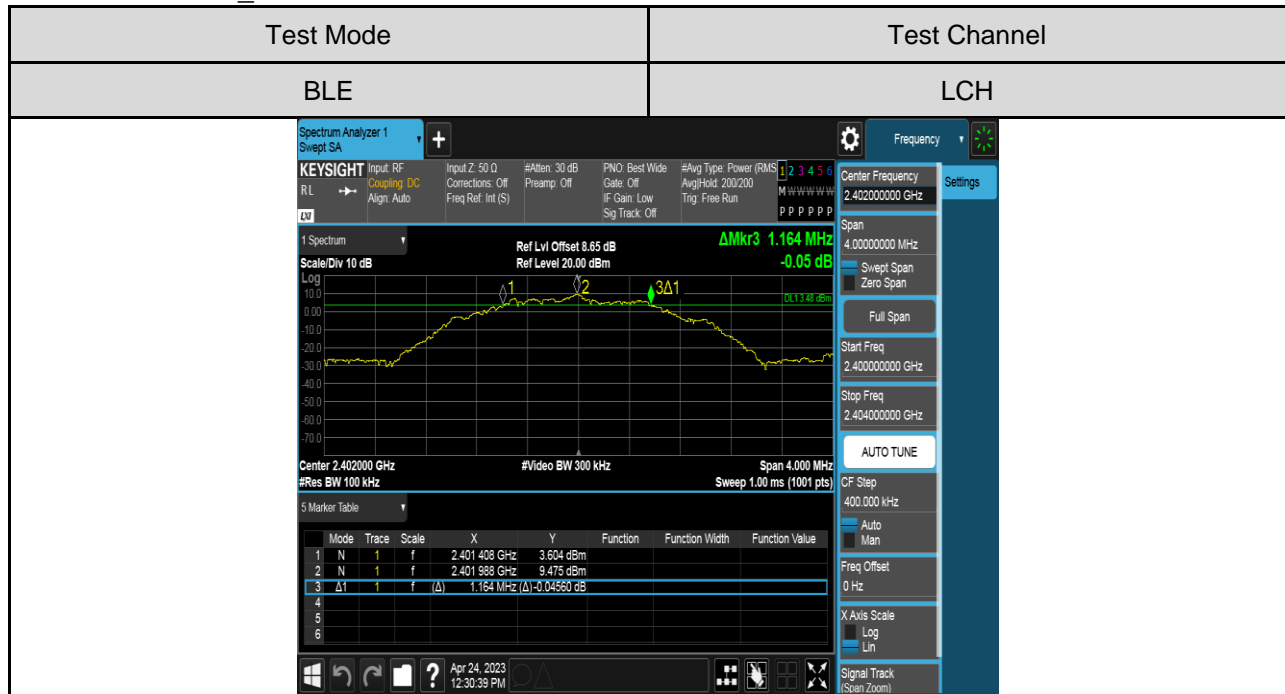

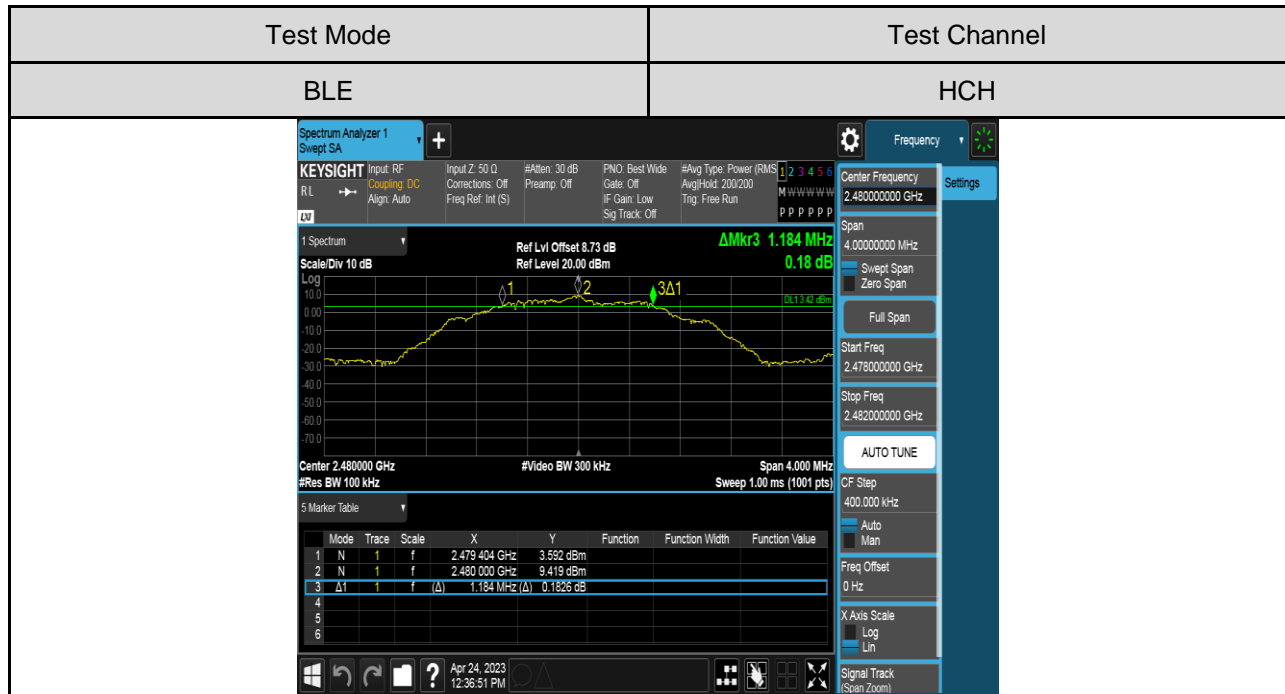
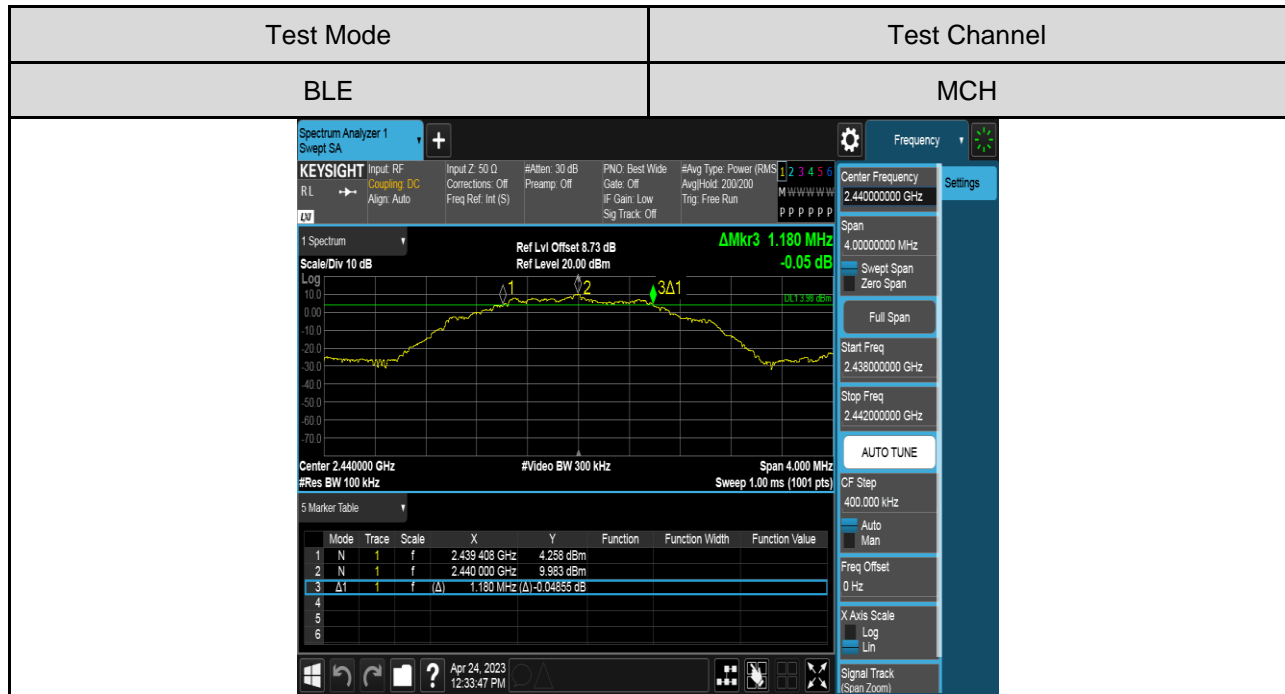

99% Bandwidth_For 1M Part:

Test Mode	Test Channel	Verdict
BLE	LCH	PASS
 <p>Keysight Spectrum Analyzer 1 - Occupied BW</p> <p>Center Freq: 2.40200000 GHz Span: 4.0000 MHz CF Step: 400.000 kHz Mkr1: 2.4020 GHz, 7.41 dBm</p> <p>Occupied Bandwidth: 1.0233 MHz Total Power: 17.0 dBm Transmit Freq Error: 836 Hz % of OBW Power: 99.00 %</p>		

Test Mode	Test Channel	Verdict
BLE	MCH	PASS
 <p>Keysight Spectrum Analyzer 1 - Occupied BW</p> <p>Center Freq: 2.44000000 GHz Span: 4.0000 MHz CF Step: 400.000 kHz Mkr1: 2.4400 GHz, 7.85 dBm</p> <p>Occupied Bandwidth: 1.0245 MHz Total Power: 17.5 dBm Transmit Freq Error: 21 Hz % of OBW Power: 99.00 %</p>		

Test Mode	Test Channel	Verdict												
BLE	HCH	PASS												
 <p>Metrics Table:</p> <table border="1"> <tr> <td>Occupied Bandwidth</td> <td>1.0244 MHz</td> <td>Total Power</td> <td>16.9 dBm</td> </tr> <tr> <td>Transmit Freq Error</td> <td>264 Hz</td> <td>% of OBW Power</td> <td>99.00 %</td> </tr> <tr> <td>x dB Bandwidth</td> <td>1.283 MHz</td> <td>x dB</td> <td>-26.00 dB</td> </tr> </table>			Occupied Bandwidth	1.0244 MHz	Total Power	16.9 dBm	Transmit Freq Error	264 Hz	% of OBW Power	99.00 %	x dB Bandwidth	1.283 MHz	x dB	-26.00 dB
Occupied Bandwidth	1.0244 MHz	Total Power	16.9 dBm											
Transmit Freq Error	264 Hz	% of OBW Power	99.00 %											
x dB Bandwidth	1.283 MHz	x dB	-26.00 dB											

99% Bandwidth_For 2M Part:

Test Mode	Test Channel												
BLE	LCH												
 <p>Metrics Table:</p> <table border="1"> <tr> <td>Occupied Bandwidth</td> <td>2.0187 MHz</td> <td>Total Power</td> <td>16.2 dBm</td> </tr> <tr> <td>Transmit Freq Error</td> <td>12.011 kHz</td> <td>% of OBW Power</td> <td>99.00 %</td> </tr> <tr> <td>x dB Bandwidth</td> <td>2.469 MHz</td> <td>x dB</td> <td>-26.00 dB</td> </tr> </table>		Occupied Bandwidth	2.0187 MHz	Total Power	16.2 dBm	Transmit Freq Error	12.011 kHz	% of OBW Power	99.00 %	x dB Bandwidth	2.469 MHz	x dB	-26.00 dB
Occupied Bandwidth	2.0187 MHz	Total Power	16.2 dBm										
Transmit Freq Error	12.011 kHz	% of OBW Power	99.00 %										
x dB Bandwidth	2.469 MHz	x dB	-26.00 dB										

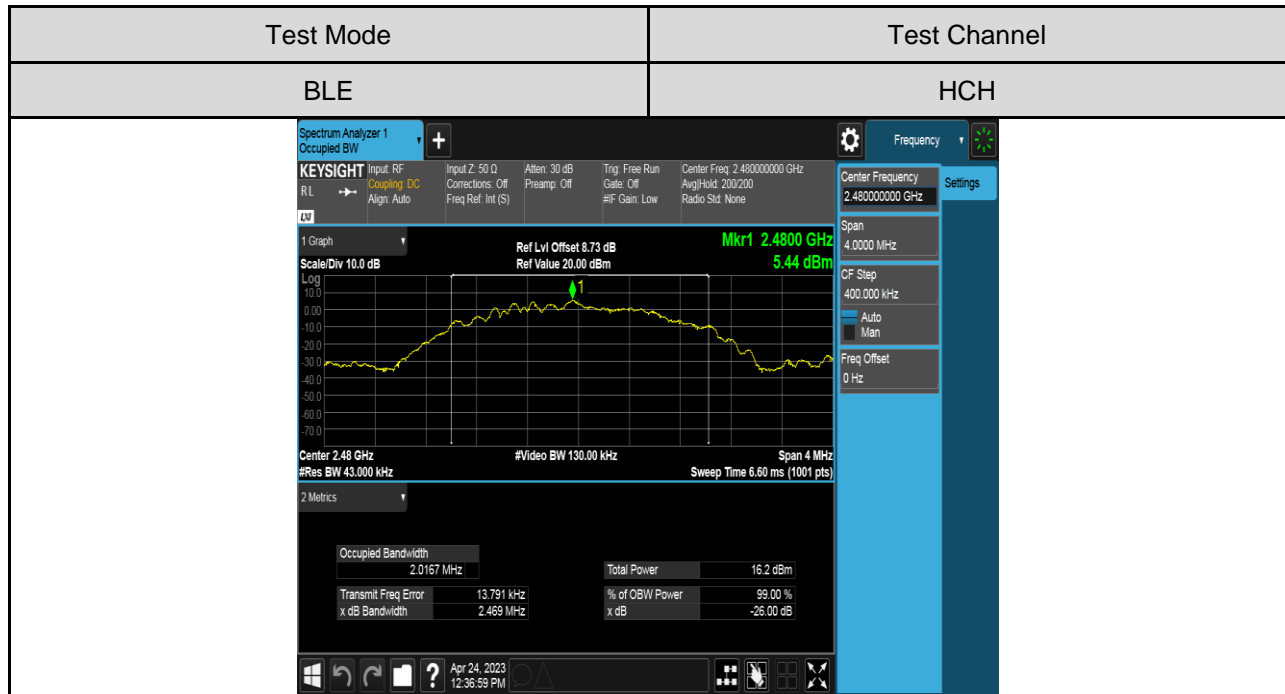
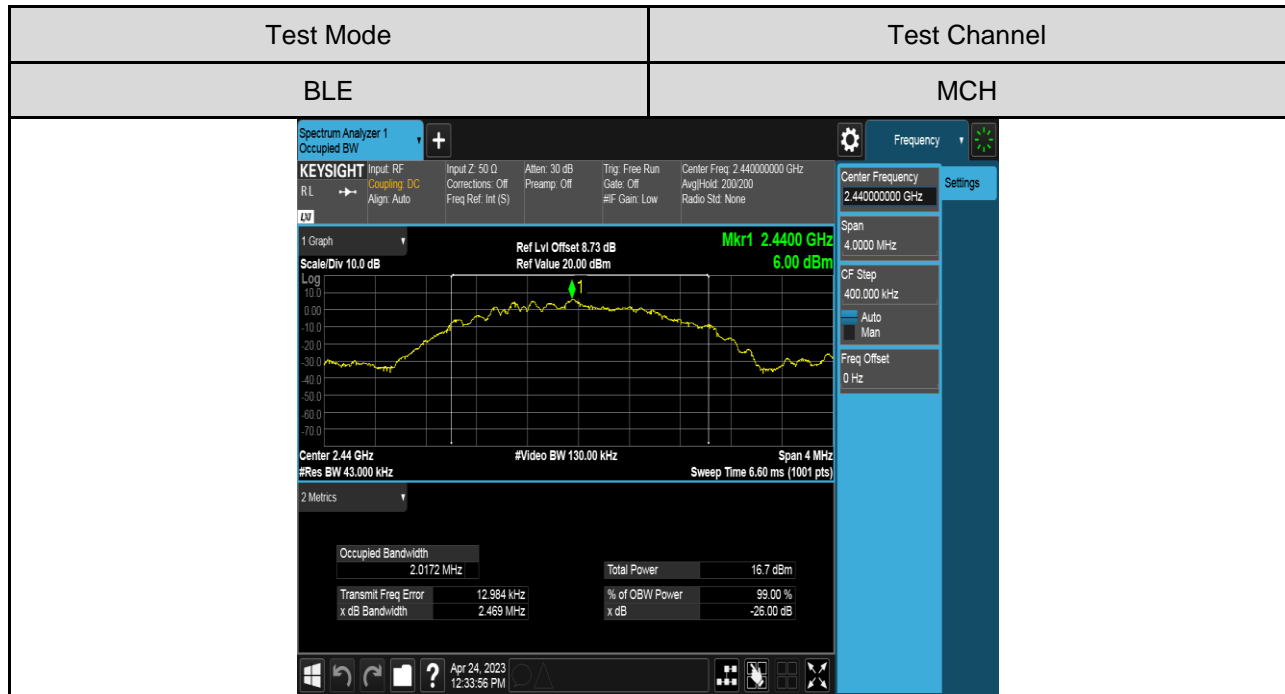

7.3. CONDUCTED OUTPUT POWER

LIMITS

FCC Part15 (15.247), Subpart C, RSS-247			
Section	Test Item	Limit	Frequency Range (MHz)
FCC 15.247(b)(3) RSS-247 Clause 5.4 (d) RSS-Gen Clause 6.12	Output Power	1 watt or 30dBm	2400-2483.5

TEST PROCEDURE

The following procedure shall be used when an instrument with a resolution bandwidth that is greater than the DTS bandwidth is available to perform the measurement:

- a) Set the RBW \geq DTS bandwidth.
- b) Set VBW \geq [3 x RBW].
- c) Set span \geq [3 x RBW].
- d) Sweep time = auto couple.
- e) Detector = peak.
- f) Trace mode = max hold.
- g) Allow trace to fully stabilize.
- h) Use peak marker function to determine the peak amplitude level.

TEST ENVIRONMENT

Temperature	22.3°C	Relative Humidity	47.8%
Atmosphere Pressure	102.1kpa	Test Voltage	AC120V/60Hz

TEST SETUP

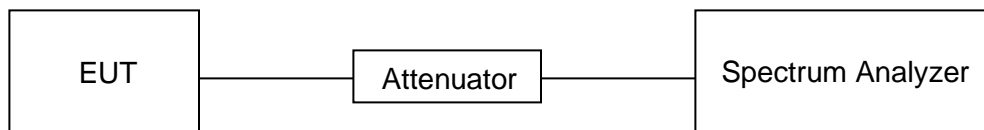



TEST RESULTS TABLE

Test Mode	Frequency[MHz]	Conducted Sensor power[dBm]	Limit [dBm]	Verdict
BLE_1M	2402	11.10	≤30.00	PASS
	2440	11.62	≤30.00	PASS
	2480	11.07	≤30.00	PASS
BLE_2M	2402	11.05	≤30.00	PASS
	2440	11.58	≤30.00	PASS
	2480	11.01	≤30.00	PASS

TEST GRAPHS

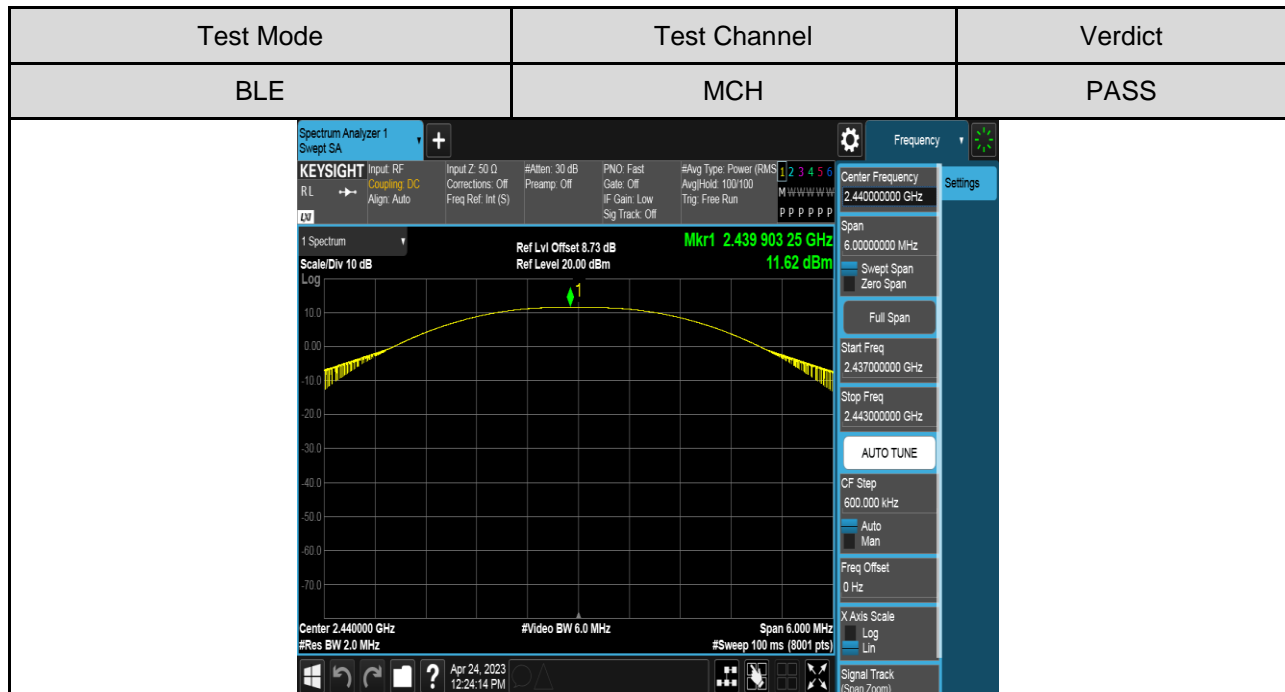
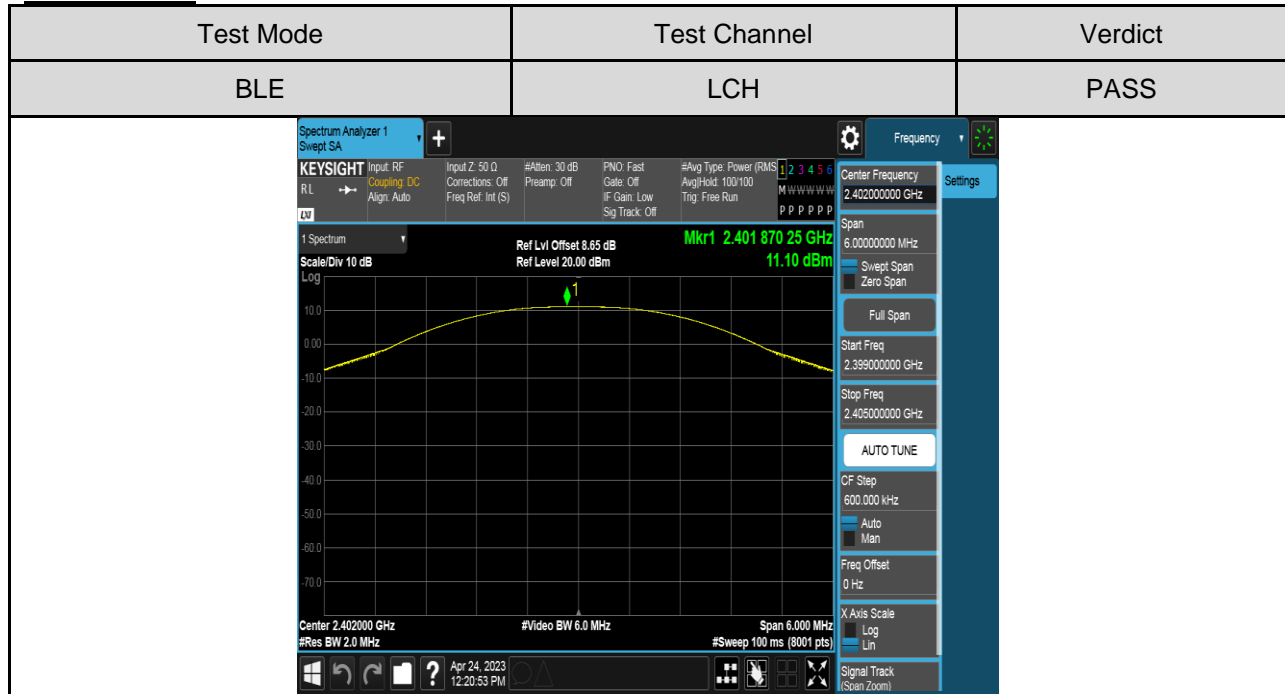
For 1M Part:



Test Mode	Test Channel	Verdict
BLE	HCH	PASS
		

For 2M Part:

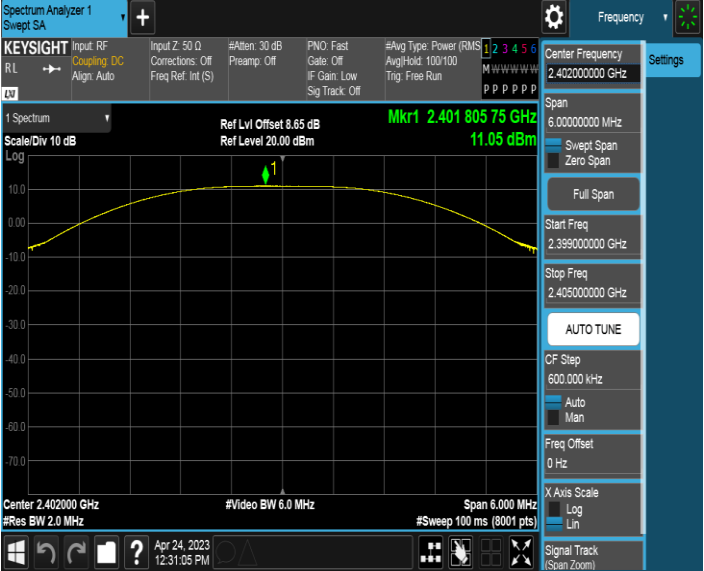
Test Mode	Test Channel	Verdict
BLE	LCH	PASS
		

Test Mode	Test Channel	Verdict
BLE	MCH	PASS
		

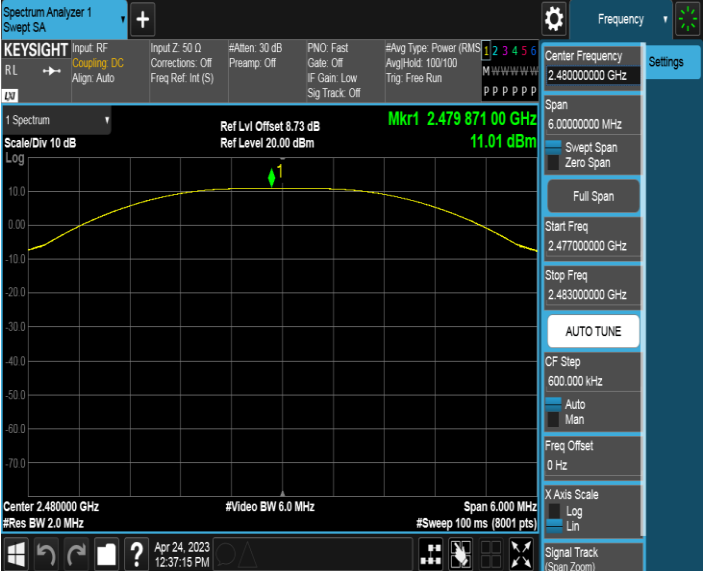
Test Mode	Test Channel	Verdict
BLE	HCH	PASS
		

7.4. POWER SPECTRAL DENSITY

LIMITS

FCC Part15 (15.247), Subpart C, RSS-247			
Section	Test Item	Limit	Frequency Range (MHz)
FCC §15.247 (e) RSS-247 Clause 5.2 (b)	Power Spectral Density	8 dBm/3 kHz	2400-2483.5

TEST PROCEDURE

Refer to FCC KDB 558074, connect the UUT to the spectrum analyser and use the following settings:

Center Frequency	The centre frequency of the channel under test
Detector	Peak
RBW	$3 \text{ kHz} \leq \text{RBW} \leq 100 \text{ kHz}$
VBW	$\geq 3 \times \text{RBW}$
Span	1.5 x DTS bandwidth
Trace	Max hold
Sweep time	Auto couple.

Allow trace to fully stabilize and use the peak marker function to determine the maximum amplitude level within the RBW.

If measured value exceeds limit, reduce RBW (no less than 3 kHz) and repeat.

TEST ENVIRONMENT

Temperature	22.3°C	Relative Humidity	47.8%
Atmosphere Pressure	102.1kpa	Test Voltage	AC120V/60Hz

TEST SETUP

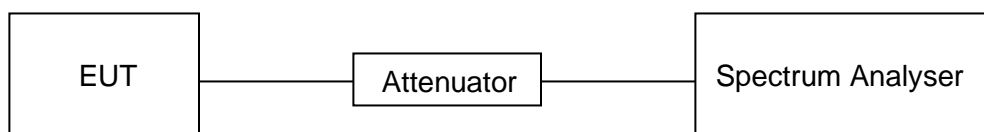



TEST RESULTS TABLE

Test Mode	Test Channel	Maximum Peak power spectral density (dBm/30kHz)	Result
BLE_1M	LCH	6.17	Pass
	MCH	6.64	Pass
	HCH	6.11	Pass
BLE_1M	LCH	3.28	Pass
	MCH	3.79	Pass
	HCH	3.22	Pass

TEST GRAPHS

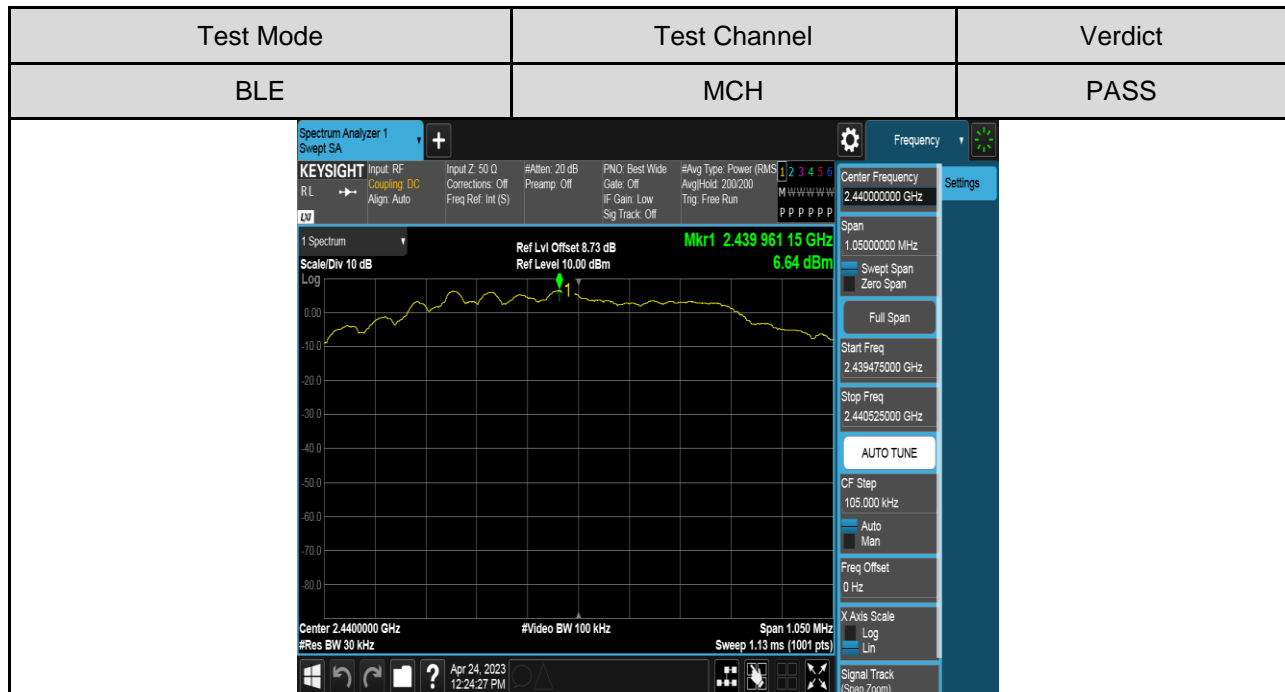
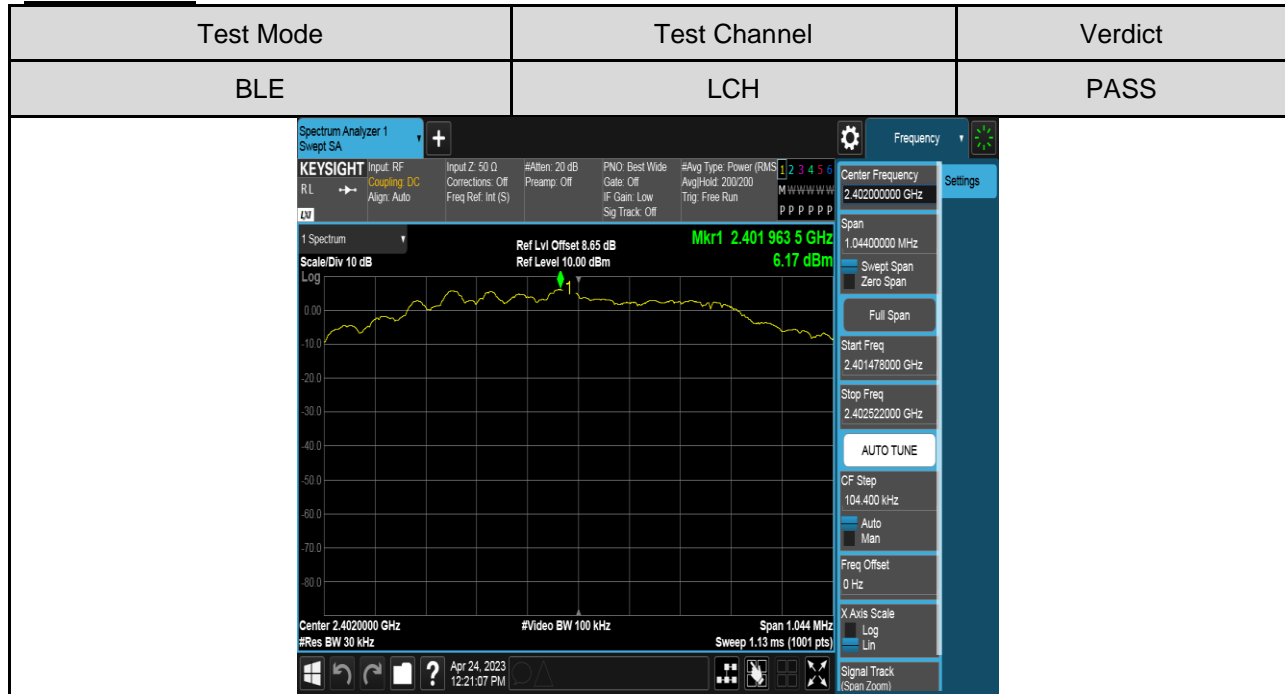
For 1M Part:



Test Mode	Test Channel	Verdict
BLE	HCH	PASS
		

For 2M Part:

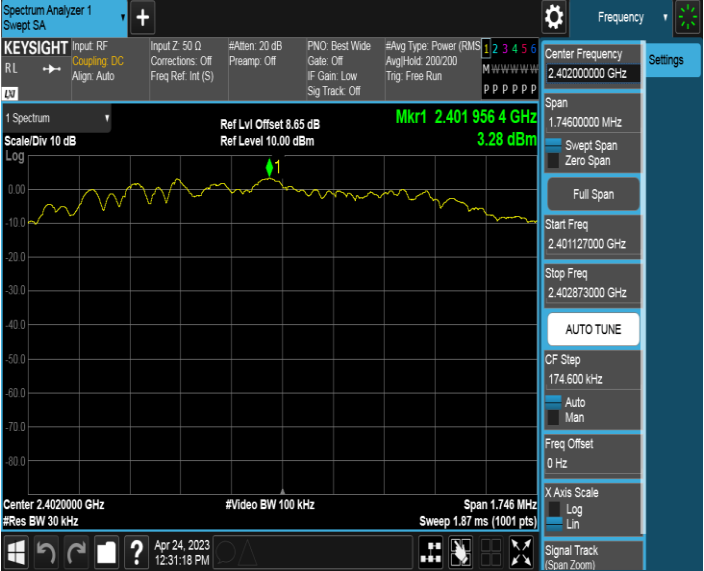
Test Mode	Test Channel	Verdict
BLE	LCH	PASS
		

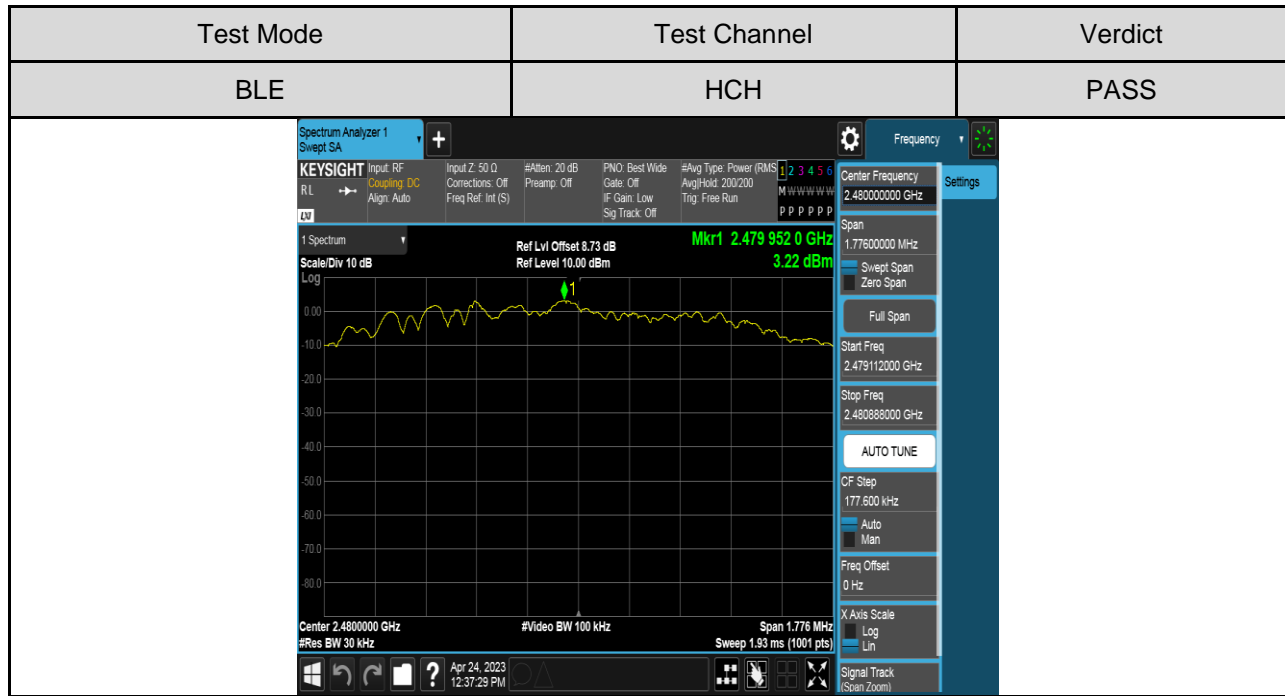
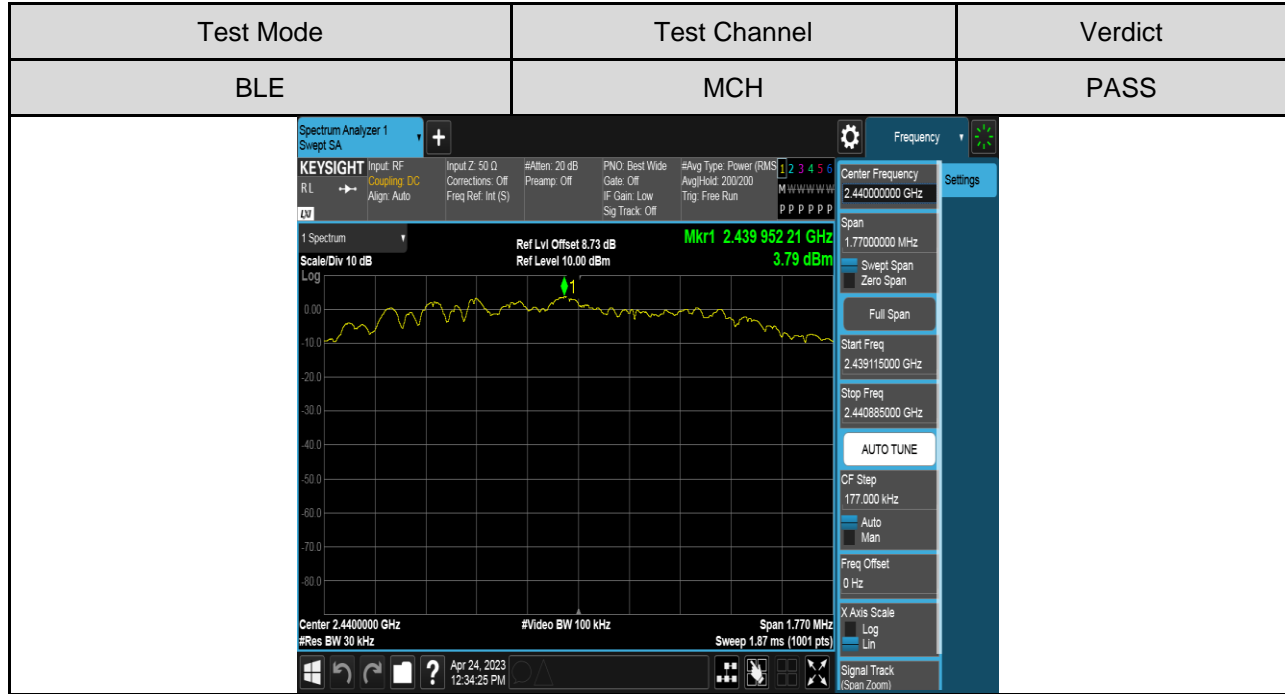

7.5. CONDUCTED BANDEdge AND SPURIOUS EMISSIONS

LIMITS

FCC Part15 (15.247), Subpart C, RSS-247		
Section	Test Item	Limit
FCC §15.247 (d) RSS-247 Clause 5.5 RSS-GEN Clause 6.13	Conducted Bandedge and Spurious Emissions	20 dB below that in the 100 kHz bandwidth within the band that contains the highest level of the desired power

TEST PROCEDURE

Refer to FCC KDB 558074, connect the UUT to the spectrum analyser and use the following settings:

Center Frequency	The centre frequency of the channel under test
Detector	Peak
RBW	100 kHz
VBW	$\geq 3 \times \text{RBW}$
Span	1.5 x DTS bandwidth
Trace	Max hold
Sweep time	Auto couple.

Use the peak marker function to determine the maximum PSD level.

Span	Set the center frequency and span to encompass frequency range to be measured
Detector	Peak
RBW	100 kHz
VBW	$\geq 3 \times \text{RBW}$
measurement points	$\geq \text{span}/\text{RBW}$
Trace	Max hold
Sweep time	Auto couple.

Use the peak marker function to determine the maximum amplitude level.

TEST SETUP

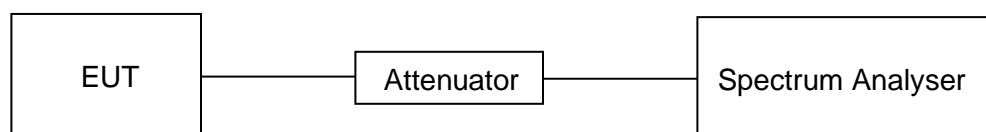

Form-ULID-008536-14 V3.0

TEST ENVIRONMENT

Temperature	22.3°C	Relative Humidity	47.8%
Atmosphere Pressure	102.1kpa	Test Voltage	AC120V/60Hz

PART 1: REFERENCE LEVEL MEASUREMENT**TEST RESULTS TABLE**

Test Mode	Test Channel	Result[dBm]
BLE-1M	LCH	9.95
	MCH	10.47
	HCH	9.93
BLE-2M	LCH	9.55
	MCH	10.07
	HCH	9.50

TEST GRAPHS

For 1M Part:

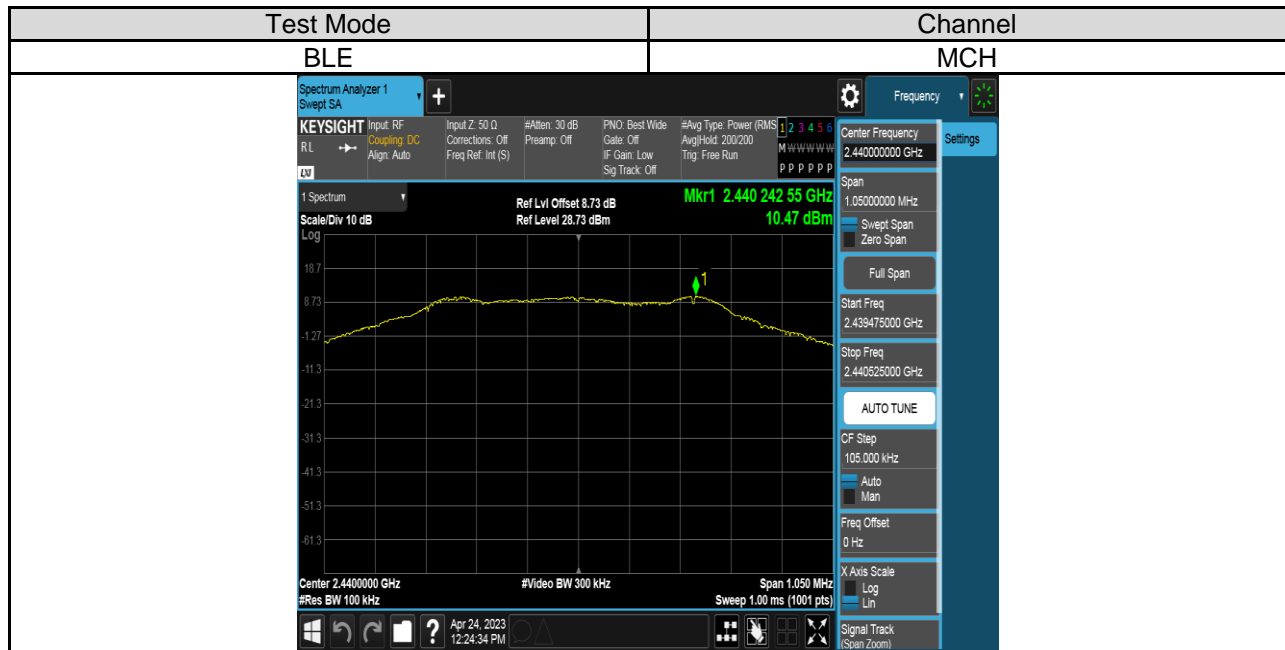
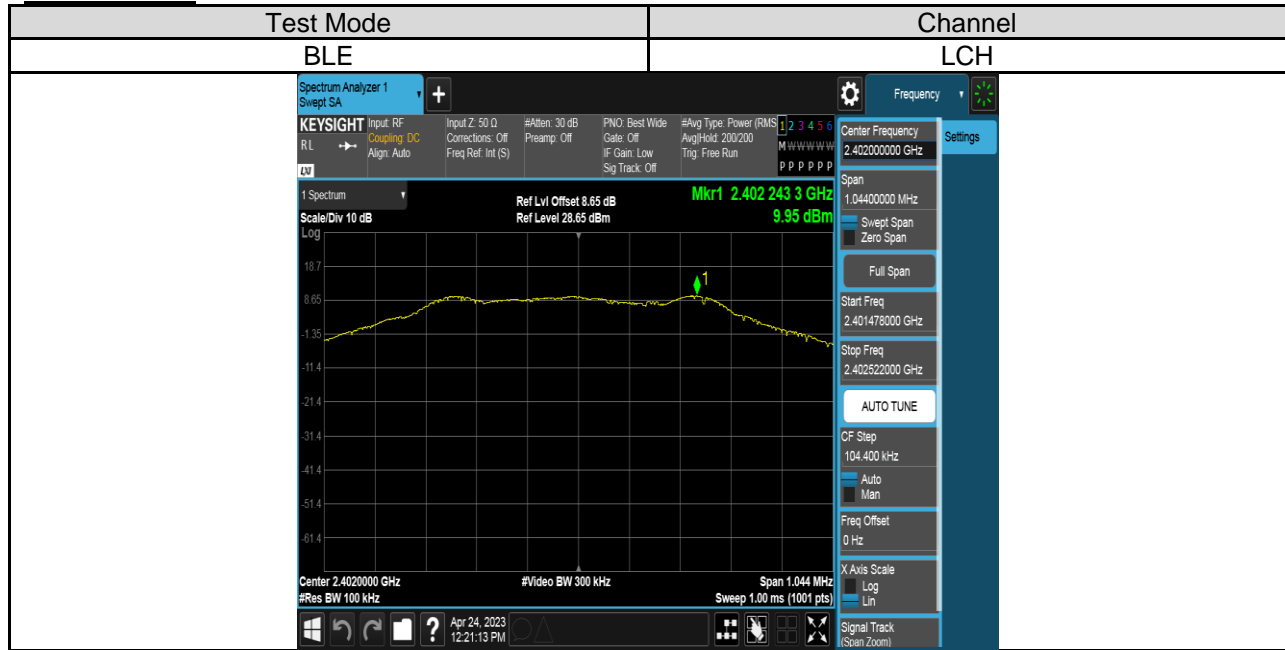



For 2M Part:

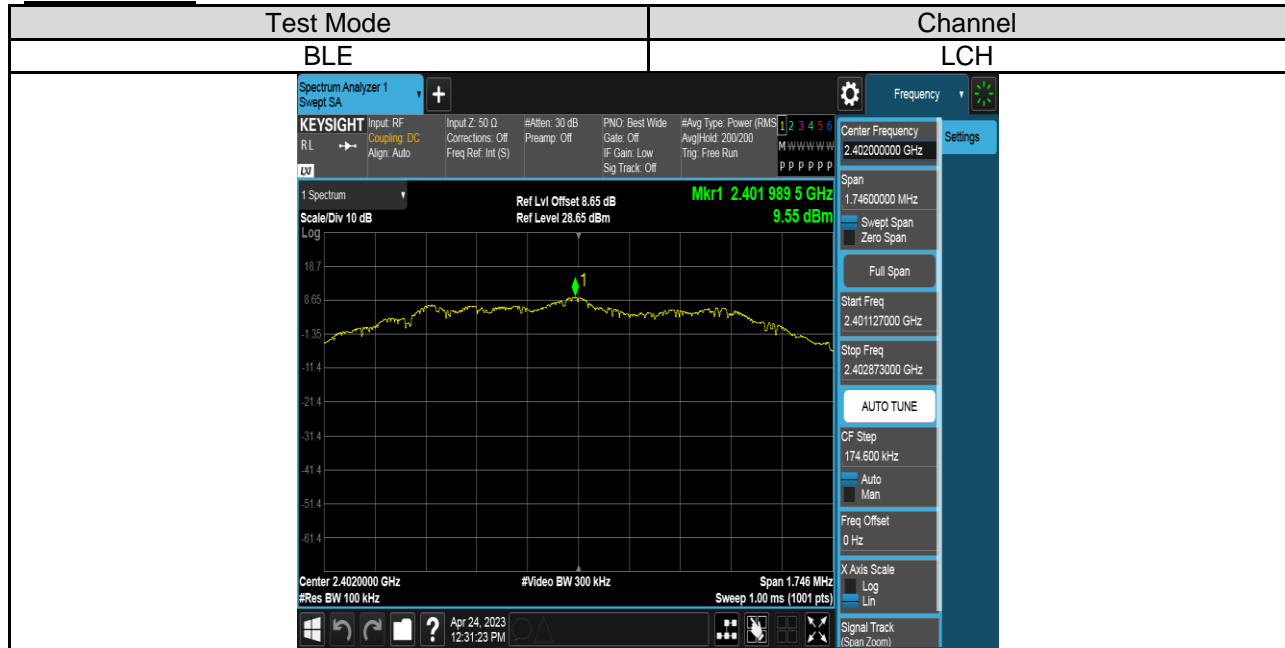

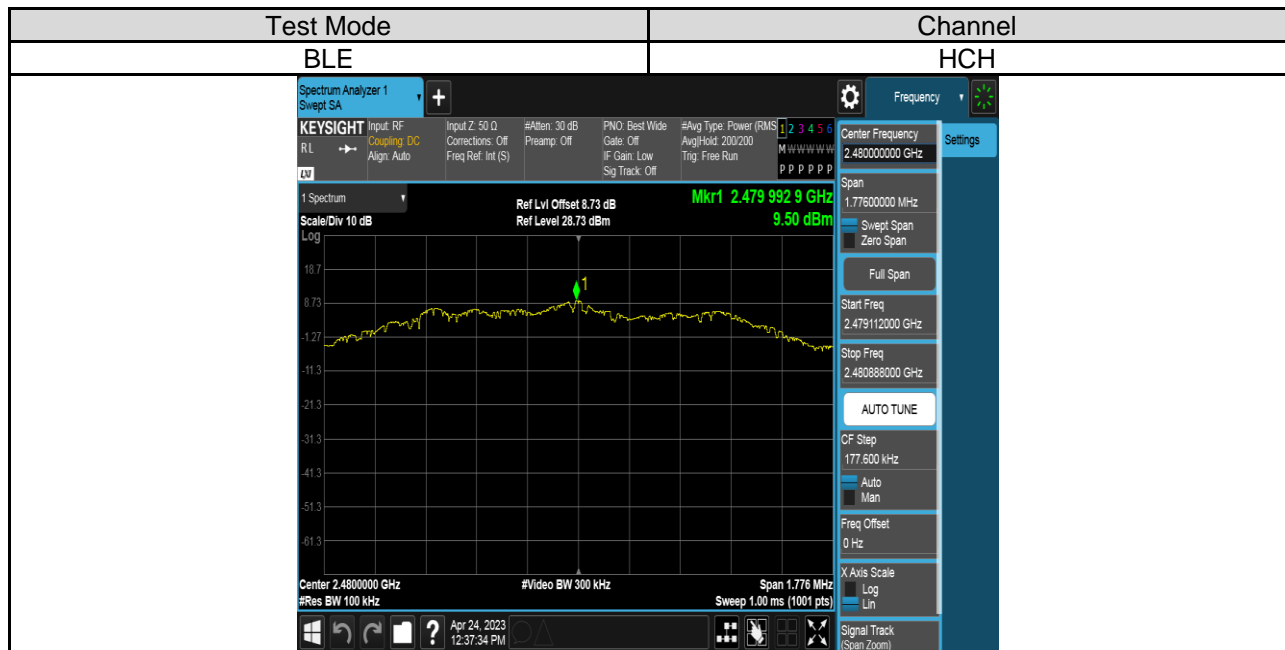
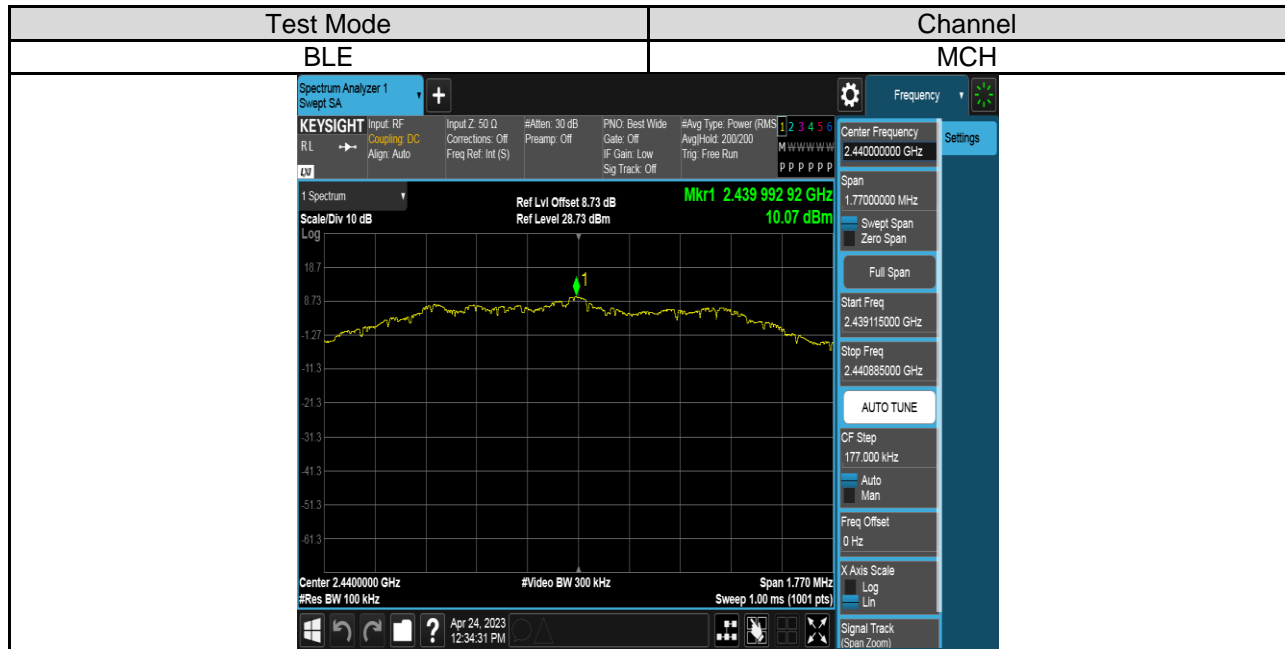

PART 2: CONDUCTED BANDEDGE**TEST RESULTS TABLE**

Test Mode	Test Channel	Result	Verdict
BLE-1M	LCH	Refer to the Test Graph	PASS
	HCH	Refer to the Test Graph	PASS
BLE-2M	LCH	Refer to the Test Graph	PASS
	HCH	Refer to the Test Graph	PASS

TEST GRAPHS

For 1M Part:

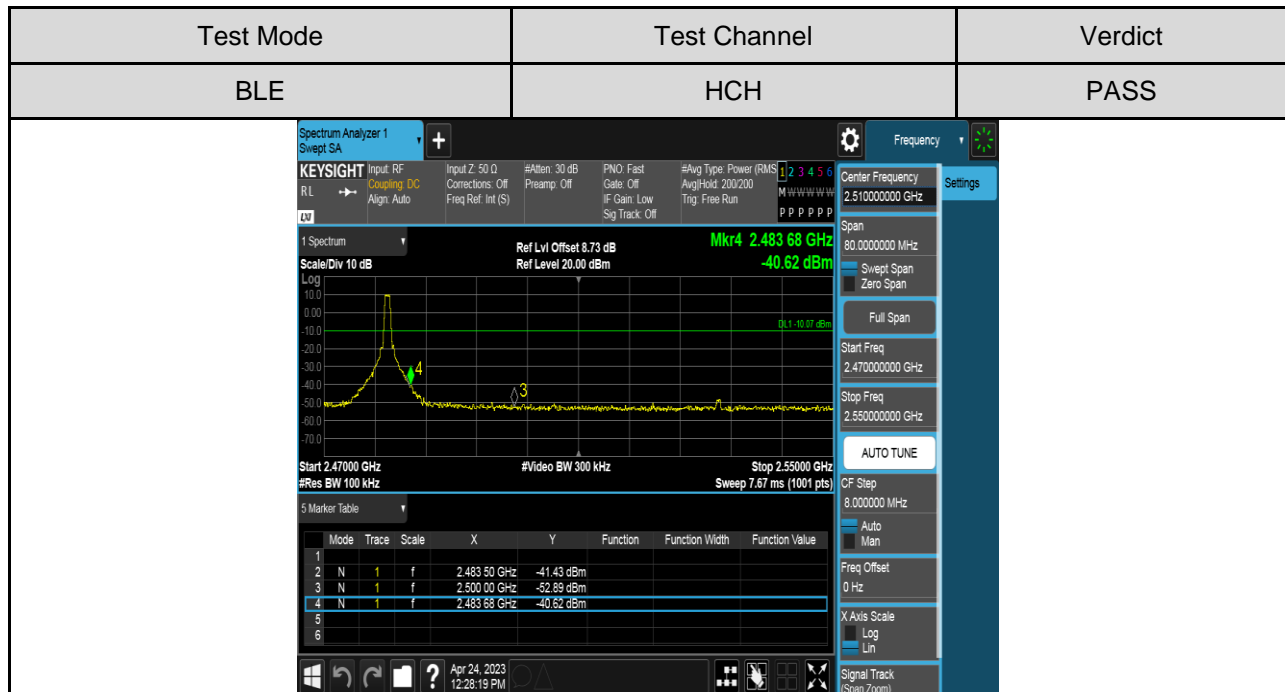
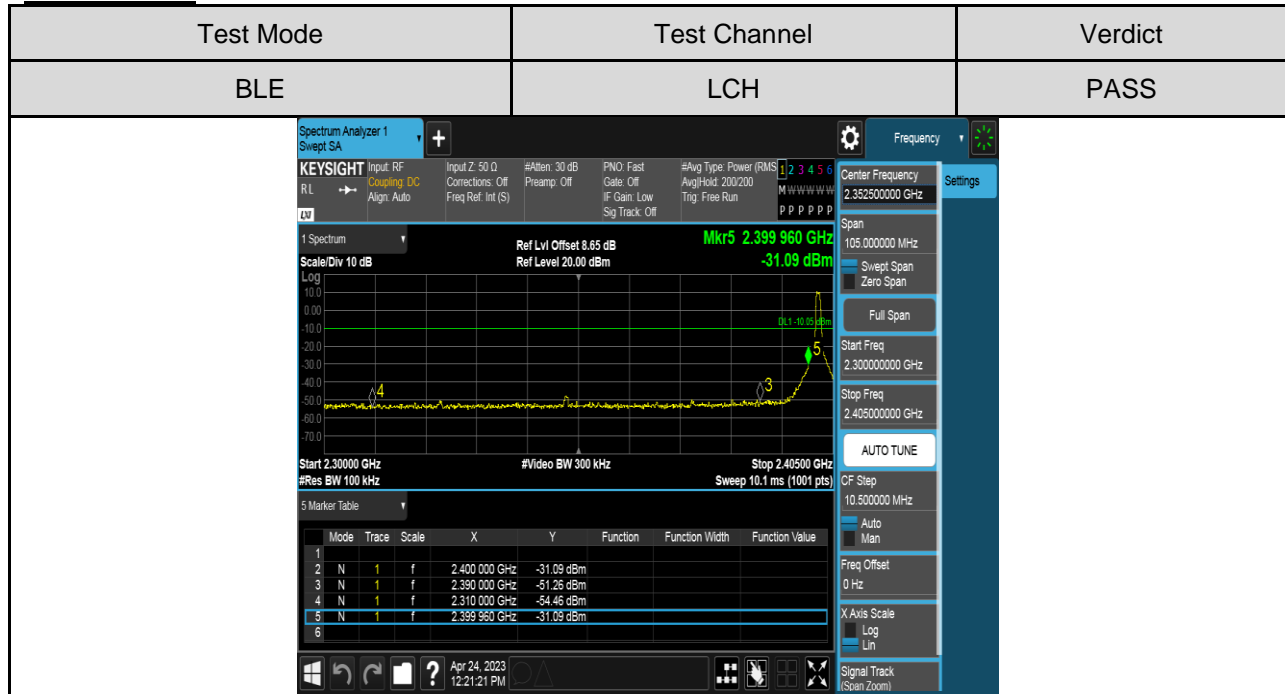

For 2M Part:

Test Mode	Test Channel	Verdict
BLE	LCH	PASS

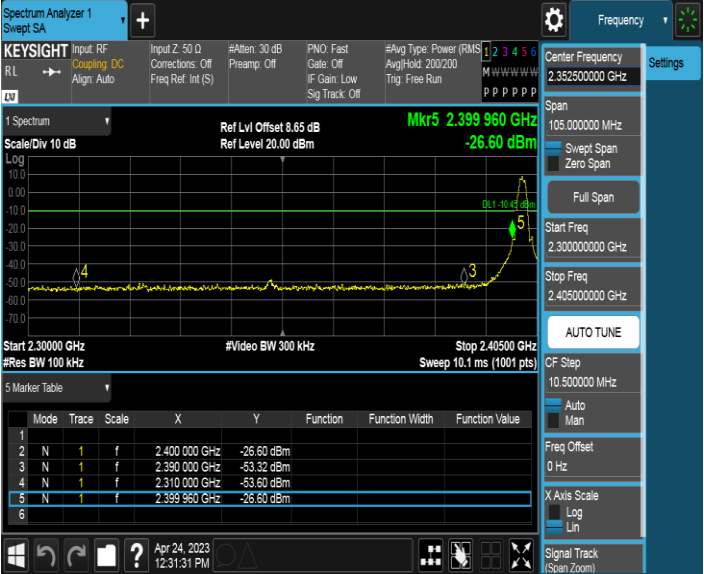

Mode	Trace	Scale	X	Y	Function	Function Width	Function Value
1	N	f	2.400 000 GHz	-26.60 dBm			
2	N	f	2.390 000 GHz	-53.32 dBm			
3	N	f	2.310 000 GHz	-53.60 dBm			
4	N	f	2.399 960 GHz	-26.60 dBm			
5	N	f	2.399 960 GHz	-26.60 dBm			
6							

Test Mode	Test Channel	Verdict
BLE	HCH	PASS



Mode	Trace	Scale	X	Y	Function	Function Width	Function Value
1	N	f	2.483 50 GHz	-40.58 dBm			
2	N	f	2.500 00 GHz	-52.43 dBm			
3	N	f	2.483 60 GHz	-40.45 dBm			
4	N	f	2.483 60 GHz	-40.45 dBm			
5							
6							

PART 3: CONDUCTED SPURIOUS EMISSION**TEST RESULTS TABLE**

Test Mode	Test Channel	Result	Verdict
BLE-1M	LCH	Refer to the Test Graph	PASS
	MCH	Refer to the Test Graph	PASS
	HCH	Refer to the Test Graph	PASS
BLE-2M	LCH	Refer to the Test Graph	PASS
	MCH	Refer to the Test Graph	PASS
	HCH	Refer to the Test Graph	PASS

TEST GRAPHS

For 1M Part:

Test Mode	Channel	Verdict
BLE	LCH	PASS

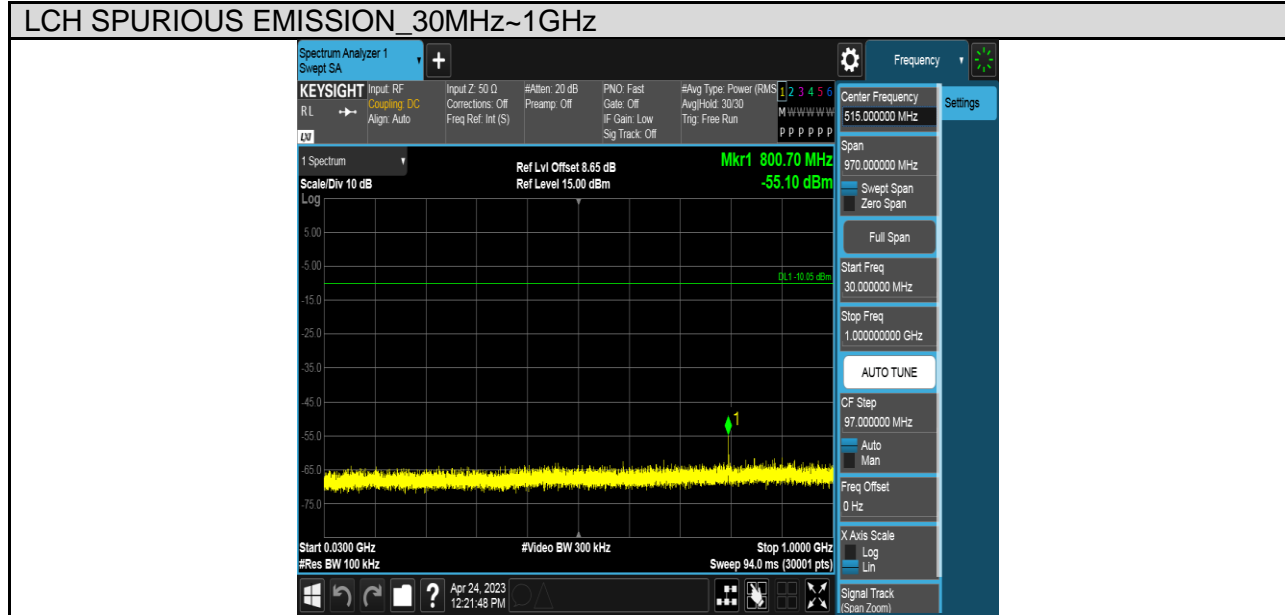

Test Mode	Channel	Verdict
BLE	MCH	PASS

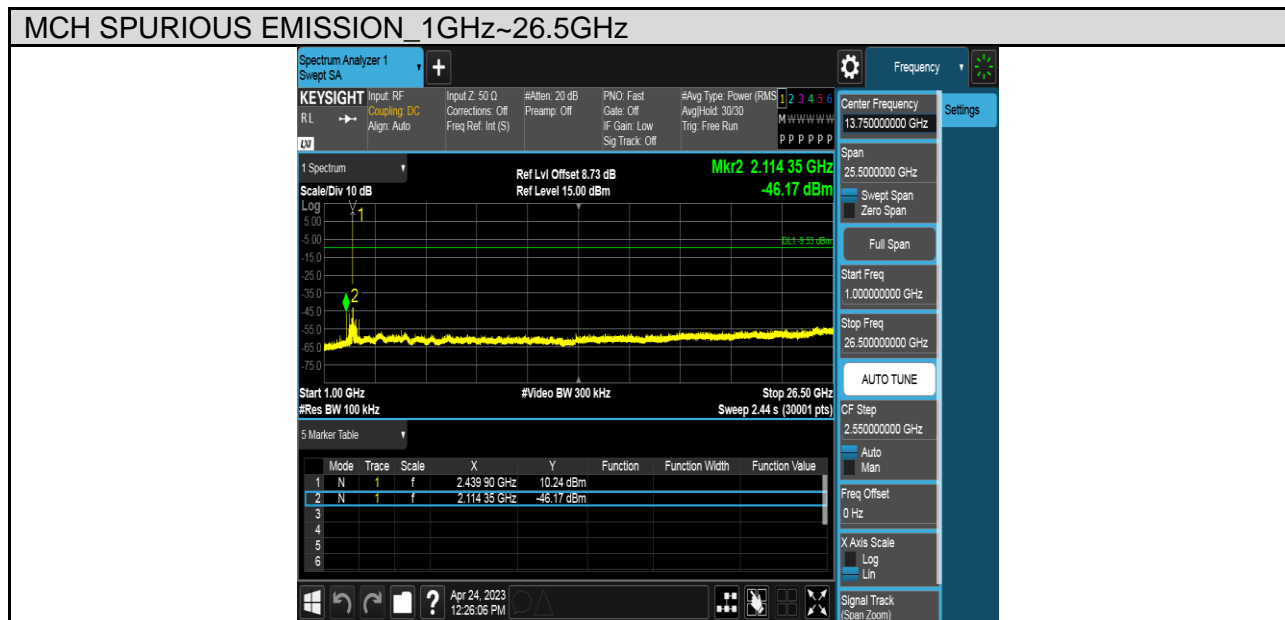
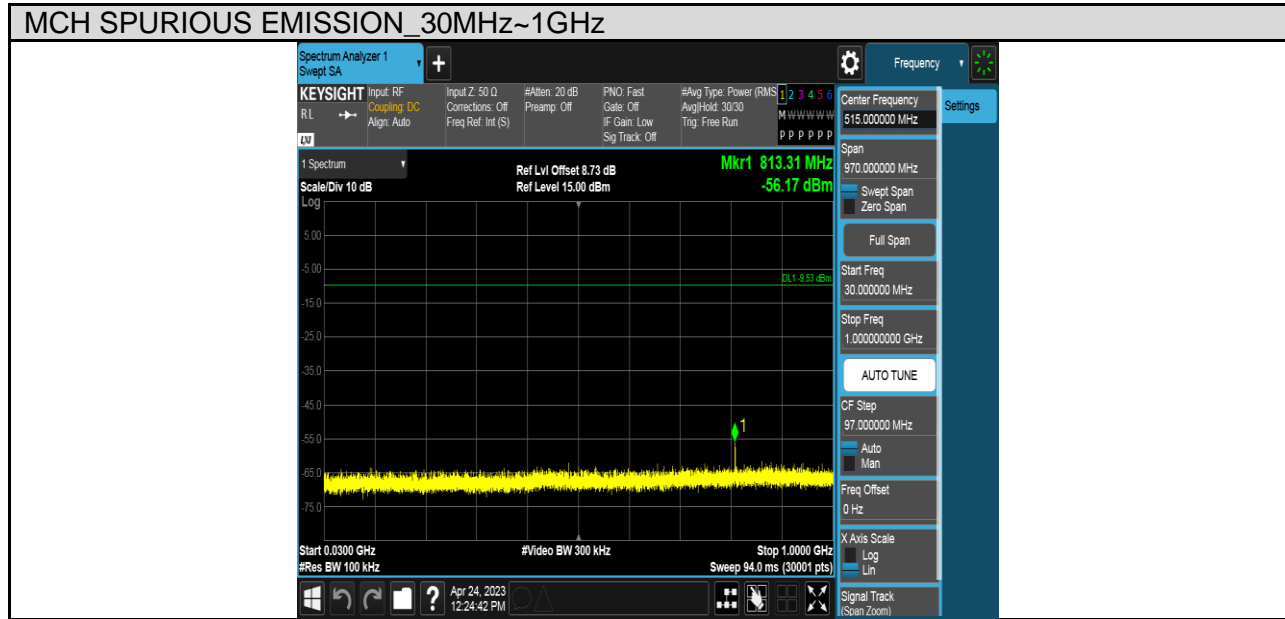

Test Mode	Channel	Verdict
BLE	HCH	PASS

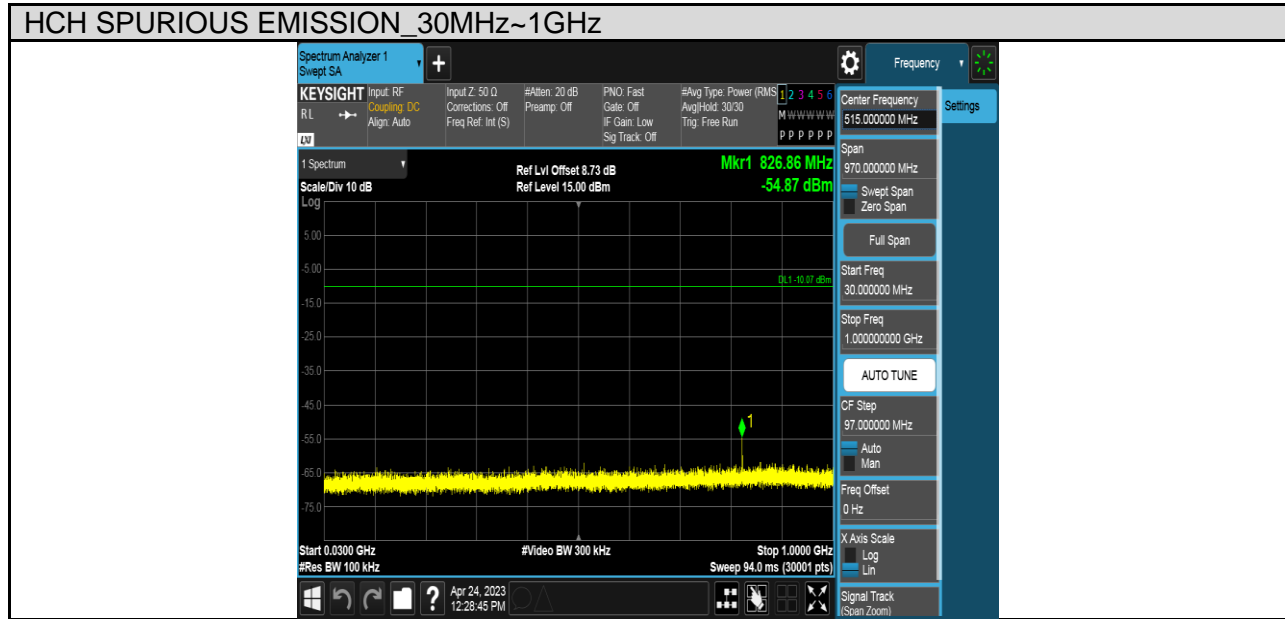

For 2M Part:

Test Mode	Channel	Verdict
BLE	LCH	PASS

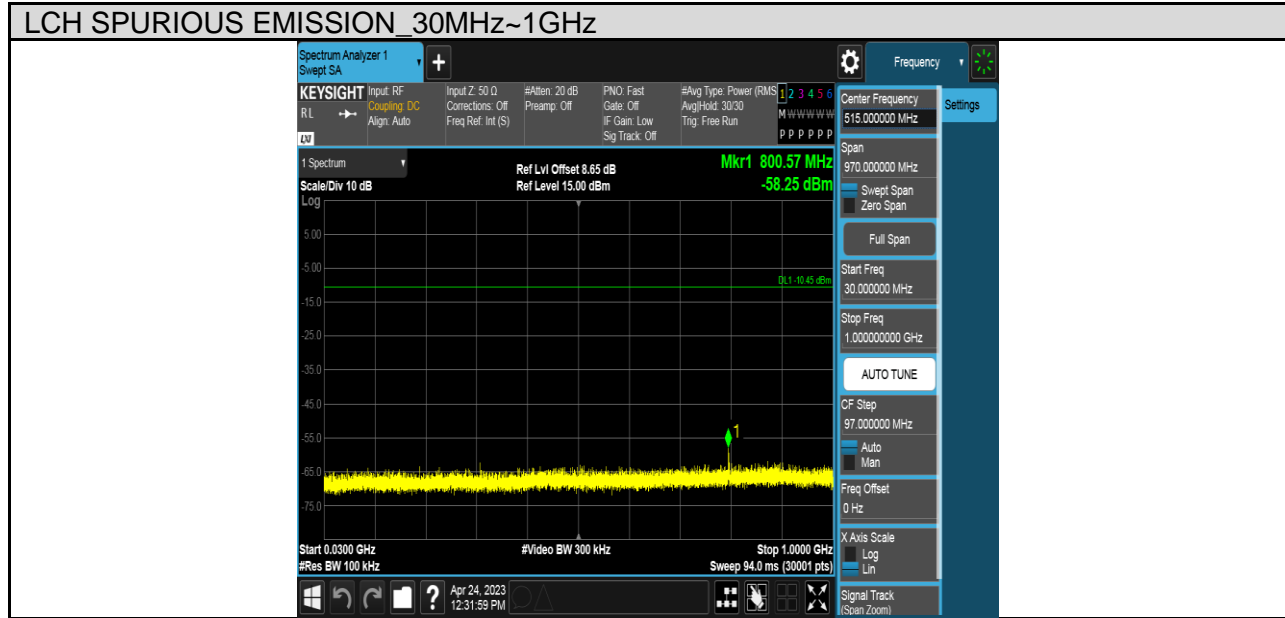

Test Mode	Channel	Verdict
BLE	MCH	PASS

