

tineco

PURE ONE S11 SERIES Smart Vacuum Cleaner

Instruction Manual

Manual De Uso

Mode D'emploi

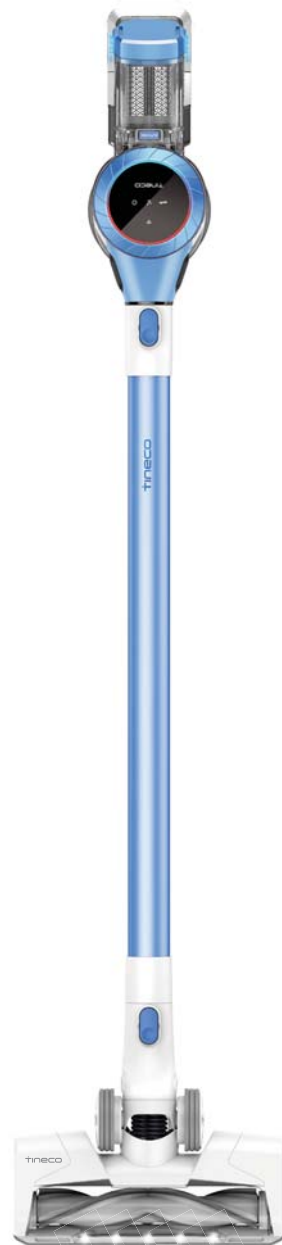

*Actual product may differ from illustration.

CONTENTS

Important Safety Instructions.....	2
Overview.....	5
Accessories.....	7
Assembly.....	9
Operation.....	11
Maintenance.....	18
Specifications.....	22
Troubleshooting.....	23
Warranty.....	25



Important Safety Instructions

SAVE THESE INSTRUCTIONS

Household use only.

When using an electrical appliance, basic precautions should always be followed, including the following:

READ ALL INSTRUCTIONS BEFORE USING (THIS APPLIANCE). Failure to follow the warnings and instructions may result in electric shock, fire and/or serious injury.

EN

WARNING – To reduce the risk of fire, electric shock, or injury:

1. This appliance can be used by children aged from 8 years and above and persons with reduced physical, sensory or mental capabilities or lack of experience and knowledge if they have been given supervision or instruction concerning use of the appliance in a safe way and understand the hazards involved. Children shall not play with the appliance. Cleaning and user maintenance shall not be made by children without supervision.
2. The appliance is not to be used by persons (including children) with reduced physical, sensory or mental capabilities, or lack of experience and knowledge, unless they have been given supervision or instruction.
3. For INDOOR use ONLY. Do not use the appliance in outdoors, nor in commercial or industrial environments. Do not use the appliance on wet surfaces or surfaces with standing water.
4. Do not allow to be used as a toy. Close attention is necessary when used by or near children, pets or plants.
5. Use only as described in this manual. Use only manufacturer's recommended attachments.
6. Do not use with a damaged cord or plug. If appliance has been dropped, damaged, left outdoors, dropped into water, or is not working as it should, return it to a service center.
7. Do not handle charger, including charger plug, and charger terminals with wet hands.
8. Do not put any object into openings. Do not use with any openings blocked; keep free of dust, lint, hair, and anything that may reduce air flow.
9. Keep hair, loose clothing, fingers, and all parts of your body away from openings and moving parts.
10. Use extra care when cleaning on stairs.
11. Do not use to pick up flammable or combustible liquids, such as gasoline, or use in areas where they may be present.
12. Do not pick up anything that is burning or smoking, such as cigarettes, matches, or hot ashes.
13. Do not use without a filter.
14. Prevent unintentional activation. Ensure the switch is in the off position before connecting to the battery pack, picking up or carrying the appliance. Carrying the appliance with your finger on the switch or powering on the appliance with the switch on may cause accidents.

15. Disconnect the battery pack from the appliance before making any adjustments, changing accessories, storing the appliance. Such preventive safety measures reduce the risk of starting the appliance accidentally.
16. For the purposes of recharging the battery, only use the detachable supply unit provided with this appliance. A charger that is suitable for one type of battery pack may create a risk of fire when used with another battery pack.
17. Use appliances only with specifically designated Tineco battery packs. Use of any other battery packs may create a risk of injury and fire.
18. When battery pack is not in use, keep it away from other metal objects, like paper clips, coins, keys, nails, screws or other small metal objects, that can make a connection from one terminal to another. Shorting the battery terminals together may cause burns or a fire.
19. Under abusive conditions, liquid may be ejected from the battery; avoid contact. If contact accidentally occurs, flush with water. If liquid comes into eye contact, seek medical help. Liquid ejected from the battery may cause irritation or burns.
20. Do not use a battery pack or appliance that is damaged or modified. Damaged or modified batteries may exhibit unpredictable behavior resulting in fire, explosion or risk of injury.
21. Do not expose a battery pack or appliance to fire or excessive temperature. Exposure to fire or temperature above 266°F (130°C) cause an explosion.
22. Follow all charging instructions and do not charge the battery pack or appliance outside of the temperature range specified in the instructions. Charging improperly or at temperatures outside of the specified range may damage the battery and increase the risk of fire.
23. Have servicing performed by a qualified repair person using only identical replacement parts. This will ensure that the safety of the product is maintained.
24. This appliance contains battery cells that are non-replaceable. Do not modify or attempt to repair the appliance or the battery pack except as indicated in the instructions for use and care.
25. Always turn off this appliance before connecting or disconnecting the motorized nozzle.
26. Do not charge or store the appliance outdoors or inside a car. Only charge, store or use the battery in a dry indoor area where the temperature is higher than 39.2°F (4°C) but lower than 104°F (40°C). The charger is for indoor use only.

FCC Supplier's Declaration of Conformity

Tineco / PURE ONE S11 SERIES

VS110100US, VS110100CA, VS110200US, VS110200CA, VS110300US, VS110300CA, VS110400US, VS110400CA, VS110500US, VS110500CA, VS110600US, VS110600CA, VS110700US, VS110800US, VS111000CA, VS111000US, VS111100US, VS111100CA

This appliance complies with part 15 of the FCC Rules. Operation is subject to the following two conditions:

(1) This appliance may not cause harmful interference, and (2) this appliance must accept any interference received, including interference that may cause undesired operation.

Tineco INTELLIGENT, INC.
1700 WESTLAKE AVENUE N., SUITE 200, SEATTLE, WA, 98109, USA
WWW.TINECO.COM
1-855-292-8864

Changes or modifications not expressly approved by the party responsible for compliance could void the user's authority to operate the equipment.

Note: This equipment has been tested and found to comply with the limits for a Class B digital appliance, pursuant to Part 15 of the FCC Rules. These limits are designed to provide reasonable protection against harmful interference in a residential installation.

This equipment generates uses and can radiate radio frequency energy and, if not installed and used in accordance with the instructions, may cause harmful interference to radio communications. However, there is no guarantee that interference will not occur in a particular installation. If this equipment does cause harmful interference to radio or television reception, which can be determined by turning the equipment off and on, the user is encouraged to try to correct the interference by one or more of the following measures:

- (1) Reorient or relocate the receiving antenna.
- (2) Increase the separation between the equipment and receiver.
- (3) Connect the equipment into an outlet on a circuit different from that to which the receiver is connected.
- (4) Consult the dealer or an experienced radio/TV technician for help.

FCC Radiation Exposure Statement

This equipment complies with FCC radiation exposure limits set forth for an uncontrolled environment. This equipment should be installed and operated with a minimum distance of 20cm between the radiator and any part of your body.

Note

The manufacturer is not responsible for any radio or TV interference caused by unauthorized modifications to this equipment, such modifications could void the user's authority to operate this equipment.

IC Note

This appliance contains licence-exempt transmitter(s)/receiver(s) that comply with Innovation, Science and Economic Development Canada's licence-exempt RSS(s). Operation is subject to the following two conditions:

- (1) this appliance may not cause interference.
- (2) this appliance must accept any interference, including interference that may cause undesired operation of the appliance.

-This Class B digital apparatus complies with Canadian ICES-003.

-This equipment complies with ISED RSS-102 radiation exposure limits set forth for an uncontrolled environment. This equipment should be installed and operated with a minimum distance of 20cm between the radiator and any part of your body.

Overview

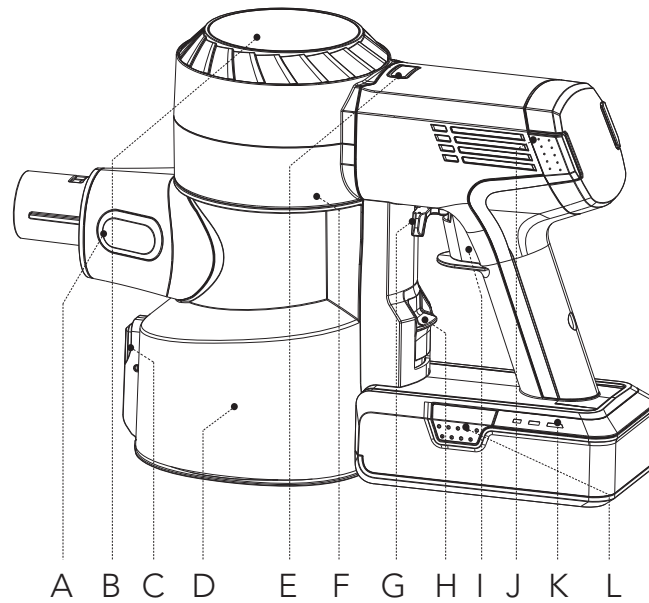

- A. Dust sensor
- B. Digital display
- C. Dust empty release button
- D. Dustbin
- E. AUTO/MAX button
- F. WiFi reset button
(Remove the dustbin to access)
- G. Trigger lock
- H. Dustbin release button
- I. Trigger
- J. HEPA release button
- K. Battery indicator light
- L. Battery release button

Digital Display

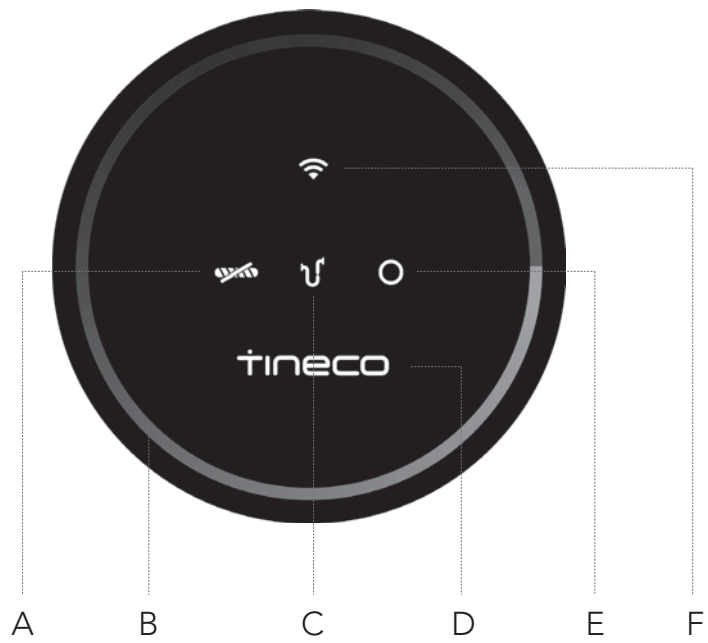

- A. Brush roller tangled
- B. Dust monitoring loop
(Blue to red according to the dust amount)
- C. Air channel blocked
- D. Tineco logo
- E. Dust sensor malfunction
- F. WiFi indicator

Accessories

Note:

- Test an accessory on a small, inconspicuous area before use on sensitive surfaces.
- The packaging box shows which accessories are included with your purchase.
- As shown below, there are many components compatible with this model. If you require more accessories, please go to www.tineco.com or store.tineco.com.

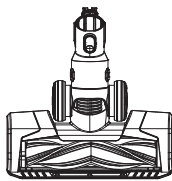

Full-size LED multi-tasker power brush

Ideal for both hard floors and carpets.
Very effective for agitating dirt embedded in the carpet.

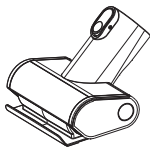

Mini power brush

For vacuuming upholstered furniture, mattresses, etc.
Vacuums pet hair and removes ingrained dirt.

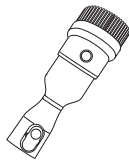

2-in-1 dusting brush

Switches between a wide and a soft brush by pressing the release button. The soft brush is most effective on hard-surface furniture while the wide brush is effective for upholstered furniture, curtains, etc.

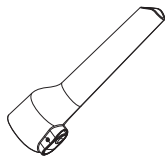

Crevice tool

For corners, nooks, and other hard-to-reach places such as around car seats, picture frames, and cupboards.



Soft dusting brush

Angled bristles on a slender, oval-shaped rim provide anti-static, cushioned contact. Suitable for dusting shelves, lighting, delicate surfaces, electronics and more.

EN

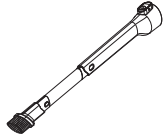

Flexible long crevice tool

Easy to bend, easy to reach tight spots. Suitable for cleaning dust behind and beneath furniture, around refrigerators, and many other tight gaps.

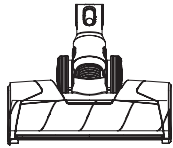

Full-size LED soft-roller power brush

Perfect for hard floors, especially sensitive wood floor. Picks up coarse and fine dirt at the same time.

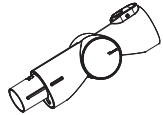

Multi-angle folding tube

An articulated joint makes it adjustable to allow for flexibility when cleaning from high to low.



Flexible extension hose

Excellent extension and flexibility to access hard-to-reach spaces; perfect for in-care use. Compatible with all non-motorized Tineco accessories.

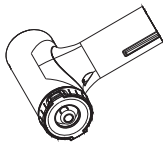

Pre-filter cleaning tool

A dirty filter is a leading cause of suction loss, and this device is designed to make your filter last much longer. Place the dirty filter inside the pre-filter cleaning tool and close the lid. Run the appliance in MAX mode, and rotate the side cover.



Hair cleaning tool

Use the end with the small blade to remove hair and debris wrapped around the roller. Use the end with the brush to clean the brush window, and the dustbin, as required.

Assembly

Tube Installation

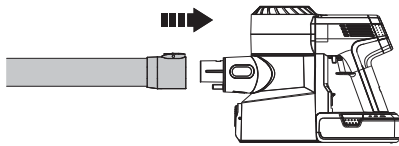

Insert tube.

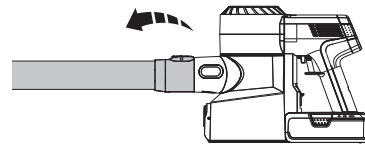

Press the release button to remove the tube.

EN

Brush Installation

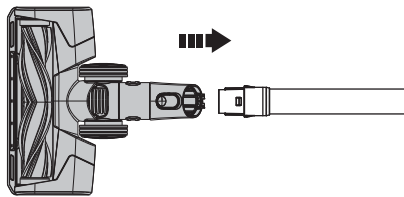

Insert the power brush.

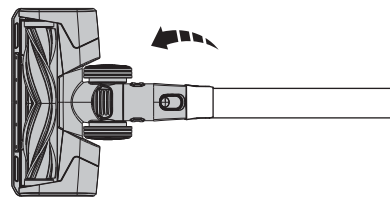

Press the release button to remove the power brush.

Dustbin Installation

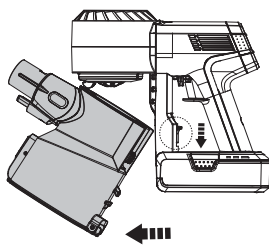

To clean the dustbin more thoroughly, press the dustbin release button to detach from the appliance.

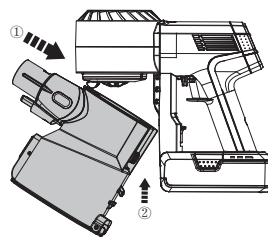

When re-attaching the dustbin, hold on an angle and slot the top of the dustbin into the hook on the main body. Push upwards until the hook is fixed into the slot on the dustbin and then it clicks back into place.

Battery Installation

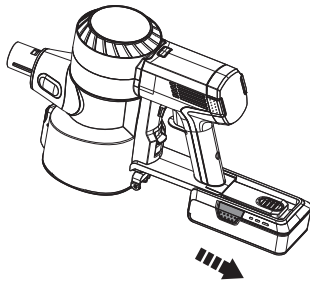

EN

Press the battery release button, and remove the battery.

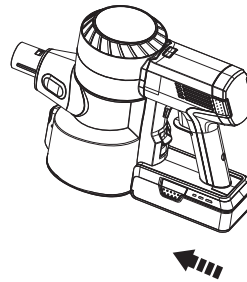

To replace, slide the battery into the slot at the base of the main body. The battery will click into position when correctly fitted.

Wall-mounted Dock Installation

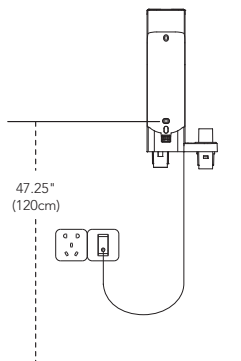

Determine the best wall location for mounting the dock. We recommend placing it 47.25" (120cm) from the lower fixing to the floor (may need to be adjusted based on the actual situation).

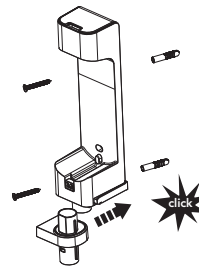

Assemble the two bracket components, with a "click" to signify correct assembly. Once this is complete, use the screws provided by Tineco to affix the dock to the wall.

Warning:

- Ensure the wall surrounding the mounting area is free of gas, water pipes, electrical cables and wires.
- To avoid the dock falling, ensure it is firmly installed.

Operation

Preparing for Use

Note:

- Before the first use, please charge the appliance (see "Charging the Battery") for 3-4 hours in an area where the ambient temperature is between 39.2°F (4°C) and 104°F (40°C).
- Select an accessory and attach it to the appliance before use (see "Accessories").

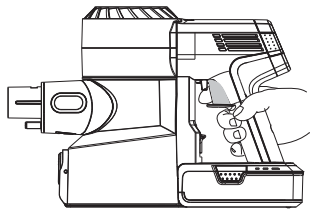

Pull the trigger to activate the suction.

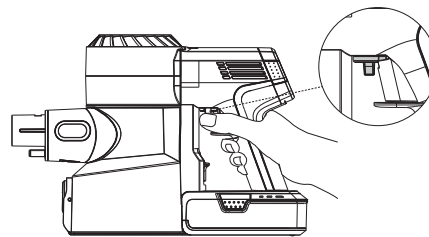

Pull the trigger lock to hold the trigger for continuous power mode.

EN

- Keep sharp objects away from the digital display to avoid scratches and scrapes.

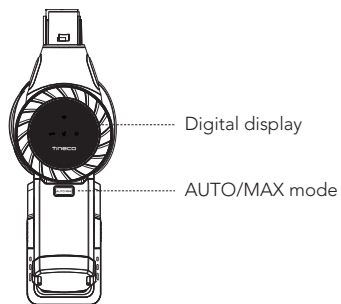

The appliance will start in AUTO mode by default. After 3 seconds, press the AUTO/MAX button to switch to Max mode and the button lights up.

Cleaning Mode Selection

AUTO Mode

- In AUTO mode, the color of dust monitoring loop changes according to the amount of dust detected. A red dust monitoring loop indicates more dust is detected whereas a blue loop indicates less is detected. This mode automatically provides the best cleaning solution.

To enter AUTO mode:

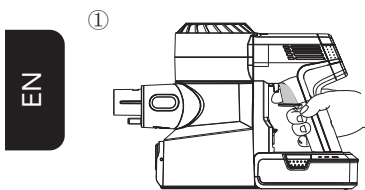

The default setting on startup is AUTO. The appliance then takes 3 seconds to initially detect blockages or dust. If no dust is detected, power is reduced to conserve energy.

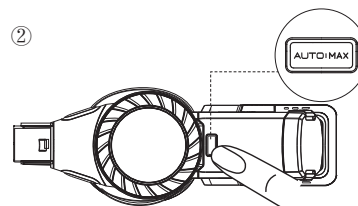

When in MAX mode, press the AUTO/MAX button to enter AUTO mode.

MAX Mode

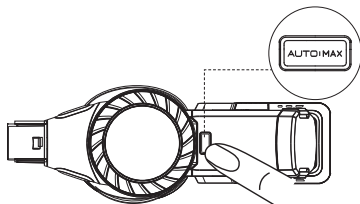

In AUTO mode, press the AUTO/MAX button to enter MAX mode and the button lights up.

APP

- All the functions can be performed using the Tineco app. Download the Tineco app from the App Store, Google Play and Tineco Official Site.

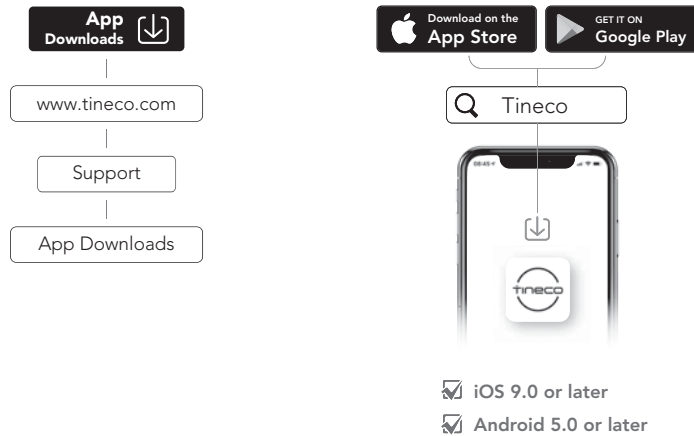

EN

App Function Introduction



Battery
Battery level in real time.



Cleaning report
Displays the dust amount, working hours and working status.



Suction adjustment
When in manual mode, swipe the phone screen to adjust suction power.



Reminder of filter status
Records the severity of the dirty filter and provides a cleaning reminder as required.



Contact us
You can contact the Customer Service about any problems during the working hours.



Feedback
If you have any comments, please send us your feedback.

Emptying the Dustbin

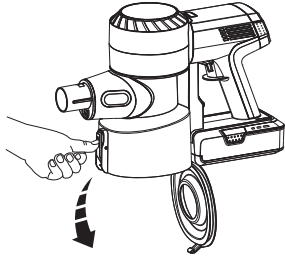

EN

When finished, press the release button on the side of the dustbin to empty the contents.

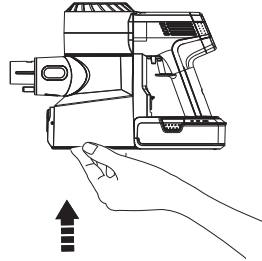

Close and click the dustbin flap back into place.

- Place the appliance on the wall-mounted dock for convenient storage and recharging after use.

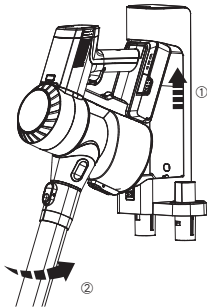

Place the main body on the dock.

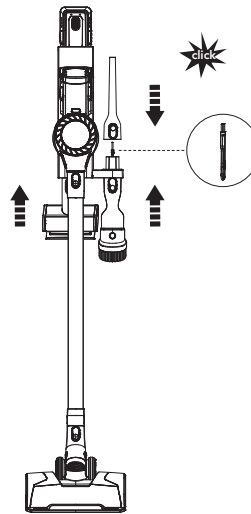

To avoid bristle damage, always place attachments on the dock after use.

Charging the Battery

- When secured on the wall-mounted dock, the battery attached to the main body will charge first, followed by the spare battery (sold separately for PURE ONE S11).

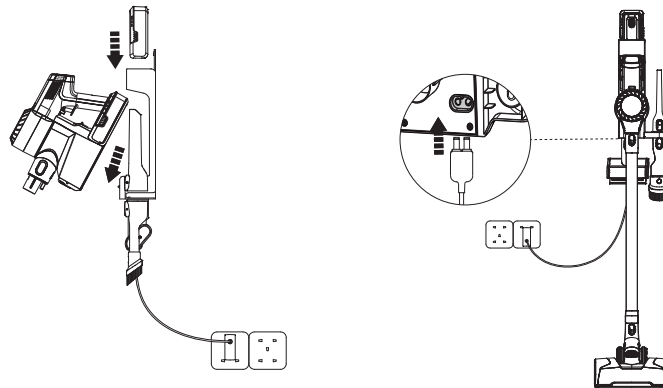

Connect the adaptor to the dock and outlet.

To charge, secure the main body and/or the spare battery on the dock. The battery can be recharged while attached to the main body, or separately.

Note:

- If you need a spare battery, please purchase from Tineco.

Warning:

- Only use the Tineco-provided adaptor to charge the battery.
- During long periods of not being used, store the lithium battery in a cool, dry place. Ensure the battery is half-charged every 3 months (2 battery indicators illuminated).
- Store appropriately indoors in a dry place. Do not expose appliance to sunlight or freezing temperature. Recommended temperature range: 39.2°F (4°C)~104°F (40°C).

Runtime

- When in AUTO mode, the runtime is approximately 40 minutes. When MAX power is used, the runtime is approximately 10 minutes.
- Estimated runtime data was obtained by a Tineco Laboratory using one battery and non-motorized accessories.

Charging Time

- A full charge takes approximately 3-4 hours for one battery.
- Estimated data was obtained by a Tineco Laboratory using ambient temperatures between 39.2°F (4°C) to 104°F (40°C).

EN

Indicator

When in Use

Battery Indicator



Three solid blue lights: full power.



Two solid blue lights: medium power.



One solid blue light: low power.



One solid red light: out of power.



One blinking red light: fault, check the troubleshooting guide.

Main Body Indicator



Illuminated: working on MAX mode.



Blinking: motor failure.

Indicators on Display



Blinking: brush roller has a blockage.

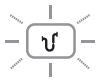

Blinking: appliance has a blockage, either in the filter or the dustbin.



Blinking: sensor inside the dustbin is obstructed, or the dustbin is not correctly installed.



Illuminated: WiFi has successfully connected.



Blinking: WiFi is connecting.



Off: WiFi is not connected, please connect.



During Charging

- The spare battery will only charge when the one attached to the main body has been fully charged. (spare battery sold separately for PURE ONE S11).



Three blue lights blinking successively: charging.



One blinking red light: fault, check the troubleshooting guide.

Fully Charged



In 5 minutes: three solid blue lights.



After 5 minutes: lights off.

Maintenance

Note:

- Clean the dustbin and filters after each use.
- Use the cleaning tool to thoroughly clean the pre-filter when the indicator light shows a blocked air channel. To maintain high performance, wash and dry the pre-filter monthly, replacing it every 6 months.
Wash and dry the HEPA filter every 3 months, replacing it every 12 months.

EN

Dustbin and Filters (mesh filter, pre-filter and HEPA filter)

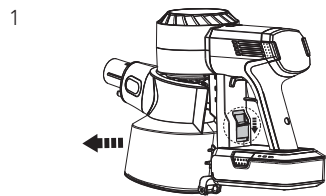

1 Press the dustbin release button to remove the dustbin.

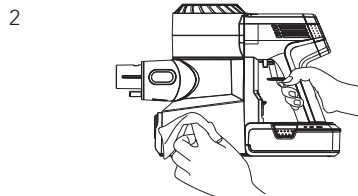

2 Clean with a damp cloth, taking care to prevent water entering the appliance main body and battery.

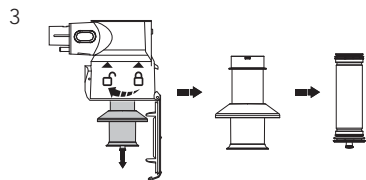

3 Turn counter-clockwise to remove the filters.

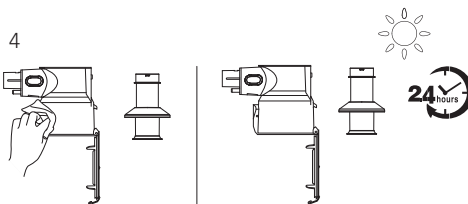

4 Clean the dustbin and mesh filter with a damp cloth. Air dry completely before reinstalling.

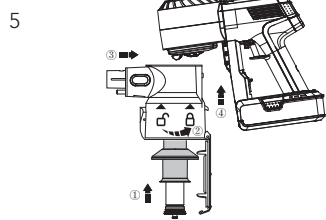

5 After cleaning, insert the clean pre-filter into the mesh filter properly and it clicks into place. Install the clean filter and dustbin back into the main body, then close the dustbin flap.

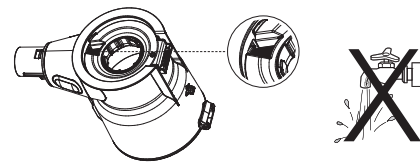

Warning:

- Do not wash the dustbin as it contains a dust sensor. If it comes into contact with water, please dry it with a hair dryer.

Pre-filter

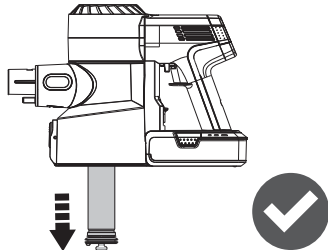

Ensure the appliance is switched off before cleaning, and remove the dirty pre-filter from the mesh filter-holder.

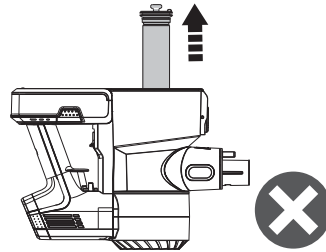

Do not turn the appliance upside down when removing or installing the filter to prevent dust from entering the air channel of the motor.

EN

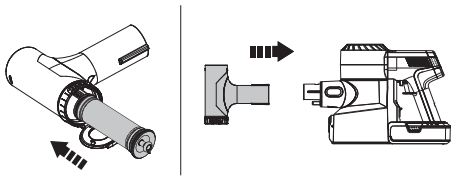

Replace a clean filter to the main body. Put the dirty pre-filter into the cleaning tool and connect the cleaning tool to the main body.

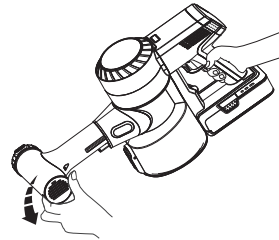

Run the appliance in MAX mode, and rotate the side cover to clean the dirty pre-filter.

Dust Sensor

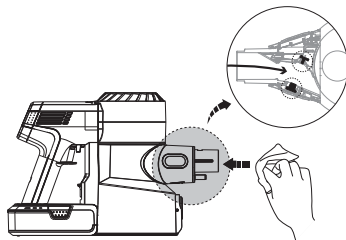

To avoid dust accumulation which can affect cleaning performance, wipe the suction mouth with a damp cloth.

HEPA Filter

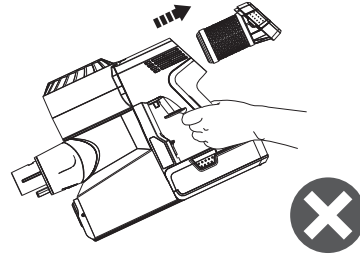
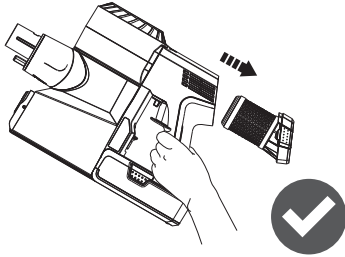

EN

Press the HEPA release button and gently remove for cleaning. Do not use the appliance without first installing the HEPA filter.

Do not place the appliance as above when removing or installing the HEPA filter, to prevent dust from entering the motor.

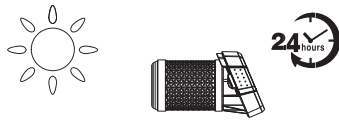
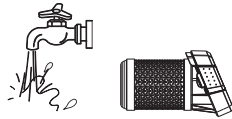

The HEPA filter can be washed under running water and must be completely dry before reinstalling.

Mini power brush

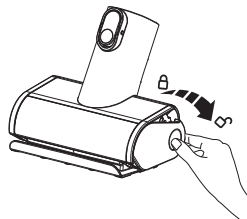

Press against the roller end cover downward.

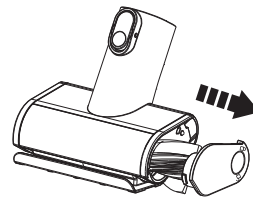

Pull out the brush roller.

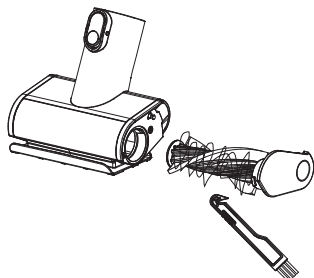

Remove the debris wrapped around the roller with the Tineco Hair Cleaning Tool.

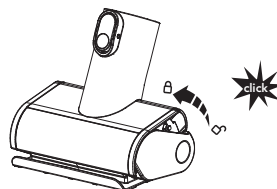

Fully reinsert the brush roller at an angle and push upward until it clicks securely back into place.

EN

Brush Roller

1

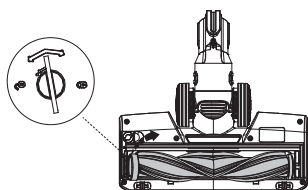

Use a coin or other tool, to unlock the brush roller lock, then remove the brush from the brush window.

2

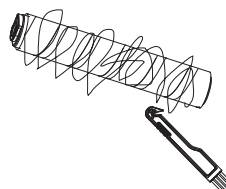

Remove the debris wrapped around the roller with the Tineco Hair Cleaning Tool.

3

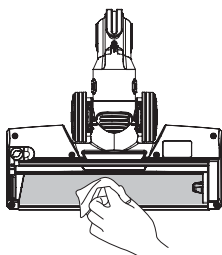

Gently clean the transparent brush window.

4

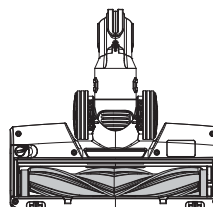

After cleaning, reinstall the brush.



Warning:

- The power brush contains electrical components which must not be soaked or washed with water.

Specifications

Product	PURE ONE S11 SERIES
Voltage	21.6V $\overline{=}$
Rated Power	450W
Dustbin Capacity	0.6L
Charging Time	3-4 hrs for one battery
Charging Input	100-120V~
Running Time (2*2000mAh Li-ion)	AUTO: ~30 mins*2 MAX: ~9 mins*2
Running Time (1*2500mAh Li-ion)	AUTO: ~40 mins MAX: ~10 mins
WiFi Frequency Bands	2.4G
WiFi Maximum Output Power	19dB







Disposal

- The battery contains materials that are harmful to the environment and must be removed from the appliance before it is discarded.
- When removing the battery, the appliance must be powered off.
- Batteries, chargers, accessories and packaging should be sorted for environmental friendly recycling. Do not put them into fire, water or soil. Do not dispose of batteries and chargers into household waste! 
- If battery leakage contacts skin or clothing, immediately flush with water to avoid irritation and seek medical help.

Troubleshooting

Problem	Possible cause	Solution
The appliance does not turn on	No power	Charge the battery
	Auto protection for overheating	Restart after cooling down
	The appliance is blocked (i.e. the tube, suction mouth or some other parts)	Check and remove blockages
Weak suction power	Dustbin and filters are full	Clean the dustbin and filters
	The pre-filter is not installed	Install the pre-filter
	The appliance is blocked (i.e. the tube, suction mouth or some other parts)	Remove blockages
	The brush roller tangled with hairs or fibers	Clean the brush roller
Abnormal motor sounds	The appliance is blocked (i.e. the tube, suction mouth or some other parts)	Remove blockages
Battery won't charge	The adaptor is not correctly inserted	Reinsert the adaptor correctly
	Insufficient contact between the main body and battery	Check the main body and battery are correctly placed
	The adaptor is not designed for PURE ONE S11	Use the original adaptor

EN

Problem	Possible cause	Solution
Indicator light blinking on work 	Motor failure	Check the motor and cool it down
Brush roller tangled indicator blinking 	The brush roller is blocked	Remove blockages
Air channel blocked indicator blinking 	The appliance is blocked, or full of dust in filter and dustbin	Remove blockages, clean the filter and dustbin
Dust sensor malfunction indicator blinking 	<ol style="list-style-type: none"> 1. The sensor inside the dustbin is blocked 2. The dustbin is not installed 	<ol style="list-style-type: none"> 1. Clean the dust on the inner sensor 2. Install the dustbin correctly
WiFi indicator is off 	WiFi is not connected	Follow the in-app guide to connect to WiFi
Battery indicator blinking red on work 	Battery failure	Remove the battery pack and let it cool

Note:

In any other case or if the solution explained above did not solve the problem, please contact us at support@tineco.com or visit our website www.tineco.com for further support.

Warranty

2-YEAR LIMITED WARRANTY

- Only applies to purchases made from authorized retailers of Tineco.
- Is subject to the adherence of the requirements outlined in this instruction manual, and is subject to further conditions outlined below.

WHAT IS COVERED?

- Your Tineco appliance has a 2-year warranty against original defects in material and workmanship, when used for private household purposes in accordance with the Tineco Instruction Manual. Motorized accessories and battery bought separately come with a 1-year warranty.
- This warranty provides, at no extra cost to you, all labor and parts necessary to ensure your appliance is in proper operating condition during the warranty period.
- This warranty will only be valid if the appliance is used in the country in which it was sold.

EN

WHAT IS NOT COVERED?

Tineco shall not be liable for costs, damages or repairs incurred as a result of:

- Appliances purchased from an unauthorized dealer.
- Careless operation or handling, misuse, abuse and/or lack of maintenance or use not in accordance with the Tineco Instruction Manual.
- Use of the appliance other than for normal domestic purposes, e.g. for commercial or rental purposes.
- Use of parts not in accordance with the Tineco Instruction Manual.
- Use of parts and accessories other than those produced or recommended by Tineco.
- External factors unrelated to product quality and use, such as weather, modifications, accidents, electrical outages, power surges or acts of God.
- Repairs or alterations carried out by unauthorized parties or agents.
- Failing to clear blockage and other hazardous material from the appliance.
- Normal wear and tear, including normal wearing parts, such as clear bin, belt, filter, HEPA, brush bar, and power cord (or where external damage or abuse is diagnosed), carpet or floor damage due to use not in accordance with manufacturer's instructions or failure to turn the brush bar off when necessary.
- Reduction in battery discharge time due to battery age or use.

WARRANTY LIMITATIONS

- Any implied warranties relating to your appliance including but not limited to warranty of merchantability or warranty of fitness for a particular purpose, are limited to the duration of this warranty.
- Warranty coverage applies to the original owner and to the original battery only and is not transferable.
- This limited warranty gives you specific legal rights. You may also have other rights which vary by region.
- Manufacturer’s warranties may not apply in all cases, depending on factors such as use of the product, where the product was purchased, or who you purchased the product from.
Please review the warranty carefully, and contact the manufacturer if you have any questions.

WARRANTY SERVICE

Register: We highly recommend that upon purchase, you register your appliance on the Tineco official website (www.tineco.com/register) and enjoy exclusive benefits. To register, please enter the last 10 digits of the serial number (remove the dustbin to find the serial number).

Failure to register your product won’t diminish your warranty rights.



How to Claim: Please retain your proof of purchase. To make a claim under our Limited Warranty, you need to provide your serial number and the original purchase receipt with the purchase date and order number on it.

All work will be carried out by Tineco or an authorized agent.

Any replaced defective parts will become the property of Tineco.

Service under this warranty will not extend the period of this warranty.

If your appliance is not functioning properly, please email us: support@tineco.com

Call our Customer Service:
1-855-292-8864
Or email our Customer Service:
support@tineco.com
Visit Tineco Website:
www.tineco.com

CONTENIDO

Medidas importantes de seguridad	28
Descripción general	31
Accesorios	33
Montaje	35
Funcionamiento	37
Mantenimiento	44
Especificaciones	48
Resolución de problemas	49
Garantía	51



Medidas importantes de seguridad

CONSERVE ESTAS INSTRUCCIONES

Solo para uso doméstico.

Al usar aparatos eléctricos se deben seguir siempre una serie de medidas básicas de seguridad, entre ellas las siguientes:

LEA TODAS LAS INSTRUCCIONES ANTES DE USAR ESTE APARATO. De no seguir todas las advertencias e instrucciones, se podrían producir descargas eléctricas, un incendio y/o lesiones personales graves.

ADVERTENCIA – Para disminuir el riesgo de incendios, descargas eléctricas o lesiones:

ES

1. Este aparato puede ser utilizado por niños a partir de 8 años y personas con discapacidades físicas, sensoriales o mentales, o con falta de experiencia y conocimientos, si están supervisados o han recibido instrucciones sobre el uso del aparato de modo seguro y comprenden los peligros que dicho uso acarrea. Los niños no deberán jugar con el aparato. La limpieza y mantenimiento a cargo del usuario no deberán ser realizados por niños sin supervisión.
2. El aparato no debe ser utilizado por personas (niños incluidos) con discapacidades físicas, sensoriales o mentales, o con falta de experiencia y conocimientos, a menos que lo hagan bajo supervisión o se les haya dado instrucciones.
3. SOLO para uso en INTERIORES. No use el aparato en el exterior, ni en entornos comerciales o industriales. No use el aparato sobre superficies húmedas o que tengan agua.
4. No permita que se utilice el aparato como un juguete. Es necesario vigilar atentamente cuando niños usen el aparato o se utilice en la cercanía de niños, mascotas o plantas.
5. Use el aparato solo como se indica en este manual. Use solo accesorios recomendados por el fabricante.
6. No use el aparato si el cable o el enchufe están dañados. Si el aparato se ha caído o dañado, se ha dejado a la intemperie, ha caído al agua o no funciona como debiera, llévelo a un centro de servicio.
7. No manipule el cargador, incluido el enchufe del cargador, ni los terminales del cargador con las manos mojadas.
8. No introduzca ningún objeto en las aberturas. No use el aparato si alguna de sus aberturas está obstruida. Manténgalo sin polvo, fibras, pelo y cualquier elemento que pudiera reducir el flujo de aire.
9. Mantenga el pelo, la ropa holgada, los dedos y todas las partes del cuerpo alejados de las aberturas y partes móviles.
10. Lleve mucho cuidado al limpiar escaleras.
11. No aspire líquidos inflamables o combustibles, tales como, gasolina, ni lo use en lugares donde pudieran estar presentes.
12. No aspire nada que se esté quemando o humeando, por ejemplo, cigarrillos.
13. No use el aparato sin el filtro.
14. Evite puestas en marcha accidentales. Verifique que el interruptor está en posición de apagado antes de conectar la batería, tomar el aparato o desplazarlo. Llevar el aparato con el dedo en el interruptor o activar el aparato con el interruptor en posición de

- encendido puede originar accidentes.
15. Desconecte la batería del aparato antes de realizar ajustes, cambiar accesorios o almacenarlo. Tales medidas preventivas disminuyen el riesgo de poner el aparato en funcionamiento por accidente.
 16. Para cargar la batería, use únicamente la unidad separable de suministro incluida con este aparato. Un cargador apto para un tipo de batería podría presentar un riesgo de incendio si se usa con otra batería.
 17. Use los aparatos solo con las baterías Tineco especialmente diseñadas. El uso de cualquier otro tipo de batería puede presentar riesgos de incendio y lesiones personales.
 18. Cuando no esté usando la batería, manténgala alejada de objetos metálicos, tales como clips, monedas, llaves, clavos, tornillos y otros objetos metálicos pequeños que pudieran conectar un terminal con el otro. Cortocircuitar los terminales de la batería puede causar quemaduras o un incendio.
 19. Si se hace un mal uso de la batería, el líquido de su interior podría salirse. Evite el contacto con ese líquido. Si hubiera un contacto accidental, lávese con agua abundante. Si el líquido entra en contacto con los ojos, solicite ayuda médica. El líquido que sale de la batería puede causar irritación o quemaduras.
 20. No use la batería ni el aparato si estuvieran dañados o modificados. Las baterías dañadas o modificadas pueden presentar comportamientos impredecibles y causar un incendio, explosión o riesgo de lesiones personales.
 21. No exponga la batería ni el aparato al fuego o al calor excesivo. Su exposición al fuego o a temperaturas superiores a 130 °C puede causar una explosión.
 22. Siga todas las instrucciones de carga y no cargue la batería o el aparato a temperaturas fuera del rango especificado en las instrucciones. Una carga incorrecta o a una temperatura fuera del rango especificado puede dañar la batería y aumentar el riesgo de que se produzca un incendio.
 23. Las reparaciones deben ser realizadas por personal cualificado que utilice únicamente piezas de repuesto idénticas a las originales. Esto garantizará que la seguridad del producto se mantenga.
 24. Este aparato posee células de batería no reemplazables. No modifique ni trate de reparar el aparato o la batería, a excepción de lo indicado en las instrucciones para su uso y cuidados.
 25. Apague siempre el aparato antes de conectar o desconectar la boquilla motorizada.
 26. No cargue ni guarde el aparato a la intemperie ni dentro de un vehículo. Solo cargue, guarde o use la batería en interiores secos donde la temperatura sea superior a 4 °C, pero inferior a 40 °C. El cargador solo es apto para usarse en interiores.

Declaración de conformidad del proveedor de la FCC

Tineco / SERIE PURE ONE S11

Este aparato cumple con la sección 15 de las normas de la FCC. El funcionamiento está sujeto a las siguientes dos condiciones:

(1) Este aparato no puede causar interferencia perjudicial y (2) este aparato debe aceptar cualquier interferencia recibida, incluidas aquellas que puedan causar una operación no deseada.

Los cambios o modificaciones que no hayan sido expresamente aprobados por la parte responsable del cumplimiento podrían invalidar el derecho del usuario de operar el equipo.

Nota: Este equipo ha sido probado y se ha determinado que cumple con los límites de un aparato digital de Clase B según lo estipulado en la sección 15 de las normas de la FCC. Estos límites están diseñados para proporcionar una protección razonable contra las interferencias perjudiciales en una instalación residencial. Este equipo genera, consume y puede irradiar energía de radiofrecuencia y, si no se instala ni utiliza de acuerdo con las instrucciones, puede causar interferencias perjudiciales en las radiocomunicaciones. Sin embargo, no se garantiza que no se producirán interferencias en una instalación determinada. Si este equipo causa interferencias perjudiciales en la recepción de radio o televisión, lo cual puede determinarse encendiendo y apagando el equipo, se recomienda al usuario que intente corregir la interferencia tomando una o más de las siguientes medidas:

ES

- (1) Reoriente o reubique la antena receptora.
- (2) Aumente la separación entre el equipo y el receptor.
- (3) Conecte el equipo a una toma de corriente que esté en un circuito distinto al del receptor.
- (4) Consulte al distribuidor o a un técnico de radio/TV experimentado para obtener ayuda.

Declaración de exposición a la radiación de la FCC

Este equipo cumple con los límites de exposición a la radiación de la FCC establecidos para un entorno no controlado.

Nota

El fabricante no se hace responsable de ninguna interferencia de radio o televisión que sea consecuencia de modificaciones no autorizadas realizadas a este equipo; dichas modificaciones podrían invalidar el derecho del usuario de operar este equipo.

Nota de Industry Canada (IC)

Este aparato contiene transmisores/receptores exentos de licencia que cumplen con las Especificaciones de estándares de radio (RSS, por sus siglas en inglés) exentas de licencia del departamento de ISED (del inglés Innovation, Science and Economic Development, "innovación, ciencia y desarrollo económico") de Canadá. El funcionamiento está sujeto a las siguientes dos condiciones:

- (1) Este aparato no puede causar interferencias.
 - (2) Este aparato debe aceptar cualquier interferencia, incluidas aquellas que puedan causar un funcionamiento indeseado del aparato.
- Este aparato digital de Clase B cumple con la norma canadiense ICES-003.
 - Este equipo cumple con los límites de exposición a la radiación de la norma RSS-102 de ISED establecidos para un entorno no controlado. Este equipo debe instalarse a una distancia mínima de 20 cm entre el radiador y cualquier parte del cuerpo del operador, así como mantener esta distancia durante su uso.

Descripción general

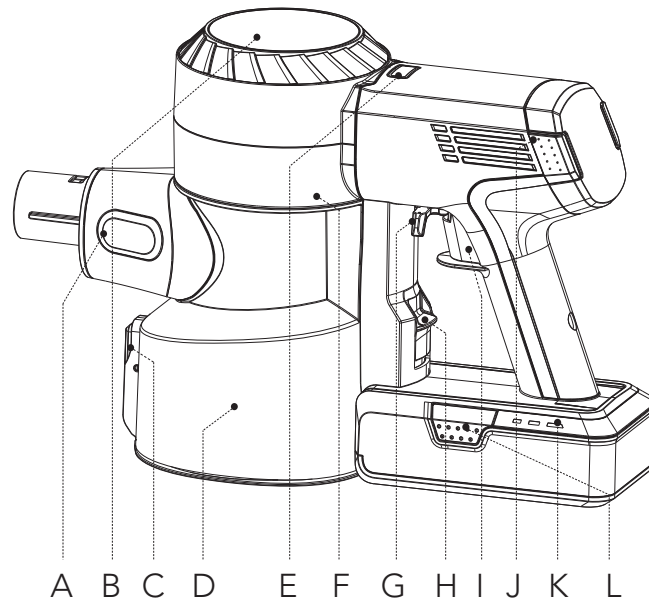

ES

- A. Sensor del polvo
- B. Pantalla digital
- C. Botón de liberación de vaciado del polvo
- D. Depósito de polvo
- E. Botón AUTO/MAX
- F. Botón de reinicio de Wi-Fi (retire el depósito para acceder)
- G. Bloqueo de gatillo
- H. Botón de liberación del depósito de polvo
- I. Gatillo
- J. Botón de liberación del filtro HEPA
- K. Luz indicadora de la batería
- L. Botón de liberación de la batería

ES

Pantalla digital

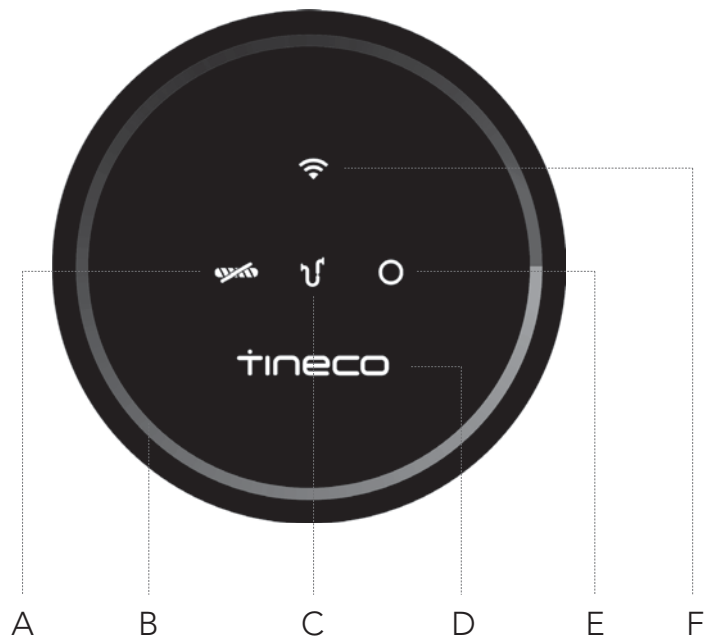

- A. Cepillo de rodillo enredado
- B. Bucle de la monitorización de polvo
(azul o rojo según la cantidad de polvo)
- C. Canal de aire obstruido
- D. Logotipo de Tineco
- E. Sensor de polvo defectuoso
- F. Indicador de Wi-Fi

Accesorios

Nota:

- Pruebe un accesorio en un área pequeña y poco visible antes de usarlo sobre superficies sensibles.
- El embalaje muestra los accesorios incluidos con su compra.
- Como se ilustra abajo, hay muchos componentes compatibles con este modelo. Si necesita más accesorios, visite www.tineco.com o store.tineco.com.

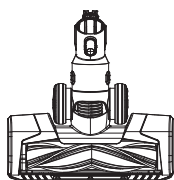

Cepillo eléctrico LED multitarea de tamaño completo

Ideal tanto para suelos duros como para alfombras. Muy eficaz para agitar la suciedad incrustada en la alfombra.

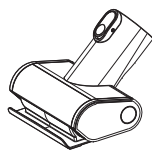

Minicepillo eléctrico

Para aspirar muebles tapizados, colchones, etc. Aspira pelo de mascotas y elimina la suciedad incrustada.

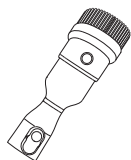

Cepillo para el polvo 2 en 1

Alterna entre un cepillo ancho y uno suave pulsando el botón de liberación. El cepillo suave es más eficaz en muebles de superficie dura y el cepillo ancho para muebles tapizados, cortinas, etc.

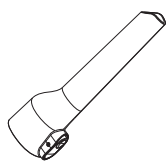

Boquilla para ranuras

Para esquinas, recovecos y otros lugares difíciles de alcanzar, como asientos de coche, marcos de fotos y armarios.

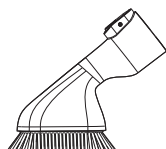

Cepillo blando para el polvo

Fibras en ángulo de forma delgada y ovalada que proporcionan un contacto acolchado antiestático. Apto para estantes, lámparas, superficies delicadas, aparatos electrónicos y mucho más.

ES