



OTA TEST REPORT

Applicant Espressif Systems (Shanghai) Co.,Ltd.
Product ESP32-PICO-mini-02
Model ESP-ANT D
Report No. Y2008A0669-T1
Issue Date August 12, 2020

TA Technology (Shanghai) Co., Ltd. tested the above equipment in accordance with the requirements in **ANSI/IEEE Std 149-2008**. The test results show that the equipment tested is capable of demonstrating compliance with the requirements as documented in this report.

Performed by: Peng Tao

Approved by: Kai Xu

TA Technology (Shanghai) Co., Ltd.

No.145, Jintang Rd, Tangzhen Industry Park, Pudong Shanghai, China

TEL: +86-021-50791141/2/3

FAX: +86-021-50791141/2/3-8000



TABLE OF CONTENTS

1.	Test Laboratory.....	3
1.1.	Notes of the Test Report	3
1.2.	Testing Location	3
1.3.	Laboratory Environment	3
2.	General Description of Equipment under Test.....	4
2.1.	Applicant and Manufacturer Information.....	4
2.2.	General information	4
2.3.	Test Date.....	4
2.4.	Applied Standards	5
3.	Test Conditions.....	6
3.1.	Test Configuration	6
3.2.	Test Measurement.....	6
4.	Test Results.....	7
4.1.	Gain and Efficiency.....	7
5.	Equipment List.....	8
	ANNEX A Pattern Plots.....	9
	ANNEX B: The EUT Appearance and Test Configuration	11
	B.1 EUT Appearance	11
	Picture 1: Constituents of EUT	11
	B.2 Test Setup.....	12



1. Test Laboratory

1.1. Notes of the Test Report

This report shall not be reproduced in full or partial, without the written approval of **TA technology (shanghai) co., Ltd.** The results documented in this report apply only to the tested sample, under the conditions and modes of operation as described herein .Measurement Uncertainties were not taken into account and are published for informational purposes only. This report is written to support regulatory compliance of the applicable standards stated above.

1.2. Testing Location

Company: TA Technology (Shanghai) Co., Ltd.
Address: No.145, Jintang Rd, Tangzhen Industry Park, Pudong Shanghai, China
City: Shanghai
Post code: 201201
Country: P. R. China
Contact: Xu Kai
Telephone: +86-021-50791141/2/3
Fax: +86-021-50791141/2/3-8000
Website: <http://www.ta-shanghai.com>
E-mail: xukai@ta-shanghai.com

1.3. Laboratory Environment

Temperature	Min. =19℃ , Max. = 25℃	
Relative humidity	Min. =40% , Max. =72%	
Shield effect	0.7-6GHz	> 100dB
Ground resistance	<0.5Ω	



2. General Description of Equipment under Test

2.1. Applicant and Manufacturer Information

Applicant Name	Espressif Systems (Shanghai) Co.,Ltd.
Applicant address	Suite 204, Block 2, 690 Bibo Road, Zhang Jiang Hi-Tech Park, Shanghai, China
Manufacturer Name	Espressif Systems (Shanghai) Co.,Ltd.
Manufacturer address	Suite 204, Block 2, 690 Bibo Road, Zhang Jiang Hi-Tech Park, Shanghai, China

2.2. General information

EUT Description	
Product Name:	ESP32-PICO-mini-02
Model	ESP-ANT D
Antenna Type:	PCB Antenna
Test Frequency:	2400MHz ~ 2483.5MHz

Test lab. of the antenna gain and radiation pattern measurement: TA Technology (Shanghai) Co., Ltd.

2.3. Test Date

The test is performed on August 10, 2020.



2.4. Applied Standards

According to the specifications of the manufacturer, it must comply with the requirements of the following standards:

Test Method: **ANSI/IEEE Std 149-2008**



3. Test Conditions

3.1. Test Configuration

Great-Circle-Cut method is used to measure the antenna 3D GAIN of EUT in OTA qualified anechoic chamber. Equipment Under Test (EUT) geometry centre vertical projection at the centre of platform, the distance from EUT to measurement antenna is 5m.

3.2. Test Measurement

Spherical coordinate system

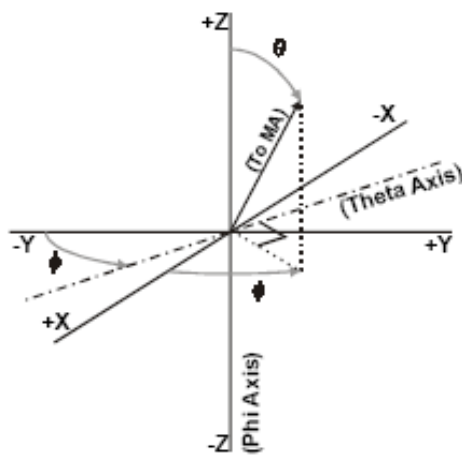
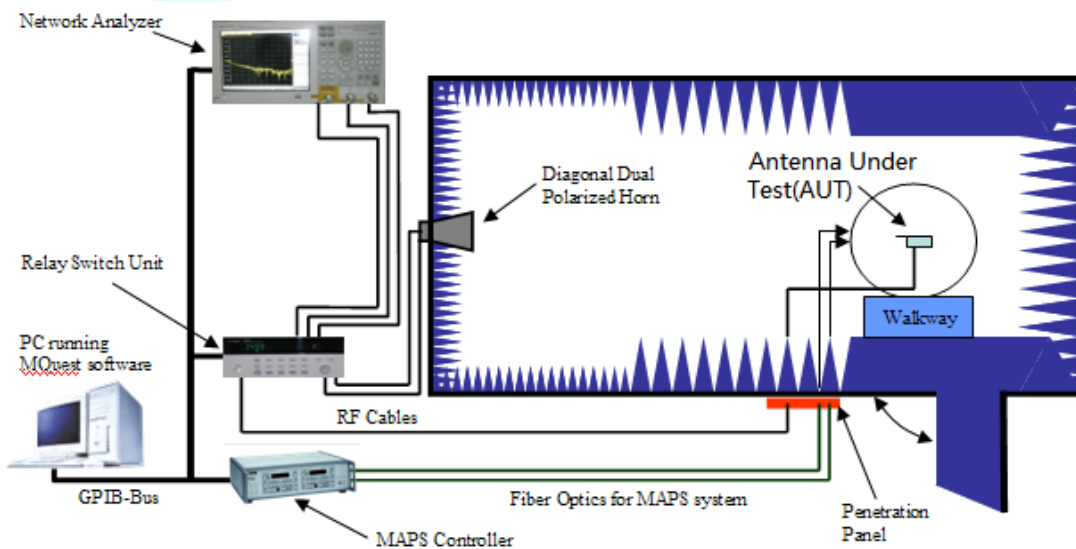

Figure 1 Test coordinate system

Note: Theta is from 0~180 degree. Phi is from 0~360. Rotate the EUT and record the Data, the step of rotation is 15 degree.

Test Setup





4. Test Results

4.1. Gain and Efficiency

Test Item	Test State	Frequency (MHz)	Efficiency (dB)	Efficiency (%)	Gain (dBi)	Directivity (dBi)	Note
Gain	Free Space	2402	-2.81	52.33	2.75	5.56	15°
		2407	-2.69	53.78	2.54	5.23	
		2412	-2.61	54.79	2.47	5.08	
		2417	-2.47	56.59	2.76	5.24	
		2422	-2.34	58.40	2.65	4.99	
		2427	-2.35	58.15	2.50	4.85	
		2432	-2.37	57.99	2.87	5.23	
		2437	-2.34	58.40	2.70	5.04	
		2442	-2.49	56.31	2.52	5.01	
		2447	-2.67	54.13	2.01	4.67	
		2452	-2.77	52.84	2.14	4.91	
		2457	-2.86	51.81	1.96	4.81	
		2462	-2.91	51.13	1.89	4.81	
		2467	-3.17	48.21	1.66	4.83	
		2472	-3.27	47.11	1.60	4.87	
		2477	-3.20	47.83	1.58	4.79	
		2482	-3.28	46.99	1.57	4.85	
		2487	-3.34	46.31	1.69	5.04	
		2492	-3.26	47.24	1.58	4.83	
		2497	-3.24	47.39	1.53	4.77	
2502	-3.30	46.78	1.49	4.79			



5. Equipment List

Type of Equipment	Manufacture	Model Number	S/N	Calibration Date	Expiration Time
Network Analyzer	Key sight	E5071B	MY42404014	2020-05-17	2021-05-16
Switch Control System	ETS	7006/7001	00059957/MY 42001152	N/A	N/A
Dual polarized horn antenna	ETS	3164-04	00062743	2020-04-14	2021-04-13
Software	ETS-lindgren	EMQ-100 Pattern Measurement software	1.09	N/A	N/A

ANNEX A Pattern Plots

2.4G 3D Pattern Plots

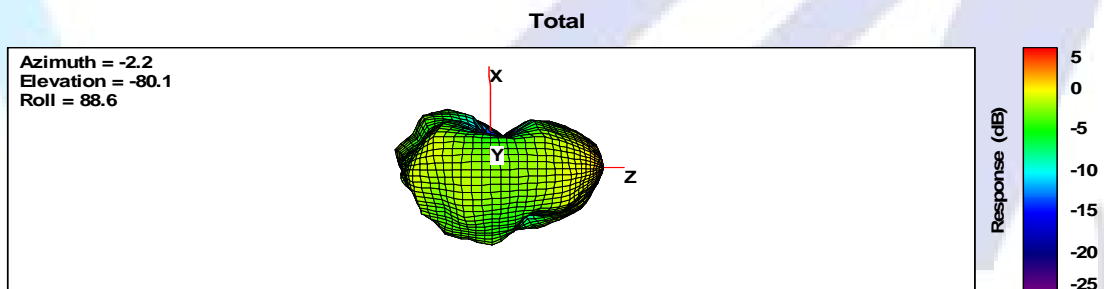
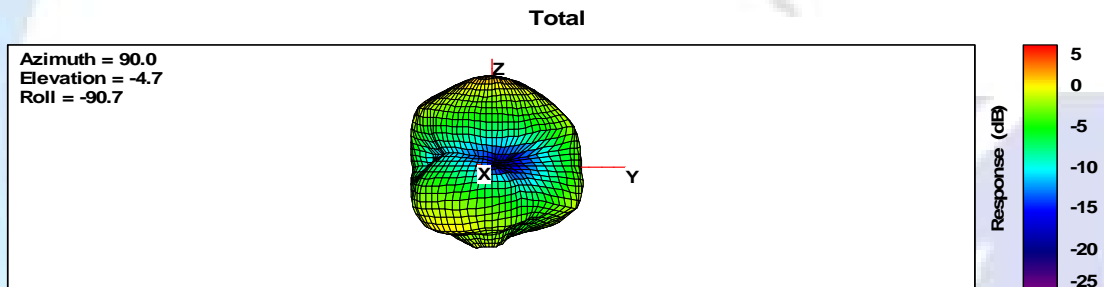
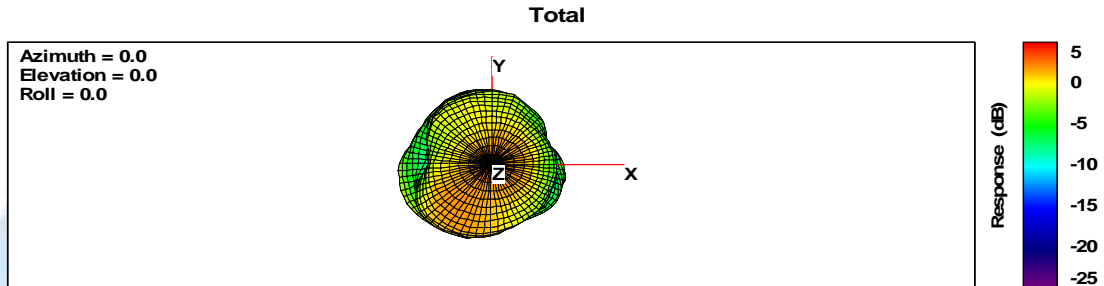

2402MHz~2452MHz



2.4G 2D Pattern Plots

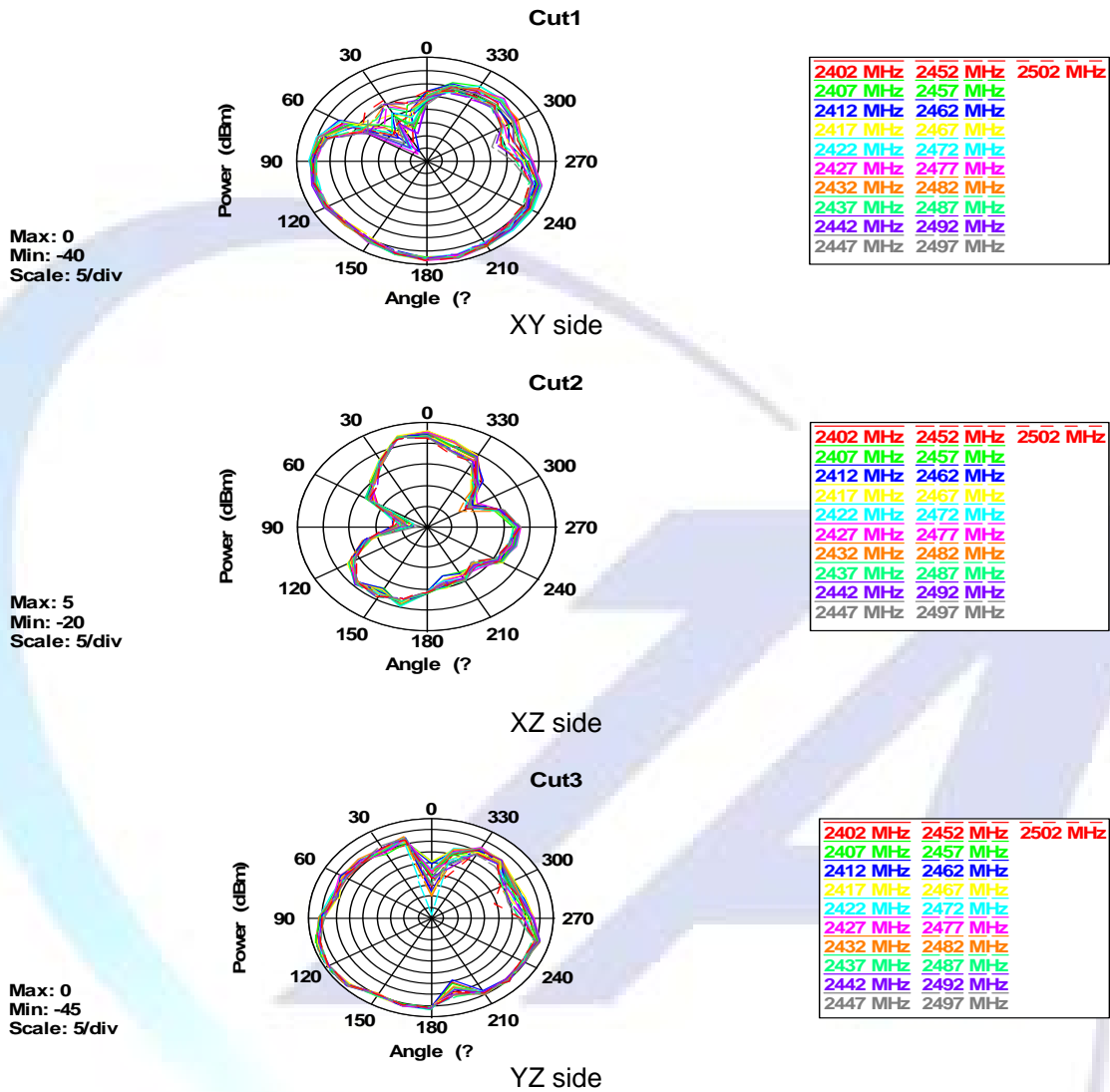

ANNEX B: The EUT Appearance and Test Configuration

B.1 EUT Appearance

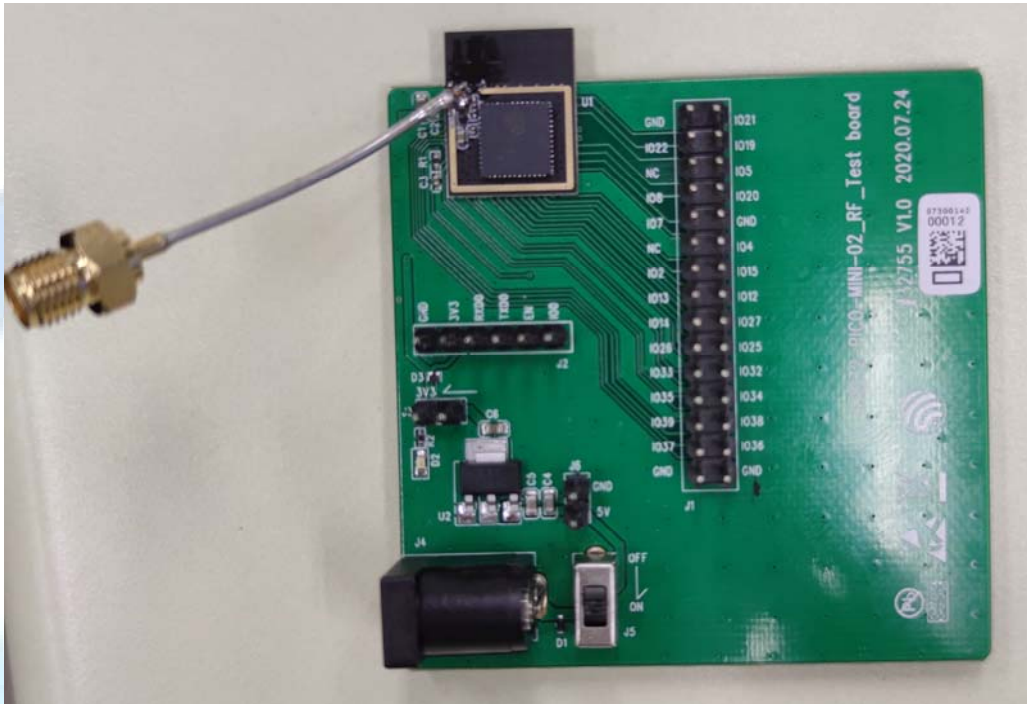

a: EUT

Picture 1: Constituents of EUT

B.2 Test Setup

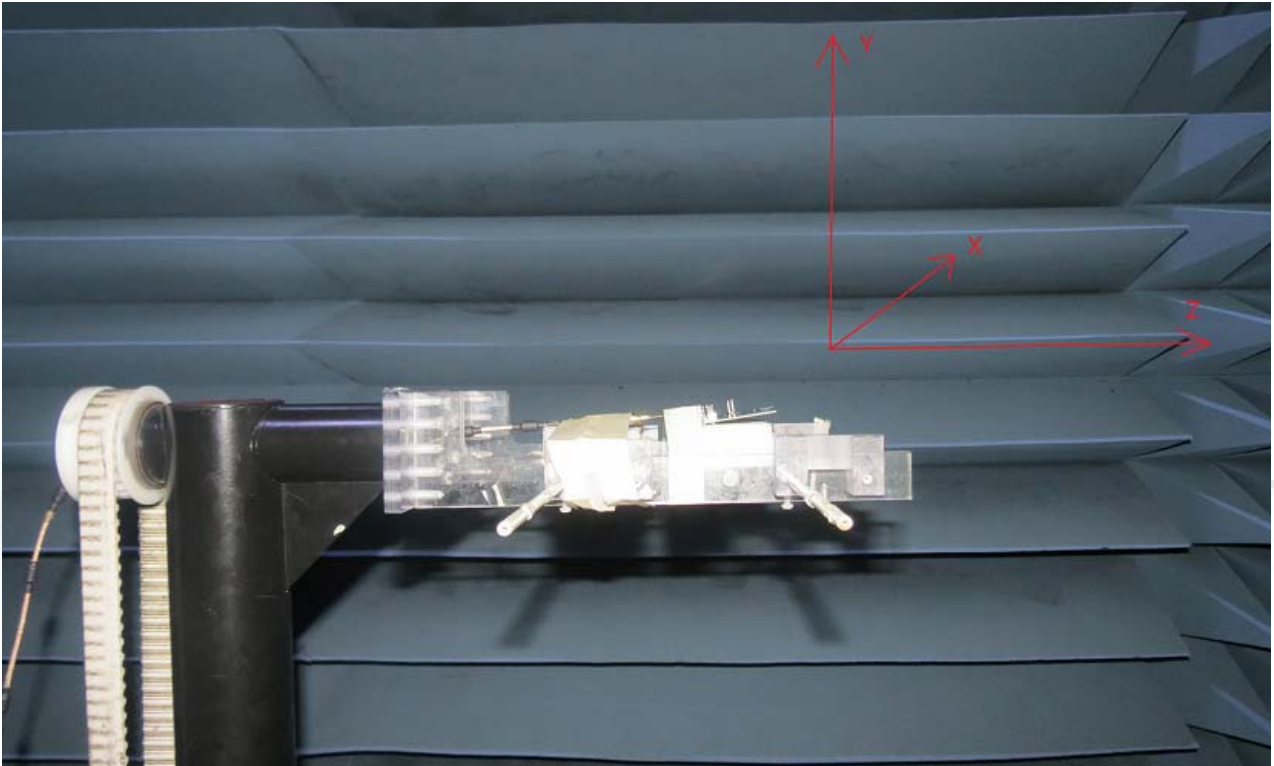

2.4G 3D Gain
Picture 2 Test Setup
*****END*****