



TEST REPORT

No. I20D00101-SAR01

For

**Client: NetEase Youdao Information Technology
(Beijing) Co., Ltd**

Production: Youdao Dictionary Pen 2

Model Name: YDP021

Brand Name: youdao

FCC ID: 2AV6G-YDP021

Hardware Version: WM86-V4

Software Version: V1.3.6AD

Issued date: 2020-09-15

NOTE

1. The test results in this test report relate only to the devices specified in this report.
2. This report shall not be reproduced except in full without the written approval of East China Institute of Telecommunications.
3. KDB has not been approved by A2LA.
4. It has been confirmed with the customer that the Tune-up Power information provided by the customer may affect the validity of the measurement results in this report, and the impact and consequences will be borne by the customer.
5. For the test results, the uncertainty of measurement is not taken into account when judging the compliance with specification, and the results of measurement or the average value of measurement results are taken as the criterion of the compliance with specification directly.

Test Laboratory:

East China Institute of Telecommunications

Add: Building 4, No. 766, Jingang Road, Pudong, Shanghai, P. R. China

Tel: +86 21 63843300

FAX: +86 21 63843301

E-Mail: welcome@ecit.org.cn

Revision Version

Report Number	Revision	Date	Memo
I20D00101-SAR01	00	2020-09-01	Initial creation of test report
I20D00101-SAR01	01	2020-09-15	Second creation of test report

CONTENTS

1. TEST LABORATORY	7
1.1. TESTING LOCATION	7
1.2. TESTING ENVIRONMENT	7
1.3. PROJECT DATA	7
1.4. SIGNATURE	7
2. CLIENT INFORMATION	8
2.1. APPLICANT INFORMATION	8
2.2. MANUFACTURER INFORMATION	8
3. EQUIPMENT UNDER TEST (EUT) AND ANCILLARY EQUIPMENT (AE)	9
3.1. ABOUT EUT	9
3.2. INTERNAL IDENTIFICATION OF EUT USED DURING THE TEST	10
3.3. INTERNAL IDENTIFICATION OF AE USED DURING THE TEST	10
4. REFERENCE DOCUMENTS	11
4.1. DOCUMENTS SUPPLIED BY APPLICANT	11
4.2. REFERENCE DOCUMENTS	11
4.3. CRITERION	11
5. TEST SUMMARY AND STATEMENT OF COMPLIANCE	12
5.1. TEST SUMMARY	12
5.2. STATEMENT OF COMPLIANCE	13
6. SPECIFIC ABSORPTION RATE (SAR)	14
6.1. INTRODUCTION	14
6.2. SAR DEFINITION	14
7. SAR MEASUREMENT SYSTEM INTRODUCTION	15
7.1. MEASUREMENT SET-UP	15
7.2. E-FIELD PROBE SYSTEM	16

7.3.	E-FIELD PROBE CALIBRATION.....	16
7.4.	OTHER TEST EQUIPMENT.....	18
8.	TEST POSITION IN RELATION TO THE PHANTOM.....	21
8.1.	GENERAL CONSIDERATIONS.....	21
8.2.	BODY-WORN DEVICE.....	22
8.3.	DESKTOP DEVICE	22
9.	TISSUE SIMULATING LIQUIDS.....	23
9.1.	EQUIVALENT TISSUES COMPOSITION.....	23
9.2.	DIELECTRIC PERFORMANCE OF TSL	24
10...	SYSTEM VALIDATION.....	25
10.1.	SYSTEM VALIDATION	25
10.2.	SYSTEM SETUP.....	25
10.3.	SYSTEM VALIDATION RESULT	25
11...	MEASUREMENT PROCEDURES	26
11.1.	TEST STEPS.....	26
11.2.	SPATIAL PEAK SAR EVALUATION	27
11.3.	GENERAL MEASUREMENT PROCEDURE	28
11.4.	WCDMA MEASUREMENT PROCEDURES	29
11.5.	LTE MEASUREMENT PROCEDURE	30
11.6.	BLUETOOTH & WIFI MEASUREMENT PROCEDURES.....	31
12...	SIMULTANEOUS TRANSMISSION SAR CONSIDERATIONS	32
12.1.	REFERENCE DOCUMENT	32
12.2.	ANTENNA SEPARATION DISTANCES	32
12.3.	SAR MEASUREMENT POSITIONS.....	33
12.4.	LOW POWER TRANSMITTERS SAR CONSIDERATION	33
12.5.	SIMULTANEOUS TRANSMISSION ANALYSIS	33
13...	CONDUCTED OUTPUT POWER	34

13.1.	BT MEASUREMENT RESULT	34
13.2.	WIFI MEASUREMENT RESULT	35
14...	SAR MEASUREMENT RESULT	37
14.1.	STANDALONE SAR TEST RESULT	37
14.2.	SAR MEASUREMENT VARIABILITY	37
15...	TEST EQUIPMENT UTILIZED	38
16...	MEASUREMENT UNCERTAINTY	39
ANNEX A.	GRAPH RESULTS	41
ANNEX B.	SYSTEM VALIDATION PLOT	42
ANNEX C.	CALIBRATION CERTIFICATION	43
ANNEX D.	ACCREDITATION CERTIFICATION	56

1. Test Laboratory

1.1. Testing Location

Company Name	East China Institute of Telecommunications
Address	Building 4, No. 766, Jingang Road, Pudong, Shanghai, P. R. China
Postal Code	201206
Telephone	+86 21 63843300
Fax	+86 21 63843301
FCC Designation No	CN1177

1.2. Testing Environment

Normal Temperature	18°C-25°C
Relative Humidity	25%RH-75%RH

1.3. Project Data

Project Leader	Xu Yuting
Testing Start Date	2020-08-10
Testing End Date	2020-08-10

1.4. Signature



Gong Jiawei

(Prepared this test report)



Yan Hang

(Reviewed this test report)

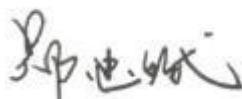

Zheng Zhongbin

(Approved this test report)

2. Client Information

2.1. Applicant Information

Company Name	NetEase Youdao Information Technology (Beijing) Co., Ltd
Address	No.7 Building,Zhongguancun Software Park West,No.10 Xibeiwang East RD,Haidian District,Beijing,China
Telephone	+86 13810968741
Postcode	100193

2.2. Manufacturer Information

Company Name	Mobiwire Mobiles(NingBo) Co.,LTD
Address	Building A,No.999 Dacheng East Road,Fenghua District,Ningbo City,Zhejiang Province,PRC
Telephone	+86 135 8683 5362
Postcode	N/A

3. Equipment Under Test (EUT) and Ancillary Equipment (AE)

3.1. About EUT

Description:	Youdao Dictionary Pen 2
Model Name:	YDP021
Operation Model(s):	BT4.2 WiFi
Tx Frequency:	2412- 2462 MHz (WiFi)
Test device Production Information:	Production unit
WLAN Mode:	WLAN 2.4GHz 802.11b/g/n HT20/n HT40
Device Type:	Portable device
Antenna Type:	Embedded antenna
Accessories/Body-worn Configurations:	N/A
Dimensions:	69mm X 20mm X 5.35mm
Hotspot Mode:	Support
Note:	Photographs of EUT are shown in ANNEX C of this test report.

3.2. Internal Identification of EUT used during the test

EUT ID*	SN or IMEI	HW Version	SW Version	Date of receipt
N04	2A51600000400533	WM86-V4	V1.3.6AD	2020-07-14

*EUT ID: is used to identify the test sample in the lab internally.

3.3. Internal Identification of AE used during the test

AE ID*	Description	Type	Manufacturer
--	--	--	--

*AE ID: is used to identify the test sample in the lab internally.

4. Reference Documents

4.1. Documents supplied by applicant

All technical documents are supplied by the client or manufacturer, which is the basis of testing.

4.2. Reference Documents

The following documents listed in this section are referred for testing.

Reference	Title	Version
ANSI C95.1	IEEE Standard for Safety Levels with Respect to Human Exposure to Radio Frequency Electromagnetic Fields, 3 kHz to 300 GHz.	1999
IEEE 1528	Recommended Practice for Determining the Peak Spatial-Average Specific Absorption Rate (SAR) in the Human Body Due to Wireless Communications Devices: Experimental Techniques.	2013
KDB648474	Wireless Chargers Battery Cover	D03 v01r04
KDB248227	802 11 WiFi SAR	D01 v02r02
KDB447498	General RF Exposure Guidance	D01 v06
KDB865664	SAR Measurement 100 MHz to 6 GHz	D01 v01r04
KDB865664	RF Exposure Reporting	D02 v01r02
KDB941225	Hotspot SAR	D06 v02r01

4.3. Criterion

At frequencies between 100 kHz and 6 GHz, the MPE (Maximum Permissible Exposure) in population/uncontrolled environments for electromagnetic field strengths may be exceeded if

- a) The exposure conditions can be shown by appropriate techniques to produce SARs below 0.08W/kg, as averaged over the whole body, and spatial peak SAR values not exceeding 1.6 W/kg, as averaged over any 1g of tissue (defined as a tissue volume in the shape of a cube), except for the hands, wrists, feet, and ankles where the spatial peak SAR shall not exceed 4 W/kg, as averaged over any 10g of tissue (defined as a tissue volume in the shape of a cube); and
- b) The induced currents in the body confirm with the MPE in table 2, Part B in ANSI C95.1-1999.

5. Test Summary and Statement of Compliance

5.1. Test Summary

The maximum results of Specific Absorption Rate (SAR) in standalone mode are as follows.

Table 5.1: Standalone Max. Reported SAR

Band	SAR 10g(w/kg)
	Limb(0mm)
WiFi 2.4G	1.539

5.2. Statement of Compliance

The **YDP021** manufactured by **youdao** is a parent model for testing.

ECIT has verified that the compliance of the tested device specified in section 3 of this test report is successfully evaluated according to the procedure and test methods as defined in type certification requirement listed in section 4 of this test report.

For body worn operation mode, this device with any accessory that contained in this report has been tested and the values meet FCC RF exposure guidelines. Use of other accessories may not ensure compliance with FCC RF exposure guidelines.

6. Specific Absorption Rate (SAR)

6.1. Introduction

SAR is related to the rate at which energy is absorbed per unit mass in an object exposed to a radio field. The SAR distribution in a biological body is complicated and is usually carried out by experimental techniques or numerical modeling. The standard recommends limits for two tiers of groups, occupational/controlled and general population/uncontrolled, based on a person's awareness and ability to exercise control over his or her exposure. In general, occupational/controlled exposure limits are higher than the limits for general population/uncontrolled.

6.2. SAR Definition

The SAR definition is the time derivative (rate) of the incremental energy (dW) absorbed by (dissipated in) an incremental mass (dm) contained in a volume element (dv) of a given density (ρ). The equation description is as below:

$$SAR = \frac{d}{dt} \left(\frac{dW}{dm} \right) = \frac{d}{dt} \left(\frac{dW}{\rho dv} \right)$$

SAR is expressed in units of Watts per kilogram (W/kg)

SAR measurement can be either related to the temperature elevation in tissue by

$$SAR = c \left(\frac{\delta T}{\delta t} \right)$$

Where: c is the specific heat capacity, δT is the temperature rise and δt is the exposure duration, or related to the electrical field in the tissue by

$$SAR = \frac{\sigma |E|^2}{\rho}$$

Where:

- σ is the conductivity of the tissue
- ρ is the mass density of tissue, which is normally set to 1g/cm^3
- E is the RMS electrical field strength

However for evaluating SAR of low power transmitter, electrical field measurement is typically applied.

7. SAR Measurement System Introduction

7.1. Measurement Set-up

The DASY5 system for performing compliance tests is illustrated above graphically. This system consists of the following items:

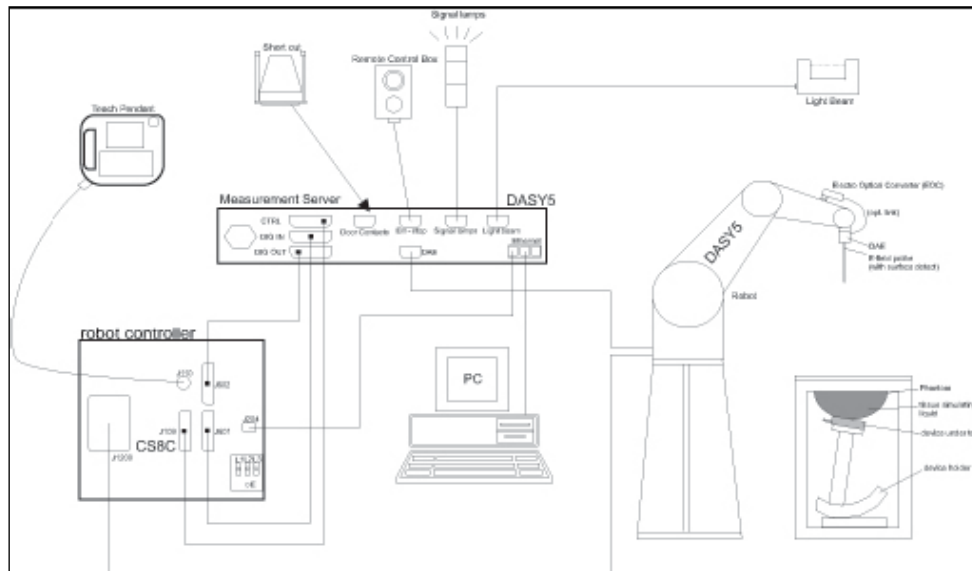

Picture 7-1 SAR Measurement Set-up

- A standard high precision 6-axis robot (Stäubli TX=RX family) with controller, teach pendant and software. An arm extension for accommodating the data acquisition electronics (DAE).
- An isotropic field probe optimized and calibrated for the targeted measurement.
- A data acquisition electronics (DAE) which performs the signal amplification, signal multiplexing, AD conversion, offset measurements, mechanical surface detection, collision detection, etc. The unit is battery powered with standard or rechargeable batteries. The signal is optically transmitted to the EOC.
- The Electro-optical converter (EOC) performs the conversion from optical to electrical signals for the digital communication to the DAE. To use optical surface detection, a special version of the EOC is required. The EOC signal is transmitted to the measurement server.
- The function of the measurement server is to perform the time critical tasks such as signal filtering, control of the robot operation and fast movement interrupts.
- The Light Beam used is for probe alignment. This improves the (absolute) accuracy of the probe positioning.
- A computer running WinXP and the DASY5 software.
- Remote control and teach pendant as well as additional circuitry for robot safety such as warning lamps, etc.
- The phantom, the device holder and other accessories according to the targeted measurement.

7.2. E-field Probe System

The SAR measurements were conducted with the dosimetric probe designed in the classical triangular configuration and optimized for dosimetric evaluation. The probe is constructed using the thick film technique; with printed resistive lines on ceramic substrates. The probe is equipped with an optical multi-fiber line ending at the front of the probe tip. It is connected to the EOC box on the robot arm and provides an automatic detection of the phantom surface. Half of the fibers are connected to a pulsed infrared transmitter, the other half to a synchronized receiver. As the probe approaches the surface, the reflection from the surface produces a coupling from the transmitting to the receiving fibers. This reflection increases first during the approach, reaches maximum and then decreases. If the probe is flatly touching the surface, the coupling is zero. The distance of the coupling maximum to the surface is independent of the surface reflectivity and largely independent of the surface to probe angle. The DASY5 software reads the reflection during a software approach and looks for the maximum using 2nd ord curve fitting. The approach is stopped at reaching the maximum.

Probe Specifications:	
Model:	ES3DV3,EX3DV4
Frequency Range:	10MHz — 6GHz(EX3DV4)
	10MHz — 4GHz(ES3DV3)
Calibration:	In head and body simulating tissue at frequency from 650MHz to 5900MHz
Linearity:	± 0.2 dB(30 MHz to 4 GHz) for ES3DV3 ± 0.2 dB(30 MHz to 6 GHz) for EX3DV4
Dynamic Range:	10 mW/kg — 100 W/kg
Probe Length:	330 mm
Probe Tip Length:	20 mm
Body Diameter:	12 mm
Tip Diameter:	2.5 mm (3.9 mm for ES3DV3)
Tip-Center:	1 mm (2.0mm for ES3DV3)
Application:	SAR Dosimetry Testing Compliance tests of mobile phones Dosimetry in strong gradient fields



Picture 7-2 Detail of Probe



Picture 7-3 E-field Probe

7.3. E-field Probe Calibration

Each E-Probe/Probe Amplifier combination has unique calibration parameters. A TEM cell calibration procedure is conducted to determine the proper amplifier settings to enter in the probe parameters. The amplifier settings are determined for a given frequency by subjecting the probe to a known E-field density (1 mW/cm²) using an RF Signal generator, TEM cell, and RF Power Meter.

The free space E-field from amplified probe outputs is determined in a test chamber. This calibration can be performed in a TEM cell if the frequency is below 1 GHz and inn a waveguide or other methodologies

above 1 GHz for free space. For the free space calibration, the probe is placed in the volumetric center of the cavity and at the proper orientation with the field. The probe is then rotated 360 degrees until the three channels show the maximum reading. The power density readings equates to 1 mW/cm².

E-field temperature correlation calibration is performed in a flat phantom filled with the appropriate simulated brain tissue. The E-field in the medium correlates with the temperature rise in the dielectric medium. For temperature correlation calibration a RF transparent thermistor-based temperature probe is used in conjunction with the E-field probe.

$$SAR = C \frac{\Delta T}{\Delta t}$$

Where:

Δt = Exposure time (30 seconds),

C = Heat capacity of tissue (brain or muscle),

ΔT = Temperature increase due to RF exposure.

$$SAR = \frac{|E|^2 \cdot \sigma}{\rho}$$

Where:

σ = Simulated tissue conductivity,

ρ = Tissue density (kg/m³).

7.4. Other Test Equipment

7.4.1. Data Acquisition Electronics (DAE)

The data acquisition electronics consist of a highly sensitive electrometer-grade preamplifier with auto-zeroing, a channel and gain-switching multiplexer, a fast 16 bit AD-converter and a command decoder with a control logic unit. Transmission to the measurement server is accomplished through an optical downlink for data and status information, as well as an optical uplink for commands and the clock.

The mechanical probe mounting device includes two different sensor systems for frontal and sideways probe contacts. They are used for mechanical surface detection and probe collision detection.

The input impedance of the DAE is 200M Ohm; the inputs are symmetrical and floating. Common mode rejection is above 80dB.



Picture 7-4: DAE

7.4.2. Robot

The SPEAG DASY system uses the high precision robots (DASY5: TX90) type from Stäubli SA (France).

For the 6-axis controller system, the robot controller version from Stäubli is used. The Stäubli robot series have many features that are important for our application:

- High precision (repeatability 0.02mm)
- High reliability (industrial design)
- Low maintenance costs (virtually maintenance free due to direct drive gears; no belt drives)
- Jerk-free straight movements (brushless synchronous motors; no stepper motors)
- Low ELF interference (motor control fields shielded via the closed metallic construction shields)



Picture 7-5: DASY 5

7.4.3. Measurement Server

The Measurement server is based on a PC/104 CPU board with CPU (DASY5: 400 MHz, Intel Celeron), chip disk (DASY5: 128MB), RAM (DASY5: 128MB). The necessary circuits for communication with the DAE electronic box, as well as the 16 bit AD converter system for optical detection and digital I/O interface are contained on the DASY I/O board, which is directly connected to the PC/104 bus of the CPU board.



Picture 7-6: Server for DASY 5

The measurement server performs all real-time data evaluation of field measurements and surface detection, controls robot movements and handles safety operation. The PC operating system cannot interfere with these time critical processes. All connections are supervised by a watchdog, and disconnection of any of the cables to the measurement server will automatically disarm the robot and disable all program-controlled robot movements. Furthermore, the measurement server is equipped with an expansion port which is reserved for future applications. Please note that this expansion port does not have a standardized pinout, and therefore only devices provided by SPEAG can be connected. Devices from any other supplier could seriously damage the measurement server.

7.4.4. Device Holder for Phantom

The SAR in the phantom is approximately inversely proportional to the square of the distance between the source and the liquid surface. For a source at 5mm distance, a positioning uncertainty of $\pm 0.5\text{mm}$ would produce a SAR uncertainty of $\pm 20\%$. Accurate device positioning is therefore crucial for accurate and repeatable measurements. The positions in which the devices must be measured are defined by the standards.

The DASY device holder is designed to cope with the different positions given in the standard. It has two scales for device rotation (with respect to the body axis) and device inclination (with respect to the line between the ear reference points). The rotation centers for both scales is the ear reference point (ERP). Thus the device needs no repositioning when changing the angles.

The DASY device holder is constructed of low-loss POM material having the following dielectric parameters: relative permittivity $\epsilon = 3$ and loss tangent $\delta = 0.02$. The amount of dielectric material has been reduced in the closest vicinity of the device, since measurements have suggested that the influence of the clamp on the test results could thus be lowered.



Picture 7-7: Device Holder

The extension is lightweight and made of POM, acrylic glass and foam. It fits easily on the upper part of the Mounting Device in place of the phone positioner. The extension is fully compatible with the Twin-SAM and ELI phantoms.

The DASY device holder is constructed of low-loss POM material having the following dielectric parameters: relative permittivity $\epsilon = 3$ and loss tangent $\delta = 0.02$. The amount of dielectric material has been reduced in the closest vicinity of the device, since measurements have suggested that the influence of the clamp on the test results could thus be lowered.

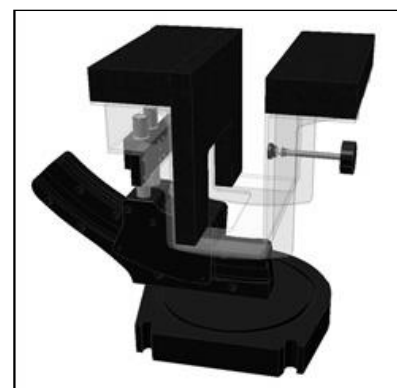

Picture 7-8: Laptop Extension Kit

7.4.5. Phantom

The SAM Twin Phantom V4.0 is constructed of a fiberglass shell integrated in a table. The shape of the

shell is based on data from an anatomical study designed to represent the 90th percentile of the population. The phantom enables the dissymmetric evaluation of SAR for both left and right handed handset usage, as well as body-worn usage using the flat phantom region. Reference markings on the Phantom allow the complete setup of all predefined phantom positions and measurement grids by manually teaching three points in the robot. The shell phantom has a 2mm shell thickness (except the ear region where shell thickness increases to 6 mm).

Shell Thickness:	2 ± 0.2 mm	
Available:	Special	
Filling Volume:	Approx. 25 liters	
Dimensions:	810 x 1000 x 500 mm (H x L x W)	

Picture 7-9: SAM Twin Phantom

8. Test Position in Relation to the Phantom

8.1. General considerations

This standard specifies two handset test positions against the head phantom – the “cheek” position and the “tilt” position.

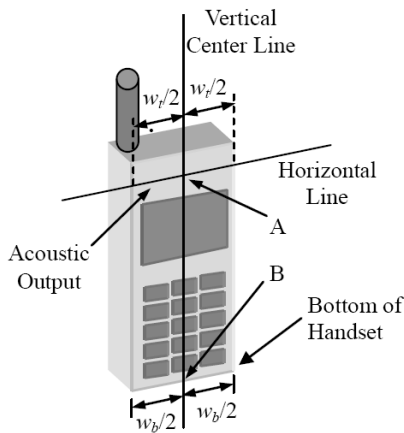

Picture 8-1 Typical “fixed” case handset

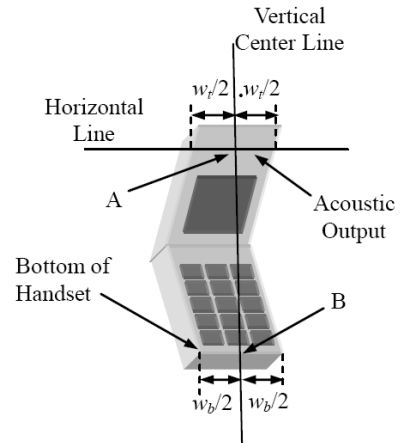

Picture 8-2 Typical “clam-shell” case handset

w_t	Width of the handset at the level of the acoustic
w_b	Width of the bottom of the handset
A	Midpoint of the width w_t of the handset at the level of the acoustic output
B	Midpoint of the width w_b of the bottom of the handset

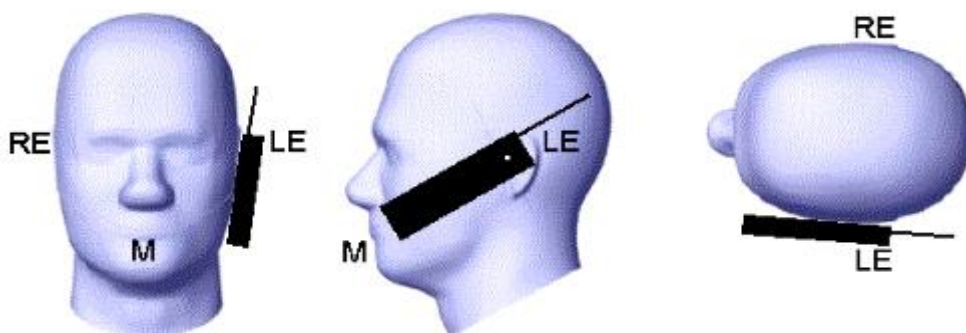

Picture 8-3 Cheek position of the wireless device on the left side of SAM

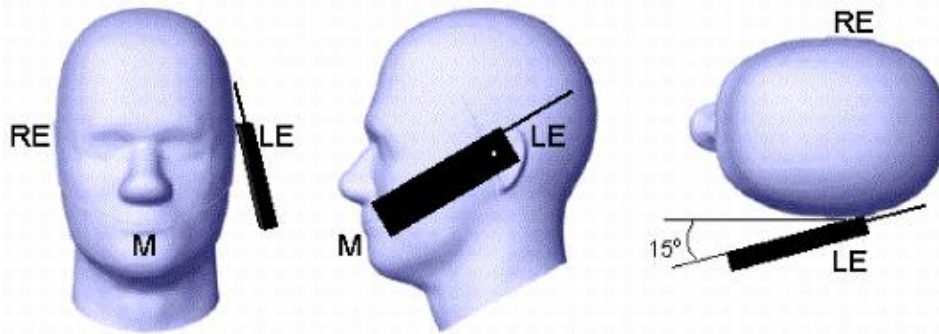

Picture 8-4 Tilt position of the wireless device on the left side of SAM

8.2. Body-worn device

A typical example of a body-worn device is a mobile phone, wireless enabled PDA (personal digital assistant) or other battery operated wireless device with the ability to transmit while mounted on a person’s body using a carry accessory approved by the wireless device manufacturer.

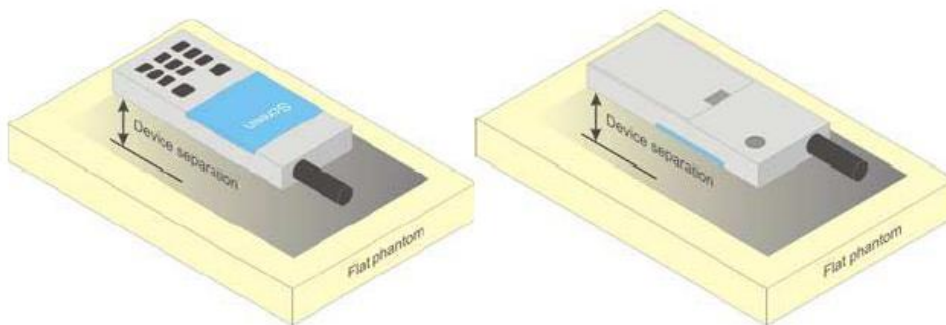

Picture 8-5 Test positions for body-worn devices

8.3. Desktop device

A typical example of a desktop device is a wireless enabled desktop computer placed on a table or desk when used.

The DUT shall be positioned at the distance and in the orientation to the phantom that corresponds to the intended use as specified by the manufacturer in the user instructions. For devices that employ an external antenna with variable positions.

Tests shall be performed for all antenna positions specified.

Picture 8-6 shows positions for desktop device SAR tests. If the intended use is not specified, the device shall be tested directly against the flat phantom.

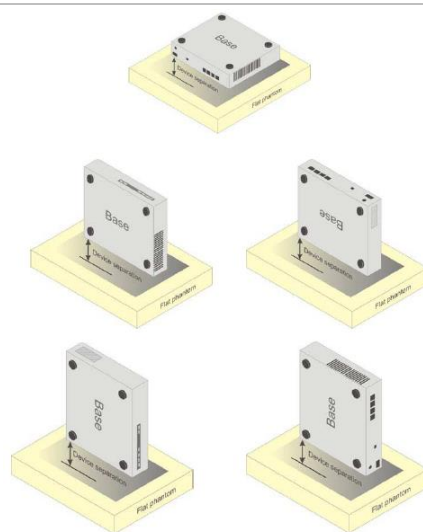

Picture 8-6 Test positions for desktop devices

9. Tissue Simulating Liquids

9.1. Equivalent Tissues Composition

The liquid used for the frequency range of 650-6000 MHz consisted of water, sugar, salt, preventol, glycol monobutyl and Cellulose. The liquid has been previously proven to be suited for worst-case. The Table 9.1 shows the detail solution. It's satisfying the latest tissue dielectric parameters requirements proposed by the IEEE 1528 and IEC 62209.

Table 9.1: Composition of the Head Tissue Equivalent Matter

Frequency (MHz)	835	900	1800	1950	2300	2450	2600	5800
Ingredients (% by weight)								
Water	41.45	40.92	55.242	54.89	56.34	58.79	58.79	65.53
Sugar	56.0	56.5	/	/	/	/	/	
Salt	1.45	1.48	0.306	0.18	0.14	0.06	0.06	
Preventol	0.1	0.1	/	/	/	/	/	
Cellulose	1.0	1.0	/	/	/	/	/	
GlycolMonobutyl	/	/	44.452	44.93	43.52	41.15	41.15	
Diethylenglycol momohexylether	/	/	/	/	/	/	/	17.24
Triton X-100	/	/	/	/	/	/	/	17.23
Dielectric Parameters Target Value	$\epsilon=41.5$ $\sigma=0.90$	$\epsilon=41.5$ $\sigma=0.97$	$\epsilon=40.0$ $\sigma=1.40$	$\epsilon=40.0$ $\sigma=1.40$	$\epsilon=39.5$ $\sigma=1.67$	$\epsilon=39.2$ $\sigma=1.80$	$\epsilon=39.0$ $\sigma=1.96$	$\epsilon=35.3$ $\sigma=5.27$

Table 9.2: Targets for tissue simulating liquid

Frequency (MHz)	Liquid Type	Conductivity (σ)	$\pm 5\%$ Range	Permittivity (ϵ)	$\pm 5\%$ Range
835	Head	0.90	0.874~0.97	41.5	39.4~43.6
900	Head	0.97	0.92~1.02	41.5	39.4~43.6
1800	Head	1.40	1.33~1.47	40.0	38.0~42.0
1950	Head	1.40	1.33~1.47	40.0	38.0~42.0
2300	Head	1.67	1.59~1.75	39.5	37.5~41.4
2450	Head	1.80	1.71~1.89	39.2	37.2~41.2
2600	Head	1.96	1.86~2.06	39.0	37.5~40.95
5200	Head	4.66	4.43~4.89	35.99	34.19~37.79
5300	Head	4.76	4.52~4.99	35.87	34.08~37.66
5500	Head	4.96	4.71~5.2	35.6	33.82~37.38
5600	Head	5.07	4.82~5.32	35.53	33.75~37.30
5800	Head	5.27	5.01~5.53	35.3	33.54~37.05

Note: Effective February 19, 2019, FCC has permitted the use of single head-tissue simulating liquid specified in IEC 62209-1 for all SAR tests.

9.2. Dielectric Performance of TSL

Table 9.3: Dielectric Performance of Head Tissue Simulating Liquid

Tissue Simulating Liquid								
Frequency (MHz)	Head(Standard)		Temperature	Date	Test Result		Deviation (%)	
	Permittivity ϵ	Conductivity σ			Permittivity ϵ	Conductivity σ	Permittivity ϵ	Conductivity σ
2450	39.20	1.80	22.6°C	2020/8/10	38.47	1.787	-1.86%	-0.72%

10. System Validation

10.1. System Validation

Each DASY system is equipped with one or more system validation kits. These units, together with the predefined measurement procedures within the DASY software, enable the user to conduct the system performance check and system validation. System validation kit includes a dipole, tripod holder to fix it underneath the flat phantom and a corresponding distance holder.

10.2. System Setup

In the simplified setup for system evaluation, the DUT is replaced by a calibrated dipole and the power source is replaced by a continuous wave that comes from a signal generator. The calibrated dipole must be placed beneath the flat phantom section of the SAM twin phantom with the correct distance holder. The distance holder should touch the phantom surface with a light pressure at the reference marking and be oriented parallel to the long side of the phantom. The equipment setup is shown below:

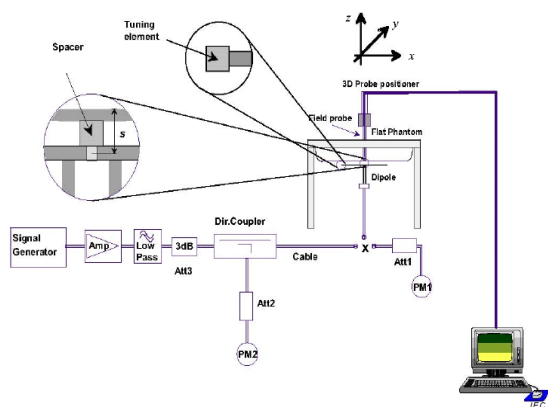

Picture 10-1 Setup for System Evaluation



Picture 10-2. Setup for Dipole

10.3. System Validation Result

Table 10.1: System Validation Result of SAR

SAR System Validation								
Frequency (MHz)	Average Target Value (w/kg)		Temperature	Date	Test Result (w/kg)		Deviation (%)	
	10g	1g			10g	1g	10g	1g
2450	24.4	52.4	22.6°C	2020/8/10	24.72	53.2	1.31%	1.53%

Note: The input power level is equivalent to 1w

11. Measurement Procedures

11.1. Test Steps

According to the SAR test standard, the recommended procedure for assessing the peak spatial-average SAR value consists of the following steps:

(a) Power reference measurement

The reference and drift jobs are useful for monitoring the power drift of the device under test in the batch process. Both jobs measure the electric field strength at a specified reference position, at a selectable distance from the phantom surface. The reference position can be either the selected section's grid reference point or a user point in this section. The reference job projects the selected point onto the phantom surface, orients the probe perpendicularly to the surface, and approaches the surface using the selected detection method.

(b) Area scan

The area scan is used as a fast scan in two dimensions to find the area of high field values, before doing a finer measurement around the hot spot. The sophisticated interpolation routines implemented in DASY software can find the maximum locations even in relatively coarse grids. The scan area is defined by an editable grid. This grid is anchored at the grid reference point of the selected section in the phantom. When the area scan's property sheet is brought up, grid was at to 15mm * 15mm and can be edited by users.

(c) Zoom scan

Zoom scans are used to assess the peak spatial SAR values within a cubic averaging volume containing 1g and 10g of simulated tissue. The default zoom scan measures 5 * 5 * 7 points within a cube whose base faces are centered around the maximum found in a preceding area scan job within the same procedure. If the preceding Area Scan job indicates more than one maximum, the number of Zoom Scans has to be enlarged accordingly.

(d) Power drift measurement

The drift job measures the field at the same location as the most recent reference job within the same procedure, and with the same setting. The drift measurement gives the field difference in dB from the reading conducted within the last reference measurement. Several drift measurements are possible for one reference measurement. This allows a user to monitor the power drift of the device under within a batch process. In the properties of the drift job, the user can specify a limit for the drift and have DASY software stop the measurements if this limit is exceeded. This ensures that the power drift during one measurement is within 5%.

The SAR measurement procedures for each of test conditions are as follows:

- (a) Make EUT to transmit it maximum output power
- (b) Measure conducted output power through RF cable
- (c) Place the EUT in the specific position of phantom
- (d) Measure SAR results for Middle channel or the highest power channel on each testing position
- (e) Measure SAR results for other channels in worst SAR testing position if the reported SAR of highest power channel is larger than 0.8 W/kg
- (f) Record the SAR value

11.2. Spatial Peak SAR Evaluation

The procedure for spatial peak SAR evaluation has been implemented according to the IEEE1529 standard. It can be conducted for 1g and 10g.

The DASY system allows evaluations that combine measured data and robot positions, such as:

a) Maximum Search

During a maximum search, global and local maximum searches are automatically performed in 2D after each Area Scan measurement with at least 6 measurement points. It is based on the evaluation of the local SAR gradient calculated by the Quadratic Shepard's method. The algorithm will find the global maximum and all local maxima within -2dB of the global maxima for all SAR distributions.

b) Extrapolation

Extrapolation routines are used to obtain SAR values between the lowest measurement points and the inner phantom surface. The extrapolation distance is determined by the surface detection distance and the probe sensor offset. Several measurements at different distances are necessary for the extrapolation. Extrapolation routines require at least 10 measurement points in 3D space. They are used in the Cube Scan to obtain SAR values between the lowest measurement points and the inner phantom surface. The routine uses the modified Quadratic Shepard's method for extrapolation. For a grid using 5*5*5 measurement points with 5mm resolution amounting to 343 measurement points, the uncertainty of the extrapolation routines is less than 1% for 1g and 10 cubes.

c) Boundary effect

For measurements in the immediate vicinity of a phantom surface, the field coupling effects between the probe and the boundary influence the probe characteristics. Boundary effect errors of different dosi-metric probe types have been analyzed by measurements and using a numerical probe model. As expected, both methods showed an enhanced sensitivity in the immediate vicinity of the boundary. The effect strongly depends on the probe dimensions and disappears with increasing distance from the boundary. The sensitivity can be approximately given as:

$$S \approx S_0 + S_b * \exp\left(-\frac{z}{a}\right) * \cos\left(\pi \frac{z}{\lambda}\right)$$

Since the decay of the boundary effect dominates for small probe ($a \ll \lambda$), the cos-term can be omitted. Factors S_b (parameter Alpha in the DASY software) and a (parameter Delta in the DASY software) are assessed during probe calibration and used for numerical compensation of the boundary effect. Several simulations and measurements have confirmed that the compensation is valid for different field and boundary configurations.

This simple compensation procedure can largely reduce the probe uncertainty near boundaries. It works well as long as:

- The boundary curvature is small
- The probe axis is angled less than 30° to the boundary normal
- The distance between probe and boundary is larger than 25% of the probe diameter
- The probe is symmetric (all sensors have the same offset from the probe tip)

Since all of these requirements are fulfilled in a DASY system, the correction of the probe boundary effect in the vicinity of the phantom surface is performed in a fully automated manner via the measurement data extraction during post processing.

11.3. General Measurement Procedure

The area and zoom scan resolutions specified in the table below must be applied to the SAR measurements and fully documented in SAR reports to qualify for TCB approval. Probe boundary effect error compensation is required for measurements with the probe tip closer than half a probe tip diameter to the phantom surface. Both the probe tip diameter and sensor offset distance must satisfy measurement protocols; to ensure probe boundary effect errors are minimized and the higher fields closest to the phantom surface can be correctly measured and extrapolated to the phantom surface for computing 1-g SAR. Tolerances of the post-processing algorithms must be verified by the test laboratory for the scan resolutions used in the SAR measurements, according to the reference distribution functions specified in IEEE Std 1528-2013. The results should be documented as part of the system validation records and may be requested to support test results when all the measurement parameters in the following table are not satisfied.

Table 11.1: Test Resolution Requirement

Items		≤3GHz	>3GHz	
Maximum Distance		5mm ±1mm	$\frac{1}{2} * \delta * \ln(2)$ mm ±0.5mm	
Maximum probe angle		30±1°	20±1°	
Maximum Area Scan spatial resolution: ΔX_{Area} , ΔY_{Area}		≤2GHz: ≤15mm	3-4GHz: ≤12mm	
		2-3GHz: ≤12mm	4-6GHz: ≤10mm	
		when the x or y dimension of the device , in the measurement plane orientation, is smaller than the above, the measurement resolution must be ≤ the corresponding x or y dimension of the device with at least one measurement point on the device		
Maximum Zoom Scan spatial resolution: ΔX_{Zoom} , ΔY_{Zoom}		≤2GHz: ≤8mm	3-4GHz: ≤5mm	
		2-3GHz: ≤5mm	4-6GHz: ≤4mm	
maximum zoom scan spatial resolution, normal to phantom surface	uniform grid: $\Delta Z_{Zoom}(n)$	≤5mm	3-4GHz: ≤4mm	
	graded grid		$\Delta Z_{Zoom}(1)$: between 1 st two points closest to phantom surface	4-5GHz: ≤3mm
			$\Delta Z_{Zoom}(n > 1)$ between subsequent points	5-6GHz: ≤2mm
			3-4GHz: ≤3mm	
			4-5GHz: ≤2.5mm	
			5-6GHz: ≤2mm	
			≤1.5*	
minimum zoom scan volume	x, y, z	≥30mm	3-4GHz: ≥28mm 4-5GHz: ≥25mm 5-6GHz: ≥22mm	

Notes:

δ is the penetration depth of a plane-wave at normal incidence to the tissue medium in IEEE 1528-2013.

When Zoom Scan is required and reported SAR from the Area Scan based 1-g SAR estimation procedure of KDB publication 447498 is ≤1.4 W/kg, ≤8mm for 2GHz-3GHz, ≤7mm for 3GHz-4GHz, ≤5mm for 4GHz-6GHz Zoom Scan resolution may be applied.

11.4. WCDMA Measurement Procedures

The following procedures are applicable to WCDMA handsets operating under 3GPP Release99, Release 5 and Release 6. The default test configuration is to measure SAR with an established radio link between the DUT and a communication test set using a 12.2kbps RMC (reference measurement channel) configured in Test Loop Mode 1. SAR is selectively confirmed for other physical channel configurations (DPCCH & DPDCHn), HSDPA and HSPA (HSUPA/HSDPA) modes according to output power, exposure conditions and device operating capabilities. Both uplink and downlink should be configured with the same RMC or AMR, when required. SAR for Release 5 HSDPA and Release 6 HSPA are measured using the applicable FRC (fixed reference channel) and E-DCH reference channel configurations. Maximum output power is verified according to applicable versions of 3GPP TS 34.121 and SAR must be measured according to these maximum output conditions. When Maximum Power Reduction (MPR) is not implemented according to Cubic Metric (CM) requirements for Release 6 HSPA, the following procedures do not apply.

Table 11.2: HSDPA setting for Release 5

Sub-test	β_c	β_d	β_d (SF)	β_c / β_d	β_{hs}	CM (dB)	MPR (dB)
1	2/15	15/15	64	2/15	4/15	1.5	0.5
2	12/15	15/15	64	12/15	24/25	2.0	1
3	15/15	8/15	64	15/8	30/15	2.0	1
4	15/15	4/15	64	15/4	30/15	2.0	1

Table 11.3: HSUPA setting for Release 6

Sub-test	β_c	β_d	β_d (SF)	β_c / β_d	β_{hs}	β_{ec}	β_{ed}	β_{ed} (SF)	β_{ed} (codes)	CM (dB)	MPR (dB)	AG Index	E-TFCI
1	11/15	15/15	64	11/15	22/15	209/225	1039/225	4	1	2.0	1.0	20	75
2	6/15	15/15	64	6/15	12/15	12/15	12/15	4	1	3.0	2.0	12	67
3	15/15	9/15	64	15/9	30/15	30/15	β_{ed1} :47/15 β_{ed2} :47/15	4	2	3.0	2.0	15	92
4	2/15	15/15	64	2/15	4/15	4/15	56/75	4	1	2.0	1.0	17	71
5	15/15	15/15	64	15/15	24/15	30/15	134/15	4	1	2.0	1.0	21	81

Note:

A KDB inquiry is required to address test and approval requirements when the maximum output power measured in HS-DPCCH Sub-test 2 – 4 is higher than Sub-test 1.

A KDB inquiry is required to determine test and approval requirements when the maximum output power measured in E-DCH Sub-test 2 – 4 is higher than Sub-test 5.

11.5. LTE Measurement Procedure

SAR tests for LTE are performed with a base station simulator. Closed loop power control was used so the UE transmits with maximum output power during SAR testing.

1. Per KDB 941225 D05, start with the largest channel bandwidth and measure SAR for QPSK with 1 RB allocation, using the RB offset and required test channel combination with the highest maximum output power for RB offsets at the upper edge, middle and lower edge of each required test channel.
2. 50% RB allocation for QPSK SAR testing follows 1RB QPSK allocation procedure.
3. For QPSK with 100% RB allocation, SAR is not required when the highest maximum output power for 100 % RB allocation is less than the highest maximum output power in 50% and 1 RB allocations and the highest reported SAR for 1 RB and 50% RB allocation are ≤ 0.8 W/kg. Otherwise, SAR is measured for the highest output power channel; and if the reported SAR is > 1.45 W/kg, the remaining required test channels must also be tested.
4. 16QAM/64QAM output power for each RB allocation configuration is $>$ not $\frac{1}{2}$ dB higher than the same configuration in QPSK and the reported SAR for the QPSK configuration is ≤ 1.45 W/kg; 16QAM/64QAM SAR testing is not required.
5. Smaller bandwidth output power for each RB allocation configuration is $>$ not $\frac{1}{2}$ dB higher than the same configuration in the largest supported bandwidth, and the reported SAR for the largest supported bandwidth is ≤ 1.45 W/kg; smaller bandwidth SAR testing is not required.
6. For LTE B12 / B26 the maximum bandwidth does not support three non-overlapping channels, when a device supports overlapping channel assignment in a channel bandwidth configuration, the middle channel of the group of overlapping channels should be selected for testing.
7. LTE band 17 / 2 / 5 / 38 / 4 SAR test was covered by Band 12 / 25 / 26 / 41 / 66; according to TCB workshop, SAR test for overlapping LTE bands can be reduced if
 - a. The maximum output power, including tolerance, for the smaller band is \leq the larger band to qualify for the SAR test exclusion.
 - b. The channel bandwidth and other operating parameters for the smaller band are fully supported by the larger band.

LTE Carrier Aggregation Conducted Power (Downlink)

According to KDB941225 D05A v01r02, Uplink maximum output power measurement with downlink carrier aggregation active should be measured, using the highest output channel measured without downlink carrier aggregation, to confirm that uplink maximum output power with downlink carrier aggregation active remains within the specified tune-up tolerance limits and not more than $\frac{1}{4}$ dB higher than the maximum output measured without downlink carrier aggregation active.

LTE TDD Considerations

According to KDB 941225 D05 SAR for LTE Devices, for Time-Division Duplex (TDD) systems, SAR must be tested using a fixed periodic duty factor according to the highest transmission duty factor implemented for the device and supported by the defined 3GPP LTE TDD configurations.

SAR was tested with the highest transmission duty factor (63.33%) using Uplink-downlink configuration 0 and Special sub-frame configuration 7.

LTE TDD Band 41 supports 3GPP TS 36.211 section 4.2 for Type 2 Frame Structure and Table 4.2-2 for uplink-downlink configurations and Table 4.2-1 for Special sub-frame configurations.

Table 11.4 Calculated Duty Cycle for LTE TDD

Uplink-Downlink Configuration		Sub-frame Number										Calculated
0	Periodicity	1	2	3	4	5	6	7	8	9	10	Duty Cycle (%)
0	5 ms	D	S	U	U	U	D	S	U	U	U	63.33
1	5 ms	D	S	U	U	D	D	S	U	U	D	43.33
2	5 ms	D	S	U	D	D	D	S	U	D	D	23.33
3	10 ms	D	S	U	U	U	D	D	D	D	D	31.67
4	10 ms	D	S	U	U	D	D	D	D	D	D	21.67
5	10 ms	D	S	U	D	D	D	D	D	D	D	11.67
6	5 ms	D	S	U	U	U	D	S	U	U	D	53.33

Example for Calculated Duty Cycle for Uplink-Downlink Configuration 0:

$$\text{Calculated Duty Cycle} = (5120 \times T_s \times 2 + 6 \text{ ms}) / 10\text{ms} = 63.33\%$$

Where

$$T_s = 1/(15000 \times 2048) \text{ seconds}$$

11.6. Bluetooth & WiFi Measurement Procedures

Normal network operating configurations are not suitable for measuring the SAR of 802.11 transmitters in general. Unpredictable fluctuations in network traffic and antenna diversity conditions can introduce undesirable variations in SAR results. The SAR for these devices should be measured using chipset based test mode software to ensure that the results are consistent and reliable.

Chipset based test mode software is hardware dependent and generally varies among manufacturers. The device operating parameters established in a test mode for SAR measurements must be identical to those programmed in production units, including output power levels, amplifier gain settings and other RF performance tuning parameters. The test frequencies should correspond to actual channel frequencies defined for domestic use. SAR for devices with switched diversity should be measured with only one antenna transmitting at a time during each SAR measurement, according to a fixed modulation and data rate. The same data pattern should be used for all measurements.

12. Simultaneous Transmission SAR Considerations

12.1. Reference Document

The following procedures adopted from “FCC SAR Considerations for Cell Phones with Multiple Transmitters” are applicable to handsets with built-in unlicensed transmitters such as 802.11 a/b/g and Bluetooth devices which may simultaneously transmit with the licensed transmitter.

12.2. Antenna Separation Distances

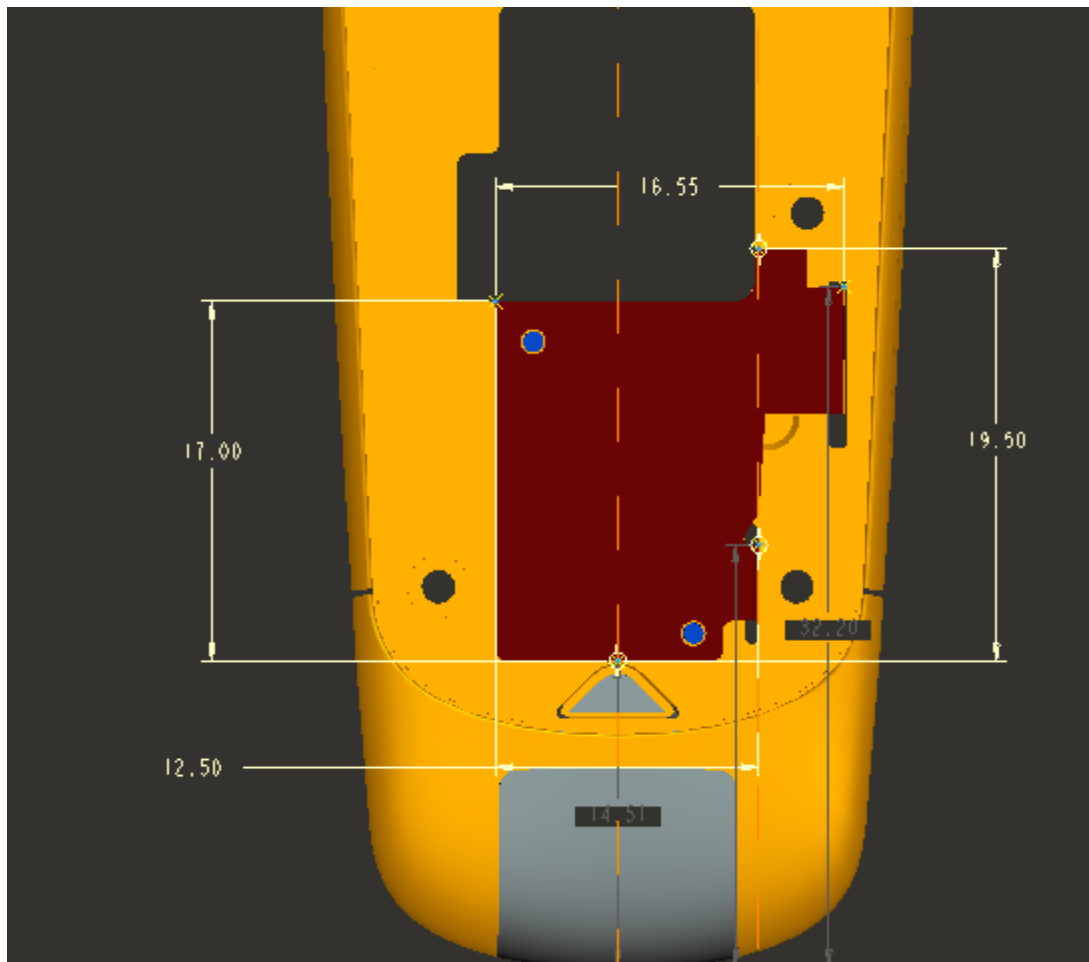

Picture 12-1 Antenna Locations

12.3. SAR Measurement Positions

According to the KDB941225 D06 Hot Spot SAR v01, the edges with less than 2.5 cm distance to the antennas need to be tested for SAR.

Table 12.1: SAR measurement Positions

Antenna Mode	Front	Back	Left	Right	Top	Bottom
BT/WiFi	Yes	Yes	No	Yes	Yes	No

12.4. Low Power Transmitters SAR Consideration

Standalone 1-g head or body SAR evaluation by measurement or numerical simulation for low power transmitters is not required when the corresponding SAR Exclusion Threshold condition, listed below, is satisfied.

The 1-g SAR test exclusion threshold for 100 MHz to 6 GHz at test separation distances ≤ 50 mm are determined by:

$$\frac{(\text{max. power of channel, including tune-up tolerance, mW})}{(\text{min. test separation distance, mm})} * \sqrt{\text{Frequency (GHz)}} \leq 3.0$$

Where

- Frequency(GHz) is the RF channel transmit frequency in GHz
- Power and distance are rounded to the nearest mW and mm before calculation
- The result is rounded to one decimal place for comparison

According to the KDB447498 appendix A, the SAR test exclusion threshold for 2450MHz at 5mm test separation distances is 10mW. That means the transmitters with tune-up power below 10mW are excluded for SAR measurement.

12.5. Simultaneous Transmission Analysis

KDB 447498 D01 General RF Exposure Guidance introduces a new formula for calculating the SPLSR (SAR to Peak Location Ratio) between pairs of simultaneously transmitting antennas:

$$\text{SPLSR} = \sqrt{(SAR1 + SAR2)^3 / R_i}$$

Where

- SAR1 is the highest measured or estimated SAR for the first of a pair of simultaneous transmitting antennas, in a specific test operating mode and exposure condition.
- SAR2 is the highest measured or estimated SAR for the second of a pair of simultaneous transmitting antennas, in the same test operating mode and exposure condition as the first.
- Ri is the separation distance between the pair of simultaneous transmitting antennas. When the SAR is measured, for both antennas in the pair, it is determined by the actual x, y and z coordinates in the 1-g SAR for each SAR peak location, based on the extrapolated and interpolated result in the zoom scan measurement, using the formula of

$$(x1 - x2)^2 + (y1 - y2)^2 + (z1 - z2)^2$$

In order for a pair of simultaneous transmitting antennas with the sum of 1-g SAR > 1.6 W/kg to qualify for

exemption from Simultaneous Transmission SAR measurements, it has to satisfy the condition of:

$$\sqrt{(SAR1 + SAR2)^3/Ri} < 0.04$$

13. Conducted Output Power

13.1. BT Measurement result

Table 13.7: The conducted power for Bluetooth

BlueTooth		BT conducted power (dBm)					
Mode	Channel	DH5		2DH5		3DH5	
		Tune up	Output Power	Tune up	Output Power	Tune up	Output Power
BT4.2	0	9.6	9.54	8.5	8.23	8.5	8.21
	39	9.6	9.35	8.5	7.93	8.5	8.06
	78	9.6	9.21	8.5	7.84	8.5	8.03
BlueTooth		BLE conducted power (dBm)					
Mode		Tune up		Channel		Output Power	
BLE		4		0		3.843	
		4		19		3.683	
		4		38		3.454	

NOTE: According to KDB447498 D01 BT standalone SAR are not required, because maximum average output power is less than 10mW.

Evaluation=2.872 < 3.0

When the standalone SAR test exclusion is applied to an antenna that transmits simultaneously with other antennas, the standalone SAR must be estimated according to the following to determine simultaneous transmission SAR test exclusion:

$$SAR = \frac{P(\text{Max. Power of channel, including tuneup tolerance, mW})}{D(\text{Min. test separation distance, mm})} * \frac{\sqrt{\text{frequency(GHz)}}}{x}$$

Where

- D (Min, test separation distances, mm) is always set to 50 mm for Head SAR evaluation
- Frequency(GHz) is the center frequency in GHz
- where x = 7.5 for 1-g SAR, and x = 18.75 for 10-g SAR

Therefor

- SAR body value of BT is 0.153 W/Kg for 10g where D is set to 5mm

13.2. WiFi Measurement result

Table 13.8: The average conducted power for WiFi

WiFi			WiFi 2.4G conducted power(dBm)	
Mode	BW	Channel	Tune up	Output Power
802.11b	20M	1	17	16.46
		6	17	16.40
		11	17	16.29
802.11g	20M	1	17	16.00
		6	17	16.04
		11	17	15.9
802.11n	20M	1	16	15.16
		6	16	15.13
		11	16	15.05
	40M	3	14	13.51
		6	14	13.49
		11	14	13.36

2.4 GHz 802.11g/n OFDM SAR Test Exclusion Requirements

When SAR measurement is required for 2.4 GHz 802.11g/n OFDM configurations, the measurement and test reduction procedures for OFDM are applied. SAR is not required for the following 2.4 GHz OFDM conditions.

- a) When KDB Publication 447498 D01 SAR test exclusion applies to the OFDM configuration.
- b) When the highest *reported* SAR for DSSS is adjusted by the ratio of OFDM to DSSS specified maximum output power and the adjusted SAR is ≤ 1.2 W/kg.

The default power measurement procedures are:

- a) Power must be measured at each transmit antenna port according to the DSSS and OFDM transmission configurations in each standalone and aggregated frequency band.
- b) Power measurement is required for the transmission mode configuration with the highest maximum output power specified for production units.
 - 1) When the same highest maximum output power specification applies to multiple transmission modes, the largest channel bandwidth configuration with the lowest order modulation and lowest data rate is measured.
 - 2) When the same highest maximum output power is specified for multiple largest channel bandwidth configurations with the same lowest order modulation or lowest order modulation and lowest data rate, power measurement is required for all equivalent 802.11 configurations with the same maximum output power.
- c) For each transmission mode configuration, power must be measured for the highest and lowest channels; and at the mid-band channel(s) when there are at least 3 channels. For configurations with multiple mid-band channels, due to an even number of channels, both channels should be measured.

During WiFi SAR testing EUT is configured with the WiFi continuous TX tool, and the transmission duty factor was monitored on the spectrum analyzer with zero-span setting, the duty cycle is 100%.

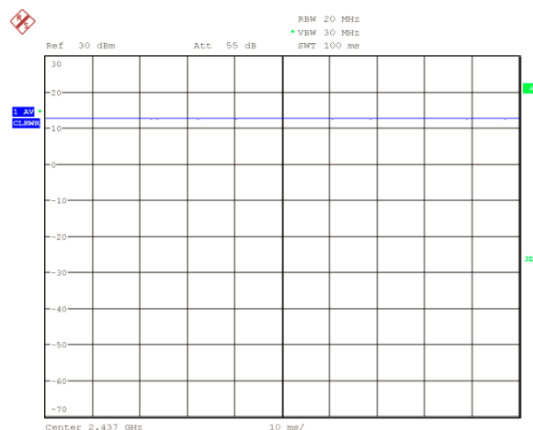

Picture 13-1 WiFi 11b duty factor

14. SAR Measurement Result

14.1. Standalone SAR Test Result

Table 14.1: SAR Values for WIFI 2.4G

Test Position	Cover Type	Mode	BW(MHz)	Duty Cycle	Channel	Frequency (MHz)	Measured power (dBm)	Tune-up (dBm)	Power Drift (dB)	Limit of 10gSAR 4.0 W/kg (mW/g)			Figure No.
										Measured SAR10g	Scaling Factor	Report SAR10g	
Limb SAR (Distance 0mm)													
Front Side	Standard	802.11b	20	1:1	6	2437	16.4	17	-0.09	1.34	1.15	1.539	1
Back Side	Standard	802.11b	20	1:1	6	2437	16.4	17	0.00	0.23	1.15	0.264	/
Left Side	Standard	802.11b	20	1:1	6	2437	16.4	17	0.00	0.182	1.15	0.209	/
Right Side	Standard	802.11b	20	1:1	6	2437	16.4	17	-0.03	0.121	1.15	0.139	/
Top Side	Standard	802.11b	20	1:1	6	2437	16.4	17	-0.03	0.0904	1.15	0.104	/

14.2. SAR Measurement Variability

SAR measurement variability must be assessed for each frequency band, which is determined by the SAR probe calibration point and tissue-equivalent medium used for the device measurements. When both head and body tissue-equivalent media are required for SAR measurements in a frequency band, the variability measurement procedures should be applied to the tissue medium with the highest measured SAR, using the highest measured SAR configuration for that tissue-equivalent medium.

The following procedures are applied to determine if repeated measurements are required.

- 1) Repeated measurement is not required when the original highest measured SAR is < 0.80 W/kg; steps 2) through 4) do not apply.
- 2) When the original highest measured SAR is ≥ 0.80 W/kg, repeat that measurement once.
- 3) Perform a second repeated measurement only if the ratio of largest to smallest SAR for the original and first repeated measurements is > 1.20 or when the original or repeated measurement is ≥ 1.45 W/kg ($\sim 10\%$ from the 1-g SAR limit).
- 4) Perform a third repeated measurement only if the original, first or second repeated measurement is ≥ 1.5 W/kg and the ratio of largest to smallest SAR for the original, first and second repeated measurements is > 1.20 .

Table 14.5: SAR Measurement Variability (10g)

Frequency		Configuration	Test Position	Original SAR (W/kg)	First Repeated SAR (W/kg)	The Ratio
MHz	Ch.					
--	--	--	--	--	--	--

Note: According to the KDB 865664 D01 repeated measurement is not required when the original highest measured SAR is < 0.8 W/kg.

15. Test Equipment Utilized

Table 15.1 SAR Test System Equipment List

Item	Instrument Name	Type	Serial Number	Manufacturer	Cal. Date	Cal. interval
1	Network analyzer	N5242A	MY51221755	Agilent	2019-12-11	1 year
2	Power meter	NRVD	102257	RS	2020-5-10	1 year
3	Power sensor	NRV-Z5	100241			
			100644			
4	Signal Generator	E4438C	MY49072044	Agilent	2020-5-10	1 Year
5	Amplifier	NTWPA-0086010F	12023024	rflight	No Calibration Requested	
6	Coupler	778D	MY4825551	Agilent	2020-5-10	1 year
7	E-field Probe	EX3DV4	7401	SPEAG	2020-04-01	1 year
8	DAE	SPEAG DAE4	1581	SPEAG	2020-05-06	1 year
9	Dipole Validation Kit	SPEAG D2450V2	858	SPEAG	2018-10-26	3 year

16. Measurement Uncertainty

Table 16.1 Measurement Uncertainty Evaluation for SAR test

Error Description	Uncert. Value	Prob. Dist.	Div.	(Ci)	(Ci)	Std. Unc. [%]	Std. Unc. [%]	(Ui) ueff
				1g	10g	(1g)	(10g)	
Measurement System								
Probe Calibration	13.3	N	2	1	1	6.65	6.65	∞
Axial Isotropy	4.7	R	$\sqrt{3}$	0.7	0.7	1.90	1.90	∞
Hemispherical Isotropy	9.6	R	$\sqrt{3}$	0.7	0.7	3.88	3.88	∞
Boundary effects	1	R	$\sqrt{3}$	1	1	0.58	0.58	∞
Linearity	4.7	R	$\sqrt{3}$	1	1	2.70	2.70	∞
System Detection Limits	1	R	$\sqrt{3}$	1	1	0.58	0.58	∞
Readout Electronics	0.7	N	1	1	1	0.70	0.70	∞
Response Time	0.8	R	$\sqrt{3}$	1	1	0.50	0.50	∞
Integration Time	2.6	R	$\sqrt{3}$	1	1	1.50	1.50	∞
RF Ambient Noise	3	R	$\sqrt{3}$	1	1	1.70	1.70	∞
RF Ambient Reflections	3	R	$\sqrt{3}$	1	1	1.70	1.70	∞
Probe Positioner	0.4	R	$\sqrt{3}$	1	1	0.20	0.20	∞
Probe Positioning	2.9	R	$\sqrt{3}$	1	1	1.70	1.70	∞
Post-processing	4	R	$\sqrt{3}$	1	1	2.30	2.30	∞
Test Sample Related								
Device Holder	2.55	N	1	1	1	2.55	2.55	71
Test Sample Positioning	1.34	N	1	1	1	1.34	1.34	3
Power Drift	5	R	$\sqrt{3}$	1	1	2.9	2.9	∞
Phantom and Setup								
Phantom Uncertainty	4	R	$\sqrt{3}$	1	1	2.3	2.3	∞
Liquid Conductivity (target)	5	R	$\sqrt{3}$	0.64	0.43	2.9	2.9	∞
Liquid Conductivity (meas.)	5	N	1	0.64	0.43	5	5	∞
Liquid Permittivity (target)	5	R	$\sqrt{3}$	0.6	0.49	2.9	2.9	∞
Liquid Permittivity (meas.)	5	N	1	0.6	0.49	5	5	∞
Combined Std. Uncertainty	$U_C = \sqrt{\sum_{i=1}^{23} C_i^2 U_i^2}$					11.23	10.70	
Expanded STD Uncertainty	$U_C = 2U_C'$					22.45	21.40	

Table 16.2 Measurement Uncertainty Evaluation for System Validation

Error Description	Uncert. Value	Prob. Dist.	Div.	(Ci)	(Ci)	Std. Unc.[%]	Std. Unc.[%]	(Ui) ueff
				1g	10g	(1g)	(10g)	
Measurement System								
Probe Calibration	13.3	N	2	1	1	6.65	6.65	∞
Axial Isotropy	4.7	R	$\sqrt{3}$	0.7	0.7	1.90	1.90	∞
Hemispherical Isotropy	9.6	R	$\sqrt{3}$	0.7	0.7	3.88	3.88	∞
Boundary effects	1	R	$\sqrt{3}$	1	1	0.58	0.58	∞
Linearity	4.7	R	$\sqrt{3}$	1	1	2.70	2.70	∞
System Detection Limits	1	R	$\sqrt{3}$	1	1	0.58	0.58	∞
Readout Electronics	0.7	N	1	1	1	0.70	0.70	∞
Response Time	0.8	R	$\sqrt{3}$	1	1	0.50	0.50	∞
Integration Time	2.6	R	$\sqrt{3}$	1	1	1.50	1.50	∞
RF Ambient Noise	3	R	$\sqrt{3}$	1	1	1.70	1.70	∞
RF Ambient Reflections	3	R	$\sqrt{3}$	1	1	1.70	1.70	∞
Probe Positioner	0.4	R	$\sqrt{3}$	1	1	0.20	0.20	∞
Probe Positioning	2.9	R	$\sqrt{3}$	1	1	1.70	1.70	∞
Post-processing	4	R	$\sqrt{3}$	1	1	2.30	2.30	∞
Test Sample Related								
Validation Dipole Positioning	2	N	1	1	1	2	2	
Dipole Input Power	5	N	1	1	1	5	5	
Power Drift	5	R	$\sqrt{3}$	1	1	2.9	2.9	∞
Phantom and Setup								
Phantom Uncertainty	4	R	$\sqrt{3}$	1	1	2.3	2.3	∞
Liquid Conductivity (target)	5	R	$\sqrt{3}$	0.64	0.43	2.9	2.9	∞
Liquid Conductivity (meas.)	5	N	1	0.64	0.43	5	5	∞
Liquid Permittivity (target)	5	R	$\sqrt{3}$	0.6	0.49	2.9	2.9	∞
Liquid Permittivity (meas.)	5	N	1	0.6	0.49	5	5	∞
Combined Std. Uncertainty	$U_c = \sqrt{\sum_{i=1}^{23} C_i^2 U_i^2}$					12.11	11.63	
Expanded STD Uncertainty	$U_c = 2U_c$					24.23	23.26	

END OF REPORT BODY

ANNEX A. Graph Results

Fig.1 WiFi2.4G Phantom Mode Middle

Date/Time: 2020/8/10

Electronics: DAE4 Sn1581

Medium parameters used (extrapolated): $f = 2437$ MHz; $\sigma = 1.777$ S/m; $\epsilon_r = 38.489$; $\rho = 1000$ kg/m³

Ambient Temperature: 22.6°C Liquid Temperature: 22.6°C

Communication System: WLAN 2450 2600MHz; Frequency: 2437 MHz; Duty Cycle: 1:1

Probe: EX3DV4 - SN7401ConvF(7.85, 7.85, 7.85) @ 2437 MHz

WiFi2.4G Phantom Mode Middle/Area Scan (41x121x1):

Measurement grid: dx=10 mm, dy=10 mm

Maximum value of SAR (Measurement) = 9.07 W/kg

WiFi2.4G Phantom Mode Middle/Zoom Scan (7x7x7)/Cube 0:

Measurement grid: dx=5mm, dy=5mm, dz=5mm

Reference Value = 8.407 V/m; Power Drift = -0.09 dB

Peak SAR (extrapolated) = 12.8 W/kg

SAR(1 g) = 3.98 W/kg; SAR(10 g) = 1.34 W/kg

Maximum value of SAR (measured) = 8.92 W/kg

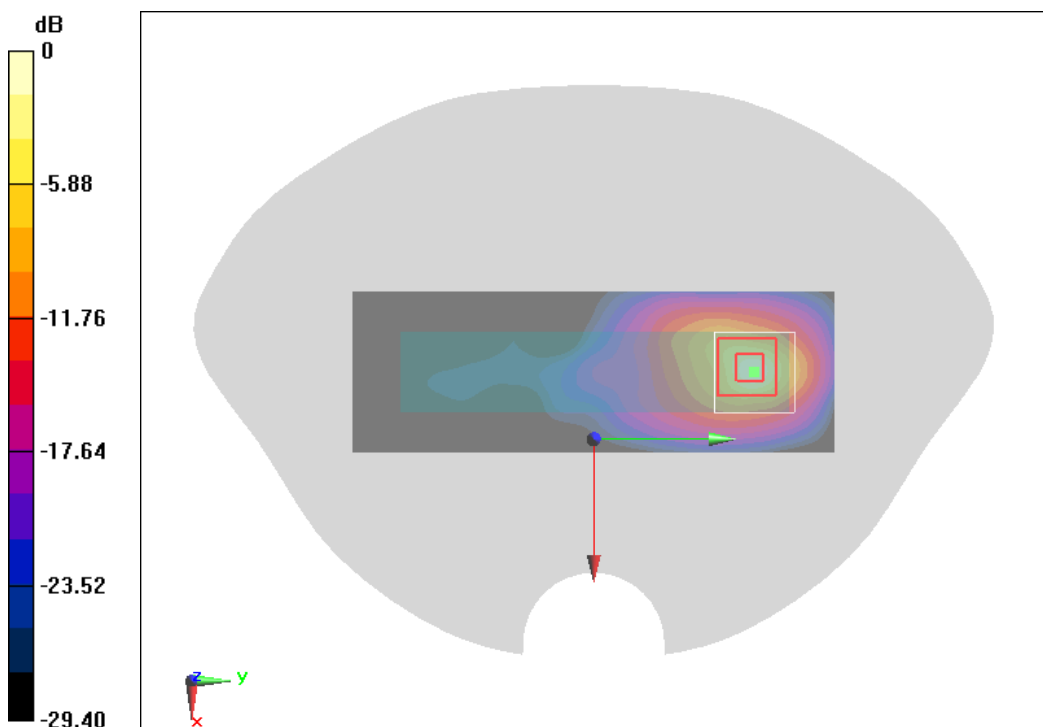

ANNEX B. System Validation Plot

Head 2450MHz

Date/Time: 2020/8/10

Electronics: DAE4 Sn1581

Medium parameters used (interpolated): $f = 2450$ MHz; $\sigma = 1.787$ S/m; $\epsilon_r = 38.473$; $\rho = 1000$ kg/m³

Ambient Temperature: 22.6°C Liquid Temperature: 22.6°C

Communication System: CW 2600MHz; Frequency: 2450 MHz; Duty Cycle: 1:1

Probe: EX3DV4 - SN7401ConvF(7.85, 7.85, 7.85) @ 2450 MHz

Head 2450MHz/Area Scan (101x101x1):

Measurement grid: dx=10 mm, dy=10 mm

Maximum value of SAR (Measurement) = 22.6 W/kg

Head 2450MHz/Zoom Scan (7x7x7)/Cube 0:

Measurement grid: dx=5mm, dy=5mm, dz=5mm

Reference Value = 113.4 V/m; Power Drift = 0.00 dB

Peak SAR (extrapolated) = 28.5 W/kg

SAR(1 g) = 13.3 W/kg; SAR(10 g) = 6.18 W/kg

Maximum value of SAR (measured) = 22.8 W/kg

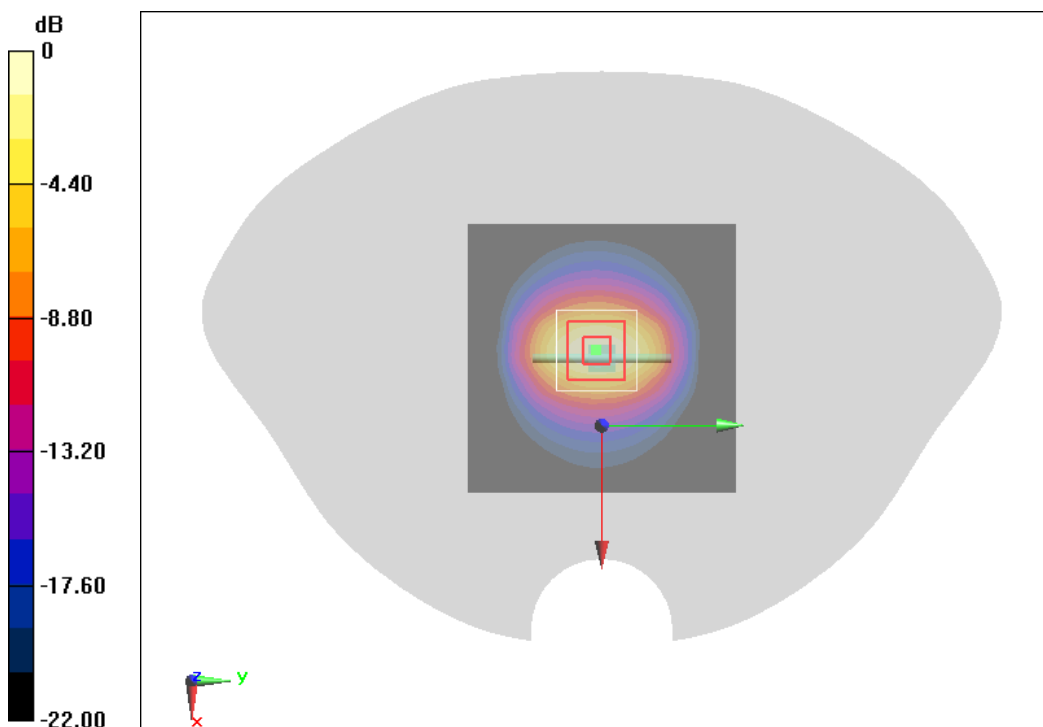

ANNEX C. Calibration Certification



In Collaboration with
s p e a g
 CALIBRATION LABORATORY



中国认可
 国际互认
 校准
 CALIBRATION
 CNAS L0570

Add: No.51 Xueyuan Road, Haidian District, Beijing, 100191, China
 Tel: +86-10-62304633-2512 Fax: +86-10-62304633-2504
 E-mail: cttl@chinattl.com [Http://www.chinattl.cn](http://www.chinattl.cn)

 Client : **CTTL-SH**

 Certificate No: **Z20-60180**

CALIBRATION CERTIFICATE

Object: **DAE4 - SN: 1581**

Calibration Procedure(s): **FF-Z11-002-01**
 Calibration Procedure for the Data Acquisition Electronics (DAEx)

Calibration date: **May 06, 2020**

This calibration Certificate documents the traceability to national standards, which realize the physical units of measurements(SI). The measurements and the uncertainties with confidence probability are given on the following pages and are part of the certificate.

All calibrations have been conducted in the closed laboratory facility: environment temperature(22±3)°C and humidity<70%.

Calibration Equipment used (M&TE critical for calibration)

Primary Standards	ID #	Cal Date(Calibrated by, Certificate No.)	Scheduled Calibration
Process Calibrator 753	1971018	24-Jun-19 (CTTL, No.J19X05126)	Jun-20

	Name	Function	Signature
Calibrated by:	Yu Zongying	SAR Test Engineer	
Reviewed by:	Lin Hao	SAR Test Engineer	
Approved by:	Qi Dianyuan	SAR Project Leader	

Issued: May 08, 2020

This calibration certificate shall not be reproduced except in full without written approval of the laboratory.



Add: No.51 Xueyuan Road, Haidian District, Beijing, 100191, China
Tel: +86-10-62304633-2512 Fax: +86-10-62304633-2504
E-mail: cttl@chinattl.com Http://www.chinattl.cn

Glossary:

DAE data acquisition electronics
Connector angle information used in DASY system to align probe sensor X to the robot coordinate system.

Methods Applied and Interpretation of Parameters:

- *DC Voltage Measurement:* Calibration Factor assessed for use in DASY system by comparison with a calibrated instrument traceable to national standards. The figure given corresponds to the full scale range of the voltmeter in the respective range.
- *Connector angle:* The angle of the connector is assessed measuring the angle mechanically by a tool inserted. Uncertainty is not required.
- The report provide only calibration results for DAE, it does not contain other performance test results.



Add: No.51 Xueyuan Road, Haidian District, Beijing, 100191, China
 Tel: +86-10-62304633-2512 Fax: +86-10-62304633-2504
 E-mail: cttl@chinattl.com Http://www.chinattl.cn

DC Voltage Measurement

A/D - Converter Resolution nominal

High Range: 1LSB = 6.1 μ V, full range = -100...+300 mV
 Low Range: 1LSB = 61nV, full range = -1.....+3mV

DASY measurement parameters: Auto Zero Time: 3 sec; Measuring time: 3 sec

Calibration Factors	X	Y	Z
High Range	405.200 \pm 0.15% (k=2)	405.459 \pm 0.15% (k=2)	405.719 \pm 0.15% (k=2)
Low Range	3.99505 \pm 0.7% (k=2)	3.99885 \pm 0.7% (k=2)	4.00362 \pm 0.7% (k=2)

Connector Angle

Connector Angle to be used in DASY system	13 $^{\circ}$ \pm 1 $^{\circ}$
---	----------------------------------



In Collaboration with
s p e a g
 CALIBRATION LABORATORY



中国认可
 国际互认
 校准
 CALIBRATION
 CNAS L0570

Add: No.51 Xueyuan Road, Haidian District, Beijing, 100191, China
 Tel: +86-10-62304633-2512 Fax: +86-10-62304633-2504
 E-mail: cttl@chinattl.com Http://www.chinattl.cn

 Client **CTTL-SH**

 Certificate No: **Z20-60103**

CALIBRATION CERTIFICATE

Object: EX3DV4 - SN : 7401

Calibration Procedure(s): FF-Z11-004-01
 Calibration Procedures for Dosimetric E-field Probes

Calibration date: April 01, 2020

This calibration Certificate documents the traceability to national standards, which realize the physical units of measurements(SI). The measurements and the uncertainties with confidence probability are given on the following pages and are part of the certificate.

All calibrations have been conducted in the closed laboratory facility: environment temperature(22±3)°C and humidity<70%.

Calibration Equipment used (M&TE critical for calibration)

Primary Standards	ID #	Cal Date(Calibrated by, Certificate No.)	Scheduled Calibration
Power Meter NRP2	101919	18-Jun-19(CTTL, No.J19X05125)	Jun-20
Power sensor NRP-Z91	101547	18-Jun-19(CTTL, No.J19X05125)	Jun-20
Power sensor NRP-Z91	101548	18-Jun-19(CTTL, No.J19X05125)	Jun-20
Reference 10dBAttenuator	18N50W-10dB	10-Feb-20(CTTL, No.J20X00525)	Feb-22
Reference 20dBAttenuator	18N50W-20dB	10-Feb-20(CTTL, No.J20X00526)	Feb-22
Reference Probe EX3DV4	SN 7307	24-May-19(SPEAG, No.EX3-7307_May19/2)	May-20
DAE4	SN 1525	26-Aug-19(SPEAG, No.DAE4-1525_Aug19)	Aug-20
Secondary Standards	ID #	Cal Date(Calibrated by, Certificate No.)	Scheduled Calibration
SignalGenerator MG3700A	6201052605	18-Jun-19(CTTL, No.J19X05127)	Jun-20
Network Analyzer E5071C	MY46110673	10-Feb-20(CTTL, No.J20X00515)	Feb-21

	Name	Function	Signature
Calibrated by:	Yu Zongying	SAR Test Engineer	
Reviewed by:	Lin Hao	SAR Test Engineer	
Approved by:	Qi Dianyuan	SAR Project Leader	

Issued: April 03, 2020

This calibration certificate shall not be reproduced except in full without written approval of the laboratory.



In Collaboration with
s p e a g
 CALIBRATION LABORATORY

Add: No.51 Xueyuan Road, Haidian District, Beijing, 100191, China
 Tel: +86-10-62304633-2512 Fax: +86-10-62304633-2504
 E-mail: cttl@chinattl.com [Http://www.chinattl.cn](http://www.chinattl.cn)

Glossary:

TSL	tissue simulating liquid
NORM _{x,y,z}	sensitivity in free space
ConvF	sensitivity in TSL / NORM _{x,y,z}
DCP	diode compression point
CF	crest factor (1/duty_cycle) of the RF signal
A,B,C,D	modulation dependent linearization parameters
Polarization Φ	Φ rotation around probe axis
Polarization θ	θ rotation around an axis that is in the plane normal to probe axis (at measurement center), i $\theta=0$ is normal to probe axis
Connector Angle	information used in DASY system to align probe sensor X to the robot coordinate system

Calibration is Performed According to the Following Standards:

- a) IEEE Std 1528-2013, "IEEE Recommended Practice for Determining the Peak Spatial-Averaged Specific Absorption Rate (SAR) in the Human Head from Wireless Communications Devices: Measurement Techniques", June 2013
- b) IEC 62209-1, "Measurement procedure for the assessment of Specific Absorption Rate (SAR) from hand-held and body-mounted devices used next to the ear (frequency range of 300 MHz to 6 GHz)", July 2016
- c) IEC 62209-2, "Procedure to determine the Specific Absorption Rate (SAR) for wireless communication devices used in close proximity to the human body (frequency range of 30 MHz to 6 GHz)", March 2010
- d) KDB 865664, "SAR Measurement Requirements for 100 MHz to 6 GHz"

Methods Applied and Interpretation of Parameters:

- **NORM_{x,y,z}**: Assessed for E-field polarization $\theta=0$ ($f \leq 900$ MHz in TEM-cell; $f > 1800$ MHz: waveguide). NORM_{x,y,z} are only intermediate values, i.e., the uncertainties of NORM_{x,y,z} does not effect the E^2 -field uncertainty inside TSL (see below ConvF).
- **NORM(f)_{x,y,z} = NORM_{x,y,z} * frequency_response** (see Frequency Response Chart). This linearization is implemented in DASY4 software versions later than 4.2. The uncertainty of the frequency response is included in the stated uncertainty of ConvF.
- **DCP_{x,y,z}**: DCP are numerical linearization parameters assessed based on the data of power sweep (no uncertainty required). DCP does not depend on frequency nor media.
- **PAR**: PAR is the Peak to Average Ratio that is not calibrated but determined based on the signal characteristics.
- **A_{x,y,z}; B_{x,y,z}; C_{x,y,z}; VR_{x,y,z}; A,B,C** are numerical linearization parameters assessed based on the data of power sweep for specific modulation signal. The parameters do not depend on frequency nor media. VR is the maximum calibration range expressed in RMS voltage across the diode.
- **ConvF and Boundary Effect Parameters**: Assessed in flat phantom using E-field (or Temperature Transfer Standard for $f \leq 800$ MHz) and inside waveguide using analytical field distributions based on power measurements for $f > 800$ MHz. The same setups are used for assessment of the parameters applied for boundary compensation (alpha, depth) of which typical uncertainty valued are given. These parameters are used in DASY4 software to improve probe accuracy close to the boundary. The sensitivity in TSL corresponds to NORM_{x,y,z} * ConvF whereby the uncertainty corresponds to that given for ConvF. A frequency dependent ConvF is used in DASY version 4.4 and higher which allows extending the validity from ± 50 MHz to ± 100 MHz.
- **Spherical isotropy (3D deviation from isotropy)**: in a field of low gradients realized using a flat phantom exposed by a patch antenna.
- **Sensor Offset**: The sensor offset corresponds to the offset of virtual measurement center from the probe tip (on probe axis). No tolerance required.
- **Connector Angle**: The angle is assessed using the information gained by determining the NORM_x (no uncertainty required).



In Collaboration with
s p e a g
 CALIBRATION LABORATORY

Add: No.51 Xueyuan Road, Haidian District, Beijing, 100191, China
 Tel: +86-10-62304633-2512 Fax: +86-10-62304633-2504
 E-mail: cttl@chinattl.com [Http://www.chinattl.cn](http://www.chinattl.cn)

DASY/EASY – Parameters of Probe: EX3DV4 – SN:7401

Basic Calibration Parameters

	Sensor X	Sensor Y	Sensor Z	Unc (k=2)
Norm($\mu\text{V}/(\text{V}/\text{m})^2$) ^A	0.37	0.45	0.34	±10.0%
DCP(mV) ^B	102.4	100.8	102.6	

Modulation Calibration Parameters

UID	Communication System Name		A dB	B dB· μV	C	D dB	VR mV	Unc ^E (k=2)
0	CW	X	0.0	0.0	1.0	0.00	137.2	±2.3%
		Y	0.0	0.0	1.0		155.7	
		Z	0.0	0.0	1.0		128.3	

The reported uncertainty of measurement is stated as the standard uncertainty of Measurement multiplied by the coverage factor k=2, which for a normal distribution Corresponds to a coverage probability of approximately 95%.

^A The uncertainties of Norm X, Y, Z do not affect the E²-field uncertainty inside TSL (see Page 4 and Page 5).

^B Numerical linearization parameter: uncertainty not required.

^E Uncertainty is determined using the max. deviation from linear response applying rectangular distribution and is expressed for the square of the field value.



In Collaboration with
s p e a g
 CALIBRATION LABORATORY

Add: No.51 Xueyuan Road, Haidian District, Beijing, 100191, China
 Tel: +86-10-62304633-2512 Fax: +86-10-62304633-2504
 E-mail: cttl@chinattl.com [Http://www.chinattl.cn](http://www.chinattl.cn)

DASY/EASY – Parameters of Probe: EX3DV4 – SN:7401

Calibration Parameter Determined in Head Tissue Simulating Media

f [MHz] ^C	Relative Permittivity ^F	Conductivity (S/m) ^F	ConvF X	ConvF Y	ConvF Z	Alpha ^E	Depth ^G (mm)	Unct. (k=2)
750	41.9	0.89	10.51	10.51	10.51	0.40	0.75	±12.1%
835	41.5	0.90	10.22	10.22	10.22	0.15	1.31	±12.1%
900	41.5	0.97	10.24	10.24	10.24	0.16	1.32	±12.1%
1750	40.1	1.37	8.65	8.65	8.65	0.22	1.13	±12.1%
1900	40.0	1.40	8.37	8.37	8.37	0.20	1.19	±12.1%
2000	40.0	1.40	8.35	8.35	8.35	0.22	1.18	±12.1%
2300	39.5	1.67	8.17	8.17	8.17	0.47	0.80	±12.1%
2450	39.2	1.80	7.85	7.85	7.85	0.50	0.77	±12.1%
2600	39.0	1.96	7.60	7.60	7.60	0.55	0.76	±12.1%
5250	35.9	4.71	5.74	5.74	5.74	0.45	1.25	±13.3%
5600	35.5	5.07	5.21	5.21	5.21	0.45	1.30	±13.3%
5750	35.4	5.22	5.22	5.22	5.22	0.45	1.40	±13.3%

^C Frequency validity above 300 MHz of ±100MHz only applies for DASY v4.4 and higher (Page 2), else it is restricted to ±50MHz. The uncertainty is the RSS of ConvF uncertainty at calibration frequency and the uncertainty for the indicated frequency band. Frequency validity below 300 MHz is ± 10, 25, 40, 50 and 70 MHz for ConvF assessments at 30, 64, 128, 150 and 220 MHz respectively. Above 5 GHz frequency validity can be extended to ± 110 MHz.

^F At frequency below 3 GHz, the validity of tissue parameters (ϵ and σ) can be relaxed to ±10% if liquid compensation formula is applied to measured SAR values. At frequencies above 3 GHz, the validity of tissue parameters (ϵ and σ) is restricted to ±5%. The uncertainty is the RSS of the ConvF uncertainty for indicated target tissue parameters.

^G Alpha/Depth are determined during calibration. SPEAG warrants that the remaining deviation due to the boundary effect after compensation is always less than ± 1% for frequencies below 3 GHz and below ± 2% for the frequencies between 3-6 GHz at any distance larger than half the probe tip diameter from the boundary.



In Collaboration with
s p e a g
 CALIBRATION LABORATORY

Add: No.51 Xueyuan Road, Haidian District, Beijing, 100191, China
 Tel: +86-10-62304633-2512 Fax: +86-10-62304633-2504
 E-mail: cttl@chinattl.com [Http://www.chinattl.cn](http://www.chinattl.cn)

DASY/EASY – Parameters of Probe: EX3DV4 – SN:7401

Calibration Parameter Determined in Body Tissue Simulating Media

f [MHz] ^C	Relative Permittivity ^F	Conductivity (S/m) ^F	ConvF X	ConvF Y	ConvF Z	Alpha ^G	Depth ^G (mm)	Unct. (k=2)
750	55.5	0.96	10.67	10.67	10.67	0.40	0.80	±12.1%
835	55.2	0.97	10.26	10.26	10.26	0.18	1.35	±12.1%
900	55.0	1.05	10.29	10.29	10.29	0.30	1.05	±12.1%
1750	53.4	1.49	8.36	8.36	8.36	0.19	1.28	±12.1%
1900	53.3	1.52	8.11	8.11	8.11	0.24	1.12	±12.1%
2000	53.3	1.52	8.03	8.03	8.03	0.21	1.28	±12.1%
2300	52.9	1.81	8.04	8.04	8.04	0.49	0.86	±12.1%
2450	52.7	1.95	7.95	7.95	7.95	0.58	0.79	±12.1%
2600	52.5	2.16	7.67	7.67	7.67	0.68	0.70	±12.1%
5250	48.9	5.36	5.23	5.23	5.23	0.45	1.85	±13.3%
5600	48.5	5.77	4.61	4.61	4.61	0.50	1.80	±13.3%
5750	48.3	5.94	4.70	4.70	4.70	0.55	1.45	±13.3%

^C Frequency validity above 300 MHz of ±100MHz only applies for DASY v4.4 and higher (Page 2), else it is restricted to ±50MHz. The uncertainty is the RSS of ConvF uncertainty at calibration frequency and the uncertainty for the indicated frequency band. Frequency validity below 300 MHz is ± 10, 25, 40, 50 and 70 MHz for ConvF assessments at 30, 64, 128, 150 and 220 MHz respectively. Above 5 GHz frequency validity can be extended to ± 110 MHz.

^F At frequency below 3 GHz, the validity of tissue parameters (ϵ and σ) can be relaxed to ±10% if liquid compensation formula is applied to measured SAR values. At frequencies above 3 GHz, the validity of tissue parameters (ϵ and σ) is restricted to ±5%. The uncertainty is the RSS of the ConvF uncertainty for indicated target tissue parameters.

^G Alpha/Depth are determined during calibration. SPEAG warrants that the remaining deviation due to the boundary effect after compensation is always less than ± 1% for frequencies below 3 GHz and below ± 2% for the frequencies between 3-6 GHz at any distance larger than half the probe tip diameter from the boundary.



In Collaboration with
s p e a g
CALIBRATION LABORATORY

Add: No.51 Xueyuan Road, Haidian District, Beijing, 100191, China
Tel: +86-10-62304633-2512 Fax: +86-10-62304633-2504
E-mail: cttl@chinattl.com [Http://www.chinattl.cn](http://www.chinattl.cn)

Frequency Response of E-Field (TEM-Cell: ifi110 EXX, Waveguide: R22)

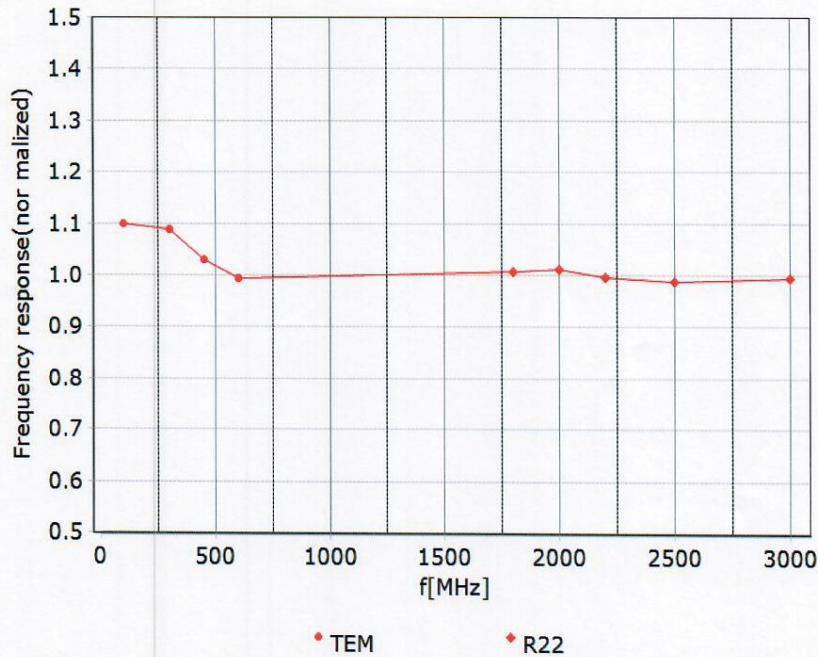

Uncertainty of Frequency Response of E-field: $\pm 7.4\%$ (k=2)

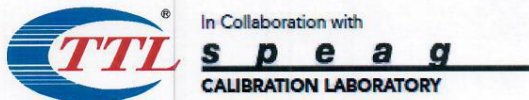

In Collaboration with
TTL speag
CALIBRATION LABORATORY
 Add: No.51 Xueyuan Road, Haidian District, Beijing, 100191, China
 Tel: +86-10-62304633-2512 Fax: +86-10-62304633-2504
 E-mail: cttl@chinattl.com [Http://www.chinattl.cn](http://www.chinattl.cn)

Receiving Pattern (Φ), $\theta=0^\circ$

f=600 MHz, TEM

f=1800 MHz, R22

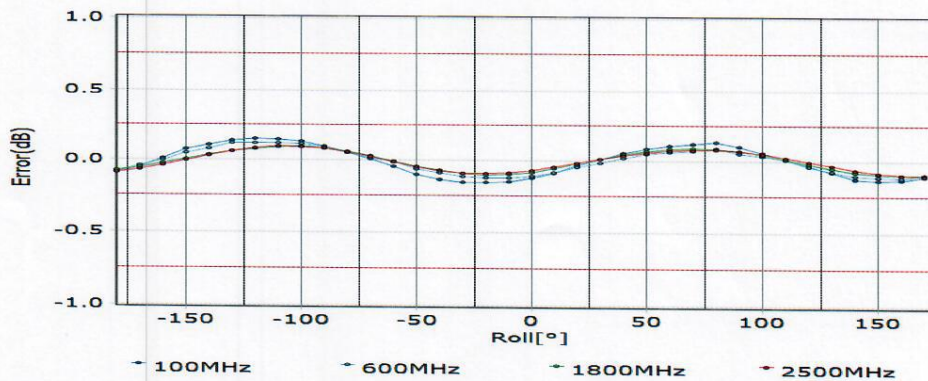
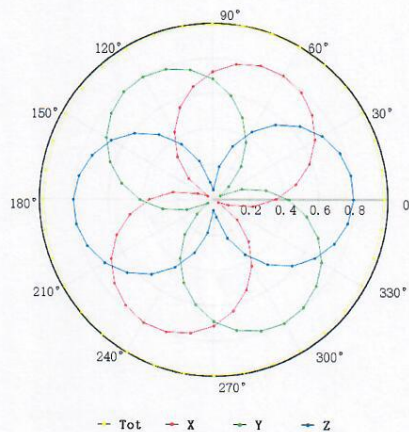
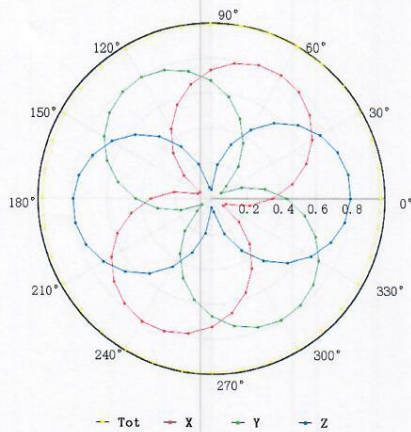

Uncertainty of Axial Isotropy Assessment: $\pm 1.2\%$ ($k=2$)



In Collaboration with
s p e a g
CALIBRATION LABORATORY

Add: No.51 Xueyuan Road, Haidian District, Beijing, 100191, China
Tel: +86-10-62304633-2512 Fax: +86-10-62304633-2504
E-mail: cttl@chinattl.com [Http://www.chinattl.cn](http://www.chinattl.cn)

Dynamic Range f(SAR_{head}) (TEM cell, f = 900 MHz)

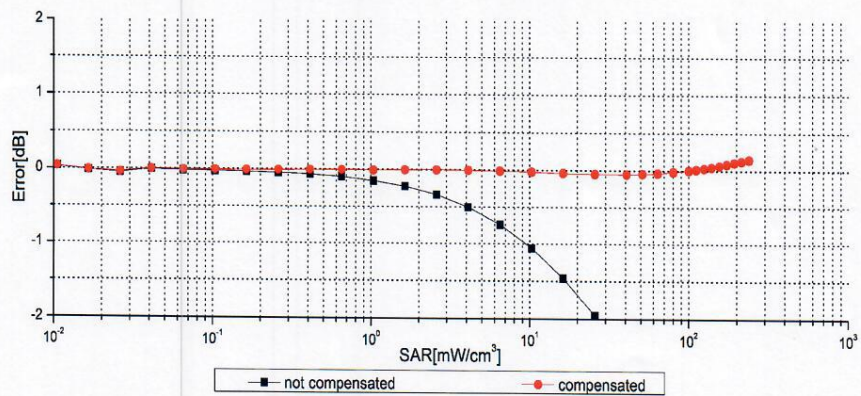
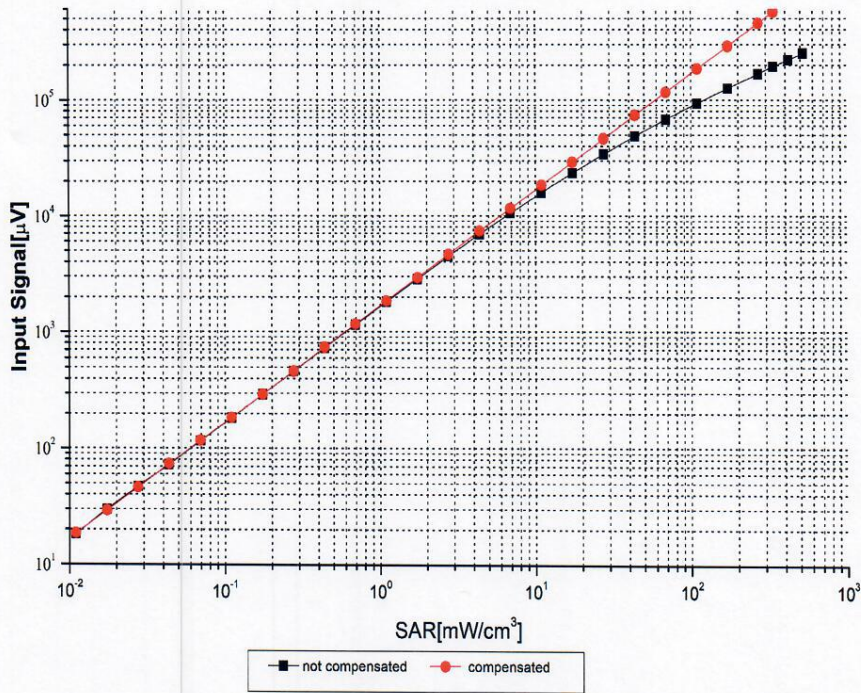

Uncertainty of Linearity Assessment: ±0.9% (k=2)

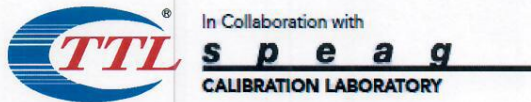

Add: No.51 Xueyuan Road, Haidian District, Beijing, 100191, China
 Tel: +86-10-62304633-2512 Fax: +86-10-62304633-2504
 E-mail: cttl@chinattl.com [Http://www.chinattl.cn](http://www.chinattl.cn)

Conversion Factor Assessment

f=750 MHz,WGLS R9(H_convF)

f=1750 MHz,WGLS R22(H_convF)

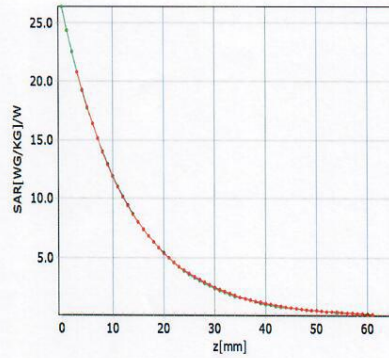
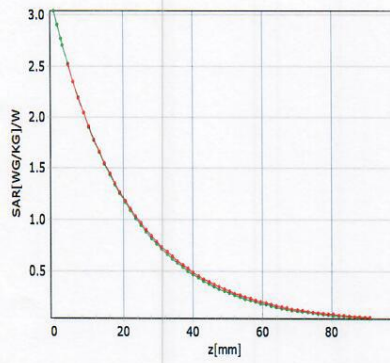

* analytical * measured

* analytical * measured

Deviation from Isotropy in Liquid

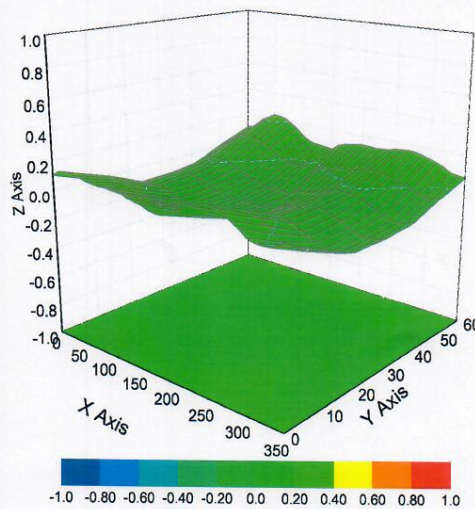

Uncertainty of Spherical Isotropy Assessment: $\pm 3.2\%$ (K=2)



In Collaboration with
s p e a g
CALIBRATION LABORATORY

Add: No.51 Xueyuan Road, Haidian District, Beijing, 100191, China
Tel: +86-10-62304633-2512 Fax: +86-10-62304633-2504
E-mail: ctl@chinattl.com [Http://www.chinattl.cn](http://www.chinattl.cn)

DASY/EASY – Parameters of Probe: EX3DV4 – SN:7401

Other Probe Parameters

Sensor Arrangement	Triangular
Connector Angle (°)	151.2
Mechanical Surface Detection Mode	enabled
Optical Surface Detection Mode	disable
Probe Overall Length	337mm
Probe Body Diameter	10mm
Tip Length	10mm
Tip Diameter	2.5mm
Probe Tip to Sensor X Calibration Point	1mm
Probe Tip to Sensor Y Calibration Point	1mm
Probe Tip to Sensor Z Calibration Point	1mm
Recommended Measurement Distance from Surface	1.4mm

ANNEX D. Accreditation Certification

The image shows an accreditation certificate from A2LA. At the top, there are logos for ILAC-MRA and A2LA. The text reads: "Accredited Laboratory", "A2LA has accredited", "EAST CHINA INSTITUTE OF TELECOMMUNICATIONS", "Shanghai, People's Republic of China", "for technical competence in the field of", "Electrical Testing". Below this, it states: "This laboratory is accredited in accordance with the recognized International Standard ISO/IEC 17025:2017 General requirements for the competence of testing and calibration laboratories. This accreditation demonstrates technical competence for a defined scope and the operation of a laboratory quality management system [refer to joint ISO-ILAC-IAF Communiqué dated April 2017].". There is a yellow seal on the left with "A2LA" and "SEAL 1979" and a signature on the right. The signature is for the Vice President of Accreditation Services. The certificate number is 3682.01 and it is valid to February 28, 2021. At the bottom, it says: "For the tests to which this accreditation applies, please refer to the laboratory's Electrical Scope of Accreditation."

*****End of the Report*****