

*Levana*<sup>®</sup>

Mila Video Baby Monitor

# Quick Start Guide





## We Want to Hear From You

Help your fellow parents decide which monitor is best for their families.  
Please leave an honest review wherever you purchased your Mila!



[mylevana.com](https://mylevana.com)



[/mylevana](https://www.facebook.com/mylevana)



[@mylevana](https://www.instagram.com/mylevana)

# Worry Less, Do More.

Learn about all of your Mila Baby Monitor's features and tips  
by viewing our support videos.



**Open camera & scan this QR code**  
to access all Mila support videos or  
visit: **[bit.ly/MilaSupport](https://bit.ly/MilaSupport)**

# Getting to Know Mila

## Monitor Buttons and Functions

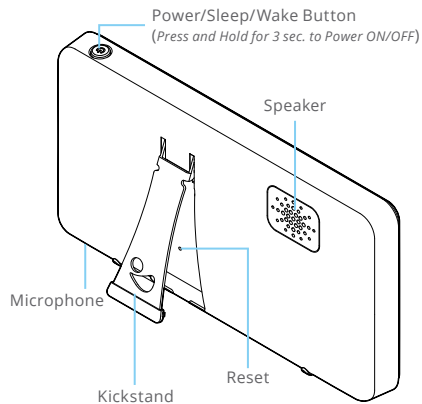
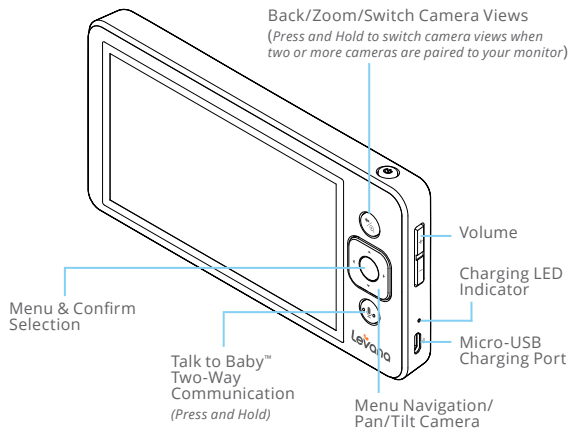

## Camera Buttons & Functions

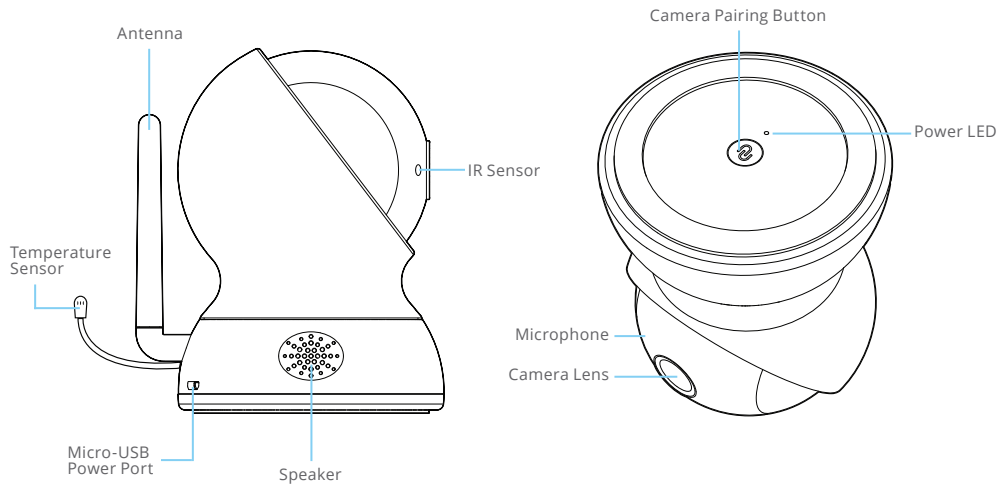

## Notification Bar

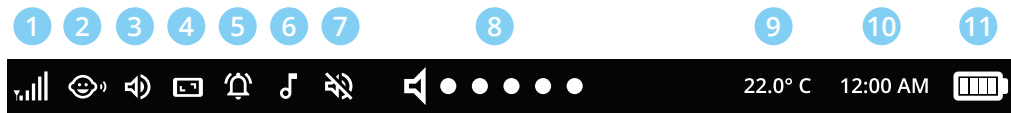

- |   |                                  |    |                                    |
|---|----------------------------------|----|------------------------------------|
| 1 | Signal Strength                  | 7  | Monitor Audio Muted                |
| 2 | Voice Activated Power Save Mode  | 8  | Sound Indicator (at active camera) |
| 3 | Monitor Mode: Audio Only         | 9  | Temperature (at active camera)     |
| 4 | Monitor Mode: Always On          | 10 | Time                               |
| 5 | Temperature Alert (if activated) | 11 | Battery Level                      |
| 6 | Lullaby Playing                  |    |                                    |



**TIP:** This icon represents the Lullaby duration you have set. The dots located beside the camera icon indicate which paired camera you are viewing.

# Setting Up Your Mila Baby Monitor

Charge the Monitor for 7 hours and Plug in the Camera

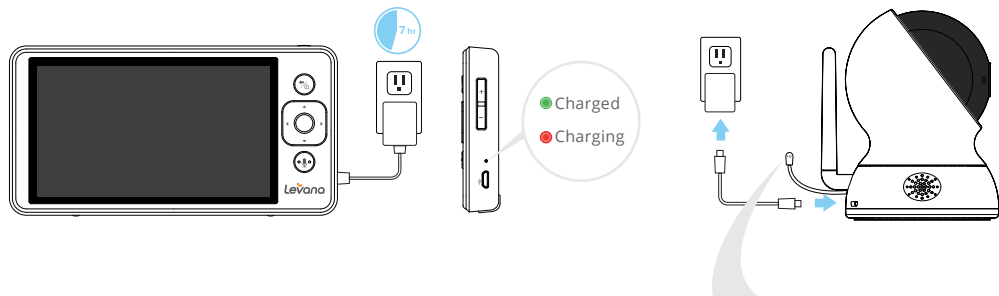

**IMPORTANT:** We recommend placing your camera(s) no more than 5ft. away from your baby, as audio may not be detected if placed further. For a safe setup, never mount cameras directly above the crib or baby. Power cords must be kept at least 3ft. away from the crib and baby's reach at all times.

**TIP:** Ensure the camera's temperature sensor is unobstructed. When the camera is placed near a window or air vent, the accuracy of the temperature rating may be affected.



# Using Your Mila Baby Monitor

## Viewing Modes

Navigate to the Menu and select Viewing Modes. Please note that Multi-Camera Views require two or more paired cameras.

**TIP:** Press and hold the  button to switch cameras when there are two or more cameras paired to your monitor.



### Full Screen View

This mode allows you to see one camera in full-screen view.



### Multi-Camera Views

Split and Quad Screen allows you to see up to four cameras at once.

**IMPORTANT:** *The camera with an orange border is the Active camera. This means the audio, pan & tilt functions, and Talk to Baby™ are active for this camera only.*



### Sequence Mode

When there are two or more paired cameras, your monitor can cycle through each camera on full screen every 5 seconds.

## Monitor Modes

Navigate to the Menu and select Monitor Mode. Each option will change how your audio and cameras are displayed on the monitor.

### Always On

This mode keeps your display and audio ON, unless you press the Sleep/Wake button.

**TIP:** When you press the orange Sleep/Wake button, Mila will not display any video or play any audio.

### Audio Only

This mode turns OFF your display and keeps audio playback from your cameras ON. If you have multiple cameras paired, you'll only hear audio for the Active camera. In Sequence Mode, audio will cycle through all paired cameras every 5 seconds.

### Voice Activated

This mode puts your video display to sleep and wakes your monitor for 20 seconds when noise is detected at the camera. If two or more cameras are paired, your monitor will wake up to the specific camera that detects noise.

The sensitivity of the camera can be adjusted. **Low:** If you only want to hear loud screaming or crying, **Medium:** If you want to hear babbling and talking, or **High:** If you want to hear everything from low whispers to crying.

## Lullabies

Navigate to the Menu, select Lullabies, and select the camera you want to play Lullabies or White Noise from. Each camera can play a different lullaby.



### Lullaby

Choose between three classic lullabies, soothing nature sounds or white noise.

### Duration

Select ON to play a lullaby continuously or choose a preset duration. Duration does not need to be turned ON for Sound Activation to be active.

### Sound Activation

When turned ON, your selected lullaby will play for five minutes when Mila detects noise from your baby.

### Camera Volume

Adjust the volume output from the selected camera. This will apply to the Lullabies and Talk-to-Baby™ volume.

**TIP:** While using Lullabies in the Voice Activated Monitor Mode, the microphone is muted and will not activate for noise in the room. **We recommend using Always On or Audio Only while playing Lullabies from the camera.**

## Pairing Additional Cameras

Your initial Mila Baby Monitor will come to you with the camera(s) paired. Follow these steps if adding additional cameras.



Press the **Menu Button** to access the Device Menu.

Select **Settings**.

Select **Camera Pairing**.



Select a **camera square** with a **(+) icon** to pair a new camera.

Press and hold the **Pair Button** on the bottom of the camera until a beep is heard.

Pairing successful!

**TIP:** Camera must be plugged-in to pair with Mila's monitor.

# Frequently Asked Questions

## How can I change which camera I am viewing?

Press and hold the  button to switch your Active camera. When doing this in Split or Quad Screen View, the Active camera will have an orange border.

**TIP:** Audio playback, Talk to Baby™, and pan & tilt functions will only affect the Active camera.

## Why can't I hear audio from one of my cameras while in Split Screen Monitor Mode?

While in Split or Quad Screen and Always On Monitor Mode, Mila will only play audio from the Active camera.

**Note:** The Active camera will have an orange border. If you need to detect audio from all cameras, we recommend using Sequence Mode. This will cycle through each camera in Full-Screen every 5 seconds.

## Why is the temperature on my monitor different from the thermostat in my home?

Mila's thermostat is located on the camera (See Camera Buttons & Functions page). If your camera is placed near a window or air vent, the accuracy of the temperature rating may be affected. When moving the camera, it may take some time for Mila's thermostat to adjust to the temperature of the new location.

## **Why can't I hear my baby through the monitor when they're making noise?**

Sometimes Mila's camera is too far away from your baby to detect the sounds being made. We recommend placing your camera within 3-5ft. from your little one for the best audio performance. While using Lullabies in Voice Activation Monitor Mode, the microphone on that camera is muted. This means you will not be notified if additional noise is detected. If playing Lullabies/White Noise from Mila's camera, we recommend using Always On or Audio Only.

## **How can I make my Mila battery last longer?**

The less time your screen is turned on, the more battery life you will be able to preserve. We recommend using Voice Activation when possible so that you're only being notified when your little one makes a sound. There are options for setting the sensitivity of your Voice Activation. Using the Low Sensitivity will reduce the number of times Mila wakes up, only notifying you when noises such as crying or screaming are detected. Mila also features an Audio Only mode if you wish to have constant audio, but do not need to see your little one.

## **My video stream has gone black. How can I fix it?**

Though rare, it is possible that other wireless devices in your home may interfere with Mila. If this happens, just press and hold the Menu button for 10 seconds and your video should resume.

# Need More Help?

Our mission is to bring you the peace of mind you deserve during your parenting journey. If your experience with your monitor is anything short of amazing, we're here to fix that!



Open camera & scan this QR code to access all of our Mila support articles & tips or visit: [mylevana.com/support](https://mylevana.com/support)



This device complies with Part 15 of the FCC Rules. Operation is subject to the following two conditions: (1) this device may not cause harmful interference, and (2) this device must accept any interference received, including interference that may cause undesired operation.

changes or modifications not expressly approved by the party responsible for compliance could void the user's authority to operate the equipment.

This equipment has been tested and found to comply with the limits for a Class B digital device, pursuant to Part 15 of the FCC Rules. These limits are designed to provide reasonable protection against harmful interference in a residential installation. This equipment generates, uses and can radiate radio frequency energy and, if not installed and used in accordance with the instructions, may cause harmful interference to radio communications. However, there is no guarantee that interference will not occur in a particular installation.

If this equipment does cause harmful interference to radio or television reception, which can be determined by turning the equipment off and on, the user is encouraged to try to correct the interference by one or more of the following measures:

- Reorient or relocate the receiving antenna.
- Increase the separation between the equipment and receiver.
- Connect the equipment into an outlet on a circuit different from that to which the receiver is connected.
- Consult the dealer or an experienced radio/TV technician for help.

#### **ISED compliance statement**

This device contains licence-exempt transmitter(s)/receiver(s) that comply with Innovation, Science and Economic Development Canada's licence-exempt RSS(s). Operation is subject to the following two conditions:

(1) This device may not cause interference.

(2) This device must accept any interference, including interference that may cause undesired operation of the device.

L'émetteur/récepteur exempt de licence contenu dans le présent appareil est conforme aux CNR d'Innovation, Sciences et Développement économique Canada applicables aux appareils radio exempts de licence. L'exploitation est autorisée aux deux conditions suivantes :

(1) L'appareil ne doit pas produire de brouillage;

(2) L'appareil doit accepter tout brouillage radioélectrique subi, même si le brouillage est susceptible d'en compromettre le fonctionnement.

#### **FCC Radiation Exposure statement**

This equipment complies with FCC radiation exposure limits set forth for an uncontrolled environment. This equipment should be installed and operated with minimum distance 20 cm between the radiator and your body.



### **FCC SAR statement - Monitor**

This equipment complies with FCC radiation exposure limits set forth for an uncontrolled environment. End user must follow the specific operating instructions for satisfying RF exposure compliance. This transmitter must not be co-located or operating in conjunction with any other antenna or transmitter.

The portable device is designed to meet the requirements for exposure to radio waves established by the Federal Communications Commission (USA). These requirements set a SAR limit of 1.6 W/kg averaged over one gram of tissue. The highest SAR value reported under this standard during product certification for use when properly worn on the Limb.

### **ISED Radiation Exposure statement**

This equipment complies with IC RSS-102 radiation exposure limits set forth for an uncontrolled environment. This equipment should be installed and operated with minimum distance 20 cm between the radiator and your body.

Cet équipement est conforme aux limites d'exposition aux radiations IC CNR-102 établies pour un environnement non contrôlé. Cet équipement doit être installé et utilisé avec une distance minimale de 20 cm entre le radiateur et votre corps.

### **IC SAR statement - Monitor**

This equipment complies with ISED radiation exposure limits set forth for an uncontrolled environment. End user must follow the specific operating instructions for satisfying RF exposure compliance. This transmitter must not be co-located or operating in conjunction with any other antenna or transmitter.

The portable device is designed to meet the requirements for exposure to radio waves established by the ISED. These requirements set a SAR limit of 1.6 W/kg averaged over one gram of tissue. The highest SAR value reported under this standard during product certification for use when properly worn on the Limb.

Cet équipement est conforme aux limites d'exposition aux rayonnements ISED établies pour un environnement non contrôlé. L'utilisateur final doit suivre les instructions spécifiques pour satisfaire les normes. Cet émetteur ne doit pas être co-implanté ou fonctionner en conjonction avec toute autre antenne ou transmetteur.

Le dispositif portatif est conçu pour répondre aux exigences d'exposition aux ondes radio établie par le développement énergétique DURABLE. Ces exigences un SAR limite de 1,6 W/kg en moyenne pour un gramme de tissu. Lors de la certification du produit, la valeur SAR la plus élevée rapportée conformément à la présente norme doit être utilisée lorsqu'elle est correctement portée sur les membres.



## WARNING

**STRANGULATION HAZARD:** Children have STRANGLED in cords. Keep this cord out of reach of children (more than 3ft. (0.9 m) away).





[mylevana.com](https://mylevana.com)



REV110007282021