



Test Report No.: W7L-P23060014RF03



VARIANT FCC TEST REPORT

(Part 15, Subpart E)



Applicant:	Shenzhen Zolon Technology Co., Ltd.
Address:	401, Building 3, Shenzhen Software Park, Maling Community, Yuehai Street, Nanshan District, Shenzhen City, Guangdong Province, P.R.C

Manufacturer or Supplier:	Shenzhen Zolon Technology Co., Ltd.
Address:	401, Building 3, Shenzhen Software Park, Maling Community, Yuehai Street, Nanshan District, Shenzhen City, Guangdong Province, P.R.C
Product:	Data Service Terminal
Brand Name:	ZOLON
Model Name:	T3300
FCC ID:	2AV5BT3300
Date of tests:	Oct. 08, 2022 ~ Oct. 26, 2022

The tests have been carried out according to the requirements of the following standard:

FCC Part 15, Subpart E, Section 15.407

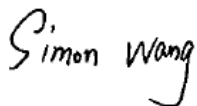
CONCLUSION: The submitted sample was found to COMPLY with the test requirement

Prepared by Simon Wang Engineer / Mobile Department	Approved by Luke Lu Manager / Mobile Department
 Date: Jul. 03, 2023	 Date: Jul. 03, 2023

This report is governed by, and incorporates by reference, the Conditions of Testing as posted at the date of issuance of this report at <http://www.bureauveritas.com/home/about-us/our-business/cps/about-us/terms-conditions/> and is intended for your exclusive use. Any copying or replication of this report to or for any other person or entity, or use of our name or trademark, is permitted only with our prior written permission. This report sets forth our findings solely with respect to the test samples identified herein. The results set forth in this report are not indicative or representative of the quality or characteristics of the lot from which a test sample was taken or any similar or identical product unless specifically and expressly noted. Our report includes all of the tests requested by you and the results thereof based upon the information that you provided to us. Measurement uncertainty is only provided upon request for accredited tests. Statements of conformity are based on simple acceptance criteria without taking measurement uncertainty into account, unless otherwise requested in writing. You have 60 days from date of issuance of this report to notify us of any material error or omission caused by our negligence or if you require measurement uncertainty; provided, however, that such notice shall be in writing and shall specifically address the issue you wish to raise. A failure to raise such issue within the prescribed time shall constitute your unqualified acceptance of the completeness of this report, the tests conducted and the correctness of the report contents.



TABLE OF CONTENTS

RELEASE CONTROL RECORD	4
1 SUMMARY OF TEST RESULTS	5
1.1 MEASUREMENT UNCERTAINTY	6
2 GENERAL INFORMATION.....	7
2.1 GENERAL DESCRIPTION OF EUT	7
2.2 DESCRIPTION OF TEST MODES	9
2.2.1 TEST MODE APPLICABILITY AND TESTED CHANNEL DETAIL.....	11
2.3 DUTY CYCLE OF TEST SIGNAL	15
2.4 DESCRIPTION OF SUPPORT UNITS	15
2.4.1 CONFIGURATION OF SYSTEM UNDER TEST	16
2.5 GENERAL DESCRIPTION OF APPLIED STANDARDS	16
3 TEST TYPES AND RESULTS.....	17
3.1 RADIATED EMISSION AND BANDEDGE MEASUREMENT.....	17
3.1.1 LIMITS OF RADIATED EMISSION AND BANDEDGE MEASUREMENT.....	17
3.1.2 LIMITS OF UNWANTED EMISSION.....	17
3.1.3 TEST INSTRUMENTS.....	18
3.1.4 TEST PROCEDURES	19
3.1.5 DEVIATION FROM TEST STANDARD	19
3.1.6 TEST SETUP	20
3.1.7 EUT OPERATING CONDITION	22
3.1.8 TEST RESULTS	23
3.2 CONDUCTED EMISSION MEASUREMENT	87
3.2.1 LIMITS OF CONDUCTED EMISSION MEASUREMENT	87
3.2.2 TEST INSTRUMENTS.....	87
3.2.3 TEST PROCEDURES	87
3.2.4 DEVIATION FROM TEST STANDARD	88
3.2.5 TEST SETUP	88
3.2.6 EUT OPERATING CONDITIONS	88
3.2.7 TEST RESULTS	89
3.3 MAXIMUM CONDUCTED OUTPUT POWER MEASUREMENT	91
3.3.1 LIMITS OF MAXIMUM CONDUCTED OUTPUT POWER MEASUREMENT	91
3.3.2 TEST SETUP	92
3.3.3 TEST INSTRUMENTS.....	92



3.3.4	TEST PROCEDURE	93
3.3.5	DEVIATION FROM TEST STANDARD	95
3.3.6	EUT OPERATING CONDITIONS	95
3.3.7	TEST RESULTS	96
3.4	MAXIMUM POWER SPECTRAL DENSITY MEASUREMENT.....	97
3.4.1	LIMITS OF MAXIMUM POWER SPECTRAL DENSITY MEASUREMENT	97
3.4.2	TEST SETUP	97
3.4.3	TEST INSTRUMENTS.....	97
3.4.4	TEST PROCEDURES	98
3.4.5	DEVIATION FROM TEST STANDARD	98
3.4.6	EUT OPERATING CONDITIONS	98
3.4.7	TEST RESULTS	99
3.5	AUTOMATICALLY DISCONTINUE TRANSMISSION	100
3.5.1	LIMIT OF AUTOMATICALLY DISCONTINUE TRANSMISSION	100
3.5.2	TEST INSTRUMENTS.....	100
3.5.3	TEST RESULT	100
4	PHOTOGRAPHS OF THE TEST CONFIGURATION	101
5	MODIFICATIONS RECORDERS FOR ENGINEERING CHANGES TO THE EUT BY THE LAB	102
APPENDIX A	103



BUREAU
VERITAS

Test Report No.: W7L-P23060014RF03

RELEASE CONTROL RECORD

ISSUE NO.	REASON FOR CHANGE	DATE ISSUED
W7L-P22090035RF03	Original release	Oct. 26, 2022
W7L-P23060014RF03	Based on the original product changing the FCC ID, applicant and manufacturer information, band name.	Jul. 03, 2023



1 SUMMARY OF TEST RESULTS

The EUT has been tested according to the following specifications:

APPLIED STANDARD: FCC PART 15, SUBPART E		
STANDARD SECTION	TEST TYPE AND LIMIT	RESULT
15.407(b)(6)	AC Power Conducted Emission	Compliance
15.407(b) (1/2/3/4/5)	Radiated Emission & Band Edge Measurement	Compliance
15.407(a/1/2/3)	Maximum conducted output Power	Compliance
15.407(a/1/2/3)	Peak Power Spectral Density	Compliance
15.403(i)	26 dB Bandwidth	Compliance
15.407(e)	6 dB Bandwidth	Compliance
15.203	Antenna Requirement	Compliance

NOTE:

1. Except the data of RSE and Band Edge Measurement, other data of 802.11a & 802.11n/ac (20/40) & 802.11ac 80 please refer to the appendix A
2. Only the worse data were report



1.1 MEASUREMENT UNCERTAINTY

Where relevant, the following measurement uncertainty levels have been estimated for tests performed on the EUT as specified in CISPR 16-4-2:

MEASUREMENT	UNCERTAINTY
AC Power Conducted emissions	±2.70dB
Radiated emissions (9KHz~30MHz)	±2.68dB
Radiated emissions (30MHz~1GHz)	±4.98dB
Radiated emissions (1GHz ~6GHz)	±4.70dB
Radiated emissions (6GHz ~18GHz)	±4.60dB
Radiated emissions (18GHz ~40GHz)	±4.12dB
Conducted emissions	±4.01dB
Occupied Channel Bandwidth	±43.58KHz
Conducted Output power	±2.06dB
Power Spectral Density	±0.85 dB

This uncertainty represents an expanded uncertainty expressed at approximately the 95% confidence level using a coverage factor of $k = 2$.



2 GENERAL INFORMATION

2.1 GENERAL DESCRIPTION OF EUT

PRODUCT	Data Service Terminal
BRAND NAME	ZOLON
MODEL NAME	T3300
NOMINAL VOLTAGE	5.0Vdc(adapter or host equipment) 3.8Vdc (Li-ion, battery)
MODULATION	OFDM
TRANSFER RATE	802.11a: 54.0/ 48.0/ 36.0/ 24.0/ 18.0/ 12.0/ 9.0/ 6.0Mbps 802.11n: up to 150.0Mbps 802.11ac: up to 433.3Mbps
OPERATING FREQUENCY	5180 ~ 5240MHz, 5260 ~ 5320MHz, 5745 ~ 5825MHz
NUMBER OF CHANNEL	5180 ~ 5240MHz: 4 for 802.11a, 802.11n/ac (20MHz) 2 for 802.11n/ac (40MHz) 1 for 802. 802.11ac(80MHz) 5260 ~ 5320MHz: 4 for 802.11a, 802.11n/ac (20MHz) 2 for 802.11n/ac (40MHz) 1 for 802.11ac (80MHz) 5745 ~ 5825MHz: 5 for 802.11a, 802.11n/ac (20MHz) 3 for 802.11n/ac (40MHz) 2 for 802.11ac (80MHz)
AVERAGE POWER	45.81mW for 5180 ~ 5240MHz 41.02mW for 5260 ~ 5320MHz 26.42mW for 5745 ~ 5825MHz
ANTENNA TYPE	Monopole Antenna
ANTENNA GAIN	3.2 dBi for 5180 ~ 5240MHz 3.2 dBi for 5260 ~ 5320MHz 3.2 dBi for 5745 ~ 5825MHz
HW VERSION	T3300
SW VERSION	V0.0.0.1
I/O PORTS	Refer to user's manual
CABLE SUPPLIED	USB cable: unshielded without ferrite, 1.5meter



NOTE:

1. For a more detailed features description, please refer to the manufacturer's specifications or the user's manual.
2. The EUT incorporates a SISO function. Physically, the EUT provides one completed transmitter and one receiver.

MODULATION MODE	TX FUNCTION
802.11a	1TX /1RX
802.11n/802.11ac (20MHz)	1TX /1RX
802.11n/802.11ac (40MHz)	1TX /1RX
802.11ac (80MHz)	1TX /1RX

3. For the test results, the EUT had been tested with all conditions. But only the worst case was shown in test report.

4. List of Accessory:

ACCESSORIES	BRAND	MANUFACTURER	MODEL	SPECIFICATION
Battery	IES	ICON ENERGY SYSTEM (SHEN ZHEN) CO., LTD	IDS128NA	Capacity: 3.8 Vdc, 1400mAh



2.2 DESCRIPTION OF TEST MODES

FOR 5180 ~ 5240MHz

4 channels are provided for 802.11a, 802.11n, 802.11ac (20MHz):

CHANNEL	FREQUENCY	CHANNEL	FREQUENCY
36	5180 MHz	44	5220 MHz
40	5200 MHz	48	5240 MHz

2 channels are provided for 802.11n, 802.11ac (40MHz):

CHANNEL	FREQUENCY	CHANNEL	FREQUENCY
38	5190 MHz	46	5230 MHz

1 channel is provided for 802.11ac (80MHz):

CHANNEL	FREQUENCY	CHANNEL	FREQUENCY
42	5210 MHz		

FOR 5260 ~ 5320MHz

4 channels are provided for 802.11a, 802.11n, 802.11ac (20MHz):

CHANNEL	FREQUENCY	CHANNEL	FREQUENCY
52	5260 MHz	60	5300 MHz
56	5280 MHz	64	5320 MHz

2 channels are provided for 802.11n, 802.11ac (40MHz):

CHANNEL	FREQUENCY	CHANNEL	FREQUENCY
54	5270 MHz	62	5310 MHz

1 channel is provided for 802.11ac (80MHz):

CHANNEL	FREQUENCY	CHANNEL	FREQUENCY
58	5290 MHz		



FOR 5745 ~ 5825MHz

4 channels are provided for 802.11a, 802.11n, 802.11ac (20MHz):

CHANNEL	FREQUENCY	CHANNEL	FREQUENCY
149	5745 MHz	157	5785 MHz
153	5765 MHz	165	5825 MHz

2 channels are provided for 802.11n, 802.11ac (40MHz):

CHANNEL	FREQUENCY	CHANNEL	FREQUENCY
151	5755 MHz	159	5795 MHz

1 channel is provided for 802.11ac (80MHz):

CHANNEL	FREQUENCY	CHANNEL	FREQUENCY
155	5775 MHz		



2.2.1 TEST MODE APPLICABILITY AND TESTED CHANNEL DETAIL

EUT CONFIGURE MODE	APPLICABLE TO				DESCRIPTION
	RE≥1G	RE<1G	PLC	APCM	
A	√	√	√	-	Powered by Adapter with wifi(5G) link
B	-	-	-	√	Powered by Battery with wifi(5G) link
C	-	-	-	-	Powered by USB with wifi(5G) link

Where **RE≥1G**: Radiated Emission above 1GHz **RE<1G**: Radiated Emission below 1GHz
PLC: Power Line Conducted Emission **APCM**: Antenna Port Conducted Measurement

NOTE:
The EUT had been pre-tested on the positioned of each 3 axis. The worst case was found when positioned on **X-plane**.
NOTE: “-” means no effect.

RADIATED EMISSION TEST (BELOW 1GHz):

- Pre-Scan has been conducted to determine the worst-case mode from all possible combinations between available modulations, data rates and antenna ports (if EUT with antenna diversity architecture).
- Following channel(s) was (were) selected for the final test as listed below.

EUT CONFIGURE MODE	MODE	FREQ. BAND (MHz)	AVAILABLE CHANNEL	TESTED CHANNEL	MODULATION	DATA RATE (Mbps)
A	802.11a	5745-5825	149 to 165	157	OFDM	6.0



RADIATED EMISSION TEST (ABOVE 1GHz):

- Pre-Scan has been conducted to determine the worst-case mode from all possible combinations between available modulations, data rates and antenna ports (if EUT with antenna diversity architecture).
- Following channel(s) was (were) selected for the final test as listed below.

EUT CONFIGURE MODE	MODE	FREQ. BAND (MHz)	AVAILABLE CHANNEL	TESTED CHANNEL	MODULATION	DATA RATE (Mbps)
A	802.11a	5180-5240	36 to 48	36, 48	OFDM	6.0
A	802.11an/ac (20MHz)		36 to 48	36, 48	OFDM	MCS0
A	802.11an/ac (40MHz)		38 to 46	38, 46	OFDM	MCS0
A	802.11ac (80MHz)		42	42	OFDM	MCS0
A	802.11a	5260-5320	52 to 64	52, 60, 64	OFDM	6.0
A	802.11an/ac (20MHz)		52 to 64	52, 60, 64	OFDM	MCS0
A	802.11an/ac (40MHz)		54 to 62	54, 62	OFDM	MCS0
A	802.11ac (80MHz)		58	58	OFDM	MCS0
A	802.11a	5745-5825	149 to 165	149, 157,165	OFDM	6.0
A	802.11an/ac (20MHz)		149 to 165	149, 157,165	OFDM	MCS0
A	802.11an/ac (40MHz)		151 to 159	151, 159	OFDM	MCS0
A	802.11ac (80MHz)		155	155	OFDM	MCS0

POWER LINE CONDUCTED EMISSION TEST:

- Pre-Scan has been conducted to determine the worst-case mode from all possible combinations between available modulations, data rates and antenna ports (if EUT with antenna diversity architecture).
- Following channel(s) was (were) selected for the final test as listed below.

EUT CONFIGURE MODE	MODE	FREQ. BAND (MHz)	AVAILABLE CHANNEL	TESTED CHANNEL	MODULATION	DATA RATE (Mbps)
A	802.11a	5745-5825	149 to 165	157	OFDM	6.0



BANDEDGE MEASUREMENT:

- Pre-Scan has been conducted to determine the worst-case mode from all possible combinations between available modulations, data rates and antenna ports (if EUT with antenna diversity architecture).
- Following channel(s) was (were) selected for the final test as listed below.

EUT CONFIGURE MODE	MODE	FREQ. BAND (MHz)	AVAILABLE CHANNEL	TESTED CHANNEL	MODULATION	DATA RATE (Mbps)
A	802.11a	5180-5240	36 to 48	36, 48	OFDM	6.0
A	802.11an/ac (20MHz)		36 to 48	36, 48	OFDM	MCS0
A	802.11an/ac (40MHz)		38 to 46	38, 46	OFDM	MCS0
A	802.11ac (80MHz)		42	42	OFDM	MCS0
A	802.11a	5260-5320	52 to 64	52, 60, 64	OFDM	6.0
A	802.11an/ac (20MHz)		52 to 64	52, 60, 64	OFDM	MCS0
A	802.11an/ac (40MHz)		54 to 62	54, 62	OFDM	MCS0
A	802.11ac (80MHz)		58	58	OFDM	MCS0
A	802.11a	5745-5825	149 to 165	149, 157,165	OFDM	6.0
A	802.11an/ac (20MHz)		149 to 165	149, 157,165	OFDM	MCS0
A	802.11an/ac (40MHz)		151 to 159	151, 159	OFDM	MCS0
A	802.11ac (80MHz)		155	155	OFDM	MCS0



ANTENNA PORT CONDUCTED MEASUREMENT:

- This item includes all test value of each mode, but only includes spectrum plot of worst value of each mode.
- Pre-Scan has been conducted to determine the worst-case mode from all possible combinations between available modulations, data rates and antenna ports (if EUT with antenna diversity architecture).
- Following channel(s) was (were) selected for the final test as listed below.

EUT CONFIGURE MODE	MODE	FREQ. BAND (MHz)	AVAILABLE CHANNEL	TESTED CHANNEL	MODULATION	DATA RATE (Mbps)
A	802.11a	5180-5240	36 to 48	36, 48	OFDM	6.0
A	802.11an/ac (20MHz)		36 to 48	36, 48	OFDM	MCS0
A	802.11an/ac (40MHz)		38 to 46	38, 46	OFDM	MCS0
A	802.11ac (80MHz)		42	42	OFDM	MCS0
A	802.11a	5260-5320	52 to 64	52, 60, 64	OFDM	6.0
A	802.11an/ac (20MHz)		52 to 64	52, 60, 64	OFDM	MCS0
A	802.11an/ac (40MHz)		54 to 62	54, 62	OFDM	MCS0
A	802.11ac (80MHz)		58	58	OFDM	MCS0
A	802.11a	5745-5825	149 to 165	149, 157,165	OFDM	6.0
A	802.11an/ac (20MHz)		149 to 165	149, 157,165	OFDM	MCS0
A	802.11an/ac (40MHz)		151 to 159	151, 159	OFDM	MCS0
A	802.11ac (80MHz)		155	155	OFDM	MCS0

TEST CONDITION:

APPLICABLE TO	ENVIRONMENTAL CONDITIONS	INPUT POWER	TESTED BY
RE<1G	23deg. C, 70%RH	DC 5V By Adapter	Star Le
RE≥1G	23deg. C, 70%RH	DC 5V By Adapter	Star Le
PLC	25deg. C, 52%RH	DC 5V By Adapter	James Fu
APCM	25deg. C, 60%RH	DC 3.8V By Battery	James Fu



2.3 DUTY CYCLE OF TEST SIGNAL

Please Refer to Appendix A/B. Of this test report.

WORST-CASE DATA:

Measured Duty Cycle		
Mode		Duty Cycle [%]
		ANT0
5GHZ	11a	97.22
	11n20	80.95
	11n40	71.43
	11ac20	80.95
	11ac40	73.33
	11ac80	66.67

Note:

Duty cycle of test signal is < 98%, duty factor shall be considered.

2.4 DESCRIPTION OF SUPPORT UNITS

The EUT has been tested as an independent unit together with other necessary accessories or support units. The following support units or accessories were used to form a representative test configuration during the tests.

NO.	PRODUCT	BRAND	MODEL NO.	SERIAL NO.	FCC ID
1	Desktop	Lenovo	M73 SFF	PC04GRQV	N/A
2	Desktop	Lenovo	M73 SFF	PC06CS27	N/A
3	Laptop	Lenovo	Thnikpad L440	R90FTFKN	N/A
4	DC source	Kikusui/JP	PMX18-5A	0000001	N/A

NO.	SIGNAL CABLE DESCRIPTION OF THE ABOVE SUPPORT UNITS
1	AC Line: Unshielded, Detachable 1.5m
2	AC Line: Unshielded, Detachable 1.5m
3	AC Line: Unshielded, Detachable 1.5m
4	DC Line: Unshielded, Detachable 1.0m



2.4.1 CONFIGURATION OF SYSTEM UNDER TEST

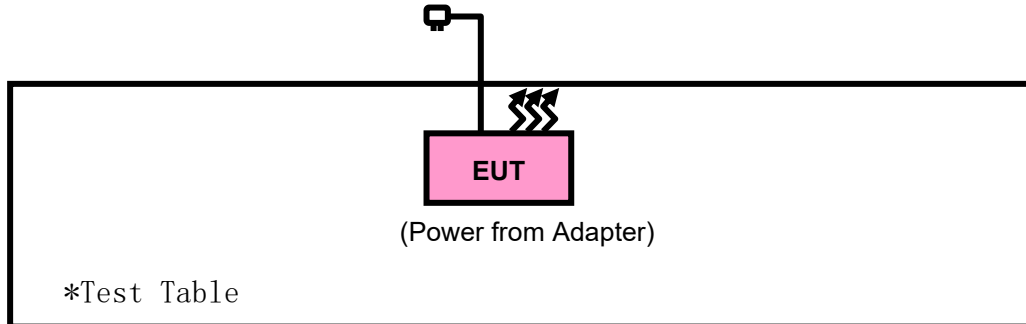

2.5 GENERAL DESCRIPTION OF APPLIED STANDARDS

The EUT is a RF Product. According to the specifications of the manufacturer, it must comply with the requirements of the following standards:

FCC Part 15, Subpart E (15.407)

KDB 789033 D02 General U-NII Test Procedures New Rules v02r01

ANSI C63.10-2013

All test items have been performed and recorded as per the above standards.

NOTE: The EUT is also considered as a kind of computer peripheral, because the connection to computer is necessary for typical use. It has been verified to comply with the requirements of FCC Part 15, Subpart B, Class B (Certification). The test report has been issued separately.



3 TEST TYPES AND RESULTS

3.1 RADIATED EMISSION AND BANDEDGE MEASUREMENT

3.1.1 LIMITS OF RADIATED EMISSION AND BANDEDGE MEASUREMENT

Radiated emissions which fall in the restricted bands must comply with the radiated emission limits specified as below table:

FREQUENCIES (MHz)	FIELD STRENGTH (microvolts/meter)	MEASUREMENT DISTANCE (meters)
0.009 ~ 0.490	2400/F(kHz)	300
0.490 ~ 1.705	24000/F(kHz)	30
1.705 ~ 30.0	30	30
30 ~ 88	100	3
88 ~ 216	150	3
216 ~ 960	200	3
Above 960	500	3

NOTE:

1. The lower limit shall apply at the transition frequencies.
2. Emission level (dBuV/m) = 20 log Emission level (uV/m).
3. For frequencies above 1000MHz, the field strength limits are based on average detector, however, the peak field strength of any emission shall not exceed the maximum permitted average limits, specified above by more than 20dB under any condition of modulation.

3.1.2 LIMITS OF UNWANTED EMISSION

RESTRICTED BANDS	APPLICABLE TO	LIMIT	
	789033 D02 General UNII Test Procedures New Rules v02r01	FIELD STRENGTH AT 3m (dBµV/m)	
		PK : 74	AV : 54
OUT OF THE RESTRICTED BANDS	APPLICABLE TO	EIRP LIMIT (dBm/MHz)	EQUIVALENT FIELD STRENGTH AT 3m (dBµV/m)
	15.407(b)(1)	PK : -27	PK : 68.2
	15.407(b)(2)		
	15.407(b)(3)		
15.407(b)(4)	See note 2 (FCC 16-24)		



NOTE: The following formula is used to convert the equipment isotropic radiated power (eirp) to field strength:

$$E = \frac{1000000 \sqrt{30P}}{3} \mu\text{V/m, where P is the eirp (Watts).}$$

2. All emissions shall be limited to a level of -27 dBm/MHz at 75 MHz or more above or below the band edge increasing linearly to 10 dBm/MHz at 25 MHz above or below the band edge, and from 25 MHz above or below the band edge increasing linearly to a level of 15.6 dBm/MHz at 5 MHz above or below the band edge, and from 5 MHz above or below the band edge increasing linearly to a level of 27 dBm/MHz at the band edge.

3.1.3 TEST INSTRUMENTS

Equipment	Manufacturer	Model No.	Serial No.	Last Cal.	Next Cal.
3m Semi-anechoic Chamber	ETS-LINDGREN	9m*6m*6m	Euroshieldpn-CT0001143-1216	May. 19,20	May. 18,23
Bilog Antenna	ETS-LINDGREN	3143B	00161965	Mar. 06,22	Mar. 05,23
Horn Antenna	ETS-LINDGREN	3117	00168692	Mar. 06,22	Mar. 05,23
Horn Antenna (18GHz-40GHz)	N/A	QWH-SL-18-40-K-SG/QMS-00361	15433	Aug. 24, 22	Aug. 23, 23
Test Software	E3	V 9.160323	N/A	N/A	N/A
Test Software	JS1120-3	3.2.06	N/A	N/A	N/A
10dB Attenuator	JFW/USA	50HF-010-SMA	1505	Jun. 02,22	Jun. 01,23
MXE EMI Receiver	KEYSIGHT	N9038A-544	MY54450026	Feb. 18,22	Feb. 17,23
Signal Pre-Amplifier	EMSI	EMC 9135	980249	May.12,22	May.11,23
Signal Pre-Amplifier	EMSI	EMC 012645B	980257	May.12,22	May.11,23
Signal Pre-Amplifier	EMSI	EMC 184045B	980259	Feb. 21,22	Feb.20,23
DC Source	Kikusui/JP	PMX18-5A	0000001	Aug. 24, 22	Aug. 23, 23
Power Meter	Anritsu	ML2495A	1506002	Feb. 22,22	Feb. 21,23
Power Sensor	Anritsu	MA2411B	1339352	May. 06,22	May. 05,23
Loop Antenna	Schwarzbeck	FMZB 1519B	00173	Sep.04,22	Sep. 03,23

NOTE: 1. The calibration interval of the above test instruments is 12 months or 36 months and the calibrations are traceable to CEPREI/CHINA, GRGT/CHINA and NIM/CHINA.

2. The test was performed in 3m Chamber.

3. The FCC Site Registration No. is 525120; The Designation No. is CN1171.



3.1.4 TEST PROCEDURES

- a. The EUT was placed on the top of a rotating table 0.8 meters (for below 1GHz) / 1.5 meters (for above 1GHz) above the ground at 3 meter chamber room for test. The table was rotated 360 degrees to determine the position of the highest radiation.
- b. The EUT was set 3 meters away from the interference-receiving antenna, which was mounted on the top of a variable-height antenna tower.
- c. The antenna is a broadband antenna, and its height is varied from one meter to four meters above the ground to determine the maximum value of the field strength. Both horizontal and vertical polarizations of the antenna are set to make the measurement.
- d. For each suspected emission, the EUT was arranged to its worst case and then the antenna was tuned to heights from 1 meter to 4 meters and the rotatable table was turned from 0 degrees to 360 degrees to find the maximum reading.
- e. The test-receiver system was set to Peak Detect Function and Specified Bandwidth with Maximum Hold Mode.
- f. If the emission level of the EUT in peak mode was 10dB lower than the limit specified, then testing could be stopped and the peak values of the EUT would be reported. Otherwise the emissions that did not have 10dB margin would be re-tested one by one using peak, quasi-peak or average method as specified and then reported in a data sheet.

NOTE:

1. The resolution bandwidth and video bandwidth of test receiver/spectrum analyzer is 120kHz for Peak detection (PK) and Quasi-peak detection (QP) at frequency below 1GHz.
2. The resolution bandwidth of test receiver/spectrum analyzer is 1MHz and video bandwidth is 3MHz for Peak detection at frequency above 1GHz.
3. The resolution bandwidth of test receiver/spectrum analyzer is 1MHz and the video bandwidth is 3MHz for RMS Average (Duty cycle < 98%) for Average detection (AV) at frequency above 1GHz, then the measurement results was added to a correction factor ($10 \log(1/\text{duty cycle})$).
4. The resolution bandwidth of test receiver/spectrum analyzer is 1MHz and the video bandwidth is 10Hz (Duty cycle \geq 98%) for Average detection (AV) at frequency above 1GHz.
5. All modes of operation were investigated and the worst-case emissions are reported.

3.1.5 DEVIATION FROM TEST STANDARD

No deviation.



3.1.6 TEST SETUP

<Frequency Range 9KHz~30MHz >

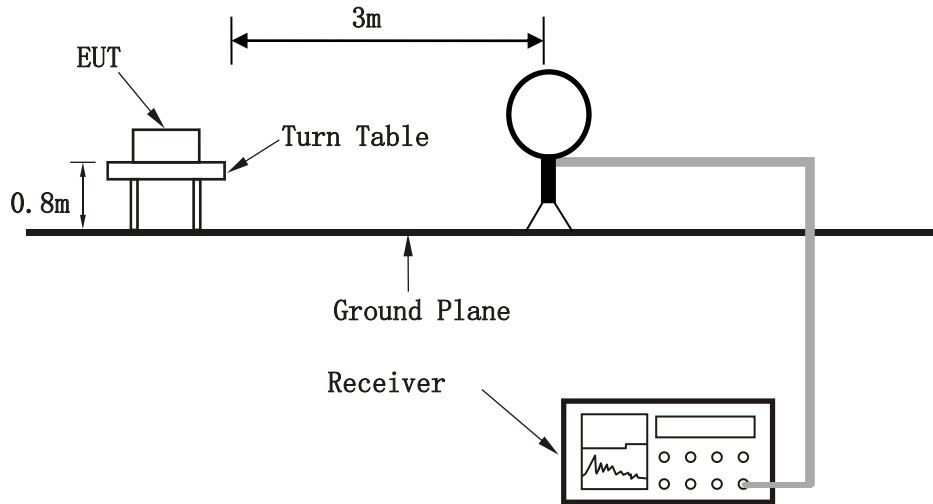

< Frequency Range 30MHz~1GHz >

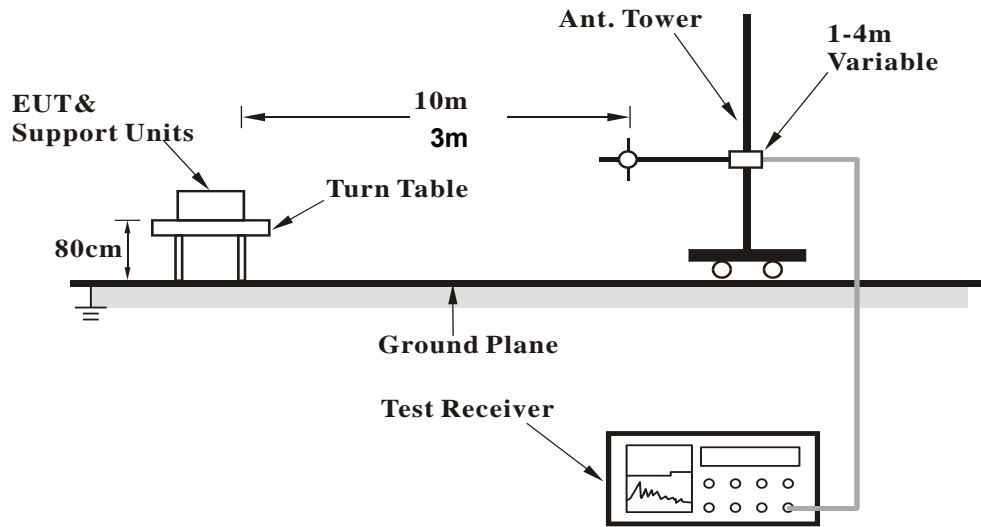

<Frequency Range above 1GHz>

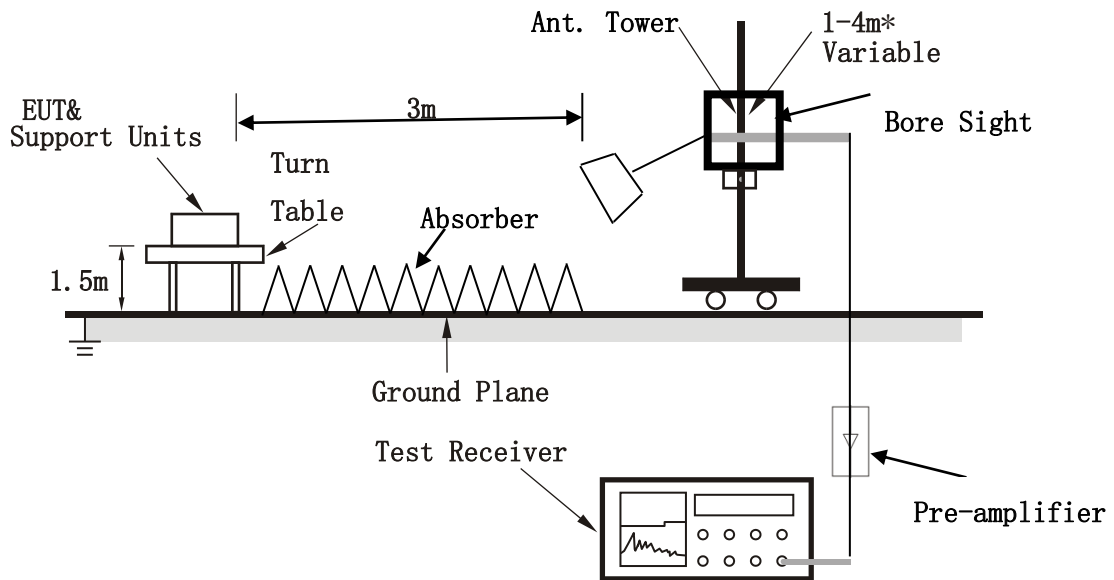



Note: Above 1G is a directional antenna

Depends on the EUT height and the antenna 3dB beamwidth both, refer to section 7.3 of CISPR 16-2-3.

For the actual test configuration, please refer to the attached file (Test Setup Photo).

3.1.7 EUT OPERATING CONDITION

- a. Set the EUT under full load condition and placed them on a testing table.
- b. Set the transmitter part of EUT under transmission condition continuously at specific channel frequency.
- c. The necessary accessories enable the EUT in full functions.



3.1.8 TEST RESULTS

NOTE : The 9K~30MHz amplitude of spurious emissions attenuated more than 20 dB below the permissible value is not required in the report.

30 MHz – 1GHz data:

Band 4

802.11a

CHANNEL	TX Channel 157	DETECTOR FUNCTION	Quasi-Peak (QP)
FREQUENCY RANGE	30MHz ~ 1GHz		

ANTENNA POLARITY & TEST DISTANCE: HORIZONTAL AT 3 M										
FREQ. (MHz)	EMISSION LEVEL (dBuV/m)	READ LEVEL (dBuV)	LIMIT (dBuV/m)	MARGIN (dB)	ANTENNA FACTOR (dB /m)	CABLE LOSS (dB)	PREAMP FACTOR (dB)	ANTENNA HEIGHT (cm)	TABLE ANGLE (Degree)	REMARK
57.16	29.8	56.85	40	-10.2	9.48	0.43	36.96	139	98	QP
108.57	36.71	62.91	43.5	-6.79	10.03	0.55	36.78	162	172	QP
236.61	38.71	61.27	46	-7.29	12.91	0.81	36.28	170	63	QP
280.26	32.56	54.15	46	-13.44	13.8	0.88	36.27	105	214	QP
431.58	32.15	50.71	46	-13.85	16.8	1.12	36.48	189	209	QP
623.64	33.5	48.9	46	-12.5	20.15	1.39	36.94	185	63	QP

REMARKS:

1. Emission level (dBuV/m) = Read level (dBuV) + Correction Factor (dB/m).
2. Correction Factor (dB/m) = Antenna Factor (dB/m) + Cable Factor (dB).
3. The other emission levels were very low against the limit.
4. Margin value = Emission level – Limit value.

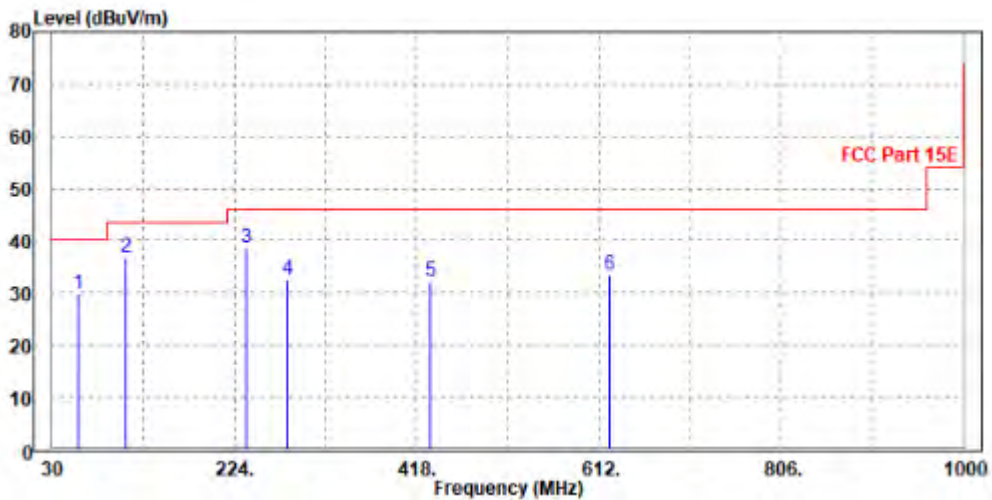



CHANNEL	Channel 157	DETECTOR FUNCTION	Quasi-Peak (QP)
FREQUENCY RANGE	30MHz ~ 1GHz		

ANTENNA POLARITY & TEST DISTANCE: VERTICAL AT 3 M										
FREQ. (MHz)	EMISSION LEVEL (dBuV/m)	READ LEVEL (dBuV)	LIMIT (dBuV/m)	MARGIN (dB)	ANTENNA FACTOR (dB /m)	CABLE LOSS (dB)	PREAMP FACTOR (dB)	ANTENNA HEIGHT (cm)	TABLE ANGLE (Degree)	REMARK
57.16	29.96	57.58	40	-10.04	8.91	0.43	36.96	128	188	QP
107.6	27.35	54.72	43.5	-16.15	8.87	0.55	36.79	173	60	QP
237.58	25.93	49.07	46	-20.07	12.33	0.81	36.28	109	284	QP
303.54	27.26	48.54	46	-18.74	14.08	0.91	36.27	169	43	QP
431.58	31.38	50.03	46	-14.62	16.71	1.12	36.48	134	41	QP
597.45	29.12	45.05	46	-16.88	19.55	1.36	36.84	152	321	QP

REMARKS:

1. Emission level (dBuV/m) = Read level (dBuV) + Correction Factor (dB/m).
2. Correction Factor (dB/m) = Antenna Factor (dB/m) + Cable Factor (dB).
3. The other emission levels were very low against the limit.
4. Margin value = Emission level – Limit value.

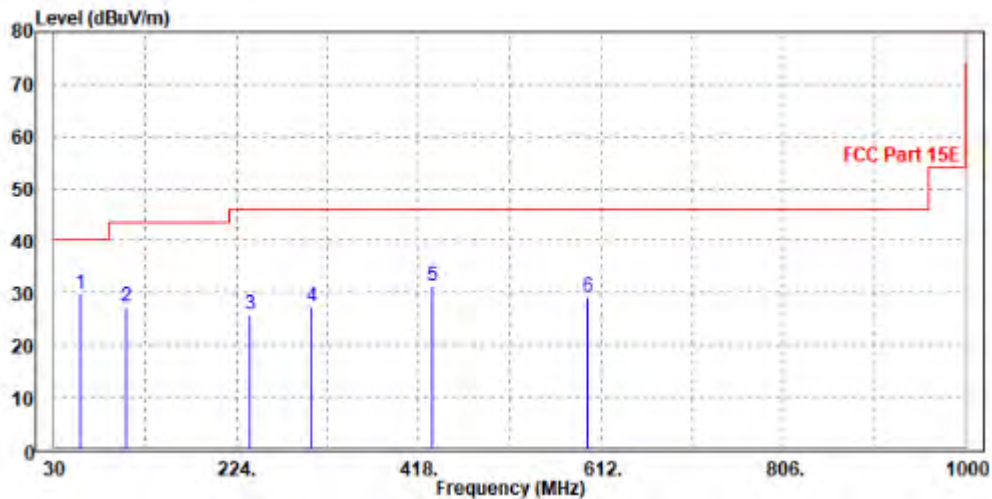



ABOVE 1GHz WORST-CASE DATA:

Note: For higher frequency, the emission is too low to be detected.

Band 1

802.11a

CHANNEL	TX Channel 36	DETECTOR FUNCTION	Peak (PK)
FREQUENCY RANGE	1GHz ~ 40GHz		Average (AV)

ANTENNA POLARITY & TEST DISTANCE: HORIZONTAL AT 3 M										
FREQ. (MHz)	EMISSION LEVEL (dBuV/m)	READ LEVEL (dBuV)	LIMIT (dBuV/m)	MARGIN (dB)	ANTENNA FACTOR (dB /m)	CABLE LOSS (dB)	PREAMP FACTOR (dB)	ANTENNA HEIGHT (cm)	TABLE ANGLE (Degree)	REMARK
5150	60.48	61.55	74	-13.52	34.52	9.92	45.51	151	246	Peak
5150	50.88	51.95	54	-3.12	34.52	9.92	45.51	151	246	Average
5180	104.47	105.53	/	/	34.54	9.91	45.51	104	158	Peak
5180	97.71	98.77	/	/	34.54	9.91	45.51	104	158	Average
5350	54.36	55.34	74	-19.64	34.68	9.85	45.51	155	351	Peak
5350	47.73	48.71	54	-6.27	34.68	9.85	45.51	155	351	Average
ANTENNA POLARITY & TEST DISTANCE: VERTICAL AT 3 M										
FREQ. (MHz)	EMISSION LEVEL (dBuV/m)	READ LEVEL (dBuV)	LIMIT (dBuV/m)	MARGIN (dB)	ANTENNA FACTOR (dB /m)	CABLE LOSS (dB)	PREAMP FACTOR (dB)	ANTENNA HEIGHT (cm)	TABLE ANGLE (Degree)	REMARK
5150	58.37	59.36	74	-15.63	34.6	9.92	45.51	180	163	Peak
5150	50.69	51.68	54	-3.31	34.6	9.92	45.51	180	163	Average
5180	104.79	105.79	/	/	34.6	9.91	45.51	163	198	Peak
5180	97.72	98.72	/	/	34.6	9.91	45.51	163	198	Average
5350	54.69	55.75	74	-19.31	34.6	9.85	45.51	182	268	Peak
5350	47.35	48.41	54	-6.65	34.6	9.85	45.51	182	268	Average

REMARKS:

- Emission Level = Read Level+ Antenna Factor + Cable Loss- Preamp Factor
Margin value = Emission level – Limit value.
- 5180MHz: Fundamental frequency.



CHANNEL	TX Channel 40	DETECTOR FUNCTION	Peak (PK)
FREQUENCY RANGE	1GHz ~ 40GHz		Average (AV)

ANTENNA POLARITY & TEST DISTANCE: HORIZONTAL AT 3 M

FREQ. (MHz)	EMISSION LEVEL (dBuV/m)	READ LEVEL (dBuV)	LIMIT (dBuV/m)	MARGIN (dB)	ANTENNA FACTOR (dB /m)	CABLE LOSS (dB)	PREAMP FACTOR (dB)	ANTENNA HEIGHT (cm)	TABLE ANGLE (Degree)	REMARK
5150	56.53	57.6	74	-17.47	34.52	9.92	45.51	123	273	Peak
5150	50.2	51.27	54	-3.8	34.52	9.92	45.51	123	273	Average
5200	106.5	107.55	/	/	34.56	9.9	45.51	179	171	Peak
5200	99.45	100.5	/	/	34.56	9.9	45.51	179	171	Average
5350	55.44	56.42	74	-18.56	34.68	9.85	45.51	111	157	Peak
5350	47.8	48.78	54	-6.2	34.68	9.85	45.51	111	157	Average

ANTENNA POLARITY & TEST DISTANCE: VERTICAL AT 3 M

FREQ. (MHz)	EMISSION LEVEL (dBuV/m)	READ LEVEL (dBuV)	LIMIT (dBuV/m)	MARGIN (dB)	ANTENNA FACTOR (dB /m)	CABLE LOSS (dB)	PREAMP FACTOR (dB)	ANTENNA HEIGHT (cm)	TABLE ANGLE (Degree)	REMARK
5150	55.74	56.73	74	-18.26	34.6	9.92	45.51	135	170	Peak
5150	49.6	50.59	54	-4.4	34.6	9.92	45.51	135	170	Average
5200	105.41	106.42	/	/	34.6	9.9	45.51	120	132	Peak
5200	98.91	99.92	/	/	34.6	9.9	45.51	120	132	Average
5350	53.71	54.77	74	-20.29	34.6	9.85	45.51	121	46	Peak
5350	48.18	49.24	54	-5.82	34.6	9.85	45.51	121	46	Average

REMARKS:

- Emission Level = Read Level+ Antenna Factor + Cable Loss- Preamp Factor
Margin value = Emission level – Limit value.
- 5200MHz: Fundamental frequency.



CHANNEL	TX Channel 48	DETECTOR FUNCTION	Peak (PK)
FREQUENCY RANGE	1GHz ~ 40GHz		Average (AV)

ANTENNA POLARITY & TEST DISTANCE: HORIZONTAL AT 3 M

FREQ. (MHz)	EMISSION LEVEL (dBuV/m)	READ LEVEL (dBuV)	LIMIT (dBuV/m)	MARGIN (dB)	ANTENNA FACTOR (dB /m)	CABLE LOSS (dB)	PREAMP FACTOR (dB)	ANTENNA HEIGHT (cm)	TABLE ANGLE (Degree)	REMARK
5150	56.84	57.91	74	-17.16	34.52	9.92	45.51	158	28	Peak
5150	49.02	50.09	54	-4.98	34.52	9.92	45.51	158	28	Average
5240	106.68	107.71	/	/	34.59	9.89	45.51	143	261	Peak
5240	99.88	100.91	/	/	34.59	9.89	45.51	143	261	Average
5350	53.6	54.58	74	-20.4	34.68	9.85	45.51	139	238	Peak
5350	47.52	48.5	54	-6.48	34.68	9.85	45.51	139	238	Average

ANTENNA POLARITY & TEST DISTANCE: VERTICAL AT 3 M

FREQ. (MHz)	EMISSION LEVEL (dBuV/m)	READ LEVEL (dBuV)	LIMIT (dBuV/m)	MARGIN (dB)	ANTENNA FACTOR (dB /m)	CABLE LOSS (dB)	PREAMP FACTOR (dB)	ANTENNA HEIGHT (cm)	TABLE ANGLE (Degree)	REMARK
5150	54.65	55.64	74	-19.35	34.6	9.92	45.51	156	31	Peak
5150	49.56	50.55	54	-4.44	34.6	9.92	45.51	156	31	Average
5240	107.13	108.15	/	/	34.6	9.89	45.51	199	103	Peak
5240	100.12	101.14	/	/	34.6	9.89	45.51	199	103	Average
5350	55.55	56.61	74	-18.45	34.6	9.85	45.51	165	69	Peak
5350	47.58	48.64	54	-6.42	34.6	9.85	45.51	165	69	Average

REMARKS:

- Emission Level = Read Level+ Antenna Factor + Cable Loss- Preamp Factor
Margin value = Emission level – Limit value.
- 5240MHz: Fundamental frequency.



802.11n (20MHz)

CHANNEL	TX Channel 36	DETECTOR FUNCTION	Peak (PK)
FREQUENCY RANGE	1GHz ~ 40GHz		Average (AV)

ANTENNA POLARITY & TEST DISTANCE: HORIZONTAL AT 3 M

FREQ. (MHz)	EMISSION LEVEL (dBuV/m)	READ LEVEL (dBuV)	LIMIT (dBuV/m)	MARGIN (dB)	ANTENNA FACTOR (dB /m)	CABLE LOSS (dB)	PREAMP FACTOR (dB)	ANTENNA HEIGHT (cm)	TABLE ANGLE (Degree)	REMARK
5150	55.17	56.24	74	-18.83	34.52	9.92	45.51	114	107	Peak
5150	49.73	50.8	54	-4.27	34.52	9.92	45.51	114	107	Average
5180	102.43	103.49	/	/	34.54	9.91	45.51	182	246	Peak
5180	94.27	95.33	/	/	34.54	9.91	45.51	182	246	Average
5350	53.63	54.61	74	-20.37	34.68	9.85	45.51	104	212	Peak
5350	47.39	48.37	54	-6.61	34.68	9.85	45.51	104	212	Average

ANTENNA POLARITY & TEST DISTANCE: VERTICAL AT 3 M

FREQ. (MHz)	EMISSION LEVEL (dBuV/m)	READ LEVEL (dBuV)	LIMIT (dBuV/m)	MARGIN (dB)	ANTENNA FACTOR (dB /m)	CABLE LOSS (dB)	PREAMP FACTOR (dB)	ANTENNA HEIGHT (cm)	TABLE ANGLE (Degree)	REMARK
5150	58.15	59.14	74	-15.85	34.6	9.92	45.51	168	244	Peak
5150	50.82	51.81	54	-3.18	34.6	9.92	45.51	168	244	Average
5180	101.6	102.6	/	/	34.6	9.91	45.51	197	10	Peak
5180	94.95	95.95	/	/	34.6	9.91	45.51	197	10	Average
5350	54.88	55.94	74	-19.12	34.6	9.85	45.51	178	253	Peak
5350	47.1	48.16	54	-6.9	34.6	9.85	45.51	178	253	Average

REMARKS:

- Emission Level = Read Level+ Antenna Factor + Cable Loss- Preamp Factor
Margin value = Emission level – Limit value.
- 5180MHz: Fundamental frequency.



CHANNEL	TX Channel 40	DETECTOR FUNCTION	Peak (PK)
FREQUENCY RANGE	1GHz ~ 40GHz		Average (AV)

ANTENNA POLARITY & TEST DISTANCE: HORIZONTAL AT 3 M

FREQ. (MHz)	EMISSION LEVEL (dBuV/m)	READ LEVEL (dBuV)	LIMIT (dBuV/m)	MARGIN (dB)	ANTENNA FACTOR (dB /m)	CABLE LOSS (dB)	PREAMP FACTOR (dB)	ANTENNA HEIGHT (cm)	TABLE ANGLE (Degree)	REMARK
5150	55.18	56.25	74	-18.82	34.52	9.92	45.51	100	38	Peak
5150	50.13	51.2	54	-3.87	34.52	9.92	45.51	100	38	Average
5200	105.51	106.56	/	/	34.56	9.9	45.51	136	88	Peak
5200	98.04	99.09	/	/	34.56	9.9	45.51	136	88	Average
5350	54.39	55.37	74	-19.61	34.68	9.85	45.51	102	338	Peak
5350	47.5	48.48	54	-6.5	34.68	9.85	45.51	102	338	Average

ANTENNA POLARITY & TEST DISTANCE: VERTICAL AT 3 M

FREQ. (MHz)	EMISSION LEVEL (dBuV/m)	READ LEVEL (dBuV)	LIMIT (dBuV/m)	MARGIN (dB)	ANTENNA FACTOR (dB /m)	CABLE LOSS (dB)	PREAMP FACTOR (dB)	ANTENNA HEIGHT (cm)	TABLE ANGLE (Degree)	REMARK
5150	53.5	54.49	74	-20.5	34.6	9.92	45.51	103	46	Peak
5150	49.87	50.86	54	-4.13	34.6	9.92	45.51	103	46	Average
5200	107.43	108.44	/	/	34.6	9.9	45.51	107	136	Peak
5200	98.89	99.9	/	/	34.6	9.9	45.51	107	136	Average
5350	53.14	54.2	74	-20.86	34.6	9.85	45.51	99	277	Peak
5350	47.38	48.44	54	-6.62	34.6	9.85	45.51	99	277	Average

REMARKS:

- Emission Level = Read Level+ Antenna Factor + Cable Loss- Preamp Factor
Margin value = Emission level – Limit value.
- 5200MHz: Fundamental frequency.



CHANNEL	TX Channel 48	DETECTOR FUNCTION	Peak (PK)
FREQUENCY RANGE	1GHz ~ 40GHz		Average (AV)

ANTENNA POLARITY & TEST DISTANCE: HORIZONTAL AT 3 M

FREQ. (MHz)	EMISSION LEVEL (dBuV/m)	READ LEVEL (dBuV)	LIMIT (dBuV/m)	MARGIN (dB)	ANTENNA FACTOR (dB /m)	CABLE LOSS (dB)	PREAMP FACTOR (dB)	ANTENNA HEIGHT (cm)	TABLE ANGLE (Degree)	REMARK
5150	55.18	56.25	74	-18.82	34.52	9.92	45.51	156	356	Peak
5150	49.08	50.15	54	-4.92	34.52	9.92	45.51	156	356	Average
5240	106.01	107.04	/	/	34.59	9.89	45.51	111	103	Peak
5240	97.26	98.29	/	/	34.59	9.89	45.51	111	103	Average
5350	53.62	54.6	74	-20.38	34.68	9.85	45.51	156	132	Peak
5350	47.58	48.56	54	-6.42	34.68	9.85	45.51	156	132	Average

ANTENNA POLARITY & TEST DISTANCE: VERTICAL AT 3 M

FREQ. (MHz)	EMISSION LEVEL (dBuV/m)	READ LEVEL (dBuV)	LIMIT (dBuV/m)	MARGIN (dB)	ANTENNA FACTOR (dB /m)	CABLE LOSS (dB)	PREAMP FACTOR (dB)	ANTENNA HEIGHT (cm)	TABLE ANGLE (Degree)	REMARK
5150	54.09	55.08	74	-19.91	34.6	9.92	45.51	158	124	Peak
5150	49.27	50.26	54	-4.73	34.6	9.92	45.51	158	124	Average
5240	107.21	108.23	/	/	34.6	9.89	45.51	105	326	Peak
5240	99.82	100.84	/	/	34.6	9.89	45.51	105	326	Average
5350	53.77	54.83	74	-20.23	34.6	9.85	45.51	170	262	Peak
5350	47.37	48.43	54	-6.63	34.6	9.85	45.51	170	262	Average

REMARKS:

- Emission Level = Read Level+ Antenna Factor + Cable Loss- Preamp Factor
Margin value = Emission level – Limit value.
- 5240MHz: Fundamental frequency.



802.11n (40MHz)

CHANNEL	TX Channel 38	DETECTOR FUNCTION	Peak (PK)
FREQUENCY RANGE	1GHz ~ 40GHz		Average (AV)

ANTENNA POLARITY & TEST DISTANCE: HORIZONTAL AT 3 M

FREQ. (MHz)	EMISSION LEVEL (dBuV/m)	READ LEVEL (dBuV)	LIMIT (dBuV/m)	MARGIN (dB)	ANTENNA FACTOR (dB /m)	CABLE LOSS (dB)	PREAMP FACTOR (dB)	ANTENNA HEIGHT (cm)	TABLE ANGLE (Degree)	REMARK
5150	56.35	57.42	74	-17.65	34.52	9.92	45.51	137	186	Peak
5150	50.17	51.24	54	-3.83	34.52	9.92	45.51	137	186	Average
5190	97.07	98.12	/	/	34.55	9.91	45.51	168	20	Peak
5190	90.27	91.32	/	/	34.55	9.91	45.51	168	20	Average
5350	53.38	54.36	74	-20.62	34.68	9.85	45.51	137	259	Peak
5350	48.17	49.15	54	-5.83	34.68	9.85	45.51	137	259	Average

ANTENNA POLARITY & TEST DISTANCE: VERTICAL AT 3 M

FREQ. (MHz)	EMISSION LEVEL (dBuV/m)	READ LEVEL (dBuV)	LIMIT (dBuV/m)	MARGIN (dB)	ANTENNA FACTOR (dB /m)	CABLE LOSS (dB)	PREAMP FACTOR (dB)	ANTENNA HEIGHT (cm)	TABLE ANGLE (Degree)	REMARK
5150	59.85	60.84	74	-14.15	34.6	9.92	45.51	129	323	Peak
5150	50.72	51.71	54	-3.28	34.6	9.92	45.51	129	323	Average
5190	97.35	98.35	/	/	34.6	9.91	45.51	159	312	Peak
5190	91.88	92.88	/	/	34.6	9.91	45.51	159	312	Average
5350	53.67	54.73	74	-20.33	34.6	9.85	45.51	136	203	Peak
5350	47.69	48.75	54	-6.31	34.6	9.85	45.51	136	203	Average

REMARKS:

- Emission Level = Read Level+ Antenna Factor + Cable Loss- Preamp Factor
Margin value = Emission level – Limit value.
- 5190MHz: Fundamental frequency.



CHANNEL	TX Channel 46	DETECTOR FUNCTION	Peak (PK)
FREQUENCY RANGE	1GHz ~ 40GHz		Average (AV)

ANTENNA POLARITY & TEST DISTANCE: HORIZONTAL AT 3 M

FREQ. (MHz)	EMISSION LEVEL (dBuV/m)	READ LEVEL (dBuV)	LIMIT (dBuV/m)	MARGIN (dB)	ANTENNA FACTOR (dB /m)	CABLE LOSS (dB)	PREAMP FACTOR (dB)	ANTENNA HEIGHT (cm)	TABLE ANGLE (Degree)	REMARK
5150	56.24	57.31	74	-17.76	34.52	9.92	45.51	141	358	Peak
5150	48.96	50.03	54	-5.04	34.52	9.92	45.51	141	358	Average
5230	101.71	102.75	/	/	34.58	9.89	45.51	155	57	Peak
5230	95.38	96.42	/	/	34.58	9.89	45.51	155	57	Average
5350	55.12	56.1	74	-18.88	34.68	9.85	45.51	146	40	Peak
5350	49.01	49.99	54	-4.99	34.68	9.85	45.51	146	40	Average

ANTENNA POLARITY & TEST DISTANCE: VERTICAL AT 3 M

FREQ. (MHz)	EMISSION LEVEL (dBuV/m)	READ LEVEL (dBuV)	LIMIT (dBuV/m)	MARGIN (dB)	ANTENNA FACTOR (dB /m)	CABLE LOSS (dB)	PREAMP FACTOR (dB)	ANTENNA HEIGHT (cm)	TABLE ANGLE (Degree)	REMARK
5150	55.85	56.84	74	-18.15	34.6	9.92	45.51	124	257	Peak
5150	48.33	49.32	54	-5.67	34.6	9.92	45.51	124	257	Average
5230	102.92	103.94	/	/	34.6	9.89	45.51	175	63	Peak
5230	98.39	99.41	/	/	34.6	9.89	45.51	175	63	Average
5350	54.45	55.51	74	-19.55	34.6	9.85	45.51	111	153	Peak
5350	48.28	49.34	54	-5.72	34.6	9.85	45.51	111	153	Average

REMARKS:

- Emission Level = Read Level+ Antenna Factor + Cable Loss- Preamp Factor
Margin value = Emission level – Limit value.
- 5230MHz: Fundamental frequency.



802.11ac (20MHz)

CHANNEL	TX Channel 36	DETECTOR FUNCTION	Peak (PK)
FREQUENCY RANGE	1GHz ~ 40GHz		Average (AV)

ANTENNA POLARITY & TEST DISTANCE: HORIZONTAL AT 3 M

FREQ. (MHz)	EMISSION LEVEL (dBuV/m)	READ LEVEL (dBuV)	LIMIT (dBuV/m)	MARGIN (dB)	ANTENNA FACTOR (dB /m)	CABLE LOSS (dB)	PREAMP FACTOR (dB)	ANTENNA HEIGHT (cm)	TABLE ANGLE (Degree)	REMARK
5150	55.32	56.39	74	-18.68	34.52	9.92	45.51	163	284	Peak
5150	49.09	50.16	54	-4.91	34.52	9.92	45.51	163	284	Average
5180	101.47	102.53	/	/	34.54	9.91	45.51	107	14	Peak
5180	96.25	97.31	/	/	34.54	9.91	45.51	107	14	Average
5350	53.65	54.63	74	-20.35	34.68	9.85	45.51	164	153	Peak
5350	47.37	48.35	54	-6.63	34.68	9.85	45.51	164	153	Average

ANTENNA POLARITY & TEST DISTANCE: VERTICAL AT 3 M

FREQ. (MHz)	EMISSION LEVEL (dBuV/m)	READ LEVEL (dBuV)	LIMIT (dBuV/m)	MARGIN (dB)	ANTENNA FACTOR (dB /m)	CABLE LOSS (dB)	PREAMP FACTOR (dB)	ANTENNA HEIGHT (cm)	TABLE ANGLE (Degree)	REMARK
5150	56.96	57.95	74	-17.04	34.6	9.92	45.51	124	299	Peak
5150	49.65	50.64	54	-4.35	34.6	9.92	45.51	124	299	Average
5180	104.03	105.03	/	/	34.6	9.91	45.51	111	67	Peak
5180	96.79	97.79	/	/	34.6	9.91	45.51	111	67	Average
5350	53.52	54.58	74	-20.48	34.6	9.85	45.51	116	286	Peak
5350	47.38	48.44	54	-6.62	34.6	9.85	45.51	116	286	Average

REMARKS:

- Emission Level = Read Level+ Antenna Factor + Cable Loss- Preamp Factor
Margin value = Emission level – Limit value.
- 5180MHz: Fundamental frequency.



CHANNEL	TX Channel 40	DETECTOR FUNCTION	Peak (PK)
FREQUENCY RANGE	1GHz ~ 40GHz		Average (AV)

ANTENNA POLARITY & TEST DISTANCE: HORIZONTAL AT 3 M

FREQ. (MHz)	EMISSION LEVEL (dBuV/m)	READ LEVEL (dBuV)	LIMIT (dBuV/m)	MARGIN (dB)	ANTENNA FACTOR (dB /m)	CABLE LOSS (dB)	PREAMP FACTOR (dB)	ANTENNA HEIGHT (cm)	TABLE ANGLE (Degree)	REMARK
5150	55.66	56.73	74	-18.34	34.52	9.92	45.51	174	58	Peak
5150	49.61	50.68	54	-4.39	34.52	9.92	45.51	174	58	Average
5200	103.41	104.46	/	/	34.56	9.9	45.51	185	290	Peak
5200	96.15	97.2	/	/	34.56	9.9	45.51	185	290	Average
5350	54.37	55.35	74	-19.63	34.68	9.85	45.51	185	357	Peak
5350	47.79	48.77	54	-6.21	34.68	9.85	45.51	185	357	Average

ANTENNA POLARITY & TEST DISTANCE: VERTICAL AT 3 M

FREQ. (MHz)	EMISSION LEVEL (dBuV/m)	READ LEVEL (dBuV)	LIMIT (dBuV/m)	MARGIN (dB)	ANTENNA FACTOR (dB /m)	CABLE LOSS (dB)	PREAMP FACTOR (dB)	ANTENNA HEIGHT (cm)	TABLE ANGLE (Degree)	REMARK
5150	54.82	55.81	74	-19.18	34.6	9.92	45.51	193	74	Peak
5150	49.31	50.3	54	-4.69	34.6	9.92	45.51	193	74	Average
5200	103.15	104.16	/	/	34.6	9.9	45.51	161	156	Peak
5200	97.96	98.97	/	/	34.6	9.9	45.51	161	156	Average
5350	54.01	55.07	74	-19.99	34.6	9.85	45.51	199	12	Peak
5350	47.78	48.84	54	-6.22	34.6	9.85	45.51	199	12	Average

REMARKS:

- Emission Level = Read Level+ Antenna Factor + Cable Loss- Preamp Factor
Margin value = Emission level – Limit value.
- 5200MHz: Fundamental frequency.



CHANNEL	TX Channel 48	DETECTOR FUNCTION	Peak (PK)
FREQUENCY RANGE	1GHz ~ 40GHz		Average (AV)

ANTENNA POLARITY & TEST DISTANCE: HORIZONTAL AT 3 M

FREQ. (MHz)	EMISSION LEVEL (dBuV/m)	READ LEVEL (dBuV)	LIMIT (dBuV/m)	MARGIN (dB)	ANTENNA FACTOR (dB /m)	CABLE LOSS (dB)	PREAMP FACTOR (dB)	ANTENNA HEIGHT (cm)	TABLE ANGLE (Degree)	REMARK
5150	54.99	56.06	74	-19.01	34.52	9.92	45.51	132	159	Peak
5150	47.99	49.06	54	-6.01	34.52	9.92	45.51	132	159	Average
5240	102.42	103.45	/	/	34.59	9.89	45.51	104	43	Peak
5240	95.38	96.41	/	/	34.59	9.89	45.51	104	43	Average
5350	53.88	54.86	74	-20.12	34.68	9.85	45.51	141	261	Peak
5350	49.26	50.24	54	-4.74	34.68	9.85	45.51	141	261	Average

ANTENNA POLARITY & TEST DISTANCE: VERTICAL AT 3 M

FREQ. (MHz)	EMISSION LEVEL (dBuV/m)	READ LEVEL (dBuV)	LIMIT (dBuV/m)	MARGIN (dB)	ANTENNA FACTOR (dB /m)	CABLE LOSS (dB)	PREAMP FACTOR (dB)	ANTENNA HEIGHT (cm)	TABLE ANGLE (Degree)	REMARK
5150	54.72	55.71	74	-19.28	34.6	9.92	45.51	160	138	Peak
5150	48.79	49.78	54	-5.21	34.6	9.92	45.51	160	138	Average
5240	103.94	104.96	/	/	34.6	9.89	45.51	151	245	Peak
5240	97.02	98.04	/	/	34.6	9.89	45.51	151	245	Average
5350	53.96	55.02	74	-20.04	34.6	9.85	45.51	162	39	Peak
5350	47.06	48.12	54	-6.94	34.6	9.85	45.51	162	39	Average

REMARKS:

- Emission Level = Read Level+ Antenna Factor + Cable Loss- Preamp Factor
Margin value = Emission level – Limit value.
- 5240MHz: Fundamental frequency.



802.11ac (40MHz)

CHANNEL	TX Channel 38	DETECTOR FUNCTION	Peak (PK)
FREQUENCY RANGE	1GHz ~ 40GHz		Average (AV)

ANTENNA POLARITY & TEST DISTANCE: HORIZONTAL AT 3 M

FREQ. (MHz)	EMISSION LEVEL (dBuV/m)	READ LEVEL (dBuV)	LIMIT (dBuV/m)	MARGIN (dB)	ANTENNA FACTOR (dB /m)	CABLE LOSS (dB)	PREAMP FACTOR (dB)	ANTENNA HEIGHT (cm)	TABLE ANGLE (Degree)	REMARK
5150	56.37	57.44	74	-17.63	34.52	9.92	45.51	152	91	Peak
5150	50.79	51.86	54	-3.21	34.52	9.92	45.51	152	91	Average
5190	98.32	99.37	/	/	34.55	9.91	45.51	135	35	Peak
5190	90.35	91.4	/	/	34.55	9.91	45.51	135	35	Average
5350	53.91	54.89	74	-20.09	34.68	9.85	45.51	148	269	Peak
5350	47.38	48.36	54	-6.62	34.68	9.85	45.51	148	269	Average

ANTENNA POLARITY & TEST DISTANCE: VERTICAL AT 3 M

FREQ. (MHz)	EMISSION LEVEL (dBuV/m)	READ LEVEL (dBuV)	LIMIT (dBuV/m)	MARGIN (dB)	ANTENNA FACTOR (dB /m)	CABLE LOSS (dB)	PREAMP FACTOR (dB)	ANTENNA HEIGHT (cm)	TABLE ANGLE (Degree)	REMARK
5150	55.74	56.73	74	-18.26	34.6	9.92	45.51	137	214	Peak
5150	50.65	51.64	54	-3.35	34.6	9.92	45.51	137	214	Average
5190	96.97	97.97	/	/	34.6	9.91	45.51	194	274	Peak
5190	91.75	92.75	/	/	34.6	9.91	45.51	194	274	Average
5350	53.91	54.97	74	-20.09	34.6	9.85	45.51	146	258	Peak
5350	47.35	48.41	54	-6.65	34.6	9.85	45.51	146	258	Average

REMARKS:

- Emission Level = Read Level+ Antenna Factor + Cable Loss- Preamp Factor
Margin value = Emission level – Limit value.
- 5190MHz: Fundamental frequency.



CHANNEL	TX Channel 46	DETECTOR FUNCTION	Peak (PK)
FREQUENCY RANGE	1GHz ~ 40GHz		Average (AV)

ANTENNA POLARITY & TEST DISTANCE: HORIZONTAL AT 3 M

FREQ. (MHz)	EMISSION LEVEL (dBuV/m)	READ LEVEL (dBuV)	LIMIT (dBuV/m)	MARGIN (dB)	ANTENNA FACTOR (dB /m)	CABLE LOSS (dB)	PREAMP FACTOR (dB)	ANTENNA HEIGHT (cm)	TABLE ANGLE (Degree)	REMARK
5150	58.47	59.54	74	-15.53	34.52	9.92	45.51	160	17	Peak
5150	49.45	50.52	54	-4.55	34.52	9.92	45.51	160	17	Average
5230	98.96	100	/	/	34.58	9.89	45.51	102	121	Peak
5230	92.6	93.64	/	/	34.58	9.89	45.51	102	121	Average
5350	54.25	55.23	74	-19.75	34.68	9.85	45.51	167	131	Peak
5350	48.98	49.96	54	-5.02	34.68	9.85	45.51	167	131	Average

ANTENNA POLARITY & TEST DISTANCE: VERTICAL AT 3 M

FREQ. (MHz)	EMISSION LEVEL (dBuV/m)	READ LEVEL (dBuV)	LIMIT (dBuV/m)	MARGIN (dB)	ANTENNA FACTOR (dB /m)	CABLE LOSS (dB)	PREAMP FACTOR (dB)	ANTENNA HEIGHT (cm)	TABLE ANGLE (Degree)	REMARK
5150	55.9	56.89	74	-18.1	34.6	9.92	45.51	178	244	Peak
5150	48.6	49.59	54	-5.4	34.6	9.92	45.51	178	244	Average
5230	102.05	103.07	/	/	34.6	9.89	45.51	148	198	Peak
5230	94.56	95.58	/	/	34.6	9.89	45.51	148	198	Average
5350	56.47	57.53	74	-17.53	34.6	9.85	45.51	194	356	Peak
5350	47.72	48.78	54	-6.28	34.6	9.85	45.51	194	356	Average

REMARKS:

- Emission Level = Read Level+ Antenna Factor + Cable Loss- Preamp Factor
Margin value = Emission level – Limit value.
- 5230MHz: Fundamental frequency.



802.11ac (80MHz)

CHANNEL	TX Channel 42	DETECTOR FUNCTION	Peak (PK)
FREQUENCY RANGE	1GHz ~ 40GHz		Average (AV)

ANTENNA POLARITY & TEST DISTANCE: HORIZONTAL AT 3 M

FREQ. (MHz)	EMISSION LEVEL (dBuV/m)	READ LEVEL (dBuV)	LIMIT (dBuV/m)	MARGIN (dB)	ANTENNA FACTOR (dB /m)	CABLE LOSS (dB)	PREAMP FACTOR (dB)	ANTENNA HEIGHT (cm)	TABLE ANGLE (Degree)	REMARK
5150	56.89	57.96	74	-17.11	34.52	9.92	45.51	185	172	Peak
5150	50.54	51.61	54	-3.46	34.52	9.92	45.51	185	172	Average
5210	93.78	94.82	/	/	34.57	9.9	45.51	175	122	Peak
5210	87.55	88.59	/	/	34.57	9.9	45.51	175	122	Average
5350	53.4	54.38	74	-20.6	34.68	9.85	45.51	189	116	Peak
5350	46.88	47.86	54	-7.12	34.68	9.85	45.51	189	116	Average

ANTENNA POLARITY & TEST DISTANCE: VERTICAL AT 3 M

FREQ. (MHz)	EMISSION LEVEL (dBuV/m)	READ LEVEL (dBuV)	LIMIT (dBuV/m)	MARGIN (dB)	ANTENNA FACTOR (dB /m)	CABLE LOSS (dB)	PREAMP FACTOR (dB)	ANTENNA HEIGHT (cm)	TABLE ANGLE (Degree)	REMARK
5150	55.94	56.93	74	-18.06	34.6	9.92	45.51	146	293	Peak
5150	50.72	51.71	54	-3.28	34.6	9.92	45.51	146	293	Average
5210	91.82	92.83	/	/	34.6	9.9	45.51	135	29	Peak
5210	86.8	87.81	/	/	34.6	9.9	45.51	135	29	Average
5350	53.13	54.19	74	-20.87	34.6	9.85	45.51	151	89	Peak
5350	47.63	48.69	54	-6.37	34.6	9.85	45.51	151	89	Average

REMARKS:

- Emission Level = Read Level+ Antenna Factor + Cable Loss- Preamp Factor
Margin value = Emission level – Limit value.
- 5210MHz: Fundamental frequency.



Worst case harmonic:

802.11a

CHANNEL	TX Channel 36	DETECTOR FUNCTION	Peak (PK)
FREQUENCY RANGE	1GHz ~ 25GHz		Average (AV)

ANTENNA POLARITY & TEST DISTANCE: HORIZONTAL AT 3 M

	Freq	Level	Read Level	Limit Line	Over Limit	Factor	Remark	Pol/Phase
	MHz	dBuV/m	dBuV	dBuV/m	dB	dB/m		
1	10360.000	52.49	42.53	74.00	-21.51	9.96	Peak	Horizontal
2	10360.000	43.32	33.36	54.00	-10.68	9.96	Average	Horizontal
3	PK15535.000	54.11	38.97	74.00	-19.89	15.14	Peak	Horizontal
4	PP15535.000	44.95	29.81	54.00	-9.05	15.14	Average	Horizontal

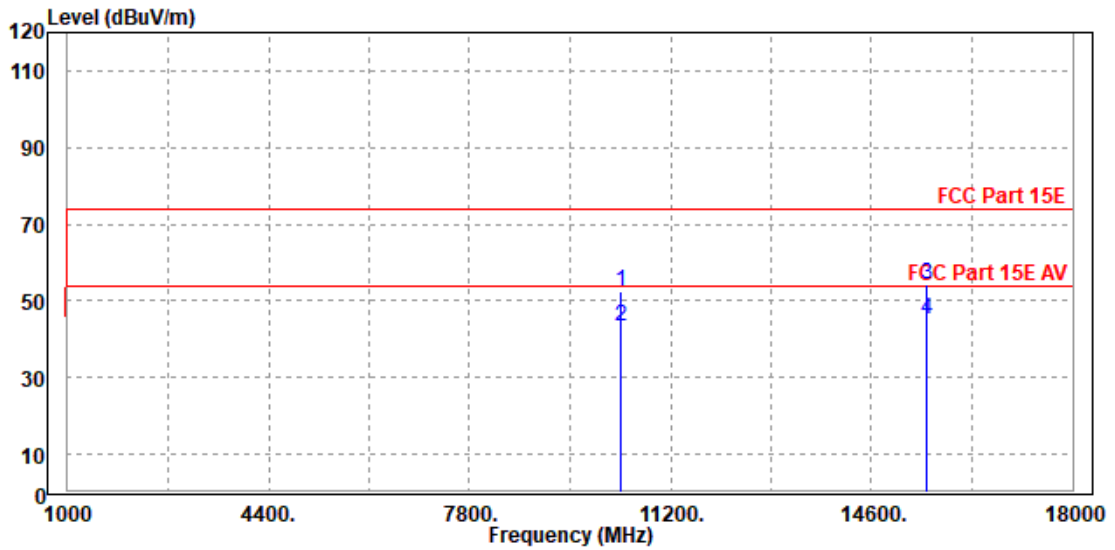



ANTENNA POLARITY & TEST DISTANCE: VERTICAL AT 3 M

	Freq	Level	Read Level	Limit Line	Over Limit	Factor	Remark	Pol/Phase
	MHz	dBuV/m	dBuV	dBuV/m	dB	dB/m		
1	10367.000	51.45	42.58	74.00	-22.55	8.87	Peak	Vertical
2	10367.000	42.51	33.64	54.00	-11.49	8.87	Average	Vertical
3	PK15540.000	52.58	39.25	74.00	-21.42	13.33	Peak	Vertical
4	PP15540.000	43.89	30.56	54.00	-10.11	13.33	Average	Vertical

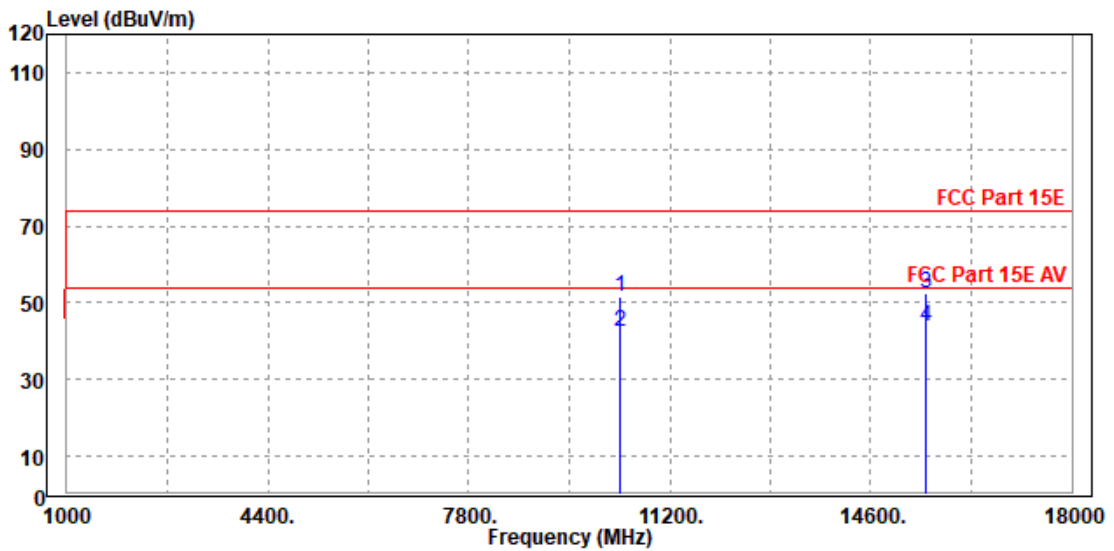

REMARKS:

- Emission Level = Read Level+ Antenna Factor + Cable Loss- Preamp Factor
Margin value = Emission level – Limit value.
- 5180MHz: Fundamental frequency.



Band 2

802.11a

CHANNEL	TX Channel 52	DETECTOR FUNCTION	Peak (PK)
FREQUENCY RANGE	1GHz ~ 40GHz		Average (AV)

ANTENNA POLARITY & TEST DISTANCE: HORIZONTAL AT 3 M

FREQ. (MHz)	EMISSION LEVEL (dBuV/m)	READ LEVEL (dBuV)	LIMIT (dBuV/m)	MARGIN (dB)	ANTENNA FACTOR (dB /m)	CABLE LOSS (dB)	PREAMP FACTOR (dB)	ANTENNA HEIGHT (cm)	TABLE ANGLE (Degree)	REMARK
5150	54.76	55.83	74	-19.24	34.52	9.92	45.51	105	185	Peak
5150	49.27	50.34	54	-4.73	34.52	9.92	45.51	105	185	Average
5260	105.87	106.89	/	/	34.61	9.88	45.51	172	156	Peak
5260	98.68	99.7	/	/	34.61	9.88	45.51	172	156	Average
5350	54.64	55.62	74	-19.36	34.68	9.85	45.51	116	268	Peak
5350	47.35	48.33	54	-6.65	34.68	9.85	45.51	116	268	Average

ANTENNA POLARITY & TEST DISTANCE: VERTICAL AT 3 M

FREQ. (MHz)	EMISSION LEVEL (dBuV/m)	READ LEVEL (dBuV)	LIMIT (dBuV/m)	MARGIN (dB)	ANTENNA FACTOR (dB /m)	CABLE LOSS (dB)	PREAMP FACTOR (dB)	ANTENNA HEIGHT (cm)	TABLE ANGLE (Degree)	REMARK
5150	57.55	58.54	74	-16.45	34.6	9.92	45.51	118	258	Peak
5150	49.35	50.34	54	-4.65	34.6	9.92	45.51	118	258	Average
5260	106.6	107.63	/	/	34.6	9.88	45.51	160	187	Peak
5260	100.05	101.08	/	/	34.6	9.88	45.51	160	187	Average
5350	56.39	57.45	74	-17.61	34.6	9.85	45.51	107	116	Peak
5350	48.37	49.43	54	-5.63	34.6	9.85	45.51	107	116	Average

REMARKS:

- Emission Level = Read Level+ Antenna Factor + Cable Loss- Preamp Factor
Margin value = Emission level – Limit value.
- 5260MHz: Fundamental frequency.



CHANNEL	TX Channel 60	DETECTOR FUNCTION	Peak (PK)
FREQUENCY RANGE	1GHz ~ 40GHz		Average (AV)

ANTENNA POLARITY & TEST DISTANCE: HORIZONTAL AT 3 M

FREQ. (MHz)	EMISSION LEVEL (dBuV/m)	READ LEVEL (dBuV)	LIMIT (dBuV/m)	MARGIN (dB)	ANTENNA FACTOR (dB /m)	CABLE LOSS (dB)	PREAMP FACTOR (dB)	ANTENNA HEIGHT (cm)	TABLE ANGLE (Degree)	REMARK
5150	54.5	55.57	74	-19.5	34.52	9.92	45.51	146	229	Peak
5150	49.59	50.66	54	-4.41	34.52	9.92	45.51	146	229	Average
5300	107.02	108.02	/	/	34.64	9.87	45.51	195	349	Peak
5300	99.16	100.16	/	/	34.64	9.87	45.51	195	349	Average
5350	54.87	55.85	74	-19.13	34.68	9.85	45.51	155	279	Peak
5350	48.7	49.68	54	-5.3	34.68	9.85	45.51	155	279	Average

ANTENNA POLARITY & TEST DISTANCE: VERTICAL AT 3 M

FREQ. (MHz)	EMISSION LEVEL (dBuV/m)	READ LEVEL (dBuV)	LIMIT (dBuV/m)	MARGIN (dB)	ANTENNA FACTOR (dB /m)	CABLE LOSS (dB)	PREAMP FACTOR (dB)	ANTENNA HEIGHT (cm)	TABLE ANGLE (Degree)	REMARK
5150	56.43	57.42	74	-17.57	34.6	9.92	45.51	104	275	Peak
5150	50.4	51.39	54	-3.6	34.6	9.92	45.51	104	275	Average
5300	106.98	108.02	/	/	34.6	9.87	45.51	103	173	Peak
5300	99.91	100.95	/	/	34.6	9.87	45.51	103	173	Average
5350	55.46	56.52	74	-18.54	34.6	9.85	45.51	114	65	Peak
5350	49.85	50.91	54	-4.15	34.6	9.85	45.51	114	65	Average

REMARKS:

- Emission Level = Read Level+ Antenna Factor + Cable Loss- Preamp Factor
Margin value = Emission level – Limit value.
- 5300MHz: Fundamental frequency.



CHANNEL	TX Channel 64	DETECTOR FUNCTION	Peak (PK)
FREQUENCY RANGE	1GHz ~ 40GHz		Average (AV)

ANTENNA POLARITY & TEST DISTANCE: HORIZONTAL AT 3 M

FREQ. (MHz)	EMISSION LEVEL (dBuV/m)	READ LEVEL (dBuV)	LIMIT (dBuV/m)	MARGIN (dB)	ANTENNA FACTOR (dB /m)	CABLE LOSS (dB)	PREAMP FACTOR (dB)	ANTENNA HEIGHT (cm)	TABLE ANGLE (Degree)	REMARK
5150	55.52	56.59	74	-18.48	34.52	9.92	45.51	185	188	Peak
5150	48.58	49.65	54	-5.42	34.52	9.92	45.51	185	188	Average
5320	101.04	102.03	/	/	34.66	9.86	45.51	118	221	Peak
5320	93.84	94.83	/	/	34.66	9.86	45.51	118	221	Average
5350	56.89	57.87	74	-17.11	34.68	9.85	45.51	180	252	Peak
5350	49.34	50.32	54	-4.66	34.68	9.85	45.51	180	252	Average

ANTENNA POLARITY & TEST DISTANCE: VERTICAL AT 3 M

FREQ. (MHz)	EMISSION LEVEL (dBuV/m)	READ LEVEL (dBuV)	LIMIT (dBuV/m)	MARGIN (dB)	ANTENNA FACTOR (dB /m)	CABLE LOSS (dB)	PREAMP FACTOR (dB)	ANTENNA HEIGHT (cm)	TABLE ANGLE (Degree)	REMARK
5150	54.53	55.52	74	-19.47	34.6	9.92	45.51	101	174	Peak
5150	48.96	49.95	54	-5.04	34.6	9.92	45.51	101	174	Average
5320	101.14	102.19	/	/	34.6	9.86	45.51	188	70	Peak
5320	94.05	95.1	/	/	34.6	9.86	45.51	188	70	Average
5350	54.12	55.18	74	-19.88	34.6	9.85	45.51	99	26	Peak
5350	50.55	51.61	54	-3.45	34.6	9.85	45.51	99	26	Average

REMARKS:

- Emission Level = Read Level+ Antenna Factor + Cable Loss- Preamp Factor
Margin value = Emission level – Limit value.
- 5320MHz: Fundamental frequency.



802.11n (20MHz)

CHANNEL	TX Channel 52	DETECTOR FUNCTION	Peak (PK)
FREQUENCY RANGE	1GHz ~ 40GHz		Average (AV)

ANTENNA POLARITY & TEST DISTANCE: HORIZONTAL AT 3 M

FREQ. (MHz)	EMISSION LEVEL (dBuV/m)	READ LEVEL (dBuV)	LIMIT (dBuV/m)	MARGIN (dB)	ANTENNA FACTOR (dB /m)	CABLE LOSS (dB)	PREAMP FACTOR (dB)	ANTENNA HEIGHT (cm)	TABLE ANGLE (Degree)	REMARK
5150	55.1	56.17	74	-18.9	34.52	9.92	45.51	100	275	Peak
5150	48.86	49.93	54	-5.14	34.52	9.92	45.51	100	275	Average
5260	104.32	105.34	/	/	34.61	9.88	45.51	194	157	Peak
5260	98.15	99.17	/	/	34.61	9.88	45.51	194	157	Average
5350	54.46	55.44	74	-19.54	34.68	9.85	45.51	89	74	Peak
5350	47.59	48.57	54	-6.41	34.68	9.85	45.51	89	74	Average

ANTENNA POLARITY & TEST DISTANCE: VERTICAL AT 3 M

FREQ. (MHz)	EMISSION LEVEL (dBuV/m)	READ LEVEL (dBuV)	LIMIT (dBuV/m)	MARGIN (dB)	ANTENNA FACTOR (dB /m)	CABLE LOSS (dB)	PREAMP FACTOR (dB)	ANTENNA HEIGHT (cm)	TABLE ANGLE (Degree)	REMARK
5150	54.78	55.77	74	-19.22	34.6	9.92	45.51	150	198	Peak
5150	48.94	49.93	54	-5.06	34.6	9.92	45.51	150	198	Average
5260	105.79	106.82	/	/	34.6	9.88	45.51	157	26	Peak
5260	98.52	99.55	/	/	34.6	9.88	45.51	157	26	Average
5350	56.18	57.24	74	-17.82	34.6	9.85	45.51	146	12	Peak
5350	48.08	49.14	54	-5.92	34.6	9.85	45.51	146	12	Average

REMARKS:

- Emission Level = Read Level+ Antenna Factor + Cable Loss- Preamp Factor
Margin value = Emission level – Limit value.
- 5260MHz: Fundamental frequency.



CHANNEL	TX Channel 60	DETECTOR FUNCTION	Peak (PK)
FREQUENCY RANGE	1GHz ~ 40GHz		Average (AV)

ANTENNA POLARITY & TEST DISTANCE: HORIZONTAL AT 3 M

FREQ. (MHz)	EMISSION LEVEL (dBuV/m)	READ LEVEL (dBuV)	LIMIT (dBuV/m)	MARGIN (dB)	ANTENNA FACTOR (dB /m)	CABLE LOSS (dB)	PREAMP FACTOR (dB)	ANTENNA HEIGHT (cm)	TABLE ANGLE (Degree)	REMARK
5150	55.16	56.23	74	-18.84	34.52	9.92	45.51	113	230	Peak
5150	48.83	49.9	54	-5.17	34.52	9.92	45.51	113	230	Average
5300	105.01	106.01	/	/	34.64	9.87	45.51	131	70	Peak
5300	97.43	98.43	/	/	34.64	9.87	45.51	131	70	Average
5350	54.46	55.44	74	-19.54	34.68	9.85	45.51	107	321	Peak
5350	48.79	49.77	54	-5.21	34.68	9.85	45.51	107	321	Average

ANTENNA POLARITY & TEST DISTANCE: VERTICAL AT 3 M

FREQ. (MHz)	EMISSION LEVEL (dBuV/m)	READ LEVEL (dBuV)	LIMIT (dBuV/m)	MARGIN (dB)	ANTENNA FACTOR (dB /m)	CABLE LOSS (dB)	PREAMP FACTOR (dB)	ANTENNA HEIGHT (cm)	TABLE ANGLE (Degree)	REMARK
5150	54.12	55.11	74	-19.88	34.6	9.92	45.51	125	84	Peak
5150	49.01	50	54	-4.99	34.6	9.92	45.51	125	84	Average
5300	105.55	106.59	/	/	34.6	9.87	45.51	166	348	Peak
5300	98.83	99.87	/	/	34.6	9.87	45.51	166	348	Average
5350	56.59	57.65	74	-17.41	34.6	9.85	45.51	124	310	Peak
5350	48.1	49.16	54	-5.9	34.6	9.85	45.51	124	310	Average

REMARKS:

- Emission Level = Read Level+ Antenna Factor + Cable Loss- Preamp Factor
Margin value = Emission level – Limit value.
- 5300MHz: Fundamental frequency.



CHANNEL	TX Channel 64	DETECTOR FUNCTION	Peak (PK)
FREQUENCY RANGE	1GHz ~ 40GHz		Average (AV)

ANTENNA POLARITY & TEST DISTANCE: HORIZONTAL AT 3 M

FREQ. (MHz)	EMISSION LEVEL (dBuV/m)	READ LEVEL (dBuV)	LIMIT (dBuV/m)	MARGIN (dB)	ANTENNA FACTOR (dB /m)	CABLE LOSS (dB)	PREAMP FACTOR (dB)	ANTENNA HEIGHT (cm)	TABLE ANGLE (Degree)	REMARK
5150	55.04	56.11	74	-18.96	34.52	9.92	45.51	192	289	Peak
5150	48.86	49.93	54	-5.14	34.52	9.92	45.51	192	289	Average
5320	102.06	103.05	/	/	34.66	9.86	45.51	174	87	Peak
5320	94.61	95.6	/	/	34.66	9.86	45.51	174	87	Average
5350	57.71	58.69	74	-16.29	34.68	9.85	45.51	208	333	Peak
5350	50.6	51.58	54	-3.4	34.68	9.85	45.51	208	333	Average

ANTENNA POLARITY & TEST DISTANCE: VERTICAL AT 3 M

FREQ. (MHz)	EMISSION LEVEL (dBuV/m)	READ LEVEL (dBuV)	LIMIT (dBuV/m)	MARGIN (dB)	ANTENNA FACTOR (dB /m)	CABLE LOSS (dB)	PREAMP FACTOR (dB)	ANTENNA HEIGHT (cm)	TABLE ANGLE (Degree)	REMARK
5150	54.2	55.19	74	-19.8	34.6	9.92	45.51	131	104	Peak
5150	48.91	49.9	54	-5.09	34.6	9.92	45.51	131	104	Average
5320	101.34	102.39	74	27.34	34.6	9.86	45.51	161	340	Peak
5320	94.58	95.63	54	40.58	34.6	9.86	45.51	161	340	Average
5350	58.23	59.29	74	-15.77	34.6	9.85	45.51	138	252	Peak
5350	50.81	51.87	54	-3.19	34.6	9.85	45.51	138	252	Average

REMARKS:

- Emission Level = Read Level+ Antenna Factor + Cable Loss- Preamp Factor
Margin value = Emission level – Limit value.
- 5320MHz: Fundamental frequency.



802.11n (40MHz)

CHANNEL	TX Channel 54	DETECTOR FUNCTION	Peak (PK)
FREQUENCY RANGE	1GHz ~ 40GHz		Average (AV)

ANTENNA POLARITY & TEST DISTANCE: HORIZONTAL AT 3 M

FREQ. (MHz)	EMISSION LEVEL (dBuV/m)	READ LEVEL (dBuV)	LIMIT (dBuV/m)	MARGIN (dB)	ANTENNA FACTOR (dB /m)	CABLE LOSS (dB)	PREAMP FACTOR (dB)	ANTENNA HEIGHT (cm)	TABLE ANGLE (Degree)	REMARK
5150	57.33	58.4	74	-16.67	34.52	9.92	45.51	167	191	Peak
5150	49.43	50.5	54	-4.57	34.52	9.92	45.51	167	191	Average
5270	100.84	101.85	/	/	34.62	9.88	45.51	151	244	Peak
5270	96.03	97.04	/	/	34.62	9.88	45.51	151	244	Average
5350	59.67	60.65	74	-14.33	34.68	9.85	45.51	179	97	Peak
5350	50.6	51.58	54	-3.4	34.68	9.85	45.51	179	97	Average

ANTENNA POLARITY & TEST DISTANCE: VERTICAL AT 3 M

FREQ. (MHz)	EMISSION LEVEL (dBuV/m)	READ LEVEL (dBuV)	LIMIT (dBuV/m)	MARGIN (dB)	ANTENNA FACTOR (dB /m)	CABLE LOSS (dB)	PREAMP FACTOR (dB)	ANTENNA HEIGHT (cm)	TABLE ANGLE (Degree)	REMARK
5150	55.28	56.27	74	-18.72	34.6	9.92	45.51	189	199	Peak
5150	49.04	50.03	54	-4.96	34.6	9.92	45.51	189	199	Average
5270	101.35	102.38	/	/	34.6	9.88	45.51	174	291	Peak
5270	96.08	97.11	/	/	34.6	9.88	45.51	174	291	Average
5350	55.57	56.63	74	-18.43	34.6	9.85	45.51	185	170	Peak
5350	50.64	51.7	54	-3.36	34.6	9.85	45.51	185	170	Average

REMARKS:

- Emission Level = Read Level+ Antenna Factor + Cable Loss- Preamp Factor
Margin value = Emission level – Limit value.
- 5270MHz: Fundamental frequency.



CHANNEL	TX Channel 62	DETECTOR FUNCTION	Peak (PK)
FREQUENCY RANGE	1GHz ~ 40GHz		Average (AV)

ANTENNA POLARITY & TEST DISTANCE: HORIZONTAL AT 3 M

FREQ. (MHz)	EMISSION LEVEL (dBuV/m)	READ LEVEL (dBuV)	LIMIT (dBuV/m)	MARGIN (dB)	ANTENNA FACTOR (dB /m)	CABLE LOSS (dB)	PREAMP FACTOR (dB)	ANTENNA HEIGHT (cm)	TABLE ANGLE (Degree)	REMARK
5150	54.28	55.35	74	-19.72	34.52	9.92	45.51	113	150	Peak
5150	48.97	50.04	54	-5.03	34.52	9.92	45.51	113	150	Average
5310	95.88	96.88	/	/	34.65	9.86	45.51	166	31	Peak
5310	90.68	91.68	/	/	34.65	9.86	45.51	166	31	Average
5350	56.14	57.12	74	-17.86	34.68	9.85	45.51	109	9	Peak
5350	50.46	51.44	54	-3.54	34.68	9.85	45.51	109	9	Average

ANTENNA POLARITY & TEST DISTANCE: VERTICAL AT 3 M

FREQ. (MHz)	EMISSION LEVEL (dBuV/m)	READ LEVEL (dBuV)	LIMIT (dBuV/m)	MARGIN (dB)	ANTENNA FACTOR (dB /m)	CABLE LOSS (dB)	PREAMP FACTOR (dB)	ANTENNA HEIGHT (cm)	TABLE ANGLE (Degree)	REMARK
5150	54.92	55.91	74	-19.08	34.6	9.92	45.51	120	153	Peak
5150	48.75	49.74	54	-5.25	34.6	9.92	45.51	120	153	Average
5310	96.48	97.53	/	/	34.6	9.86	45.51	136	205	Peak
5310	90.7	91.75	/	/	34.6	9.86	45.51	136	205	Average
5350	56.59	57.65	74	-17.41	34.6	9.85	45.51	117	340	Peak
5350	50.12	51.18	54	-3.88	34.6	9.85	45.51	117	340	Average

REMARKS:

- Emission Level = Read Level+ Antenna Factor + Cable Loss- Preamp Factor
Margin value = Emission level – Limit value.
- 5310MHz: Fundamental frequency.



802.11ac (20MHz)

CHANNEL	TX Channel 52	DETECTOR FUNCTION	Peak (PK)
FREQUENCY RANGE	1GHz ~ 40GHz		Average (AV)

ANTENNA POLARITY & TEST DISTANCE: HORIZONTAL AT 3 M

FREQ. (MHz)	EMISSION LEVEL (dBuV/m)	READ LEVEL (dBuV)	LIMIT (dBuV/m)	MARGIN (dB)	ANTENNA FACTOR (dB /m)	CABLE LOSS (dB)	PREAMP FACTOR (dB)	ANTENNA HEIGHT (cm)	TABLE ANGLE (Degree)	REMARK
5150	55.98	57.05	74	-18.02	34.52	9.92	45.51	184	234	Peak
5150	49.12	50.19	54	-4.88	34.52	9.92	45.51	184	234	Average
5260	103.44	104.46	/	/	34.61	9.88	45.51	181	115	Peak
5260	96.95	97.97	/	/	34.61	9.88	45.51	181	115	Average
5350	55.44	56.42	74	-18.56	34.68	9.85	45.51	195	59	Peak
5350	47.94	48.92	54	-6.06	34.68	9.85	45.51	195	59	Average

ANTENNA POLARITY & TEST DISTANCE: VERTICAL AT 3 M

FREQ. (MHz)	EMISSION LEVEL (dBuV/m)	READ LEVEL (dBuV)	LIMIT (dBuV/m)	MARGIN (dB)	ANTENNA FACTOR (dB /m)	CABLE LOSS (dB)	PREAMP FACTOR (dB)	ANTENNA HEIGHT (cm)	TABLE ANGLE (Degree)	REMARK
5150	54.45	55.44	74	-19.55	34.6	9.92	45.51	181	345	Peak
5150	49.75	50.74	54	-4.25	34.6	9.92	45.51	181	345	Average
5260	102.66	103.69	/	/	34.6	9.88	45.51	194	156	Peak
5260	96.42	97.45	/	/	34.6	9.88	45.51	194	156	Average
5350	53.79	54.85	74	-20.21	34.6	9.85	45.51	187	105	Peak
5350	48.25	49.31	54	-5.75	34.6	9.85	45.51	187	105	Average

REMARKS:

- Emission Level = Read Level+ Antenna Factor + Cable Loss- Preamp Factor
Margin value = Emission level – Limit value.
- 5260MHz: Fundamental frequency.



CHANNEL	TX Channel 60	DETECTOR FUNCTION	Peak (PK)
FREQUENCY RANGE	1GHz ~ 40GHz		Average (AV)

ANTENNA POLARITY & TEST DISTANCE: HORIZONTAL AT 3 M

FREQ. (MHz)	EMISSION LEVEL (dBuV/m)	READ LEVEL (dBuV)	LIMIT (dBuV/m)	MARGIN (dB)	ANTENNA FACTOR (dB /m)	CABLE LOSS (dB)	PREAMP FACTOR (dB)	ANTENNA HEIGHT (cm)	TABLE ANGLE (Degree)	REMARK
5150	55.64	56.71	74	-18.36	34.52	9.92	45.51	135	325	Peak
5150	49.16	50.23	54	-4.84	34.52	9.92	45.51	135	325	Average
5300	103.15	104.15	/	/	34.64	9.87	45.51	154	30	Peak
5300	95.85	96.85	/	/	34.64	9.87	45.51	154	30	Average
5350	53.64	54.62	74	-20.36	34.68	9.85	45.51	124	267	Peak
5350	48.07	49.05	54	-5.93	34.68	9.85	45.51	124	267	Average

ANTENNA POLARITY & TEST DISTANCE: VERTICAL AT 3 M

FREQ. (MHz)	EMISSION LEVEL (dBuV/m)	READ LEVEL (dBuV)	LIMIT (dBuV/m)	MARGIN (dB)	ANTENNA FACTOR (dB /m)	CABLE LOSS (dB)	PREAMP FACTOR (dB)	ANTENNA HEIGHT (cm)	TABLE ANGLE (Degree)	REMARK
5150	56.5	57.49	74	-17.5	34.6	9.92	45.51	127	123	Peak
5150	48.82	49.81	54	-5.18	34.6	9.92	45.51	127	123	Average
5300	103.11	104.15	/	/	34.6	9.87	45.51	160	24	Peak
5300	96.03	97.07	/	/	34.6	9.87	45.51	160	24	Average
5350	54.85	55.91	74	-19.15	34.6	9.85	45.51	131	104	Peak
5350	48.08	49.14	54	-5.92	34.6	9.85	45.51	131	104	Average

REMARKS:

- Emission Level = Read Level+ Antenna Factor + Cable Loss- Preamp Factor
Margin value = Emission level – Limit value.
- 5300MHz: Fundamental frequency.



CHANNEL	TX Channel 64	DETECTOR FUNCTION	Peak (PK)
FREQUENCY RANGE	1GHz ~ 40GHz		Average (AV)

ANTENNA POLARITY & TEST DISTANCE: HORIZONTAL AT 3 M

FREQ. (MHz)	EMISSION LEVEL (dBuV/m)	READ LEVEL (dBuV)	LIMIT (dBuV/m)	MARGIN (dB)	ANTENNA FACTOR (dB /m)	CABLE LOSS (dB)	PREAMP FACTOR (dB)	ANTENNA HEIGHT (cm)	TABLE ANGLE (Degree)	REMARK
5150	56.81	57.88	74	-17.19	34.52	9.92	45.51	199	323	Peak
5150	49.31	50.38	54	-4.69	34.52	9.92	45.51	199	323	Average
5320	101.74	102.73	/	/	34.66	9.86	45.51	160	293	Peak
5320	95.3	96.29	/	/	34.66	9.86	45.51	160	293	Average
5350	56.81	57.79	74	-17.19	34.68	9.85	45.51	185	335	Peak
5350	49.25	50.23	54	-4.75	34.68	9.85	45.51	185	335	Average

ANTENNA POLARITY & TEST DISTANCE: VERTICAL AT 3 M

FREQ. (MHz)	EMISSION LEVEL (dBuV/m)	READ LEVEL (dBuV)	LIMIT (dBuV/m)	MARGIN (dB)	ANTENNA FACTOR (dB /m)	CABLE LOSS (dB)	PREAMP FACTOR (dB)	ANTENNA HEIGHT (cm)	TABLE ANGLE (Degree)	REMARK
5150	54.59	55.58	74	-19.41	34.6	9.92	45.51	125	93	Peak
5150	49.18	50.17	54	-4.82	34.6	9.92	45.51	125	93	Average
5320	101.77	102.82	/	/	34.6	9.86	45.51	189	303	Peak
5320	95.1	96.15	/	/	34.6	9.86	45.51	189	303	Average
5350	56.08	57.14	74	-17.92	34.6	9.85	45.51	122	351	Peak
5350	49.25	50.31	54	-4.75	34.6	9.85	45.51	122	351	Average

REMARKS:

- Emission Level = Read Level+ Antenna Factor + Cable Loss- Preamp Factor
Margin value = Emission level – Limit value.
- 5320MHz: Fundamental frequency.