

Tronsmart

T7 mini

Portable Outdoor Speaker

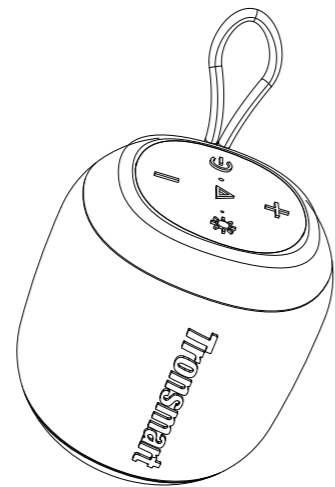

USER MANUAL

English

Thank you for purchasing the Tronsmart T7 Mini Portable Outdoor Speaker. Please read the user manual before use and keep it handy for future reference. If you have any additional questions or comments, please contact us by email at: support@tronsmart.com

Package Contents

- 1 x T7 Mini Portable Outdoor Speaker
- 1 x Aux-in Cable
- 1 x Type-C Charging Cable
- 1 x Warranty Card
- 1 x User Manual

Button Configuration

- ① Power On/Power Off
- ② Power Indicator/Charging Indicator/Bluetooth Indicator
- ③ Play/Pause
- ④ Microphone
- ⑤ Volume -
- ⑥ LED Light Switch
- ⑦ Volume +
- ⑧ Aux-in Port
- ⑨ TF/SD Card Slot
- ⑩ Type-C Charging Port

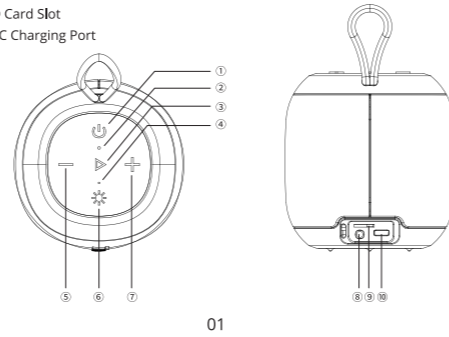

01

	Press for 2s to turn on
	Press for 2s to turn off
	Press once to switch modes among Wireless, TF Card & Aux-in
	Double Press to enter/exit stereo pairing.
	Press once to play or pause the music
	Double press to activate voice assistant
	Press once to answer or hang up the phone call
	Press for 2s to reject the phone call
	Press for 8s to reset
	Press once to turn on/off LED Indicator
	Press to turn up volume
	Double press to skip to next track
	Press to turn down volume
	Double press to skip to previous track
	Press for 2s to disconnect from device

*Note

- The volume synchronizes with iOS devices ONLY.
- If the volume could not synchronize between speaker & phone on some Android devices, please adjust the volume of both speakers & phone synchronously.
- Auto-switch to last playing mode while powering on.

Specifications

Model	T7 Mini
Wireless Version	5.3
Wireless Profile	A2DP / HFP / A2DP / AVRCP
Audio Codec	SBC
Transmission Distance	Up to 18m/59ft (open area)
Waterproof	IPX7
Output	15W
Power Supply	5V1A via Type-C port
Frequency Range	20Hz - 20KHz
Battery	2500mAh
Playtime(Varied by Volume Level & Audio Content)	Up to 18 Hours(LED Off) Up to 8 Hours(LED On)
Charging time	3 Hours

02

Tronsmart

FCC Warning Statement

Changes or modifications not expressly approved by the party responsible for compliance could void the user's authority to operate the equipment. This equipment has been tested and found to comply with the limits for a Class B digital device, pursuant to Part 15 of the FCC Rules. These limits are designed to provide reasonable protection against harmful interference in a residential installation. This equipment generates uses and can radiate radio frequency energy and, if not installed and used in accordance with the instructions, may cause harmful interference to radio communications. However, there is no guarantee that interference will not occur in a particular installation. If this equipment does cause harmful interference to radio or television reception, which can be determined by turning the equipment off and on, the user is encouraged to try to correct the interference by one or more of the following measures:

- Reorient or relocate the receiving antenna.
- Increase the separation between the equipment and receiver.
- Connect the equipment into an outlet on a circuit different from that to which the receiver is connected.
- Consult the dealer or an experienced radio/TV technician for help.

This device complies with part 15 of the FCC Rules. Operation is subject to the following two conditions: (1) This device may not cause harmful interference, and (2) this device must accept any interference received, including interference that may cause undesired operation.

The device has been evaluated to meet general RF exposure requirements.

SHENZHEN GEEKBUY E-COMMERCE CO., LTD.
Warehouse 10214, No. 49 White Avenue, White Community,
Bantian Street, Longgang District, Shenzhen, China
Email: support@tronsmart.com
800-270-1082 (USA & Canada)
+86-755-23603740 (Global)



www.tronsmart.com FCC ID: 2AV32-T7MINI Made in China

How to Use

1. Turn On/Off

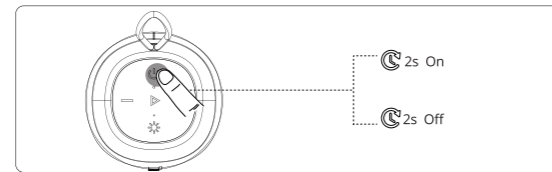

On	White Indicator On
Off	Red Indicator On

2. Connection

Search & click "Tronsmart T7 Mini" to connect.

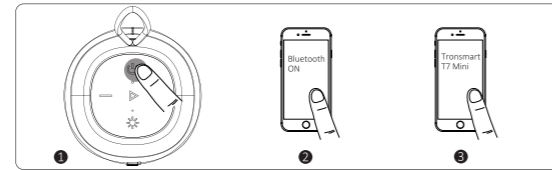

Pairing	Blue Indicator Flashes
Connected	Blue Indicator On

3. Disconnect

Quickly connect to another device, you could press the '+' & '-' button for 2s to disconnect from device.

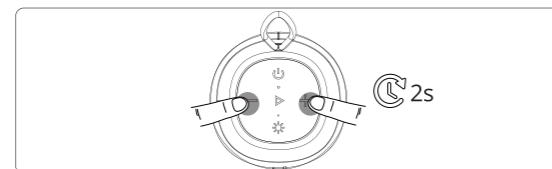

03

4. True Wireless Stereo Mode

Connect 2 Tronsmart T7 Mini speakers to enjoy powerful stereo sound.

1) Turn on both speakers. Please make sure either speaker has entered pairing mode.

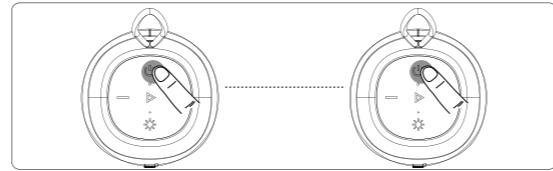

2) Double Press "Power" Button of either speaker(Host Speaker) to enter stereo pairing mode with white indicator flashes. (Double press to exit)

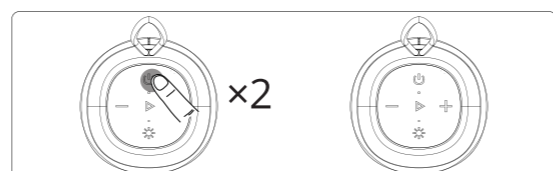

3) If paired successfully, the host speaker will stay white indicator on while vice one will flash white once 3s.

Host Speaker	White Indicator on
Vice Speaker	White Indicator Flashes once 3s

4) Search & click "Tronsmart T7 Mini" to connect.



04

Host Speaker	Blue Indicator on
Vice Speaker	Blue Indicator Flashes once 3s

*Note

You could only pick up a call on the host speaker.

5. Aux-in Mode

Simply connect the speaker with your wired device via the 3.5 mm audio jack cable. Note: After plugging in an audio cable, the speaker will automatically switch to Aux-in mode.

6. TF/Micro SD Card Slot Mode

The speaker will play the music from your TF/Micro SD card when plugging the card into the slot.

7. Indicator

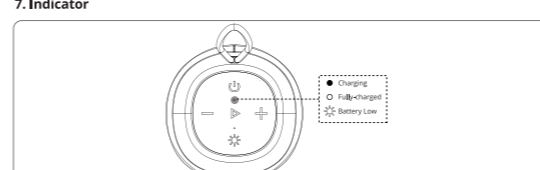

Red Indicator Flashes Slowly	Battery Low
Red Indicator On	Charging
Red Indicator Goes off	Fully-charged

8. Reset

Press "Play/Pause" button for 8s to reset. If reset successfully, the speaker will turn off.

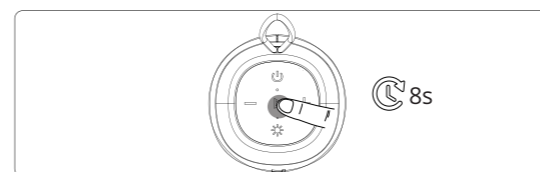

05

9. Auto Power Off

The speaker will power off automatically after 10 minutes if it does not pair with any device.

When in low battery, the speaker will power off automatically as well.

Care & Maintenance

- Do not use any form of detergents or cleaning material to clean the product as any type of chemical may make this device unusable.
- Do not disassemble this product. It contains no user serviceable parts.
- Do not drop or jump on it and treat it with care for the best performance.
- Keep the product in a dry location. Dust, dirt & moisture from humidity can accumulate on the body of the product if kept at an unfriendly place.
- Do not dispose this product in fire or batteries may explode or leak.

Warranty Information

Your "Tronsmart T7 Mini Portable Outdoor Speaker", is warranted to the original owner for 12 months from the date of purchase against defects in material and workmanship under normal use and service. Tronsmart is not responsible for the accidental use of this product and its liability will not exceed the purchase price of the product. If you have any problems while using the product, please do not hesitate to contact our customer support team at support@tronsmart.com.

06