

说明书：

尺寸：A5

材质：128克铜版纸封面黑白印刷，过环保漆，
70克内页书写纸双面黑白印刷

要求：印刷清晰，裁切整齐

ENTERTAINMENT TV

BUILT-IN SOUNDBAR

Model: CX32A21ETVDC / CX40A21ETVDC / CX50A21ETVDC



Instruction Manual

Contents

| | |
|--|----|
| Important Safety Instructions | 1 |
| About Your TV | |
| Features | 3 |
| Includes | 3 |
| Setup | |
| Connecting the Stand | 3 |
| Remote Batteries | 3 |
| Mounting the TV on a wall | 4 |
| Orientation | |
| Front Panel | 5 |
| Remote | 6 |
| Inputs | 7 |
| Main Menu Operation | |
| Setup Wizard | 8 |
| Source Select | 10 |
| Zone B Source Menu | 10 |
| Setup Menu | 11 |
| Picture Menu | 12 |
| Sound Menu | 13 |
| Time Menu | 14 |
| Lock Menu | 15 |
| Channel Menu | 16 |
| Bluetooth | 17 |
| FM Radio | 18 |
| Media | 19 |
| Specifications | 22 |
| Trouble Shooting | 23 |
| Customer Support | |
| Warranty | 24 |

Important Safety Instructions

Warnings and Precautions

To prevent any injuries, the following safety precautions should be observed in the installation, use, servicing and maintenance of this equipment.

Before operating this equipment, please read this manual completely, and keep it for future reference.





- 1) Read these instructions.
- 2) Keep these instructions.
- 3) Heed all warnings.
- 4) Follow all instructions.
- 5) Do not use this apparatus near water.
- 6) Do not clean with strong chemical agents
- 7) The appliance is intended for household use only, and not for commercial or industrial use.
- 8) Do not block any of the ventilation openings. Install in accordance with the manufacturer's instructions.
- 9) Do not install near any heat sources such as radiators, heat registers, stoves, or other apparatus (including amplifiers) that produce heat.
- 10) Care required with the use of this apparatus in tropical climates. Do not use the appliance under temperatures over 40°C.
- 11) Protect the power cord from being walked on or pinched particularly at plugs, convenience receptacles, and the point where they exit from the apparatus.
- 12) Only use the attachments/accessories specified by the manufacturer.
- 13) Use only with a stand, or bracket, specified by the manufacturer, or sold with the apparatus.
- 14) Unplug this apparatus during lightning storms or when unused for long periods of time.
- 15) Do not operate the unit if it is not working normally or has been damaged in anyway. Turn the unit off, unplug it from the power source and consult service personnel. Do not attempt to service this unit yourself.
- 16) Refer all servicing to qualified service personnel. Servicing is required when the apparatus has been damaged in any way, such as power supply cord or plug is damaged, liquid has been spilled or objects have fallen into the apparatus, the apparatus has been exposed to rain or moisture, does not operate normally, or has been dropped.



Important Safety Instructions

- 17) Do not listen to headphones at high volumes; the excessive sound pressure from earphones can cause hearing loss.
- 18) Keep the player clean and never store it next to a heat source or in dirty, humid or wet places. Keep it out of direct sunlight.
- 19) Press the Player's button gently. Pressing them or the screen too hard can damage the player.
- 20) Do not subject the product to harsh impacts. Do not drop the appliance. This may result in damage to the product.
Do not touch, push or rub the surface of the LCD screen with any sharp or hard objects. When the surface of the LCD screen becomes dusty, wipe it gently with an absorbent cotton cloth or other soft material like chamois. Do not use acetone, toluene or alcohol to clean the surface of the screen. These chemicals will cause damage to the surface.
- 21) Please observe the local regulations regarding the disposal of packaging materials, exhausted batteries and old equipment.

WARNING: To reduce the risk of fire or electric shock, this apparatus shall not be exposed to dripping or splashing and no objects filled with liquids, such as vases, shall be placed on the apparatus.

| | |
|---|--|
|  CAUTION RISK OF ELECTRIC SHOCK DO NOT OPEN  |  <p>The lightning flash with an arrowhead symbol, within an equilateral triangle is intended to alert the user to the presence of uninsulated "dangerous voltage" within the product's enclosure that may be of sufficient magnitude to constitute a risk of electric shock to persons.</p>  <p>The exclamation point within an equilateral triangle is intended to alert the user to the presence of important operating and maintenance (servicing) instructions in the literature accompanying the appliance.</p> |
| <p>CAUTION: TO REDUCE THE RISK OF ELECTRIC SHOCK, DO NOT REMOVE COVER (OR BACK), NO USER-SERVICEABLE PARTS INSIDE. REFER SERVICING TO QUALIFIED SERVICE PERSONNEL.</p> | <p>5B-En</p> |

Apparatus with Class I construction shall be connected to a Mains socket outlet with a protective earthing connection.

WARNING

TO PREVENT DAMAGE WHICH MAY RESULT IN FIRE OR ELECTRIC SHOCK HAZARD, DO NOT EXPOSE THIS APPLIANCE TO RAIN OR MOISTURE.

Caution :

- These servicing instructions are for use by qualified service personnel only.
To reduce the risk of electric shock, do not perform any servicing other than that contained in the operating instructions unless you are qualified to do so.
- Any changes or modifications not expressly approved by the party responsible for compliance could void the user's authority to operate the equipment.

About Your TV

Features

- With built in Soundbar system.
- With 2 Zone audio distribution, FM and Bluetooth.
- Front panel USB in and HDMI in ports.
- Front panel buttons.

Includes

- Remote Control and 2 AAA Batteries
- Base Stand and Screws
- Instruction Manual
- Wall-mount Screws (BM6*10mm)
- Quick Start Guide
- POP Label
- DC Power cable

Setup

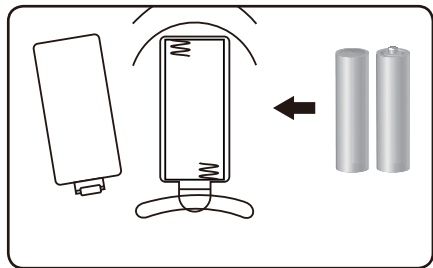
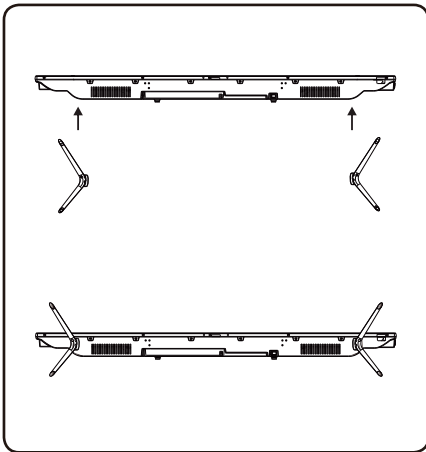

Remote Batteries

Requires 2, AAA-size batteries (included)

Connecting the Stand

When placing TV on flat surface, be careful not to push, scratch, or otherwise damage the front of the TV and LCD screen. Using a screwdriver, tighten the screws by hand. Using a power drill could damage the TV stand.

Mounting the TV on a wall

If you mount this TV on the wall, follow the instructions exactly as set out by the manufacturer. Incomplete or improper installation may cause injury to you, and/or damage to the LED TV. When you have appropriate wall mount brackets, please install them by using the VESA screws included in TV PE bag.

Install Steps

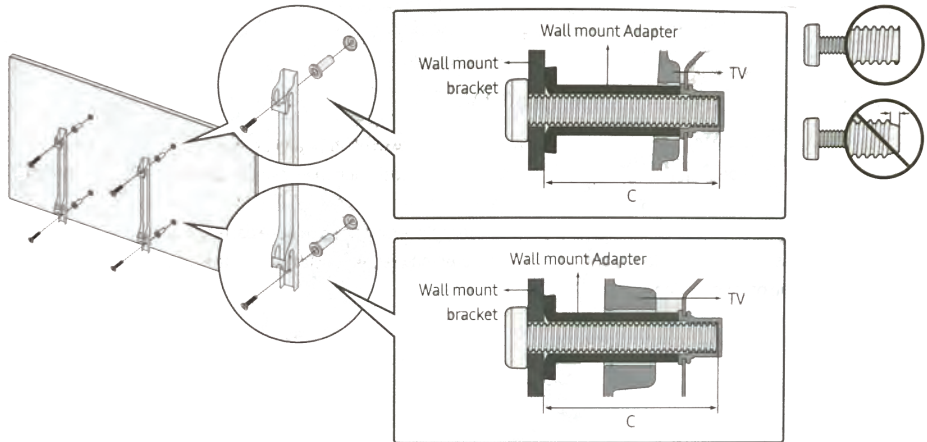

1. Assemble the wall mount adapter.
2. Install the wall mount adapter on a wall with screws.
3. Install the wall mount brackets onto rear cabinet with the VESA screws.
4. Buckle the brackets with TV into the wall mount adapter.





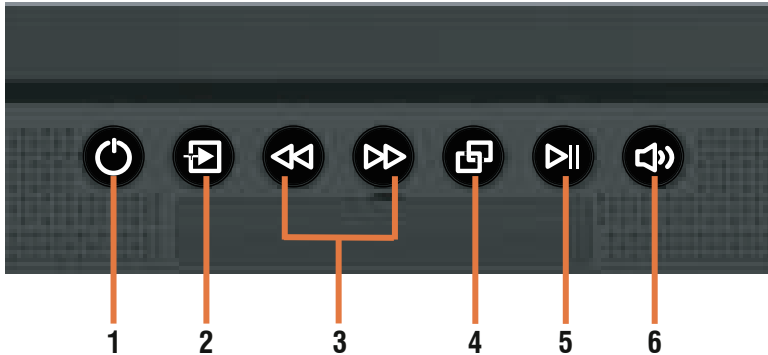

Please refer to the table below to ensure the correct size VESA mount is used with the TV.

| TV size in inches | VESA screw hole specs | | Screw Size mm | Quantity pcs |
|-------------------|-----------------------|-----------|---------------|--------------|
| | Width mm | Height mm | | |
| 32 | 200 | 100 | BM6*10 | 4 |
| 40 | 200 | 200 | BM6*10 | 4 |
| 50 | 200 | 200 | BM6*10 | 4 |

Orientation

Front Panel



1.  Power button: Press to Turn ON/OFF the TV.
2.  Source button: Press repeatedly to select desired audio and/or video source.
3.  Arrow buttons: Press to seek up and down radio stations and TV channels.
Also use with Virtual Sound button (6) for function selection.
4.  Pair button: In Bluetooth Source, press to connect a Bluetooth compatible audio device.
5.  Play button: In Bluetooth, Media and FM Source, press for play/pause selection.
6.  Virtual Sound button:
 - Press to toggle through Zone A: ON/OFF - Zone A Volume - Zone B: ON/OFF - Zone B Volume.
 - Use the Arrow buttons (3) to select Zone ON/OFF and Volume levels
 - Press and briefly hold the Virtual Sound button (6) to access the Zone B Source menu.
 - Press the Arrow buttons (3) to choose the active source for Zone B.

Orientation

Remote

1. : Turn ON/OFF the TV .
2. Source: Select desired audio and/or video source.
3. P.MODE: Select a picture mode.
4. S.MODE: Select a sound mode.
5. z z² : Select amount of time before TV turns off automatically.
6. NUMBER Buttons(0-9): Enter numbers or select channels;
In FM radio source, press SET and one of the 0-9 numeric numbers to preset radio stations, then press one of the 0-9 buttons to recall desired radio station preset.
7. -/-: Switch between single and double digit input.
8. : Switch between the current and previous channel.
9. Red VOL +/- (ZONE A): Adjust Volume level for Zone A.
10. Green VOL +/- (ZONE B): Adjust Volume level for Zone B.
11. : Shut off sound of TV temporarily, press again to restore TV sound.
12. INFO: Display current channel information;
Turn off screen in BT and FM source.
13. CH-(TUNE-): Seek down FM radio stations or TV channel.
14. CH+(TUNE+): Seek up FM radio stations or TV channel.
15. SET: When a new radio station searched, Press the SET button and one of the 0-9 numeric buttons to preset your radio station.
16. MENU: Enter the main menu. In menu mode, moves up one level.
17. EXIT: Exit the current menu.
18. : Navigate within a menu ; Select for fine tuning in FM radio source.
19. : Navigate within a menu; Choose the active source for Zone B source menu.
20. ENTER: Confirm the operation.
21. / : Switch closed captions on and off in TV;
During playback, press it to select play or pause the current playback.
22. : Display the electronic program guide; Stop playing.
23. : Press and hold it to fast backward.
24. : Press and hold it to fast forward.
25. : During playback, select the previous track / chapter.
26. : During playback, select the next track/chapter.
27. REPEAT: Select repeat playback mode.
28. GOTO: Jump to a specific time on a DVD/VCD/MPS/WMA or CD.
29. A-B: Start A-B repeat function.
30. F.LIST: Display favorite channel list.
31. FAV: Assign current channel to favorite channel list.
32. ZOOM: Set picture size.
33. CH.LIST: Display the channel list.
34. MTS: Select MTS sound system, press repeatedly to choose one of the modes among Mono, Stereo, Snap.
35. FREEZE: Display frozen image on screen.
36. RED A: Switch Zone A ON and OFF.
37. BT PAIR: Connect to a Bluetooth® compatible audio device.
38. GREEN B: Switch Zone B ON and OFF;
Press and briefly hold the green B button to access the Zone B Source menu.

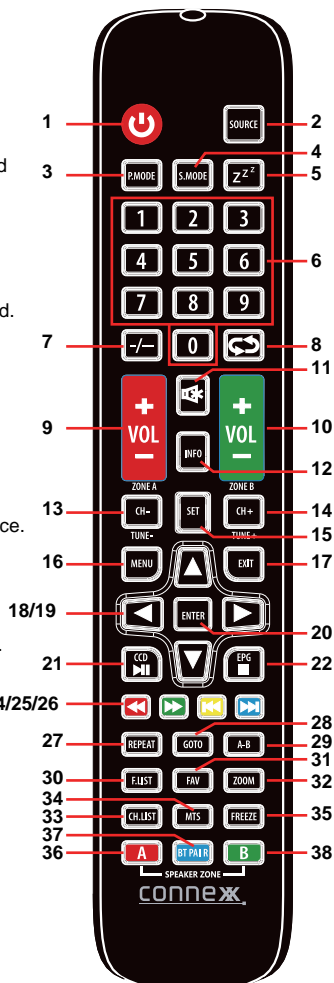

Orientation

Inputs

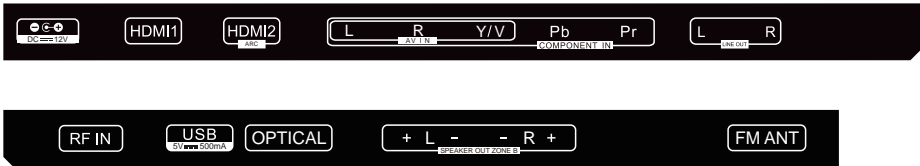

FRONT HDMI 3 IN: HDMI input.

FRONT USB: USB Port for media playback when Media is the TV's selected source.

DC 12V IN: Power (DC 12V or plugpack) input.

HDMI 1 IN: HDMI input.

HDMI 2(ARC) IN: HDMI(ARC) input.

AV IN: Connects to the Audio out and composite Video out of an AV device (L / R / V).

YPbPr IN: Composite/Component Video in.

LINE OUT: Connects to the Audio in ports of an audio device.

RF IN: Connects to the ANTENNA, CABLE, or CABLE BOX.

USB: USB Port for media playback when Media is the TV's selected source.

OPTICAL OUT: Connects to the Optical Audio in port of an audio device.

SPEAKER OUT ZONE B: Connects to 2 external loud speakers(L / R).

FM ANT: Connects to the FM ANTENNA.

Main Menu Operation

Setup Wizard

Connect RF cable to the RF IN connector.

Select Language

Press ◀ / ▶ button to select the language to be used for menus and message.

Press ▼ / ▲ button to select **Go to next step** and press **ENTER** button to enter the sub-menu.



Select Time

Press ▼ / ▲ button to select the time zone, daylight saving time and time format you want.

Press ◀ / ▶ button on the remote control to adjust.

Press ▼ / ▲ button on the remote control to select **Go to next step** and press **ENTER** button to enter the sub-menu.

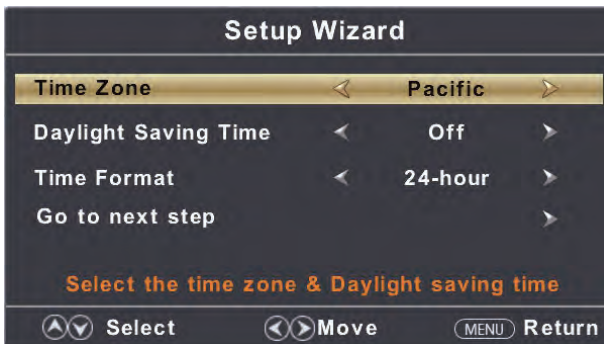

Main Menu Operation

Setup Wizard

Auto Scan

Press ◀ / ▶ button to select the Air or Cable for how you watch TV.

Press ▼ / ▲ button to select **Go to next step** and press **ENTER** button to start auto scan.

Air: Auto Scan → Start to scan.

Cable: Auto Scan → Cable System (AUTO - STD - IRC - HRC) → Start to scan.

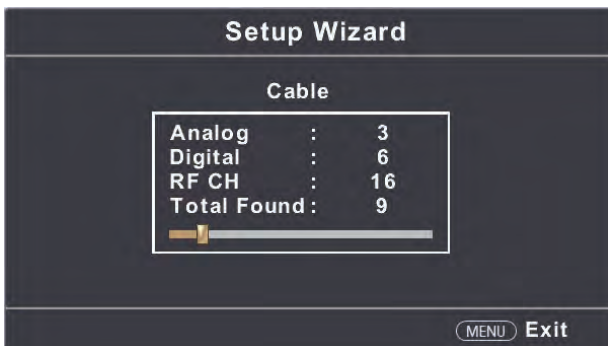
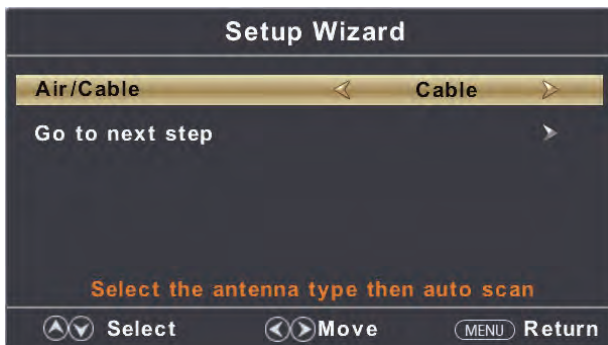

Source Select

Press **Source** button on the remote or front panel,

Press **▼/▲** button on the remote or **◀/▶** button on the front panel to choose the desired source.



Zone B Source Menu

Use this Menu to select Zone B source – TV All (same as Zone A), Bluetooth® or FM.

- Press and briefly hold the **green B** button on the remote control or **↔** button on the front panel to access the Zone B Source menu.
- Press **▼/▲** button on the remote control or **◀/▶** button on the front panel to choose the active source for Zone B.



Setup Menu

Press **MENU** to enter the main menu, Press **◀ / ▶** button to select Setup.
 Press **ENTER** or **▼** to enter.
 Press **MENU** again to exit or back to parent menu.



Press **▼ / ▲** button to select among Menu Language / Transparent / OSD Timeout / Closed Caption / Over Scan / Input Label / Other settings / Restore Default / HDMI CEC / Voice Guidance / Video Description.
 Press **ENTER** or **▶** to enter.
 Press **◀ / ▶** button to adjust.
 Press **MENU** again to move back to parent menu.

Other Settings



HDMI CEC



Picture Menu

Press **MENU** to enter the main menu, Press ◀ / ▶ button to select Picture.
Press **ENTER** or ▼ to enter.
Press **MENU** again to exit or back to parent menu.



Press ▼ / ▲ button to select among Picture Mode / Brightness / Contrast / Color / Tint / Sharpness / Color Temperature / Advanced Settings.
Press **ENTER** or ▶ to enter.
Press ◀ / ▶ button to adjust.
Press **MENU** again to move back to parent menu.

Advanced Settings



Sound Menu

Press **MENU** to enter the main menu, Press ◀ / ▶ button to select Sound.

Press **ENTER** or ▼ to enter.

Press **MENU** again to exit or back to parent menu.



Press ▼ / ▲ button to select among Sound Mode/ Bass / Treble / Balance / Digital Audio Output/ Surround Sound / AVL / ZONE B Audio Mode.

Press **ENTER** or ▶ to enter.

Press ◀ / ▶ button to adjust.

Press **MENU** again to move back to parent menu.

Time Menu

Press **MENU** to enter the main menu, Press ◀ / ▶ button to select Time.
Press **ENTER** or ▼ to enter.
Press **MENU** again to exit or back to parent menu.



Press ▼ / ▲ button to select among Sleep Timer / Time Zone / Daylight Saving Time / Time Format / Auto Clock / Clock.
Press **ENTER** or ▶ to enter.
Press ◀ / ▶ button to adjust.
Press **MENU** again to move back to parent menu.

Lock Menu

Press **MENU** to enter the main menu, Press ◀ / ▶ button to select Lock.

Press **ENTER** or ▼ to enter.

Press **MENU** again to exit or back to parent menu.

Enter your 4- digital password. Default password is 0000, and if you forget what you set, please call the service center.



Press ▼ / ▲ button to select among Change Password / System Lock / Input Block / US Rating / Canada Rating / RRT Setting / Reset RRT.

Press **ENTER** or ▶ to enter.

Press ◀ / ▶ button to adjust.

Press **MENU** again to move back to parent menu.



Channel Menu

Press **MENU** to enter the main menu, Press ◀ / ▶ button to select Channel.
Press **ENTER** or ▼ to enter.
Press **MENU** again to exit or back to parent menu.



Press ▼ / ▲ button to select among Air/Cable / Auto Scan / Favorite/Channel List / Show/Hide / Channel Number / Channel Label .
Press **ENTER** or ▶ to enter.
Press ◀ / ▶ button to adjust.
Press **MENU** again to move back to parent menu.

Bluetooth

Press **Source** button on the remote or front panel,

Press **▼/▲** button on the remote or **<</>>** button on the front panel to choose the Bluetooth Source.

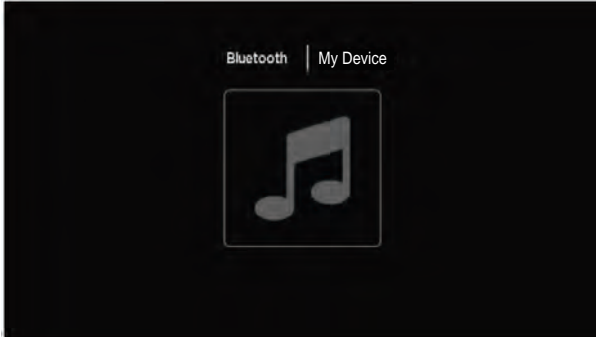

- Press **BT PAIR** button on the front panel or **BT PAIR** button on the remote to connect to a Bluetooth® compatible audio device. Follow pairing instructions on your device.
- Navigate your selections with **<</>>** button on the remote.
- Play/Pause selections with **▶||** button on the remote or front panel.
- Press **INFO** button to turn off the screen in Bluetooth Source.

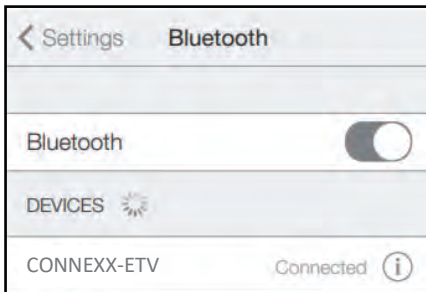

FM Radio

Press **Source** button on the remote or front panel.

Press **▼ / ▲** button on the remote or **◀ / ▶** button on the front panel to choose the FM Radio Source.

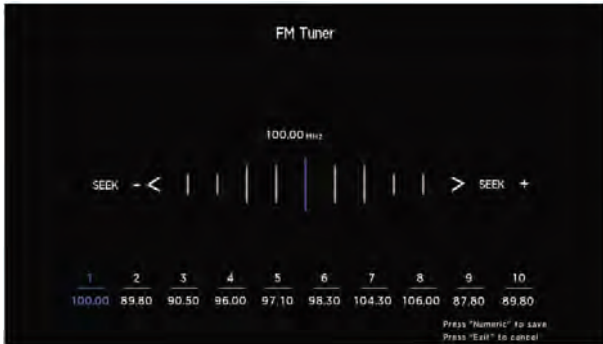

- Press **◀ / ▶** button on the front panel or **TUNE+** and **TUNE-** buttons on the remote to seek up and down radio stations. Press **◀ / ▶** button on the remote control for fine tuning.
- Press the **SET** button on the remote and one of the **0-9** numeric buttons to preset your radio station. Then press just one of the **0-9** buttons to recall your desired radio station preset.
- Play/Pause selections with **▶||** button on the remote or front panel.
- Press **INFO** button to turn off the screen in FM Radio Source.

Media

Note: Before operating Media menu, plug in USB device.
Press **Source** button on the remote or front panel,



Press ◀ / ▶ button on the remote to select the option Photo / Music / Text you want to adjust in the main **Media** menu, then press **Enter** button to enter.

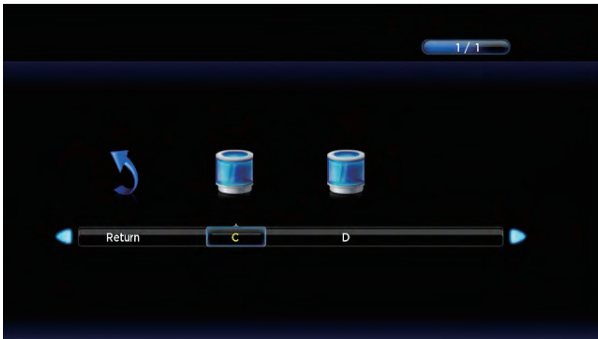

Media

Press ◀ / ▶ button to select USB Drive C or D then press **Enter** button to enter.

Note: Drive C is rear panel USB port, Drive D is front USB port.

Press **EXIT** button to return back to the previous menu.

Press ◀ / ▶ button to select drive you want to view, then press **Enter** button to enter.

Press ◀ / ▶ button to select return option to back to the previous menu or press **EXIT** button.



Press ◀ / ▶ button to select the file you want to view in the file selecting menu, then press **Enter** button to display picture.

When highlighting the option you select, the file information will appear on the right and picture will be previewed in the center.

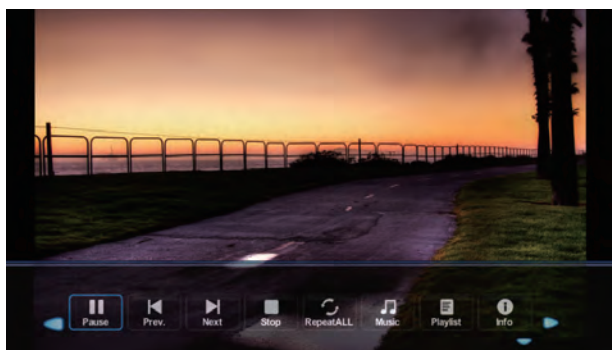

Press ◀ / ▶ button to navigate through options shown at bottom of screen, use these options to control how the photo slideshow is viewed.

Press **EXIT** button return back to main Media menu.

Media

Press ◀ / ▶ button to select MUSIC in the main menu, then press **Enter** button to enter.

Press **Menu** button to return back to the previous menu and exit menu to quit.

Press ◀ / ▶ button to select drive you want to play, then press **Enter** button to enter.

Press ◀ / ▶ button to select return option to back to the previous menu.



Press ◀ / ▶ button to select the file you want to play in the file selecting menu. When highlighting the option you select, the file information will appear on the right.

Press **Enter** button to play. Press **ENTER** button again to display and operate file details.

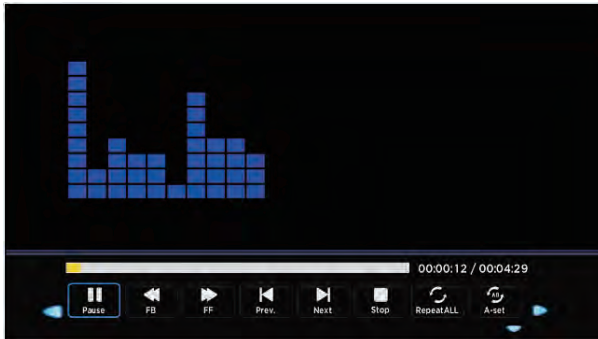

Press ◀ / ▶ button to select desired function in the bottom menu that you want to run, then press **Enter** button to operate.

Press **EXIT** button to move back to the previous menu.

Press ▼ button to hide the bottom menu.

Specifications

Picture & Sound

| Model | CX32A21ETVDC | CX40A21ETVDC | CX50A21ETVDC |
|------------------|----------------------|----------------------|----------------------|
| Panel Size | 32" | 40" | 50" |
| Panel Resolution | 1366×768 | 1920×1080 | 1920×1080 |
| Brightness | 220cd/m ² | 220cd/m ² | 250cd/m ² |
| Contrast Ratio | 3000:1 | 5000:1 | 5000:1 |
| Response Time | 8.5ms | 9.5ms | 9ms |
| View Angle | H:178°, V:178° | H:178°, V:178° | H:178°, V:178° |
| Display Type | D-LED | | |
| Aspect Ratio | 16:9 | | |

Input & Output

| | |
|---------------------|------------------|
| RF IN | 1 |
| USB | FRONT×1 & REAR×1 |
| OPTICAL OUT | 1 |
| SPEAKER OUT ZONE B | L(+/-) & R(+/-) |
| FM ANT | 1 |
| HDMI | FRONT×1 & REAR×2 |
| AV IN | 1 |
| COMPONENT(YPBPR) IN | 1 |
| LINE OUT | L & R |

USB Playback

| | |
|--------------------------|----------------|
| Output voltage / current | 5V / 500mA |
| USB standard | USB V2.0 |
| Photo playback format | JPEG, PNG, BMP |
| Music playback format | MP3, WAV |
| Text playback format | TXT |

General Specifications

| | | | |
|-----------------------|-------------------|---------------|----------------|
| Dimensions excl. base | 732×81×471mm | 907×81×555mm | 1131×101×697mm |
| Dimensions incl. base | 732×196×512mm | 907×211×598mm | 1131×236×750mm |
| Net Weight | 4.5kg | 6.1kg | 11.65kg |
| Wall Mount VESA | 200×100 | 200×200 | 200×200 |
| Power supply | DC 12V | | |
| Speaker Out Power | 2*20W@4Ω (ZONE B) | | |
| FM Frequency range | 87.5-107.9MHz | | |

Trouble Shooting

| Problem | Solution/Issue |
|--|---|
| TV does not operate | <p>Make sure the power cord is plugged in. Try another AC outlet. Power is off, check fuse or circuit breaker. Unplug unit for an hour, then plug it back in.</p> |
| Normal picture, but no sound | <p>Check the volume settings. Sound muted? Press MUTE button. Try another TV channel. Check audio cable connections.</p> |
| The remote control does not work | <p>Make sure the remote control is in range with no obstructions. Check the batteries.</p> |
| Poor sound or no sound | <p>Station or Cable TV experiencing problems, tune to another TV channel. Check sound adjustments (Volume or Mute). Check for sources of possible interference.</p> |
| Poor picture or no picture | <p>Station or Cable TV experiencing problems, tune to another TV channel. Make sure channels are set into memory. Perform Auto Scan, see channel menu. Check antenna or Cable TV connections, adjust antenna. Check for sources of possible interference. Check picture control adjustments.</p> |
| Poor TV reception | <p>Ensure the antenna amplifier is turned on for Antenna TV. Adjust the antenna position to a stronger signal receiving angle. Check the Antenna connection is tight to the TV. Check there is power supplied to the Antenna distribution box. Confirm your incoming cable is connected to the correct cable / antenna wall connection inside the RV. Ensure the internal RV coax jump cable is connected to the correct port.</p> |
| Poor Cable / Satellite TV Reception | <p>Ensure antenna amp is turned off for cable signal. Check incoming Cable is connected correctly to RV. Ensure cable splitter box has power. Confirm the incoming cable is connected to the correct cable / Satellite wall connection inside your RV. Ensure the internal RV coax jump cable is connected to the correct port. Check Dish has no obstruction.</p> |
| TV shuts off | <p>Sleep Timer is set. Power interrupted.</p> |
| TV AV input plays black and white | <p>Check RCA connections on the back of the TV and from the source to ensure they are connected to the correct connections. Ensure the yellow connection is in the correct port.</p> |

Customer Support

Warranty

Limited 1 Year Warranty

The Manufacturer warrants this product to be free from defects in workmanship and materials, under normal use and conditions, for a period of 1 year for parts and 90 days for labor from the original date of purchase. The Manufacturer agrees, at its option during the warranty period, to repair any defect in parts, material or workmanship, or to furnish a repaired or refurbished product of equal value in exchange without charge (except for a fee for shipping, handling, packing, return postage, and insurance which will be incurred by the customer). Such repair or replacement is subject to verification of the defect or malfunction and proof of purchase as confirmed by showing the model number on the original dated sales receipt. This warranty is **not transferable** to any person or entity other than the original purchaser, and does not cover the costs incurred from installation, removal, or reinstallation of the product.

The extent of the Manufacturer's liability under this warranty is limited to the repair or replacement provided above. In no event shall the Manufacturer's liability exceed the purchase price paid by the purchaser for the product.

Services provided under the terms of this warranty are your exclusive remedy.

Coverage Does NOT Include:

- Any product which has been subject to damage due to an act of God, misuse, neglect, accident, abuse, commercial use.
- Damage due to improper installation, operation or maintenance, or attempted repair by anyone other than the Manufacturer.
- Damage to external media devices such as DVDs, CDs, iPod, iPhone, MP3 players, and/or memory devices.
- Cosmetic damage, accidental damage, set-up adjustments, panel damage by non-moving images for a long period of time, connection to an improper voltage supply, modification of, or to, any part of the product.
- Re-manufactured units, product sold "As Is", or closeout product.
- The cost of shipping this product to the Service Center and its return to the owner.

Where is the Warranty Valid?

This warranty is valid only in the United States and Canada, and grants specific legal rights. You may also have other rights which vary from state to state.

How to Obtain Service

FOR WARRANTY SERVICE AND INSTRUCTIONS ON HOW TO RETURN YOUR PRODUCT CALL:

U.S.(800) 442-7717

International(574) 522-7781

Our technical support team is available Monday – Friday, 8 am to 5 pm EST

Please make sure to place the product in its original packaging, or packaging that provides the same amount of protection as the original packaging.

FCC Statement

This equipment has been tested and found to comply with the limits for a Class B digital device, pursuant to part 15 of the FCC Rules. These limits are designed to provide reasonable protection against harmful interference in a residential installation. This equipment generates, uses and can radiate radio frequency energy and, if not installed and used in accordance with the instructions, may cause harmful interference to radio communications. However, there is no guarantee that interference will not occur in a particular installation. If this equipment does cause harmful interference to radio or television reception, which can be determined by turning the equipment off and on, the user is encouraged to try to correct the interference by one or more of the following measures:

- Reorient or relocate the receiving antenna.
- Increase the separation between the equipment and receiver.
- Connect the equipment into an outlet on a circuit different from that to which the receiver is connected.
- Consult the dealer or an experienced radio/TV technician for help.

Changes or modifications not expressly approved by the party responsible for compliance could void the user's authority to operate the equipment.

RF Exposure Statement

The distance between user and products should be no less than 20cm.

River Park Inc.
21953 Protecta Drive | Elkhart, IN 46516
<http://www.riverparkinc.com>
U.S.(800) 442-7717
International(574) 522-7781