



**CFR 47 FCC PART 15 SUBPART C
ISED RSS-247 ISSUE 2**

TEST REPORT

For

Wireless Router

MODEL NUMBER: SR120-A

FCC ID: 2AV2N-SR120A

IC: 26145-SR120A

REPORT NUMBER: 4789430346-3

ISSUE DATE: May 20, 2020

Prepared for

**Fiberhome Telecommunication Technologies Co., Ltd.
No.88 Youkeyuan Road, Hongshan District, Wuhan, Hubei Province, P.R.China**

Prepared by

**UL Verification Services (Guangzhou) Co., Ltd, Song Shan Lake Branch
Building 10, Innovation Technology Park, No. 1, Li Bin Road, Song Shan Lake Hi-
Tech Development Zone Dongguan, People's Republic of China
Tel: +86 769 22038881
Fax: +86 769 33244054
Website: www.ul.com**



Revision History

Rev.	Issue Date	Revisions	Revised By
V0	5/20/2020	Initial Issue	



Summary of Test Results			
Clause	Test Items	FCC/ISED Rules	Test Results
1	6dB Bandwidth and 99% Occupied Bandwidth	FCC Part 15.247 (a) (2) RSS-247 Clause 5.2 (a) ISED RSS-Gen Clause 6.7	Pass
2	Peak Conducted Output Power	FCC Part 15.247 (b) (3) RSS-247 Clause 5.4 (d)	Pass
3	Power Spectral Density	FCC Part 15.247 (e) RSS-247 Clause 5.2 (b)	Pass
4	Conducted Bandedge and Spurious Emission	FCC Part 15.247 (d) RSS-247 Clause 5.5	Pass
5	Radiated Bandedge and Spurious Emission	FCC Part 15.247 (d) FCC Part 15.209 FCC Part 15.205 RSS-247 Clause 5.5 RSS-GEN Clause 8.9	Pass
6	Conducted Emission Test For AC Power Port	FCC Part 15.207 RSS-GEN Clause 8.8	Pass
7	Antenna Requirement	FCC Part 15.203 RSS-GEN Clause 6.8	Pass
Note: 1. This test report is only published to and used by the applicant, and it is not for evidence purpose in China. 2. The measurement result for the sample received is <Pass> according to < CFR 47 FCC PART 15 SUBPART C >< ISED RSS-247 > when <Accuracy Method> decision rule is applied.			



TABLE OF CONTENTS

1. ATTESTATION OF TEST RESULTS	6
2. TEST METHODOLOGY	7
3. FACILITIES AND ACCREDITATION	7
4. CALIBRATION AND UNCERTAINTY	8
4.1. <i>MEASURING INSTRUMENT CALIBRATION</i>	<i>8</i>
4.2. <i>MEASUREMENT UNCERTAINTY.....</i>	<i>8</i>
5. EQUIPMENT UNDER TEST	9
5.1. <i>DESCRIPTION OF EUT</i>	<i>9</i>
5.2. <i>MAXIMUM OUTPUT POWER.....</i>	<i>9</i>
5.3. <i>CHANNEL LIST.....</i>	<i>9</i>
5.4. <i>TEST CHANNEL CONFIGURATION.....</i>	<i>9</i>
5.5. <i>THE WORSE CASE POWER SETTING PARAMETER.....</i>	<i>10</i>
5.6. <i>THE WORSE CASE CONFIGURATIONS</i>	<i>10</i>
5.7. <i>DESCRIPTION OF AVAILABLE ANTENNAS</i>	<i>11</i>
5.8. <i>TEST ENVIRONMENT</i>	<i>11</i>
5.9. <i>DESCRIPTION OF TEST SETUP.....</i>	<i>12</i>
6. MEASURING INSTRUMENT AND SOFTWARE USED	13
7. ANTENNA PORT TEST RESULTS	14
7.1. <i>ON TIME AND DUTY CYCLE.....</i>	<i>14</i>
7.2. <i>6 dB DTS BANDWIDTH AND 99% OCCUPIED BANDWIDTH</i>	<i>17</i>
7.3. <i>CONDUCTED AVERAGE OUTPUT POWER.....</i>	<i>19</i>
7.3.1. <i>802.11b MIMO MODE</i>	<i>20</i>
7.3.2. <i>802.11g MIMO MODE</i>	<i>20</i>
7.3.3. <i>802.11n HT20 MIMO MODE.....</i>	<i>20</i>
7.3.4. <i>802.11n HT40 MIMO MODE.....</i>	<i>20</i>
7.4. <i>POWER SPECTRAL DENSITY.....</i>	<i>21</i>
7.5. <i>CONDUCTED BANDEDGE AND SPURIOUS EMISSIONS.....</i>	<i>23</i>
8. RADIATED TEST RESULTS.....	25
8.1. <i>RESTRICTED BANDEDGE.....</i>	<i>32</i>
8.1.1. <i>802.11b MIMO MODE</i>	<i>32</i>
8.1.2. <i>802.11g MIMO MODE</i>	<i>38</i>
8.1.3. <i>802.11n HT20 MIMO MODE.....</i>	<i>45</i>
8.1.4. <i>802.11n HT40 MIMO MODE.....</i>	<i>52</i>
8.2. <i>SPURIOUS EMISSIONS (1~3GHz).....</i>	<i>59</i>
8.2.1. <i>802.11b MIMO MODE</i>	<i>59</i>



8.2.2.	802.11g MIMO MODE	65
8.2.3.	802.11n HT20 MIMO MODE	71
8.2.4.	802.11n HT40 MIMO MODE	77
8.3.	<i>SPURIOUS EMISSIONS (3~18GHz)</i>	83
8.3.1.	802.11b MIMO MODE	83
8.3.2.	802.11g MIMO MODE	89
8.3.3.	802.11n HT20 MIMO MODE	95
8.3.4.	802.11n HT40 MIMO MODE	101
8.4.	<i>SPURIOUS EMISSIONS (18~26GHz)</i>	107
8.4.1.	802.11b MIMO MODE	107
8.5.	<i>SPURIOUS EMISSIONS (0.03 ~ 1 GHz)</i>	109
8.5.1.	802.11b MIMO MODE	109
8.6.	<i>SPURIOUS EMISSIONS BELOW 30M</i>	111
8.6.1.	802.11b MIMO MODE	111
9.	AC POWER LINE CONDUCTED EMISSIONS	114
9.1.	802.11b MIMO MODE	115
10.	ANTENNA REQUIREMENTS	117
11.	APPENDIX	118
11.1.	<i>APPENDIX A: DTS BANDWIDTH</i>	118
11.1.1.	TEST RESULT	118
11.1.2.	TEST GRAPHS	119
11.2.	<i>APPENDIX B: OCCUPIED CHANNEL BANDWIDTH</i>	131
11.2.1.	TEST RESULT	131
11.2.2.	TEST GRAPHS	132
11.3.	<i>APPENDIX D: MAXIMUM POWER SPECTRAL DENSITY</i>	144
11.3.1.	TEST RESULT	144
11.3.2.	TEST GRAPHS	145
11.4.	<i>APPENDIX E: BAND EDGE MEASUREMENTS</i>	157
11.4.1.	TEST RESULT	157
11.4.2.	TEST GRAPHS	158
11.5.	<i>APPENDIX F: CONDUCTED SPURIOUS EMISSION</i>	166
11.5.1.	TEST RESULT	166
11.5.2.	TEST GRAPHS	168



1. ATTESTATION OF TEST RESULTS

Applicant Information

Company Name: Fiberhome Telecommunication Technologies Co., Ltd.
Address: No.88 Youkeyuan Road, Hongshan District, Wuhan, Hubei Province, P.R.China

Manufacturer Information

Company Name: Fiberhome Telecommunication Technologies Co., Ltd.
Address: No.88 Youkeyuan Road, Hongshan District, Wuhan, Hubei Province, P.R.China

EUT Description

EUT Name: Wireless Router
Model: SR120-A
Brand: FiberHome
Sample Status: Normal
Sample ID: 2978107
Sample Received Date: March 25, 2020
Date of Tested: March 26, 2020 ~ May 20, 2020

APPLICABLE STANDARDS	
STANDARD	TEST RESULTS
CFR 47 FCC PART 15 SUBPART C	PASS
ISED RSS-247 Issue 2	PASS
ISED RSS-GEN Issue 5	PASS

Prepared By:

Denny Huang
Project Engineer

Checked By:

Shawn Wen
Laboratory Leader

Approved By:

Stephen Guo
Laboratory Manager



2. TEST METHODOLOGY

The tests documented in this report were performed in accordance with KDB 558074 D01 15.247 Meas Guidance v05r02, KDB 414788 D01 Radiated Test Site v01r01, CFR 47 FCC Part 2, CFR 47 FCC Part 15, ANSI C63.10-2013, ISED RSS-247 Issue 2 and ISED RSS-GEN Issue 5.

3. FACILITIES AND ACCREDITATION

Accreditation Certificate	<p>A2LA (Certificate No.: 4102.01) UL Verification Services (Guangzhou) Co., Ltd. Song Shan Lake Branch. has been assessed and proved to be in compliance with A2LA.</p> <p>FCC (FCC Designation No.: CN1187) UL Verification Services (Guangzhou) Co., Ltd. Song Shan Lake Branch. Has been recognized to perform compliance testing on equipment subject to the Commission's Declaration of Conformity (DoC) and Certification rules</p> <p>ISED(Company No.: 21320) UL Verification Services (Guangzhou) Co., Ltd. Song Shan Lake Branch. has been registered and fully described in a report filed with ISED. The Company Number is 21320.</p> <p>VCCI (Registration No.: G-20019, R-20004, C-20012 and T-20011) UL Verification Services (Guangzhou) Co., Ltd. Song Shan Lake Branch. has been assessed and proved to be in compliance with VCCI, the Membership No. is 3793. Facility Name: Chamber D, the VCCI registration No. is G-20019 and R-20004 Shielding Room B , the VCCI registration No. is C-20012 and T-20011</p>
---------------------------	---

Note 1: All tests measurement facilities use to collect the measurement data are located at Building 10, Innovation Technology Park, Song Shan Lake Hi tech Development Zone, Dongguan, 523808, China

Note 2: The test anechoic chamber in UL Verification Services (Guangzhou) Co., Ltd. Song Shan Lake Branch had been calibrated and compared to the open field sites and the test anechoic chamber is shown to be equivalent to or worst case from the open field site.

Note 3: For below 30MHz, lab had performed measurements at test anechoic chamber and comparing to measurements obtained on an open field site. And these measurements below 30MHz had been correlated to measurements performed on an OFS.



4. CALIBRATION AND UNCERTAINTY

4.1. MEASURING INSTRUMENT CALIBRATION

The measuring equipment utilized to perform the tests documented in this report has been calibrated in accordance with the manufacturer's recommendations, and is traceable to recognize national standards.

4.2. MEASUREMENT UNCERTAINTY

Where relevant, the following measurement uncertainty levels have been estimated for tests performed on the apparatus:

Test Item	Uncertainty
Conduction Emission	3.62dB
Radiation Emission Test (Include Fundamental Emission) (9kHz-30MHz)	2.2dB
Radiation Emission Test (Include Fundamental Emission) (30MHz-1GHz)	4.00dB
Radiation Emission Test (1GHz to 26GHz) (Include Fundamental Emission)	5.78dB (1GHz-18GHz)
	5.23dB (18GHz-26GHz)

Note: This uncertainty represents an expanded uncertainty expressed at approximately the 95% confidence level using a coverage factor of k=2.



5. EQUIPMENT UNDER TEST

5.1. DESCRIPTION OF EUT

EUT Name	Wireless Router
Model	SR120-A
Radio Technology	IEEE802.11b/g/n HT20/n HT40
Operation frequency	IEEE 802.11b: 2412MHz—2462MHz IEEE 802.11g: 2412MHz—2462MHz IEEE 802.11n HT20: 2412MHz—2462MHz IEEE 802.11n HT40: 2422MHz—2452MHz
Modulation	IEEE 802.11b: DSSS(CCK) IEEE 802.11g: OFDM (64QAM, 16QAM, QPSK, BPSK) IEEE 802.11n HT20: OFDM (64QAM, 16QAM, QPSK, BPSK) IEEE 802.11n HT40: OFDM (64QAM, 16QAM, QPSK, BPSK)
Rate Input:	AC 100V ~ 240V, 50Hz ~ 60Hz
Rate Output:	DC 12V, 1A

5.2. MAXIMUM OUTPUT POWER

Number of Transmit Chains (NTX)	IEE Std. 802.11	Frequency (MHz)	Channel Number	Max AV Conducted Power (dBm)
2	IEEE 802.11b	2412-2462	1-11[11]	20.02
2	IEEE 802.11g	2412-2462	1-11[11]	19.45
2	IEEE 802.11nHT20	2412-2462	1-11[11]	19.72
2	IEEE 802.11nHT40	2422-2452	3-9[7]	19.42

5.3. CHANNEL LIST

Channel List for 802.11b/g/n							
Channel	Frequency (MHz)	Channel	Frequency (MHz)	Channel	Frequency (MHz)	Channel	Frequency (MHz)
1	2412	4	2427	7	2442	10	2457
2	2417	5	2432	8	2447	11	2462
3	2422	6	2437	9	2452	/	/

5.4. TEST CHANNEL CONFIGURATION

Test Mode	Test Channel	Frequency
WiFi TX (802.11b)	CH1, CH6, CH11/ Low, Middle, High	2412MHz, 2437MHz, 2462MHz
WiFi TX (802.11g)	CH1, CH6, CH11/ Low, Middle, High	2412MHz, 2437MHz, 2462MHz
WiFi TX (802.11n HT20)	CH1, CH6, CH11/ Low, Middle, High	2412MHz, 2437MHz, 2462MHz
WiFi TX (802.11n HT40)	CH3, CH6, CH9/ Low, Middle, High	2422MHz, 2437MHz, 2452MHz



5.5. THE WORSE CASE POWER SETTING PARAMETER

The Worst Case Power Setting Parameter under 2400 ~ 2483.5MHz Band							
Test Software		MP_TEST					
IEEE Std. 802.11	Transmit Antenna Number	Test Software Setting Value					
		NCB: 20MHz			NCB: 40MHz		
		CH 1	CH 7	CH 11	CH 3	CH 7	CH 9
b	1	24	25	27	/		
b	2	21	21	21			
g	1	34	36	38			
g	2	29	30	31			
n HT20	1	35	36	38			
n HT20	2	30	31	32			
n HT40	1	/			35	36	37
n HT40	2	/			30	31	31

5.6. THE WORSE CASE CONFIGURATIONS

For SISO modes, there are two transmission antennas. The antenna used in any given time can be either ANTENNA 1 or ANTENNA 2. The output power measurement for SISO modes on both antennas are reported.

For 2TX MIMO modes, ANTENNA 1 and ANTENNA 2, used at the same time.

Worst-case data rates as provided by the client were:

- 802.11b mode: 1 Mbps
- 802.11g mode: 6 Mbps
- 802.11n HT20 mode: MCS0
- 802.11n HT40 mode: MCS0

Both the SISO mode and MIMO mode are use the same power setting, only the worst data (MIMO mode) was recorded in this report

Both the STBC mode and MIMO mode are use the same power setting, only the worst data (MIMO mode) was recorded in this report.

The 2.4G beamforming function is enabled by test program, the carrier wave will be under radio chip phase control and sent to the antennas through the test program.

**5.7. DESCRIPTION OF AVAILABLE ANTENNAS**

Antenna	Frequency (MHz)	Antenna Type	MAX Antenna Gain (dBi)
1	2412-2462	External Antenna	4.64
2	2412-2462	External Antenna	5.30

Test Mode	Transmit and Receive Mode	Description
IEEE 802.11b	<input checked="" type="checkbox"/> 2TX, 2RX	ANT 1,2 can be used as transmitting/receiving antenna.
IEEE 802.11g	<input checked="" type="checkbox"/> 2TX, 2RX	ANT 1,2 can be used as transmitting/receiving antenna.
IEEE 802.11n HT20	<input checked="" type="checkbox"/> 2TX, 2RX	ANT 1,2 can be used as transmitting/receiving antenna.
IEEE 802.11n HT40	<input checked="" type="checkbox"/> 2TX, 2RX	ANT 1,2 can be used as transmitting/receiving antenna.

Note: MIMO with beamforming gain= $10 \cdot \log [(10 \cdot G3/20 + 10 \cdot G4/20)^2/2] = 8\text{dBi}$

5.8. TEST ENVIRONMENT

Environment Parameter	Selected Values During Tests	
Relative Humidity	45 ~ 70%	
Atmospheric Pressure:	101kPa	
Temperature	TN	22 ~ 28 °C
Voltage:	VL	/
	VN	DC 12V
	VH	/

Note: VL= Lower Extreme Test Voltage
 VN= Nominal Voltage.
 VH= Upper Extreme Test Voltage
 TN= Normal Temperature

5.9. DESCRIPTION OF TEST SETUP

SUPPORT EQUIPMENT

Item	Equipment	Brand Name	Model Name	P/N
1	Laptop	ThinkPad	T460S	SL10K24796 JS

I/O CABLES

Cable No	Port	Connector Type	Cable Type	Cable Length(m)	Remarks
1	WLAN	RJ45	Unshielded	1.5	/
2	LAN	RJ45	Unshielded	1.5	/
3	LAN	RJ45	Unshielded	1.5	/
4	LAN	RJ45	Unshielded	1.5	/
5	LAN	RJ45	Unshielded	1.5	/

ACCESSORIES

Item	Accessory	Brand Name	Model Name	Description
1	POWER ADAPTER	Fiberhome	RD1201000-C55-91MG	Input: AC 100 ~ 200V, 50/60Hz, 6.6A MAX Output: DC 12V, 1A

TEST SETUP

The EUT can work in engineering mode with a software through a Laptop.

SETUP DIAGRAM FOR TESTS

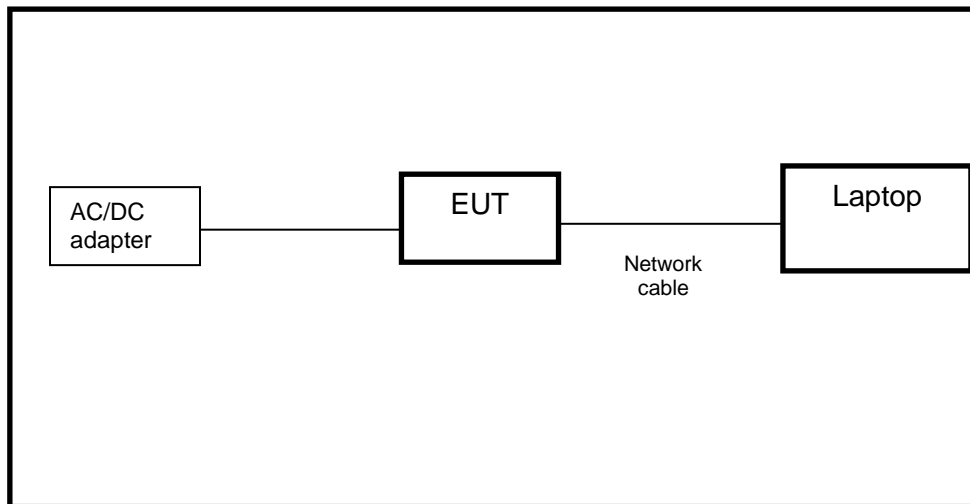

**6. MEASURING INSTRUMENT AND SOFTWARE USED**

Conducted Emissions						
Instrument						
Used	Equipment	Manufacturer	Model No.	Serial No.	Last Cal.	Next Cal.
<input checked="" type="checkbox"/>	EMI Test Receiver	R&S	ESR3	101961	Dec.05,2019	Dec.05,2020
<input checked="" type="checkbox"/>	Two-Line V- Network	R&S	ENV216	101983	Dec.05,2019	Dec.05,2020
<input checked="" type="checkbox"/>	Artificial Mains Networks	Schwarzbeck	NSLK 8126	8126465	Dec.05,2019	Dec.05,2020
Software						
Used	Description			Manufacturer	Name	Version
<input checked="" type="checkbox"/>	Test Software for Conducted disturbance			Farad	EZ-EMC	Ver. UL-3A1
Radiated Emissions						
Instrument						
Used	Equipment	Manufacturer	Model No.	Serial No.	Last Cal.	Next Cal.
<input checked="" type="checkbox"/>	MXE EMI Receiver	KESIGHT	N9038A	MY56400036	Dec.06,2019	Dec.05,2020
<input checked="" type="checkbox"/>	Hybrid Log Periodic Antenna	TDK	HLP-3003C	130960	Sep.17,2018	Sep.17,2021
<input checked="" type="checkbox"/>	Preamplifier	HP	8447D	2944A09099	Dec.05,2019	Dec.05,2020
<input checked="" type="checkbox"/>	EMI Measurement Receiver	R&S	ESR26	101377	Dec.05,2019	Dec.05,2020
<input checked="" type="checkbox"/>	Horn Antenna	TDK	HRN-0118	130939	Sep.17,2018	Sep.17,2021
<input checked="" type="checkbox"/>	High Gain Horn Antenna	Schwarzbeck	BBHA-9170	691	Aug.11,2018	Aug.11,2021
<input checked="" type="checkbox"/>	Preamplifier	TDK	PA-02-0118	TRS-305- 00067	Dec.05,2019	Dec.05,2020
<input checked="" type="checkbox"/>	Preamplifier	TDK	PA-02-2	TRS-307- 00003	Dec.05,2019	Dec.05,2020
<input checked="" type="checkbox"/>	Loop antenna	Schwarzbeck	1519B	00008	Jan.07,2019	Jan.07,2022
<input checked="" type="checkbox"/>	Band Reject Filter	Wainwright	WRCJV8-2350-2400- 2483.5-2533.5-40SS	4	Dec.05,2019	Dec.05,2020
<input checked="" type="checkbox"/>	High Pass Filter	Wi	WHKX10-2700-3000- 18000-40SS	23	Dec.05,2019	Dec.05,2020
Software						
Used	Description			Manufacturer	Name	Version
<input checked="" type="checkbox"/>	Test Software for Radiated disturbance			Farad	EZ-EMC	Ver. UL-3A1
Other instruments						
Used	Equipment	Manufacturer	Model No.	Serial No.	Last Cal.	Next Cal.
<input checked="" type="checkbox"/>	Spectrum Analyzer	Keysight	N9030A	MY55410512	Dec.06,2019	Dec.05,2020
<input checked="" type="checkbox"/>	Power sensor, Power Meter	R&S	OSP120	100921	Dec.06,2019	Dec.06,2020

7. ANTENNA PORT TEST RESULTS

7.1. ON TIME AND DUTY CYCLE

LIMITS

None; for reporting purposes only

PROCEDURE

KDB 558074 Zero-Span Spectrum Analyzer Method

TEST SETUP

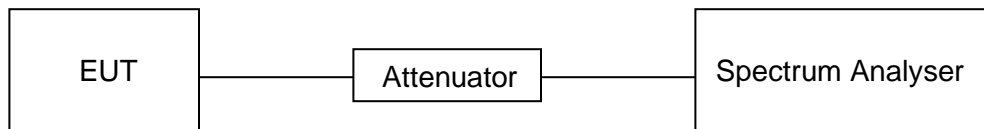

TEST ENVIRONMENT

Temperature	24.9°C	Relative Humidity	59%
Atmosphere Pressure	101kPa	Test Voltage	DC 5V

RESULTS

Mode	On Time (msec)	Period (msec)	Duty Cycle x (Linear)	Duty Cycle (%)	Duty Cycle Correction Factor (dB)	1/T Minimum VBW (KHz)	Final setting For VBW (KHz)
11b	100	100	1.0	100%	0	0.01	0.01
11g	100	100	1.0	100%	0	0.01	0.01
11n HT20	100	100	1.0	100%	0	0.01	0.01
11n HT40	100	100	1.0	100%	0	0.01	0.01

Note:

Duty Cycle Correction Factor=10log (1/x).

Where: x is Duty Cycle (Linear)

Where: T is On Time

If that calculated VBW is not available on the analyzer then the next higher value should be used.

For mode 11b, the duty cycle is greater than 98%, so it can set VBW to 10Hz.

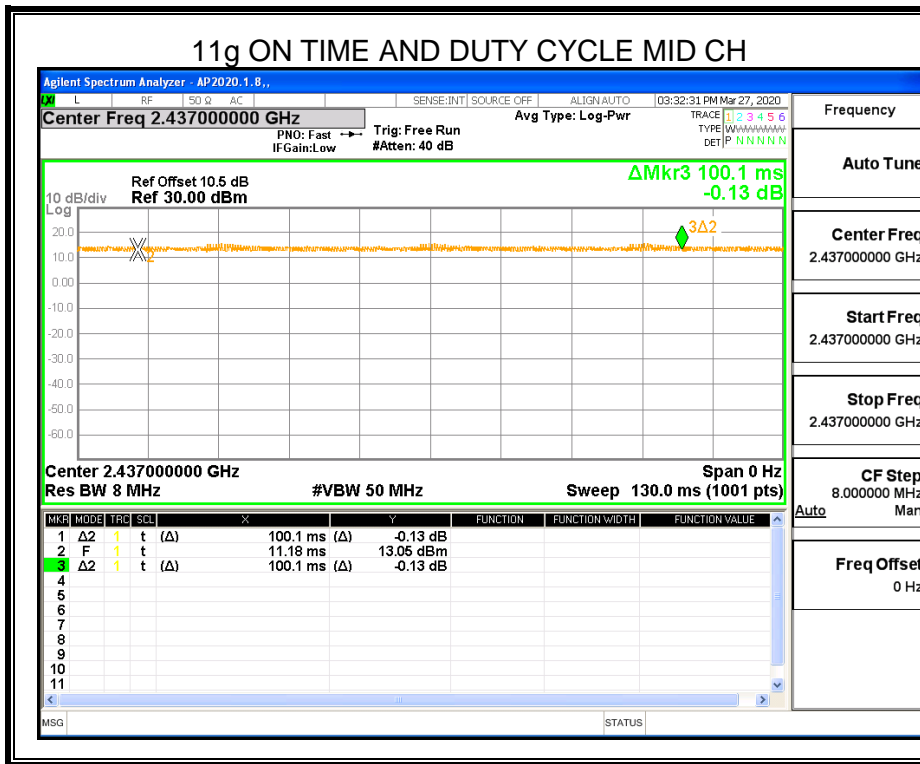
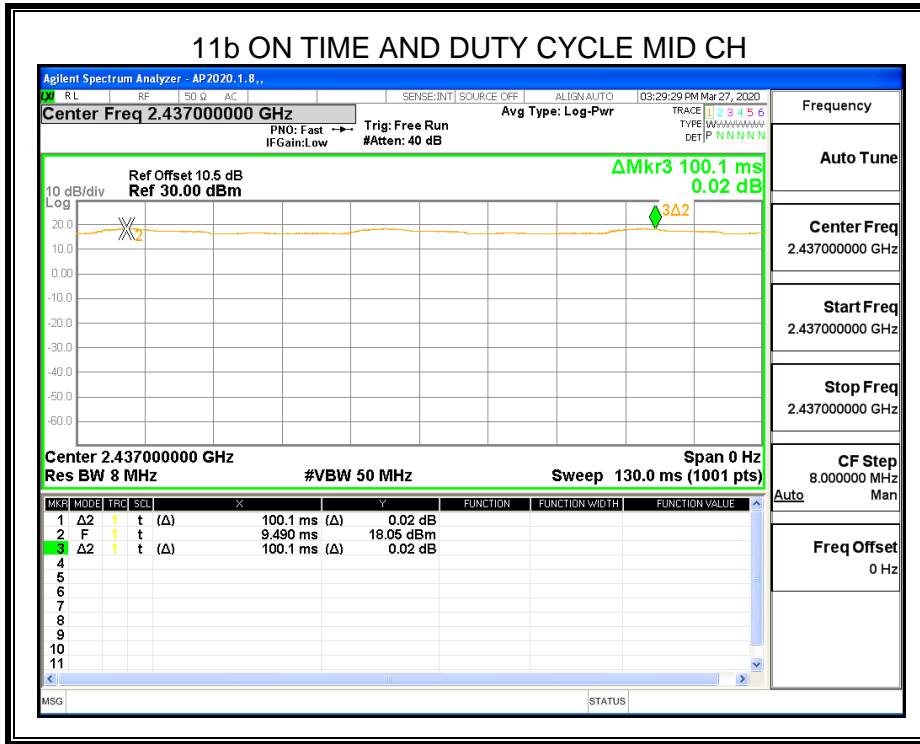

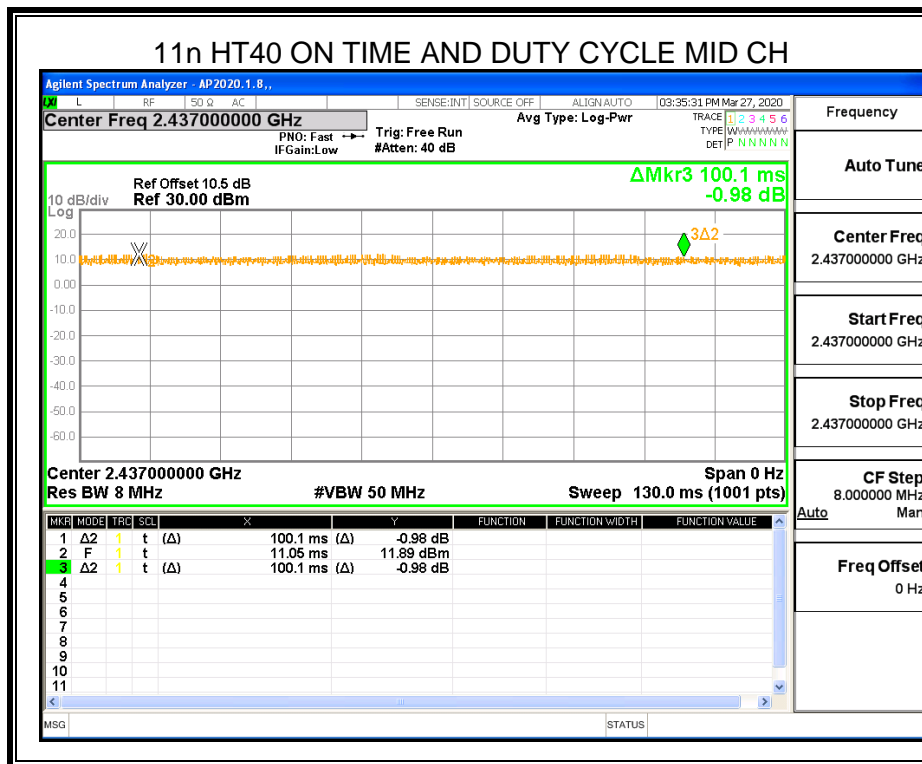
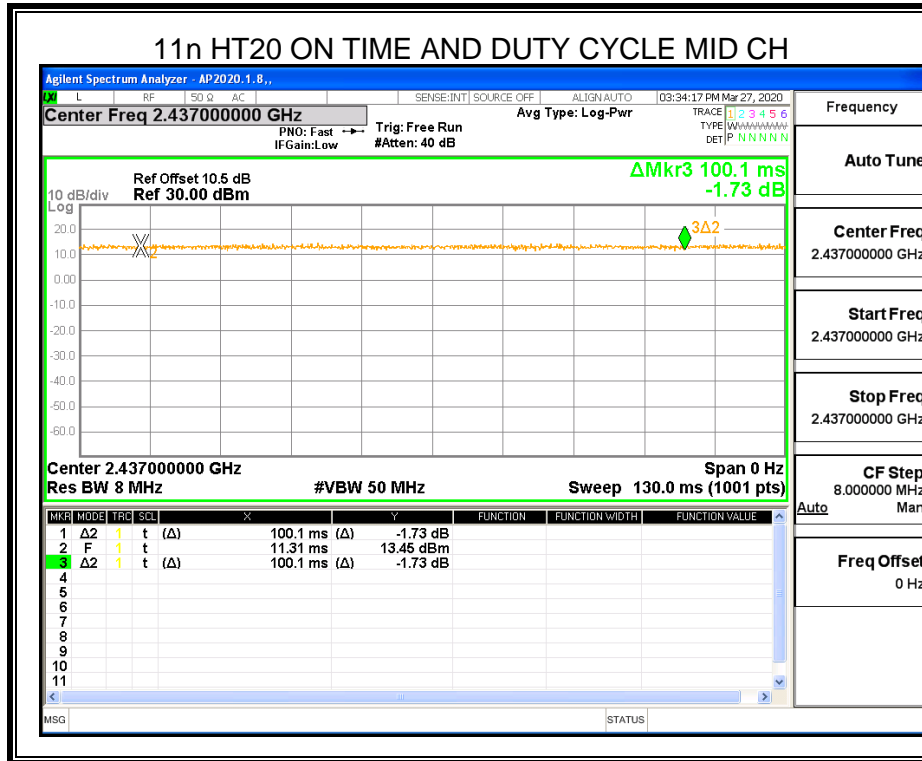

7.2. 6 dB DTS BANDWIDTH AND 99% OCCUPIED BANDWIDTH

LIMITS

CFR 47 FCC Part15 (15.247) Subpart C ISED RSS-247 ISSUE 2			
Section	Test Item	Limit	Frequency Range (MHz)
CFR 47 FCC 15.247(a)(2) ISED RSS-247 5.2 (a)	6 dB Bandwidth	≥ 500KHz	2400-2483.5
ISED RSS-Gen Clause 6.7	99% Occupied Bandwidth	For reporting purposes only.	2400-2483.5

TEST PROCEDURE

Connect the UUT to the spectrum analyser and use the following settings:

Center Frequency	The centre frequency of the channel under test
Detector	Peak
RBW	For 6dB Bandwidth :100kHz For 99% Occupied Bandwidth :1% to 5% of the occupied bandwidth
VBW	For 6dB Bandwidth: $\geq 3 \times \text{RBW}$ For 99% Occupied Bandwidth: $\geq 3 \times \text{RBW}$
Trace	Max hold
Sweep	Auto couple

Allow the trace to stabilize and measure the maximum width of the emission that is constrained by the frequencies associated with the two outermost amplitude points (upper and lower frequencies) that are attenuated by 6 dB and 99% relative to the maximum level measured in the fundamental emission.

TEST SETUP

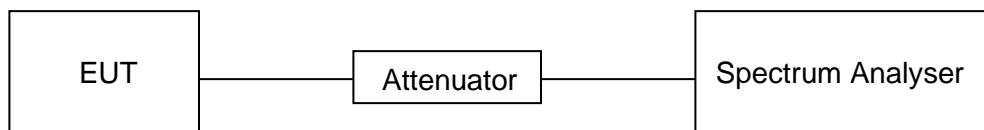



TEST ENVIRONMENT

Temperature	24.9°C	Relative Humidity	59%
Atmosphere Pressure	101kPa	Test Voltage	DC 12V

RESULTS

Please refer to appendix A and B.



7.3. CONDUCTED AVERAGE OUTPUT POWER

LIMITS

CFR 47 FCC Part15 (15.247) Subpart C ISED RSS-247 ISSUE 2			
Section	Test Item	Limit	Frequency Range (MHz)
CFR 47 FCC 15.247(b)(3) ISED RSS-247 5.4 (d)	Peak Output Power	1 watt or 30dBm	2400-2483.5

TEST PROCEDURE

Place the EUT on the table and set it in the transmitting mode.
Remove the antenna from the EUT and then connect a low loss RF cable from the antenna port to the Power sensor.
Measure the power of each channel.
Peak Detector use for Peak result.
AVG Detector use for AVG result.

TEST SETUP

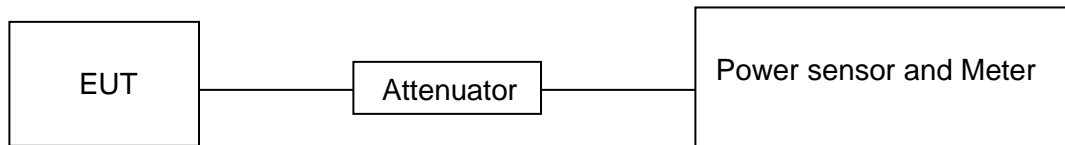

TEST ENVIRONMENT

Temperature	24.9°C	Relative Humidity	59%
Atmosphere Pressure	101kPa	Test Voltage	DC 12V

RESULTS

**7.3.1. 802.11b MIMO MODE**

Frequency (MHz)	ANT	Maximum AV Conducted Output Power (dBm)		Limit	Result
		Single	Total		
Low	0	16.95	19.92	29.4	PASS
	1	16.87			
Middle	0	16.90	20.02		
	1	17.11			
High	0	16.93	19.85		
	1	16.74			

7.3.2. 802.11g MIMO MODE

Frequency (MHz)	ANT	Maximum AV Conducted Output Power (dBm)		Limit	Result
		Single	Total		
Low	0	16.30	19.45	29.4	PASS
	1	16.57			
Middle	0	16.51	19.37		
	1	16.21			
High	0	16.52	19.36		
	1	16.18			

7.3.3. 802.11n HT20 MIMO MODE

Frequency (MHz)	ANT	Maximum AV Conducted Output Power (dBm)		Limit	Result
		Single	Total		
Low	0	16.66	19.53	29.4	PASS
	1	16.38			
Middle	0	16.53	19.58		
	1	16.61			
High	0	16.74	19.72		
	1	16.67			

7.3.4. 802.11n HT40 MIMO MODE

Frequency (MHz)	ANT	Maximum AV Conducted Output Power (dBm)		Limit	Result
		Single	Total		
Low	0	16.22	19.27	29.4	PASS
	1	16.30			
Middle	0	16.23	19.42		
	1	16.59			
High	0	16.12	19.23		
	1	16.31			

7.4. POWER SPECTRAL DENSITY

LIMITS

CFR 47 FCC Part15 (15.247) Subpart C ISED RSS-247 ISSUE 2			
Section	Test Item	Limit	Frequency Range (MHz)
CFR 47 FCC §15.247 (e) ISED RSS-247 5.2 (b)	Power Spectral Density	8 dBm/3 kHz	2400-2483.5

TEST PROCEDURE

Connect the UUT to the spectrum analyser and use the following settings:

Center Frequency	The centre frequency of the channel under test
Detector	Peak
RBW	$3 \text{ kHz} \leq \text{RBW} \leq 100 \text{ kHz}$
VBW	$\geq 3 \times \text{RBW}$
Span	1.5 x DTS bandwidth
Trace	Max hold
Sweep time	Auto couple.

Allow trace to fully stabilize and use the peak marker function to determine the maximum amplitude level within the RBW.

If measured value exceeds limit, reduce RBW (no less than 3 kHz) and repeat.

TEST SETUP

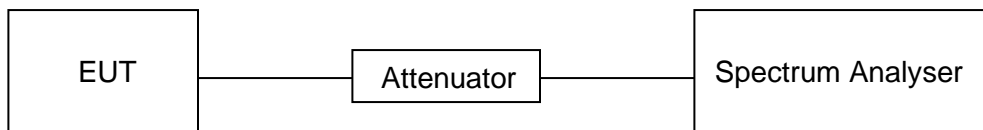

TEST ENVIRONMENT

Temperature	24.9°C	Relative Humidity	59%
Atmosphere Pressure	101kPa	Test Voltage	DC 12V



RESULTS

Please refer to appendix D.



7.5. CONDUCTED BANDEGE AND SPURIOUS EMISSIONS

LIMITS

CFR 47 FCC Part15 (15.247) Subpart C ISED RSS-247 ISSUE 2		
Section	Test Item	Limit
CFR 47 FCC §15.247 (d) ISED RSS-247 5.5	Conducted Bandedge and Spurious Emissions	at least 30 dB below that in the 100 kHz bandwidth within the band that contains the highest level of the desired power

Notes: The display line is placed at -20dBc but all emissions outside of the band meet the -30dBc limit.

TEST PROCEDURE

Connect the UUT to the spectrum analyser and use the following settings:

Center Frequency	The centre frequency of the channel under test
Detector	Peak
RBW	100kHz
VBW	$\geq 3 \times \text{RBW}$
Span	1.5 x DTS bandwidth
Trace	Max hold
Sweep time	Auto couple.

Use the peak marker function to determine the maximum PSD level.

Span	Set the center frequency and span to encompass frequency range to be measured
Detector	Peak
RBW	100kHz
VBW	$\geq 3 \times \text{RBW}$
measurement points	$\geq \text{span}/\text{RBW}$
Trace	Max hold
Sweep time	Auto couple.

Use the peak marker function to determine the maximum amplitude level.

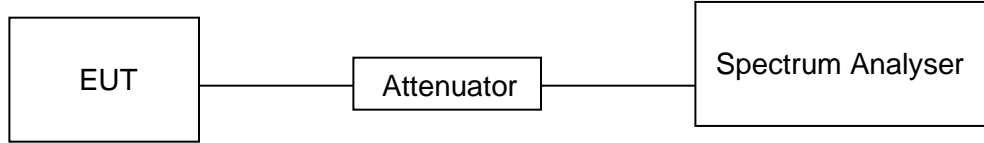
TEST SETUP**TEST ENVIRONMENT**

Temperature	24.9°C	Relative Humidity	59%
Atmosphere Pressure	101kPa	Test Voltage	DC 12V

RESULTS

Please refer to appendix E and F.



8. RADIATED TEST RESULTS

LIMITS

Please refer to CFR 47 FCC §15.205 and §15.209

Please refer to ISED RSS-GEN Clause 8.9 (Transmitter)

Radiation Disturbance Test Limit for FCC (Class B) (9KHz-1GHz)

Frequency (MHz)	Field Strength (microvolts/meter)	Measurement Distance (meters)
0.009~0.490	2400/F(KHz)	300
0.490~1.705	24000/F(KHz)	30
1.705~30.0	30	30
30~88	100	3
88~216	150	3
216~960	200	3
960~1000	500	3

Note: 1) At frequencies at or above 30 MHz, measurements may be performed at a distance other than what is specified provided: measurements are not made in the near field except where it can be shown that near field measurements are appropriate due to the characteristics of the device; and it can be demonstrated that the signal levels needed to be measured at the distance employed can be detected by the measurement equipment. Measurements shall not be performed at a distance greater than 30 meters unless it can be further demonstrated that measurements at a distance of 30 meters or less are impractical. When performing measurements at a distance other than that specified, the results shall be extrapolated to the specified distance using an extrapolation factor of 20 dB/decade (inverse linear-distance for field strength measurements; inverse-linear-distance-squared for power density measurements).

(2) At frequencies below 30 MHz, measurements may be performed at a distance closer than that specified in the regulations; however, an attempt should be made to avoid making measurements in the near field. Pending the development of an appropriate measurement procedure for measurements performed below 30 MHz, when performing measurements at a closer distance than specified, the results shall be extrapolated to the specified distance by either making measurements at a minimum of two distances on at least one radial to determine the proper extrapolation factor or by using the square of an inverse linear distance extrapolation factor (40 dB/decade). This paragraph (f) shall not apply to Access BPL devices operating below 30 MHz.

Radiation Disturbance Test Limit for FCC (Above 1G)

Frequency (MHz)	dB(uV/m) (at 3 meters)	
	Peak	Average
Above 1000	74	54



ISED General field strength limits at frequencies below 30 MHz

Table 6 – General field strength limits at frequencies below 30 MHz		
Frequency	Magnetic field strength (H-Field) (µA/m)	Measurement distance (m)
9 - 490 kHz ^{Note 1}	6.37/F (F in kHz)	300
490 - 1705 kHz	63.7/F (F in kHz)	30
1.705 - 30 MHz	0.08	30

Note 1: The emission limits for the ranges 9-90 kHz and 110-490 kHz are based on measurements employing a linear average detector.

IC Restricted bands please refer to ISED RSS-GEN Clause 8.10

Table 7 – Restricted frequency bands ^{Note 1}		
MHz	MHz	GHz
0.090 - 0.110	149.9 - 150.05	9.0 - 9.2
0.495 - 0.505	156.52475 - 156.52525	9.3 - 9.5
2.1735 - 2.1905	156.7 - 156.9	10.6 - 12.7
3.020 - 3.026	162.0125 - 167.17	13.25 - 13.4
4.125 - 4.126	167.72 - 173.2	14.47 - 14.5
4.17725 - 4.17775	240 - 285	15.35 - 16.2
4.20725 - 4.20775	322 - 335.4	17.7 - 21.4
5.677 - 5.683	399.9 - 410	22.01 - 23.12
6.215 - 6.218	608 - 614	23.6 - 24.0
6.26775 - 6.26825	960 - 1427	31.2 - 31.8
6.31175 - 6.31225	1435 - 1626.5	36.43 - 36.5
8.291 - 8.294	1645.5 - 1646.5	Above 36.6
8.362 - 8.366	1660 - 1710	
8.37625 - 8.38675	1718.8 - 1722.2	
8.41425 - 8.41475	2200 - 2300	
12.29 - 12.293	2310 - 2390	
12.51975 - 12.52025	2483.5 - 2500	
12.57675 - 12.57725	2655 - 2900	
13.36 - 13.41	3260 - 3267	
16.42 - 16.423	3332 - 3339	
16.69475 - 16.69525	3345.8 - 3358	
16.80425 - 16.80475	3500 - 4400	
25.5 - 25.67	4500 - 5150	
37.5 - 38.25	5350 - 5460	
73 - 74.6	7250 - 7750	
74.8 - 75.2	8025 - 8500	
108 - 138		

Note 1: Certain frequency bands listed in table 7 and in bands above 38.6 GHz are designated for licence-exempt applications. These frequency bands and the requirements that apply to related devices are set out in the 200 and 300 series of RSSs.



FCC Restricted bands of operation:

MHz	MHz	MHz	GHz
0.090-0.110	16.42-16.423	399.9-410	4.5-5.15
¹ 0.495-0.505	16.69475-16.69525	608-614	5.35-5.46
2.1735-2.1905	16.80425-16.80475	960-1240	7.25-7.75
4.125-4.128	25.5-25.67	1300-1427	8.025-8.5
4.17725-4.17775	37.5-38.25	1435-1626.5	9.0-9.2
4.20725-4.20775	73-74.6	1645.5-1646.5	9.3-9.5
6.215-6.218	74.8-75.2	1660-1710	10.6-12.7
6.26775-6.26825	108-121.94	1718.8-1722.2	13.25-13.4
6.31175-6.31225	123-138	2200-2300	14.47-14.5
8.291-8.294	149.9-150.05	2310-2390	15.35-16.2
8.362-8.366	156.52475-156.52525	2483.5-2500	17.7-21.4
8.37625-8.38675	156.7-156.9	2690-2900	22.01-23.12
8.41425-8.41475	162.0125-167.17	3260-3267	23.6-24.0
12.29-12.293	167.72-173.2	3332-3339	31.2-31.8
12.51975-12.52025	240-285	3345.8-3358	36.43-36.5
12.57675-12.57725	322-335.4	3600-4400	(²)
13.36-13.41			

Note: ¹Until February 1, 1999, this restricted band shall be 0.490-0.510 MHz.²Above 38.6c

TEST SETUP AND PROCEDURE

Below 30MHz

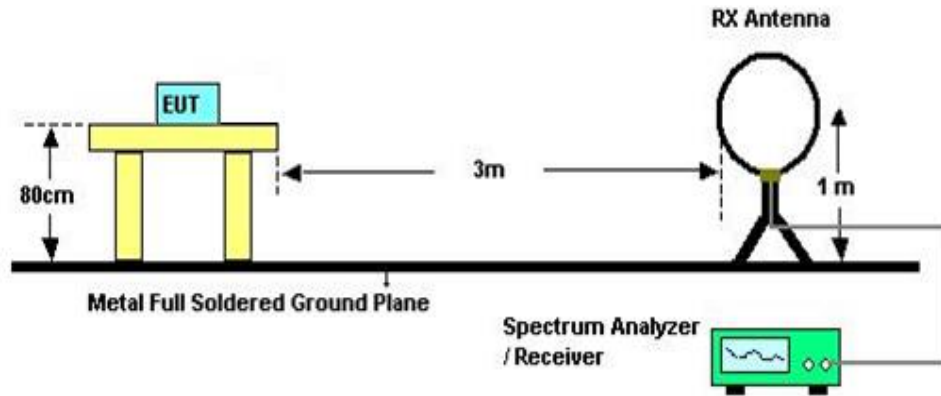

The setting of the spectrum analyser

RBW	200Hz (From 9kHz to 0.15MHz)/ 9KHz (From 0.15MHz to 30MHz)
VBW	200Hz (From 9kHz to 0.15MHz)/ 9KHz (From 0.15MHz to 30MHz)
Sweep	Auto
Detector	Peak/QP/ Average
Trace	Max hold

1. The testing follows the guidelines in ANSI C63.10-2013
2. The EUT was arranged to its worst case and then turntable (from 0 degree to 360 degrees) to find the maximum reading. A pre-amp and a high pass filter are used for the test in order to get better signal level. 3 polarizations(Horizontal, Face-on and Face-off) of the loop antenna are set to make the measurement.
3. The EUT was placed on a turntable with 0.8 meter above ground.
4. The EUT was set 3 meters from the interference receiving antenna, which was mounted on the top of a variable height antenna tower.
5. For measurement below 1GHz, the initial step in collecting conducted emission data is a spectrum analyzer peak detector mode pre-scanning the measurement frequency range. Significant peaks are then marked and then Quasi Peak detector mode re-measured. If the emission level of the EUT measured by the peak detector is 3 dB lower than the applicable limit, the peak emission level will be reported. Otherwise, the emission measurement will be repeated using the quasi-peak detector and reported.
6. For the actual test configuration, please refer to the related item in this test report (Photographs of the Test Configuration)
7. Although these tests were performed other than open field site, adequate comparison measurements were confirmed against 30m open field site. Therefore sufficient tests were made to demonstrate that the alternative site produces results that correlate with the ones of tests made in an open field site based on KDB 414788.

Below 1G

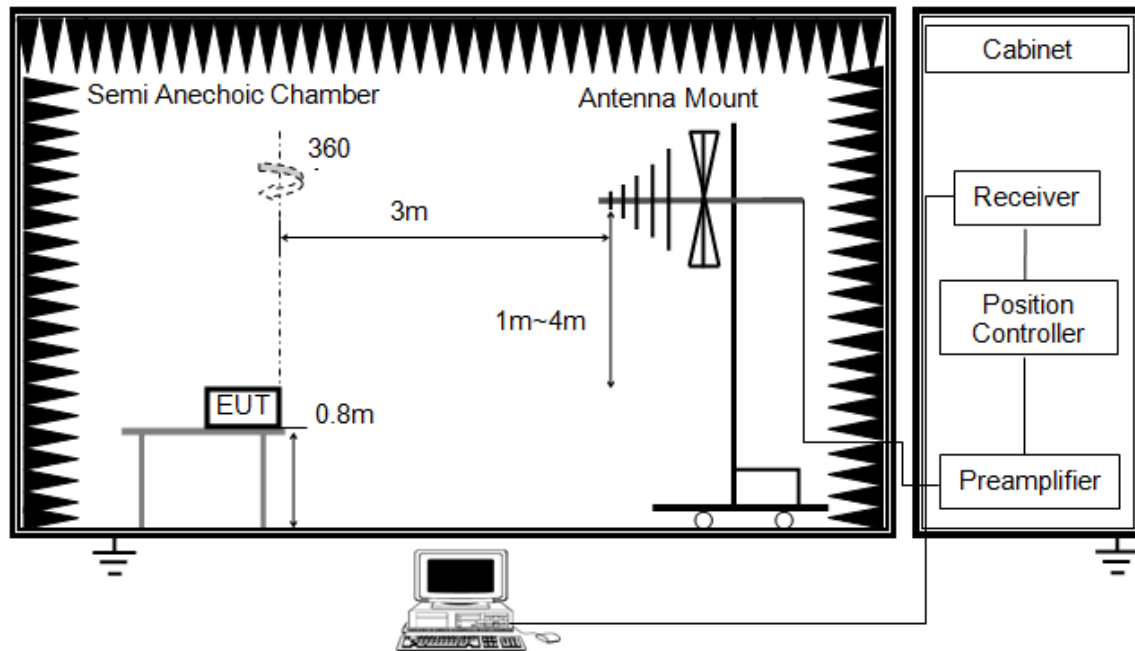

The setting of the spectrum analyser

RBW	120kHz
VBW	300kHz
Sweep	Auto
Detector	Peak/QP
Trace	Max hold

1. The testing follows the guidelines in ANSI C63.10-2013.
2. The EUT was arranged to its worst case and then tune the antenna tower (from 1 m to 4 m) and turntable (from 0 degree to 360 degrees) to find the maximum reading. A pre-amp and a high pass filter are used for the test in order to get better signal level. Both horizontal and vertical polarizations of the antenna are set to make the measurement.
3. The EUT was placed on a turntable with 0.8 meter above ground.
4. The EUT was set 3 meters from the interference receiving antenna, which was mounted on the top of a variable height antenna tower.
5. For measurement below 1GHz, the initial step in collecting conducted emission data is a spectrum analyzer peak detector mode pre-scanning the measurement frequency range. Significant peaks are then marked and then Quasi Peak detector mode re-measured. If the emission level of the EUT measured by the peak detector is 3 dB lower than the applicable limit, the peak emission level will be reported. Otherwise, the emission measurement will be repeated using the quasi-peak detector and reported.

ABOVE 1G

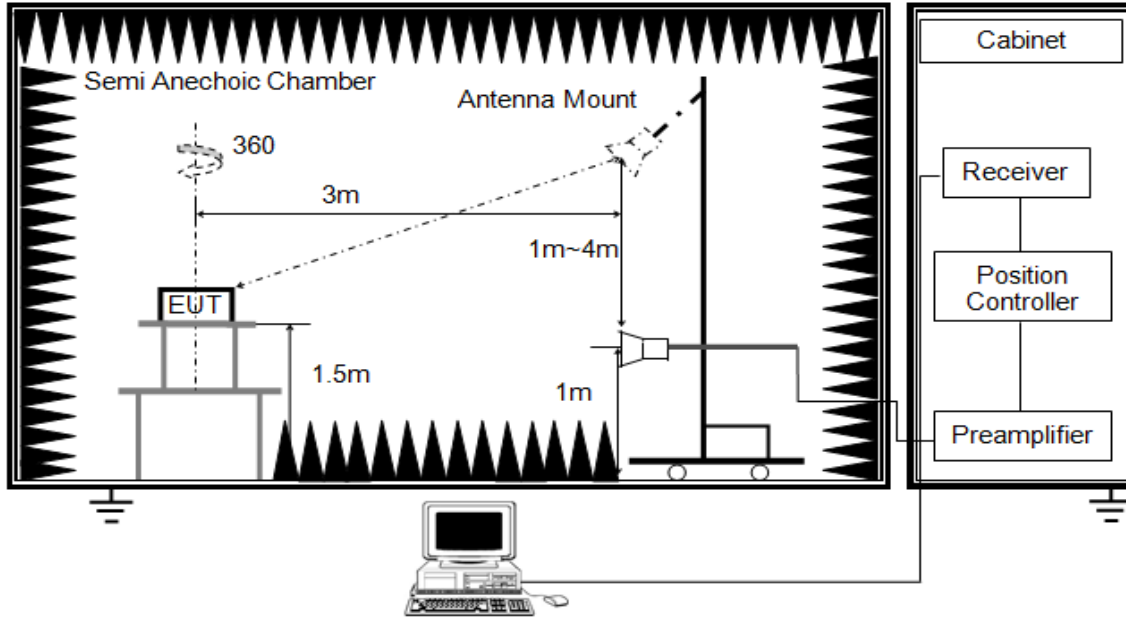

The setting of the spectrum analyser

RBW	1MHz
VBW	PEAK: 3MHz AVG: see note 6
Sweep	Auto
Detector	Peak
Trace	Max hold

1. The testing follows the guidelines in ANSI C63.10-2013.
2. The EUT was arranged to its worst case and then tune the antenna tower (from 1 m to 4 m) and turntable (from 0 degree to 360 degrees) to find the maximum reading. A pre-amp and a high pass filter are used for the test in order to get better signal level. Both horizontal and vertical polarizations of the antenna are set to make the measurement.
3. The EUT was placed on a turntable with 1.5m above ground.
4. The EUT was set 3 meters from the interference receiving antenna, which was mounted on the top of a variable height antenna tower.
5. For measurement above 1GHz, the emission measurement will be measured by the peak detector. This peak level, once corrected, must comply with the limit specified in Section 15.209.
6. For measurements above 1 GHz the resolution bandwidth is set to 1 MHz, then the video bandwidth is set to 3 MHz for peak measurements and 1 MHz resolution bandwidth with 1/T video bandwidth with peak detector for average measurements. For the Duty Cycle please refer to clause 7.1.ON TIME AND DUTY CYCLE.

X axis, Y axis, Z axis positions:

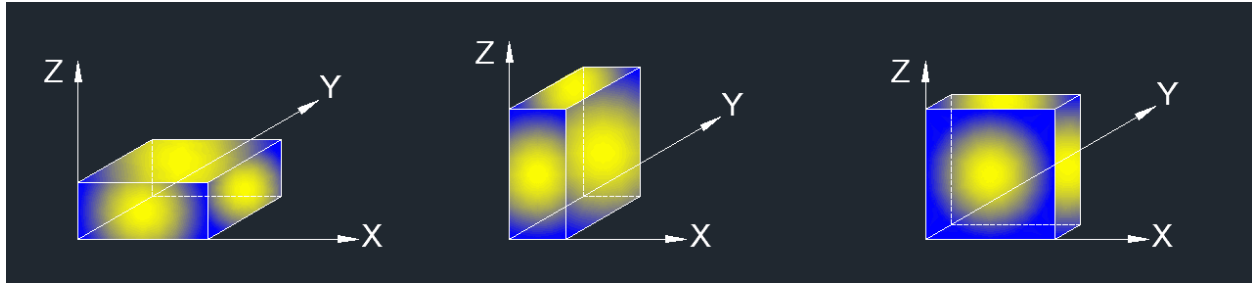

Note 1: The EUT was fully exercised with external accessories during the test. In the case of multiple accessory external ports, an external accessory shall be connected to one of each type of port.

Note 2: The EUT does not support simultaneous transmission.

TEST ENVIRONMENT

Temperature	22.9°C	Relative Humidity	58%
Atmosphere Pressure	101kPa	Test Voltage	DC 12V

8.1. RESTRICTED BANDEDGE

8.1.1. 802.11b MIMO MODE

RESTRICTED BANDEDGE (LOW CHANNEL, HORIZONTAL)

PEAK

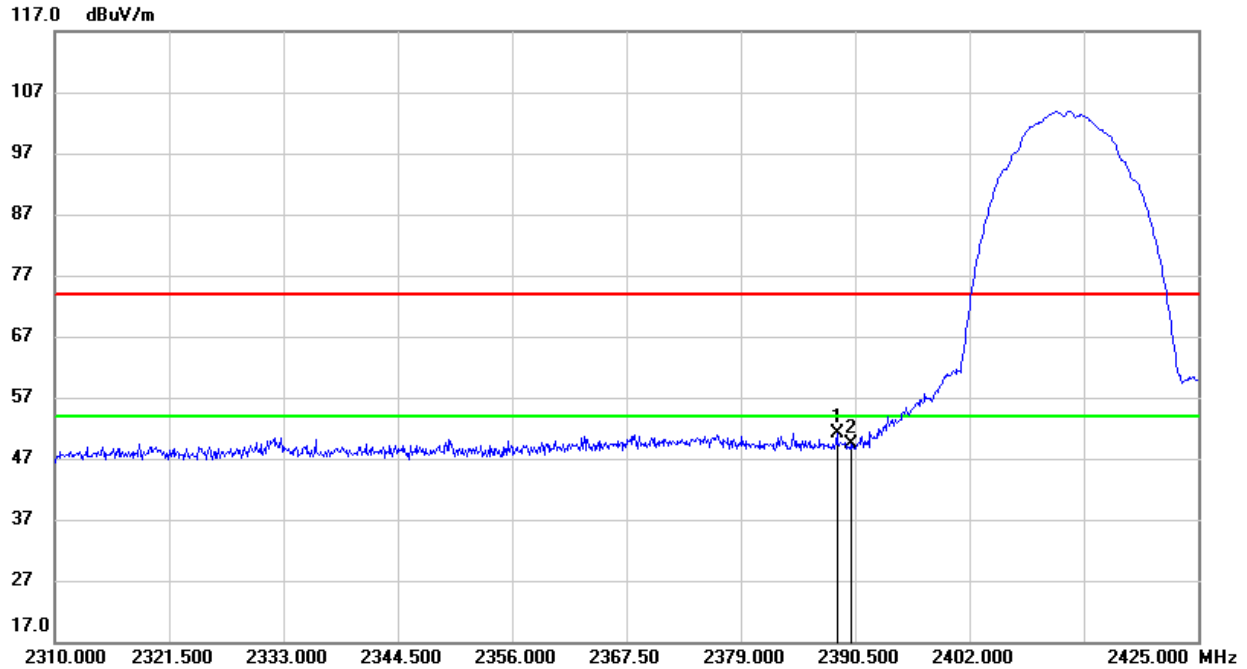

No.	Frequency (MHz)	Reading (dBuV)	Correct (dB/m)	Result (dBuV/m)	Limit (dBuV/m)	Margin (dB)	Remark
1	2388.660	18.26	32.94	51.20	74.00	-22.80	peak
2	2390.000	16.47	32.94	49.41	74.00	-24.59	peak

- Note: 1. Measurement = Reading Level + Correct Factor.
 2. If Peak Result complies with AV limit, AV Result is deemed to comply with AV limit.
 3. Peak: Peak detector.
 4. Only the worst case emission was recorded, if it complies with the limit, the other emissions deemed to comply with the limit.

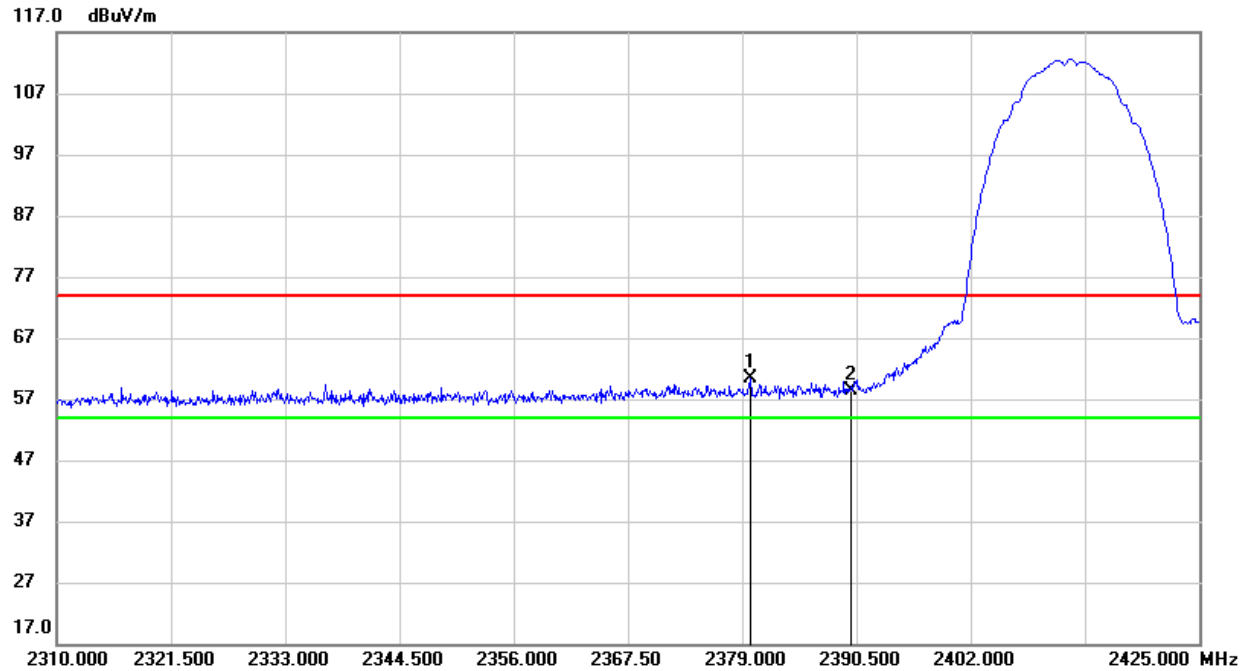
**RESTRICTED BANDEDGE (LOW CHANNEL, VERTICAL)****PEAK**

No.	Frequency (MHz)	Reading (dBuV)	Correct (dB/m)	Result (dBuV/m)	Limit (dBuV/m)	Margin (dB)	Remark
1	2379.805	27.43	32.91	60.34	74.00	-13.66	peak
2	2390.000	25.38	32.94	58.32	74.00	-15.68	peak

- Note: 1. Measurement = Reading Level + Correct Factor.
 2. If Peak Result complies with AV limit, AV Result is deemed to comply with AV limit.
 3. Peak: Peak detector.
 4. Only the worst case emission was recorded, if it complies with the limit, the other emissions deemed to comply with the limit.

Avg

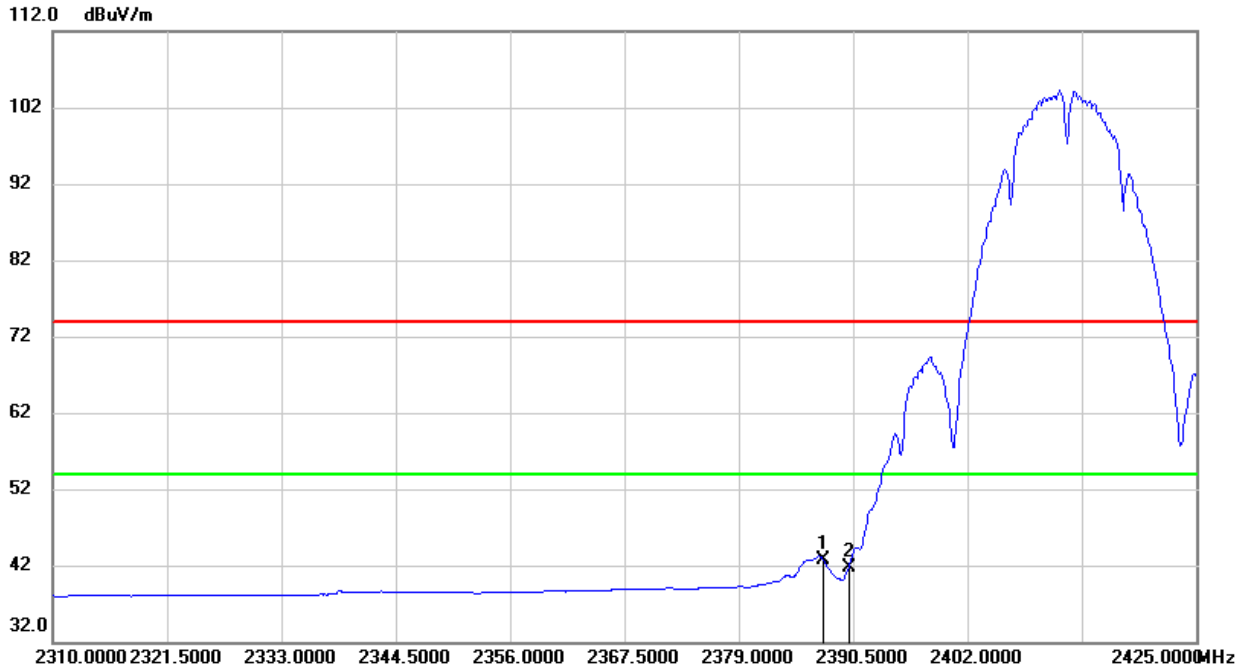

No.	Frequency (MHz)	Reading (dBuV)	Correct (dB/m)	Result (dBuV/m)	Limit (dBuV/m)	Margin (dB)	Remark
1	2387.510	9.74	32.94	42.68	54.00	-11.32	AVG
2	2390.000	8.72	32.94	41.66	54.00	-12.34	AVG

- Note:
1. Measurement = Reading Level + Correct Factor.
 2. If Peak Result complies with AV limit, AV Result is deemed to comply with AV limit.
 3. AVG: $VBW=1/Ton$ where: ton is transmit duration.
 4. For transmit duration, please refer to clause 7.1.
 5. Only the worst case emission was recorded, if it complies with the limit, the other emissions deemed to comply with the limit.

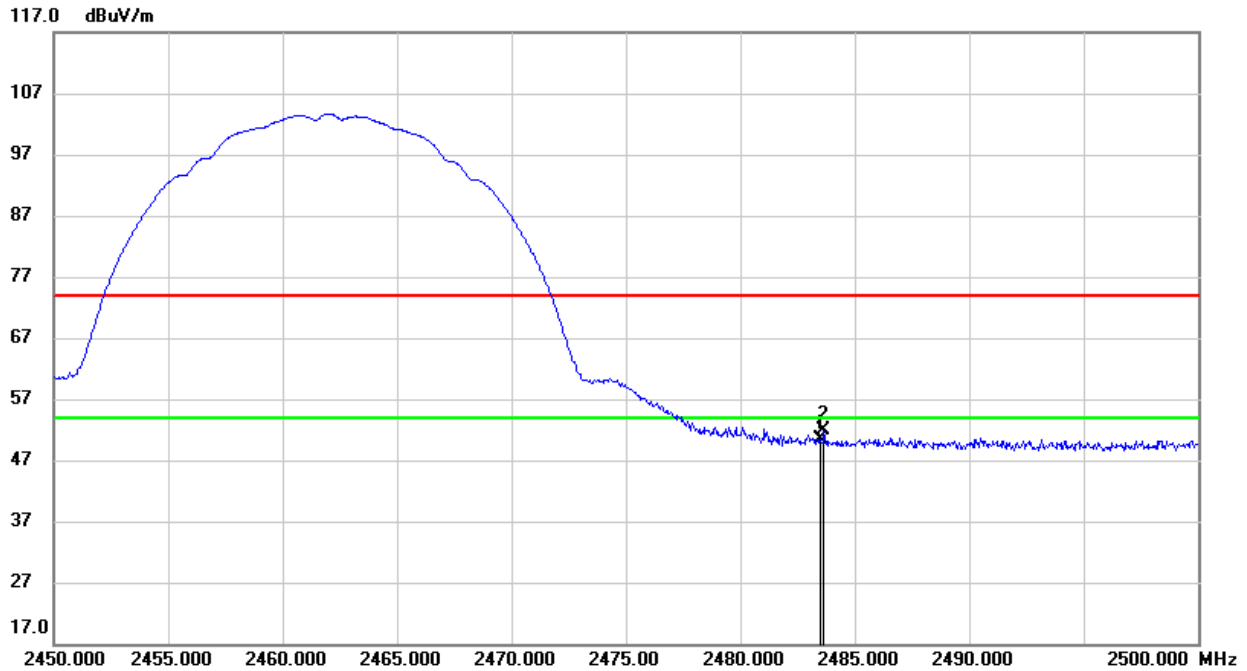
**RESTRICTED BANDEDGE (HIGH CHANNEL, HORIZONTAL)****PEAK**

No.	Frequency (MHz)	Reading (dBuV)	Correct (dB/m)	Result (dBuV/m)	Limit (dBuV/m)	Margin (dB)	Remark
1	2483.500	16.68	33.58	50.26	74.00	-23.74	peak
2	2483.650	18.39	33.58	51.97	74.00	-22.03	peak

- Note: 1. Measurement = Reading Level + Correct Factor.
 2. If Peak Result complies with AV limit, AV Result is deemed to comply with AV limit.
 3. Peak: Peak detector.
 4. Only the worst case emission was recorded, if it complies with the limit, the other emissions deemed to comply with the limit.



RESTRICTED BANDEDGE (HIGH CHANNEL, VERTICAL)

PEAK

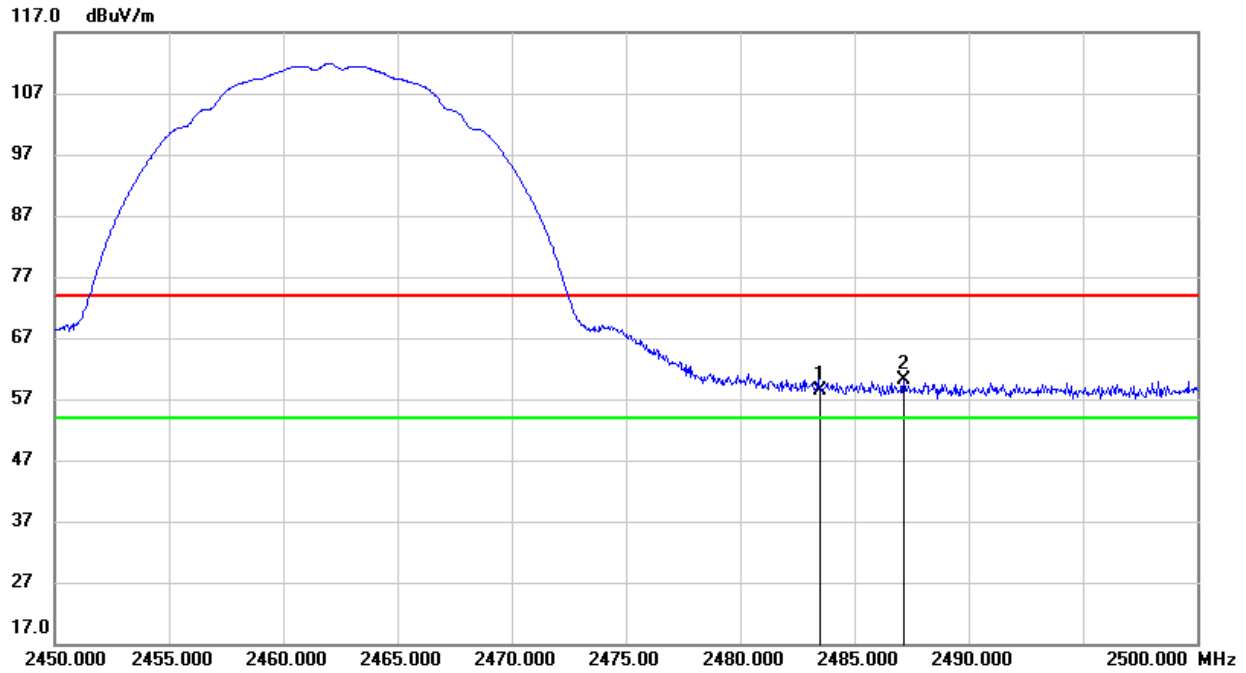

No.	Frequency (MHz)	Reading (dBuV)	Correct (dB/m)	Result (dBuV/m)	Limit (dBuV/m)	Margin (dB)	Remark
1	2483.500	24.72	33.58	58.30	74.00	-15.70	peak
2	2487.150	26.49	33.61	60.10	74.00	-13.90	peak

- Note: 1. Measurement = Reading Level + Correct Factor.
 2. If Peak Result complies with AV limit, AV Result is deemed to comply with AV limit.
 3. Peak: Peak detector.
 4. Only the worst case emission was recorded, if it complies with the limit, the other emissions deemed to comply with the limit.

Avg

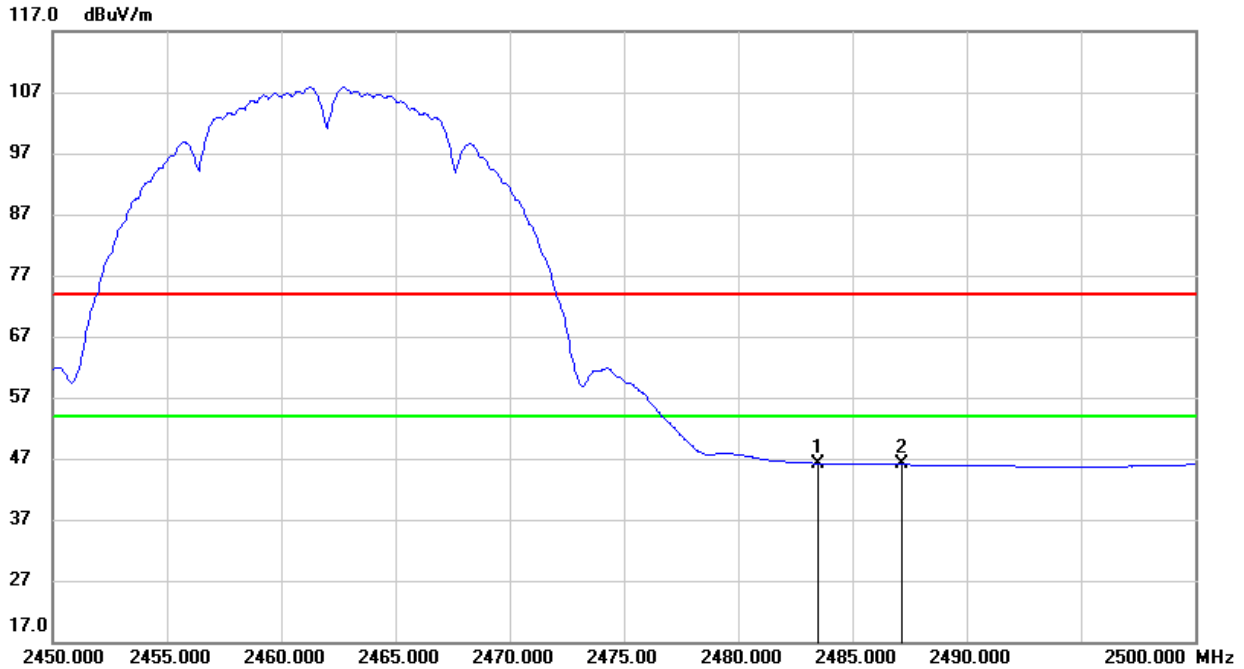

No.	Frequency (MHz)	Reading (dBuV)	Correct (dB/m)	Result (dBuV/m)	Limit (dBuV/m)	Margin (dB)	Remark
1	2483.500	12.61	33.58	46.19	54.00	-7.81	AVG
2	2487.150	12.41	33.61	46.02	54.00	-7.98	AVG

- Note: 1. Measurement = Reading Level + Correct Factor.
 2. If Peak Result complies with AV limit, AV Result is deemed to comply with AV limit.
 3. AVG: $VBW=1/Ton$ where: ton is transmit duration.
 4. For transmit duration, please refer to clause 7.1.
 5. Only the worst case emission was recorded, if it complies with the limit, the other emissions deemed to comply with the limit.

8.1.2. 802.11g MIMO MODE

RESTRICTED BANDEDGE (LOW CHANNEL, HORIZONTAL)

PEAK

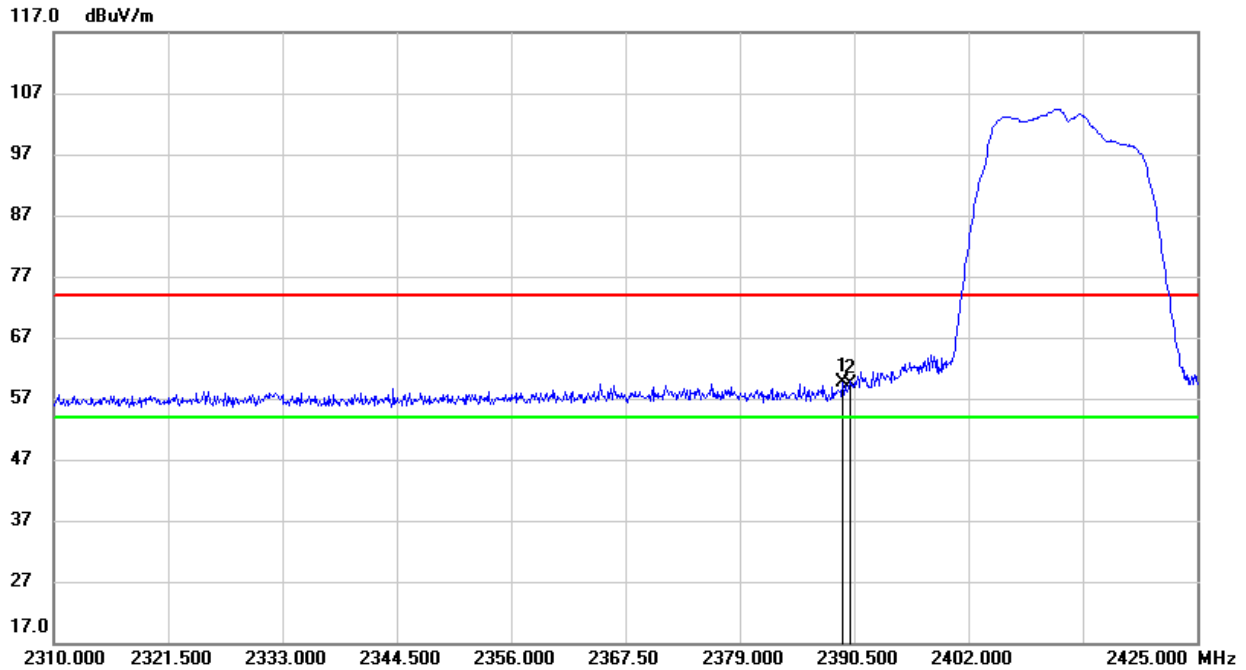

No.	Frequency (MHz)	Reading (dBuV)	Correct (dB/m)	Result (dBuV/m)	Limit (dBuV/m)	Margin (dB)	Remark
1	2389.350	26.68	32.94	59.62	74.00	-14.38	peak
2	2390.000	26.49	32.94	59.43	74.00	-14.57	peak

- Note: 1. Measurement = Reading Level + Correct Factor.
 2. If Peak Result complies with AV limit, AV Result is deemed to comply with AV limit.
 3. Peak: Peak detector.
 4. Only the worst case emission was recorded, if it complies with the limit, the other emissions deemed to comply with the limit.



AVG

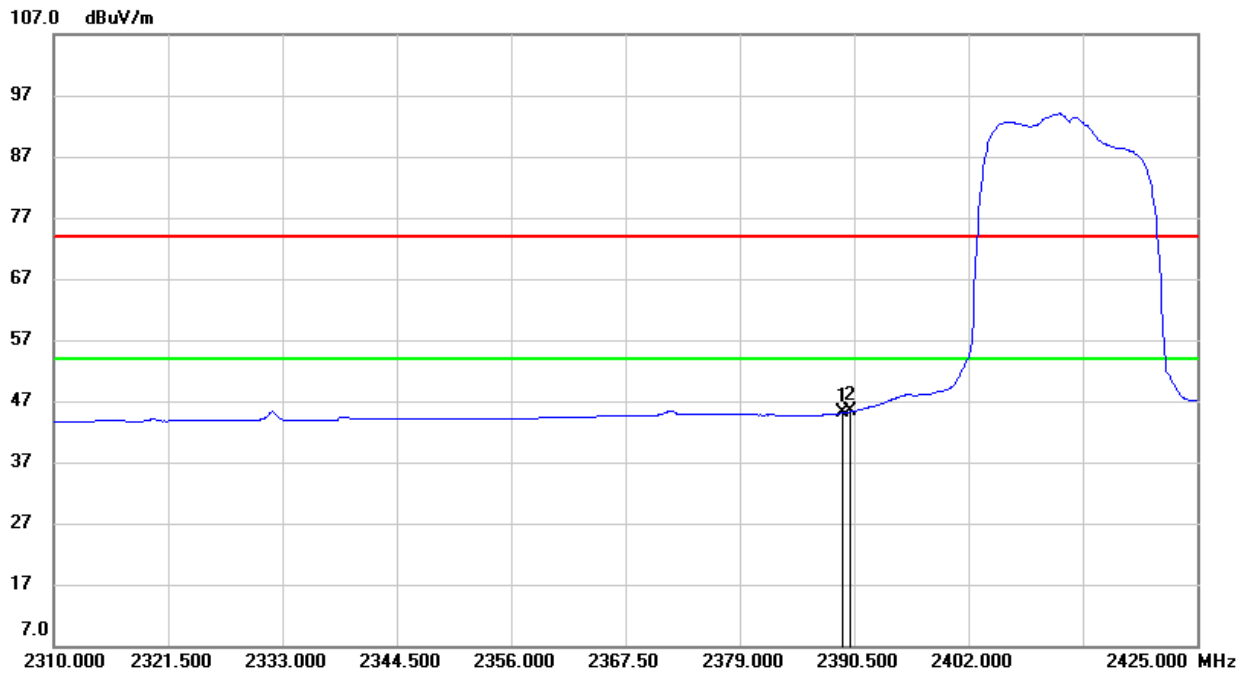

No.	Frequency (MHz)	Reading (dBuV)	Correct (dB/m)	Result (dBuV/m)	Limit (dBuV/m)	Margin (dB)	Remark
1	2389.350	12.12	32.94	45.06	54.00	-8.94	AVG
2	2390.000	12.32	32.94	45.26	54.00	-8.74	AVG

- Note: 1. Measurement = Reading Level + Correct Factor.
 2. If Peak Result complies with AV limit, AV Result is deemed to comply with AV limit.
 3. AVG: VBW=1/Ton where: ton is transmit duration.
 4. For transmit duration, please refer to clause 7.1.
 5. Only the worst case emission was recorded, if it complies with the limit, the other emissions deemed to comply with the limit.

RESTRICTED BANDEDGE (LOW CHANNEL, VERTICAL)

PEAK

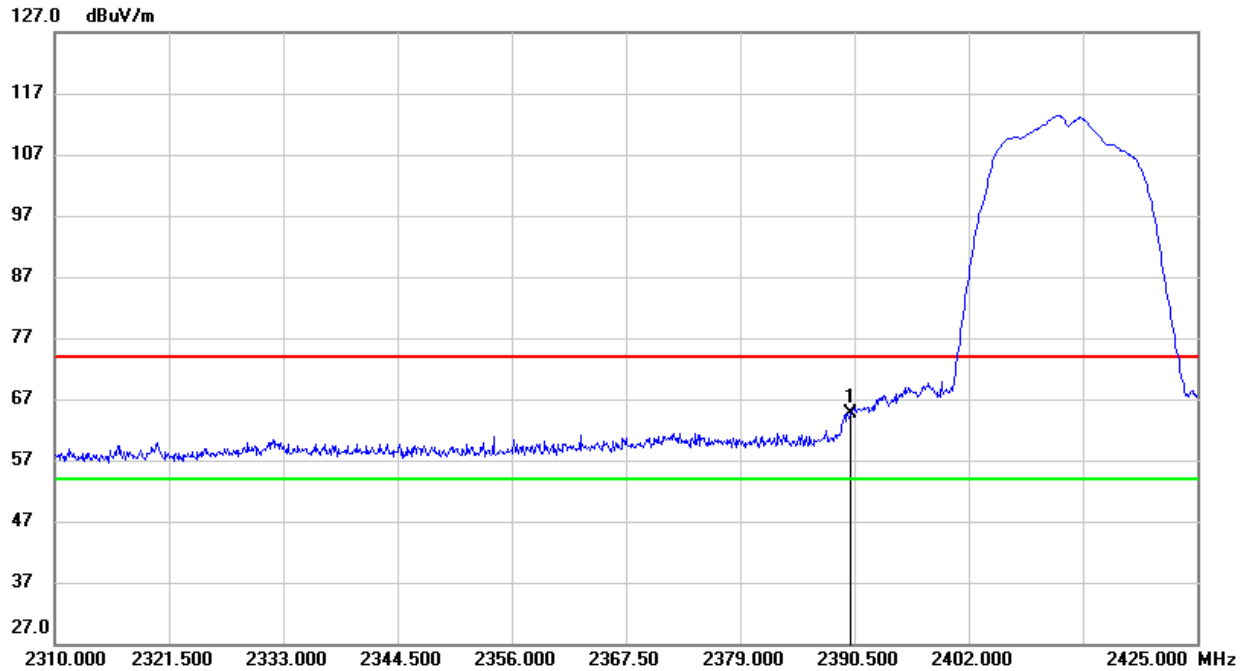

No.	Frequency (MHz)	Reading (dBuV)	Correct (dB/m)	Result (dBuV/m)	Limit (dBuV/m)	Margin (dB)	Remark
1	2390.000	31.60	32.94	64.54	74.00	-9.46	peak

- Note:
1. Measurement = Reading Level + Correct Factor.
 2. If Peak Result complies with AV limit, AV Result is deemed to comply with AV limit.
 3. Peak: Peak detector.
 4. Only the worst case emission was recorded, if it complies with the limit, the other emissions deemed to comply with the limit.



AVG

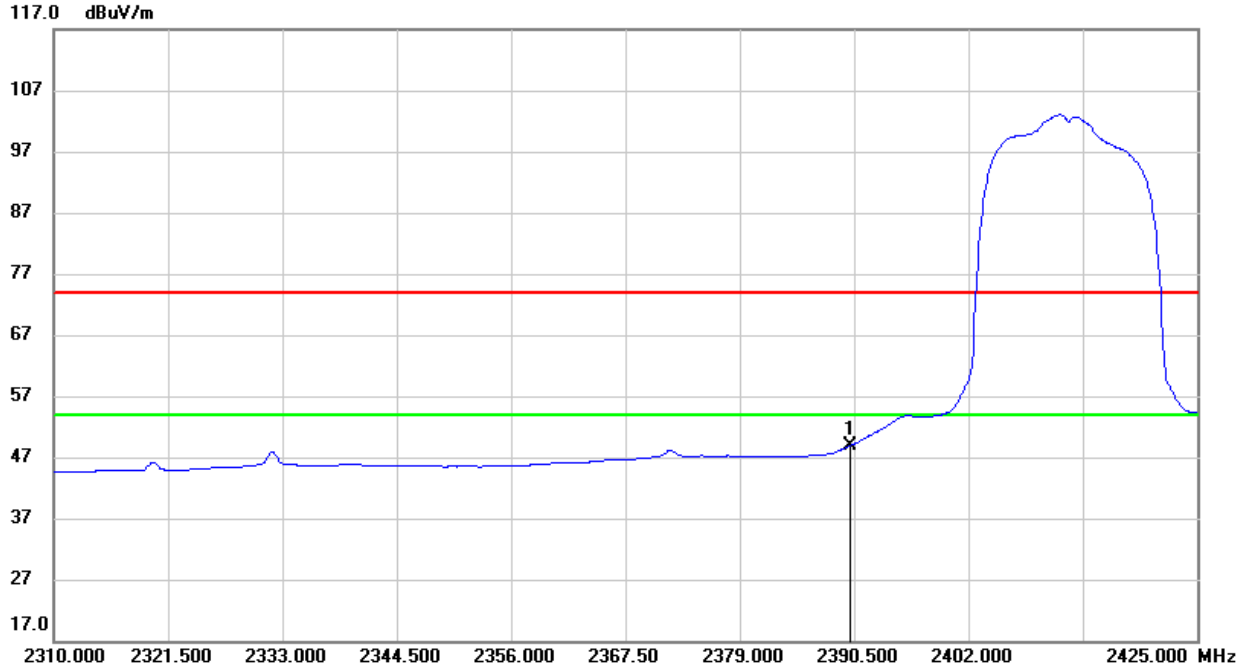

No.	Frequency (MHz)	Reading (dBuV)	Correct (dB/m)	Result (dBuV/m)	Limit (dBuV/m)	Margin (dB)	Remark
1	2390.000	15.97	32.94	48.91	54.00	-5.09	AVG

- Note:
1. Measurement = Reading Level + Correct Factor.
 2. If Peak Result complies with AV limit, AV Result is deemed to comply with AV limit.
 3. AVG: $VBW=1/Ton$ where: ton is transmit duration.
 4. For transmit duration, please refer to clause 7.1.
 5. Only the worst case emission was recorded, if it complies with the limit, the other emissions deemed to comply with the limit.

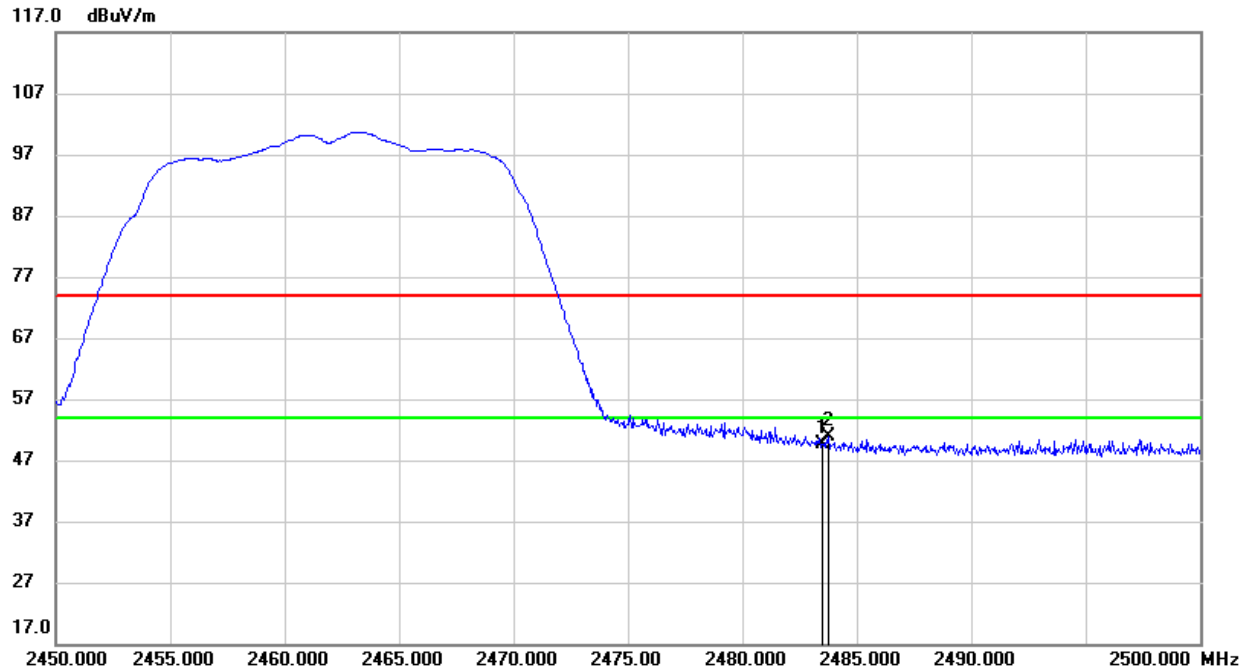
**RESTRICTED BANDEDGE (HIGH CHANNEL, HORIZONTAL)****PEAK**

No.	Frequency (MHz)	Reading (dBuV)	Correct (dB/m)	Result (dBuV/m)	Limit (dBuV/m)	Margin (dB)	Remark
1	2483.500	16.16	33.58	49.74	74.00	-24.26	peak
2	2483.750	17.24	33.58	50.82	74.00	-23.18	peak

- Note: 1. Measurement = Reading Level + Correct Factor.
 2. If Peak Result complies with AV limit, AV Result is deemed to comply with AV limit.
 3. Peak: Peak detector.
 4. Only the worst case emission was recorded, if it complies with the limit, the other emissions deemed to comply with the limit.

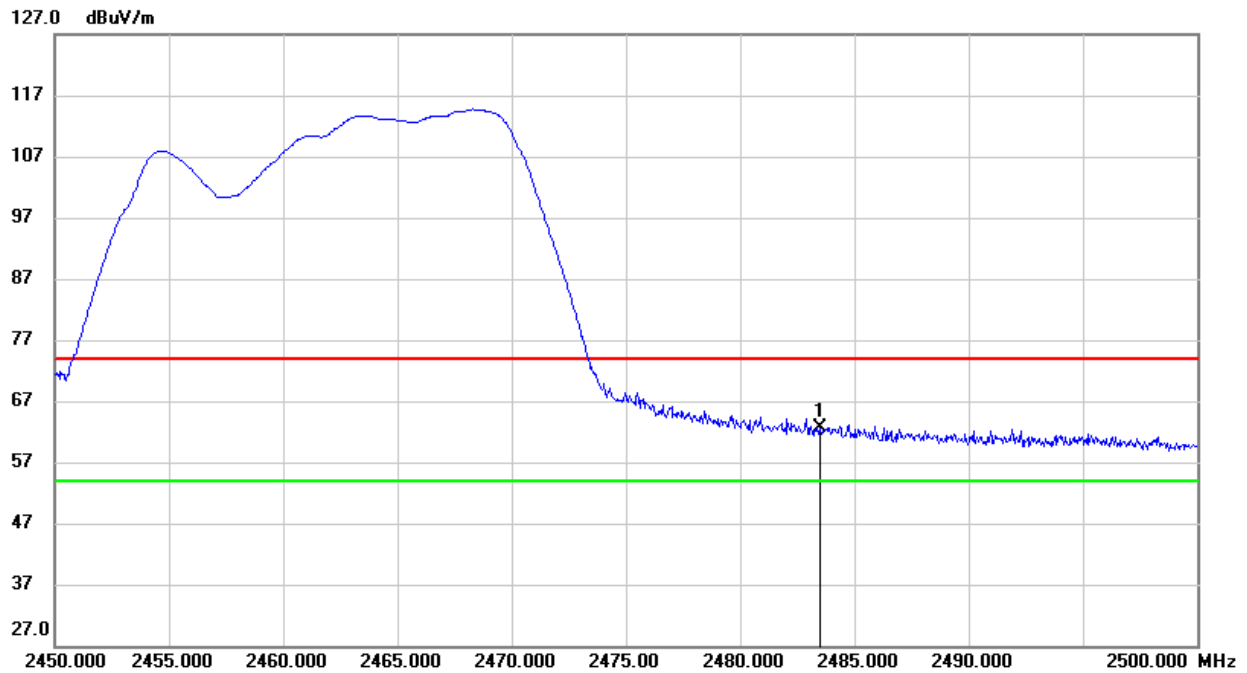
**RESTRICTED BANDEDGE (HIGH CHANNEL, VERTICAL)****PEAK**

No.	Frequency (MHz)	Reading (dBuV)	Correct (dB/m)	Result (dBuV/m)	Limit (dBuV/m)	Margin (dB)	Remark
1	2483.500	29.15	33.58	62.73	74.00	-11.27	peak

- Note: 1. Measurement = Reading Level + Correct Factor.
 2. If Peak Result complies with AV limit, AV Result is deemed to comply with AV limit.
 3. Peak: Peak detector.
 4. Only the worst case emission was recorded, if it complies with the limit, the other emissions deemed to comply with the limit.



AVG

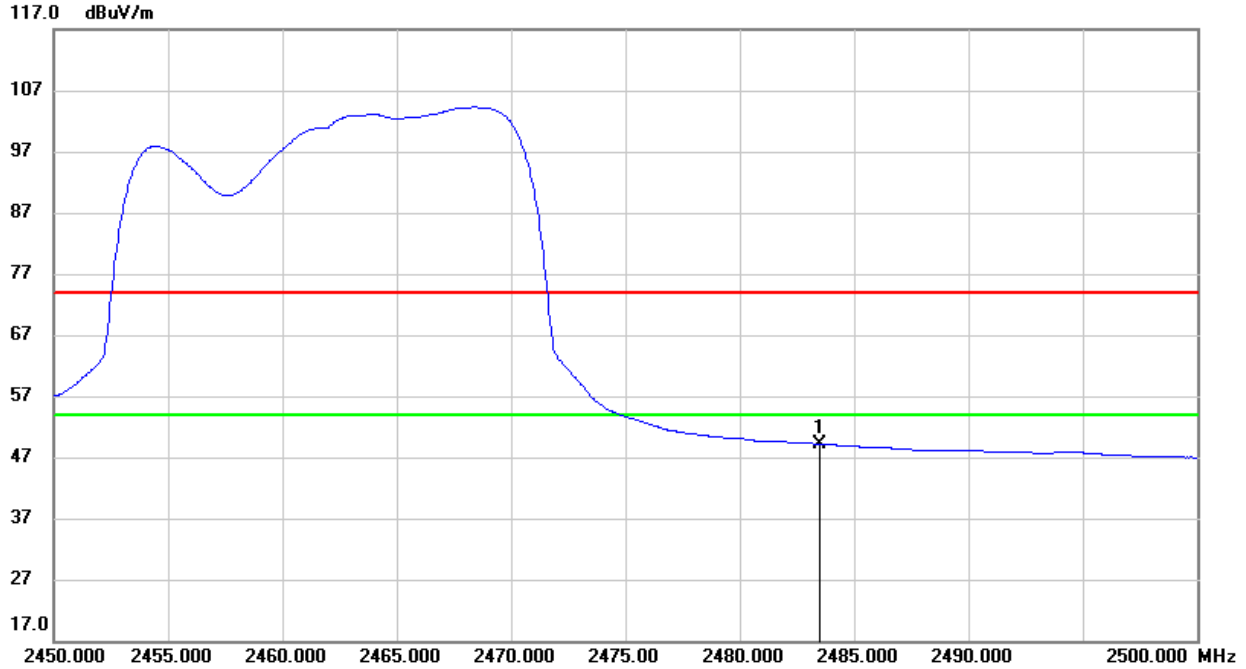

No.	Frequency (MHz)	Reading (dBuV)	Correct (dB/m)	Result (dBuV/m)	Limit (dBuV/m)	Margin (dB)	Remark
1	2483.500	15.62	33.58	49.20	54.00	-4.80	AVG

- Note:
1. Measurement = Reading Level + Correct Factor.
 2. If Peak Result complies with AV limit, AV Result is deemed to comply with AV limit.
 3. AVG: $VBW=1/Ton$ where: ton is transmit duration.
 4. For transmit duration, please refer to clause 7.1.
 5. Only the worst case emission was recorded, if it complies with the limit, the other emissions deemed to comply with the limit.

8.1.3. 802.11n HT20 MIMO MODE

RESTRICTED BANDEDGE (LOW CHANNEL, HORIZONTAL)

PEAK

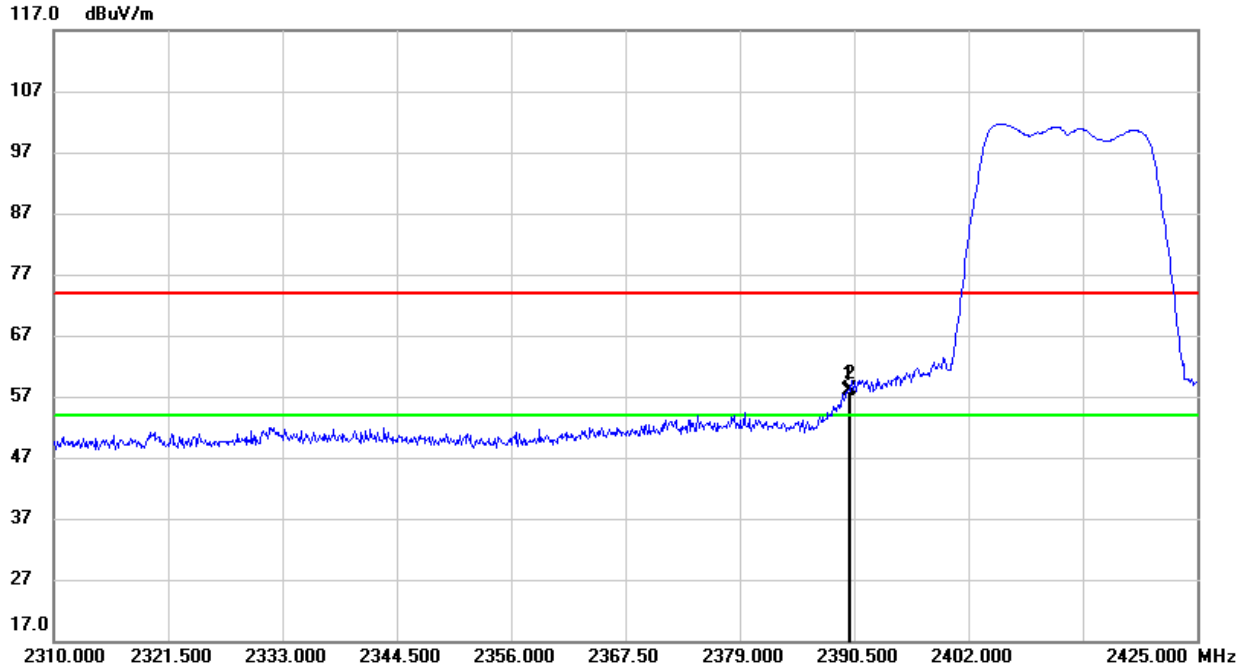

No.	Frequency (MHz)	Reading (dBuV)	Correct (dB/m)	Result (dBuV/m)	Limit (dBuV/m)	Margin (dB)	Remark
1	2390.000	24.97	32.94	57.91	74.00	-16.09	peak
2	2390.155	25.08	32.94	58.02	74.00	-15.98	peak

- Note: 1. Measurement = Reading Level + Correct Factor.
 2. If Peak Result complies with AV limit, AV Result is deemed to comply with AV limit.
 3. Peak: Peak detector.
 4. Only the worst case emission was recorded, if it complies with the limit, the other emissions deemed to comply with the limit.



AVG

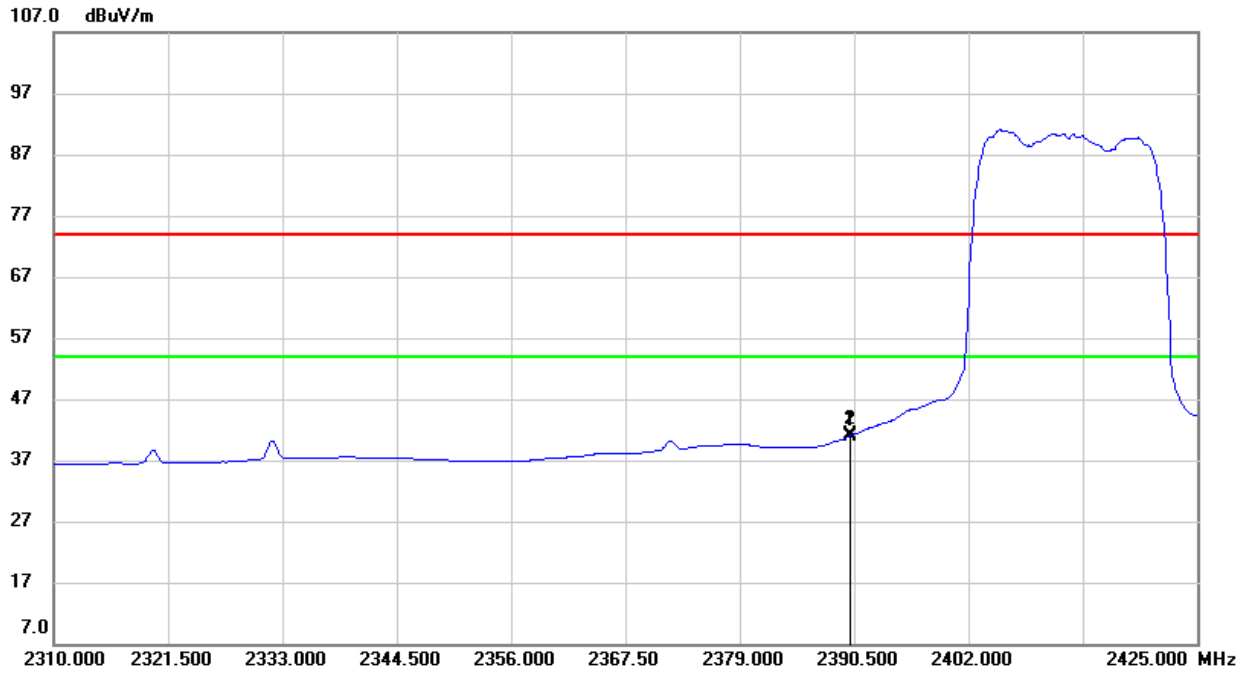

No.	Frequency (MHz)	Reading (dBuV)	Correct (dB/m)	Result (dBuV/m)	Limit (dBuV/m)	Margin (dB)	Remark
1	2390.000	8.06	32.94	41.00	74.00	-33.00	peak
2	2390.155	8.12	32.94	41.06	74.00	-32.94	peak

- Note: 1. Measurement = Reading Level + Correct Factor.
 2. If Peak Result complies with AV limit, AV Result is deemed to comply with AV limit.
 3. AVG: $VBW=1/Ton$ where: ton is transmit duration.
 4. For transmit duration, please refer to clause 7.1.
 5. Only the worst case emission was recorded, if it complies with the limit, the other emissions deemed to comply with the limit.

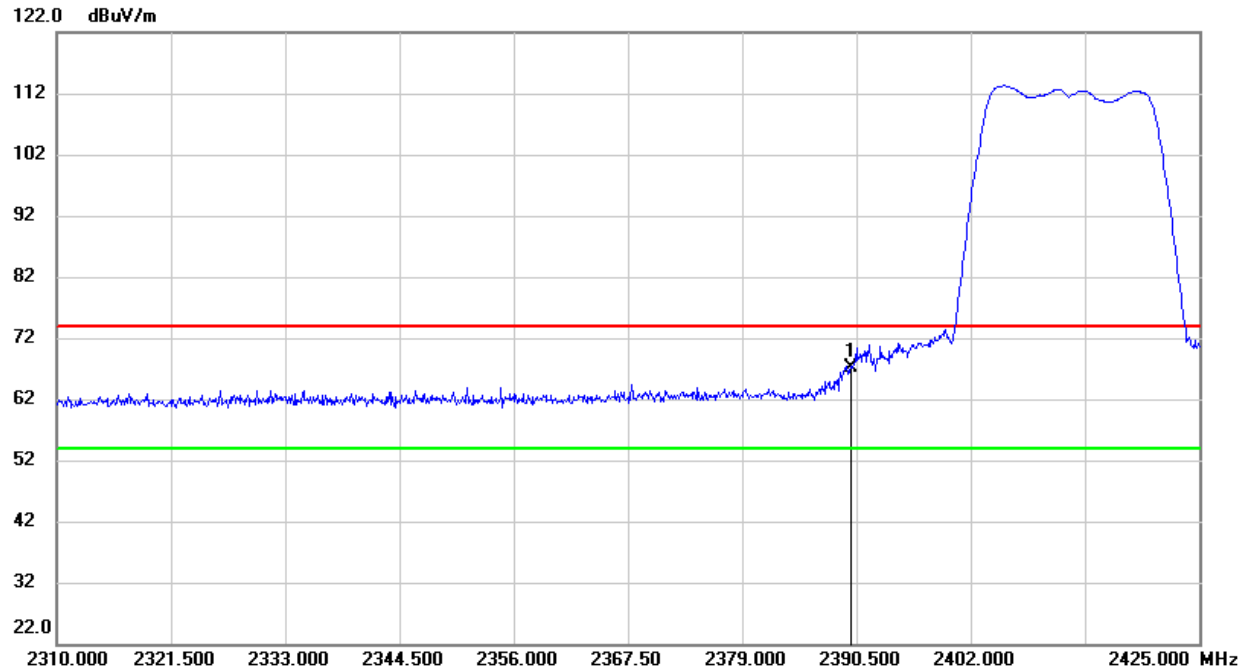
**RESTRICTED BANDEDGE (LOW CHANNEL, VERTICAL)****PEAK**

No.	Frequency (MHz)	Reading (dBuV)	Correct (dB/m)	Result (dBuV/m)	Limit (dBuV/m)	Margin (dB)	Remark
1	2390.000	34.22	32.94	67.16	74.00	-6.84	peak

- Note: 1. Measurement = Reading Level + Correct Factor.
 2. If Peak Result complies with AV limit, AV Result is deemed to comply with AV limit.
 3. Peak: Peak detector.
 4. Only the worst case emission was recorded, if it complies with the limit, the other emissions deemed to comply with the limit.

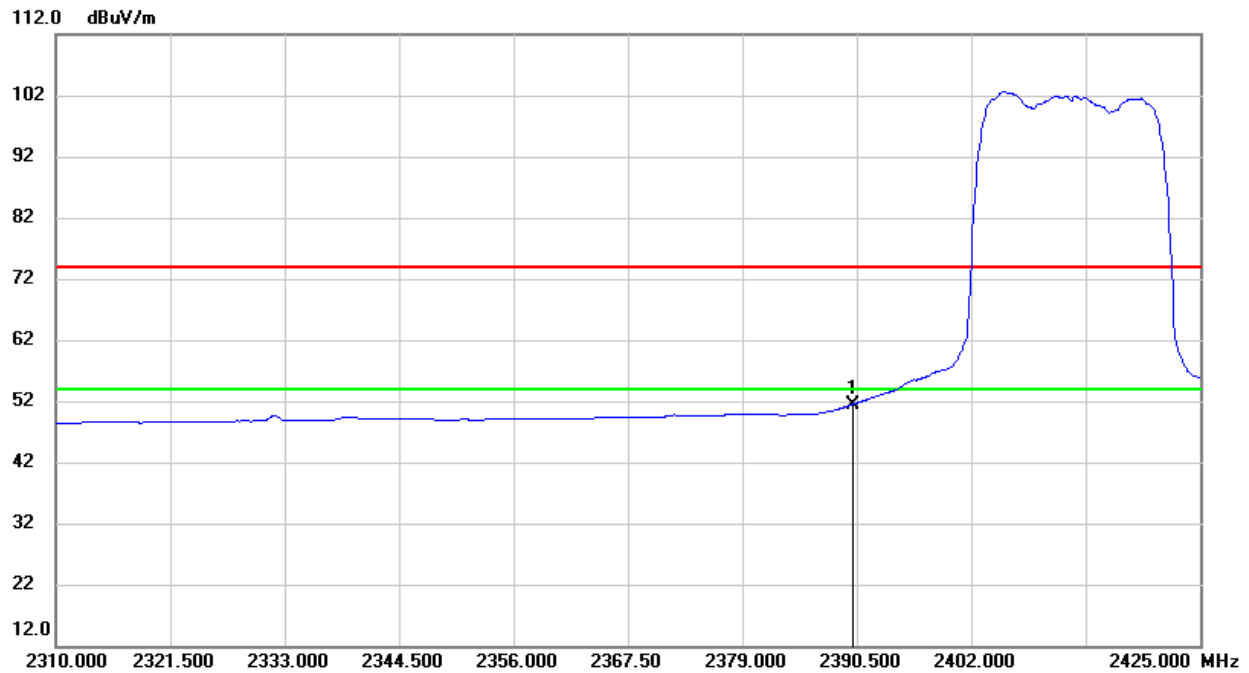
**AVG**

No.	Frequency (MHz)	Reading (dBuV)	Correct (dB/m)	Result (dBuV/m)	Limit (dBuV/m)	Margin (dB)	Remark
1	2390.000	18.56	32.94	51.50	54.00	-2.50	AVG

- Note: 1. Measurement = Reading Level + Correct Factor.
 2. If Peak Result complies with AV limit, AV Result is deemed to comply with AV limit.
 3. AVG: $VBW=1/Ton$ where: ton is transmit duration.
 4. For transmit duration, please refer to clause 7.1.
 5. Only the worst case emission was recorded, if it complies with the limit, the other emissions deemed to comply with the limit.

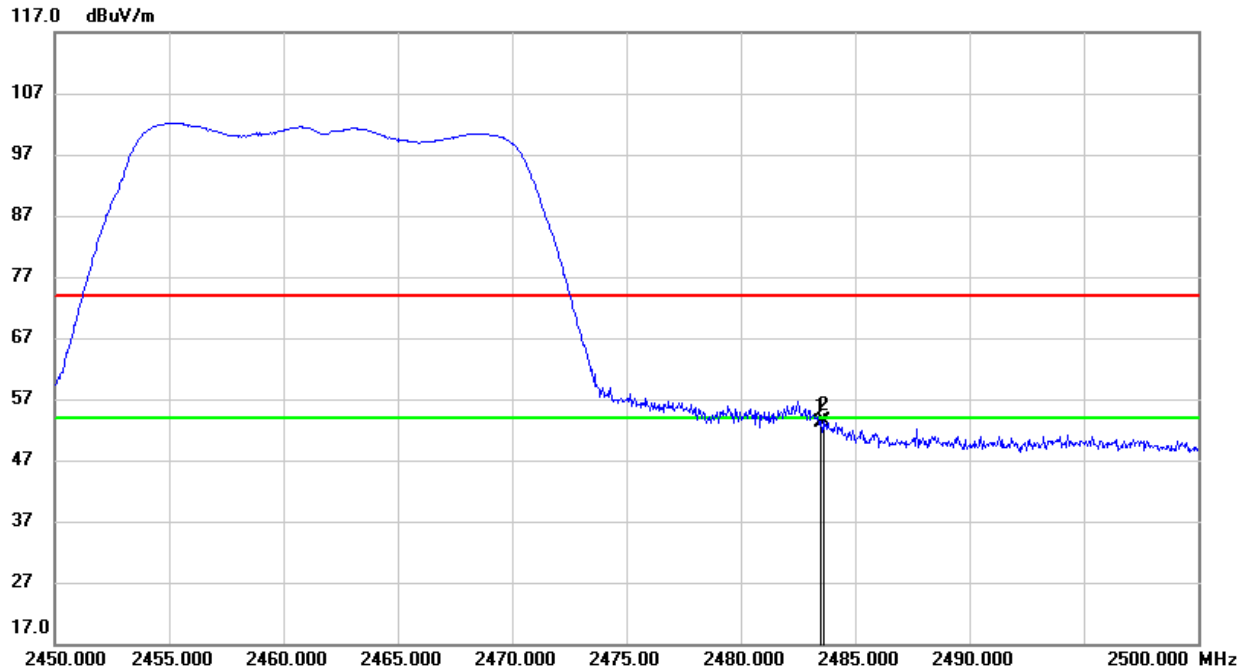
**RESTRICTED BANDEDGE (HIGH CHANNEL, HORIZONTAL)****PEAK**

No.	Frequency (MHz)	Reading (dBuV)	Correct (dB/m)	Result (dBuV/m)	Limit (dBuV/m)	Margin (dB)	Remark
1	2483.500	19.67	33.58	53.25	74.00	-20.75	peak
2	2483.650	19.68	33.58	53.26	74.00	-20.74	peak

- Note: 1. Measurement = Reading Level + Correct Factor.
 2. If Peak Result complies with AV limit, AV Result is deemed to comply with AV limit.
 3. Peak: Peak detector.
 4. Only the worst case emission was recorded, if it complies with the limit, the other emissions deemed to comply with the limit.

RESTRICTED BANDEDGE (HIGH CHANNEL, VERTICAL)

PEAK

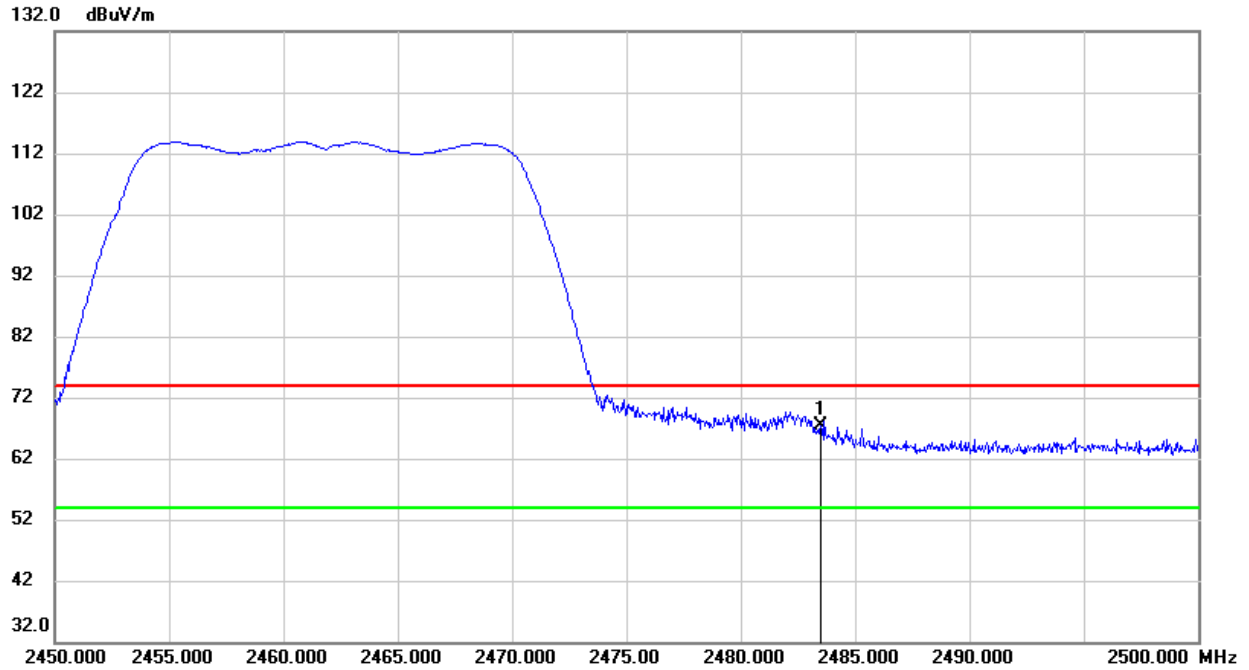

No.	Frequency (MHz)	Reading (dBuV)	Correct (dB/m)	Result (dBuV/m)	Limit (dBuV/m)	Margin (dB)	Remark
1	2483.500	33.84	33.58	67.42	74.00	-6.58	peak

- Note: 1. Measurement = Reading Level + Correct Factor.
 2. If Peak Result complies with AV limit, AV Result is deemed to comply with AV limit.
 3. Peak: Peak detector.
 4. Only the worst case emission was recorded, if it complies with the limit, the other emissions deemed to comply with the limit.



AVG

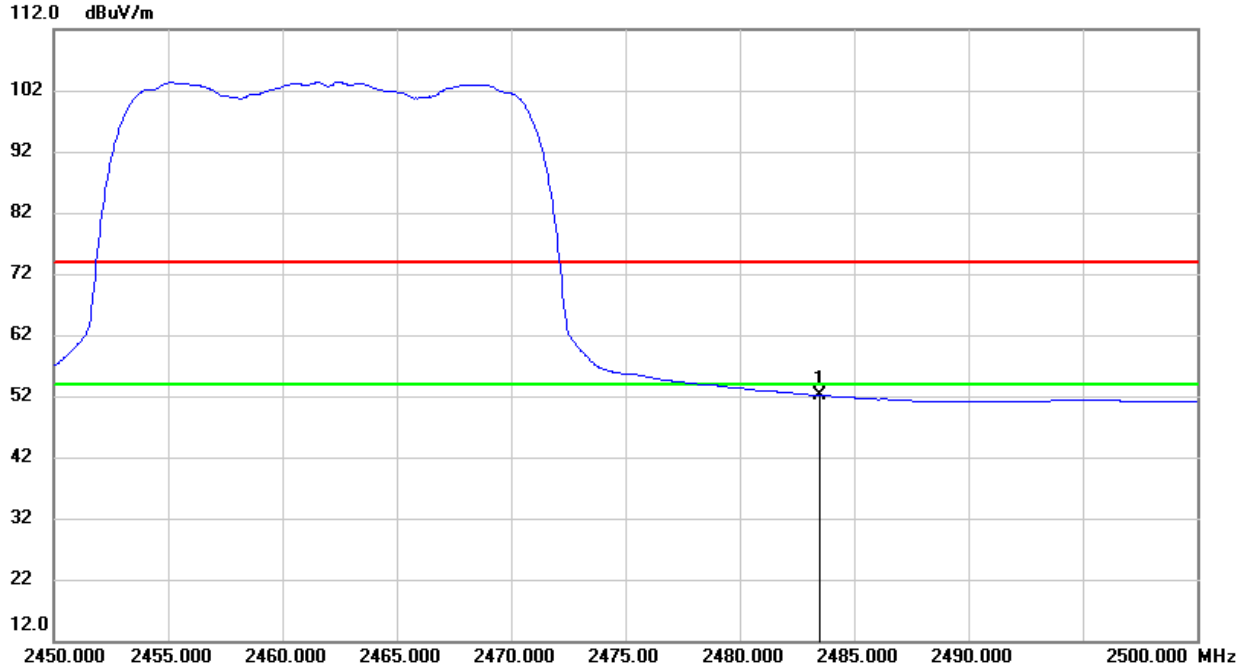

No.	Frequency (MHz)	Reading (dBuV)	Correct (dB/m)	Result (dBuV/m)	Limit (dBuV/m)	Margin (dB)	Remark
1	2483.500	18.63	33.58	52.21	54.00	-1.79	AVG

- Note:
1. Measurement = Reading Level + Correct Factor.
 2. If Peak Result complies with AV limit, AV Result is deemed to comply with AV limit.
 3. AVG: $VBW=1/Ton$ where: ton is transmit duration.
 4. For transmit duration, please refer to clause 7.1.
 5. Only the worst case emission was recorded, if it complies with the limit, the other emissions deemed to comply with the limit.



8.1.4. 802.11n HT40 MIMO MODE

RESTRICTED BANDEDGE (LOW CHANNEL, HORIZONTAL)

PEAK

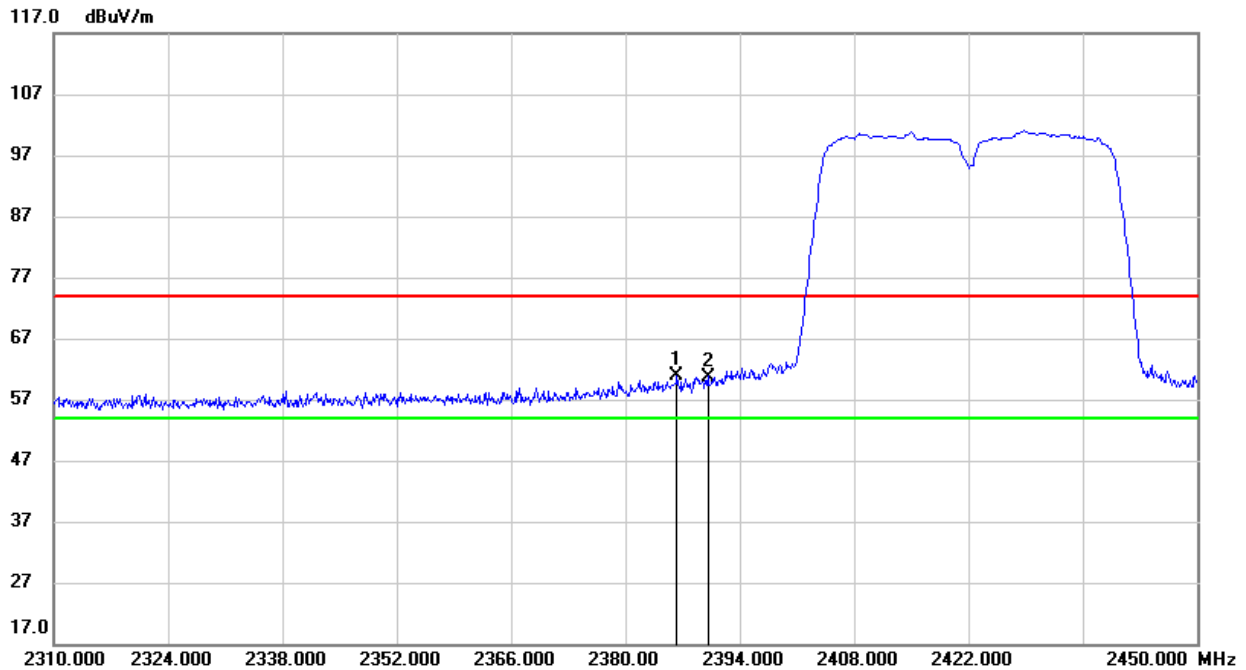

No.	Frequency (MHz)	Reading (dBuV)	Correct (dB/m)	Result (dBuV/m)	Limit (dBuV/m)	Margin (dB)	Remark
1	2386.300	27.86	32.94	60.80	74.00	-13.20	peak
2	2390.000	27.81	32.94	60.75	74.00	-13.25	peak

- Note: 1. Measurement = Reading Level + Correct Factor.
 2. If Peak Result complies with AV limit, AV Result is deemed to comply with AV limit.
 3. Peak: Peak detector.
 4. Only the worst case emission was recorded, if it complies with the limit, the other emissions deemed to comply with the limit.

AVG

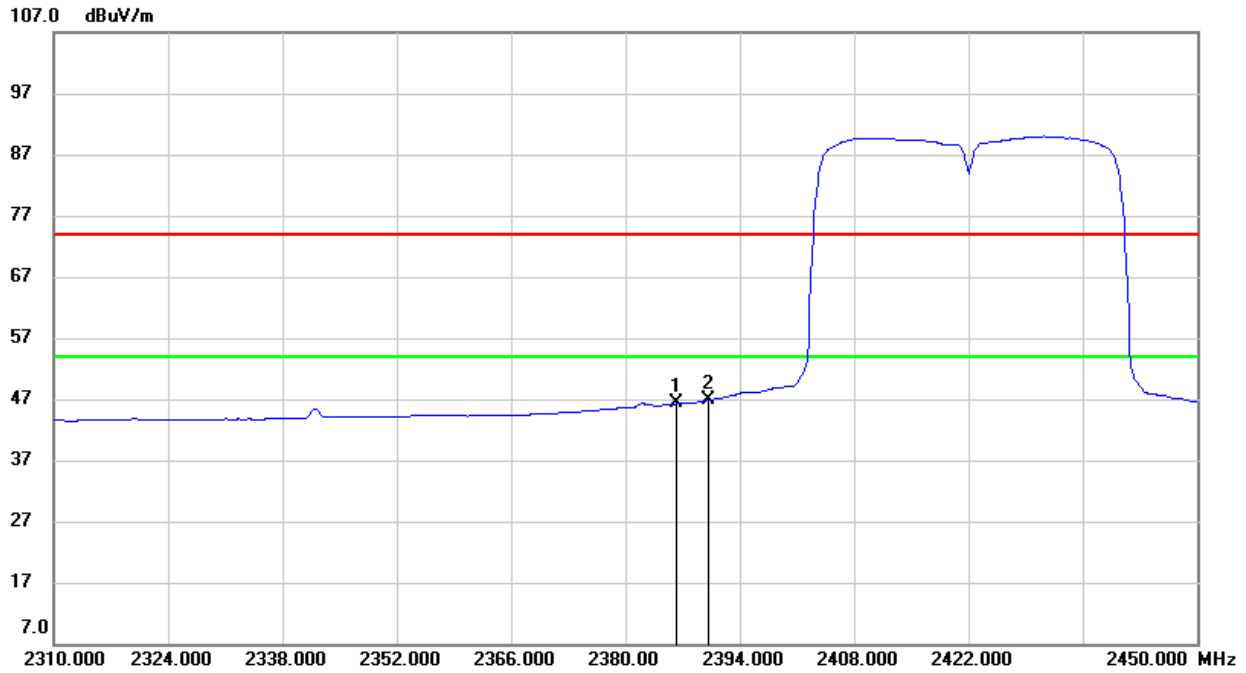

No.	Frequency (MHz)	Reading (dBuV)	Correct (dB/m)	Result (dBuV/m)	Limit (dBuV/m)	Margin (dB)	Remark
1	2386.300	13.32	32.94	46.26	54.00	-7.74	AVG
2	2390.000	13.86	32.94	46.80	54.00	-7.20	AVG

- Note: 1. Measurement = Reading Level + Correct Factor.
 2. If Peak Result complies with AV limit, AV Result is deemed to comply with AV limit.
 3. AVG: VBW=1/Ton where: ton is transmit duration.
 4. For transmit duration, please refer to clause 8.1.
 5. Only the worst case emission was recorded, if it complies with the limit, the other emissions deemed to comply with the limit.

RESTRICTED BANDEDGE (LOW CHANNEL, VERTICAL)

PEAK

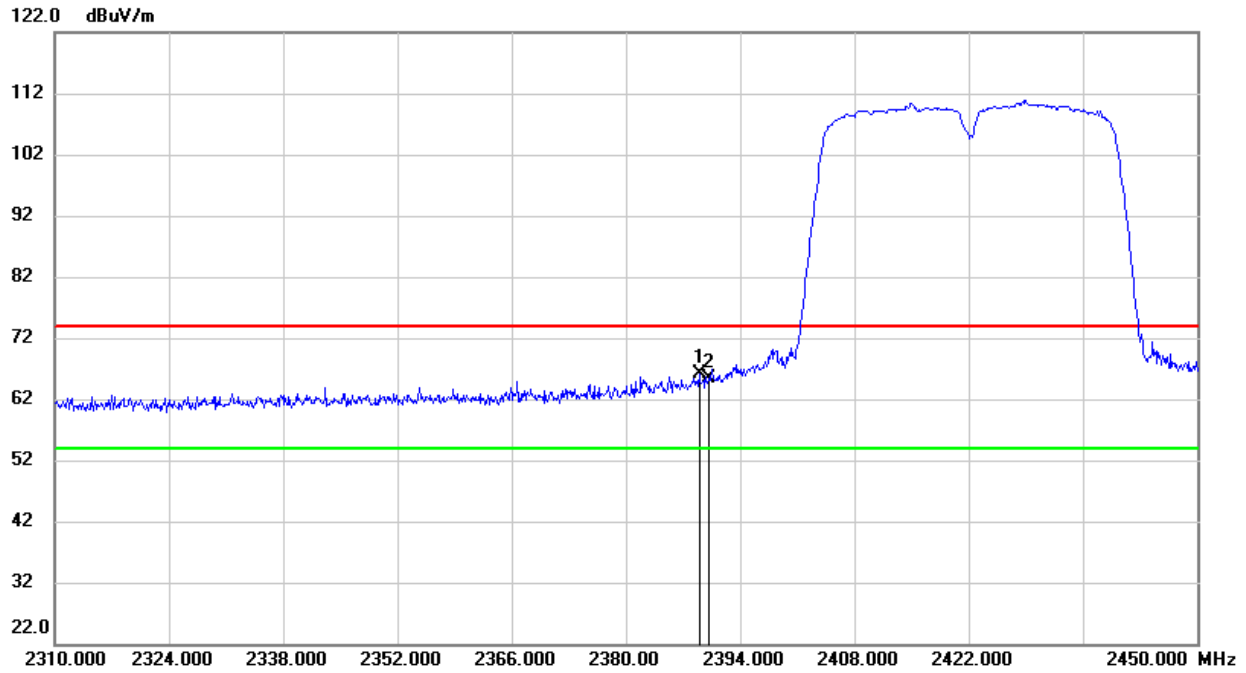

No.	Frequency (MHz)	Reading (dBuV)	Correct (dB/m)	Result (dBuV/m)	Limit (dBuV/m)	Margin (dB)	Remark
1	2388.960	33.19	32.94	66.13	74.00	-7.87	peak
2	2390.000	32.49	32.94	65.43	74.00	-8.57	peak

- Note: 1. Measurement = Reading Level + Correct Factor.
 2. If Peak Result complies with AV limit, AV Result is deemed to comply with AV limit.
 3. Peak: Peak detector.
 4. Only the worst case emission was recorded, if it complies with the limit, the other emissions deemed to comply with the limit.

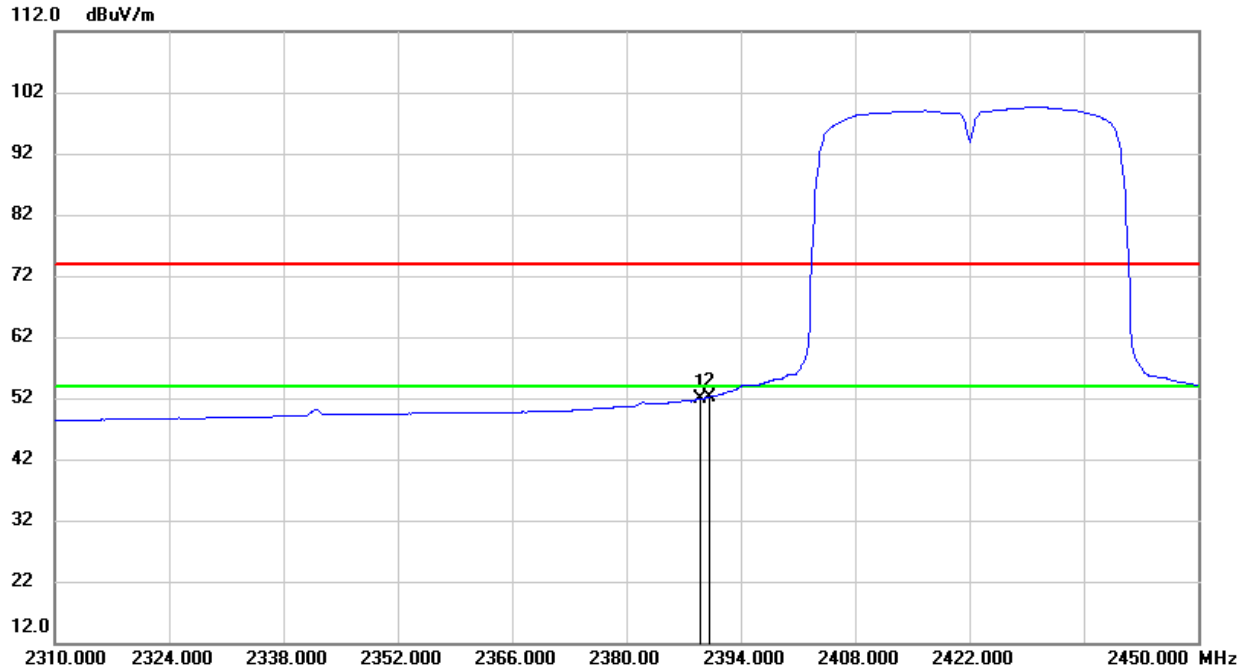
**AVG**

No.	Frequency (MHz)	Reading (dBuV)	Correct (dB/m)	Result (dBuV/m)	Limit (dBuV/m)	Margin (dB)	Remark
1	2388.960	18.98	32.94	51.92	54.00	-2.08	AVG
2	2390.000	19.21	32.94	52.15	54.00	-1.85	AVG

- Note: 1. Measurement = Reading Level + Correct Factor.
 2. If Peak Result complies with AV limit, AV Result is deemed to comply with AV limit.
 3. AVG: $VBW=1/Ton$ where: ton is transmit duration.
 4. For transmit duration, please refer to clause 8.1.
 5. Only the worst case emission was recorded, if it complies with the limit, the other emissions deemed to comply with the limit.

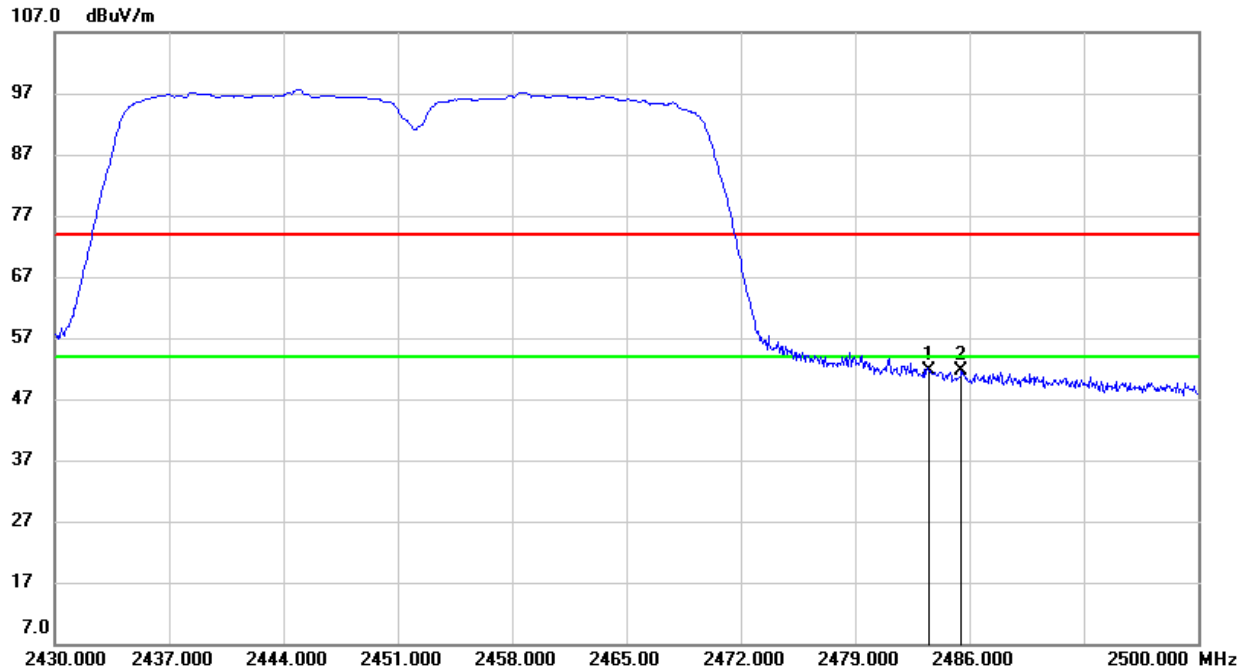
**RESTRICTED BANDEDGE (HIGH CHANNEL, HORIZONTAL)****PEAK**

No.	Frequency (MHz)	Reading (dBuV)	Correct (dB/m)	Result (dBuV/m)	Limit (dBuV/m)	Margin (dB)	Remark
1	2483.500	17.94	33.58	51.52	74.00	-22.48	peak
2	2485.510	18.14	33.59	51.73	74.00	-22.27	peak

- Note: 1. Measurement = Reading Level + Correct Factor.
 2. If Peak Result complies with AV limit, AV Result is deemed to comply with AV limit.
 3. Peak: Peak detector.
 4. Only the worst case emission was recorded, if it complies with the limit, the other emissions deemed to comply with the limit.

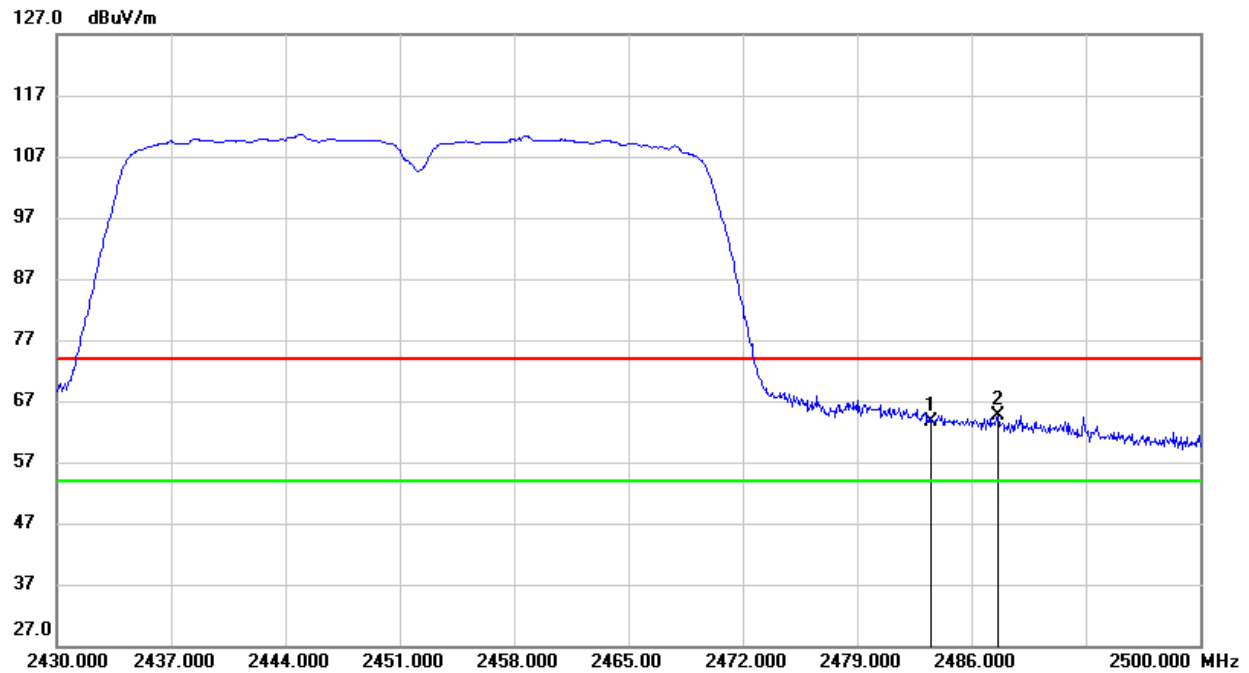
**RESTRICTED BANDEDGE (HIGH CHANNEL, VERTICAL)****PEAK**

No.	Frequency (MHz)	Reading (dBuV)	Correct (dB/m)	Result (dBuV/m)	Limit (dBuV/m)	Margin (dB)	Remark
1	2483.500	30.16	33.58	63.74	74.00	-10.26	peak
2	2487.610	31.09	33.61	64.70	74.00	-9.30	peak

- Note: 1. Measurement = Reading Level + Correct Factor.
 2. If Peak Result complies with AV limit, AV Result is deemed to comply with AV limit.
 3. Peak: Peak detector.
 4. Only the worst case emission was recorded, if it complies with the limit, the other emissions deemed to comply with the limit.

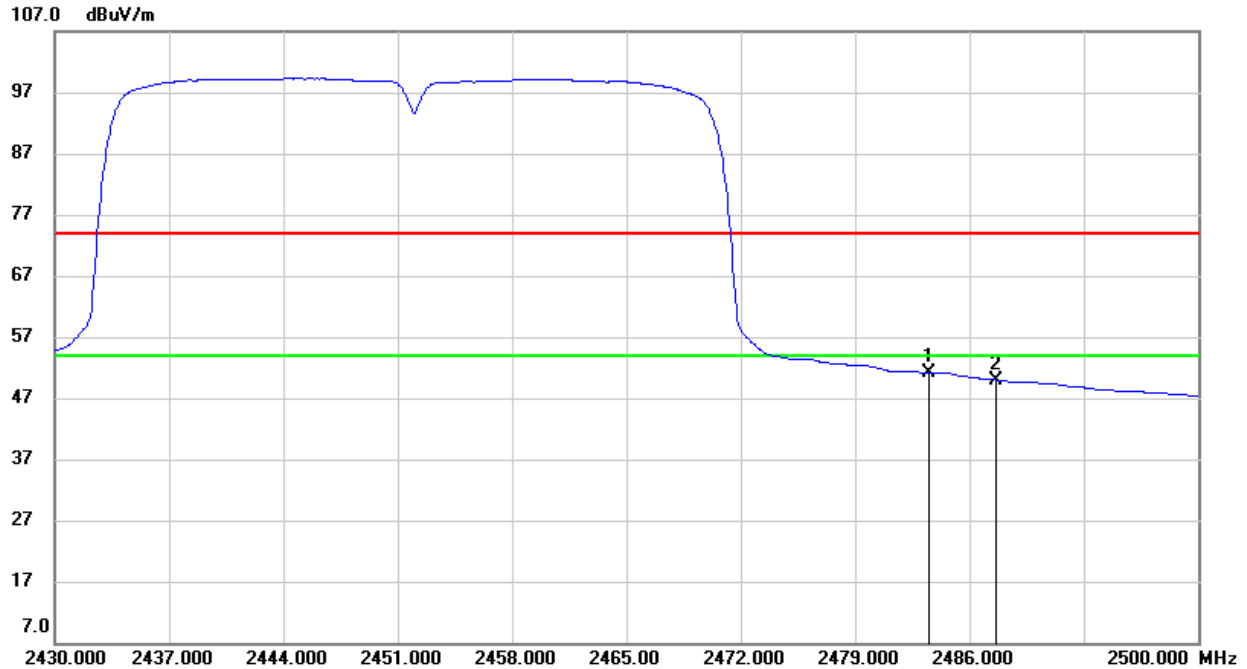
**AVG**

No.	Frequency (MHz)	Reading (dBuV)	Correct (dB/m)	Result (dBuV/m)	Limit (dBuV/m)	Margin (dB)	Remark
1	2483.500	17.51	33.58	51.09	54.00	-2.91	AVG
2	2487.610	16.37	33.61	49.98	54.00	-4.02	AVG

- Note: 1. Measurement = Reading Level + Correct Factor.
 2. If Peak Result complies with AV limit, AV Result is deemed to comply with AV limit.
 3. AVG: $VBW=1/Ton$ where: ton is transmit duration.
 4. For transmit duration, please refer to clause 8.1.
 5. Only the worst case emission was recorded, if it complies with the limit, the other emissions deemed to comply with the limit.

8.2. SPURIOUS EMISSIONS (1~3GHz)

8.2.1. 802.11b MIMO MODE

HARMONICS AND SPURIOUS EMISSIONS (LOW CHANNEL, HORIZONTAL)

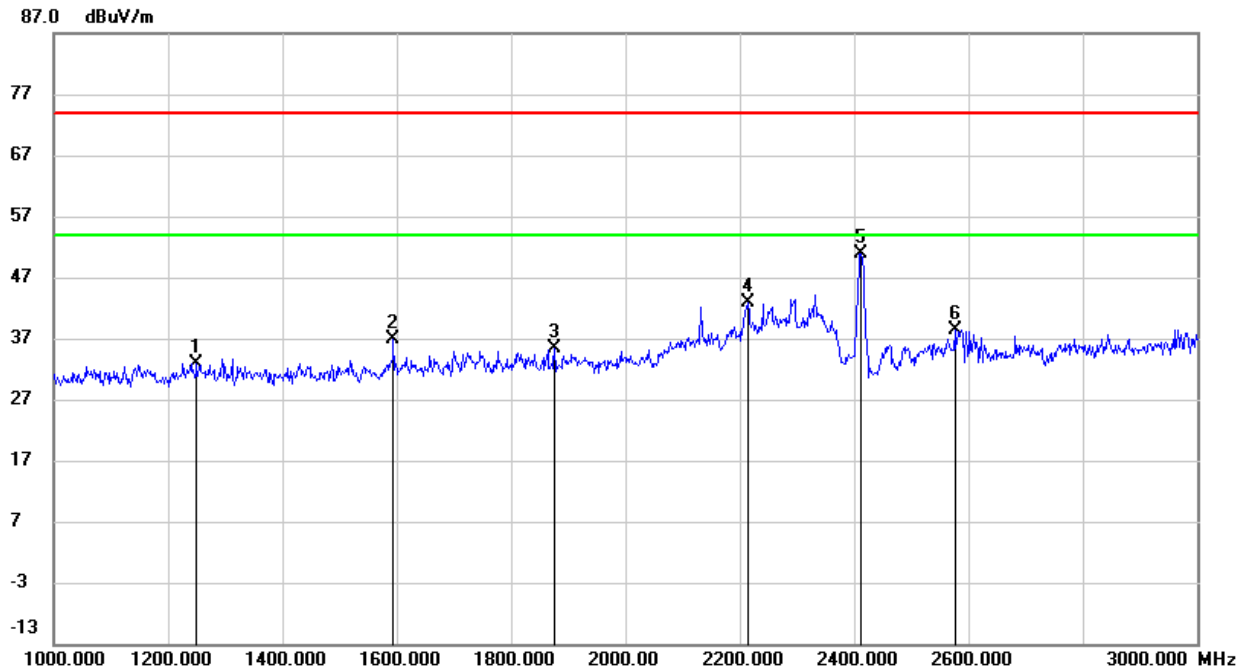

No.	Frequency (MHz)	Reading (dBuV)	Correct (dB/m)	Result (dBuV/m)	Limit (dBuV/m)	Margin (dB)	Remark
1	1250.000	45.38	-12.51	32.87	74.00	-41.13	peak
2	1594.000	48.36	-11.45	36.91	74.00	-37.09	peak
3	1876.000	45.35	-9.94	35.41	74.00	-38.59	peak
4	2214.000	51.50	-8.60	42.90	74.00	-31.10	peak
5	2412.000	58.71	-7.77	50.94	74.00	-23.06	peak
6	2576.000	45.92	-7.57	38.35	74.00	-35.65	peak

Note: 1. Measurement = Reading Level + Correct Factor.

2. If Peak Result complies with AV limit, AV Result is deemed to comply with AV limit.

3. Peak: Peak detector.

4. Filter losses were only considered in the spurious frequency bands and the authorized band was not corrected for Band reject filter losses.

5. Proper operation of the transmitter prior to adding the filter to the measurement chain.

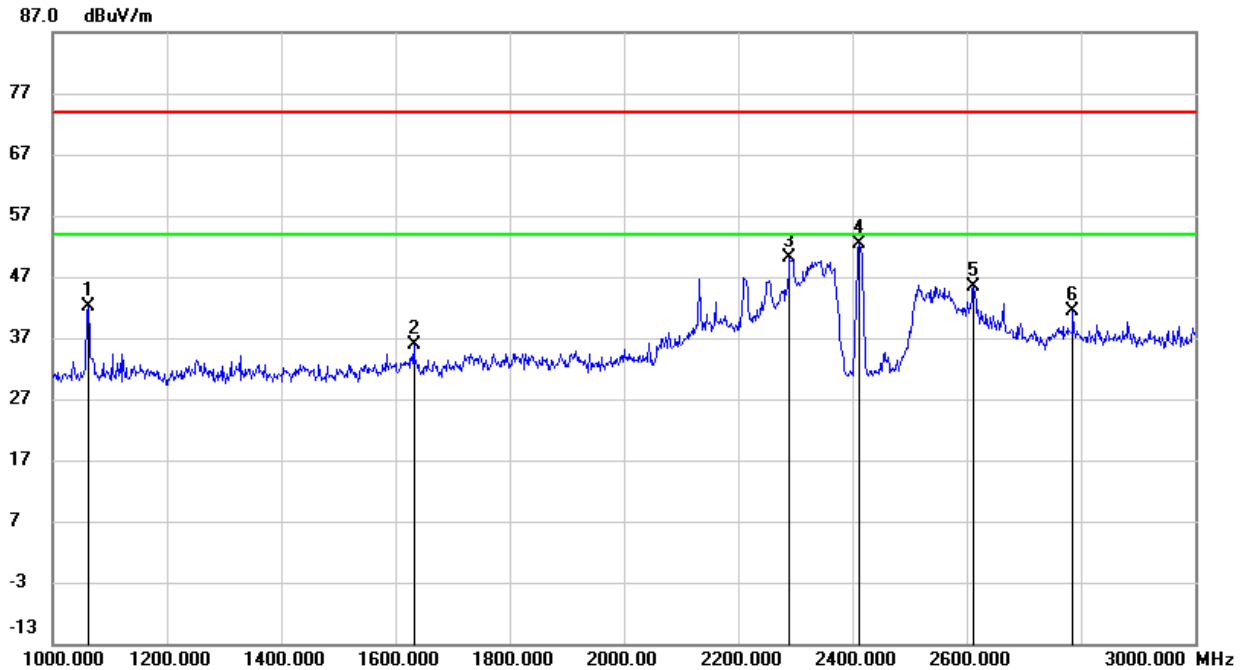
**HARMONICS AND SPURIOUS EMISSIONS (LOW CHANNEL, VERTICAL)**

No.	Frequency (MHz)	Reading (dBuV)	Correct (dB/m)	Result (dBuV/m)	Limit (dBuV/m)	Margin (dB)	Remark
1	1062.000	55.59	-13.55	42.04	74.00	-31.96	peak
2	1632.000	47.23	-11.24	35.99	74.00	-38.01	peak
3	2290.000	58.41	-8.24	50.17	74.00	-23.83	peak
4	2412.000	60.03	-7.77	52.26	74.00	-21.74	peak
5	2612.000	53.13	-7.64	45.49	74.00	-28.51	peak
6	2786.000	47.61	-6.20	41.41	74.00	-32.59	peak

- Note: 1. Measurement = Reading Level + Correct Factor.
 2. If Peak Result complies with AV limit, AV Result is deemed to comply with AV limit.
 3. Peak: Peak detector.
 4. Filter losses were only considered in the spurious frequency bands and the authorized band was not corrected for Band reject filter losses.
 5. Proper operation of the transmitter prior to adding the filter to the measurement chain.

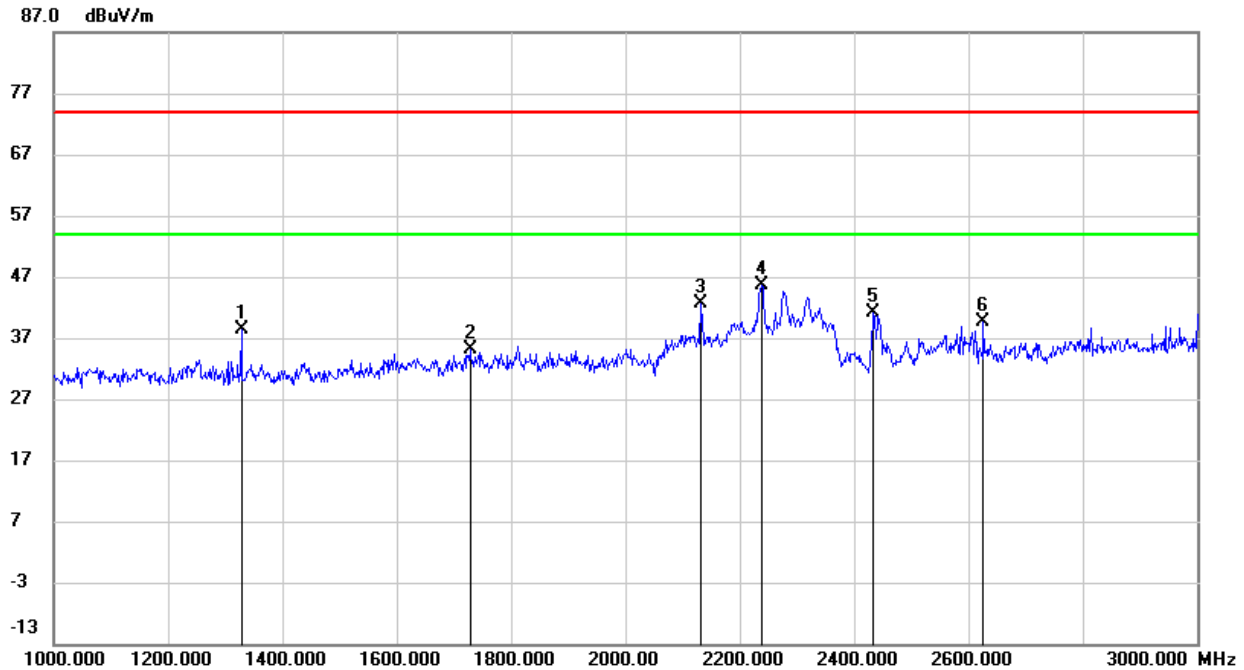
**HARMONICS AND SPURIOUS EMISSIONS (MID CHANNEL, HORIZONTAL)**

No.	Frequency (MHz)	Reading (dBuV)	Correct (dB/m)	Result (dBuV/m)	Limit (dBuV/m)	Margin (dB)	Remark
1	1328.000	50.64	-12.36	38.28	74.00	-35.72	peak
2	1728.000	45.64	-10.62	35.02	74.00	-38.98	peak
3	2132.000	51.55	-9.00	42.55	74.00	-31.45	peak
4	2238.000	54.02	-8.48	45.54	74.00	-28.46	peak
5	2434.000	48.83	-7.62	41.21	74.00	-32.79	peak
6	2626.000	47.26	-7.56	39.70	74.00	-34.30	peak

- Note: 1. Measurement = Reading Level + Correct Factor.
 2. If Peak Result complies with AV limit, AV Result is deemed to comply with AV limit.
 3. Peak: Peak detector.
 4. Filter losses were only considered in the spurious frequency bands and the authorized band was not corrected for Band reject filter losses.
 5. Proper operation of the transmitter prior to adding the filter to the measurement chain.

HARMONICS AND SPURIOUS EMISSIONS (MID CHANNEL, VERTICAL)

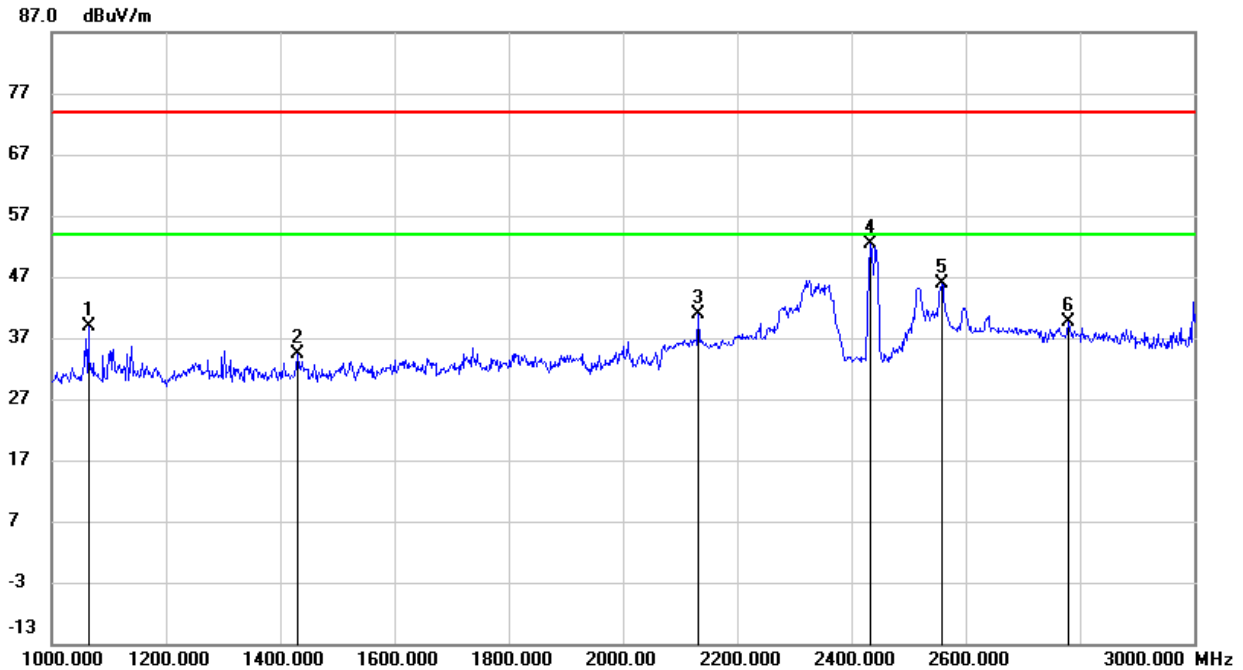

No.	Frequency (MHz)	Reading (dBuV)	Correct (dB/m)	Result (dBuV/m)	Limit (dBuV/m)	Margin (dB)	Remark
1	1064.000	52.32	-13.54	38.78	74.00	-35.22	peak
2	1430.000	46.64	-12.34	34.30	74.00	-39.70	peak
3	2132.000	49.76	-9.00	40.76	74.00	-33.24	peak
4	2434.000	60.04	-7.62	52.42	74.00	-21.58	peak
5	2558.000	53.32	-7.47	45.85	74.00	-28.15	peak
6	2780.000	45.86	-6.27	39.59	74.00	-34.41	peak

- Note: 1. Measurement = Reading Level + Correct Factor.
 2. If Peak Result complies with AV limit, AV Result is deemed to comply with AV limit.
 3. Peak: Peak detector.
 4. Filter losses were only considered in the spurious frequency bands and the authorized band was not corrected for Band reject filter losses.
 5. Proper operation of the transmitter prior to adding the filter to the measurement chain.

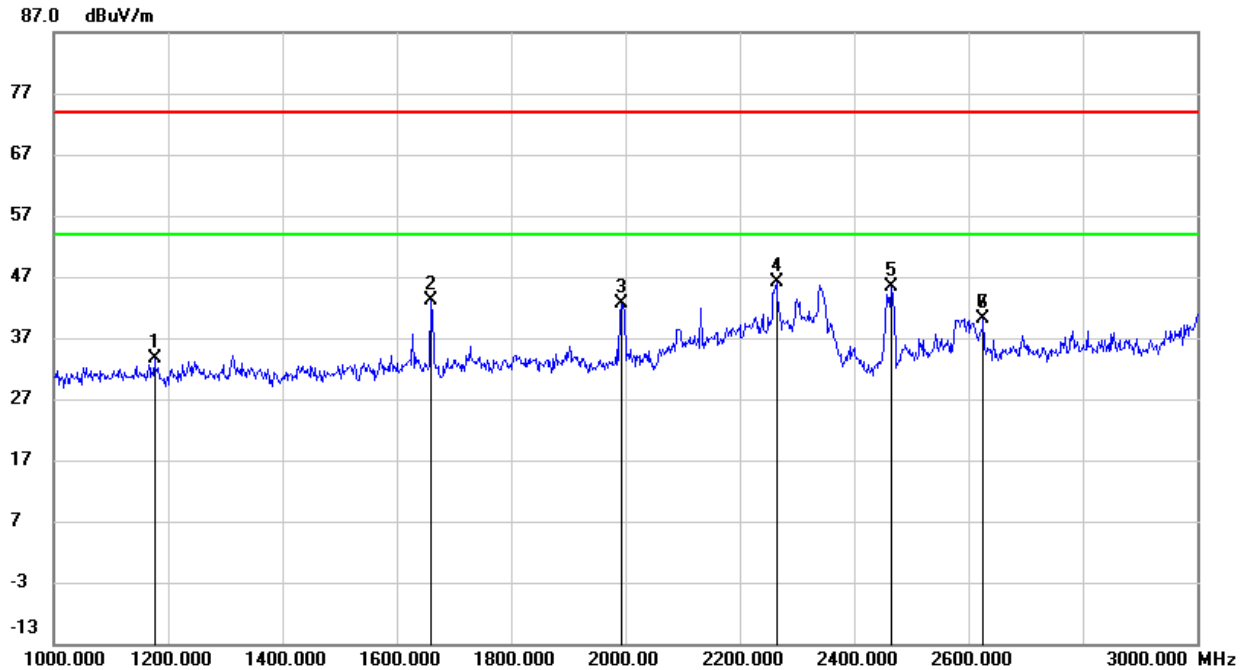
HARMONICS AND SPURIOUS EMISSIONS (HIGH CHANNEL, HORIZONTAL)

No.	Frequency (MHz)	Reading (dBuV)	Correct (dB/m)	Result (dBuV/m)	Limit (dBuV/m)	Margin (dB)	Remark
1	1176.000	46.39	-12.87	33.52	74.00	-40.48	peak
2	1660.000	54.11	-11.10	43.01	74.00	-30.99	peak
3	1994.000	52.43	-9.83	42.60	74.00	-31.40	peak
4	2264.000	54.37	-8.36	46.01	74.00	-27.99	peak
5	2466.000	52.85	-7.40	45.45	74.00	-28.55	peak
6	2626.000	47.65	-7.56	40.09	74.00	-33.91	peak
7	2626.000	47.65	-7.56	40.09	74.00	-33.91	peak

Note: 1. Measurement = Reading Level + Correct Factor.

2. If Peak Result complies with AV limit, AV Result is deemed to comply with AV limit.

3. Peak: Peak detector.

4. Filter losses were only considered in the spurious frequency bands and the authorized band was not corrected for Band reject filter losses.

5. Proper operation of the transmitter prior to adding the filter to the measurement chain.

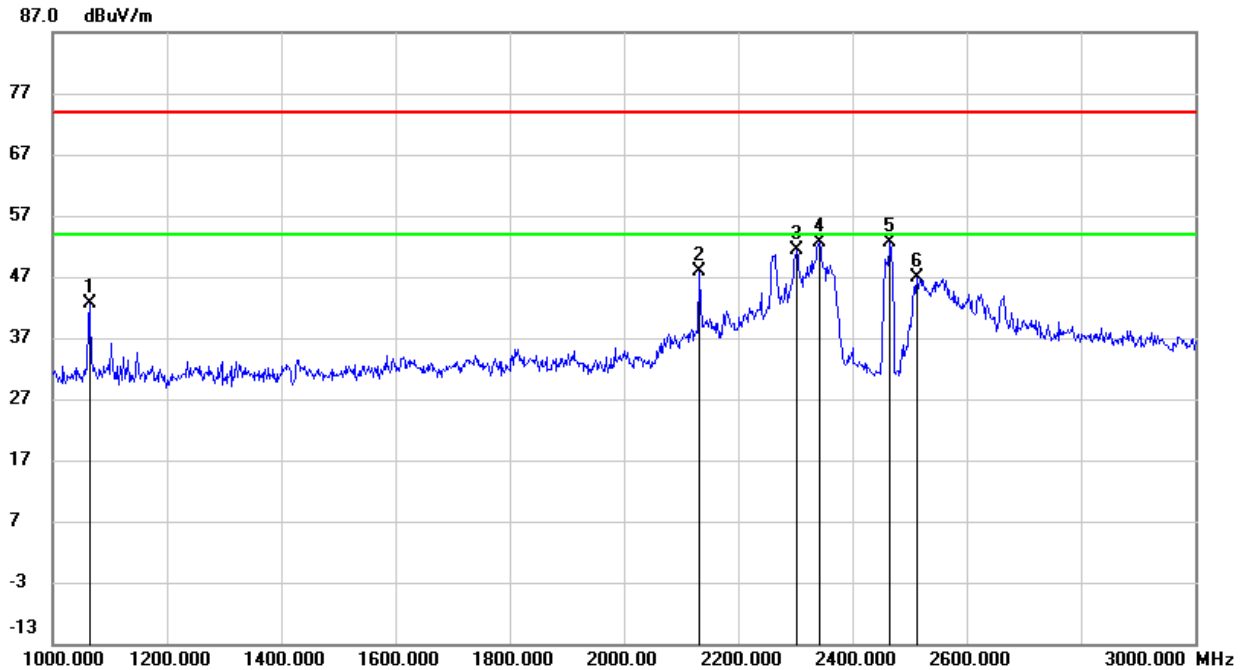
HARMONICS AND SPURIOUS EMISSIONS (HIGH CHANNEL, VERTICAL)

No.	Frequency (MHz)	Reading (dBuV)	Correct (dB/m)	Result (dBuV/m)	Limit (dBuV/m)	Margin (dB)	Remark
1	1064.000	56.29	-13.54	42.75	74.00	-31.25	peak
2	2132.000	56.84	-9.00	47.84	74.00	-26.16	peak
3	2302.000	59.51	-8.19	51.32	74.00	-22.68	peak
4	2342.000	60.78	-8.05	52.73	74.00	-21.27	peak
5	2466.000	59.93	-7.40	52.53	74.00	-21.47	peak
6	2514.000	54.22	-7.24	46.98	74.00	-27.02	peak

- Note: 1. Measurement = Reading Level + Correct Factor.
 2. If Peak Result complies with AV limit, AV Result is deemed to comply with AV limit.
 3. Peak: Peak detector.
 4. Filter losses were only considered in the spurious frequency bands and the authorized band was not corrected for Band reject filter losses.
 5. Proper operation of the transmitter prior to adding the filter to the measurement chain.

8.2.2. 802.11g MIMO MODE

HARMONICS AND SPURIOUS EMISSIONS (LOW CHANNEL, HORIZONTAL)

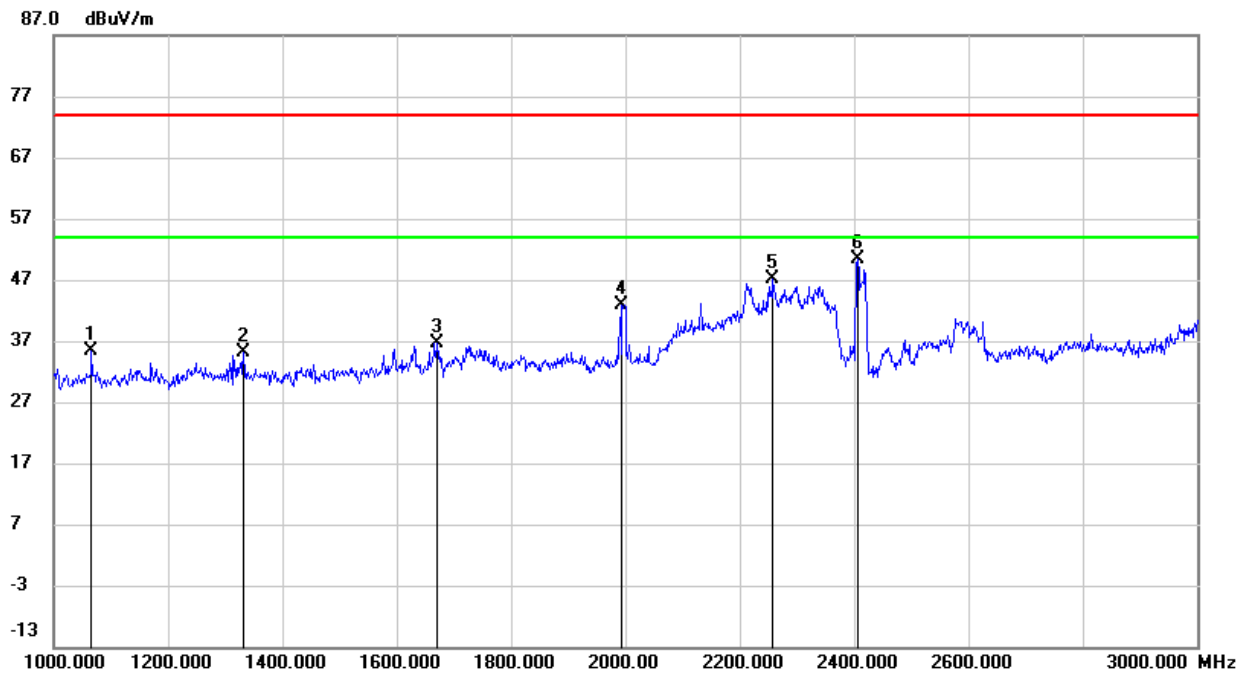

No.	Frequency (MHz)	Reading (dBuV)	Correct (dB/m)	Result (dBuV/m)	Limit (dBuV/m)	Margin (dB)	Remark
1	1066.000	49.01	-13.54	35.47	74.00	-38.53	peak
2	1332.000	47.40	-12.35	35.05	74.00	-38.95	peak
3	1670.000	47.77	-11.05	36.72	74.00	-37.28	peak
4	1994.000	52.75	-9.83	42.92	74.00	-31.08	peak
5	2258.000	55.40	-8.39	47.01	74.00	-26.99	peak
6	2406.000	58.19	-7.81	50.38	74.00	-23.62	peak

Note: 1. Measurement = Reading Level + Correct Factor.

2. If Peak Result complies with AV limit, AV Result is deemed to comply with AV limit.

3. Peak: Peak detector.

4. Filter losses were only considered in the spurious frequency bands and the authorized band was not corrected for Band reject filter losses.

5. Proper operation of the transmitter prior to adding the filter to the measurement chain.

HARMONICS AND SPURIOUS EMISSIONS (LOW CHANNEL, VERTICAL)

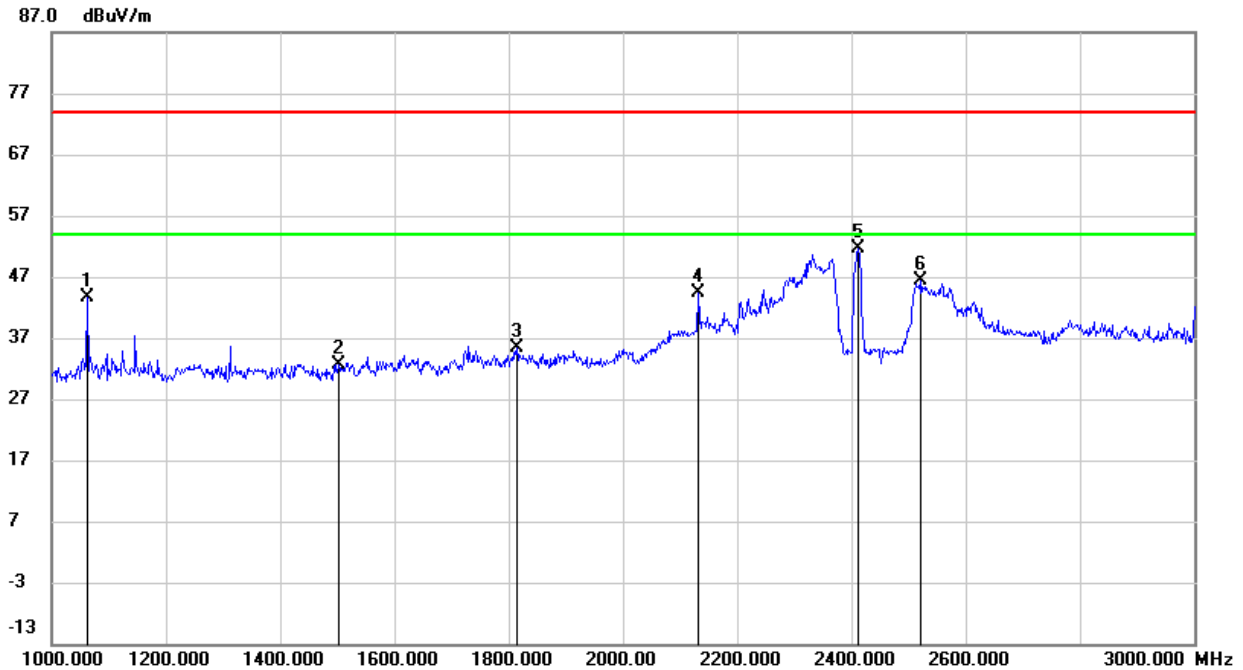

No.	Frequency (MHz)	Reading (dBuV)	Correct (dB/m)	Result (dBuV/m)	Limit (dBuV/m)	Margin (dB)	Remark
1	1062.000	57.06	-13.55	43.51	74.00	-30.49	peak
2	1502.000	44.92	-12.19	32.73	74.00	-41.27	peak
3	1814.000	45.21	-9.93	35.28	74.00	-38.72	peak
4	2132.000	53.48	-9.00	44.48	74.00	-29.52	peak
5	2412.000	59.33	-7.77	51.56	74.00	-22.44	peak
6	2522.000	53.57	-7.28	46.29	74.00	-27.71	peak

- Note: 1. Measurement = Reading Level + Correct Factor.
 2. If Peak Result complies with AV limit, AV Result is deemed to comply with AV limit.
 3. Peak: Peak detector.
 4. Filter losses were only considered in the spurious frequency bands and the authorized band was not corrected for Band reject filter losses.
 5. Proper operation of the transmitter prior to adding the filter to the measurement chain.

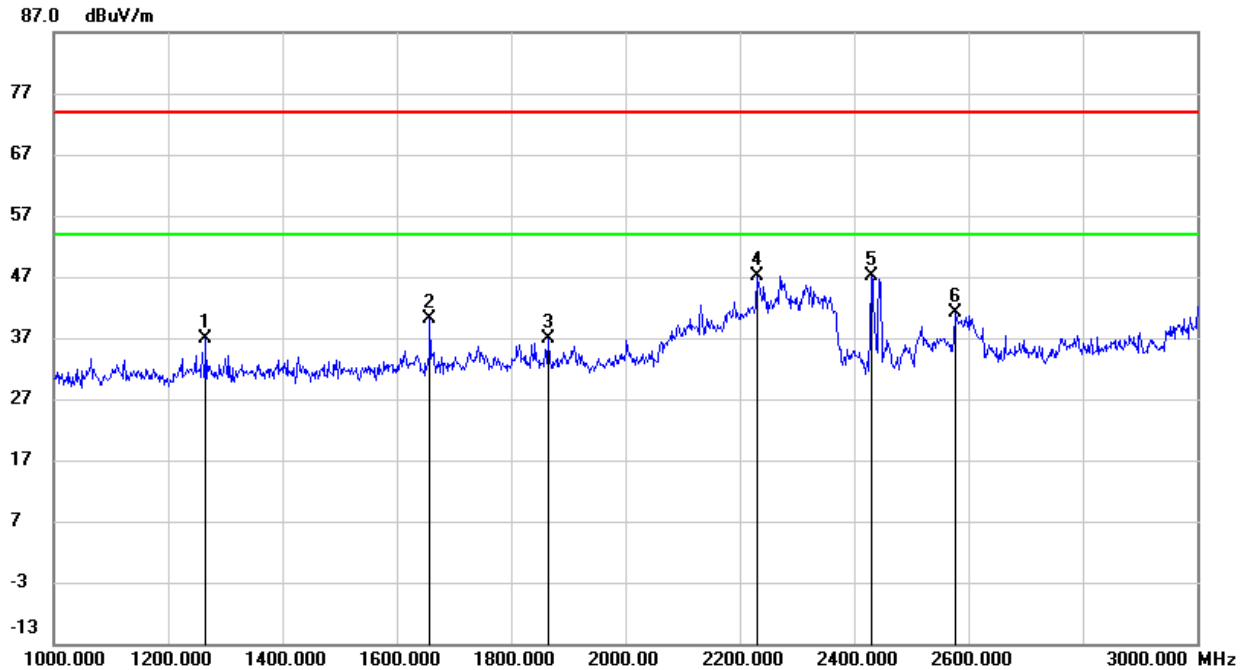
**HARMONICS AND SPURIOUS EMISSIONS (MID CHANNEL, HORIZONTAL)**

No.	Frequency (MHz)	Reading (dBuV)	Correct (dB/m)	Result (dBuV/m)	Limit (dBuV/m)	Margin (dB)	Remark
1	1266.000	49.39	-12.46	36.93	74.00	-37.07	peak
2	1658.000	51.20	-11.11	40.09	74.00	-33.91	peak
3	1864.000	46.78	-9.95	36.83	74.00	-37.17	peak
4	2230.000	55.62	-8.53	47.09	74.00	-26.91	peak
5	2430.000	54.70	-7.65	47.05	74.00	-26.95	peak
6	2576.000	48.70	-7.57	41.13	74.00	-32.87	peak

Note: 1. Measurement = Reading Level + Correct Factor.

2. If Peak Result complies with AV limit, AV Result is deemed to comply with AV limit.

3. Peak: Peak detector.

4. Filter losses were only considered in the spurious frequency bands and the authorized band was not corrected for Band reject filter losses.

5. Proper operation of the transmitter prior to adding the filter to the measurement chain.

HARMONICS AND SPURIOUS EMISSIONS (MID CHANNEL, VERTICAL)

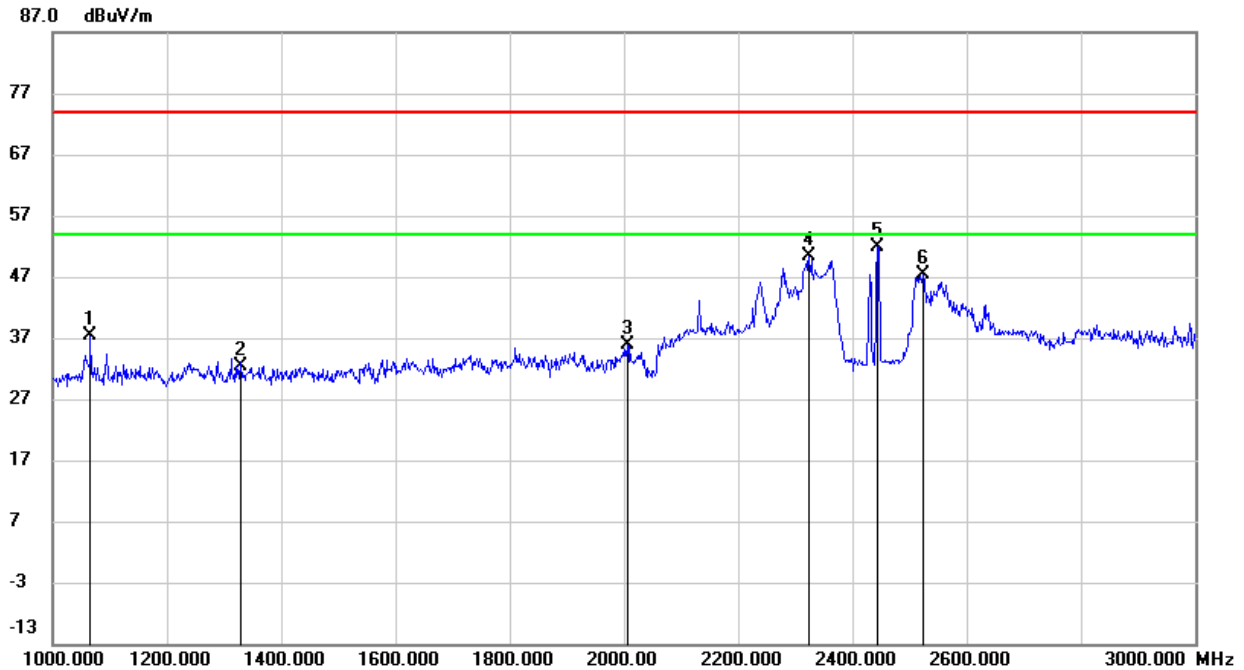

No.	Frequency (MHz)	Reading (dBuV)	Correct (dB/m)	Result (dBuV/m)	Limit (dBuV/m)	Margin (dB)	Remark
1	1066.000	50.92	-13.54	37.38	74.00	-36.62	peak
2	1330.000	44.81	-12.36	32.45	74.00	-41.55	peak
3	2006.000	45.58	-9.78	35.80	74.00	-38.20	peak
4	2324.000	58.53	-8.12	50.41	74.00	-23.59	peak
5	2444.000	59.42	-7.55	51.87	74.00	-22.13	peak
6	2524.000	54.65	-7.29	47.36	74.00	-26.64	peak

- Note: 1. Measurement = Reading Level + Correct Factor.
 2. If Peak Result complies with AV limit, AV Result is deemed to comply with AV limit.
 3. Peak: Peak detector.
 4. Filter losses were only considered in the spurious frequency bands and the authorized band was not corrected for Band reject filter losses.
 5. Proper operation of the transmitter prior to adding the filter to the measurement chain.

HARMONICS AND SPURIOUS EMISSIONS (HIGH CHANNEL, HORIZONTAL)

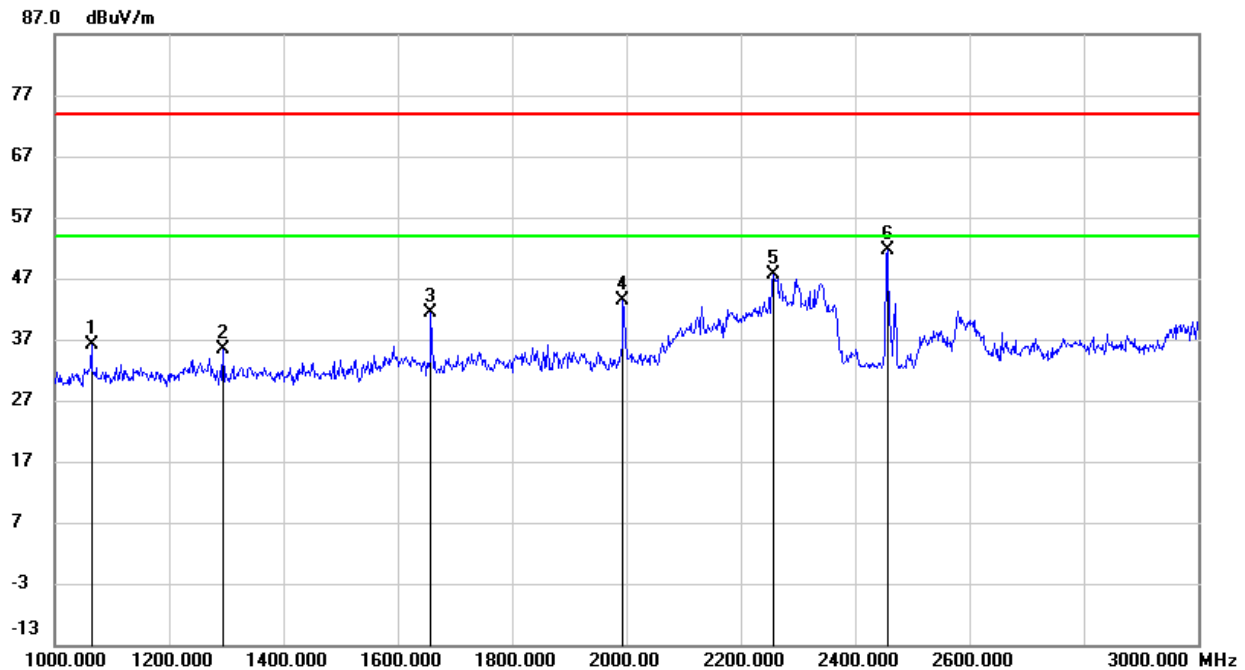

No.	Frequency (MHz)	Reading (dBuV)	Correct (dB/m)	Result (dBuV/m)	Limit (dBuV/m)	Margin (dB)	Remark
1	1064.000	49.77	-13.54	36.23	74.00	-37.77	peak
2	1294.000	47.71	-12.36	35.35	74.00	-38.65	peak
3	1658.000	52.52	-11.11	41.41	74.00	-32.59	peak
4	1994.000	53.33	-9.83	43.50	74.00	-30.50	peak
5	2256.000	55.94	-8.40	47.54	74.00	-26.46	peak
6	2456.000	59.13	-7.47	51.66	74.00	-22.34	peak

- Note: 1. Measurement = Reading Level + Correct Factor.
 2. If Peak Result complies with AV limit, AV Result is deemed to comply with AV limit.
 3. Peak: Peak detector.
 4. Filter losses were only considered in the spurious frequency bands and the authorized band was not corrected for Band reject filter losses.
 5. Proper operation of the transmitter prior to adding the filter to the measurement chain.

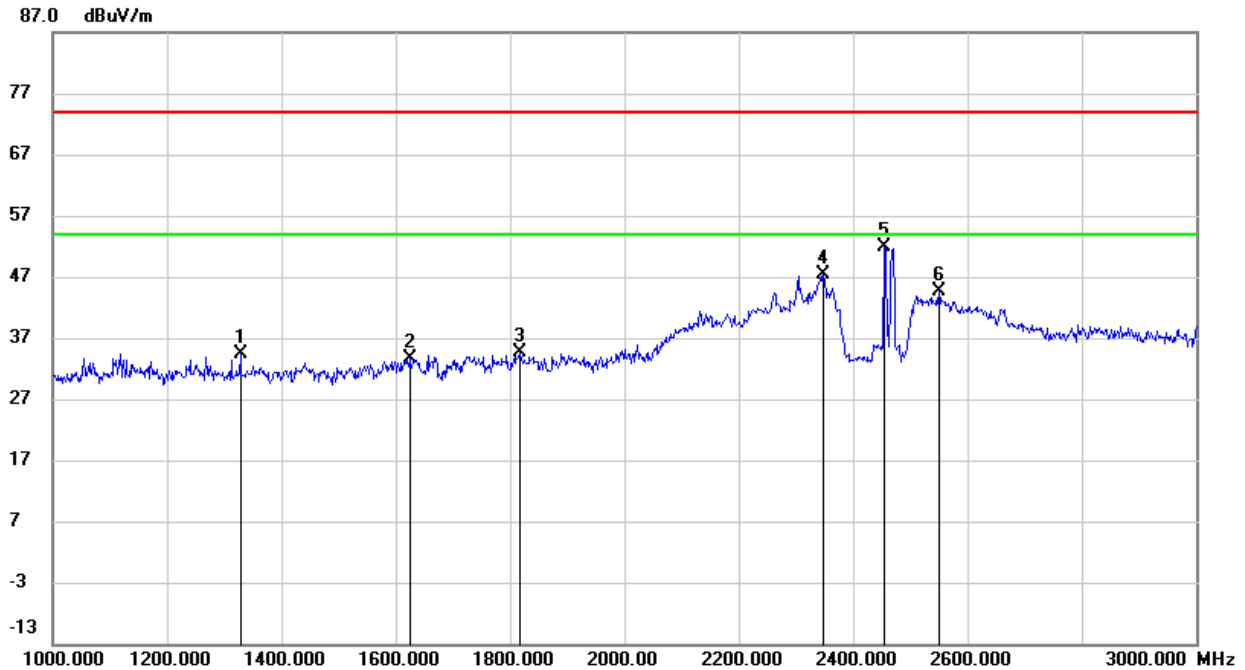
**HARMONICS AND SPURIOUS EMISSIONS (HIGH CHANNEL, VERTICAL)**

No.	Frequency (MHz)	Reading (dBuV)	Correct (dB/m)	Result (dBuV/m)	Limit (dBuV/m)	Margin (dB)	Remark
1	1328.000	46.66	-12.36	34.30	74.00	-39.70	peak
2	1624.000	44.83	-11.28	33.55	74.00	-40.45	peak
3	1816.000	44.56	-9.92	34.64	74.00	-39.36	peak
4	2348.000	55.52	-8.03	47.49	74.00	-26.51	peak
5	2454.000	59.45	-7.48	51.97	74.00	-22.03	peak
6	2550.000	52.18	-7.44	44.74	74.00	-29.26	peak

- Note: 1. Measurement = Reading Level + Correct Factor.
 2. If Peak Result complies with AV limit, AV Result is deemed to comply with AV limit.
 3. Peak: Peak detector.
 4. Filter losses were only considered in the spurious frequency bands and the authorized band was not corrected for Band reject filter losses.
 5. Proper operation of the transmitter prior to adding the filter to the measurement chain.

8.2.3. 802.11n HT20 MIMO MODE

HARMONICS AND SPURIOUS EMISSIONS (LOW CHANNEL, HORIZONTAL)

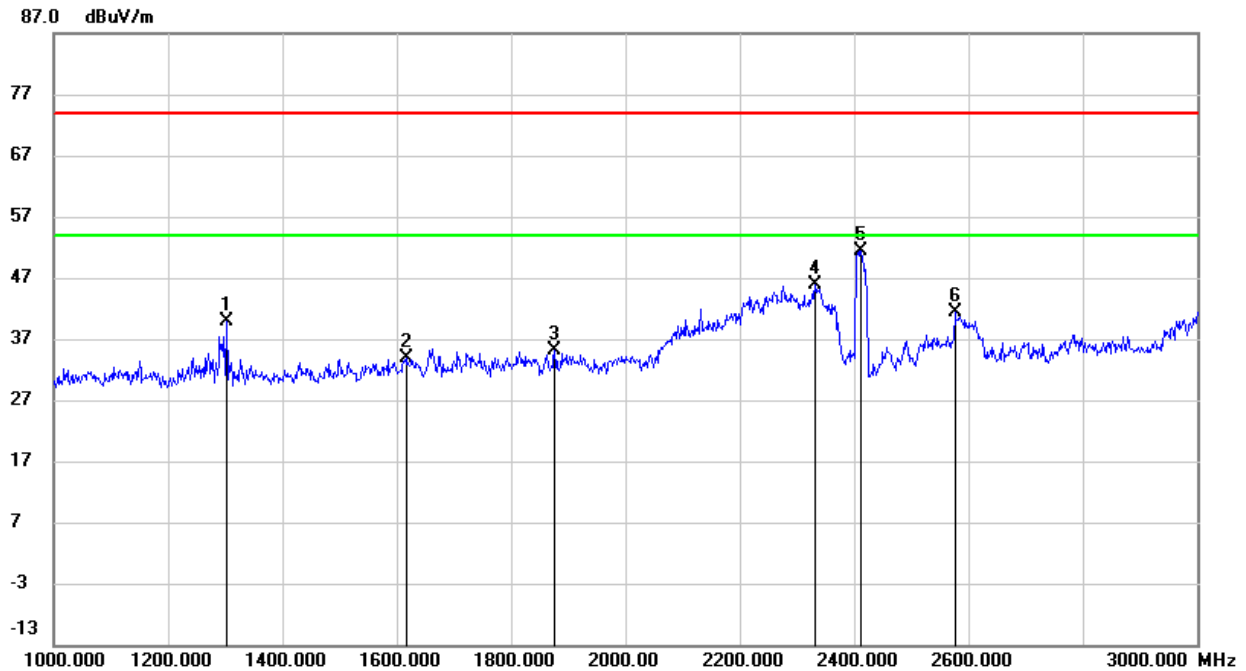

No.	Frequency (MHz)	Reading (dBuV)	Correct (dB/m)	Result (dBuV/m)	Limit (dBuV/m)	Margin (dB)	Remark
1	1302.000	52.11	-12.34	39.77	74.00	-34.23	peak
2	1618.000	45.10	-11.31	33.79	74.00	-40.21	peak
3	1876.000	44.99	-9.94	35.05	74.00	-38.95	peak
4	2332.000	53.92	-8.08	45.84	74.00	-28.16	peak
5	2412.000	59.11	-7.77	51.34	74.00	-22.66	peak
6	2576.000	48.92	-7.57	41.35	74.00	-32.65	peak

- Note: 1. Measurement = Reading Level + Correct Factor.
 2. If Peak Result complies with AV limit, AV Result is deemed to comply with AV limit.
 3. Peak: Peak detector.
 4. Filter losses were only considered in the spurious frequency bands and the authorized band was not corrected for Band reject filter losses.
 5. Proper operation of the transmitter prior to adding the filter to the measurement chain.

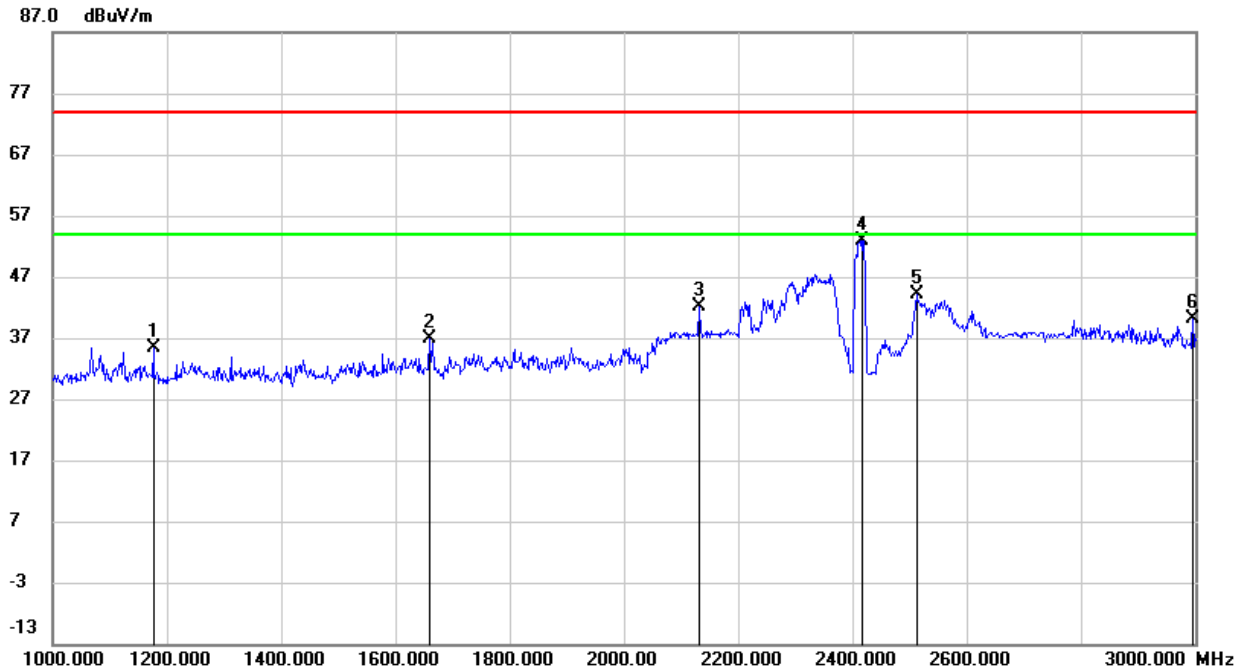
**HARMONICS AND SPURIOUS EMISSIONS (LOW CHANNEL, VERTICAL)**

No.	Frequency (MHz)	Reading (dBuV)	Correct (dB/m)	Result (dBuV/m)	Limit (dBuV/m)	Margin (dB)	Remark
1	1176.000	48.14	-12.87	35.27	74.00	-38.73	peak
2	1660.000	48.05	-11.10	36.95	74.00	-37.05	peak
3	2132.000	51.20	-9.00	42.20	74.00	-31.80	peak
4	2418.000	60.68	-7.74	52.94	74.00	-21.06	peak
5	2512.000	51.36	-7.23	44.13	74.00	-29.87	peak
6	2996.000	45.51	-5.30	40.21	74.00	-33.79	peak

- Note: 1. Measurement = Reading Level + Correct Factor.
 2. If Peak Result complies with AV limit, AV Result is deemed to comply with AV limit.
 3. Peak: Peak detector.
 4. Filter losses were only considered in the spurious frequency bands and the authorized band was not corrected for Band reject filter losses.
 5. Proper operation of the transmitter prior to adding the filter to the measurement chain.

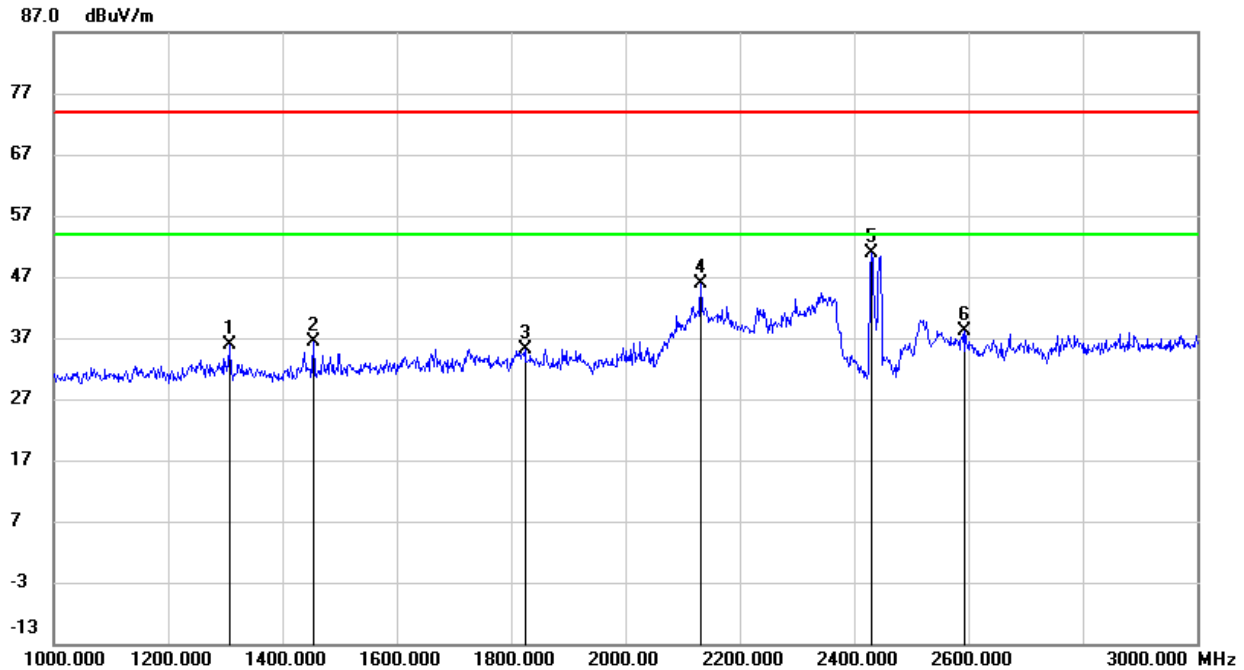
**HARMONICS AND SPURIOUS EMISSIONS (MID CHANNEL, HORIZONTAL)**

No.	Frequency (MHz)	Reading (dBuV)	Correct (dB/m)	Result (dBuV/m)	Limit (dBuV/m)	Margin (dB)	Remark
1	1308.000	48.17	-12.36	35.81	74.00	-38.19	peak
2	1454.000	48.65	-12.28	36.37	74.00	-37.63	peak
3	1824.000	45.17	-9.93	35.24	74.00	-38.76	peak
4	2132.000	54.80	-9.00	45.80	74.00	-28.20	peak
5	2430.000	58.54	-7.65	50.89	74.00	-23.11	peak
6	2594.000	45.88	-7.67	38.21	74.00	-35.79	peak

- Note: 1. Measurement = Reading Level + Correct Factor.
 2. If Peak Result complies with AV limit, AV Result is deemed to comply with AV limit.
 3. Peak: Peak detector.
 4. Filter losses were only considered in the spurious frequency bands and the authorized band was not corrected for Band reject filter losses.
 5. Proper operation of the transmitter prior to adding the filter to the measurement chain.

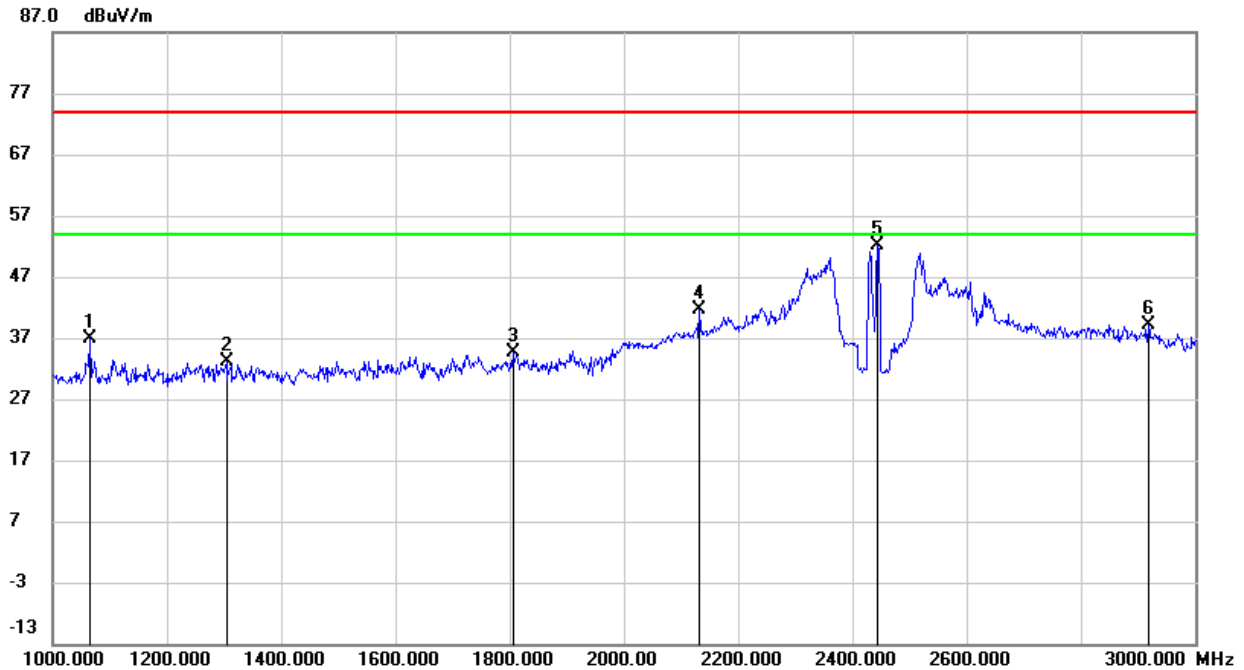
HARMONICS AND SPURIOUS EMISSIONS (MID CHANNEL, VERTICAL)

No.	Frequency (MHz)	Reading (dBuV)	Correct (dB/m)	Result (dBuV/m)	Limit (dBuV/m)	Margin (dB)	Remark
1	1066.000	50.33	-13.54	36.79	74.00	-37.21	peak
2	1304.000	45.41	-12.34	33.07	74.00	-40.93	peak
3	1806.000	44.66	-9.92	34.74	74.00	-39.26	peak
4	2132.000	50.65	-9.00	41.65	74.00	-32.35	peak
5	2444.000	59.76	-7.55	52.21	74.00	-21.79	peak
6	2918.000	44.57	-5.48	39.09	74.00	-34.91	peak

- Note: 1. Measurement = Reading Level + Correct Factor.
 2. If Peak Result complies with AV limit, AV Result is deemed to comply with AV limit.
 3. Peak: Peak detector.
 4. Filter losses were only considered in the spurious frequency bands and the authorized band was not corrected for Band reject filter losses.
 5. Proper operation of the transmitter prior to adding the filter to the measurement chain.

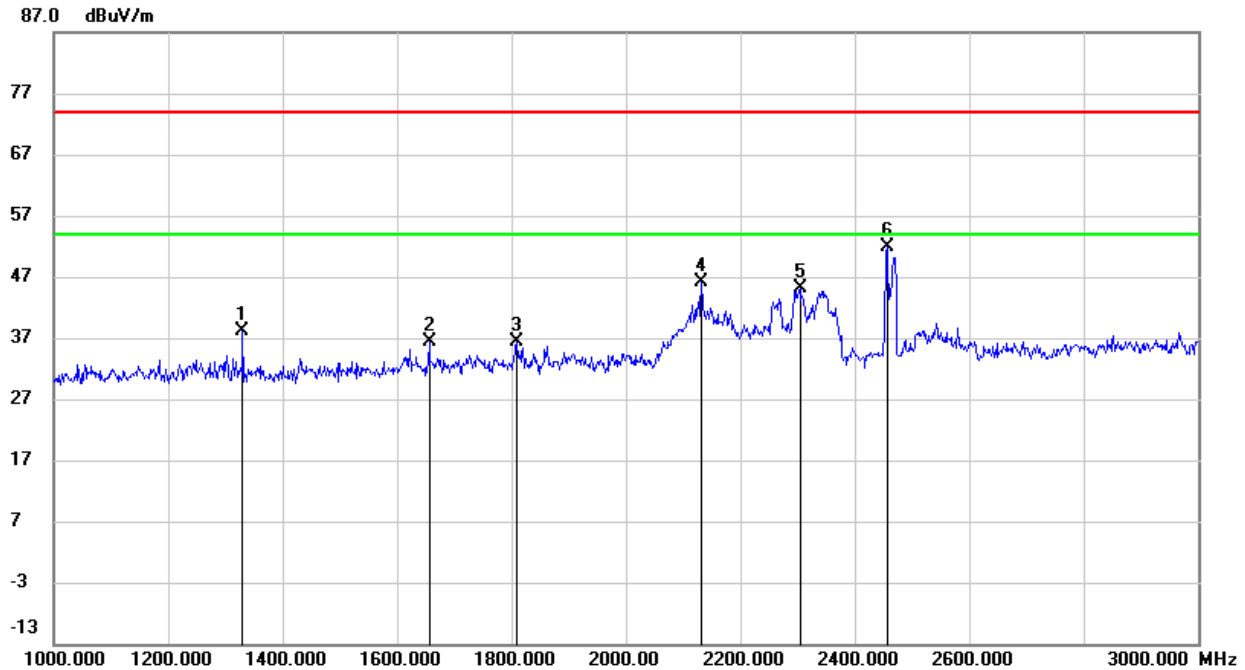
**HARMONICS AND SPURIOUS EMISSIONS (HIGH CHANNEL, HORIZONTAL)**

No.	Frequency (MHz)	Reading (dBuV)	Correct (dB/m)	Result (dBuV/m)	Limit (dBuV/m)	Margin (dB)	Remark
1	1330.000	50.52	-12.36	38.16	74.00	-35.84	peak
2	1656.000	47.43	-11.13	36.30	74.00	-37.70	peak
3	1808.000	46.39	-9.92	36.47	74.00	-37.53	peak
4	2132.000	55.01	-9.00	46.01	74.00	-27.99	peak
5	2304.000	53.21	-8.18	45.03	74.00	-28.97	peak
6	2456.000	59.35	-7.47	51.88	74.00	-22.12	peak

- Note: 1. Measurement = Reading Level + Correct Factor.
 2. If Peak Result complies with AV limit, AV Result is deemed to comply with AV limit.
 3. Peak: Peak detector.
 4. Filter losses were only considered in the spurious frequency bands and the authorized band was not corrected for Band reject filter losses.
 5. Proper operation of the transmitter prior to adding the filter to the measurement chain.

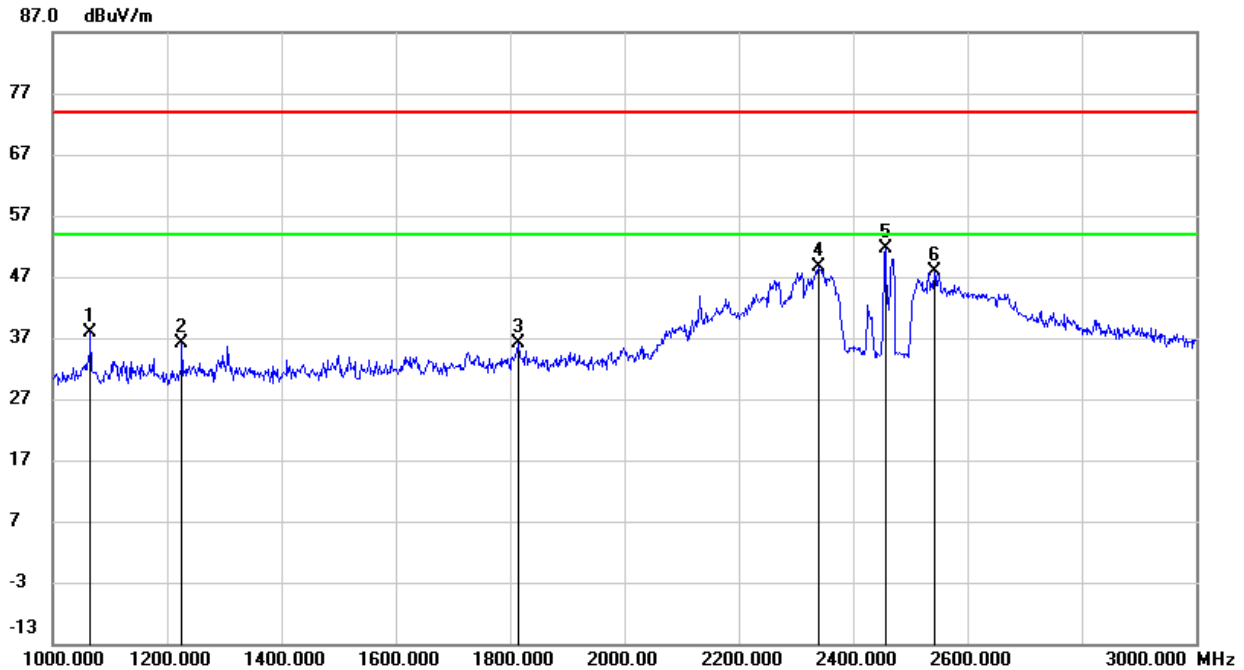
**HARMONICS AND SPURIOUS EMISSIONS (HIGH CHANNEL, VERTICAL)**

No.	Frequency (MHz)	Reading (dBuV)	Correct (dB/m)	Result (dBuV/m)	Limit (dBuV/m)	Margin (dB)	Remark
1	1066.000	51.39	-13.54	37.85	74.00	-36.15	peak
2	1226.000	48.75	-12.59	36.16	74.00	-37.84	peak
3	1814.000	46.17	-9.93	36.24	74.00	-37.76	peak
4	2340.000	56.72	-8.06	48.66	74.00	-25.34	peak
5	2456.000	59.05	-7.47	51.58	74.00	-22.42	peak
6	2542.000	55.30	-7.39	47.91	74.00	-26.09	peak

- Note: 1. Measurement = Reading Level + Correct Factor.
 2. If Peak Result complies with AV limit, AV Result is deemed to comply with AV limit.
 3. Peak: Peak detector.
 4. Filter losses were only considered in the spurious frequency bands and the authorized band was not corrected for Band reject filter losses.
 5. Proper operation of the transmitter prior to adding the filter to the measurement chain.

8.2.4. 802.11n HT40 MIMO MODE

HARMONICS AND SPURIOUS EMISSIONS (LOW CHANNEL, HORIZONTAL)

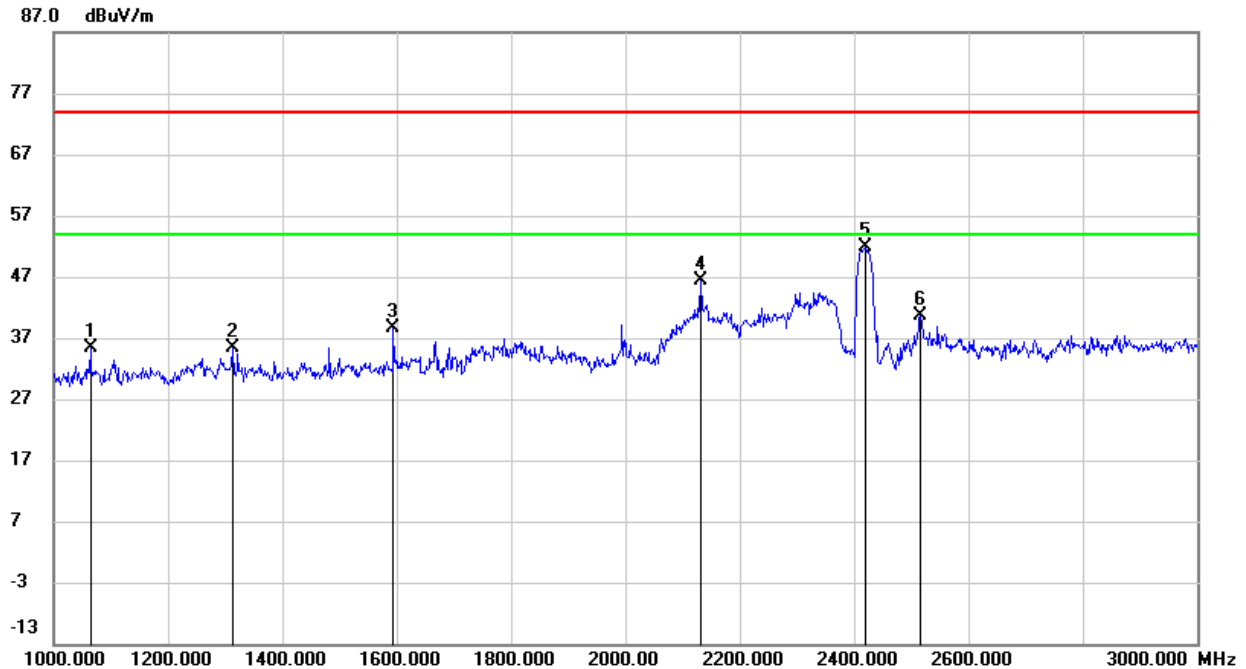

No.	Frequency (MHz)	Reading (dBuV)	Correct (dB/m)	Result (dBuV/m)	Limit (dBuV/m)	Margin (dB)	Remark
1	1064.000	48.81	-13.54	35.27	74.00	-38.73	peak
2	1312.000	47.79	-12.35	35.44	74.00	-38.56	peak
3	1594.000	50.01	-11.45	38.56	74.00	-35.44	peak
4	2132.000	55.42	-9.00	46.42	74.00	-27.58	peak
5	2420.000	59.66	-7.72	51.94	74.00	-22.06	peak
6	2516.000	47.80	-7.25	40.55	74.00	-33.45	peak

Note: 1. Measurement = Reading Level + Correct Factor.

2. If Peak Result complies with AV limit, AV Result is deemed to comply with AV limit.

3. Peak: Peak detector.

4. Filter losses were only considered in the spurious frequency bands and the authorized band was not corrected for Band reject filter losses.

5. Proper operation of the transmitter prior to adding the filter to the measurement chain.

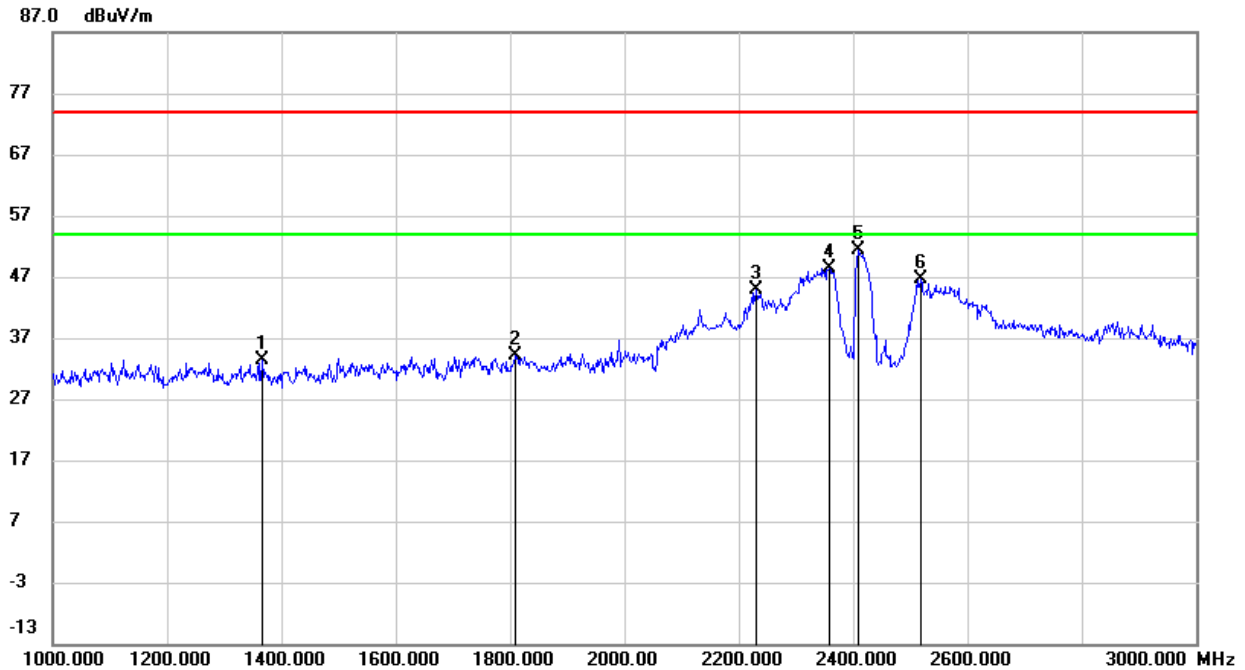
HARMONICS AND SPURIOUS EMISSIONS (LOW CHANNEL, VERTICAL)

No.	Frequency (MHz)	Reading (dBuV)	Correct (dB/m)	Result (dBuV/m)	Limit (dBuV/m)	Margin (dB)	Remark
1	1366.000	45.82	-12.37	33.45	74.00	-40.55	peak
2	1810.000	43.93	-9.92	34.01	74.00	-39.99	peak
3	2230.000	53.29	-8.53	44.76	74.00	-29.24	peak
4	2358.000	56.42	-8.00	48.42	74.00	-25.58	peak
5	2410.000	59.17	-7.78	51.39	74.00	-22.61	peak
6	2518.000	53.84	-7.27	46.57	74.00	-27.43	peak

- Note: 1. Measurement = Reading Level + Correct Factor.
 2. If Peak Result complies with AV limit, AV Result is deemed to comply with AV limit.
 3. Peak: Peak detector.
 4. Filter losses were only considered in the spurious frequency bands and the authorized band was not corrected for Band reject filter losses.
 5. Proper operation of the transmitter prior to adding the filter to the measurement chain.

HARMONICS AND SPURIOUS EMISSIONS (MID CHANNEL, HORIZONTAL)

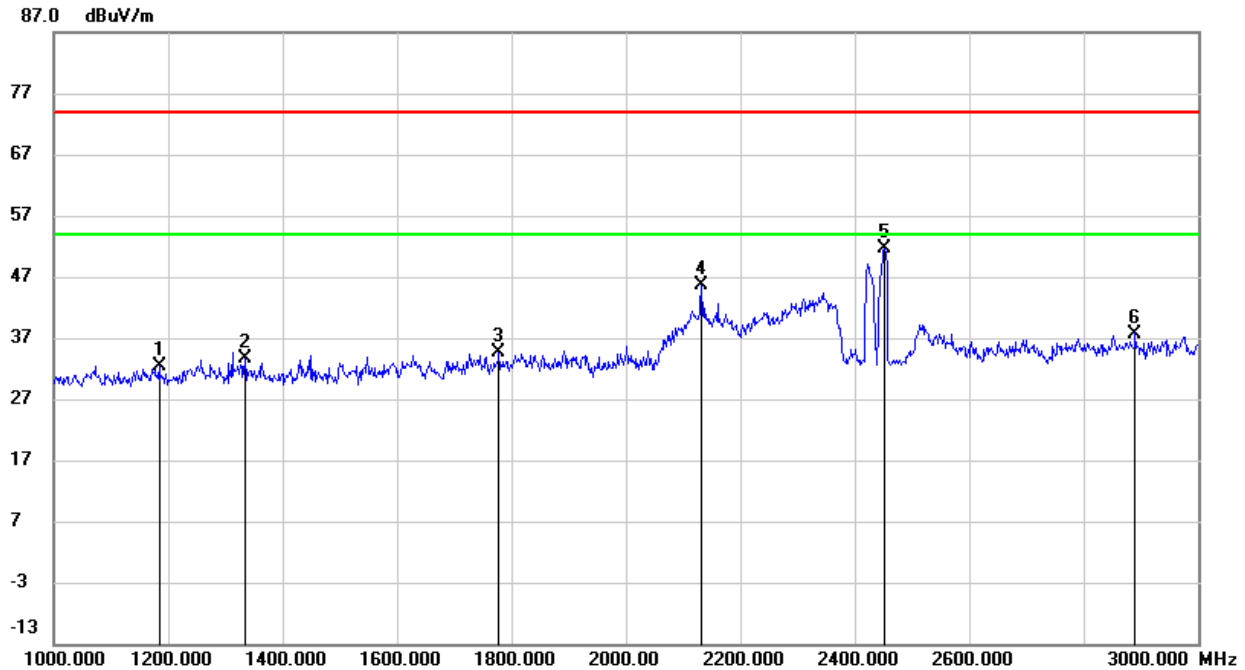

No.	Frequency (MHz)	Reading (dBuV)	Correct (dB/m)	Result (dBuV/m)	Limit (dBuV/m)	Margin (dB)	Remark
1	1184.000	45.30	-12.81	32.49	74.00	-41.51	peak
2	1334.000	46.11	-12.36	33.75	74.00	-40.25	peak
3	1778.000	44.68	-10.13	34.55	74.00	-39.45	peak
4	2132.000	54.72	-9.00	45.72	74.00	-28.28	peak
5	2452.000	59.07	-7.50	51.57	74.00	-22.43	peak
6	2890.000	43.33	-5.58	37.75	74.00	-36.25	peak

- Note: 1. Measurement = Reading Level + Correct Factor.
 2. If Peak Result complies with AV limit, AV Result is deemed to comply with AV limit.
 3. Peak: Peak detector.
 4. Filter losses were only considered in the spurious frequency bands and the authorized band was not corrected for Band reject filter losses.
 5. Proper operation of the transmitter prior to adding the filter to the measurement chain.

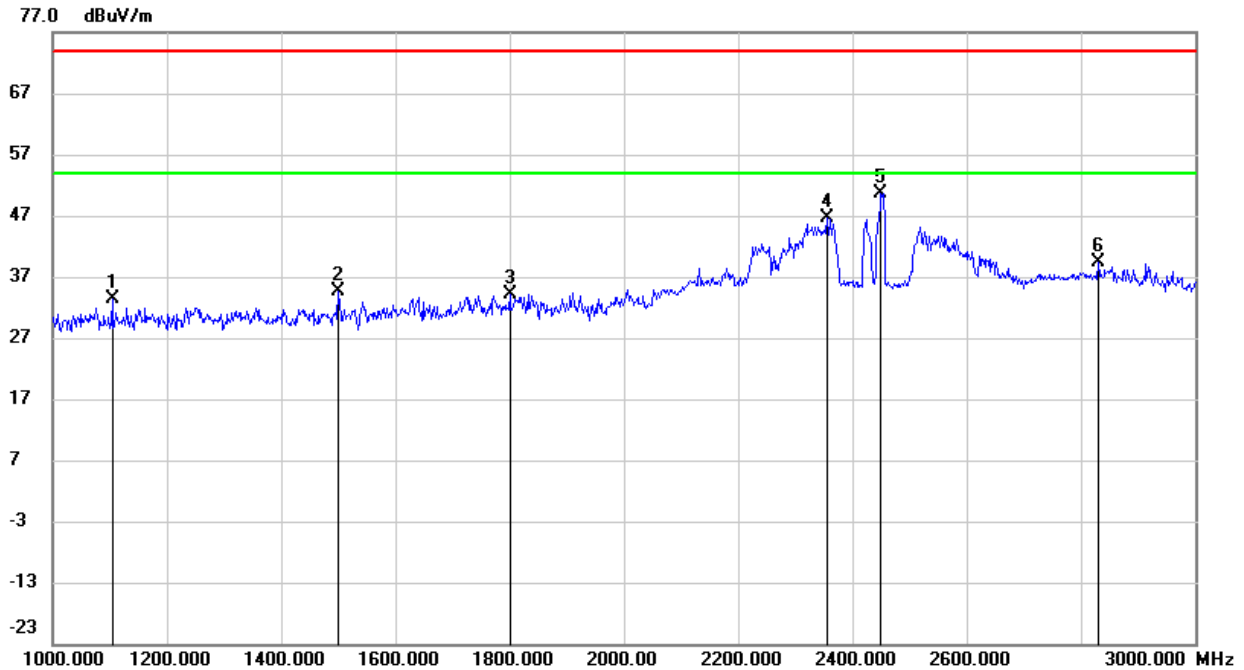
HARMONICS AND SPURIOUS EMISSIONS (MID CHANNEL, VERTICAL)

No.	Frequency (MHz)	Reading (dBuV)	Correct (dB/m)	Result (dBuV/m)	Limit (dBuV/m)	Margin (dB)	Remark
1	1104.000	46.83	-13.48	33.35	74.00	-40.65	peak
2	1500.000	46.94	-12.21	34.73	74.00	-39.27	peak
3	1800.000	44.04	-9.91	34.13	74.00	-39.87	peak
4	2356.000	54.66	-8.00	46.66	74.00	-27.34	peak
5	2450.000	58.20	-7.51	50.69	74.00	-23.31	peak
6	2830.000	45.25	-5.89	39.36	74.00	-34.64	peak

- Note: 1. Measurement = Reading Level + Correct Factor.
 2. If Peak Result complies with AV limit, AV Result is deemed to comply with AV limit.
 3. Peak: Peak detector.
 4. Filter losses were only considered in the spurious frequency bands and the authorized band was not corrected for Band reject filter losses.
 5. Proper operation of the transmitter prior to adding the filter to the measurement chain.

HARMONICS AND SPURIOUS EMISSIONS (HIGH CHANNEL, HORIZONTAL)

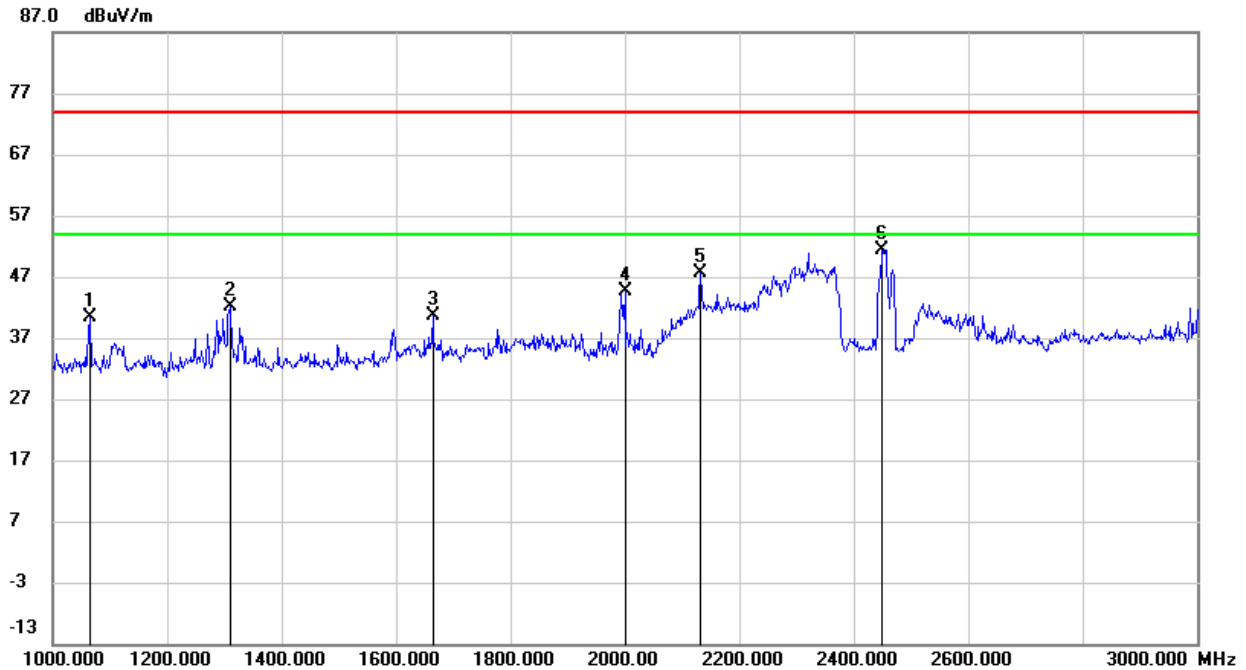

No.	Frequency (MHz)	Reading (dBuV)	Correct (dB/m)	Result (dBuV/m)	Limit (dBuV/m)	Margin (dB)	Remark
1	1066.000	53.84	-13.54	40.30	74.00	-33.70	peak
2	1310.000	54.51	-12.35	42.16	74.00	-31.84	peak
3	1664.000	51.62	-11.09	40.53	74.00	-33.47	peak
4	2000.000	54.41	-9.82	44.59	74.00	-29.41	peak
5	2132.000	56.59	-9.00	47.59	74.00	-26.41	peak
6	2450.000	59.01	-7.51	51.50	74.00	-22.50	peak

- Note: 1. Measurement = Reading Level + Correct Factor.
 2. If Peak Result complies with AV limit, AV Result is deemed to comply with AV limit.
 3. Peak: Peak detector.
 4. Filter losses were only considered in the spurious frequency bands and the authorized band was not corrected for Band reject filter losses.
 5. Proper operation of the transmitter prior to adding the filter to the measurement chain.

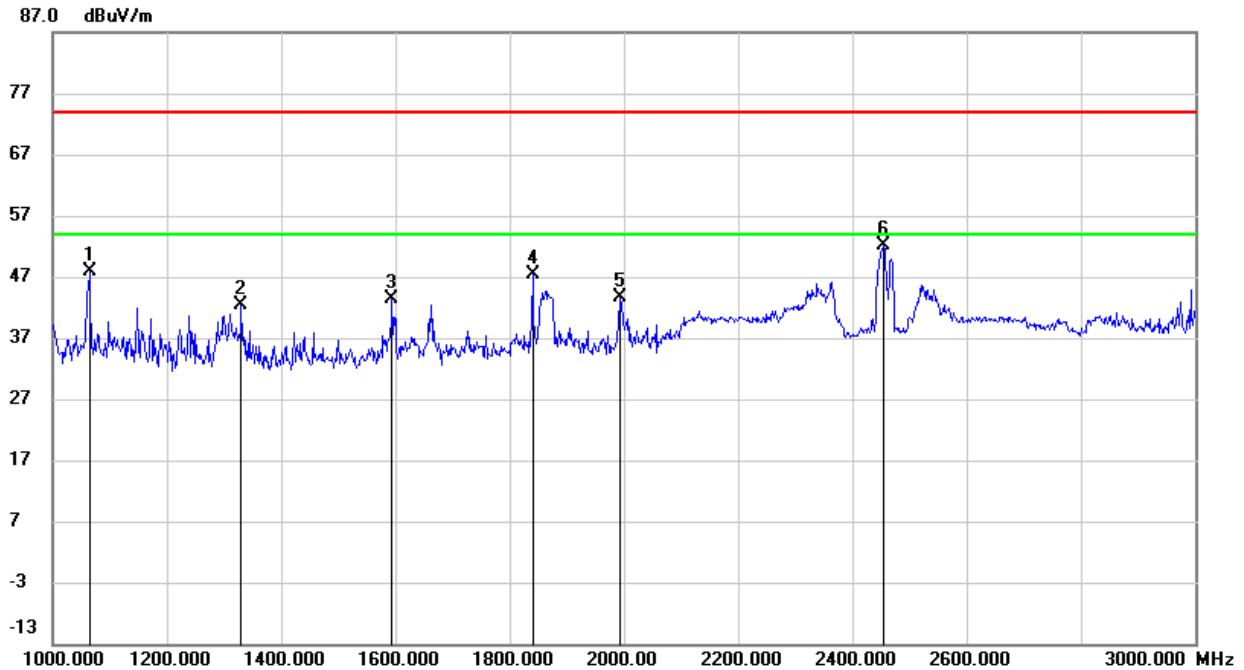
**HARMONICS AND SPURIOUS EMISSIONS (HIGH CHANNEL, VERTICAL)**

No.	Frequency (MHz)	Reading (dBuV)	Correct (dB/m)	Result (dBuV/m)	Limit (dBuV/m)	Margin (dB)	Remark
1	1064.000	61.48	-13.54	47.94	74.00	-26.06	peak
2	1330.000	54.70	-12.36	42.34	74.00	-31.66	peak
3	1594.000	54.79	-11.45	43.34	74.00	-30.66	peak
4	1840.000	57.24	-9.93	47.31	74.00	-26.69	peak
5	1994.000	53.40	-9.83	43.57	74.00	-30.43	peak
6	2454.000	59.53	-7.48	52.05	74.00	-21.95	peak

- Note: 1. Measurement = Reading Level + Correct Factor.
 2. If Peak Result complies with AV limit, AV Result is deemed to comply with AV limit.
 3. Peak: Peak detector.
 4. Filter losses were only considered in the spurious frequency bands and the authorized band was not corrected for Band reject filter losses.
 5. Proper operation of the transmitter prior to adding the filter to the measurement chain.

8.3. SPURIOUS EMISSIONS (3~18GHz)

8.3.1. 802.11b MIMO MODE

HARMONICS AND SPURIOUS EMISSIONS (LOW CHANNEL, HORIZONTAL)

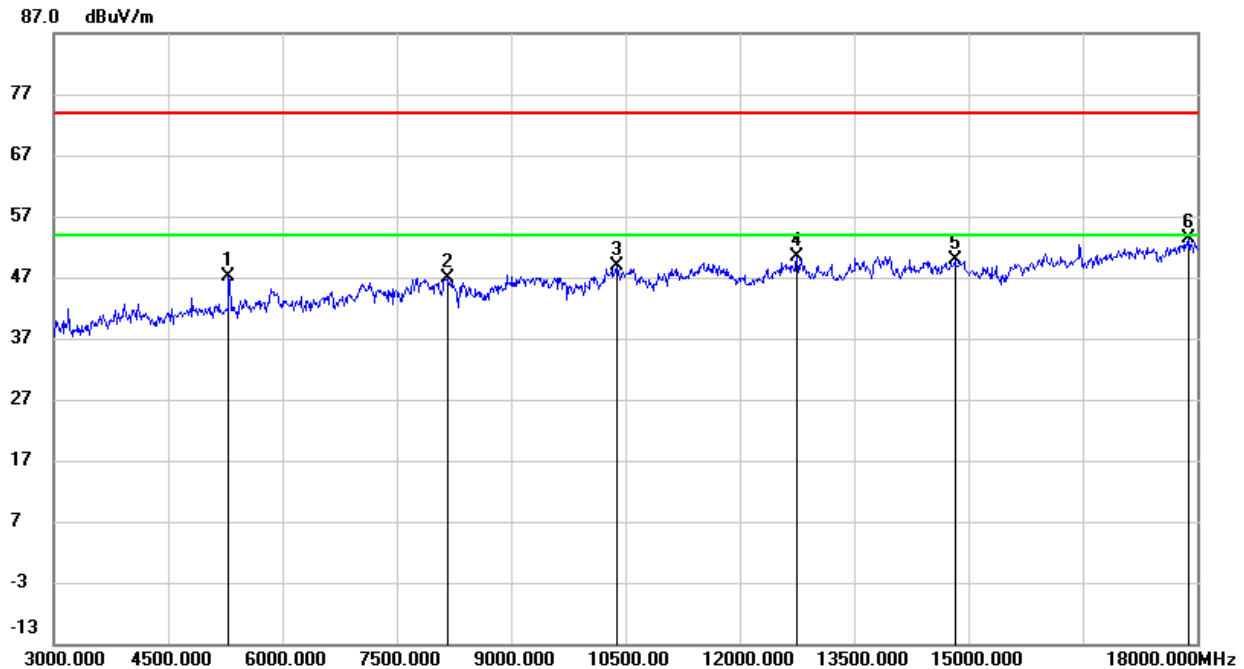

No.	Frequency (MHz)	Reading (dBuV)	Correct (dB/m)	Result (dBuV/m)	Limit (dBuV/m)	Margin (dB)	Remark
1	5295.000	45.01	2.05	47.06	74.00	-26.94	peak
2	8160.000	38.80	8.18	46.98	74.00	-27.02	peak
3	10380.000	37.80	11.00	48.80	74.00	-25.20	peak
4	12750.000	35.40	14.98	50.38	74.00	-23.62	peak
5	14820.000	33.88	15.94	49.82	74.00	-24.18	peak
6	17895.000	29.98	23.34	53.32	74.00	-20.68	peak

Note: 1. Measurement = Reading Level + Correct Factor.

2. If Peak Result complies with AV limit, AV Result is deemed to comply with AV limit.

3. Peak: Peak detector.

4. AVG: $VBW=1/Ton$ where: ton is transmit duration.

5. For transmit duration, please refer to clause 7.1.

6. Filter losses were only considered in the spurious frequency bands and the authorized band was not corrected High Pass Filter losses.

7. Proper operation of the transmitter prior to adding the filter to the measurement chain.

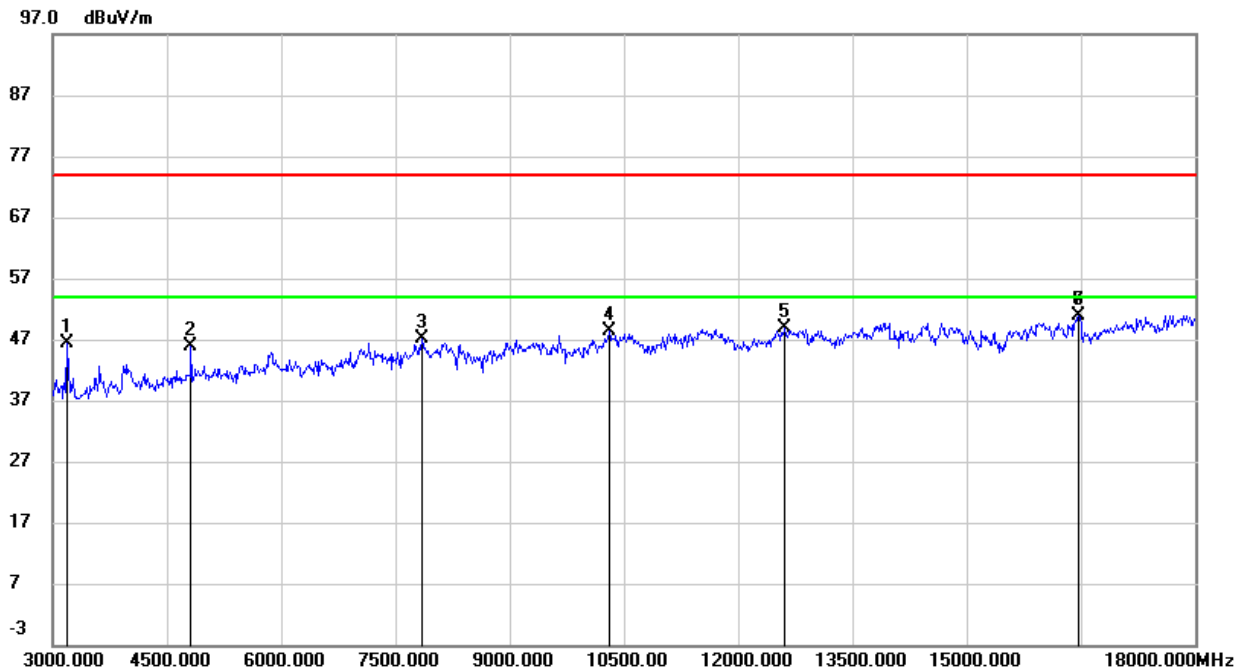
HARMONICS AND SPURIOUS EMISSIONS (LOW CHANNEL, VERTICAL)

No.	Frequency (MHz)	Reading (dBuV)	Correct (dB/m)	Result (dBuV/m)	Limit (dBuV/m)	Margin (dB)	Remark
1	3180.000	50.74	-4.33	46.41	74.00	-27.59	peak
2	4815.000	45.42	0.51	45.93	74.00	-28.07	peak
3	7845.000	39.42	7.62	47.04	74.00	-26.96	peak
4	10305.000	37.25	11.07	48.32	74.00	-25.68	peak
5	12615.000	34.73	14.03	48.76	74.00	-25.24	peak
6	16470.000	31.94	19.06	51.00	74.00	-23.00	peak
7	16470.000	31.94	19.06	51.00	74.00	-23.00	peak

Note: 1. Peak Result = Reading Level + Correct Factor.

2. If Peak Result complies with AV limit, AV Result is deemed to comply with AV limit.

3. Peak: Peak detector.

4. Filter losses were only considered in the spurious frequency bands and the authorized band was not corrected for High Pass Filter losses.

5. Proper operation of the transmitter prior to adding the filter to the measurement chain.

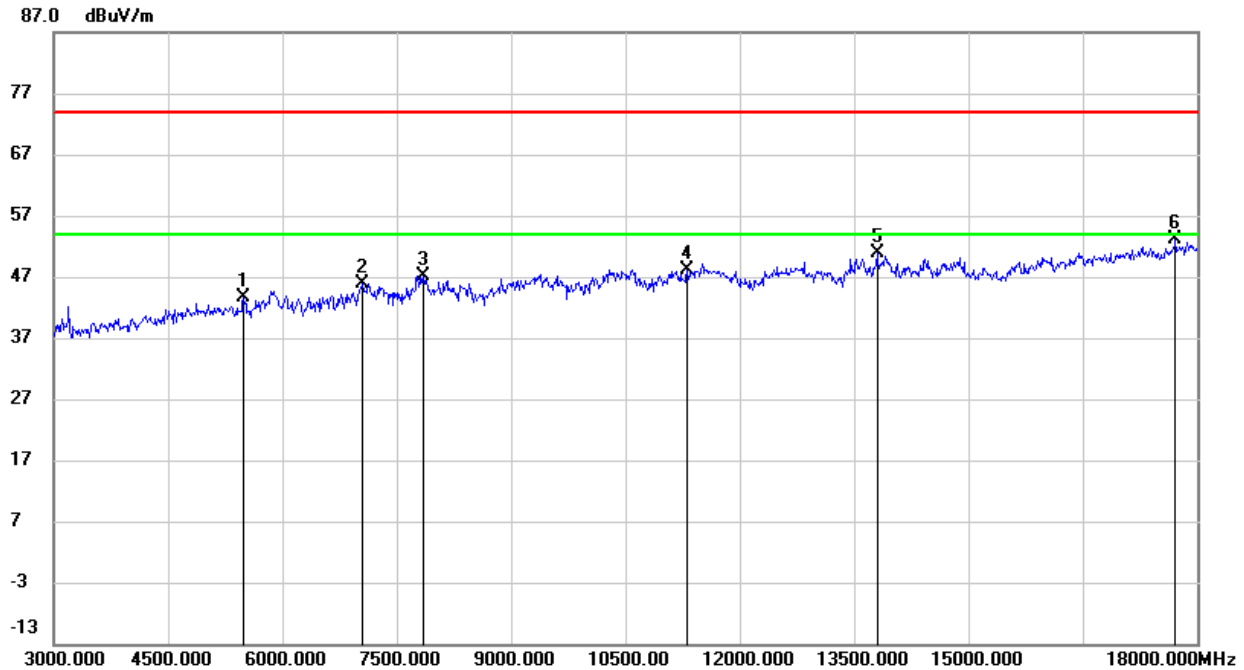
HARMONICS AND SPURIOUS EMISSIONS (MID CHANNEL, HORIZONTAL)

No.	Frequency (MHz)	Reading (dBuV)	Correct (dB/m)	Result (dBuV/m)	Limit (dBuV/m)	Margin (dB)	Remark
1	5490.000	40.62	2.93	43.55	74.00	-30.45	peak
2	7050.000	39.97	5.84	45.81	74.00	-28.19	peak
3	7845.000	39.41	7.62	47.03	74.00	-26.97	peak
4	11310.000	35.82	12.37	48.19	74.00	-25.81	peak
5	13800.000	33.88	17.10	50.98	74.00	-23.02	peak
6	17715.000	30.64	22.56	53.20	74.00	-20.80	peak

- Note: 1. Measurement = Reading Level + Correct Factor.
 2. If Peak Result complies with AV limit, AV Result is deemed to comply with AV limit.
 3. Peak: Peak detector.
 4. AVG: $VBW=1/T_{on}$ where: t_{on} is transmit duration.
 5. For transmit duration, please refer to clause 7.1.
 6. Filter losses were only considered in the spurious frequency bands and the authorized band was not corrected High Pass Filter losses.
 7. Proper operation of the transmitter prior to adding the filter to the measurement chain.



HARMONICS AND SPURIOUS EMISSIONS (MID CHANNEL, VERTICAL)

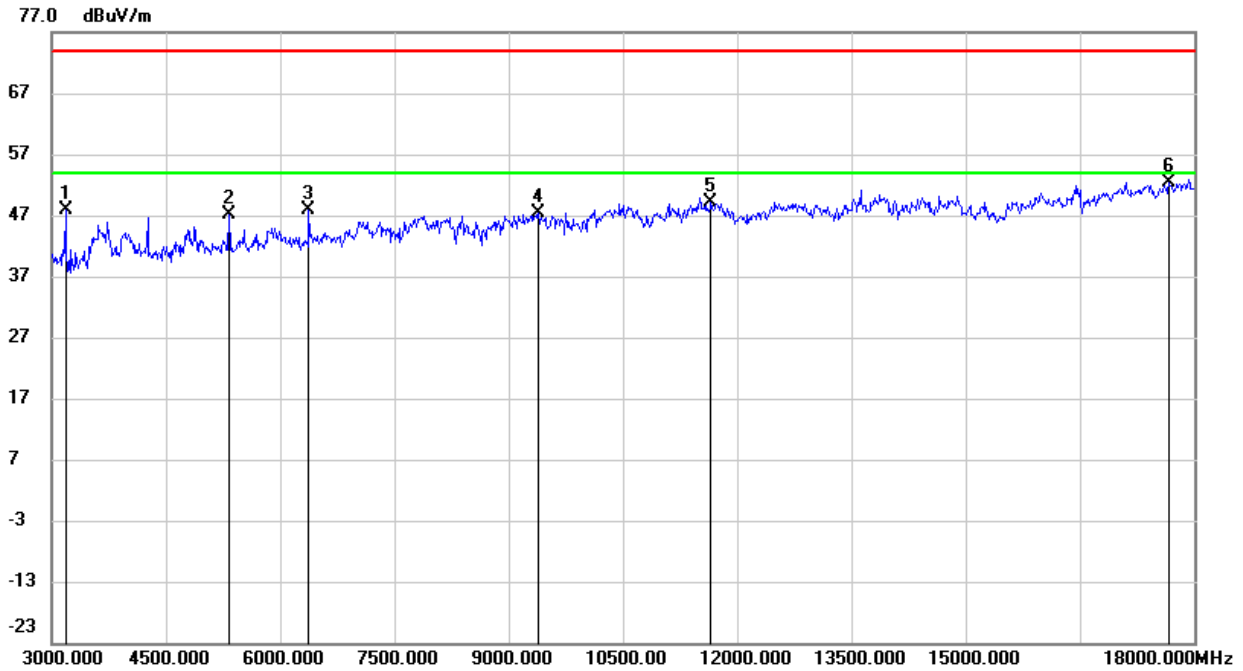

No.	Frequency (MHz)	Reading (dBuV)	Correct (dB/m)	Result (dBuV/m)	Limit (dBuV/m)	Margin (dB)	Remark
1	3180.000	52.30	-4.33	47.97	74.00	-26.03	peak
2	5325.000	45.18	1.99	47.17	74.00	-26.83	peak
3	6375.000	43.65	4.22	47.87	74.00	-26.13	peak
4	9390.000	37.81	9.53	47.34	74.00	-26.66	peak
5	11655.000	36.08	13.06	49.14	74.00	-24.86	peak
6	17670.000	30.25	22.24	52.49	74.00	-21.51	peak

- Note: 1. Peak Result = Reading Level + Correct Factor.
 2. If Peak Result complies with AV limit, AV Result is deemed to comply with AV limit.
 3. Peak: Peak detector.
 4. Filter losses were only considered in the spurious frequency bands and the authorized band was not corrected for High Pass Filter losses.
 5. Proper operation of the transmitter prior to adding the filter to the measurement chain.

HARMONICS AND SPURIOUS EMISSIONS (HIGH CHANNEL, HORIZONTAL)

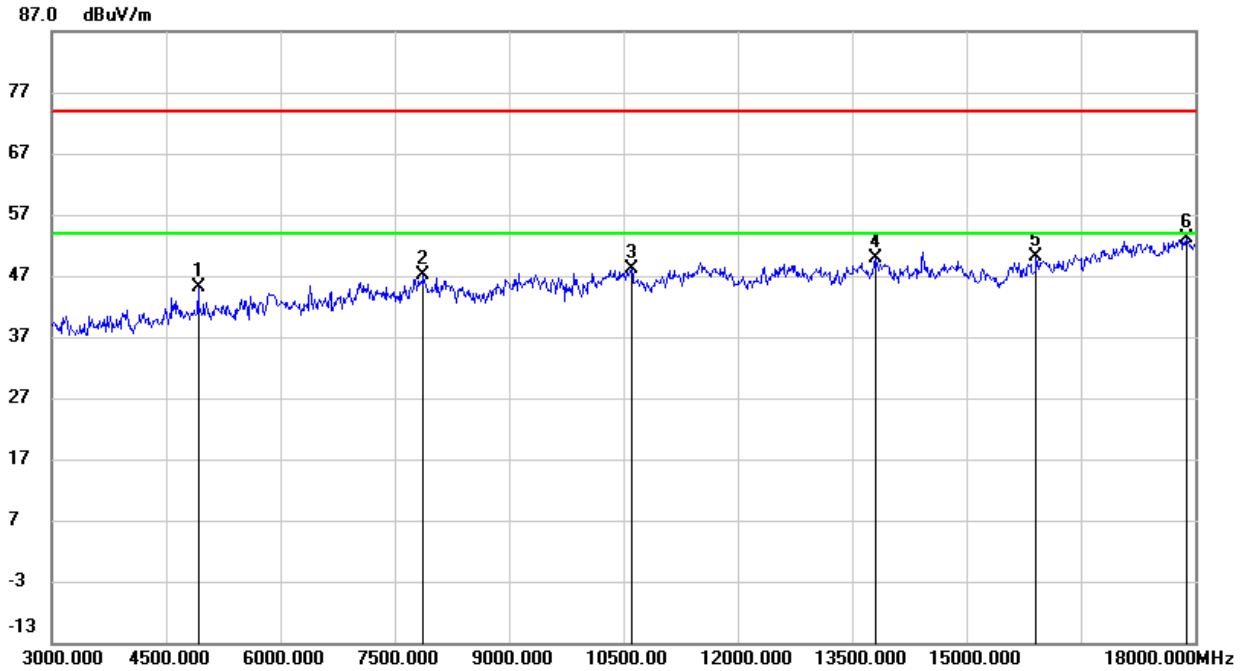

No.	Frequency (MHz)	Reading (dBuV)	Correct (dB/m)	Result (dBuV/m)	Limit (dBuV/m)	Margin (dB)	Remark
1	4920.000	44.11	0.96	45.07	74.00	-28.93	peak
2	7875.000	39.79	7.40	47.19	74.00	-26.81	peak
3	10605.000	36.08	11.93	48.01	74.00	-25.99	peak
4	13800.000	32.67	17.10	49.77	74.00	-24.23	peak
5	15915.000	32.49	17.57	50.06	74.00	-23.94	peak
6	17880.000	29.72	23.34	53.06	74.00	-20.94	peak

- Note:
1. Measurement = Reading Level + Correct Factor.
 2. If Peak Result complies with AV limit, AV Result is deemed to comply with AV limit.
 3. Peak: Peak detector.
 4. AVG: $VBW=1/T_{on}$ where: t_{on} is transmit duration.
 5. For transmit duration, please refer to clause 7.1.
 6. Filter losses were only considered in the spurious frequency bands and the authorized band was not corrected High Pass Filter losses.
 7. Proper operation of the transmitter prior to adding the filter to the measurement chain.

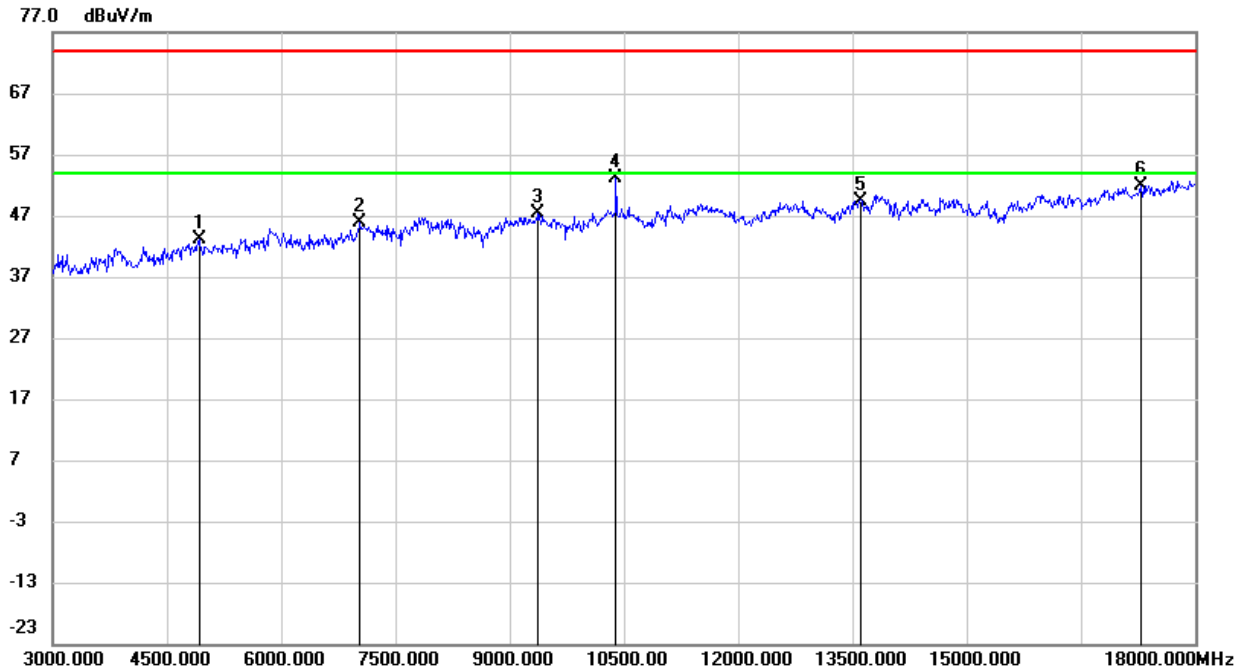
**HARMONICS AND SPURIOUS EMISSIONS (HIGH CHANNEL, VERTICAL)**

No.	Frequency (MHz)	Reading (dBuV)	Correct (dB/m)	Result (dBuV/m)	Limit (dBuV/m)	Margin (dB)	Remark
1	4920.000	42.05	0.96	43.01	74.00	-30.99	peak
2	7035.000	40.19	5.81	46.00	74.00	-28.00	peak
3	9375.000	37.82	9.45	47.27	74.00	-26.73	peak
4	10395.000	42.10	10.98	53.08	74.00	-20.92	peak
5	13605.000	33.48	16.02	49.50	74.00	-24.50	peak
6	17295.000	30.21	21.71	51.92	74.00	-22.08	peak

Note: 1. Peak Result = Reading Level + Correct Factor.

2. If Peak Result complies with AV limit, AV Result is deemed to comply with AV limit.

3. Peak: Peak detector.

4. Filter losses were only considered in the spurious frequency bands and the authorized band was not corrected for High Pass Filter losses.

5. Proper operation of the transmitter prior to adding the filter to the measurement chain.

8.3.2. 802.11g MIMO MODE

HARMONICS AND SPURIOUS EMISSIONS (LOW CHANNEL, HORIZONTAL)

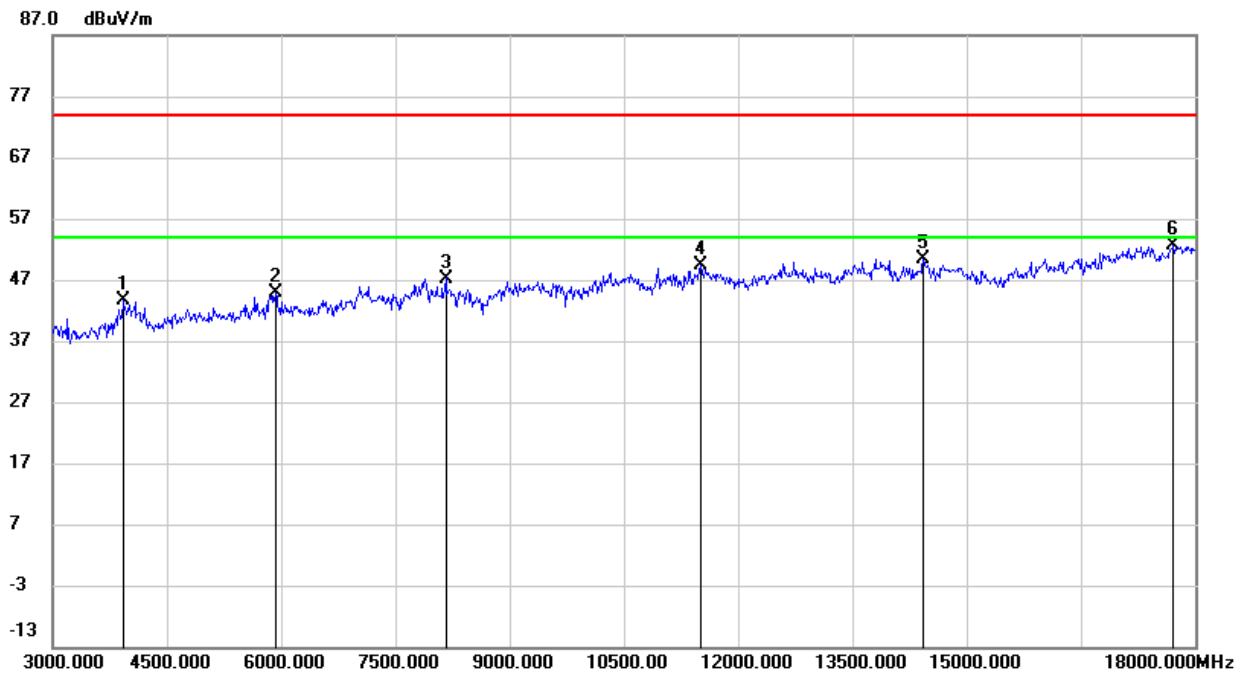

No.	Frequency (MHz)	Reading (dBuV)	Correct (dB/m)	Result (dBuV/m)	Limit (dBuV/m)	Margin (dB)	Remark
1	3930.000	46.57	-2.92	43.65	74.00	-30.35	peak
2	5925.000	40.27	4.54	44.81	74.00	-29.19	peak
3	8160.000	39.07	8.18	47.25	74.00	-26.75	peak
4	11505.000	35.88	13.42	49.30	74.00	-24.70	peak
5	14430.000	33.93	16.35	50.28	74.00	-23.72	peak
6	17715.000	29.95	22.56	52.51	74.00	-21.49	peak

- Note: 1. Peak Result = Reading Level + Correct Factor.
 2. If Peak Result complies with AV limit, AV Result is deemed to comply with AV limit.
 3. Peak: Peak detector.
 4. Filter losses were only considered in the spurious frequency bands and the authorized band was not corrected for High Pass Filter losses.
 5. Proper operation of the transmitter prior to adding the filter to the measurement chain.

HARMONICS AND SPURIOUS EMISSIONS (LOW CHANNEL, VERTICAL)

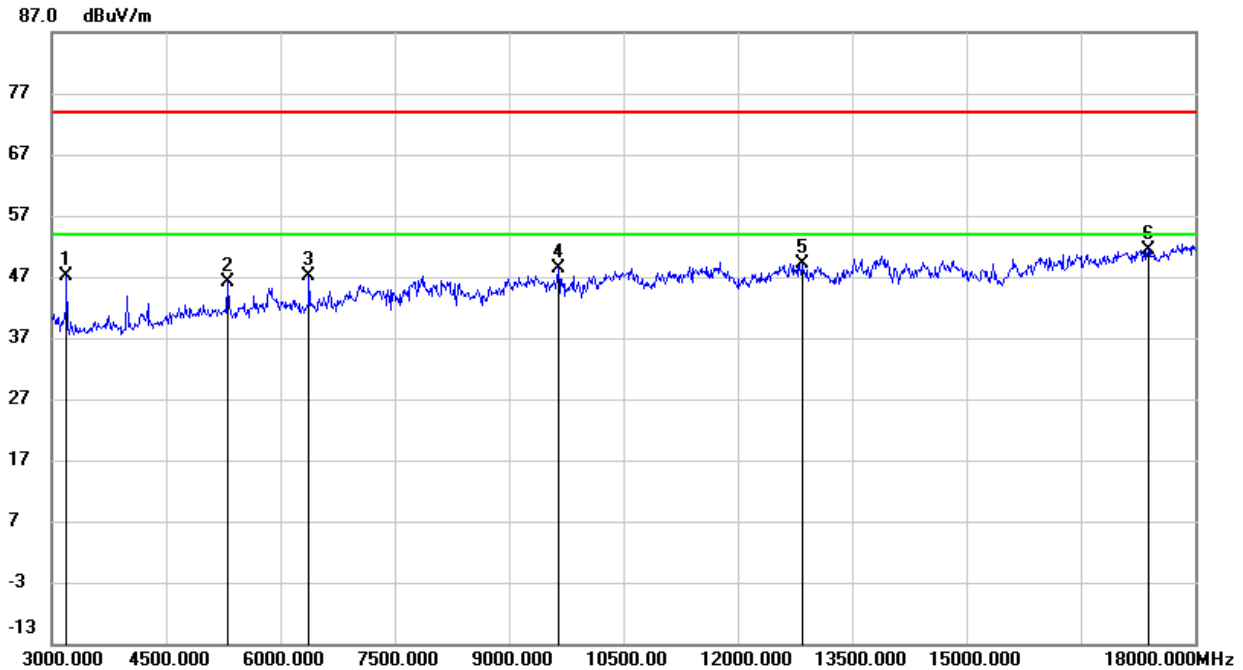

No.	Frequency (MHz)	Reading (dBuV)	Correct (dB/m)	Result (dBuV/m)	Limit (dBuV/m)	Margin (dB)	Remark
1	3195.000	51.52	-4.42	47.10	74.00	-26.90	peak
2	5310.000	44.21	2.02	46.23	74.00	-27.77	peak
3	6375.000	42.81	4.22	47.03	74.00	-26.97	peak
4	9645.000	38.80	9.66	48.46	74.00	-25.54	peak
5	12840.000	33.87	15.35	49.22	74.00	-24.78	peak
6	17385.000	30.03	21.46	51.49	74.00	-22.51	peak

- Note: 1. Peak Result = Reading Level + Correct Factor.
 2. If Peak Result complies with AV limit, AV Result is deemed to comply with AV limit.
 3. Peak: Peak detector.
 4. Filter losses were only considered in the spurious frequency bands and the authorized band was not corrected for High Pass Filter losses.
 5. Proper operation of the transmitter prior to adding the filter to the measurement chain.

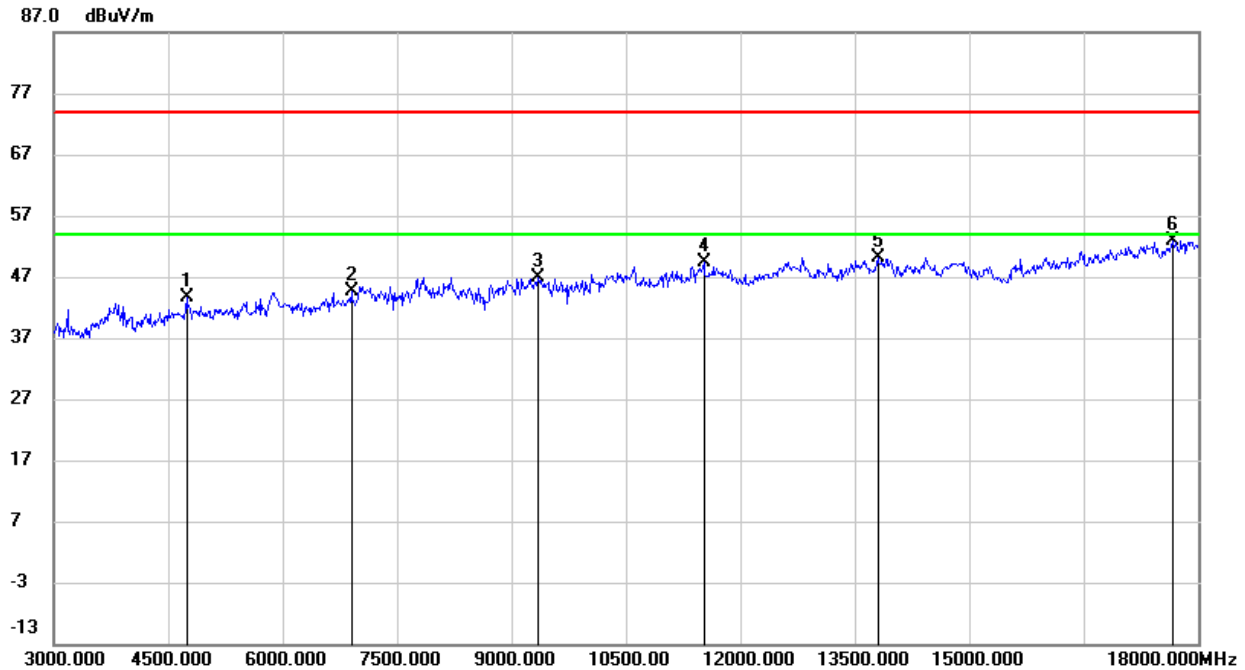
**HARMONICS AND SPURIOUS EMISSIONS (MID CHANNEL, HORIZONTAL)**

No.	Frequency (MHz)	Reading (dBuV)	Correct (dB/m)	Result (dBuV/m)	Limit (dBuV/m)	Margin (dB)	Remark
1	4740.000	43.22	0.30	43.52	74.00	-30.48	peak
2	6900.000	38.61	5.93	44.54	74.00	-29.46	peak
3	9345.000	37.62	9.26	46.88	74.00	-27.12	peak
4	11520.000	35.89	13.38	49.27	74.00	-24.73	peak
5	13800.000	32.97	17.10	50.07	74.00	-23.93	peak
6	17670.000	30.75	22.24	52.99	74.00	-21.01	peak

- Note: 1. Peak Result = Reading Level + Correct Factor.
 2. If Peak Result complies with AV limit, AV Result is deemed to comply with AV limit.
 3. Peak: Peak detector.
 4. Filter losses were only considered in the spurious frequency bands and the authorized band was not corrected for High Pass Filter losses.
 5. Proper operation of the transmitter prior to adding the filter to the measurement chain.



HARMONICS AND SPURIOUS EMISSIONS (MID CHANNEL, VERTICAL)

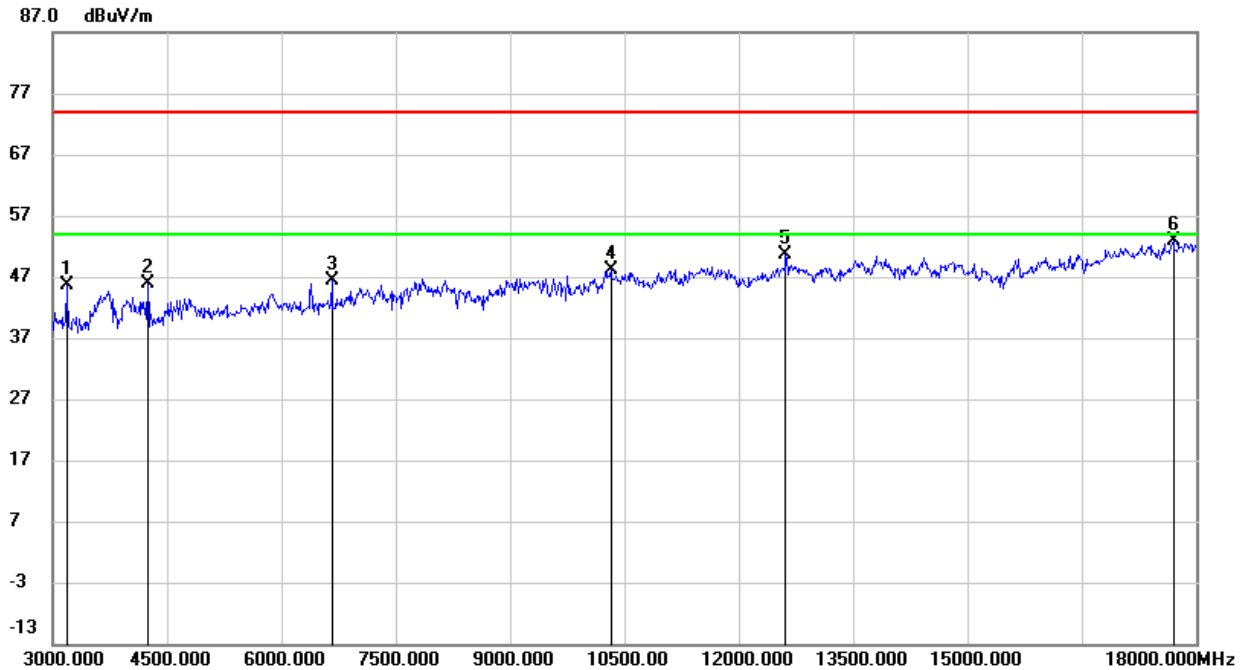

No.	Frequency (MHz)	Reading (dBuV)	Correct (dB/m)	Result (dBuV/m)	Limit (dBuV/m)	Margin (dB)	Remark
1	3180.000	49.89	-4.33	45.56	74.00	-28.44	peak
2	4245.000	47.40	-1.59	45.81	74.00	-28.19	peak
3	6660.000	41.08	5.22	46.30	74.00	-27.70	peak
4	10320.000	37.07	11.05	48.12	74.00	-25.88	peak
5	12615.000	36.57	14.03	50.60	74.00	-23.40	peak
6	17700.000	30.49	22.43	52.92	74.00	-21.08	peak

- Note: 1. Peak Result = Reading Level + Correct Factor.
 2. If Peak Result complies with AV limit, AV Result is deemed to comply with AV limit.
 3. Peak: Peak detector.
 4. Filter losses were only considered in the spurious frequency bands and the authorized band was not corrected for High Pass Filter losses.
 5. Proper operation of the transmitter prior to adding the filter to the measurement chain.

HARMONICS AND SPURIOUS EMISSIONS (HIGH CHANNEL, HORIZONTAL)

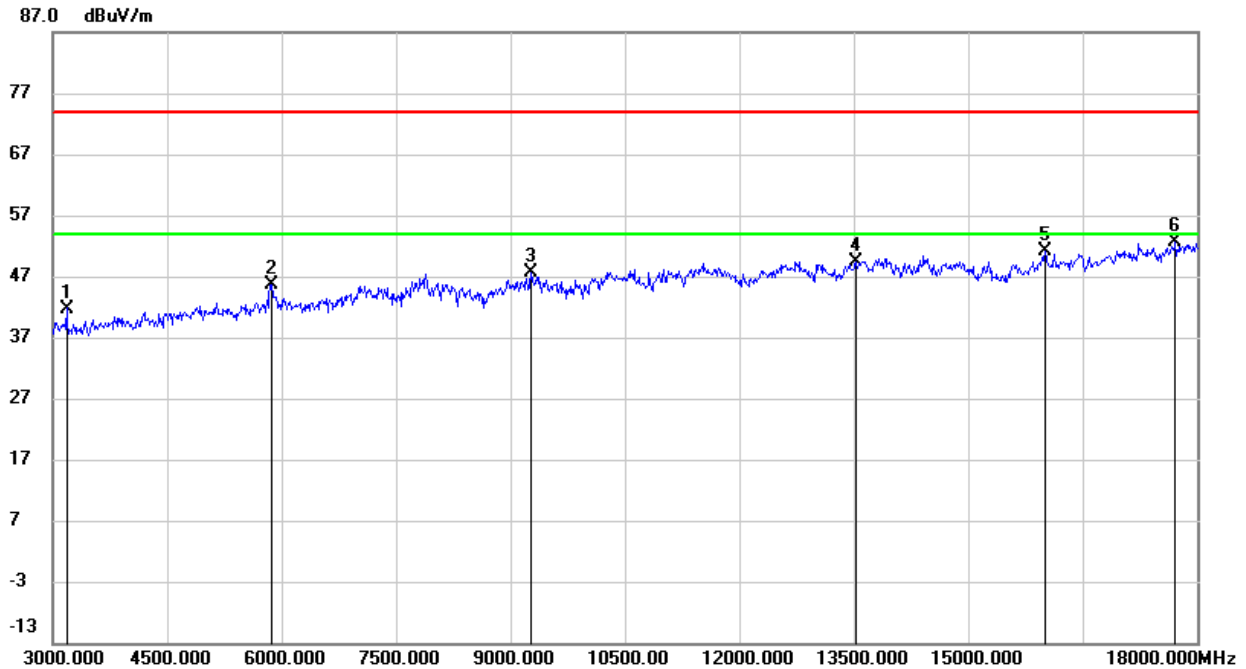

No.	Frequency (MHz)	Reading (dBuV)	Correct (dB/m)	Result (dBuV/m)	Limit (dBuV/m)	Margin (dB)	Remark
1	3180.000	46.08	-4.33	41.75	74.00	-32.25	peak
2	5865.000	41.40	4.30	45.70	74.00	-28.30	peak
3	9270.000	38.62	8.89	47.51	74.00	-26.49	peak
4	13530.000	33.52	15.86	49.38	74.00	-24.62	peak
5	16005.000	33.33	17.71	51.04	74.00	-22.96	peak
6	17715.000	30.09	22.56	52.65	74.00	-21.35	peak

- Note: 1. Peak Result = Reading Level + Correct Factor.
 2. If Peak Result complies with AV limit, AV Result is deemed to comply with AV limit.
 3. Peak: Peak detector.
 4. Filter losses were only considered in the spurious frequency bands and the authorized band was not corrected for High Pass Filter losses.
 5. Proper operation of the transmitter prior to adding the filter to the measurement chain.



HARMONICS AND SPURIOUS EMISSIONS (HIGH CHANNEL, VERTICAL)

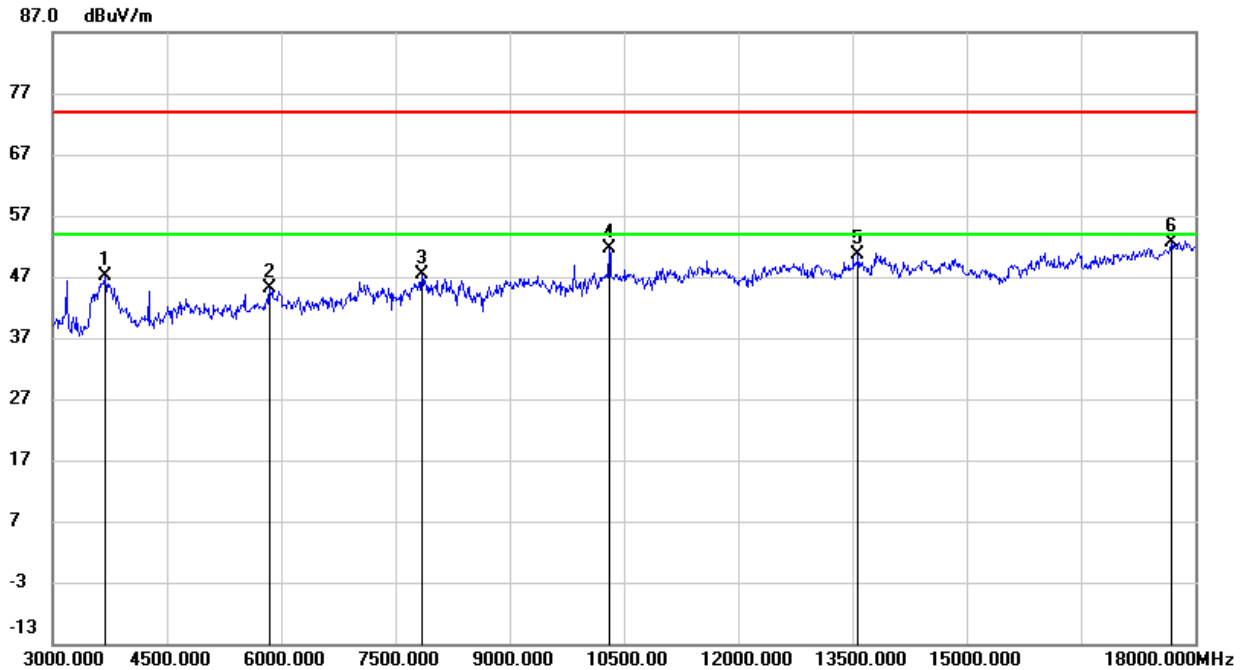

No.	Frequency (MHz)	Reading (dBuV)	Correct (dB/m)	Result (dBuV/m)	Limit (dBuV/m)	Margin (dB)	Remark
1	3690.000	49.92	-2.81	47.11	74.00	-26.89	peak
2	5850.000	41.05	4.02	45.07	74.00	-28.93	peak
3	7845.000	39.71	7.62	47.33	74.00	-26.67	peak
4	10305.000	40.48	11.07	51.55	74.00	-22.45	peak
5	13575.000	34.68	15.97	50.65	74.00	-23.35	peak
6	17685.000	30.32	22.33	52.65	74.00	-21.35	peak

- Note: 1. Peak Result = Reading Level + Correct Factor.
 2. If Peak Result complies with AV limit, AV Result is deemed to comply with AV limit.
 3. Peak: Peak detector.
 4. Filter losses were only considered in the spurious frequency bands and the authorized band was not corrected for High Pass Filter losses.
 5. Proper operation of the transmitter prior to adding the filter to the measurement chain.

8.3.3. 802.11n HT20 MIMO MODE

HARMONICS AND SPURIOUS EMISSIONS (LOW CHANNEL, HORIZONTAL)

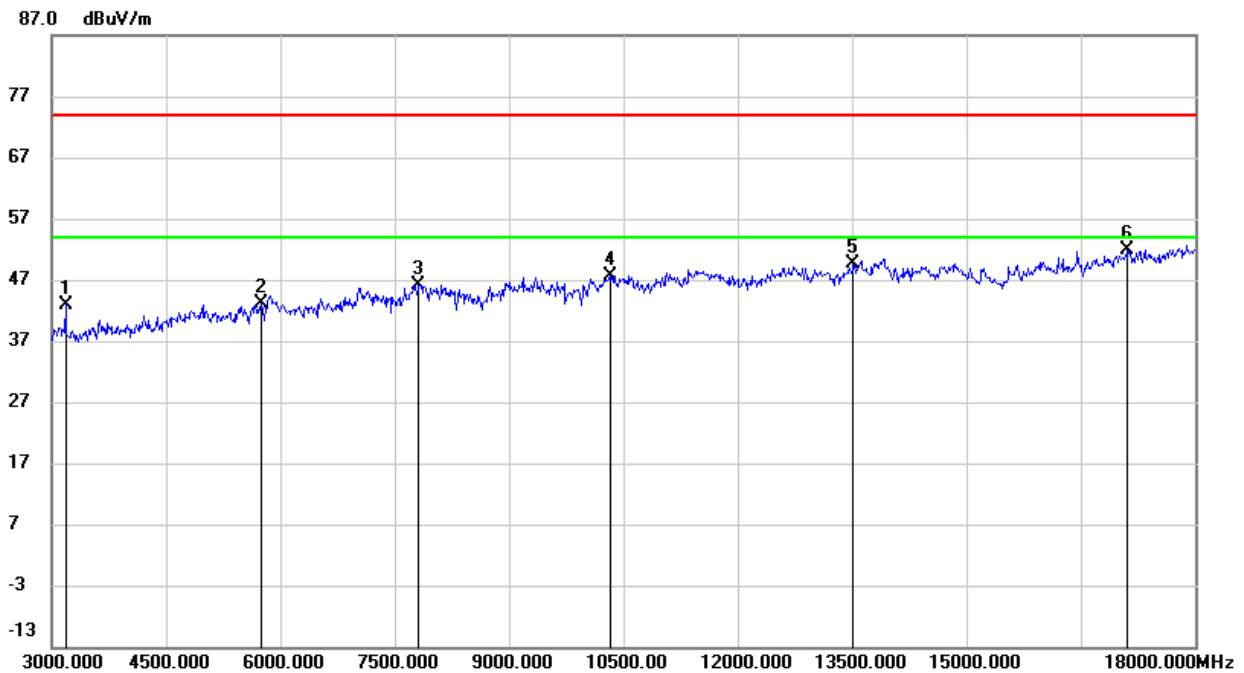

No.	Frequency (MHz)	Reading (dBuV)	Correct (dB/m)	Result (dBuV/m)	Limit (dBuV/m)	Margin (dB)	Remark
1	3180.000	47.33	-4.33	43.00	74.00	-31.00	peak
2	5745.000	40.17	2.88	43.05	74.00	-30.95	peak
3	7815.000	38.39	7.83	46.22	74.00	-27.78	peak
4	10320.000	36.57	11.05	47.62	74.00	-26.38	peak
5	13515.000	33.86	15.81	49.67	74.00	-24.33	peak
6	17115.000	31.16	20.68	51.84	74.00	-22.16	peak

Note: 1. Measurement = Reading Level + Correct Factor.

2. If Peak Result complies with AV limit, AV Result is deemed to comply with AV limit.

3. Peak: Peak detector.

4. AVG: $VBW=1/Ton$ where: ton is transmit duration.

5. For transmit duration, please refer to clause 7.1.

6. Filter losses were only considered in the spurious frequency bands and the authorized band was not corrected High Pass Filter losses.

7. Proper operation of the transmitter prior to adding the filter to the measurement chain.

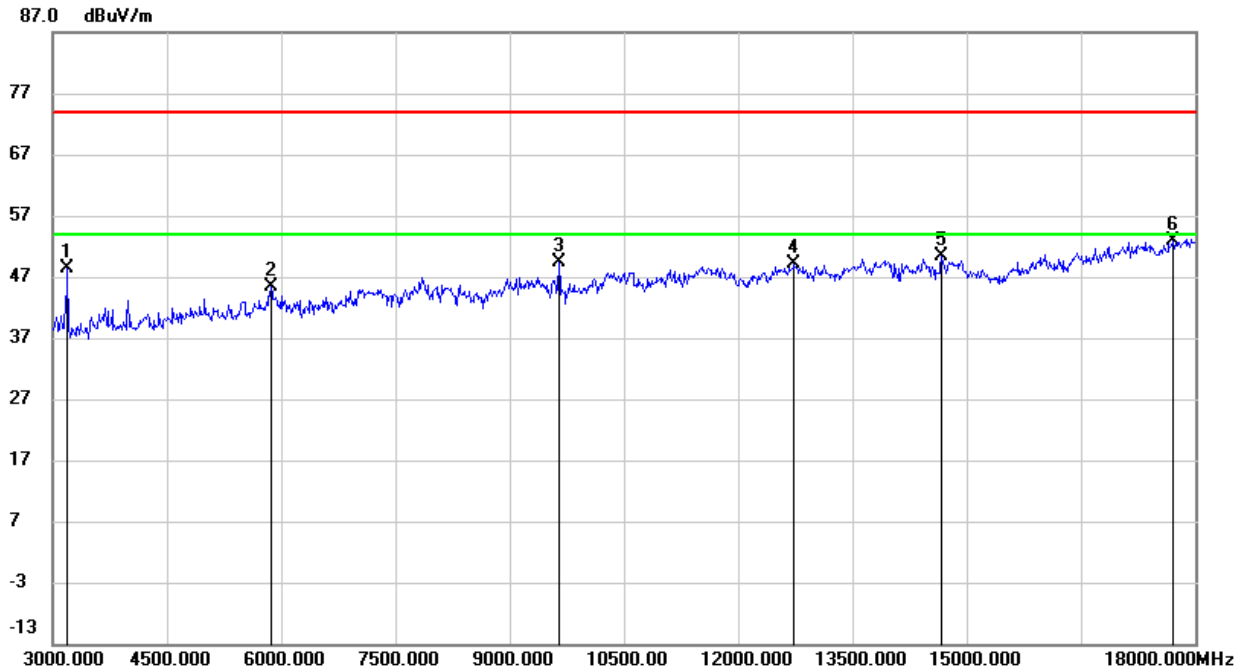
**HARMONICS AND SPURIOUS EMISSIONS (LOW CHANNEL, VERTICAL)**

No.	Frequency (MHz)	Reading (dBuV)	Correct (dB/m)	Result (dBuV/m)	Limit (dBuV/m)	Margin (dB)	Remark
1	3195.000	52.87	-4.42	48.45	74.00	-25.55	peak
2	5865.000	41.04	4.30	45.34	74.00	-28.66	peak
3	9645.000	39.76	9.66	49.42	74.00	-24.58	peak
4	12735.000	34.38	14.77	49.15	74.00	-24.85	peak
5	14670.000	34.37	16.01	50.38	74.00	-23.62	peak
6	17715.000	30.38	22.56	52.94	74.00	-21.06	peak

- Note: 1. Peak Result = Reading Level + Correct Factor.
 2. If Peak Result complies with AV limit, AV Result is deemed to comply with AV limit.
 3. Peak: Peak detector.
 4. Filter losses were only considered in the spurious frequency bands and the authorized band was not corrected for High Pass Filter losses.
 5. Proper operation of the transmitter prior to adding the filter to the measurement chain.

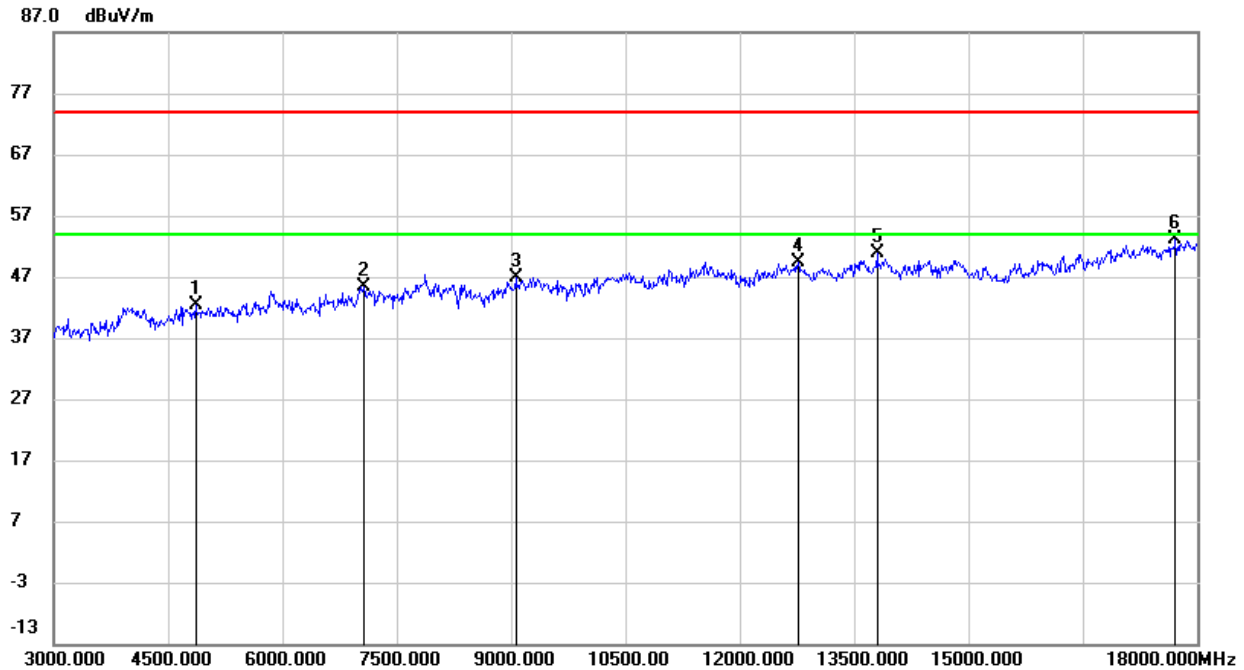
HARMONICS AND SPURIOUS EMISSIONS (MID CHANNEL, HORIZONTAL)

No.	Frequency (MHz)	Reading (dBuV)	Correct (dB/m)	Result (dBuV/m)	Limit (dBuV/m)	Margin (dB)	Remark
1	4860.000	41.60	0.70	42.30	74.00	-31.70	peak
2	7065.000	39.48	5.86	45.34	74.00	-28.66	peak
3	9060.000	37.62	9.28	46.90	74.00	-27.10	peak
4	12765.000	34.28	15.18	49.46	74.00	-24.54	peak
5	13800.000	33.87	17.10	50.97	74.00	-23.03	peak
6	17715.000	30.49	22.56	53.05	74.00	-20.95	peak

- Note:
1. Measurement = Reading Level + Correct Factor.
 2. If Peak Result complies with AV limit, AV Result is deemed to comply with AV limit.
 3. Peak: Peak detector.
 4. AVG: $VBW=1/Ton$ where: ton is transmit duration.
 5. For transmit duration, please refer to clause 7.1.
 6. Filter losses were only considered in the spurious frequency bands and the authorized band was not corrected High Pass Filter losses.
 7. Proper operation of the transmitter prior to adding the filter to the measurement chain.

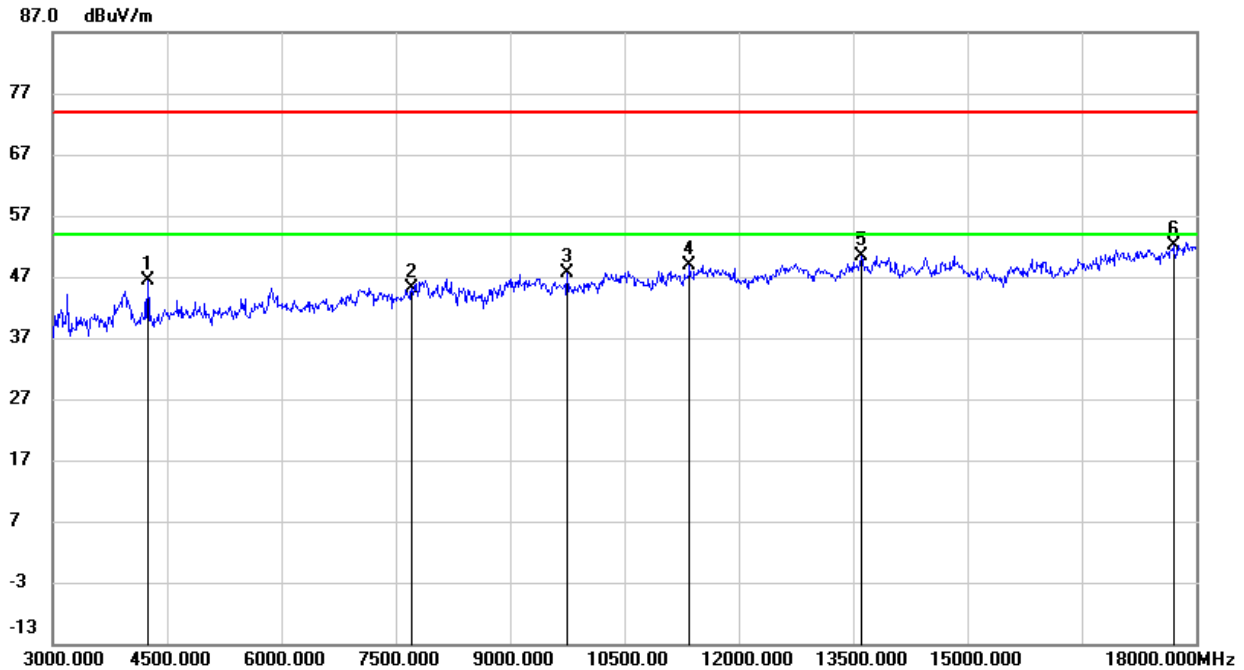
HARMONICS AND SPURIOUS EMISSIONS (MID CHANNEL, VERTICAL)

No.	Frequency (MHz)	Reading (dBuV)	Correct (dB/m)	Result (dBuV/m)	Limit (dBuV/m)	Margin (dB)	Remark
1	4245.000	48.03	-1.59	46.44	74.00	-27.56	peak
2	7710.000	38.42	6.64	45.06	74.00	-28.94	peak
3	9750.000	37.94	9.68	47.62	74.00	-26.38	peak
4	11355.000	36.50	12.48	48.98	74.00	-25.02	peak
5	13605.000	34.37	16.02	50.39	74.00	-23.61	peak
6	17700.000	29.76	22.43	52.19	74.00	-21.81	peak

- Note: 1. Peak Result = Reading Level + Correct Factor.
 2. If Peak Result complies with AV limit, AV Result is deemed to comply with AV limit.
 3. Peak: Peak detector.
 4. Filter losses were only considered in the spurious frequency bands and the authorized band was not corrected for High Pass Filter losses.
 5. Proper operation of the transmitter prior to adding the filter to the measurement chain.

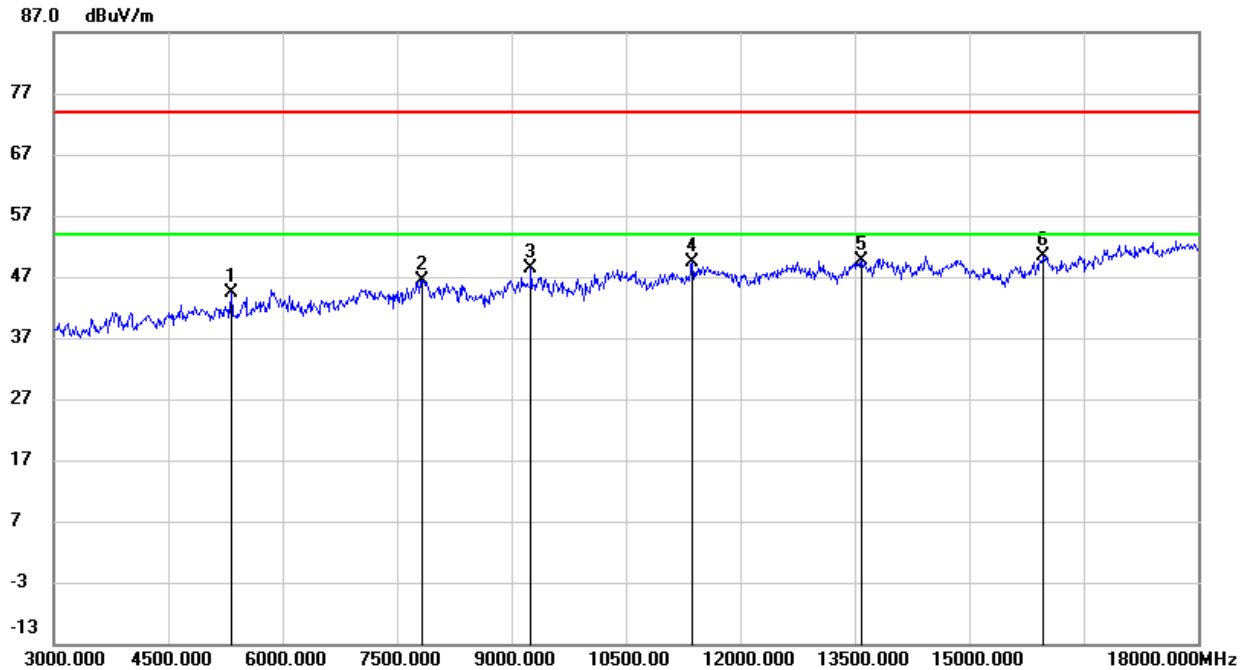
**HARMONICS AND SPURIOUS EMISSIONS (HIGH CHANNEL, HORIZONTAL)**

No.	Frequency (MHz)	Reading (dBuV)	Correct (dB/m)	Result (dBuV/m)	Limit (dBuV/m)	Margin (dB)	Remark
1	5325.000	42.36	1.99	44.35	74.00	-29.65	peak
2	7830.000	38.77	7.72	46.49	74.00	-27.51	peak
3	9255.000	39.46	8.84	48.30	74.00	-25.70	peak
4	11370.000	36.77	12.54	49.31	74.00	-24.69	peak
5	13590.000	33.67	16.00	49.67	74.00	-24.33	peak
6	15975.000	32.70	17.65	50.35	74.00	-23.65	peak

Note: 1. Measurement = Reading Level + Correct Factor.

2. If Peak Result complies with AV limit, AV Result is deemed to comply with AV limit.

3. Peak: Peak detector.

4. AVG: $VBW=1/Ton$ where: ton is transmit duration.

5. For transmit duration, please refer to clause 7.1.

6. Filter losses were only considered in the spurious frequency bands and the authorized band was not corrected High Pass Filter losses.

7. Proper operation of the transmitter prior to adding the filter to the measurement chain.



HARMONICS AND SPURIOUS EMISSIONS (HIGH CHANNEL, VERTICAL)

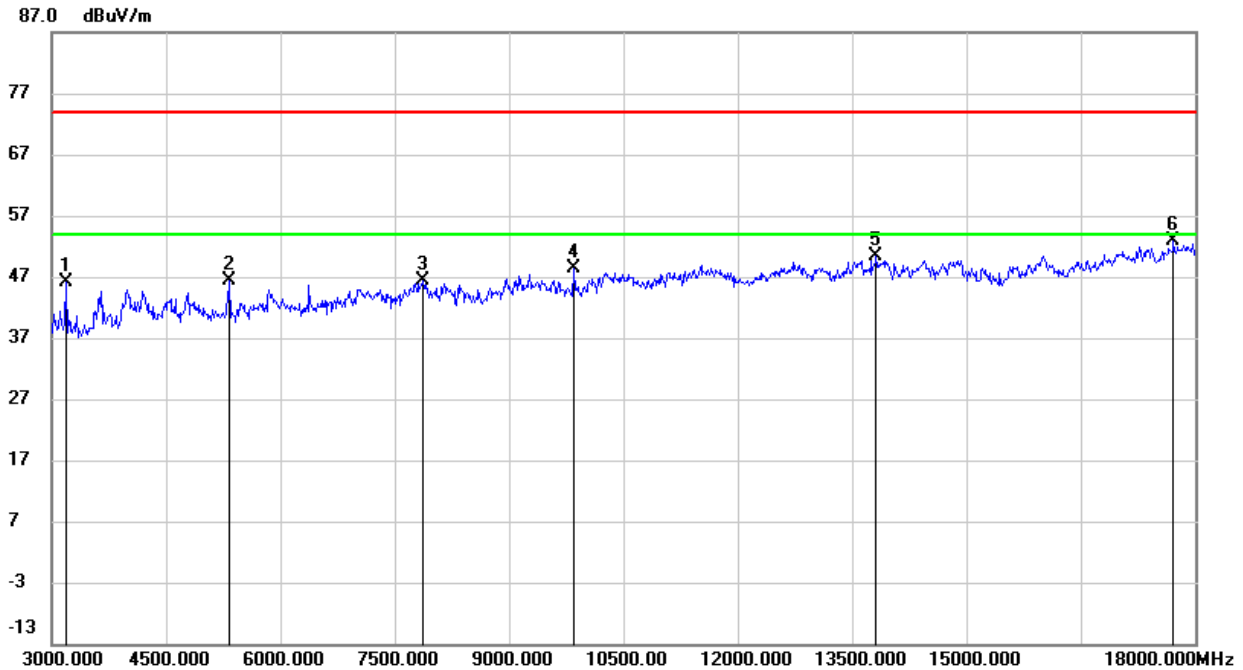

No.	Frequency (MHz)	Reading (dBuV)	Correct (dB/m)	Result (dBuV/m)	Limit (dBuV/m)	Margin (dB)	Remark
1	3180.000	50.55	-4.33	46.22	74.00	-27.78	peak
2	5325.000	44.31	1.99	46.30	74.00	-27.70	peak
3	7875.000	38.92	7.40	46.32	74.00	-27.68	peak
4	9855.000	38.35	9.92	48.27	74.00	-25.73	peak
5	13815.000	33.33	16.97	50.30	74.00	-23.70	peak
6	17715.000	30.30	22.56	52.86	74.00	-21.14	peak

- Note: 1. Measurement = Reading Level + Correct Factor.
 2. If Peak Result complies with AV limit, AV Result is deemed to comply with AV limit.
 3. Peak: Peak detector.
 4. AVG: $VBW=1/T_{on}$ where: t_{on} is transmit duration.
 5. For transmit duration, please refer to clause 7.1.
 6. Filter losses were only considered in the spurious frequency bands and the authorized band was not corrected High Pass Filter losses.
 7. Proper operation of the transmitter prior to adding the filter to the measurement chain.

8.3.4. 802.11n HT40 MIMO MODE

HARMONICS AND SPURIOUS EMISSIONS (LOW CHANNEL, HORIZONTAL)

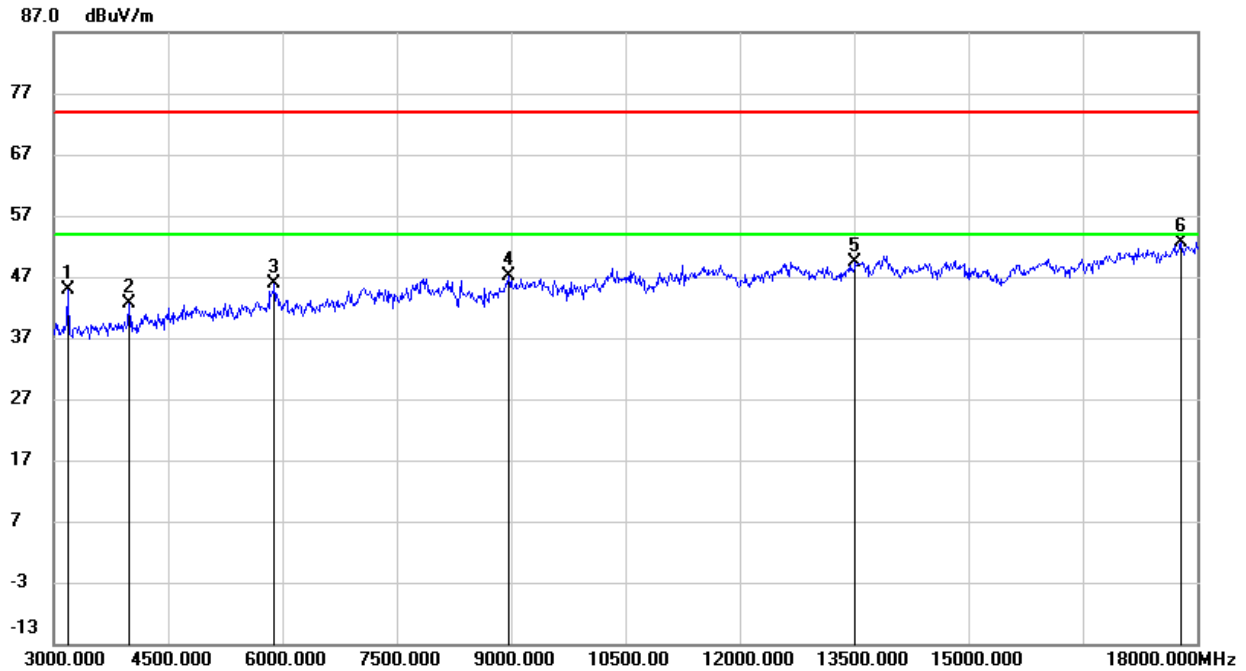

No.	Frequency (MHz)	Reading (dBuV)	Correct (dB/m)	Result (dBuV/m)	Limit (dBuV/m)	Margin (dB)	Remark
1	3180.000	49.21	-4.33	44.88	74.00	-29.12	peak
2	3990.000	45.60	-2.89	42.71	74.00	-31.29	peak
3	5895.000	40.95	4.86	45.81	74.00	-28.19	peak
4	8970.000	38.13	9.00	47.13	74.00	-26.87	peak
5	13515.000	33.47	15.81	49.28	74.00	-24.72	peak
6	17790.000	29.29	23.22	52.51	74.00	-21.49	peak

- Note: 1. Peak Result = Reading Level + Correct Factor.
 2. If Peak Result complies with AV limit, AV Result is deemed to comply with AV limit.
 3. Peak: Peak detector.
 4. Filter losses were only considered in the spurious frequency bands and the authorized band was not corrected for High Pass Filter losses.
 5. Proper operation of the transmitter prior to adding the filter to the measurement chain.

HARMONICS AND SPURIOUS EMISSIONS (LOW CHANNEL, VERTICAL)

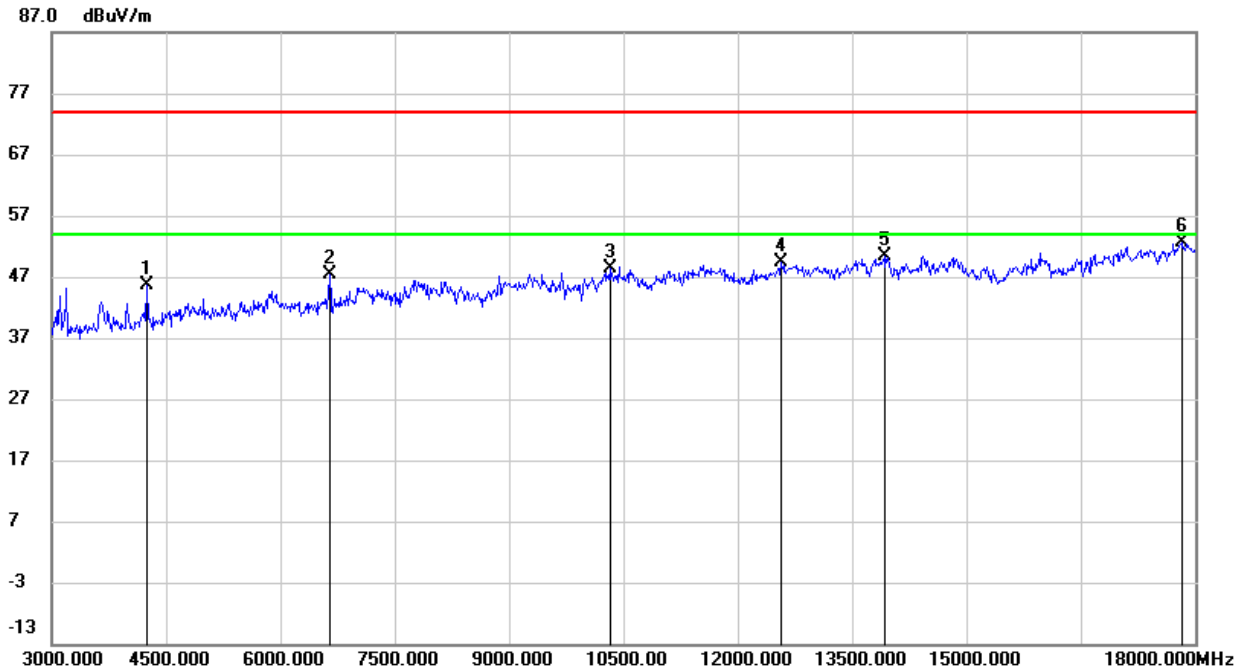

No.	Frequency (MHz)	Reading (dBuV)	Correct (dB/m)	Result (dBuV/m)	Limit (dBuV/m)	Margin (dB)	Remark
1	4245.000	47.22	-1.59	45.63	74.00	-28.37	peak
2	6645.000	42.15	5.22	47.37	74.00	-26.63	peak
3	10320.000	37.21	11.05	48.26	74.00	-25.74	peak
4	12570.000	35.23	14.17	49.40	74.00	-24.60	peak
5	13920.000	34.17	16.17	50.34	74.00	-23.66	peak
6	17820.000	29.25	23.30	52.55	74.00	-21.45	peak

- Note: 1. Peak Result = Reading Level + Correct Factor.
 2. If Peak Result complies with AV limit, AV Result is deemed to comply with AV limit.
 3. Peak: Peak detector.
 4. Filter losses were only considered in the spurious frequency bands and the authorized band was not corrected for High Pass Filter losses.
 5. Proper operation of the transmitter prior to adding the filter to the measurement chain.



HARMONICS AND SPURIOUS EMISSIONS (MID CHANNEL, HORIZONTAL)

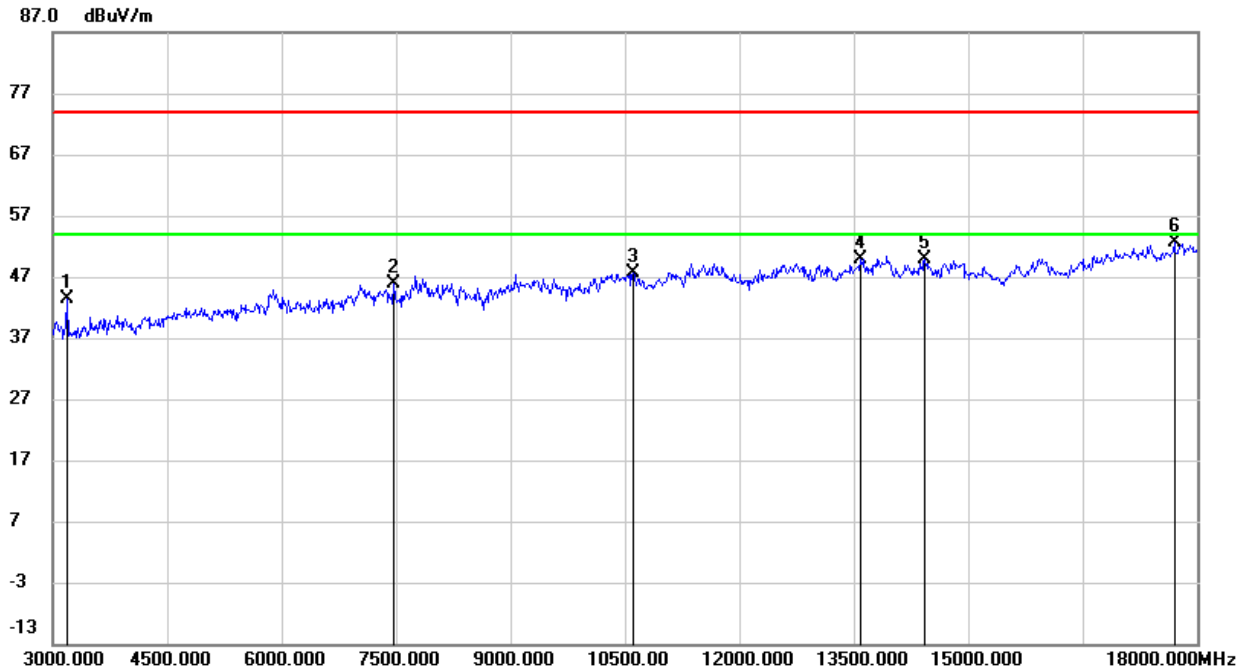

No.	Frequency (MHz)	Reading (dBuV)	Correct (dB/m)	Result (dBuV/m)	Limit (dBuV/m)	Margin (dB)	Remark
1	3180.000	47.68	-4.33	43.35	74.00	-30.65	peak
2	7470.000	39.73	6.19	45.92	74.00	-28.08	peak
3	10605.000	35.73	11.93	47.66	74.00	-26.34	peak
4	13590.000	33.77	16.00	49.77	74.00	-24.23	peak
5	14430.000	33.49	16.35	49.84	74.00	-24.16	peak
6	17700.000	30.16	22.43	52.59	74.00	-21.41	peak

- Note: 1. Peak Result = Reading Level + Correct Factor.
 2. If Peak Result complies with AV limit, AV Result is deemed to comply with AV limit.
 3. Peak: Peak detector.
 4. Filter losses were only considered in the spurious frequency bands and the authorized band was not corrected for High Pass Filter losses.
 5. Proper operation of the transmitter prior to adding the filter to the measurement chain.



HARMONICS AND SPURIOUS EMISSIONS (MID CHANNEL, VERTICAL)

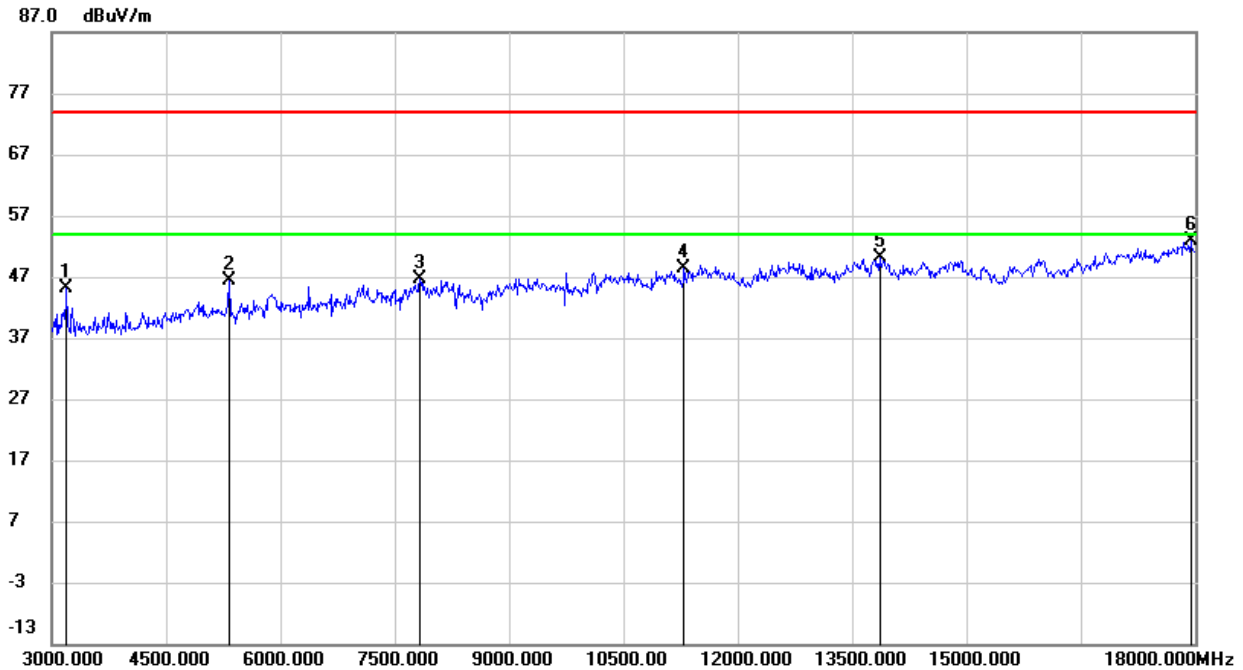

No.	Frequency (MHz)	Reading (dBuV)	Correct (dB/m)	Result (dBuV/m)	Limit (dBuV/m)	Margin (dB)	Remark
1	3195.000	49.65	-4.42	45.23	74.00	-28.77	peak
2	5325.000	44.30	1.99	46.29	74.00	-27.71	peak
3	7830.000	38.79	7.72	46.51	74.00	-27.49	peak
4	11295.000	36.13	12.34	48.47	74.00	-25.53	peak
5	13860.000	33.55	16.56	50.11	74.00	-23.89	peak
6	17940.000	29.39	23.39	52.78	74.00	-21.22	peak

- Note: 1. Peak Result = Reading Level + Correct Factor.
 2. If Peak Result complies with AV limit, AV Result is deemed to comply with AV limit.
 3. Peak: Peak detector.
 4. Filter losses were only considered in the spurious frequency bands and the authorized band was not corrected for High Pass Filter losses.
 5. Proper operation of the transmitter prior to adding the filter to the measurement chain.

HARMONICS AND SPURIOUS EMISSIONS (HIGH CHANNEL, HORIZONTAL)

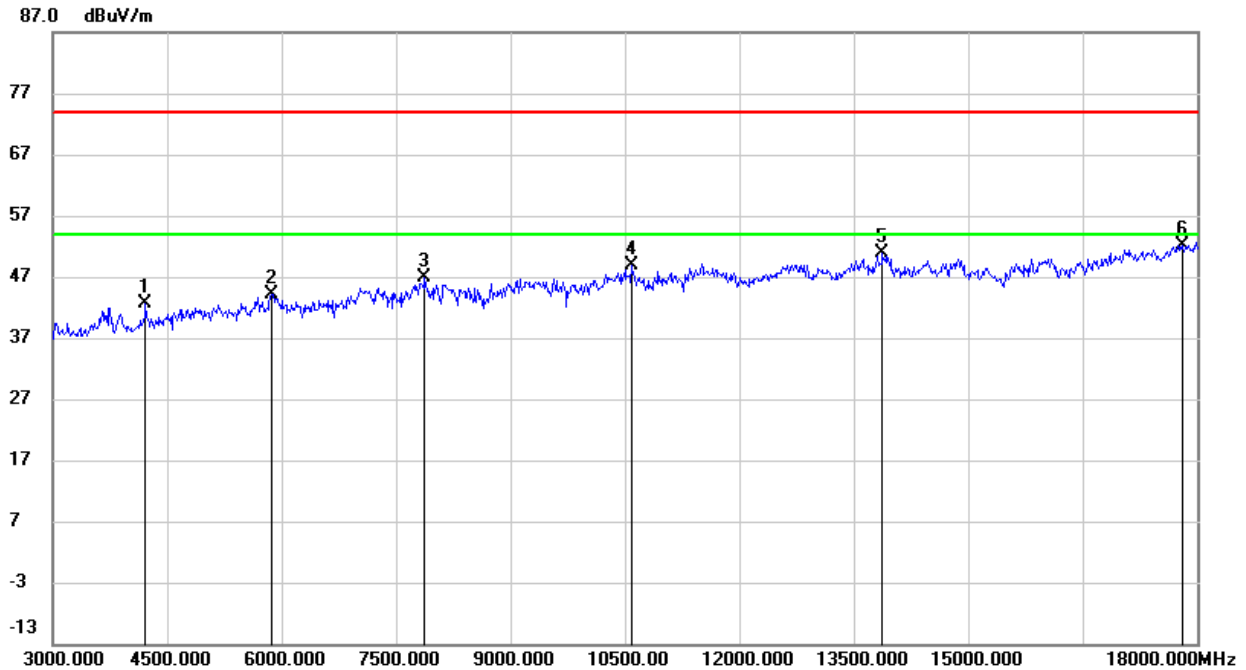

No.	Frequency (MHz)	Reading (dBuV)	Correct (dB/m)	Result (dBuV/m)	Limit (dBuV/m)	Margin (dB)	Remark
1	4215.000	43.86	-1.34	42.52	74.00	-31.48	peak
2	5865.000	39.80	4.30	44.10	74.00	-29.90	peak
3	7875.000	39.36	7.40	46.76	74.00	-27.24	peak
4	10590.000	36.97	11.88	48.85	74.00	-25.15	peak
5	13875.000	34.43	16.44	50.87	74.00	-23.13	peak
6	17805.000	28.84	23.31	52.15	74.00	-21.85	peak

- Note: 1. Peak Result = Reading Level + Correct Factor.
 2. If Peak Result complies with AV limit, AV Result is deemed to comply with AV limit.
 3. Peak: Peak detector.
 4. Filter losses were only considered in the spurious frequency bands and the authorized band was not corrected for High Pass Filter losses.
 5. Proper operation of the transmitter prior to adding the filter to the measurement chain.



HARMONICS AND SPURIOUS EMISSIONS (HIGH CHANNEL, VERTICAL)

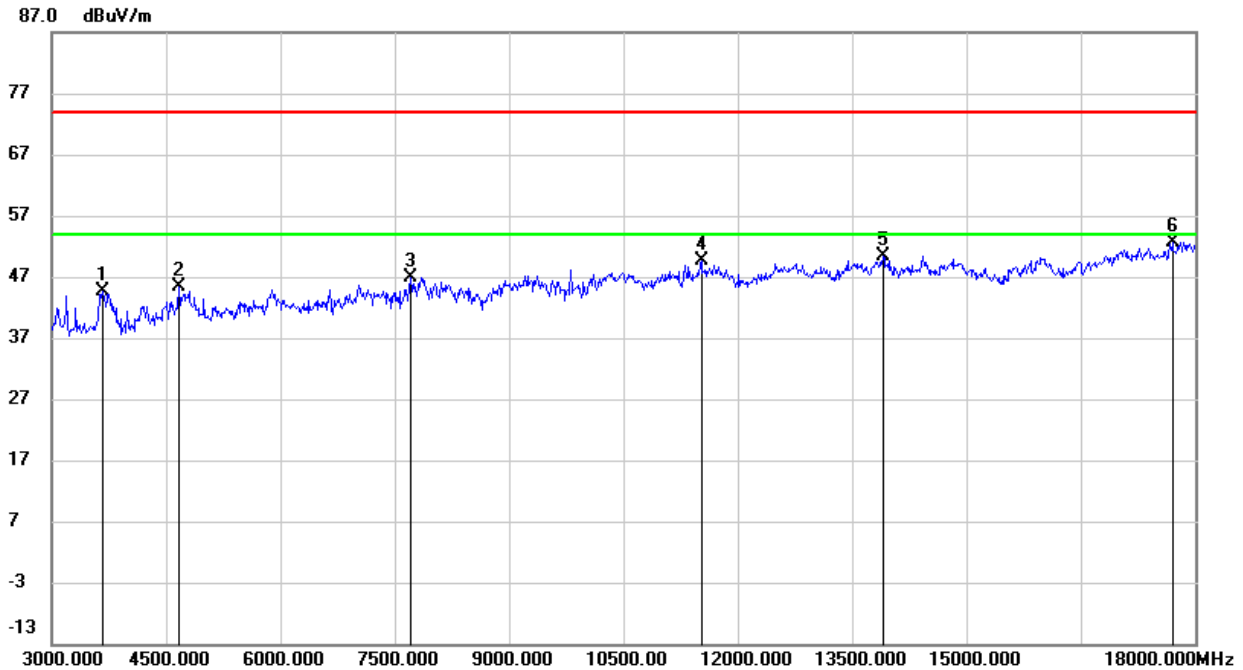

No.	Frequency (MHz)	Reading (dBuV)	Correct (dB/m)	Result (dBuV/m)	Limit (dBuV/m)	Margin (dB)	Remark
1	3660.000	47.61	-3.05	44.56	74.00	-29.44	peak
2	4665.000	45.38	-0.03	45.35	74.00	-28.65	peak
3	7710.000	40.27	6.64	46.91	74.00	-27.09	peak
4	11520.000	36.20	13.38	49.58	74.00	-24.42	peak
5	13905.000	34.11	16.20	50.31	74.00	-23.69	peak
6	17700.000	30.30	22.43	52.73	74.00	-21.27	peak

- Note: 1. Peak Result = Reading Level + Correct Factor.
 2. If Peak Result complies with AV limit, AV Result is deemed to comply with AV limit.
 3. Peak: Peak detector.
 4. Filter losses were only considered in the spurious frequency bands and the authorized band was not corrected for High Pass Filter losses.
 5. Proper operation of the transmitter prior to adding the filter to the measurement chain.



8.4. SPURIOUS EMISSIONS (18~26GHz)

8.4.1. 802.11b MIMO MODE

SPURIOUS EMISSIONS (LOW CHANNEL, WORST-CASE CONFIGURATION, HORIZONTAL)

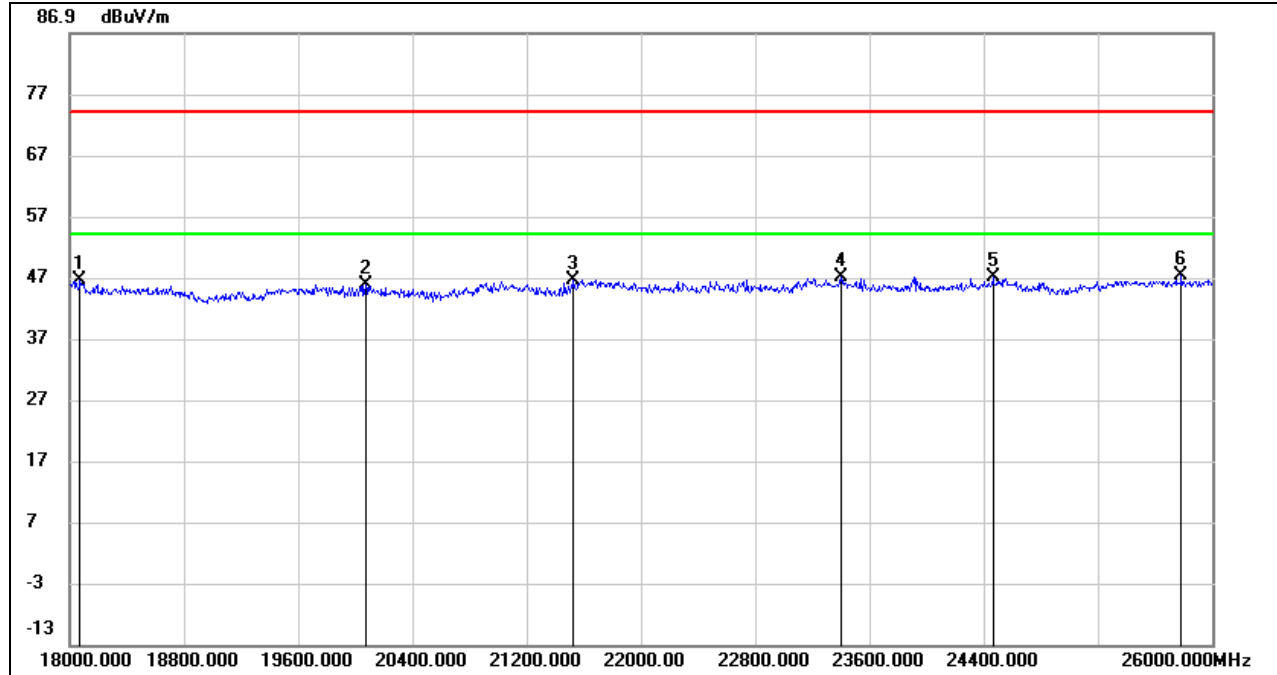

No.	Frequency (MHz)	Reading (dBuV)	Correct (dB/m)	Result (dBuV/m)	Limit (dBuV/m)	Margin (dB)	Remark
1	18072.000	50.55	-4.02	46.53	74.00	-27.47	peak
2	20072.000	50.34	-4.51	45.83	74.00	-28.17	peak
3	21528.000	52.42	-5.78	46.64	74.00	-27.36	peak
4	23400.000	51.92	-4.96	46.96	74.00	-27.04	peak
5	24464.000	49.78	-2.74	47.04	74.00	-26.96	peak
6	25784.000	48.73	-1.49	47.24	74.00	-26.76	peak

- Note: 1. Peak Result = Reading Level + Correct Factor.
 2. If Peak Result complies with AV limit, AV Result is deemed to comply with AV limit.
 3. Peak: Peak detector.

SPURIOUS EMISSIONS (LOW CHANNEL, WORST-CASE CONFIGURATION, VERTICAL)

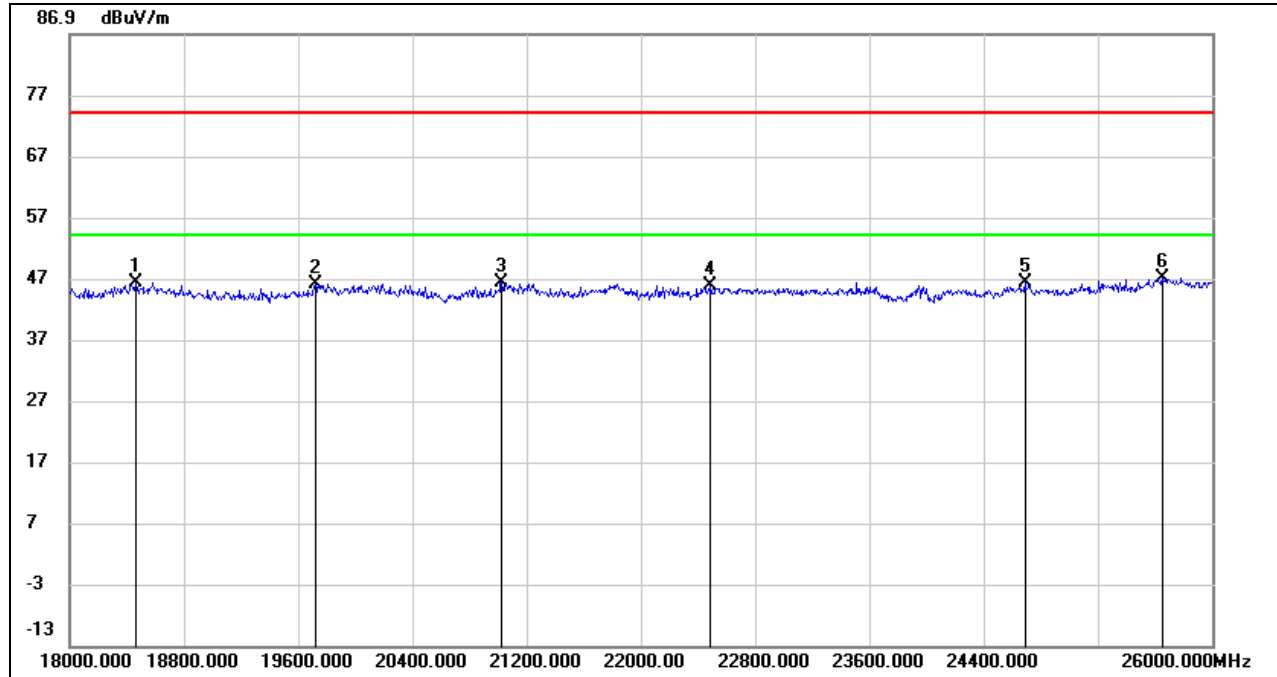

No.	Frequency (MHz)	Reading (dBuV)	Correct (dB/m)	Result (dBuV/m)	Limit (dBuV/m)	Margin (dB)	Remark
1	18464.000	50.70	-4.39	46.31	74.00	-27.69	peak
2	19720.000	50.50	-4.39	46.11	74.00	-27.89	peak
3	21024.000	51.64	-5.30	46.34	74.00	-27.66	peak
4	22488.000	51.60	-5.81	45.79	74.00	-28.21	peak
5	24688.000	48.39	-2.11	46.28	74.00	-27.72	peak
6	25648.000	48.62	-1.53	47.09	74.00	-26.91	peak

- Note: 1. Peak Result = Reading Level + Correct Factor.
 2. If Peak Result complies with AV limit, AV Result is deemed to comply with AV limit.
 3. Peak: Peak detector.

Note: All the test modes have been tested, only the worst data record in the report.

8.5. SPURIOUS EMISSIONS (0.03 ~ 1 GHz)

8.5.1. 802.11b MIMO MODE

SPURIOUS EMISSIONS (LOW CHANNEL, WORST-CASE CONFIGURATION, HORIZONTAL)

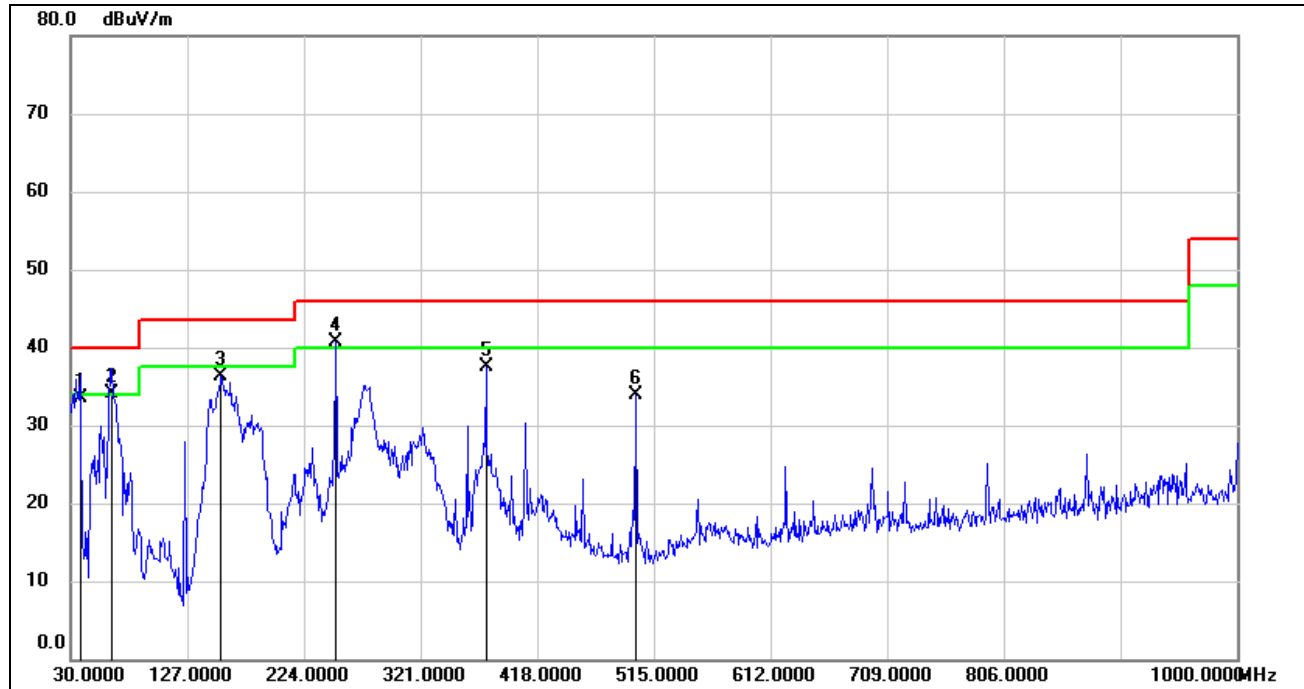

No.	Frequency (MHz)	Reading (dBuV)	Correct (dB/m)	Result (dBuV/m)	Limit (dBuV/m)	Margin (dB)	Remark
1	37.7599	51.25	-17.73	33.52	40.00	-6.48	QP
2	63.9500	53.75	-19.61	34.14	40.00	-5.86	QP
3	155.1300	54.31	-18.07	36.24	43.50	-7.26	QP
4	250.1900	57.00	-16.34	40.66	46.00	-5.34	QP
5	375.3200	50.57	-13.09	37.48	46.00	-8.52	QP
6	500.4500	44.79	-10.91	33.88	46.00	-12.12	QP

- Note: 1. Result Level = Read Level + Correct Factor.
 2. If Peak Result complies with QP limit, QP Result is deemed to comply with QP limit.
 3. Test setup: RBW: 120 kHz, VBW: 300 kHz, Sweep time: auto.

SPURIOUS EMISSIONS (LOW CHANNEL, WORST-CASE CONFIGURATION, VERTICAL)

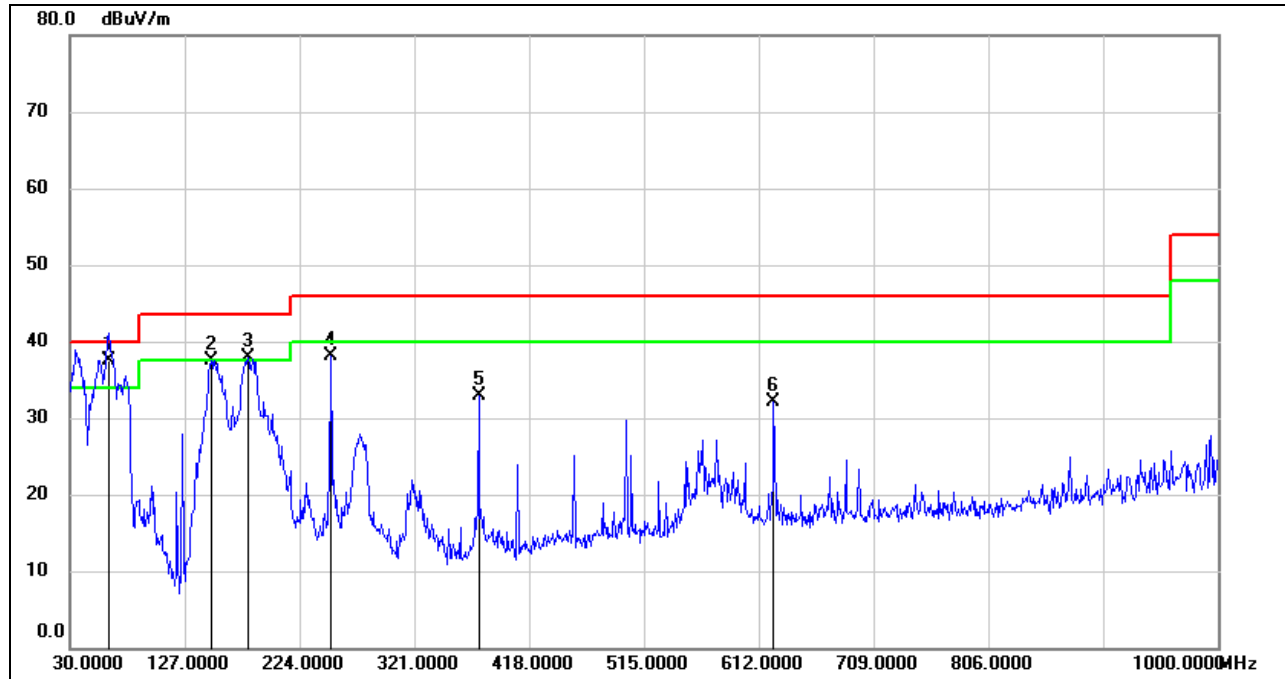

No.	Frequency (MHz)	Reading (dBuV)	Correct (dB/m)	Result (dBuV/m)	Limit (dBuV/m)	Margin (dB)	Remark
1	62.9800	57.03	-19.58	37.45	40.00	-2.55	QP
2	149.3100	55.94	-18.43	37.51	43.50	-5.99	QP
3	180.3500	54.46	-16.53	37.93	43.50	-5.57	QP
4	250.1900	54.39	-16.34	38.05	46.00	-7.95	QP
5	375.3200	46.07	-13.09	32.98	46.00	-13.02	QP
6	624.6100	40.54	-8.43	32.11	46.00	-13.89	QP

- Note: 1. Result Level = Read Level + Correct Factor.
 2. If Peak Result complies with QP limit, QP Result is deemed to comply with QP limit.
 3. Test setup: RBW: 120 kHz, VBW: 300 kHz, Sweep time: auto

Note: All the test modes have been tested, only the worst data record in the report.

8.6. SPURIOUS EMISSIONS BELOW 30M

8.6.1. 802.11b MIMO MODE

SPURIOUS EMISSIONS (LOW CHANNEL, LOOP ANTENNA FACE ON TO THE EUT, WORST-CASE CONFIGURATION)

9kHz~ 150kHz

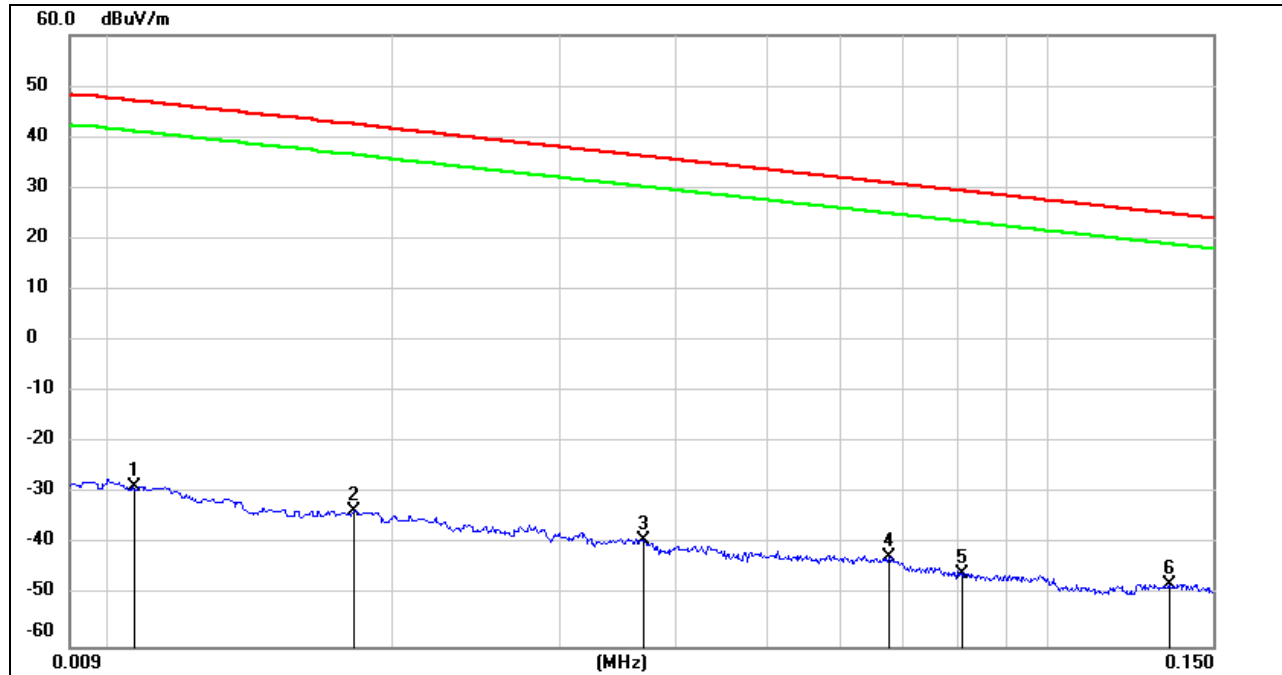

No.	Frequency (MHz)	Reading (dBuV)	Correct (dB/m)	FCC Result (dBuV/m)	FCC Limit (dBuV/m)	ISED Result (dBuA/m)	ISED Limit (dBuA/m)	Margin (dB)	Remark
1	0.0106	72.88	-101.39	-28.51	47.09	-80.01	-4.41	-75.60	peak
2	0.0181	67.85	-101.36	-33.51	42.45	-85.01	-9.05	-75.96	peak
3	0.0369	62.19	-101.42	-39.23	36.26	-90.73	-15.24	-75.49	peak
4	0.0675	59.14	-101.56	-42.42	31.02	-93.92	-20.48	-73.44	peak
5	0.0810	56.02	-101.64	-45.62	29.43	-97.12	-22.07	-75.05	peak
6	0.1348	53.91	-101.68	-47.77	25.01	-99.27	-26.49	-72.78	peak

Note: 1. Measurement = Reading Level + Correct Factor (dBuA/m= dBuV/m- 20Log10[120π] = dBuV/m- 51.5).

2. If Peak Result complies with AV and QP limit, AV and QP Result are deemed to comply with AV limit.

3. All 3 polarizations(Horizontal, Face-on and Face-off) of the loop antenna had been tested, but only the worst data recorded in the report.

150kHz ~ 490kHz

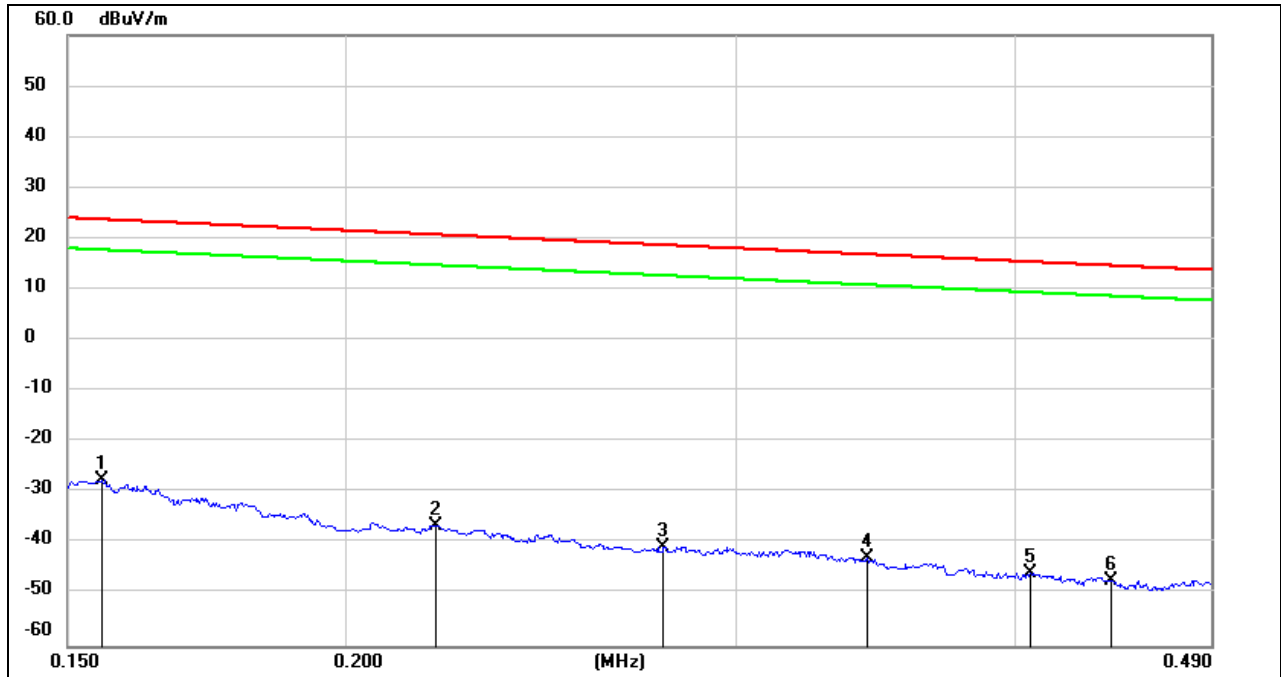

No.	Frequency (MHz)	Reading (dBuV)	Correct (dB/m)	FCC Result (dBuV/m)	FCC Limit (dBuV/m)	ISED Result (dBuA/m)	ISED Limit (dBuA/m)	Margin (dB)	Remark
1	0.1554	74.27	-101.65	-27.38	23.77	-78.88	-27.73	-51.15	peak
2	0.2197	65.27	-101.75	-36.48	20.76	-87.98	-30.74	-57.24	peak
3	0.2782	61.29	-101.83	-40.54	18.71	-92.04	-32.79	-59.25	peak
4	0.3431	59.17	-101.90	-42.73	16.89	-94.23	-34.61	-59.62	peak
5	0.4062	56.14	-101.96	-45.82	15.43	-97.32	-36.07	-61.25	peak
6	0.4420	54.83	-102.01	-47.18	14.69	-98.68	-36.81	-61.87	peak

Note: 1. Measurement = Reading Level + Correct Factor (dBuA/m= dBuV/m- 20Log10[120π] = dBuV/m- 51.5).

2. If Peak Result complies with AV and QP limit, AV and QP Result are deemed to comply with AV limit.

3. All 3 polarizations(Horizontal, Face-on and Face-off) of the loop antenna had been tested, but only the worst data recorded in the report.

490kHz ~ 30MHz

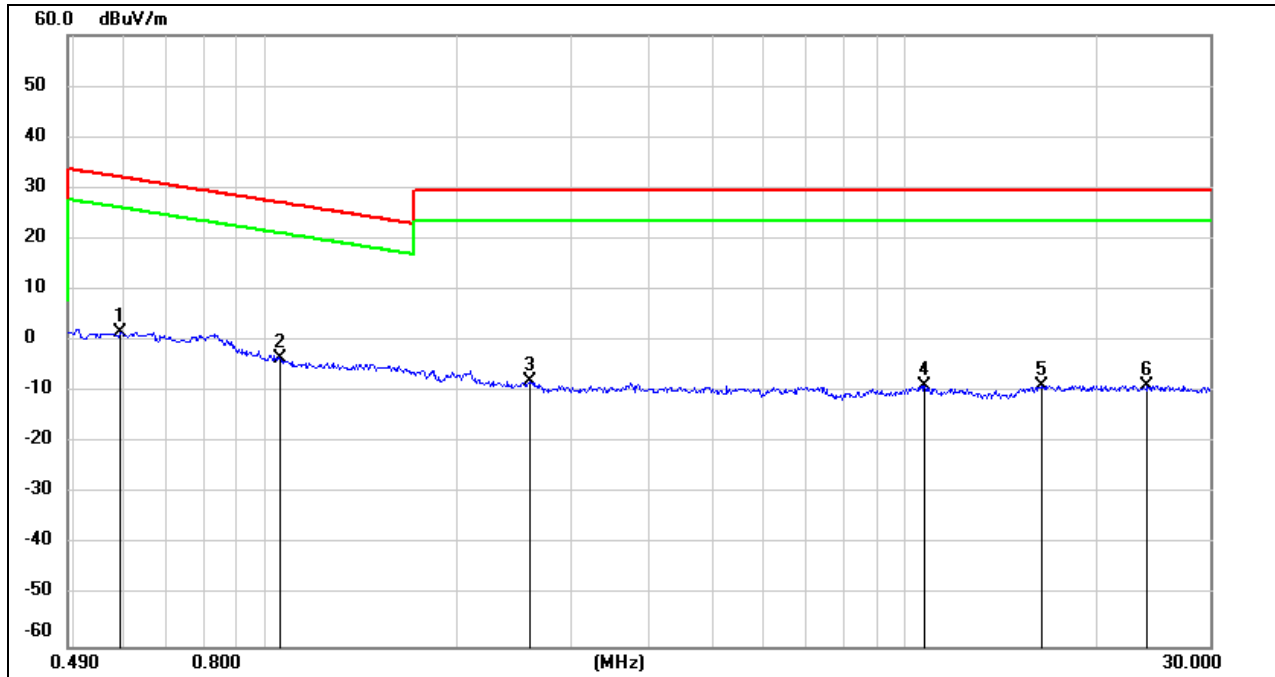

No.	Frequency (MHz)	Reading (dBuV)	Correct (dB/m)	FCC Result (dBuV/m)	FCC Limit (dBuV/m)	ISED Result (dBuA/m)	ISED Limit (dBuA/m)	Margin (dB)	Remark
1	0.5917	63.74	-62.08	1.66	32.16	-49.84	-19.34	-30.50	peak
2	1.0525	58.94	-62.24	-3.30	27.16	-54.8	-24.34	-30.46	peak
3	2.5935	53.61	-61.68	-8.07	29.54	-59.57	-21.96	-37.61	peak
4	10.7299	51.98	-60.83	-8.85	29.54	-60.35	-21.96	-38.39	peak
5	16.3959	52.17	-60.96	-8.79	29.54	-60.29	-21.96	-38.33	peak
6	23.9800	51.67	-60.53	-8.86	29.54	-60.36	-21.96	-38.40	peak

Note: 1. Measurement = Reading Level + Correct Factor (dBuA/m= dBuV/m- 20Log10[120π] = dBuV/m- 51.5).

2. If Peak Result complies with AV and QP limit, AV and QP Result are deemed to comply with AV limit.

3. All 3 polarizations(Horizontal, Face-on and Face-off) of the loop antenna had been tested, but only the worst data recorded in the report.

Note: All the test modes have been tested, only the worst data record in the report.

9. AC POWER LINE CONDUCTED EMISSIONS

LIMITS

Please refer to CFR 47 FCC §15.207 (a) and ISED RSS-Gen Clause 8.8

FREQUENCY (MHz)	Quasi-peak	Average
0.15 -0.5	66 - 56 *	56 - 46 *
0.50 -5.0	56.00	46.00
5.0 -30.0	60.00	50.00

TEST SETUP AND PROCEDURE

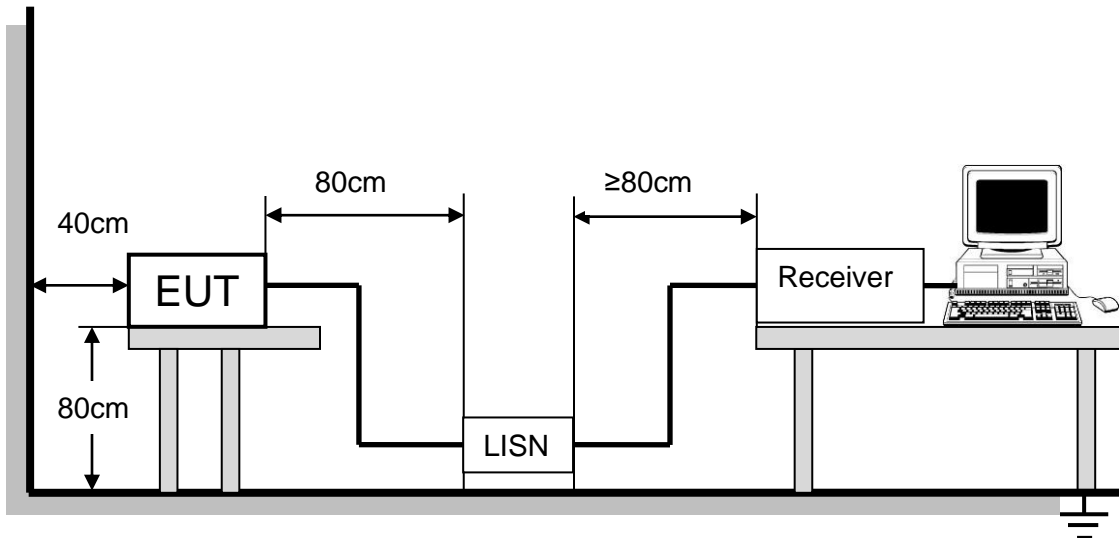

The EUT is put on a table of non-conducting material that is 80cm high. The vertical conducting wall of shielding is located 40cm to the rear of the EUT. The power line of the EUT is connected to the AC mains through an Artificial Mains Network (A.M.N.). A EMI Measurement Receiver (R&S Test Receiver ESR3) is used to test the emissions from both sides of AC line. According to the requirements in Section 6.2 of ANSI C63.10-2013. Conducted emissions from the EUT measured in the frequency range between 0.15 MHz and 30MHz using CISPR Quasi-Peak and average detector mode. The bandwidth of EMI test receiver is set at 9kHz.

The arrangement of the equipment is installed to meet the standards and operating in a manner, which tends to maximize its emission characteristics in a normal application.

TEST ENVIRONMENT

Temperature	26.4°C	Relative Humidity	67.9%
Atmosphere Pressure	101kPa	Test Voltage	AC 120V/60Hz



TEST RESULTS

9.1. 802.11b MIMO MODE

LINE N RESULTS (LOW CHANNEL, WORST-CASE CONFIGURATION)

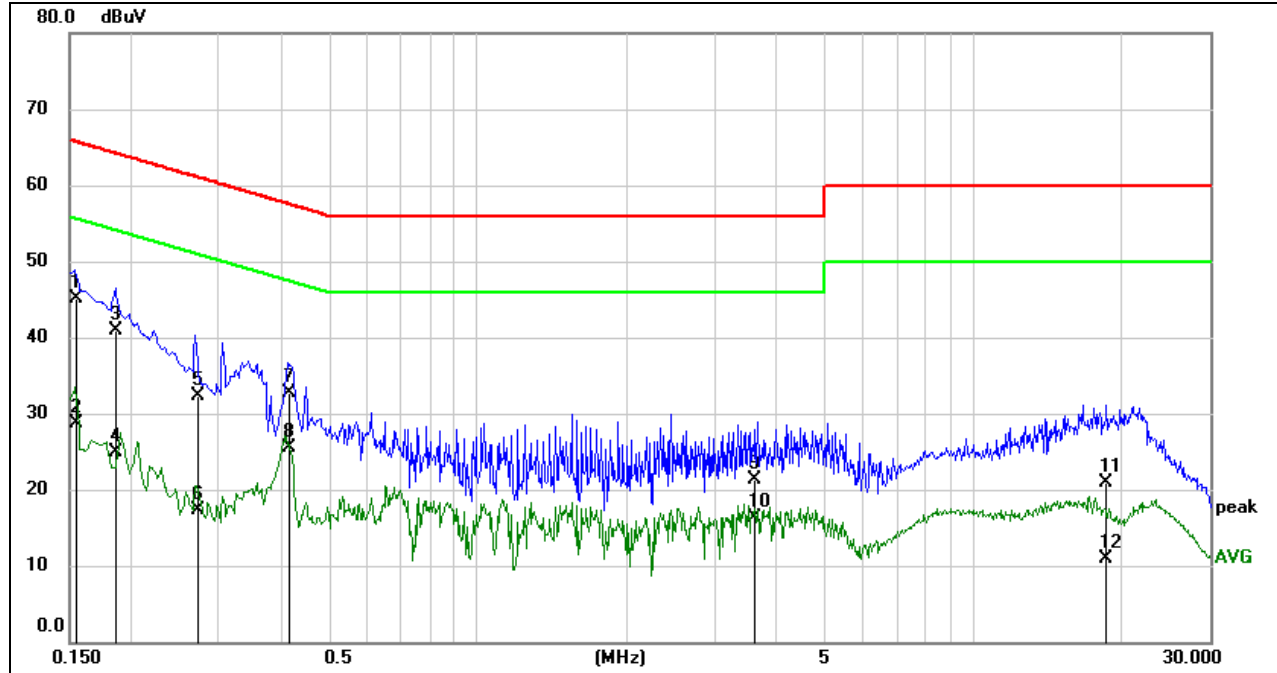

No.	Frequency (MHz)	Reading (dBuV)	Correct (dB)	Result (dBuV)	Limit (dBuV)	Margin (dB)	Remark
1	0.1552	35.56	9.61	45.17	65.72	-20.55	QP
2	0.1552	19.09	9.61	28.70	55.72	-27.02	AVG
3	0.1853	31.34	9.60	40.94	64.24	-23.30	QP
4	0.1853	15.36	9.60	24.96	54.24	-29.28	AVG
5	0.2717	22.79	9.60	32.39	61.07	-28.68	QP
6	0.2717	7.70	9.60	17.30	51.07	-33.77	AVG
7	0.4153	23.15	9.60	32.75	57.54	-24.79	QP
8	0.4153	15.92	9.60	25.52	47.54	-22.02	AVG
9	3.6193	11.58	9.65	21.23	56.00	-34.77	QP
10	3.6193	6.71	9.65	16.36	46.00	-29.64	AVG
11	18.5065	10.88	10.04	20.92	60.00	-39.08	QP
12	18.5065	0.89	10.04	10.93	50.00	-39.07	AVG

- Note: 1. Result = Reading +Correct Factor.
 2. If QP Result complies with AV limit, AV Result is deemed to comply with AV limit.
 3. Test setup: RBW: 200 Hz (9 kHz—150 kHz), 9 kHz (150 kHz—30 MHz).
 4. Step size: 80Hz (0.009MHz-0.15MHz), 4 kHz (0.15MHz-30MHz), Scan time: auto.

LINE L RESULTS (LOW CHANNEL, WORST-CASE CONFIGURATION)

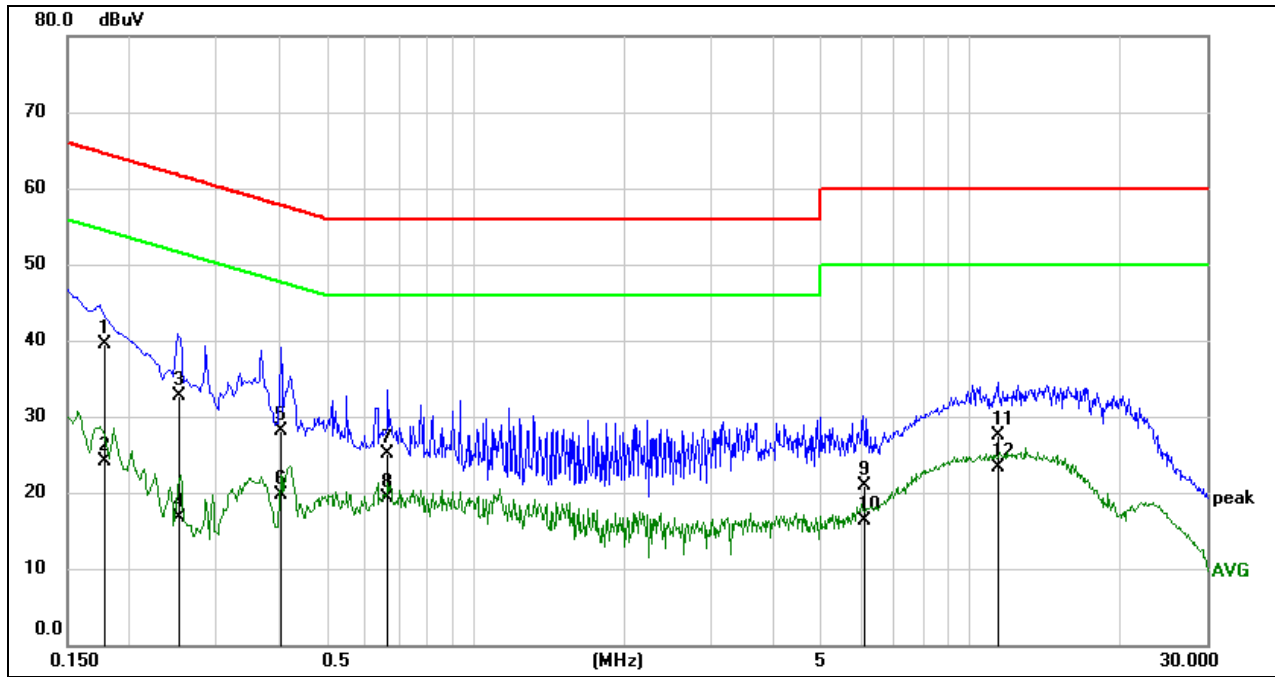

No.	Frequency (MHz)	Reading (dBuV)	Correct (dB)	Result (dBuV)	Limit (dBuV)	Margin (dB)	Remark
1	0.1781	29.98	9.60	39.58	64.57	-24.99	QP
2	0.1781	14.52	9.60	24.12	54.57	-30.45	AVG
3	0.2522	23.06	9.60	32.66	61.68	-29.02	QP
4	0.2522	7.05	9.60	16.65	51.68	-35.03	AVG
5	0.4055	18.46	9.60	28.06	57.74	-29.68	QP
6	0.4055	10.01	9.60	19.61	47.74	-28.13	AVG
7	0.6625	15.44	9.60	25.04	56.00	-30.96	QP
8	0.6625	9.75	9.60	19.35	46.00	-26.65	AVG
9	6.1061	11.10	9.71	20.81	60.00	-39.19	QP
10	6.1061	6.53	9.71	16.24	50.00	-33.76	AVG
11	11.3281	17.68	9.79	27.47	60.00	-32.53	QP
12	11.3281	13.44	9.79	23.23	50.00	-26.77	AVG

- Note: 1. Result = Reading +Correct Factor.
 2. If QP Result complies with AV limit, AV Result is deemed to comply with AV limit.
 3. Test setup: RBW: 200 Hz (9 kHz—150 kHz), 9 kHz (150 kHz—30 MHz).
 4. Step size: 80Hz (0.009MHz-0.15MHz), 4 kHz (0.15MHz-30MHz), Scan time: auto.

Note: All test modes have been tested, only the worst data record in the report.



10. ANTENNA REQUIREMENTS

APPLICABLE REQUIREMENTS

Please refer to FCC §15.203

An intentional radiator shall be designed to ensure that no antenna other than that furnished by the responsible party shall be used with the device. The use of a permanently attached antenna or of an antenna that uses a unique coupling to the intentional radiator shall be considered sufficient to comply with the provisions of this section. The manufacturer may design the unit so that a broken antenna can be replaced by the user, but the use of a standard antenna jack or electrical connector is prohibited.

Please refer to FCC §15.247(b)(4)

The conducted output power limit specified in paragraph (b) of this section is based on the use of antennas with directional gains that do not exceed 6 dBi. Except as shown in paragraph (c) of this section, if transmitting antennas of directional gain greater than 6 dBi are used, the conducted output power from the intentional radiator shall be reduced below the stated values in paragraphs (b)(1), (b)(2), and (b)(3) of this section, as appropriate, by the amount in dB that the directional gain of the antenna exceeds 6 dBi.

RESULTS

Complies

11. APPENDIX

11.1. APPENDIX A: DTS BANDWIDTH

11.1.1. TEST RESULT

Test Mode	Antenna	Channel	DTS BW [MHz]	FL[MHz]	FH[MHz]	Limit[MHz]	Verdict
11B-MIMO	Ant1	2412	9.680	2406.960	2416.640	0.5	PASS
	Ant2	2412	10.120	2406.960	2417.080	0.5	PASS
	Ant1	2437	10.120	2431.960	2442.080	0.5	PASS
	Ant2	2437	10.120	2432.000	2442.120	0.5	PASS
	Ant1	2462	9.680	2456.960	2466.640	0.5	PASS
	Ant2	2462	10.120	2456.960	2467.080	0.5	PASS
11G-MIMO	Ant1	2412	16.520	2403.760	2420.280	0.5	PASS
	Ant2	2412	16.520	2403.760	2420.280	0.5	PASS
	Ant1	2437	16.560	2428.720	2445.280	0.5	PASS
	Ant2	2437	16.480	2428.800	2445.280	0.5	PASS
	Ant1	2462	16.520	2453.760	2470.280	0.5	PASS
	Ant2	2462	16.520	2453.760	2470.280	0.5	PASS
11N20MIMO	Ant1	2412	17.680	2403.200	2420.880	0.5	PASS
	Ant2	2412	17.680	2403.200	2420.880	0.5	PASS
	Ant1	2437	17.680	2428.200	2445.880	0.5	PASS
	Ant2	2437	17.680	2428.200	2445.880	0.5	PASS
	Ant1	2462	17.680	2453.200	2470.880	0.5	PASS
	Ant2	2462	17.680	2453.200	2470.880	0.5	PASS
11N40MIMO	Ant1	2422	36.560	2403.760	2440.320	0.5	PASS
	Ant2	2422	36.560	2403.760	2440.320	0.5	PASS
	Ant1	2437	36.480	2418.760	2455.240	0.5	PASS
	Ant2	2437	36.560	2418.760	2455.320	0.5	PASS
	Ant1	2452	36.480	2433.760	2470.240	0.5	PASS
	Ant2	2452	36.480	2433.760	2470.240	0.5	PASS



11.1.2. TEST GRAPHS

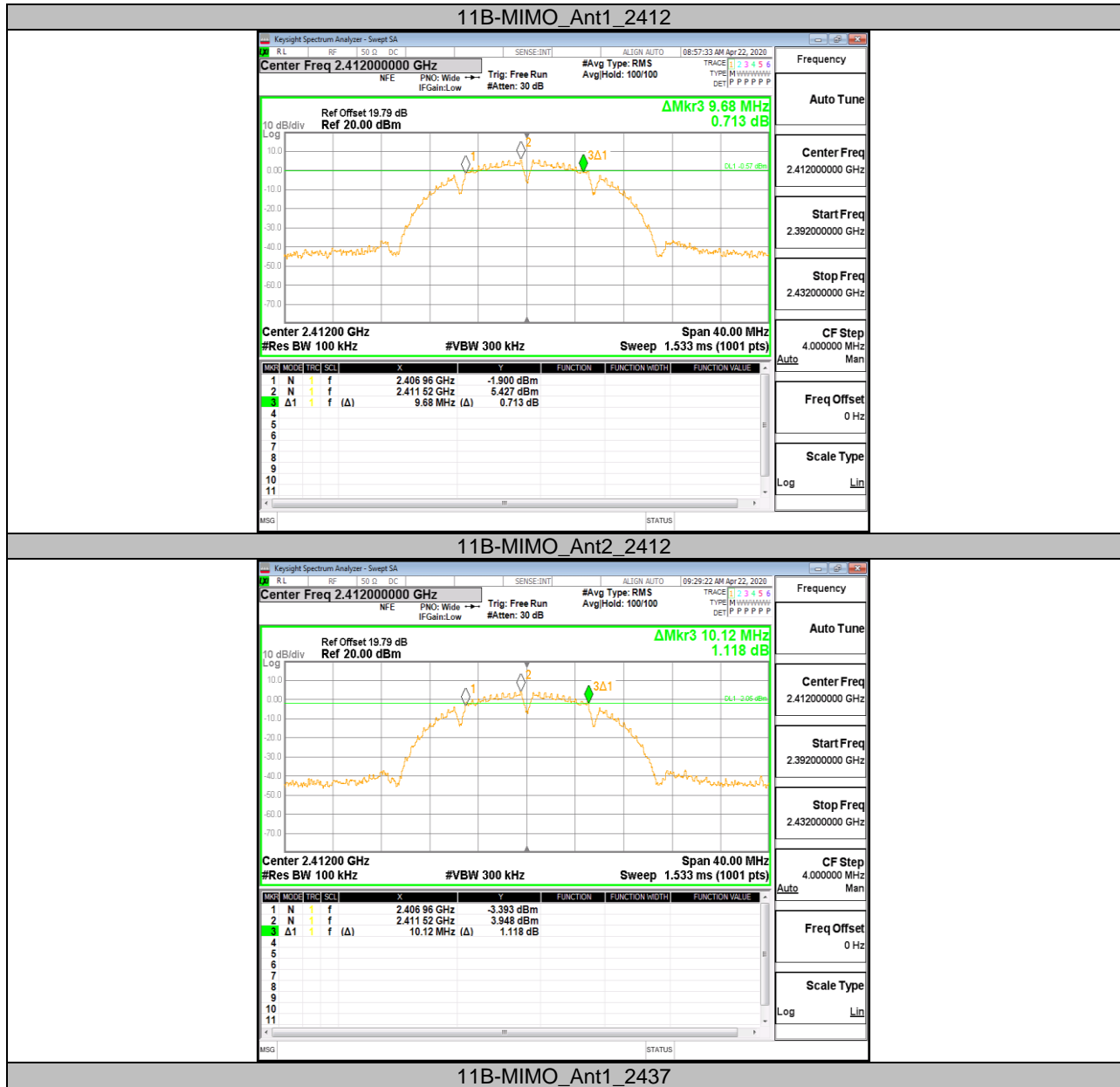

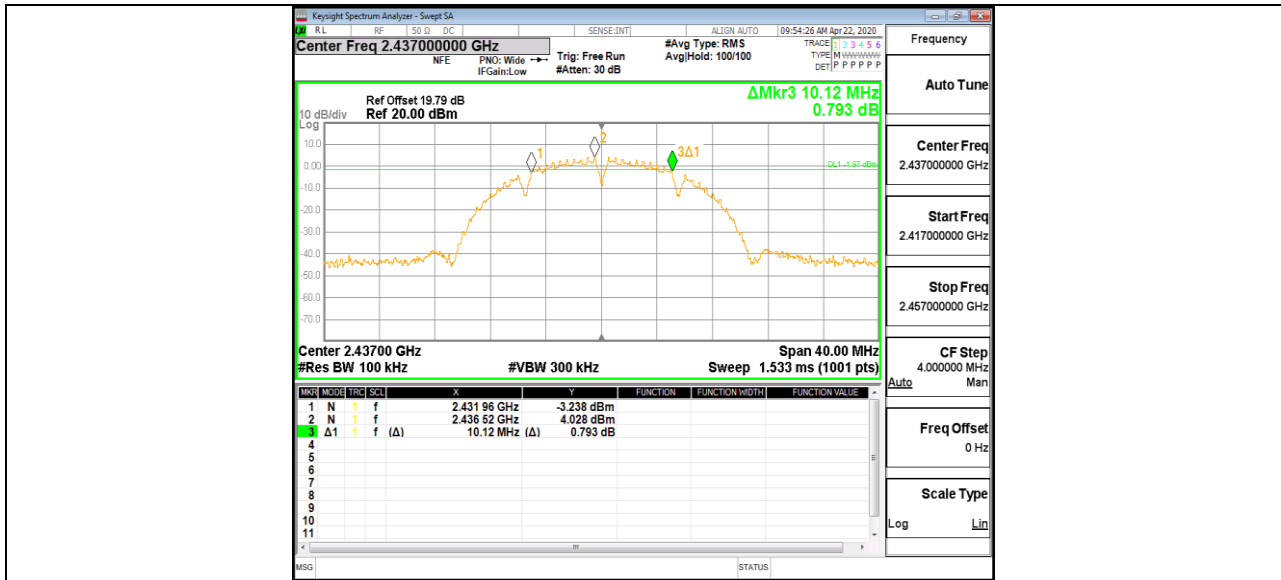

11B-MIMO_Ant2_2437

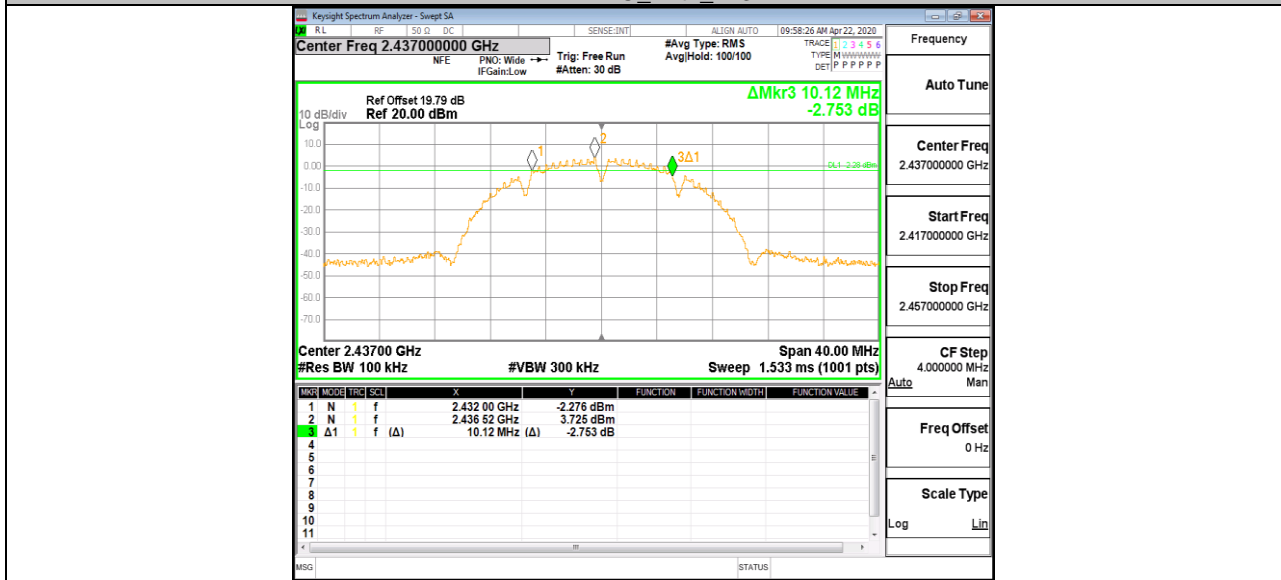

11B-MIMO_Ant1_2462

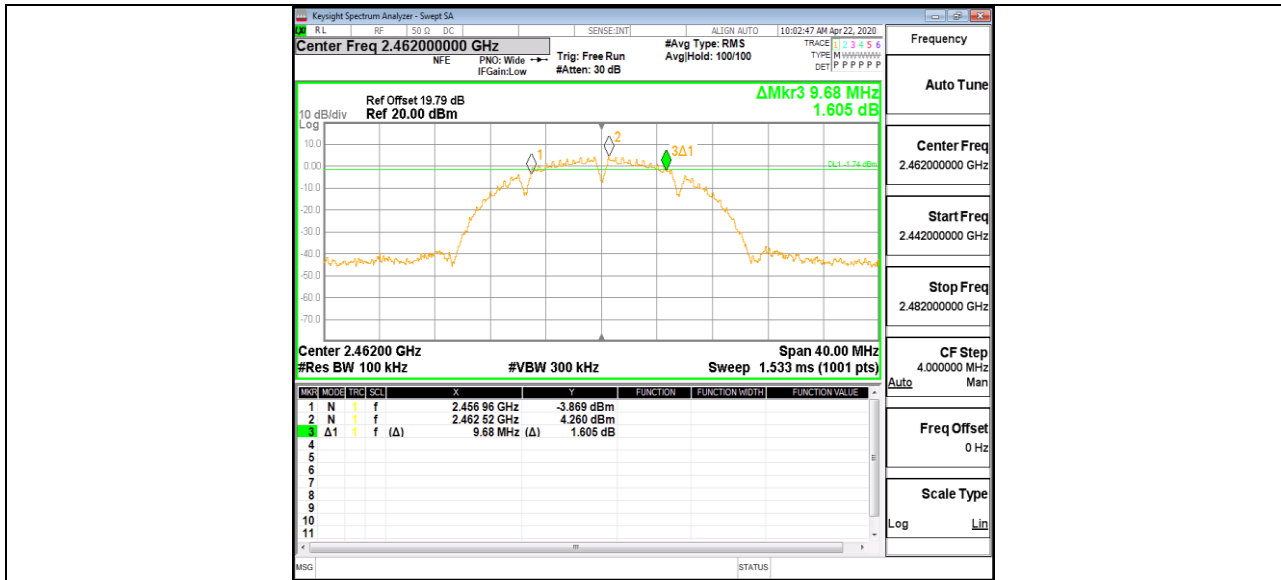

11B-MIMO_Ant2_2462

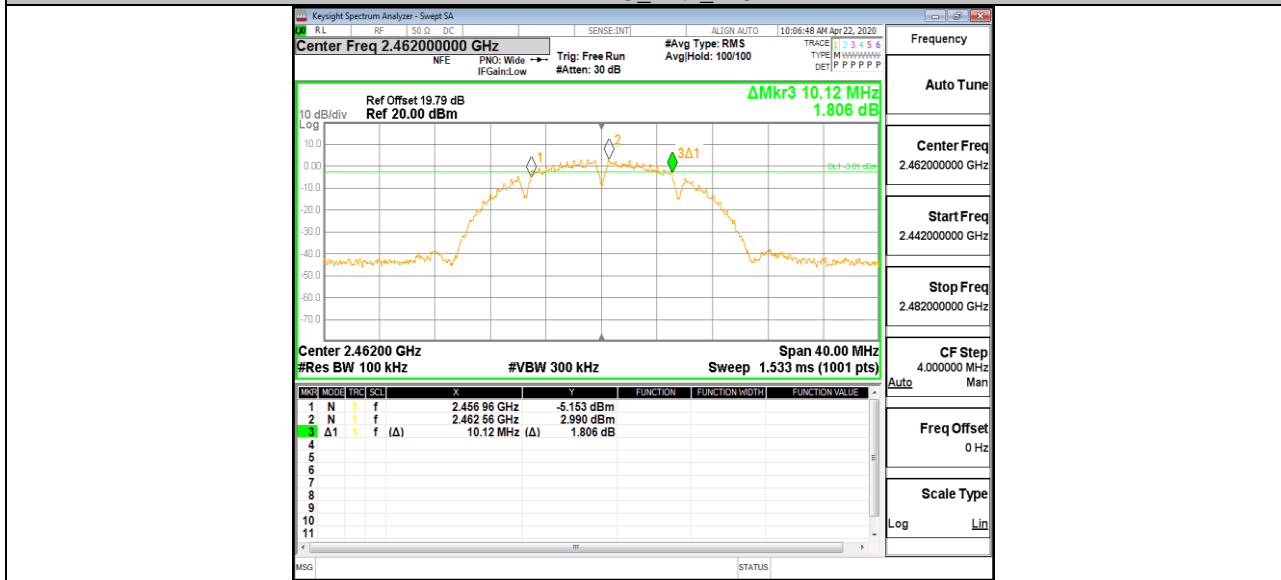

11G-MIMO_Ant1_2412

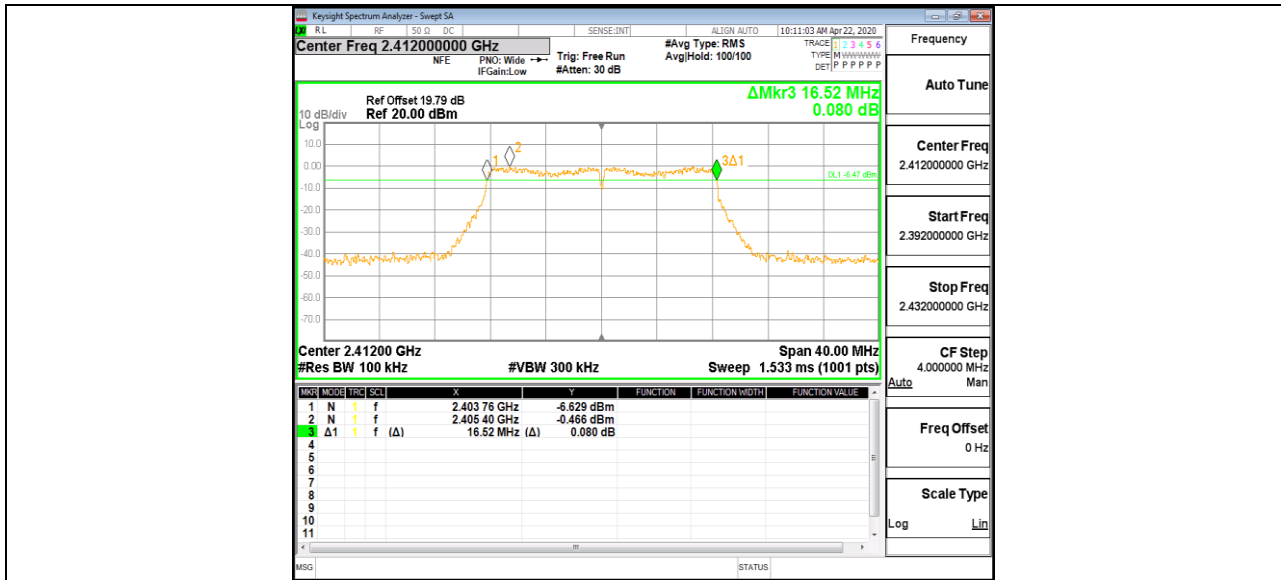

11G-MIMO_Ant2_2412

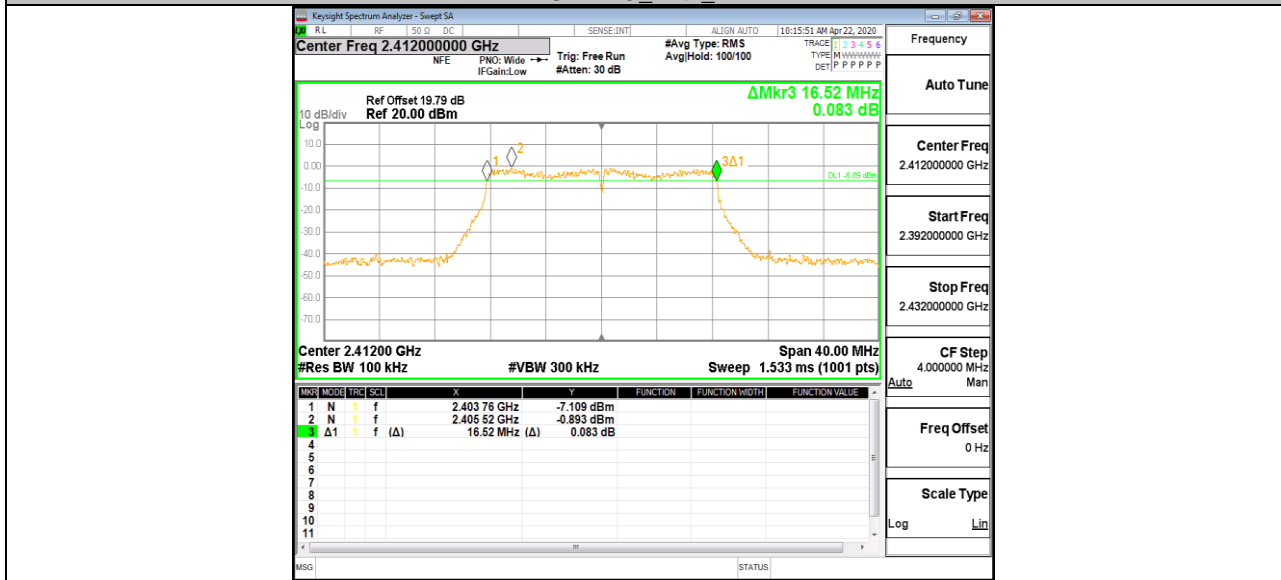

11G-MIMO_Ant1_2437

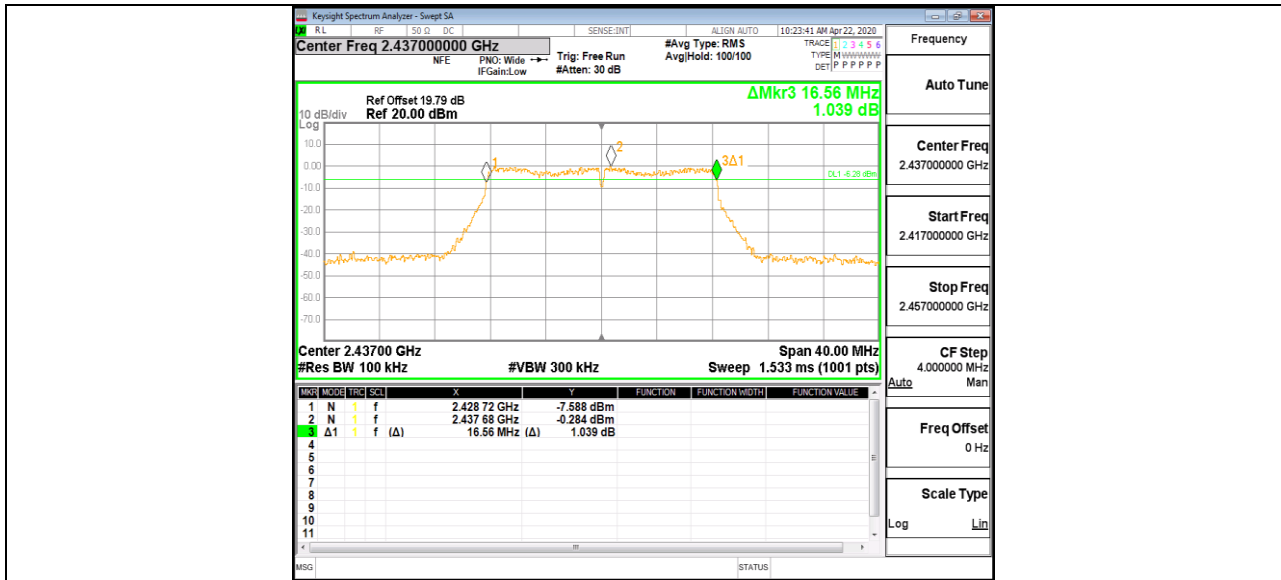

11G-MIMO_Ant2_2437

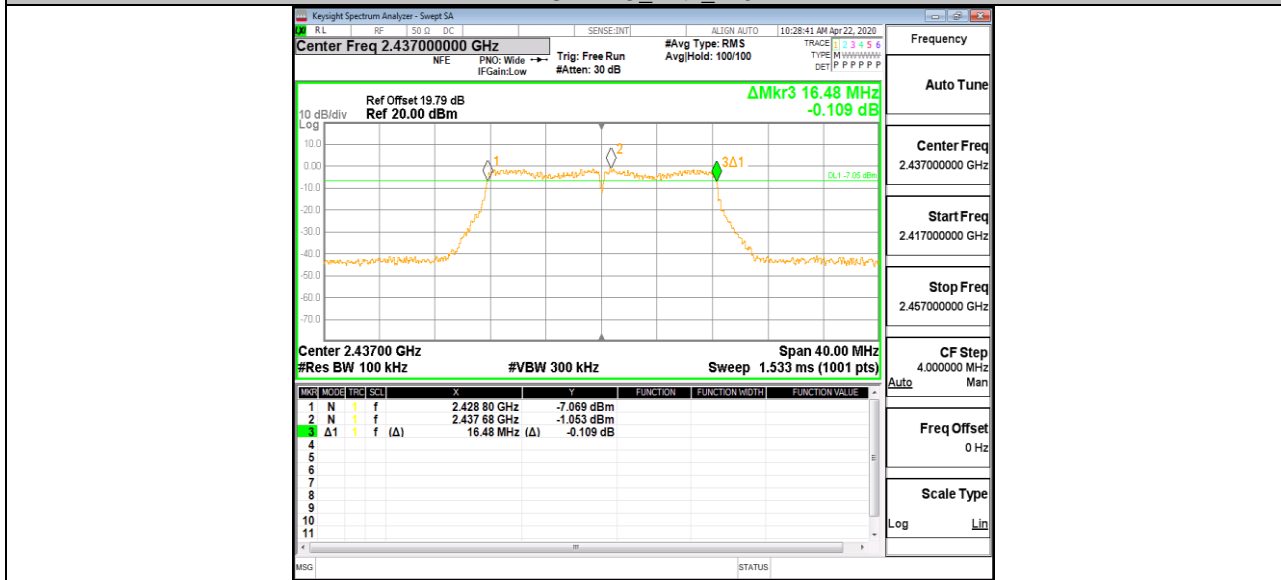

11G-MIMO_Ant1_2462

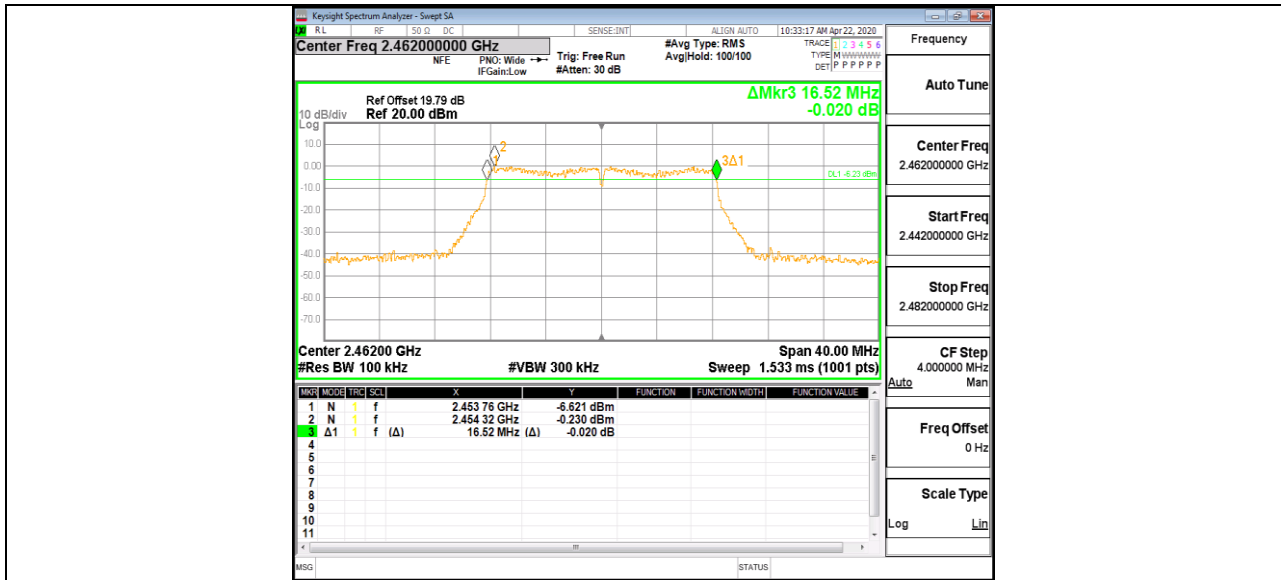

11G-MIMO_Ant2_2462

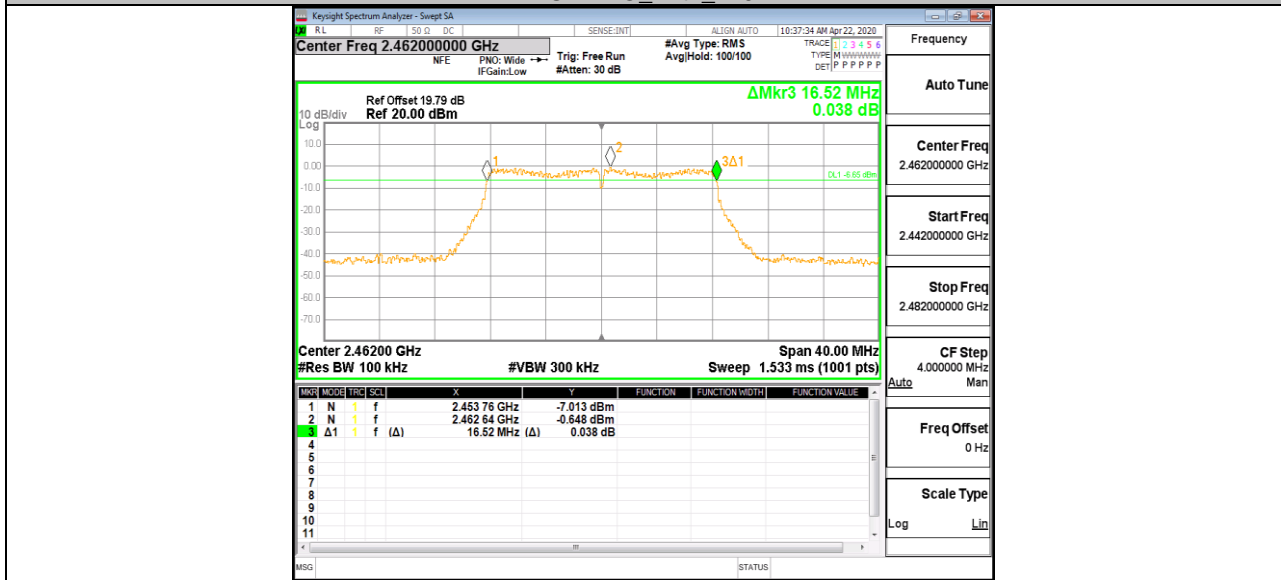

11N20MIMO_Ant1_2412

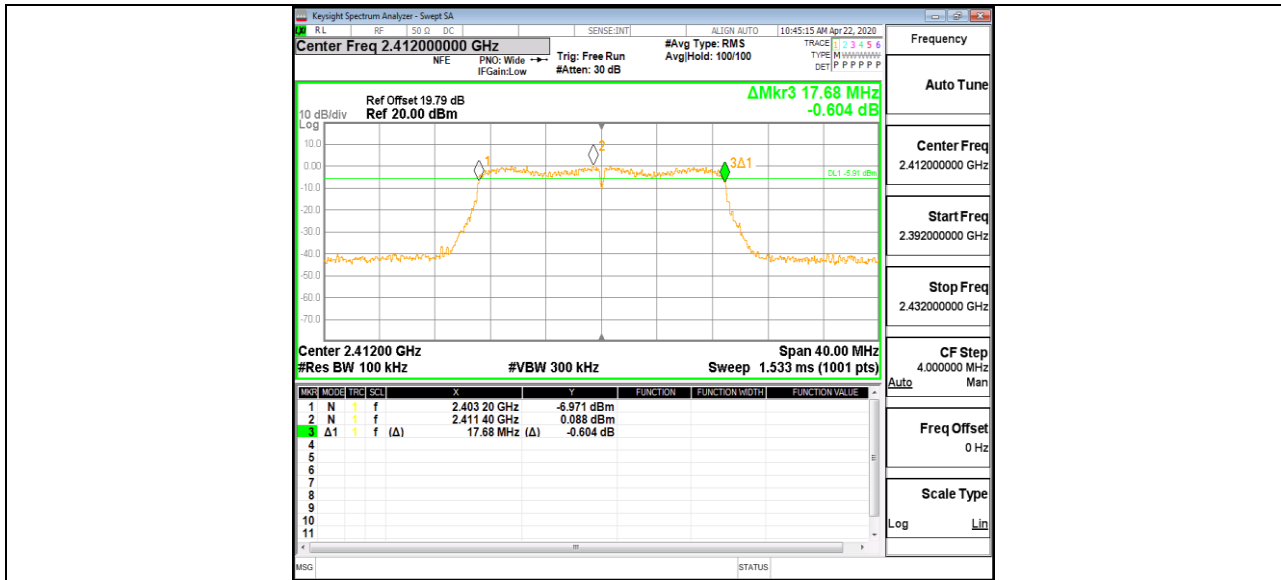

11N20MIMO_Ant2_2412

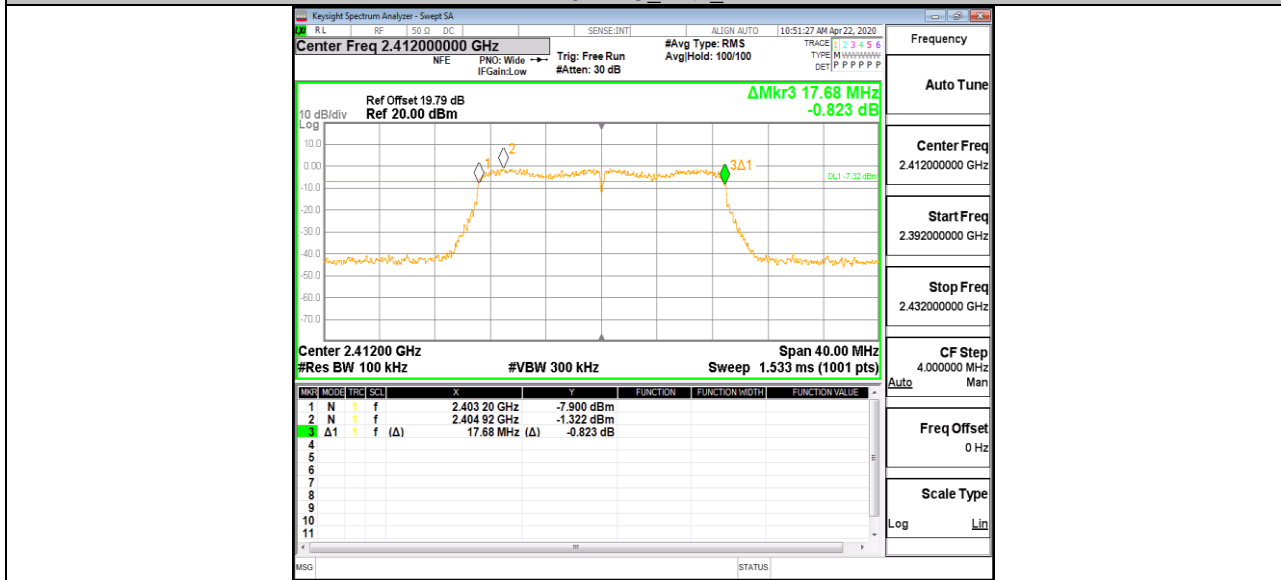

11N20MIMO_Ant1_2437