

Dangbei

 Google TV

Atom
Smart Projector

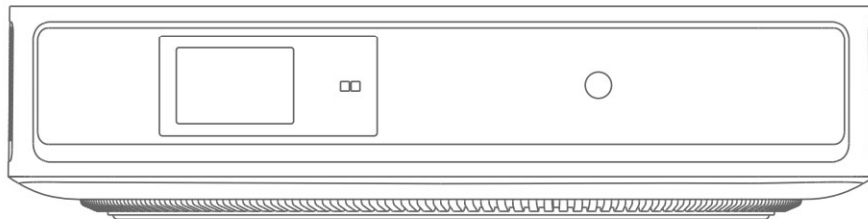

User Manual

Language

English	01-19
Deutsch	20-39
Français	40-59
Italiano	60-79
Español	80-99
日本語	100-119

Contents

Read before Use	01
Packing List	02
Projector Overview	03
Remote Control Overview	05
Getting Started	06
Network Settings	09
Focus Settings	09
Image Correction Settings	10
Bluetooth Speaker Mode	11
Google Assistant	11
Chromecast built-in™ & Screen Mirroring	12
Inputs	13
More Settings	13
Specifications	14
Troubleshooting	15
Important Precautions	17
Statement	18

Read before Use

Please read the product instructions carefully:

Thank you for purchasing and using these products.

For your safety and interests, please read the Product Instructions carefully before using the product.

About the Product Instructions:

The trademarks and names mentioned in the Product Instructions are the property of their respective owners.

All Product Instructions shown are for illustration purposes only. The actual product may vary due to product enhancements.

We shall not be liable for any personal injury, property damage, or other damages caused by the failure of the user to comply with the Product Instructions or precautions.

* Dangbei reserves the right to interpret and modify the Product Instructions.

Packing List

Before using this product, please check that all items are included in the box.

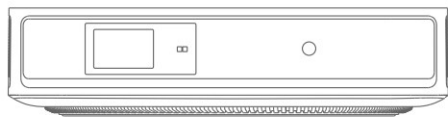

Projector



Remote Control
(batteries not included)

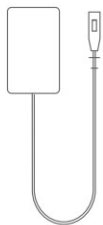

Power Adapter

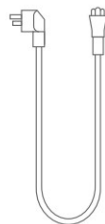

Power Cable

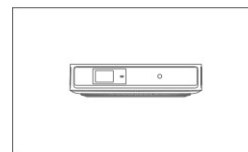

User Manual

Projector Overview

Overview and interface description.

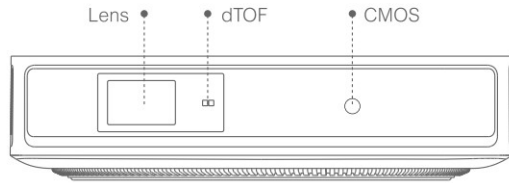

Front View

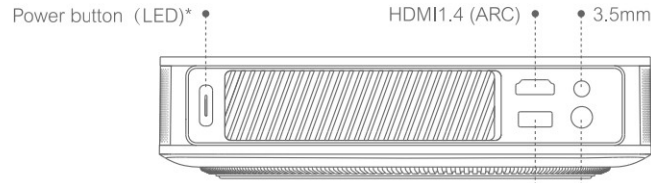

Rear View

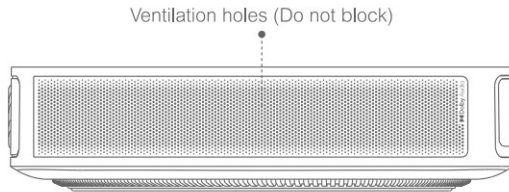

Left View

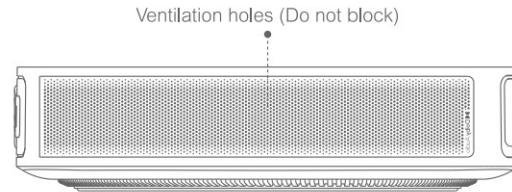

Right View



Top View

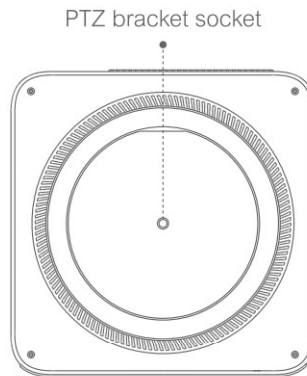

Bottom View

Power Button LED Indicator Guide		
Button	LED Status	Description
 Power button	On	Standby mode / Power on / Bluetooth speaker mode pairing successful / Power off
	Off	In projection
	Blinking	Firmware update / Bluetooth speaker mode pairing in progress

Remote Control Overview

- Open the battery compartment cover of the remote control.
- Install 2 AAA batteries (**not included**) *.
- Put back the battery compartment cover.

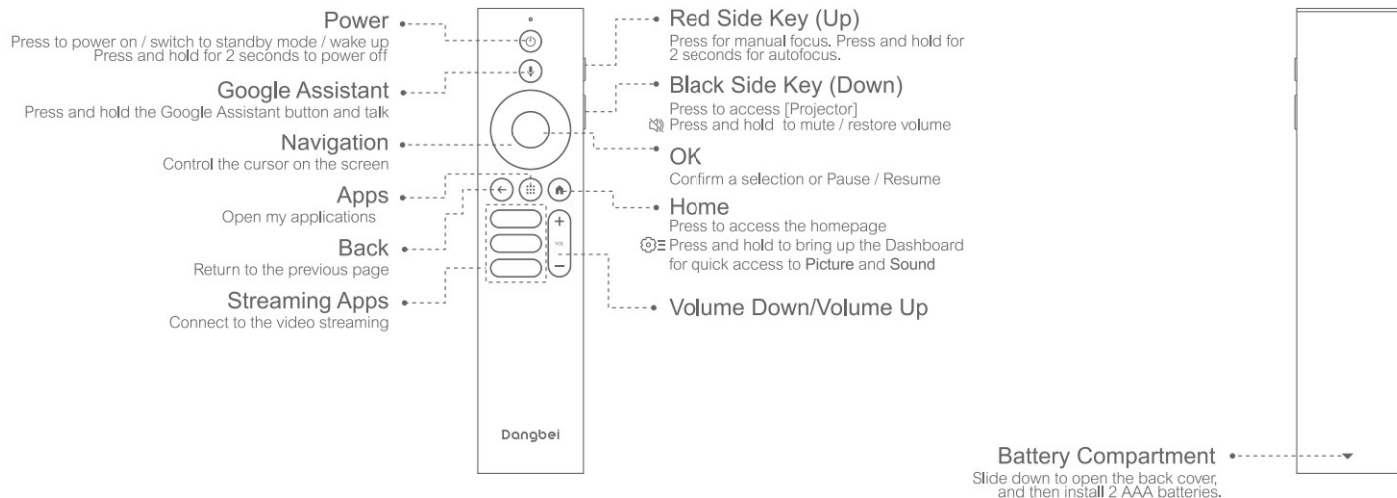

* Please insert new batteries according to the polarity indication.

Getting Started

1.Placement

Position the projector on a stable, flat surface in front of the projection surface. A flat and white projection surface is recommended. Please follow the instructions below to determine the distance between the projector and the projection surface, and the corresponding projection size:

Size	Screen (Length × Width)
60 inches	133 x 75 cm 4.36x2.46 ft
80 inches	177 x 100 cm 5.8x 3.28 ft
100 inches	221 x 124 cm 7.25 x 4.06 ft
120 inches	265 x 149 cm 8.69 x 4.88 ft



The best recommended projection size is 100 inches.

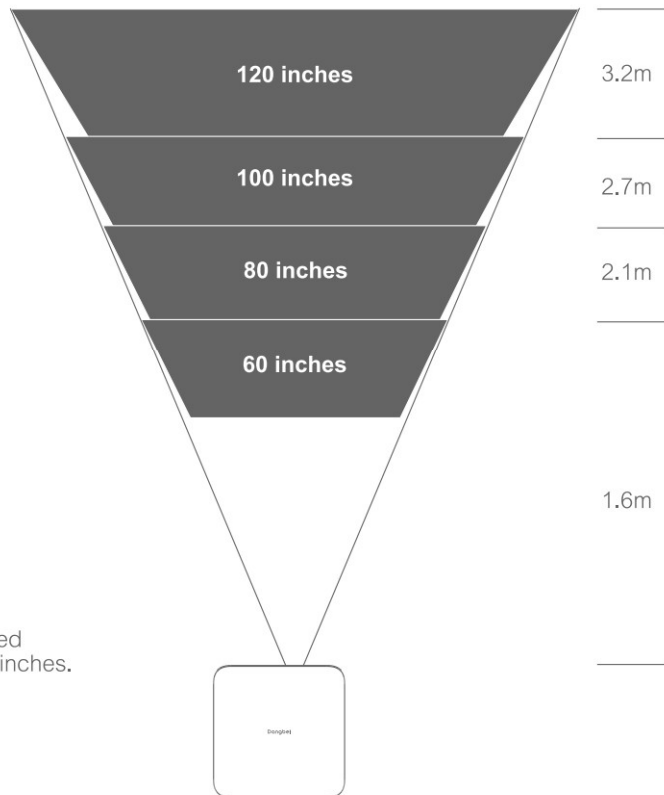

2. Power on

- ① Connect the projector to the power outlet.

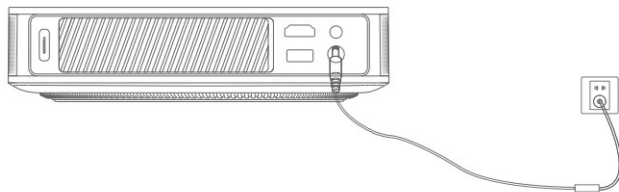

- ② Press the power button on the projector or remote control to turn on the projector.

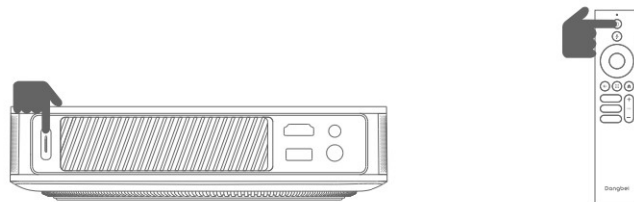



3. Standby Mode / Power off

Press the power button on the projector or remote control to enter standby mode.

Press and hold the power button on the projector or remote control for 2 seconds to turn off the projector.

3.Remote Control Pairing

- Turn on the projector and wait for the Bluetooth pairing prompt on the screen.
- Bring the remote control within 10 cm / 0.33 ft of the projector.
- Simultaneously press and hold the  and  keys.
- Release the keys after the indicator light starts flashing.
- Wait until you hear two "beep" sounds, indicating a successful pairing.

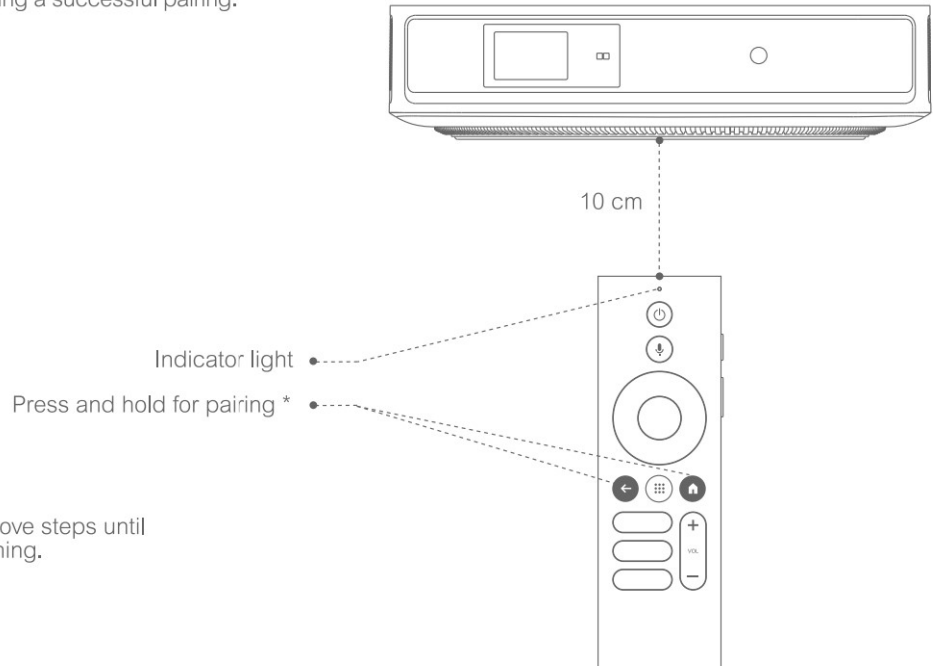

* If the pairing is unsuccessful, repeat the above steps until the remote control indicator light stops flashing.

Network Settings

- Go to [Settings], select [Network & Internet], and turn on Wi-Fi.
- Choose your network and enter the correct password.

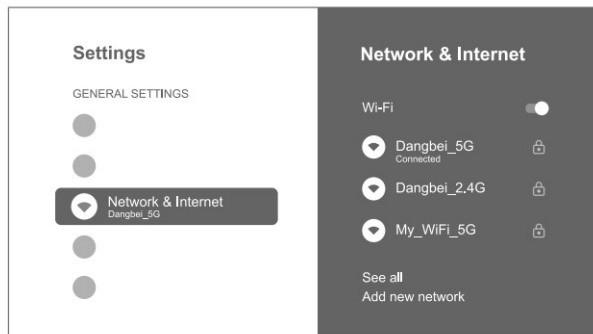

Focus Settings

Method 1: Press the red side key (up) for manual focus.

Press and hold for 2 seconds for autofocus.

Method 2: Go to [Projector], select [Focus], and choose either manual focus or autofocus.

Autofocus

Select [Auto Focus] to trigger the autofocus function.

The image will automatically become clear.

Manual focus

Select [Manual Focus] and use the navigation keys (up / down) on the remote control to adjust the focus distance and make the image clear.

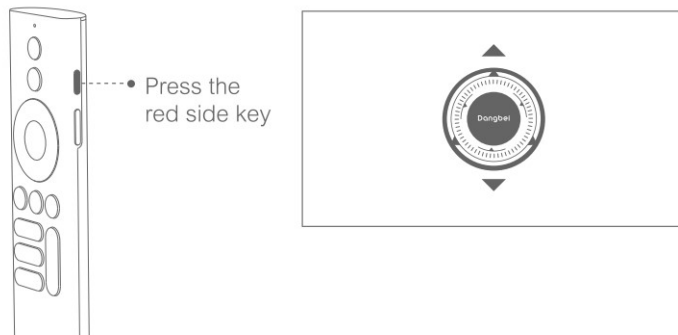
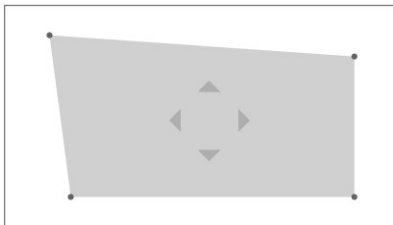

Image Correction Settings

1. Keystone Correction

- Go to [Projector] -- [Image Correction].
- Select [Auto Keystone Correction], and the screen will automatically be corrected.
- Select [Manual Keystone Correction], and use navigation keys to adjust the four points and the image shape.



2. Intelligent Screen Fit

- Go to [Projector] -- [Image Correction], and turn on [Fit to Screen].
- Follow the on-screen instructions to automatically adjust the projected image to fit the screen.

3. Intelligent Obstacle Avoidance

- Go to [Projector] -- [Image Correction] -- [Advanced], and turn on [Avoid Obstacles].
- Follow the on-screen instructions to automatically adjust the projected image to avoid any objects on the projection surface.

Bluetooth Speaker Mode

- Go to [Settings], select [Projector], and click on [Bluetooth speaker mode].
- Connect your phone to a device with the Bluetooth name containing "DBOD02". After modifying the device name, the Bluetooth name will also be synchronized accordingly.
- When you hear "Bluetooth connection successful", the projector can play music from your phone.
- Press and hold the  key on the remote control for 2 seconds to exit the [Bluetooth speaker mode].

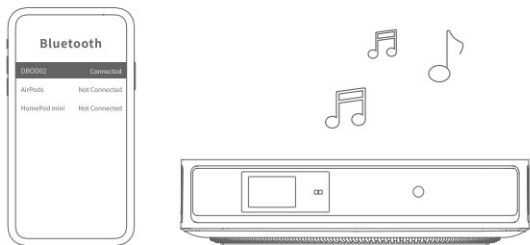

Google Assistant

Your TV is more helpful than ever. Use your voice to find movies, stream apps, play music and control the TV. Ask Google Assistant to find a specific title, search by genre, or get personalized recommendations. Even get answers on screen, control smart home devices, and more. Press the Google Assistant button on the remote to get started.

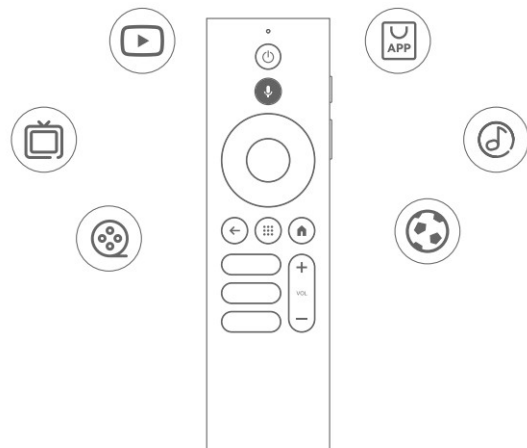

Chromecast built-in & Screen Mirroring

You can wirelessly cast movies, games, music, and your screen from your iOS, macOS, Android™, or Windows device to the projector. Please make sure that the projector and your device are connected to the same wireless network.

1. Chromecast built-in

To cast in-app content:

You can cast content from Chromecast-enabled apps such as YouTube and other streaming apps.

1. Connect your device and the projector to the same wireless network.
2. Open the streaming app on your device.
3. Play a video and tap the casting icon  on the video screen.
4. Select "DBOD02" to connect. The projector will display the video from your device.

*Due to copyright restrictions, certain content cannot be cast to the projector. You can stream the content on the projector by installing the same application on it.

2. Screen Mirroring via AirScreen

To cast the device screen:

You can project the entire screen from your device to the projector.

1. Ensure that both your device and the projector are connected to the same wireless network.
2. Install the AirScreen app on the projector.
3. Open the AirScreen app and follow the on-screen instructions to complete the process.

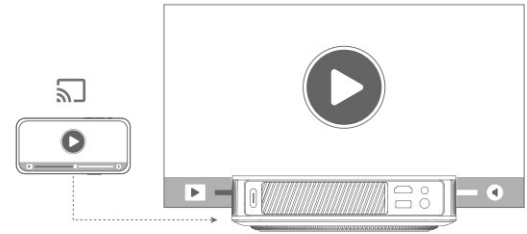

Inputs

- Go to [Inputs] -- HDMI/HOME/USB.
- Watch the content from the different signal sources.

*This product's HDMI interface is HDMI 1.4 and does not support 4K video signal input.

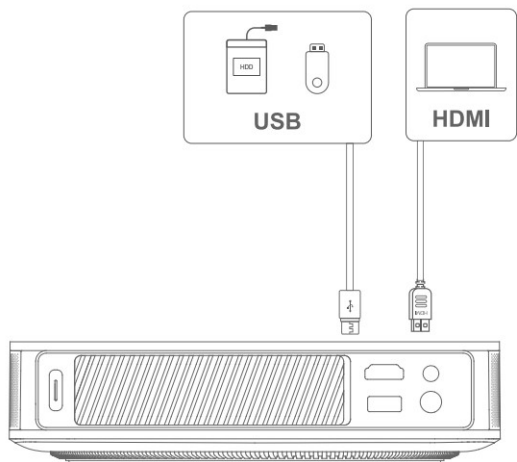

More Settings

1.Color Temperature

Go to [Settings] -- [Display&Sounds] -- [Picture] -- [Color Temperature] to select from [Standard/Warm/Eye-care].

2.Projection Mode

Go to [Settings] -- [Projector]-- [Advanced Settings] -- [Projection Mode] to choose the placement method of the projector.

3.Zoom

Go to [Settings] -- [Projector] -- [Image Correction] -- [Image Adaption] to decrease the image size from 100% to 50%.

4.3D Mode

Before enabling 3D mode, go to [Settings] -- [Projector] -- [Image Correction], and click [Reset to Default Image] to restore the image to its default state. Go to [Settings] -- [Picture] -- [3D Mode] to enable 3D mode.

*It is recommended to disable the [Auto Keystone Correction After Movement] feature when enabling 3D mode to avoid altering the image from its default state after moving the projector, which could prevent the use of 3D mode.

5.System & Product Info

Go to [Settings] -- [System] -- [About] to check the System & Product information.

Specifications

Display Technology	0.33 in, DLP	Bluetooth Version	5.1
Display Resolution	1920 x 1080	WI-FI	Dual Frequency 2.4/5.0 GHz
Throw Ratio	1.2:1	Dimensions (L x W x H)	195 × 195 × 47.5 mm 7.68 x 7.68 x 1.87 inches
Speakers	2 x 5 W	Weight	1.28kg /2.82lb

Troubleshooting

1.No audio output

- a. Check if you have double-clicked the black side key on the remote control to put the projector in mute mode.
- b. Check if the projector interface "HDMI ARC" or Bluetooth is connected to an external audio device.

2. No image output

- a. Press the power button located on the rear of the projector. The power button indicator light will turn off if the projector enters projection mode successfully.
- b. Ensure that the power adaptor has power output.

3. No network

- a. Enter settings, and check the network connection status in the network option.
- b. Ensure that the network cable is correctly inserted to the projector interface "LAN".
- c. Ensure that the router is correctly configured.

4. Blurry Image

- a. Adjust the focus or keystone.
- b. The projector and screen/wall must be positioned with an effective distance.
- c. Projector lens is not clean.

5. Non-rectangular Image

- a. Place the projector perpendicular to the screen/wall if keystone correction function is not used.
- b. Use the keystone correction function to adjust the display.

6. Automatic keystone correction failed

- a. Ensure that the Camera/TOF on the front panel is not blocked or dirty.
- b. The best automatic keystone correction distance is 2.0-4.0m, horizontal $\pm 30^\circ$.

7. Autofocus failure

- a. Ensure that the Camera/TOF on the front panel is not blocked or dirty.
- b. The best autofocus distance is 2.0-4.0m, horizontal $\pm 20^\circ$.

8. Smart Eye Protection failed

- a. Ensure that the Camera/TOF on the front panel is not blocked or dirty
- b. The optimal sensing range is located around the center of the image. Being too close to the edges may result in the eye protection feature not triggering.

9. Intelligent Screen Fit failure

- a. Ensure that the projector is correctly positioned, so that the projected image extends beyond the edges of the screen.
- b. Ensure that the projection screen has a colored border/frame on all four sides, so that the projector can recognize the frame.
- c. Ensure that the red box pattern is within the screen frame, and is not blocked.

10. The Remote Control is unresponsive

- a. Ensure that the remote control is successfully paired via Bluetooth. If the pairing is successful, the LED light will flash once when you press any button. When you press and hold any button, the LED light will remain solid.
- b. If the pairing is unsuccessful, the LED light will flash three times when you press any button. When you press and hold any button, the LED light will flash three times and then remain solid.
- c. Check if the power indicator is still on without pressing any buttons. If it is, check the status of the remote control buttons to ensure they are not being pressed.
- d. Ensure that there are no interferences or obstructions between the projector and remote control.
- e. Check the battery and installation polarity.

11. Connect the Bluetooth devices

Enter settings, open the Bluetooth option to check the Bluetooth device list, and connect the device.

12. Others

Please feel free to contact us at support@dangbei.com

Important Precautions

- Do not look directly at the projection beam with your eyes, because the strong beam may harm your eyes. RG2 IEC 60825-1:2014
- Do not block or cover the heat dissipation holes of the device to avoid affecting the heat dissipation of the internal parts, and damaging the device.
- Keep away from humidity, exposure, high temperature, low pressure, and magnetic environments.
- Do not place the device in areas susceptible to excessive dust and dirt.
- Place the device in a flat and stable station, and do not place the device on a surface that is prone to vibration.
- Do not allow children to handle the device without supervision.
- Do not place heavy or sharp objects on the device.
- Avoid extreme vibrations, because these may damage the internal components.
- Please use the correct type of battery for the remote control.
- Only use attachments/accessories specified or provided by the manufacturer (such as the exclusive power adapter, bracket, etc.).
- Do not disassemble the device. The device should only be repaired by staff authorized by the manufacturer.
- Place and use the device in a 5-35°C environment.
- The metal casing is coated with insulating paint.
- The plug is considered as a disconnected device of the adapter.
- The adapter should be installed near the equipment, and should be easily accessible.
- Protect the power cord from being walked on or pinched, particularly at the plugs, convenience receptacles, and the point where this exits from the device.
- Unplug this device if there are lightning storms or when unused for a long period of time.
- Where the power plug or an appliance coupler is used to disconnect the device, the disconnected device would remain readily operable.
- Never touch the power cable or power connector with wet hands.
- Risk of explosion if battery is replaced by an incorrect type. Dispose of used batteries according to local regulations.

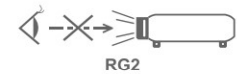

Statement

Google TV is the name of this device's software experience and a trademark of Google LLC.
Google, YouTube and Chromecast built-in are trademarks of Google LLC.

This equipment has been tested and found to comply with the limits for a Class B digital device, pursuant to Part 15 of the FCC Rules. These limits are designed to provide reasonable protection against harmful interference in a residential installation.

This equipment generates uses and can radiate radio frequency energy and, if not installed and used in accordance with the instructions, may cause harmful interference to radio communications. However, there is no guarantee that interference will not occur in a particular installation. If this equipment does cause harmful interference to radio or television reception, which can be determined by turning the equipment off and on, the user is encouraged to try to correct the interference by one or more of the following measures:

- Reorient or relocate the receiving antenna.
- Increase the separation between the equipment and receiver.
- Connect the equipment to an outlet on a circuit different from that to which the receiver is connected.
- Consult the dealer or an experienced radio/TV technician for help.

Changes or modifications not expressly approved by the party responsible for compliance could void the user's authority to operate the equipment.

We declare that this device is in compliance with the essential requirements and other relevant provisions of Directive 2014/53/EU. Satisfies all the technical regulations applicable to the product within the scope of UK Radio Equipment Regulations (SI 2017/1206); UK Electrical Equipment (Safety) Regulations (SI 2016/1101); and UK Electromagnetic Compatibility Regulations (SI 2016/1091). This device operating frequency: 2402-2480MHz (EIRP < 20dBm), 2412-2472MHz (EIRP < 20dBm), 5150~5250MHz (EIRP < 23dBm), 5250~5350MHz (EIRP < 20dBm), 5470~5725MHz (EIRP < 27dBm), 5725~5850MHz (EIRP < 13.98dBm).

 We declares that this device is in compliance with the essential requirements and other relevant provisions of Directive 2014/53/EU.

 Satisfies all the technical regulations applicable to the product within the scope of UK Radio Equipment Regulations (SI 2017/1206); UK Electrical Equipment (Safety) Regulations (SI 2016/1101); and UK Electromagnetic Compatibility Regulations (SI 2016/1091).



Manufactured under license from Dolby Laboratories. Dolby, Dolby Audio, and the double-D symbol are trademarks of Dolby Laboratories Licensing Corporation.

NETFLIX

Netflix is a trademark of Netflix, Inc.

THIS DEVICE COMPLIES WITH DHHS RULES 21 CFR CHAPTER I SUBCHAPTER J.

CAN ICES-3 (B)/NMB-3 (B)

This Class B digital apparatus complies with Canadian ICES-003.

Cet appareil numérique de classe B est conforme à la norme canadienne ICES-003.

This device contains licence-exempt transmitter(s)/receiver(s) that comply with Innovation, Science and Economic Development Canada's licence-exempt RSS(s). Operation is subject to the following two conditions:

(1) This device may not cause interference.

(2) This device must accept any interference, including interference that may cause, undesired operation of the device

L'émetteur/récepteur exempt de licence contenu dans le présent appareil est conforme aux CNR d'Innovation, Sciences et Développement économique Canada applicables aux appareils radio exempts de licence. L'exploitation est autorisée aux deux conditions suivantes :

1.L'appareil ne doit pas produire de brouillage;

2.L'appareil doit accepter tout brouillage radioélectrique subi, même si le brouillage est susceptible d'en compromettre le fonctionnement.

For projectors only

The distance between user and products should be no less than 20cm.

La distance entre l'utilisateur et le produit ne doit pas être inférieure à 20 cm.

5150-5350MHz band is restricted to indoor use only.

La bande de 5150-5350MHz est réservée à l'usage intérieur.



WARNING: This product can expose you to Lead, which is known to the State of California to cause cancer and birth defects or other reproductive harm. For more information go to www.P65Warnings.ca.gov