



STRANGULATION HAZARD – Children have STRANGLED in cords. Keep this cord out of reach of children (more than 3 feet/1 meter away from the crib). Never use extension cords with AC adapters. Only use the AC Adapters provided.



WARNING
Adult assembly required. Keep small parts away from children when assembling.

Warning Information
* Keep this instruction manual for future reference.
* For adult use only.

1 Setup and use your digital video baby monitor

A. Place Baby Unit on a flat surface, such as a desk.

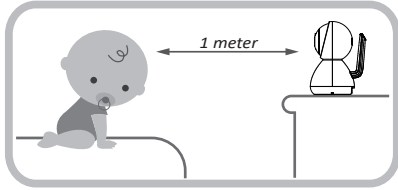

Never place the baby unit or the cord within 1 meter of the crib.

B. Connect the small plug of the power adapter to the Baby Unit and the other end to a suitable electrical outlet. Only use the enclosed adapter (5V DC 1000mA). The baby unit is turned on and the power LED will be green.

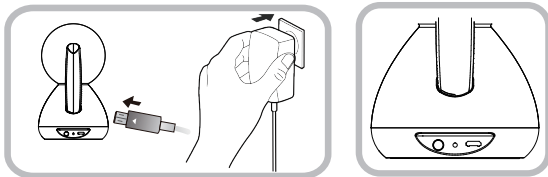

C. Connecting the power supply for the **Parent Unit**. Connect the small plug of the power adapter to the base bracket or the parent unit, and the other end to a electrical outlet. Only use the enclosed adapter(5V DC/2000mA). Recommend charging time of at least 3 hours before first use.

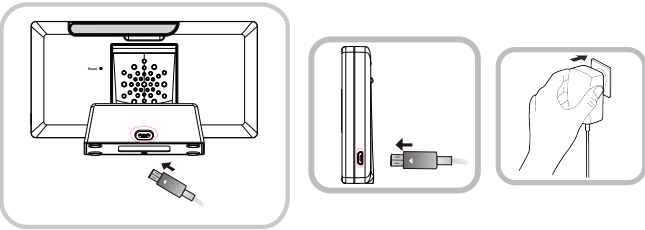

2 **Precaution: use of battery for Parent Unit**
Only charge the battery when the battery life indicator is low. Constant recharging of your battery before the low battery indicator light comes on will decrease the life of your batteries.

When battery is low, the power on/off LED (icon) will flash red and on screen display battery icon will flash red indicating that the battery needs to be charged.

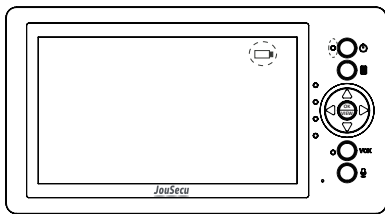

Notice:
If you use the parent unit for the first time, when you turn on the parent unit, some boot menus will pop-up on the screen, we try to explanation status and function on these menus, please according to the tips to switch to the monitor system interface. When you are familiar with this monitor, you could switch off these on screen tips in menu.

3 Function of keys and LED indicators

Parent Unit

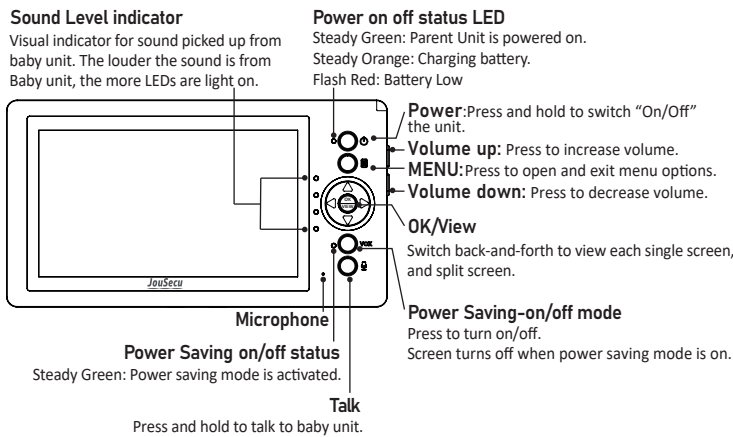

VOL- VOL+	Volume down/up	Press to decrease and increase volume.
	Talk	Press and hold to talk to baby unit.
VOX	Power Saving-on/off	Press to switch on/off Power Saving (voice activation mode).
OK VIEW	Select	Switch back-and-forth to view each single screen, and split screen.
▲ ▼	Up/Down Camera Up/Down	Menu mode (Press to adjust menu settings) Single screen mode (Press to control the current camera to rotate up/down)
◀ ▶	Left/Right Camera Left/Right	Menu mode (Press to adjust menu settings) Single screen mode (Press to control the current camera to rotate left/right)

Baby Unit

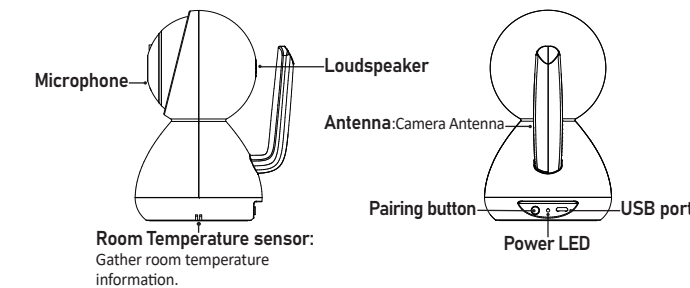

PAIR	Pairing button	When camera is powered on, press this button and the power LED starts to blink, the camera is in pairing mode. Press it again to exit pairing mode.
-------------	----------------	---

4 Start to use monitor

Status bar

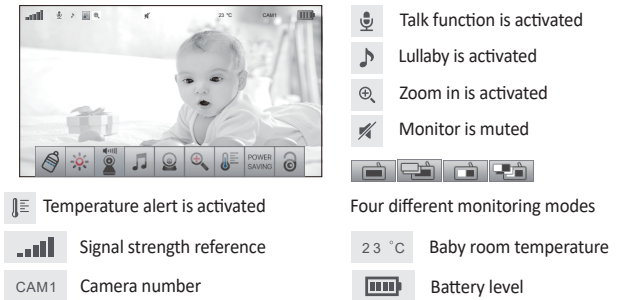

Menu operation

- Feeding time reminder is activated.
- Adjust Parent Unit LCD Brightness lighter or darker.
- Adjust camera volume : Sound level from 1 to 5.
- Activate or deactivate lullaby function, 5 lullabies can be chosen. When turn on lullaby, on Baby Unit side will always hear the ringtone from Parent Unit.
 - Repeat**: Repeat all lullabies.
 - OFF**: Deactivate lullaby function.
- ADD**: Add additional camera. Two cameras can be added.
 - Step 1: Move the parent unit to the same area as the camera. Both parent and baby unit are switched on.
 - Step 2: Select ADD in Menu. The next available camera will automatically be highlighted. Press "Select" to begin pairing.
 - Step 3: Within 10 seconds, press "Pairing button" of camera.
 - Step 4: Once successfully paired, the camera light will stop flashing and video will appear on the monitor screen within 20 seconds.
- Delete**: Delete paired camera from the list.
- Single Screen**: Show the selected single camera.
- Single Screen**: Alternate to show each single camera.
- Split Screen**: Select automatically to receive audio from louder camera.
- Split Screen**: Alternate to receive audio every 10s between both cameras.
 - Tips**: When two cameras are paired to the monitor, you can choose Single Screen alternating or Split Screen function .
- Zoom**
 - Out**
 - In**
- HIGH**: Beep Alarm is issued when room temperature is higher than this setting.
- LOW**: Beep Alarm is issued when room temperature is lower than this setting.
- C**: Display temperature in Celsius scale.
- F**: Display temperature in Fahrenheit scale.
- Temperature calibration**: Calibrate room temperature display to your standardized one.
- ON**: Activate room temperature alarm function.
- OFF**: Deactivate room temperature alarm function.
- Two different power saving modes**
To select ECO or SCREEN OFF mode
 - ECO**: Activation sound level selection and leave audio off in power saving mode.
 - Quiet**: Baby cry a little bit to activate the Parent Unit.
 - Medium**: Baby cry moderate to activate the Parent Unit.
 - Loud**: Baby cry louder to activate the Parent Unit.
 - SCREEN OFF**: Turn off screen and leave audio on: Keep audio continuously on when screen is off in power saving mode.
 - Email** : Sales@jousecu.com
 - Sound Bar**: This sound bar is designed for deaf parents to reflect sound level picked up from camera. You can turn visual sound level indication on or off.
 - Explanation On/Off**: We try to explanation status and function on the boot menu. You can turn the explanation on or off based on your usage.

WARNING THIS PRODUCT CANNOT REPLACE RESPONSIBLE ADULT SUPERVISION

- When an AC Adapter is plugged into an electrical outlet, do not touch the exposed end.
- Test baby monitor before first use, periodically, and when changing location of the baby unit(Camera).
- Do not use monitor near water (Such as bathtub, Sink, etc)
- Keep parent unit away from heat sources (Such as stoves, radiators, etc)
- Make sure there is proper ventilation around baby unit and parent unit.
- This product is not a toy. Do not allow children to play with it.
- The mains plug or an appliance coupler is used as the disconnect device, the disconnect device shall remain readily operable.
- The baby monitor should not be considered as a medical device. While using the baby monitor, it is strongly recommended to have an adult directly checking on your baby. Premature babies or children considered at risk must be supervised by your pediatrician or other medical staff.

Battery Warning

- Use only the original rechargeable battery provided.
- Do not short-circuit supply terminals.
- Remove battery when product is stored for long periods of time or when battery is exhausted.
- Dispose of exhausted battery properly.
- Keep all batteries away from children.
- The apparatus shall not be exposed to dripping or splashing and that no objects filled with liquids, such as vases, shall be placed on the apparatus.
- Danger of explosion if battery is incorrectly replaced. Replace only with the same or equivalent type.
- Batteries (battery pack or batteries installed) shall not be exposed to excessive heat such as sunshine, fire or the like.

Precautions

- Do not overload wall outlets, extension cords, or integral convenience receptacles as this can result in a risk of fire or electric shock.
- The baby monitor works better in temperature ranging between 0°C and 40°C (32°F and 104°F)
- Do not dismantle the appliance. It does not contain any parts that may be used independently.
- Never Expose the baby monitor for long period to sun's direct rays and never place it next to a source of heat, in a damp or very dusty room.
- Never push objects of any kind into this product through openings as they may touch dangerous voltage points or short-out parts that could result in a fire or electric shock. Never spill liquid of any kind on the product.
- Do not attempt to service this product yourself as opening or removing covers may expose you to dangerous voltage or other hazards. Refer all servicing to qualified service personnel.
- The product should be mounted to a wall or ceiling inly as recommended by the manufacturer.

Industry Canada Statement

This device complies with Industry Canada licence-exempt RSS standard. Operation is subject to the following two conditions: (1) this device may not cause interference, and (2) this device must accept any interference, including interference that may cause undesired operation of the device.

Le présent appareil est conforme aux CNR d'Industrie Canada applicables aux appareils radio exempts de licence. L'exploitation est autorisée aux deux conditions suivantes : (1) l'appareil ne doit pas produire de brouillage, et (2) l'utilisateur de l'appareil doit accepter tout brouillage radioélectrique subi, même si le brouillage est susceptible d'en compromettre le fonctionnement.

IC Radiation Exposure Statement:

This equipment complies with IC RSS-102 radiation exposure limit set forth for an uncontrolled environment. This equipment should be installed and operated with minimum distance 20cm between the radiator and your body.

Cet équipement est conforme aux CNR-102 d'Industrie Canada. Cet équipement doit être installé et utilisé avec une distance minimale de 20 centimètres entre le radiateur et votre corps. Cet équipement ne doit pas être co-localisé ou opérer en conjonction avec autre antenne ou émetteur. Les antennes utilisées pour cet émetteur doivent être installées et fournir une distance de séparation d'au moins 20 centimètres de toute personne et doit pas être co-située ni fonctionner en conjonction avec une autre antenne ou émetteur.

This device complies with Part 15 of the FCC Rules. Operation is subject to the following two conditions:

(1) This device may not cause harmful interference, and (2) This device must accept any interference received, including interference that may cause undesired operation.

FCC Caution

To assure continued compliance, any changes or modifications not expressly approved by the party responsible for compliance could void the user's authority to operate this equipment. (Example - use only shielded interface cables when connecting to computer or peripheral devices).

FCC Radiation Exposure Statement

This equipment complies with FCC RF radiation exposure limits set forth for an uncontrolled environment. This equipment should be installed and operated with a minimum distance of 20 centimeters between the radiator and your body.

This transmitter must not be co-located or operating in conjunction with any other antenna or transmitter.

The antennas used for this transmitter must be installed to provide a separation distance of at least 20 cm from all persons and must not be co-located or operating in conjunction with any other antenna or transmitter.

Federal Communication Commission Interference Statement

This equipment has been tested and found to comply with the limits for a Class B digital device, pursuant to Part 15 of the FCC Rules. These limits are designed to provide reasonable protection against harmful interference in a residential installation.

This equipment generates, uses and can radiate radio frequency energy and, if not installed and used in accordance with the instructions, may cause harmful interference to radio communications. However, there is no guarantee that interference will not occur in a particular installation. If this equipment does cause harmful interference to radio or television reception, which can be determined by turning the equipment off and on, the user is encouraged to try to correct the interference by one of the following measures:

- Reorient or relocate the receiving antenna.
- Increase the separation between the equipment and receiver.
- Connect the equipment into an outlet on a circuit different from that to which the receiver is connected.
- Consult the dealer or an experienced radio/TV technician for help.

JouSecu's baby monitor warranty policy

JouSecu will repair or replace (at our option) your unit free of charge for 12 months from the date of purchase if the unit is defective in workmanship or materials. To claim your repair/replacement, the product must be returned to JouSecu together with a copy of the purchase receipt. In the absence of the purchase receipt, the warranty will be 12 months from the date of manufacture. This warranty does not apply to normal wear or damage from misuse, abuse, improper storage and handling, installation, accident, unauthorized repair or alteration. Please contact our Customer service by Facebook JouSecu or via email for details.