



Shenzhen Global Test Service Co.,Ltd.

No.7-101 and 8A-104, Building 7 and 8, DCC Cultural and Creative Garden, No.98, Pingxin North Road, Shangmugu Community, Pinghu Street, Longgang District, Shenzhen, Guangdong

TEST REPORT

FCC PART 15 SUBPART C 15.249

Report Reference No.....: **GTS20200828019-1-2**

FCC ID.....: **2AUZX-WWDZWU**

Compiled by
(position+printed name+signature)...: File administrators Jimmy Wang

Supervised by
(position+printed name+signature)...: Test Engineer Aaron Tan

Approved by
(position+printed name+signature)...: Manager Jason Hu

Date of issue.....: Aug. 28, 2020

Representative Laboratory Name.: Shenzhen Global Test Service Co., Ltd.

Address.....: No.7-101 and 8A-104, Building 7 and 8, DCC Cultural and Creative Garden, No.98, Pingxin North Road, Shangmugu Community, Pinghu Street, Longgang District, Shenzhen, Guangdong

Applicant's name.....: **Ubitech Limited**

Address: Unit 12, 7/F Block A, Hi-Tech Industrial Centre, 5-21 Pak Tin Par Street, Tsuen Wan, NT, Hong Kong

Test specification

Standard.....: **47 CFR FCC Part 15 Subpart C 15.249**

TRF Originator.....: Shenzhen Global Test Service Co.,Ltd.

Master TRF.....: Dated 2014-12

Shenzhen Global Test Service Co.,Ltd. All rights reserved.

This publication may be reproduced in whole or in part for non-commercial purposes as long as the Shenzhen Global Test Service Co.,Ltd. is acknowledged as copyright owner and source of the material. Shenzhen Global Test Service Co.,Ltd. takes no responsibility for and will not assume liability for damages resulting from the reader's interpretation of the reproduced material due to its placement and context.

Test item description

Trade Mark.....: N/A

Manufacturer.....: Yong Chao Plastic Technology Co.,Ltd

Model/Type reference.....: WWDZWU

List Model.....: N/A

Ratings.....: 3.3V---3uA

Result.....: **PASS**

TEST REPORT

Test Report No. :	GTS20200828019-1-2	Aug. 28, 2020
		Date of issue

Equipment under Test : Wireless Water Detector

Model /Type : WWDZWU

Listed Models : N/A

Applicant : **Ubitech Limited**

Address : Unit 12, 7/F Block A, Hi-Tech Industrial Centre, 5-21 Pak Tin Par Street, Tsuen Wan, NT, Hong Kong

Manufacturer : **Yong Chao Plastic Technology Co.,Ltd**

Address : No.21, Jinlang 1 Street, Diaolang village, Huangjiang Town, Dongguan City, Guangdong, China

Test Result:	PASS
---------------------	-------------

The test report merely corresponds to the test sample.
 It is not permitted to copy extracts of these test result without the written permission of the test laboratory.

Contents

<u>1</u>	<u>TEST STANDARDS</u>	<u>4</u>
<u>2</u>	<u>SUMMARY</u>	<u>5</u>
2.1	General Remarks	5
2.2	Product Description	5
2.3	Equipment Under Test	5
2.4	Short description of the Equipment under Test (EUT)	5
2.5	EUT operation mode	6
2.6	Block Diagram of Test Setup	6
2.7	Special Accessories	6
2.8	Related Submittal(s) / Grant (s)	6
2.9	Modifications	6
<u>3</u>	<u>TEST ENVIRONMENT</u>	<u>7</u>
3.1	Address of the test laboratory	7
3.2	Test Facility	7
3.3	Environmental conditions	7
3.4	Summary of measurement results	8
3.5	Statement of the measurement uncertainty	8
3.6	Equipments Used during the Test	8
<u>4</u>	<u>TEST CONDITIONS AND RESULTS.....</u>	<u>10</u>
4.1	Conducted Emissions Test	10
4.2	Radiated Emissions and Band Edge	11
4.3	Occupied Bandwidth Measurement	17
4.4	Antenna Requirement	19
<u>5</u>	<u>TEST SETUP PHOTOS OF THE EUT</u>	<u>20</u>
<u>6</u>	<u>PHOTOS OF THE EUT</u>	<u>21</u>

1 TEST STANDARDS

The tests were performed according to following standards:

[FCC Rules Part 15.249](#): Operation within the bands 902 - 928 MHz, 2400 - 2483.5 MHz, 5725 - 5875 MHz, and 24.0 - 24.25 GHz.

[ANSI C63.10: 2013](#): American National Standard for Testing Unlicensed Wireless Devices

2 SUMMARY

2.1 General Remarks

Date of receipt of test sample	:	Aug. 13, 2020
Testing commenced on	:	Aug. 14, 2020
Testing concluded on	:	Aug. 25, 2020

2.2 Product Description

Product Name:	Wireless Water Detector
Model/Type reference:	WWDZWU
Power supply:	ER14250- Battery 3.6V 1200mAh
Hardware Version:	Rev1.4
Software Version:	V1.12
Test samples ID:	GTS20200828019-1-2#
Z-wave	
Modulation:	FSK/GFSK
Operation frequency:	908.42MHz, 916MHz
Channel number:	2
Antenna type:	Monopole antenna
Antenna gain:	1.0dBi

2.3 Equipment Under Test

Power supply system utilised

Power supply voltage	:	<input type="radio"/> 230V / 50 Hz	<input type="radio"/> 120V / 60Hz
		<input type="radio"/> 12 V DC	<input type="radio"/> 24 V DC
		<input checked="" type="radio"/> Other (specified in blank below)	

DC 3.6V from battery

2.4 Short description of the Equipment under Test (EUT)

This is a Wireless Water Detector.

For more details, refer to the user's manual of the EUT.

2.5 EUT operation mode

The Applicant provides communication tools software (CustosGeneralTool.UI) to control the EUT for staying in continuous transmitting (Duty Cycle more than 98%) and receiving mode for testing .There are 2 channels provided to the EUT.

Operation Frequency:

Channel	Frequency (MHz)
00	908.42
01	916.00

2.6 Block Diagram of Test Setup

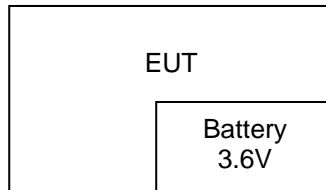

2.7 Special Accessories

Follow auxiliary equipment(s) test with EUT that provided by the manufacturer or laboratory is listed as follow:

Description	Manufacturer	Model	Technical Parameters	Certificate	Provided by
/	/	/	/	/	/
/	/	/	/	/	/
/	/	/	/	/	/
/	/	/	/	/	/

2.8 Related Submittal(s) / Grant (s)

This submittal(s) (test report) is intended for the device filing to comply with Section 15.249 of the FCC Part 15, Subpart C Rules.

2.9 Modifications

No modifications were implemented to meet testing criteria.

3 TEST ENVIRONMENT

3.1 Address of the test laboratory

Shenzhen Global Test Service Co.,Ltd.

No.7-101 and 8A-104, Building 7 and 8, DCC Cultural and Creative Garden, No.98, Pingxin North Road, Shangmugu Community, Pinghu Street, Longgang District, Shenzhen, Guangdong

The 3m-Semi anechoic test site fulfils CISPR 16-1-4 according to ANSI C63.4:2014 and CISPR 16-1-4:2010 SVSWR requirement for radiated emission above 1GHz.

3.2 Test Facility

The test facility is recognized, certified, or accredited by the following organizations:

FCC-Registration No.: 165725

Shenzhen Global Test Service Co.,Ltd EMC Laboratory has been registered and fully described in a report filed with the (FCC) Federal Communications Commission. The acceptance letter from the FCC is maintained in our files.

A2LA-Lab Cert. No.: 4758.01

Shenzhen Global Test Service Co.,Ltd. EMC Laboratory has been accredited by A2LA for technical competence in the field of electrical testing, and proved to be in compliance with ISO/IEC 17025: 2005 General Requirements for the Competence of Testing and Calibration Laboratories and any additional program requirements in the identified field of testing.

CNAS-Lab Code: L8169

Shenzhen Global Test Service Co.,Ltd. has been assessed and proved to be in compliance with CNAS-CL01 Accreditation Criteria for Testing and Calibration Laboratories (identical to ISO/IEC 17025: 2005 General Requirements) for the Competence of Testing and Calibration Laboratories. Date of Registration: Dec. 11, 2015. Valid time is until Dec. 10, 2024.

3.3 Environmental conditions

During the measurement the environmental conditions were within the listed ranges:

Temperature:	15-35 ° C
Humidity:	30-60 %
Atmospheric pressure:	950-1050mbar

3.4 Summary of measurement results

FCC PART 15.249		
FCC Part 15.249(a)	Field Strength of Fundamental	PASS
FCC Part 15.209	Spurious Emission	PASS
FCC Part 15.209	Band edge	PASS
FCC Part 15.215(c)	20dB bandwidth	PASS
FCC Part 15.207	Conducted Emission	N/A
FCC Part 15.203	Antenna Requirement	PASS

Remark:

1. The measurement uncertainty is not included in the test result.
2. NA = Not Applicable; NP = Not Performed

3.5 Statement of the measurement uncertainty

The data and results referenced in this document are true and accurate. The reader is cautioned that there may be errors within the calibration limits of the equipment and facilities. The measurement uncertainty was calculated for all measurements listed in this test report acc. to CISPR 16 - 4 „Specification for radio disturbance and immunity measuring apparatus and methods – Part 4: Uncertainty in EMC Measurements“ and is documented in the Shenzhen Global Test Service Co.,Ltd quality system acc. to DIN EN ISO/IEC 17025. Furthermore, component and process variability of devices similar to that tested may result in additional deviation. The manufacturer has the sole responsibility of continued compliance of the device.

Hereafter the best measurement capability for Shenzhen GTS laboratory is reported:

Test	Range	Measurement Uncertainty	Notes
Radiated Emission	30~1000MHz	4.10 dB	(1)
Radiated Emission	1~18GHz	4.32 dB	(1)
Radiated Emission	18-40GHz	5.54 dB	(1)
Conducted Disturbance	0.15~30MHz	3.12 dB	(1)

- (1) This uncertainty represents an expanded uncertainty expressed at approximately the 95% confidence level using a coverage factor of k=2.

3.6 Equipments Used during the Test

Test Equipment	Manufacturer	Model No.	Serial No.	Calibration Date	Calibration Due Date
LISN	R&S	ENV216	3560.6550.08	2019/09/20	2020/09/19
LISN	R&S	ESH2-Z5	893606/008	2019/09/20	2020/09/19
EMI Test Receiver	R&S	ESPI3	101841-cd	2019/09/20	2020/09/19
EMI Test Receiver	R&S	ESCI7	101102	2019/09/20	2020/09/19
Spectrum Analyzer	Agilent	N9020A	MY48010425	2019/09/20	2020/09/19
Spectrum Analyzer	Agilent	E4407B	MY45132751	2019/09/20	2020/09/19
Spectrum Analyzer	R&S	FSV40	100019	2019/09/20	2020/09/19
Vector Signal generator	Agilent	N5181A	MY49060502	2019/09/20	2020/09/19
Signal generator	Agilent	E4421B	3610AO1069	2019/09/20	2020/09/19
Climate Chamber	ESPEC	EL-10KA	A20120523	2019/09/20	2020/09/19
Controller	EM Electronics	Controller EM 1000	N/A	N/A	N/A
Horn Antenna	Schwarzbeck	BBHA 9120D	01622	2019/09/23	2020/09/22
Active Loop Antenna	Beijing Da Ze Technology Co.,Ltd.	ZN30900C	15006	2019/10/12	2020/10/11
Bilog Antenna	Schwarzbeck	VULB9163	000976	2020/05/25	2021/05/24

Broadband Horn Antenna	SCHWARZBECK	BBHA 9170	791	2019/09/20	2020/09/19
Amplifier	Schwarzbeck	BBV 9743	#202	2019/09/20	2020/09/19
Amplifier	Schwarzbeck	BBV9179	9719-025	2019/09/20	2020/09/19
Amplifier	EMCI	EMC051845B	980355	2019/09/20	2020/09/19
Temperature/Humidity Meter	Gangxing	CTH-608	02	2019/09/20	2020/09/19
High-Pass Filter	K&L	9SH10-2700/X12750-O/O	KL142031	2019/09/20	2020/09/19
High-Pass Filter	K&L	41H10-1375/U12750-O/O	KL142032	2019/09/20	2020/09/19
RF Cable(below 1GHz)	HUBER+SUHNER	RG214	RE01	2019/09/20	2020/09/19
RF Cable(above 1GHz)	HUBER+SUHNER	RG214	RE02	2019/09/20	2020/09/19
Data acquisition card	Agilent	U2531A	TW53323507	2019/09/20	2020/09/19
Power Sensor	Agilent	U2021XA	MY5365004	2019/09/20	2020/09/19
Test Control Unit	Tonscend	JS0806-1	178060067	2020/06/19	2021/06/18
Automated filter bank	Tonscend	JS0806-F	19F8060177	2020/06/19	2021/06/18
EMI Test Software	Tonscend	JS1120-1	Ver 2.6.8.0518	/	/
EMI Test Software	Tonscend	JS1120-3	Ver 2.5.77.0418	/	/
EMI Test Software	Tonscend	JS32-CE	Ver 2.5	/	/
EMI Test Software	Tonscend	JS32-RE	Ver 2.5.1.8	/	/

Note: The Cal.Interval was one year.

4 TEST CONDITIONS AND RESULTS

4.1 Conducted Emissions Test

LIMIT

According to FCC CFR Title 47 Part 15 Subpart C Section 15.207, AC Power Line Conducted Emissions Limits for Licence-Exempt Radio Apparatus as below:

Frequency range (MHz)	Limit (dBuV)	
	Quasi-peak	Average
0.15-0.5	66 to 56*	56 to 46*
0.5-5	56	46
5-30	60	50

* Decreases with the logarithm of the frequency.

TEST CONFIGURATION

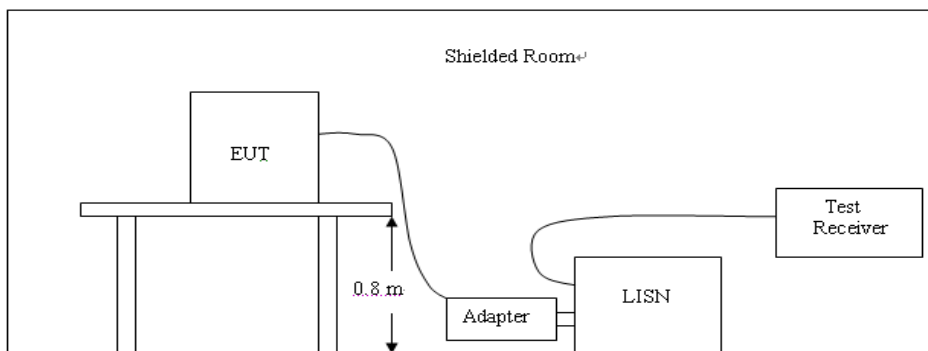

TEST PROCEDURE

1. The equipment was set up as per the test configuration to simulate typical actual usage per the user's manual. The EUT is a tabletop system; a wooden table with a height of 0.8 meters is used and is placed on the ground plane as per ANSI C63.10:2013.
2. Support equipment, if needed, was placed as per ANSI C63.10:2013.
3. All I/O cables were positioned to simulate typical actual usage as per ANSI C63.10:2013.
4. If a EUT received DC power from the USB Port of Notebook PC, the PC's adapter received AC120V/60Hz power through a Line Impedance Stabilization Network (LISN) which supplied power source and was grounded to the ground plane.
5. All support equipments received AC power from a second LISN, if any.
6. The EUT test program was started. Emissions were measured on each current carrying line of the EUT using a spectrum Analyzer / Receiver connected to the LISN powering the EUT. The LISN has two monitoring points: Line 1 (Hot Side) and Line 2 (Neutral Side). Two scans were taken: one with Line 1 connected to Analyzer / Receiver and Line 2 connected to a 50 ohm load; the second scan had Line 1 connected to a 50 ohm load and Line 2 connected to the Analyzer / Receiver.
7. Analyzer / Receiver scanned from 150 KHz to 30MHz for emissions in each of the test modes.
8. During the above scans, the emissions were maximized by cable manipulation.

TEST RESULTS

Not applicable to this device, which is powered by battery.

4.2 Radiated Emissions and Band Edge

Limit

According 15.249, the field strength of emissions from intentional radiators operated within 902MHz-928 MHz shall not exceed 94dB μ V/m (50mV/m):

FCC PART 15.249(d) Emissions radiated outside of the specified frequency bands, except for harmonics, shall be attenuated by at least 50 dB below the level of the fundamental or to the general radiated emission limits list as below, whichever is the lesser attenuation.

In addition, radiated emissions which fall in the restricted bands, must also comply with the radiated emission limits specified list as below.

Radiated emission limits

Frequency (MHz)	Distance (Meters)	Radiated (dB μ V/m)	Radiated (μ V/m)
0.009-0.49	3	$20\log(2400/F(\text{KHz}))+40\log(300/3)$	$2400/F(\text{KHz})$
0.49-1.705	3	$20\log(24000/F(\text{KHz}))+ 40\log(30/3)$	$24000/F(\text{KHz})$
1.705-30	3	$20\log(30)+ 40\log(30/3)$	30
30-88	3	40.0	100
88-216	3	43.5	150
216-960	3	46.0	200
Above 960	3	54.0	500

TEST CONFIGURATION

(A) Radiated Emission Test Set-Up, Frequency Below 30MHz

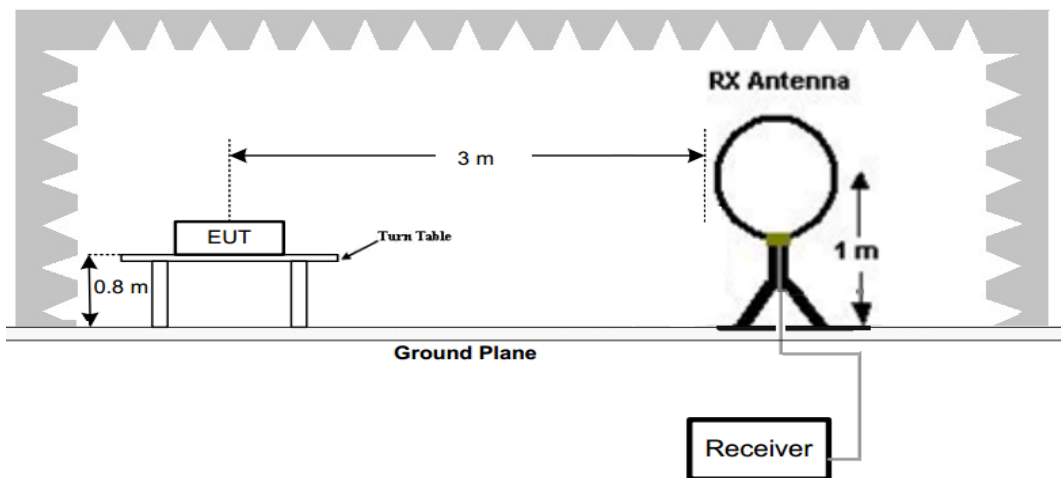

(B) Radiated Emission Test Set-Up, Frequency below 1000MHz

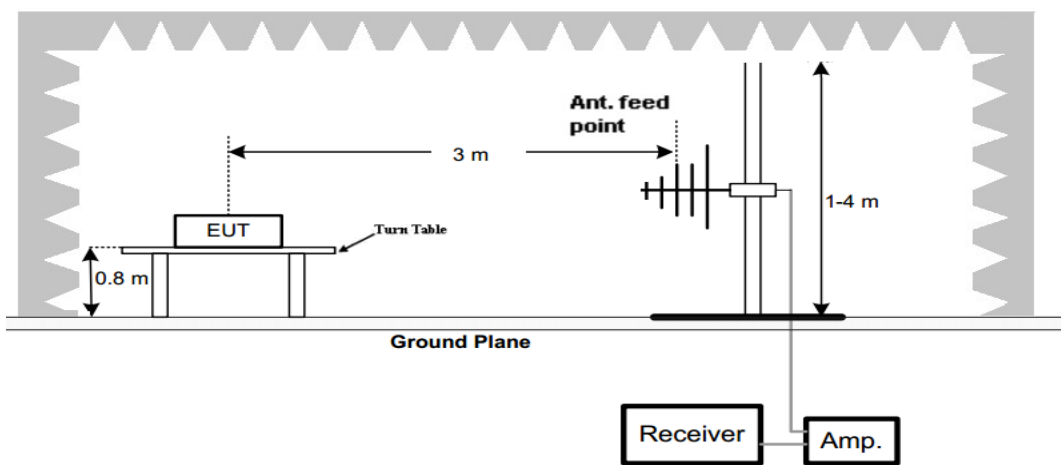

(C) Radiated Emission Test Set-Up, Frequency above 1000MHz

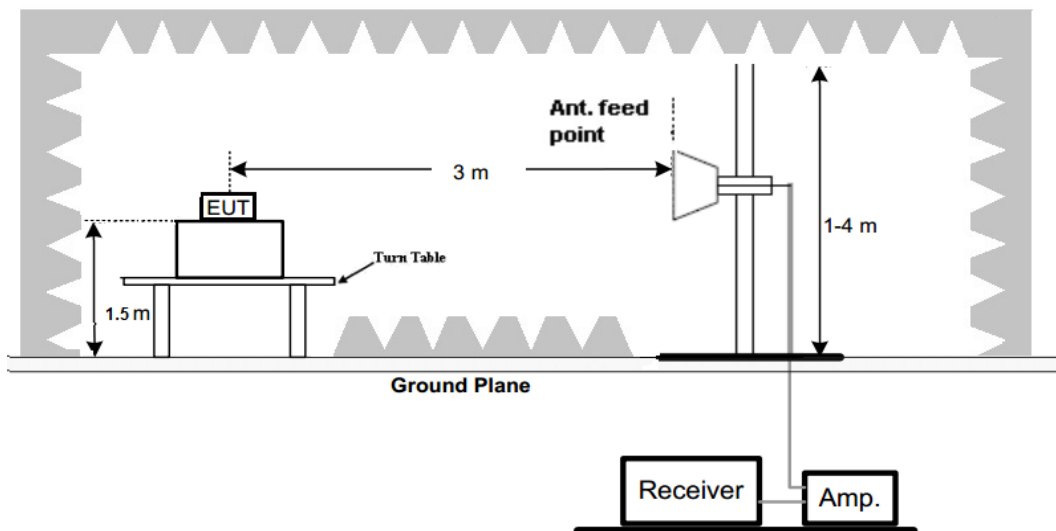

Test Procedure

1. Below 1GHz measurement the EUT is placed on a turntable which is 0.8m above ground plane, and above 1GHz measurement EUT was placed on a low permittivity and low loss tangent turn table which is 1.5m above ground plane.
2. Maximum procedure was performed by raising the receiving antenna from 1m to 4m and rotating the turn table from 0° to 360° to acquire the highest emissions from EUT
3. And also, each emission was to be maximized by changing the polarization of receiving antenna both horizontal and vertical.
4. Repeat above procedures until all frequency measurements have been completed.
5. Radiated emission test frequency band from 9KHz to 10GHz.
6. The distance between test antenna and EUT as following table states:

Test Frequency range	Test Antenna Type	Test Distance
9KHz-30MHz	Active Loop Antenna	3
30MHz-1GHz	Bilog Antenna	3
1GHz-10GHz	Horn Antenna	3

7. Setting test receiver/spectrum as following table states:

Test Frequency range	Test Receiver/Spectrum Setting	Detector
9KHz-150KHz	RBW=200Hz/VBW=3KHz, Sweep time=Auto	QP
150KHz-30MHz	RBW=9KHz/VBW=100KHz, Sweep time=Auto	QP
30MHz-1GHz	RBW=120KHz/VBW=1000KHz, Sweep time=Auto	QP
1GHz-10GHz	Peak Value: RBW=1MHz/VBW=3MHz, Sweep time=Auto Average Value: RBW=1MHz/VBW=10Hz, Sweep time=Auto	Peak

TEST RESULTS

Temperature	22.8°C	Humidity	56%
Test Engineer	Moon Tan	Configurations	Z-wave

Remark:

1. Radiated emission test from 9 KHz to 10th harmonic of fundamental was verified, and no emission found except system noise floor in 9 KHz to 30MHz and not recorded in this report.

For 30MHz-1GHz

Test Frequency:	908.42MHz	Polarization:	Horizontal
-----------------	-----------	---------------	------------

Test Graph

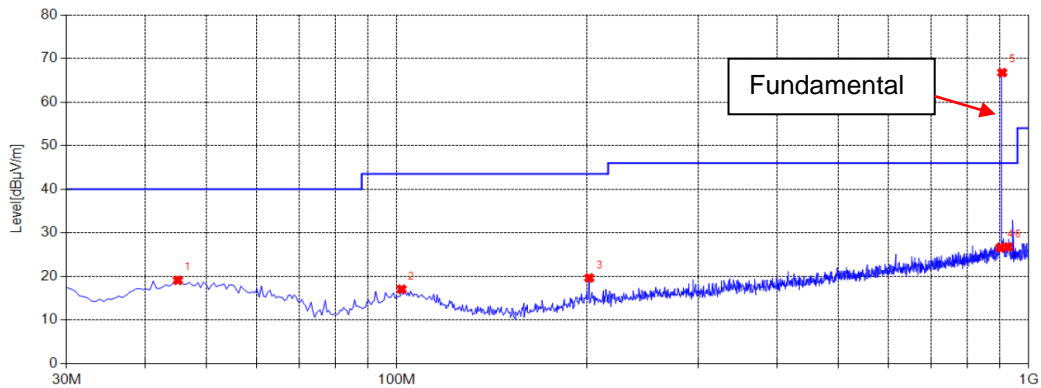

Suspected List

NO.	Frequency [MHz]	Reading (dBµV/m)	Factor [dB]	Result [dB µV/m]	Limit [dB µV/m]	Margin [dB]	Height [cm]	Angle [°]	Detector	Polarity	Remark
1	45.0350	25.63	-6.51	19.12	40.00	20.88	100	350	PK	Horizontal	Pass
2	101.7800	25.46	-8.38	17.08	43.50	26.42	100	300	PK	Horizontal	Pass
3	201.6900	28.89	-9.24	19.65	43.50	23.85	100	70	PK	Horizontal	Pass
4	902.0000	22.93	3.67	26.60	46.00	19.40	100	290	PK	Horizontal	Pass
5	908.4200	63.21	3.54	66.75	114.00	47.25	100	260	PK	Horizontal	Pass
5	908.4200	61.91	3.54	65.45	94.00	28.55	100	260	QP	Horizontal	Pass
5	908.4200	61.70	3.54	65.24	94.00	28.76	100	260	AV	Horizontal	Pass
6	928.0000	22.32	4.45	26.77	46.00	19.23	100	260	PK	Horizontal	Pass

Test Frequency:	908.42MHz	Polarization:	Vertical
-----------------	-----------	---------------	----------

Test Graph

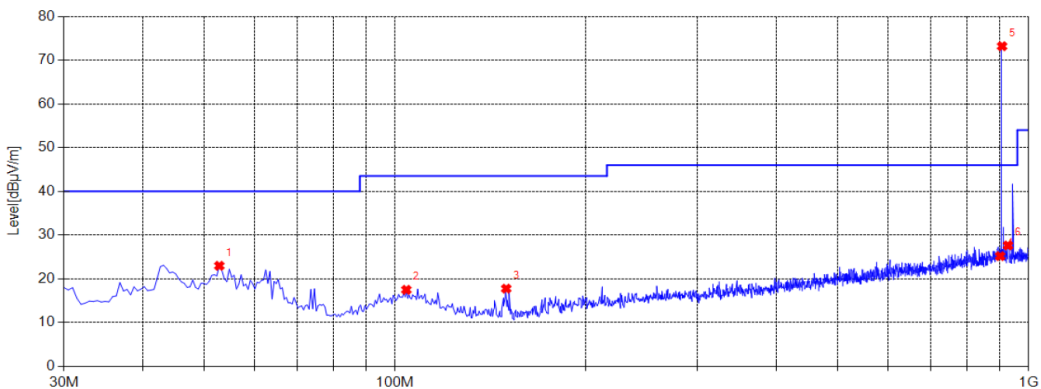

Suspected List

NO.	Frequency [MHz]	Reading (dBµV/m)	Factor [dB]	Result [dB µV/m]	Limit [dB µV/m]	Margin [dB]	Height [cm]	Angle [°]	Detector	Polarity	Remark
1	52.7950	29.82	-6.83	22.99	40.00	17.01	100	250	PK	Vertical	Pass
2	104.2050	25.72	-8.22	17.50	43.50	26.00	100	170	PK	Vertical	Pass
3	149.7950	30.63	-12.86	17.77	43.50	25.73	100	70	PK	Vertical	Pass
4	902.0000	21.53	3.67	25.20	46.00	20.80	100	30	PK	Vertical	Pass
5	908.4200	69.65	3.54	73.19	114.00	40.81	100	330	PK	Vertical	Pass
5	908.4200	67.88	3.54	71.42	94.00	22.58	100	330	QP	Vertical	Pass
5	908.4200	67.51	3.54	71.05	94.00	22.95	100	330	AV	Vertical	Pass
6	928.2200	23.19	4.45	27.64	46.00	18.36	100	220	PK	Vertical	Pass

Note: Result (dBµV/m) = Reading (dBµV/m) + Factor (dB) .
 Factor (dB) = Antenna Factor (dB/m) + Cable loss (dB) - Pre Amplifier gain (dB).
 Margin = Limit (dBµV/m) - Result (dBµV/m)

Test Frequency:	916.00MHz	Polarization:	Horizontal
-----------------	-----------	---------------	------------

Test Graph

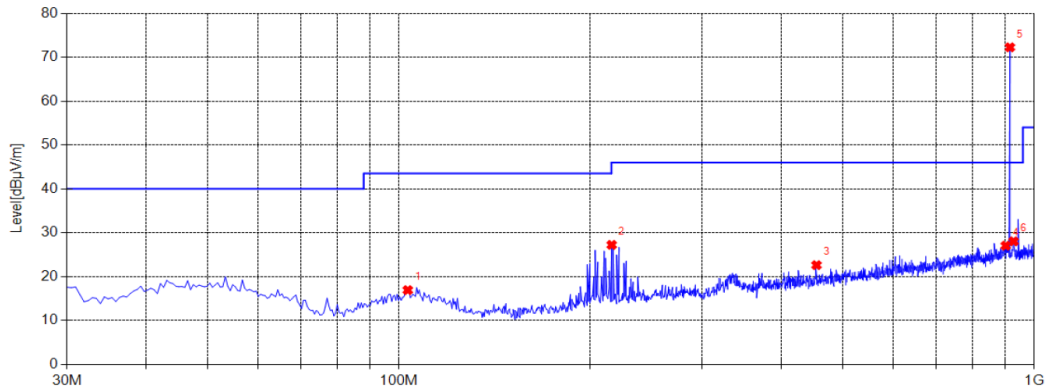

Suspected List

NO.	Frequency [MHz]	Reading (dBµV/m)	Factor [dB]	Result [dB µV/m]	Limit [dB µV/m]	Margin [dB]	Height [cm]	Angle [°]	Detector	Polarity	Remark
1	103.2350	25.25	-8.31	16.94	43.50	26.56	100	220	PK	Horizontal	Pass
2	216.2400	36.68	-9.44	27.24	46.00	18.76	100	30	PK	Horizontal	Pass
3	454.3750	27.08	-4.45	22.63	46.00	23.37	100	310	PK	Horizontal	Pass
4	902.0000	23.39	3.67	27.06	46.00	18.94	100	140	PK	Horizontal	Pass
5	916.0000	69.18	3.08	72.26	114.00	41.74	100	320	PK	Horizontal	Pass
5	916.0000	68.67	3.08	71.75	94.00	22.25	100	320	QP	Horizontal	Pass
5	916.0000	67.96	3.08	71.04	94.00	22.96	100	320	AV	Horizontal	Pass
6	928.0000	23.61	4.45	28.06	46.00	17.94	100	80	PK	Horizontal	Pass

Test Frequency:	916.00MHz	Polarization:	Vertical
-----------------	-----------	---------------	----------

Test Graph

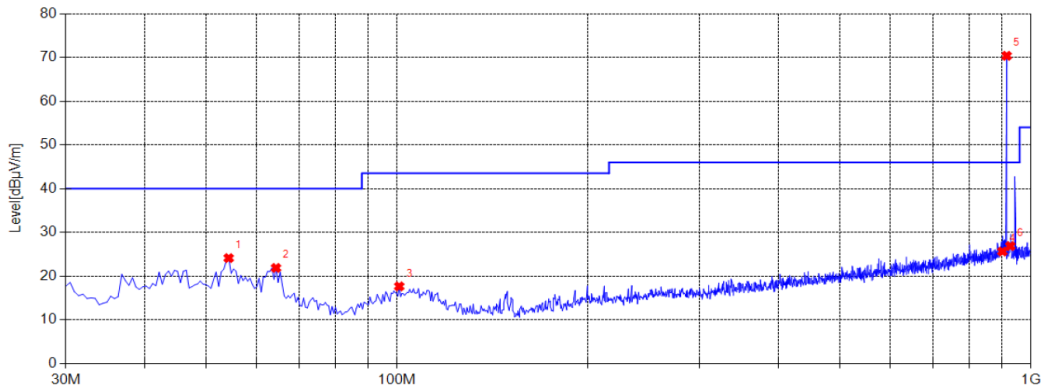

Suspected List

NO.	Frequency [MHz]	Reading (dBµV/m)	Factor [dB]	Result [dB µV/m]	Limit [dB µV/m]	Margin [dB]	Height [cm]	Angle [°]	Detector	Polarity	Remark
1	54.2500	31.05	-6.91	24.14	40.00	15.86	100	290	PK	Vertical	Pass
2	64.4350	30.94	-9.06	21.88	40.00	18.12	100	250	PK	Vertical	Pass
3	100.8100	26.25	-8.58	17.67	43.50	25.83	100	190	PK	Vertical	Pass
4	902.0000	21.97	3.67	25.64	46.00	20.36	100	30	PK	Vertical	Pass
5	916.0000	67.29	3.08	70.37	114.00	43.63	100	330	PK	Vertical	Pass
5	916.0000	66.04	3.08	69.12	94.00	24.88	100	330	QP	Vertical	Pass
5	916.0000	65.71	3.08	68.79	94.00	25.21	100	330	AV	Vertical	Pass
6	928.0000	22.43	4.45	26.88	46.00	19.12	100	160	PK	Vertical	Pass

Note: Result (dBµV/m) = Reading(dBµV/m) + Factor (dB) .
 Factor (dB) = Antenna Factor (dB/m) + Cable loss (dB) - Pre Amplifier gain (dB).
 Margin=Limit(dBµV/m)- Result (dBµV/m)

For 1GHz to 25GHz

Frequency(MHz):				908.42		Polarity:			HORIZONTAL	
No.	Frequency (MHz)	Emission Level (dBuV/m)		Limit (dBuV/m)	Margin (dB)	Raw Value (dBuV)	Antenna Factor (dB/m)	Cable Factor (dB)	Pre-amplifier (dB)	Correction Factor (dB/m)
1	1816.84	56.25	PK	74	17.75	60.43	27.23	4.03	35.44	-4.18
1	1816.84	47.25	AV	54	6.75	51.43	27.23	4.03	35.44	-4.18
2	2725.26	49.22	PK	74	24.78	50.29	29.40	4.96	35.43	-1.07
2	2725.26	--	AV	54	--	--	--	--	--	--
3	3633.68	50.72	PK	74	23.28	48.14	32.23	5.98	35.63	2.58
3	3633.68	--	AV	54	--	--	--	--	--	--

Frequency(MHz):				908.42		Polarity:			VERTICAL	
No.	Frequency (MHz)	Emission Level (dBuV/m)		Limit (dBuV/m)	Margin (dB)	Raw Value (dBuV)	Antenna Factor (dB/m)	Cable Factor (dB)	Pre-amplifier (dB)	Correction Factor (dB/m)
1	1816.84	56.98	PK	74	17.02	61.16	27.23	4.03	35.44	-4.18
1	1816.84	48.54	AV	54	5.46	52.72	27.23	4.03	35.44	-4.18
2	2725.26	50.05	PK	74	23.95	51.12	29.40	4.96	35.43	-1.07
2	2725.26	--	AV	54	--	--	--	--	--	--
3	3633.68	51.87	PK	74	22.13	49.29	32.23	5.98	35.63	2.58
3	3633.68	--	AV	54	--	--	--	--	--	--

REMARKS:

1. Emission level (dBuV/m) =Raw Value (dBuV)+Correction Factor (dB/m)
2. Correction Factor (dB/m) = Antenna Factor (dB/m)+Cable Factor (dB)-Pre-amplifier Factor
3. Margin value = Limit value- Emission level.
4. -- Mean the PK detector measured value is below average limit.
5. The other emission levels were very low against the limit.
6. RBW1MHz VBW3MHz Peak detector is for PK value; RBW 1MHz VBW10Hz Peak detector is for AV value.
7. For fundamental frequency, RBW 3MHz VBW 3MHz Peak detector is for PK Value ; RMS detector is for AV value.

Frequency(MHz):				916.00		Polarity:			HORIZONTAL	
No.	Frequency (MHz)	Emission Level (dBuV/m)		Limit (dBuV/m)	Margin (dB)	Raw Value (dBuV)	Antenna Factor (dB/m)	Cable Factor (dB)	Pre-amplifier (dB)	Correction Factor (dB/m)
1	1832.00	54.68	PK	74	19.32	58.75	27.32	4.04	35.43	-4.07
1	1832.00	45.71	AV	54	8.29	49.78	27.32	4.04	35.43	-4.07
2	2748.00	46.55	PK	74	27.45	47.52	29.48	4.98	35.43	-0.97
2	2748.00	--	AV	54	--	--	--	--	--	--
3	3664.00	49.50	PK	74	24.50	46.70	32.42	6.02	35.64	2.80
3	3664.00	--	AV	54	--	--	--	--	--	--

Frequency(MHz):				916.00		Polarity:			VERTICAL	
No.	Frequency (MHz)	Emission Level (dBuV/m)		Limit (dBuV/m)	Margin (dB)	Raw Value (dBuV)	Antenna Factor (dB/m)	Cable Factor (dB)	Pre-amplifier (dB)	Correction Factor (dB/m)
1	1832.00	56.87	PK	74	17.13	60.94	27.32	4.04	35.43	-4.07
1	1832.00	47.90	AV	54	6.10	51.97	27.32	4.04	35.43	-4.07
2	2748.00	48.22	PK	74	25.78	49.19	29.48	4.98	35.43	-0.97
2	2748.00	--	AV	54	--	--	--	--	--	--
3	3664.00	50.59	PK	74	23.41	47.79	32.42	6.02	35.64	2.80
3	3664.00	--	AV	54	--	--	--	--	--	--

REMARKS:

1. Emission level (dBuV/m) =Raw Value (dBuV)+Correction Factor (dB/m)
2. Correction Factor (dB/m) = Antenna Factor (dB/m)+Cable Factor (dB)-Pre-amplifier Factor
3. Margin value = Limit value- Emission level.
4. -- Mean the PK detector measured value is below average limit.
5. The other emission levels were very low against the limit.
6. RBW1MHz VBW3MHz Peak detector is for PK value; RBW 1MHz VBW10Hz Peak detector is for AV value.
7. For fundamental frequency, RBW 3MHz VBW 3MHz Peak detector is for PK Value; RMS detector is for AV value.

4.3 Occupied Bandwidth Measurement

Limit

N/A

Test Configuration

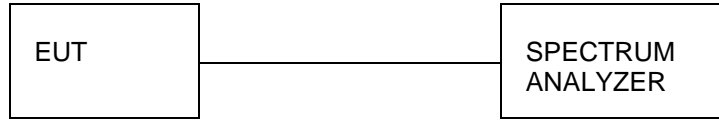

Test Procedure

The transmitter output was connected to the spectrum analyzer through an attenuator. The bandwidth of the fundamental frequency was measured by spectrum analyzer with 3 KHz RBW and 10 KHz VBW.

The 20dB bandwidth is defined as the total spectrum the power of which is higher than peak power minus 20dB.

Test Results

Temperature	22.8°C	Humidity	56%
Test Engineer	Moon Tan	Test mode	Z-wave

Modulation	Frequency (MHz)	99% OBW (KHz)	20dB bandwidth (KHz)	Result
FSK	908.42	88.9070	91.028	Pass
	916.00	111.5108	113.407	

Test plot as follows:

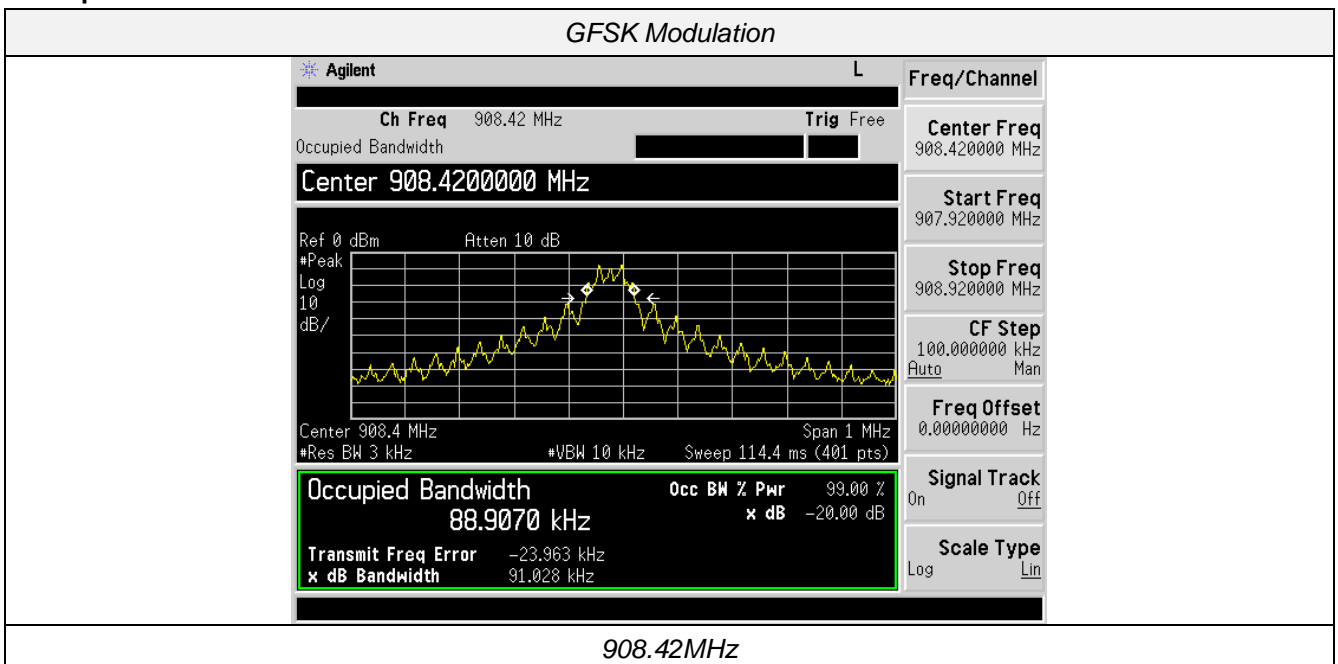

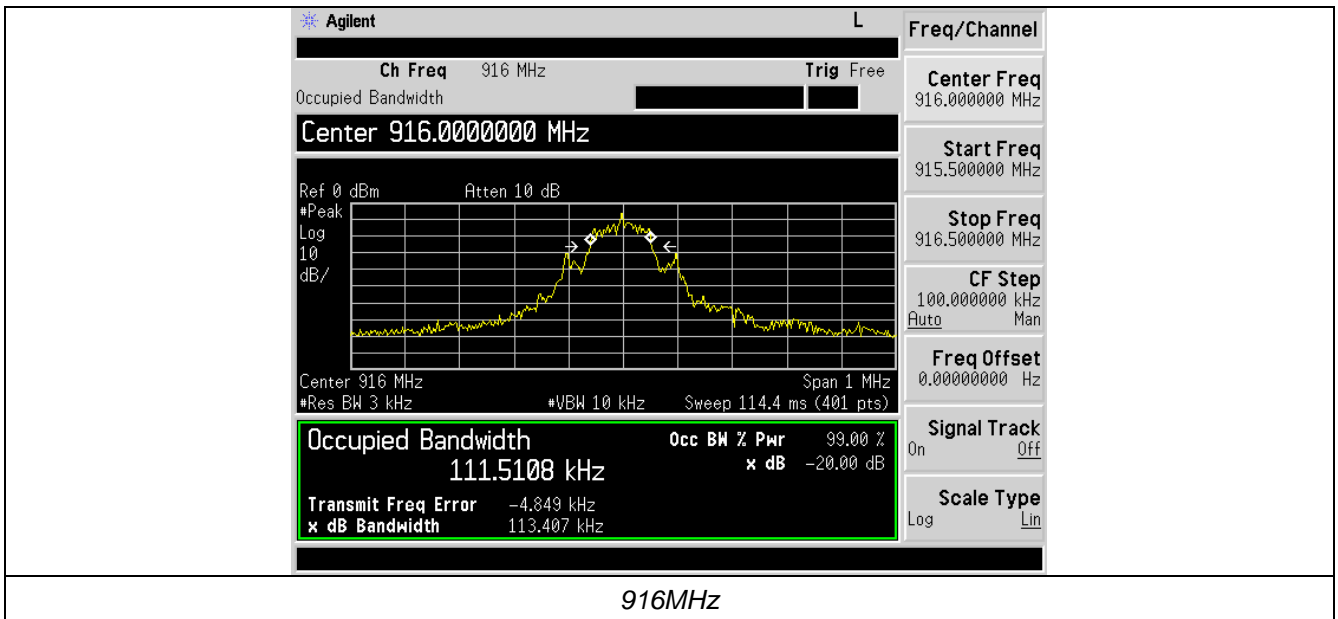

4.4 Antenna Requirement

Standard Applicable

For intentional device, according to FCC 47 CFR Section 15.203, an intentional radiator shall be designed to ensure that no antenna other than that furnished by the responsible party shall be used with the device.

Refer to statement below for compliance.

The manufacturer may design the unit so that the user can replace a broken antenna, but the use of a standard antenna jack or electrical connector is prohibited. Further, this requirement does not apply to intentional radiators that must be professionally installed.

Antenna Connected Construction

The antenna used in this product is an integral Antenna, The directional gains of antenna used for transmitting is 1.0dBi.

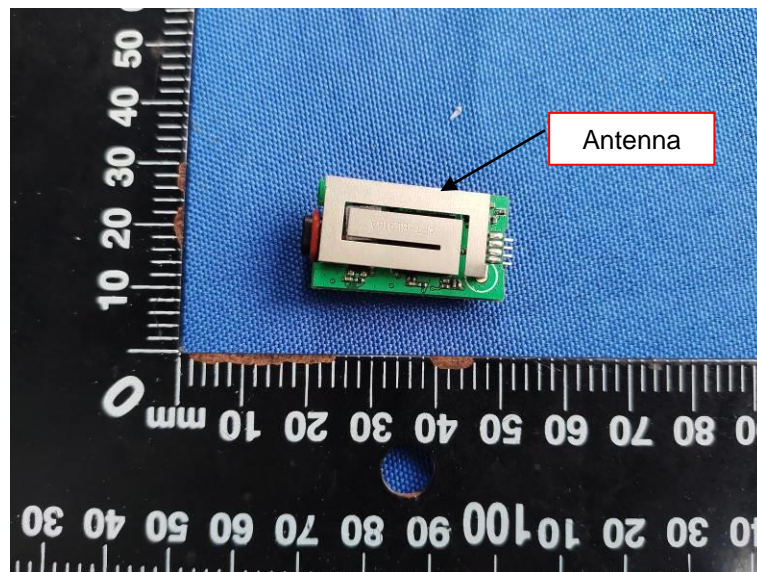

5 Test Setup Photos of the EUT



6 Photos of the EUT

External photos



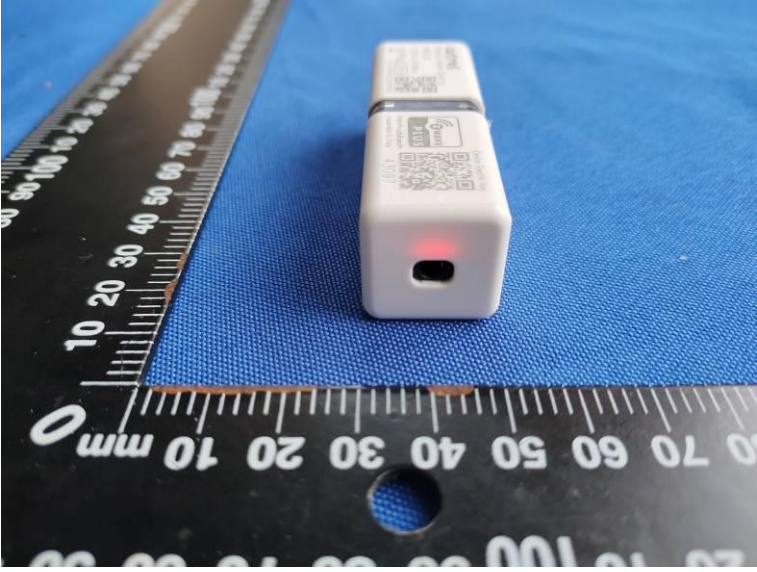
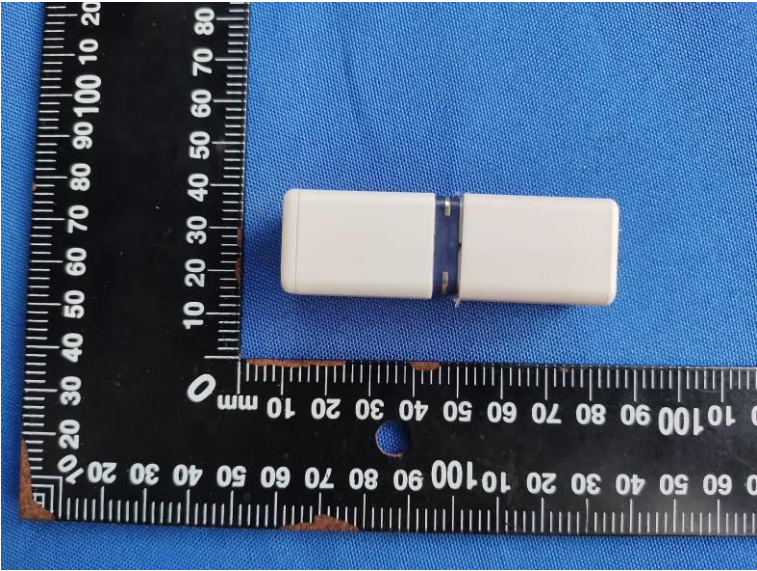

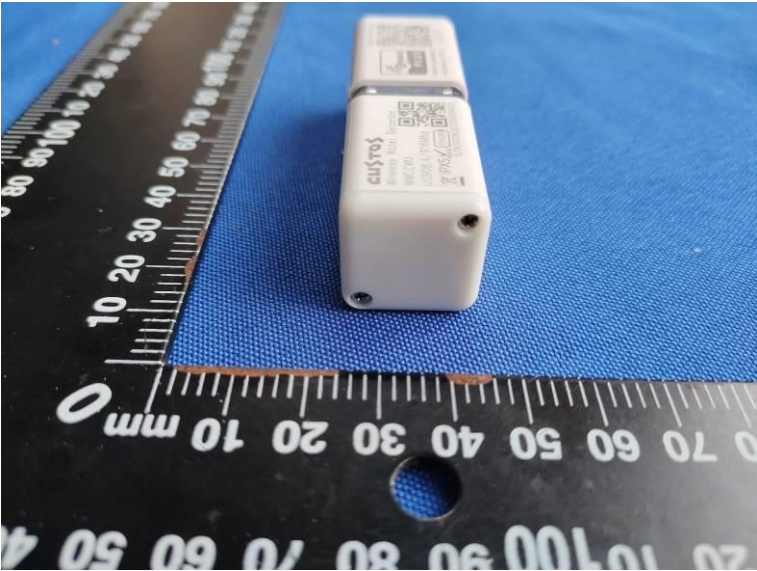

Internal Photos

