

TEST REPORT

Equipment under Test : Wireless Water Detector

Model /Type : WWDULU

Listed Models : WWDLWU

Applicant : **Ubitech Limited**

Address : Unit 12, 7/F Block A, Hi-Tech Industrial Centre, 5-21 Pak Tin Par Street, Tsuen Wan, NT, Hong Kong

Manufacturer : **ZHUHAI SHINTECH TECHNOLOGY CO.,LTD**

Address : 2th Floor, Building A NO. 7 Pingxi 3 Road, Nanping Technology Industrial Park, Zhuhai, China

Test Result:	PASS
---------------------	-------------

The test report merely corresponds to the test sample.
It is not permitted to copy extracts of these test result without the written permission of the test laboratory.

Contents

<u>1</u>	<u>TEST STANDARDS</u>	<u>4</u>
<u>2</u>	<u>SUMMARY</u>	<u>5</u>
2.1	General Remarks	5
2.2	Product Description	5
2.3	Equipment Under Test	5
2.4	Short description of the Equipment under Test (EUT)	5
2.5	EUT operation mode	5
2.6	Block Diagram of Test Setup	6
2.7	Special Accessories	6
2.8	Related Submittal(s) / Grant (s)	6
2.9	Modifications	6
<u>3</u>	<u>TEST ENVIRONMENT</u>	<u>7</u>
3.1	Address of the test laboratory	7
3.2	Test Facility	7
3.3	Environmental conditions	7
3.4	Summary of measurement results	8
3.5	Statement of the measurement uncertainty	8
3.6	Equipments Used during the Test	9
<u>4</u>	<u>TEST CONDITIONS AND RESULTS</u>	<u>10</u>
4.1	Conducted Emissions Test	10
4.2	Radiated Emissions and Band Edge	11
4.3	Maximum Conducted Output Power	18
4.4	Power Spectral Density	19
4.5	6dB Bandwidth	21
4.6	99% Bandwidth	23
4.7	Out-of-band Emissions	25
4.8	Antenna Requirement	28
<u>5</u>	<u>TEST SETUP PHOTOS OF THE EUT</u>	<u>29</u>
<u>6</u>	<u>PHOTOS OF THE EUT</u>	<u>30</u>

1 TEST STANDARDS

The tests were performed according to following standards:

FCC Rules Part 15.247: Frequency Hopping, Direct Spread Spectrum and Hybrid Systems that are in operation within the bands of 902-928 MHz, 2400-2483.5 MHz, and 5725-5850 MHz.

ANSI C63.10-2013: American National Standard for Testing Unlicensed Wireless Devices

KDB558074 D01 v05r02: Guidance for Compliance Measurements on Digital Transmission Systems (DTS) ,Frequency Hopping Spread Spectrum System(HFSS), and Hybrid System Devices Operating Under §15.247 of The FCC rules.

RSS-247-Issue 2: Digital Transmission Systems (DTSs), Frequency Hopping Systems (FHSs) and Licence-Exempt Local Area Network (LE-LAN) Devices.

RSS-Gen Issue 5: General Requirements for Compliance of Radio Apparatus

2 SUMMARY

2.1 General Remarks

Date of receipt of test sample	:	Feb. 17, 2022
Testing commenced on	:	Feb. 18, 2022
Testing concluded on	:	Mar. 07, 2022

2.2 Product Description

Product Name:	Wireless Water Detector
HVIN	WWDULU, WWDLWU
Power supply:	ER14250- Battery 3.6V 1200mAh
Hardware Version:	Rev0.1
Software Version:	V1.0
Test samples ID:	CTA220321007-1# (Engineer sample) CTA220321007-2# (Normal sample)
Lora 500KHz:	
Operation frequency:	903MHz~914.2MHz
Modulation:	LoRa
Channel number:	8
Channel separation:	1.6MHz
Antenna type:	Monopole antenna
Antenna gain:	1.0 dBi

Note:Antenna gain is provide by the manufacturer.

2.3 Equipment Under Test

Power supply system utilised

Power supply voltage	:	<input type="radio"/> 230V / 50 Hz	<input type="radio"/> 120V / 60Hz
		<input type="radio"/> 12 V DC	<input type="radio"/> 24 V DC
		<input checked="" type="radio"/> Other (specified in blank below)	

DC 3.6V From Battery

2.4 Short description of the Equipment under Test (EUT)

This is a Wireless Water Detector.

For more details, refer to the user's manual of the EUT.

2.5 EUT operation mode

The Applicant provides communication tools software (CustosGeneralTool.UI) to control the EUT for staying in continuous transmitting (Duty Cycle more than 98%) and receiving mode for testing .There are 64 channels provided to the EUT operation on 125kHz and 8 channels operation on 500kHz.

Operation Frequency Lora 500KHz:

Channel	Frequency (MHz)	Channel	Frequency (MHz)
64	903.00	68	909.40
65	904.60	69	911.00
66	906.20	70	912.60
67	907.80	71	914.20

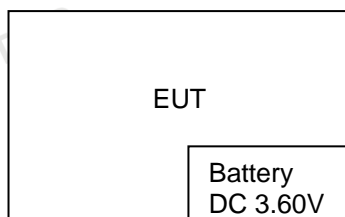
2.6 Block Diagram of Test Setup**2.7 Special Accessories**

Follow auxiliary equipment(s) test with EUT that provided by the manufacturer or laboratory is listed as follow:

Description	Manufacturer	Model	Technical Parameters	Certificate	Provided by
/	/	/	/	/	/
/	/	/	/	/	/
/	/	/	/	/	/
/	/	/	/	/	/

2.8 Related Submittal(s) / Grant (s)

This submittal(s) (test report) is intended for the device filing to comply with Section 15.247 of the FCC Part 15, Subpart C Rules and RSS-247.

2.9 Modifications

No modifications were implemented to meet testing criteria.

3 TEST ENVIRONMENT

3.1 Address of the test laboratory

Shenzhen CTA Testing Technology Co., Ltd.

Room 106, Building 1, Yibaolai Industrial Park, Qiaotou Community, Fuhai Street, Bao'an District, Shenzhen, China

3.2 Test Facility

The test facility is recognized, certified, or accredited by the following organizations:

FCC-Registration No.: 517856 Designation Number: CN1318

Shenzhen CTA Testing Technology Co., Ltd. has been listed on the US Federal Communications Commission list of test facilities recognized to perform electromagnetic emissions measurements.

A2LA-Lab Cert. No.: 6534.01

Shenzhen CTA Testing Technology Co., Ltd. has been listed by American Association for Laboratory Accreditation to perform electromagnetic emission measurement.

IC-Registration No.: 27890 CAB identifier: CN0127

The 3m-Semi anechoic test site fulfils CISPR 16-1-4 according to ANSI C63.10 and CISPR 16-1-4:2010.

3.3 Environmental conditions

During the measurement the environmental conditions were within the listed ranges:

Radiated Emission:

Temperature:	24 ° C
Humidity:	46 %
Atmospheric pressure:	950-1050mbar

AC Power Conducted Emission:

Temperature:	25 ° C
Humidity:	47 %
Atmospheric pressure:	950-1050mbar

Conducted testing:

Temperature:	24 ° C
Humidity:	46 %
Atmospheric pressure:	950-1050mbar

Shenzhen CTA Testing Technology Co., Ltd.

Room 106, Building 1, Yibaolai Industrial Park, Qiaotou Community, Fuhai Street, Bao'an District, Shenzhen, China

Tel:+86-755 2322 5875 E-mail:cta@cta-test.cn Web:http://www.cta-test.cn

3.4 Summary of measurement results

Test Specification clause	Test case	Test Mode	Test Channel	Recorded In Report		Test result
§15.247(b)(4)	Antenna gain	Lora DR4	<input checked="" type="checkbox"/> Lowest <input checked="" type="checkbox"/> Middle <input checked="" type="checkbox"/> Highest	Lora DR4	<input checked="" type="checkbox"/> Lowest <input checked="" type="checkbox"/> Middle <input checked="" type="checkbox"/> Highest	Pass
§15.247(e) RSS-247 5.2(b)	Power spectral density	Lora DR4	<input checked="" type="checkbox"/> Lowest <input checked="" type="checkbox"/> Middle <input checked="" type="checkbox"/> Highest	Lora DR4	<input checked="" type="checkbox"/> Lowest <input checked="" type="checkbox"/> Middle <input checked="" type="checkbox"/> Highest	Pass
§15.247(a)(2) RSS-247 5.2(a)	Spectrum bandwidth – 6 dB bandwidth	Lora DR4	<input checked="" type="checkbox"/> Lowest <input checked="" type="checkbox"/> Middle <input checked="" type="checkbox"/> Highest	Lora DR4	<input checked="" type="checkbox"/> Lowest <input checked="" type="checkbox"/> Middle <input checked="" type="checkbox"/> Highest	Pass
§15.247(b)(1) RSS-247 5.4(d)	Maximum output power	Lora DR4	<input checked="" type="checkbox"/> Lowest <input checked="" type="checkbox"/> Middle <input checked="" type="checkbox"/> Highest	Lora DR4	<input checked="" type="checkbox"/> Lowest <input checked="" type="checkbox"/> Middle <input checked="" type="checkbox"/> Highest	Pass
§15.247(d) RSS-247 5.5	Band edge compliance conducted	Lora DR4	<input checked="" type="checkbox"/> Lowest <input checked="" type="checkbox"/> Highest	Lora DR4	<input checked="" type="checkbox"/> Lowest <input checked="" type="checkbox"/> Highest	Pass
§15.205 RSS-Gen 8.10	Band edge compliance radiated	Lora DR4	<input checked="" type="checkbox"/> Lowest <input checked="" type="checkbox"/> Highest	Lora DR4	<input checked="" type="checkbox"/> Lowest <input checked="" type="checkbox"/> Highest	Pass
§15.247(d) RSS-247 5.2	TX spurious emissions conducted	Lora DR4	<input checked="" type="checkbox"/> Lowest <input checked="" type="checkbox"/> Middle <input checked="" type="checkbox"/> Highest	Lora DR4	<input checked="" type="checkbox"/> Lowest <input checked="" type="checkbox"/> Middle <input checked="" type="checkbox"/> Highest	Pass
§15.209(a) RSS-Gen 8.9	TX spurious emissions Radiated Above 1GHz	Lora DR4	<input checked="" type="checkbox"/> Lowest <input checked="" type="checkbox"/> Middle <input checked="" type="checkbox"/> Highest	Lora DR4	<input checked="" type="checkbox"/> Lowest <input checked="" type="checkbox"/> Middle <input checked="" type="checkbox"/> Highest	Pass
§15.209(a) RSS-Gen 8.9	TX spurious Emissions radiated Below 1GHz	Lora DR4	<input checked="" type="checkbox"/> Lowest <input checked="" type="checkbox"/> Middle <input checked="" type="checkbox"/> Highest	Lora DR4	<input checked="" type="checkbox"/> Middle	Pass
§15.207 RSS-Gen 8.8	Conducted Emissions 9KHz-30 MHz	N/A	N/A	N/A	N/A	N/A

Note:1. N/A mean Not Applicable.

2. DR means DateRate refer to LoRaWAN Specification as below:

DataRate	Configuration	Indicative physical bit rate [bit/sec]
0	LoRa: SF10 / 125 kHz	980
1	LoRa: SF9 / 125 kHz	1760
2	LoRa: SF8 / 125 kHz	3125
3	LoRa: SF7 / 125 kHz	5470
4	LoRa: SF8 / 500 kHz	12500

3.5 Statement of the measurement uncertainty

The data and results referenced in this document are true and accurate. The reader is cautioned that there may be errors within the calibration limits of the equipment and facilities. The measurement uncertainty was calculated for all measurements listed in this test report acc. to TR-100028-01 "Electromagnetic compatibility and Radio spectrum Matters (ERM);Uncertainties in the measurement of mobile radio equipment characteristics; Part 1" and TR-100028-02 "Electromagnetic compatibility and Radio spectrum Matters (ERM);Uncertainties in the measurement of mobile radio equipment characteristics; Part 2 " and is documented in the Shenzhen CTA Testing Technology Co., Ltd. quality system acc. to DIN EN ISO/IEC 17025. Furthermore, component and process variability of devices similar to that tested may result in additional deviation. The manufacturer has the sole responsibility of continued compliance of the device.

Hereafter the best measurement capability for Shenzhen CTA Testing Technology Co., Ltd. :

Test	Range	Measurement Uncertainty	Notes
Radiated Emission	30~1000MHz	4.06 dB	(1)

Shenzhen CTA Testing Technology Co., Ltd.

Room 106, Building 1, Yibaolai Industrial Park, Qiaotou Community, Fuhai Street, Bao'an District, Shenzhen, China
Tel:+86-755 2322 5875 E-mail:cta@cta-test.cn Web:http://www.cta-test.cn

Radiated Emission	1~18GHz	5.14 dB	(1)
Radiated Emission	18-40GHz	5.38 dB	(1)
Conducted Disturbance	0.15~30MHz	2.14 dB	(1)

(1) This uncertainty represents an expanded uncertainty expressed at approximately the 95% confidence level using a coverage factor of k=2.

3.6 Equipments Used during the Test

Test Equipment	Manufacturer	Model No.	Equipment No.	Calibration Date	Calibration Due Date
LISN	R&S	ENV216	CTA-308	2021/08/06	2022/08/05
LISN	R&S	ENV216	CTA-314	2021/08/06	2022/08/05
EMI Test Receiver	R&S	ESPI	CTA-307	2021/08/06	2022/08/05
EMI Test Receiver	R&S	ESCI	CTA-306	2021/08/06	2022/08/05
Spectrum Analyzer	Agilent	N9020A	CTA-301	2021/08/06	2022/08/05
Spectrum Analyzer	R&S	FSP	CTA-337	2021/08/06	2022/08/05
Vector Signal generator	Agilent	N5182A	CTA-305	2021/08/06	2022/08/05
Analog Signal Generator	R&S	SML03	CTA-304	2021/08/06	2022/08/05
Universal Radio Communication	CMW500	R&S	CTA-302	2021/08/06	2022/08/05
Temperature and humidity meter	Chigo	ZG-7020	CTA-326	2021/08/06	2022/08/05
Ultra-Broadband Antenna	Schwarzbeck	VULB9163	CTA-310	2021/08/07	2022/08/06
Horn Antenna	Schwarzbeck	BBHA 9120D	CTA-309	2021/08/07	2022/08/06
Loop Antenna	Zhinan	ZN30900C	CTA-311	2021/08/07	2022/08/06
Horn Antenna	Beijing Hangwei Dayang	OBH100400	CTA-336	2021/08/06	2022/08/05
Amplifier	Schwarzbeck	BBV 9745	CTA-312	2021/08/06	2022/08/05
Amplifier	Taiwan chengyi	EMC051845B	CTA-313	2021/08/06	2022/08/05
Directional coupler	NARDA	4226-10	CTA-303	2021/08/06	2022/08/05
High-Pass Filter	XingBo	XBLBQ-GTA18	CTA-402	2021/08/06	2022/08/05
High-Pass Filter	XingBo	XBLBQ-GTA27	CTA-403	2021/08/06	2022/08/05
Automated filter bank	Tonscend	JS0806-F	CTA-404	2021/08/06	2022/08/05
Power Sensor	Agilent	U2021XA	CTA-405	2021/08/06	2022/08/05
Amplifier	Schwarzbeck	BBV9719	CTA-406	2021/08/06	2022/08/05

4 TEST CONDITIONS AND RESULTS

4.1 Conducted Emissions Test

LIMIT

According to FCC CFR Title 47 Part 15 Subpart C Section 15.207, AC Power Line Conducted Emissions Limits for Licence-Exempt Radio Apparatus as below:

Frequency range (MHz)	Limit (dBuV)	
	Quasi-peak	Average
0.15-0.5	66 to 56*	56 to 46*
0.5-5	56	46
5-30	60	50

* Decreases with the logarithm of the frequency.

TEST CONFIGURATION

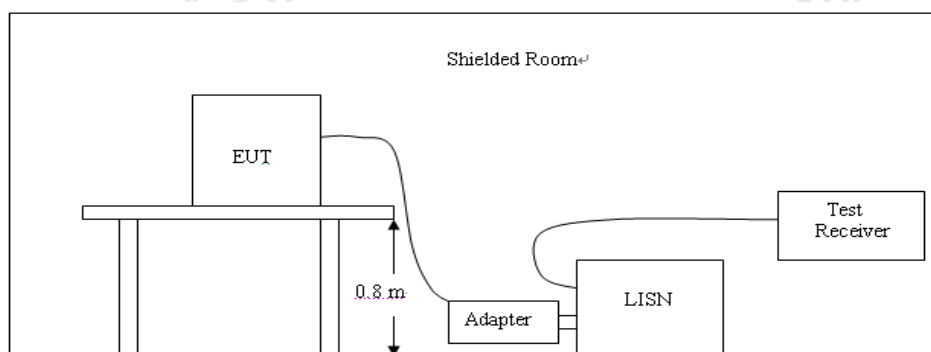

TEST PROCEDURE

1. The equipment was set up as per the test configuration to simulate typical actual usage per the user's manual. The EUT is a tabletop system; a wooden table with a height of 0.8 meters is used and is placed on the ground plane as per ANSI C63.10:2013.
2. Support equipment, if needed, was placed as per ANSI C63.10:2013.
3. All I/O cables were positioned to simulate typical actual usage as per ANSI C63.10:2013.
4. If a EUT received DC power from the USB Port of Notebook PC, the PC's adapter received AC120V/60Hz power through a Line Impedance Stabilization Network (LISN) which supplied power source and was grounded to the ground plane.
5. All support equipments received AC power from a second LISN, if any.
6. The EUT test program was started. Emissions were measured on each current carrying line of the EUT using a spectrum Analyzer / Receiver connected to the LISN powering the EUT. The LISN has two monitoring points: Line 1 (Hot Side) and Line 2 (Neutral Side). Two scans were taken: one with Line 1 connected to Analyzer / Receiver and Line 2 connected to a 50 ohm load; the second scan had Line 1 connected to a 50 ohm load and Line 2 connected to the Analyzer / Receiver.
7. Analyzer / Receiver scanned from 150 KHz to 30MHz for emissions in each of the test modes.
8. During the above scans, the emissions were maximized by cable manipulation.

TEST RESULTS

Not applicable to this device, which is powered by battery.

4.2 Radiated Emissions and Band Edge

TEST CONFIGURATION

Frequency range 9 KHz – 30MHz

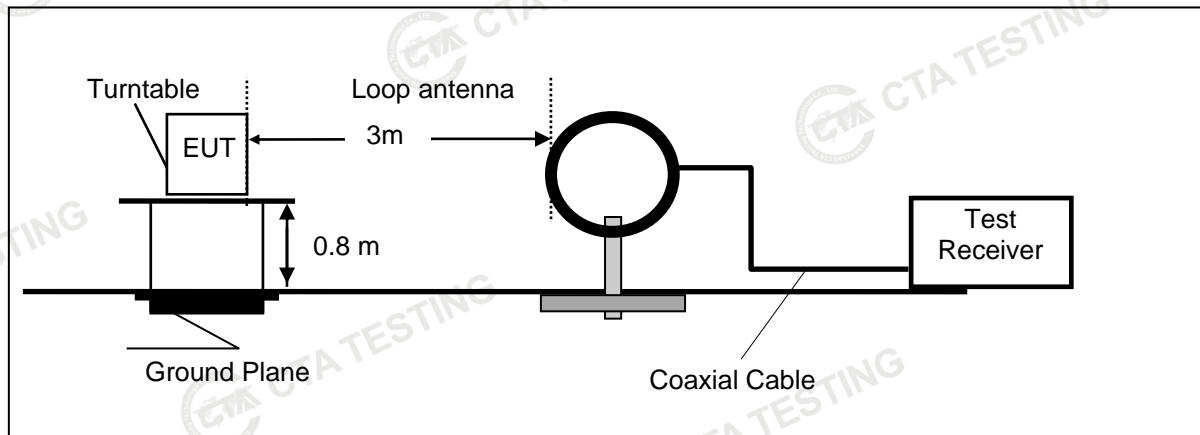

Frequency range 30MHz – 1000MHz

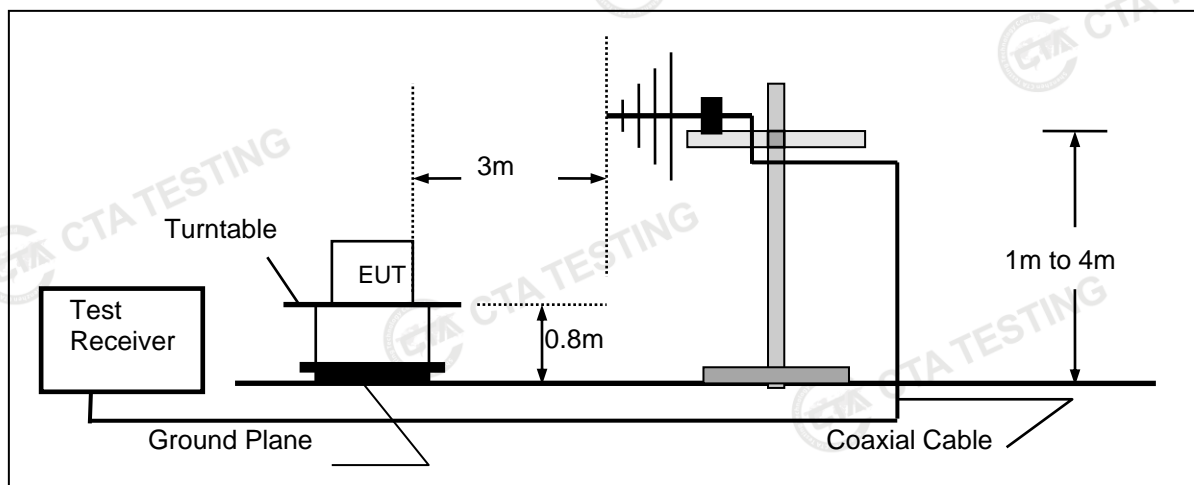

Frequency range above 1GHz-25GHz

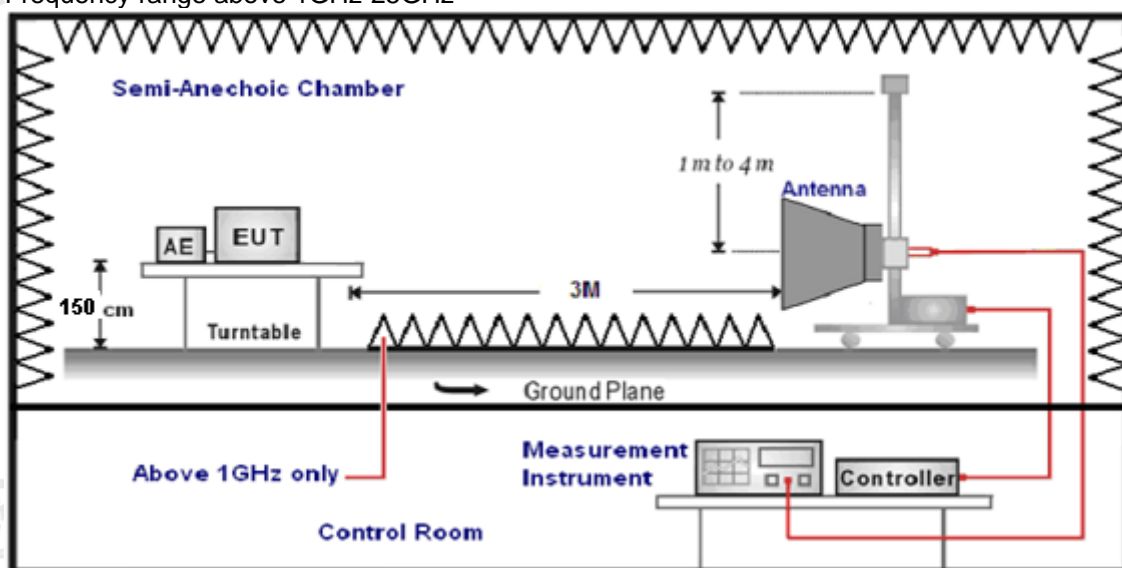

TEST PROCEDURE

1. The EUT was placed on a turn table which is 0.8m above ground plane when testing frequency range 9 KHz –1GHz;the EUT was placed on a turn table which is 1.5m above ground plane when testing frequency range 1GHz – 10GHz.
2. Maximum procedure was performed by raising the receiving antenna from 1m to 4m and rotating the turn table from 0° to 360° to acquire the highest emissions from EUT.
3. And also, each emission was to be maximized by changing the polarization of receiving antenna both horizontal and vertical.
4. Repeat above procedures until all frequency measurements have been completed.
5. Radiated emission test frequency band from 9KHz to 25GHz.
6. The distance between test antenna and EUT as following table states:

Test Frequency range	Test Antenna Type	Test Distance
9KHz-30MHz	Active Loop Antenna	3
30MHz-1GHz	Ultra-Broadband Antenna	3
1GHz-18GHz	Double Ridged Horn Antenna	3

7. Setting test receiver/spectrum as following table states:

Test Frequency range	Test Receiver/Spectrum Setting	Detector
9KHz-150KHz	RBW=200Hz/VBW=3KHz, Sweep time=Auto	QP
150KHz-30MHz	RBW=9KHz/VBW=100KHz, Sweep time=Auto	QP
30MHz-1GHz	RBW=120KHz/VBW=1000KHz, Sweep time=Auto	QP
1GHz-40GHz	Peak Value: RBW=1MHz/VBW=3MHz, Sweep time=Auto Average Value: RBW=1MHz/VBW=10Hz, Sweep time=Auto	Peak

Field Strength Calculation

The field strength is calculated by adding the Antenna Factor and Cable Factor and subtracting the Amplifier Gain and Duty Cycle Correction Factor(if any) from the measured reading. The basic equation with a sample calculation is as follows:

$$FS = RA + AF + CL - AG$$

Where FS = Field Strength	CL = Cable Attenuation Factor (Cable Loss)
RA = Reading Amplitude	AG = Amplifier Gain
AF = Antenna Factor	

$$\text{Transd} = \text{AF} + \text{CL} - \text{AG}$$

RADIATION LIMIT

For intentional device, according to § 15.209(a), the general requirement of field strength of radiated emission from intentional radiators at a distance of 3 meters shall not exceed the following table. According to § 15.247(d), in any 100kHz bandwidth outside the frequency band in which the EUT is operating, the radio frequency power that is produced by the intentional radiator shall be at least 20dB below that in the 100kHz bandwidth within the band that contains the highest level of desired power.

Frequency (MHz)	Distance (Meters)	Radiated (dBµV/m)	Radiated (µV/m)
0.009-0.49	3	$20\log(2400/F(\text{KHz})) + 40\log(300/3)$	$2400/F(\text{KHz})$
0.49-1.705	3	$20\log(24000/F(\text{KHz})) + 40\log(30/3)$	$24000/F(\text{KHz})$
1.705-30	3	$20\log(30) + 40\log(30/3)$	30
30-88	3	40.0	100
88-216	3	43.5	150
216-960	3	46.0	200
Above 960	3	54.0	500

TEST RESULTS

Remark:

1. This test was performed with EUT in X, Y, Z position and the worse case was found when EUT in X position.
2. For below 1GHz testing recorded worst at Lora DR4 middle channel.
3. Radiated emission test from 9 KHz to 10th harmonic of fundamental was verified, and no emission found except system noise floor in 9 KHz to 30MHz and not recorded in this report.

For 30MHz-1GHz

Test Frequency:	909.4MHz	Polarization:	Horizontal
-----------------	----------	---------------	------------

Test Graph

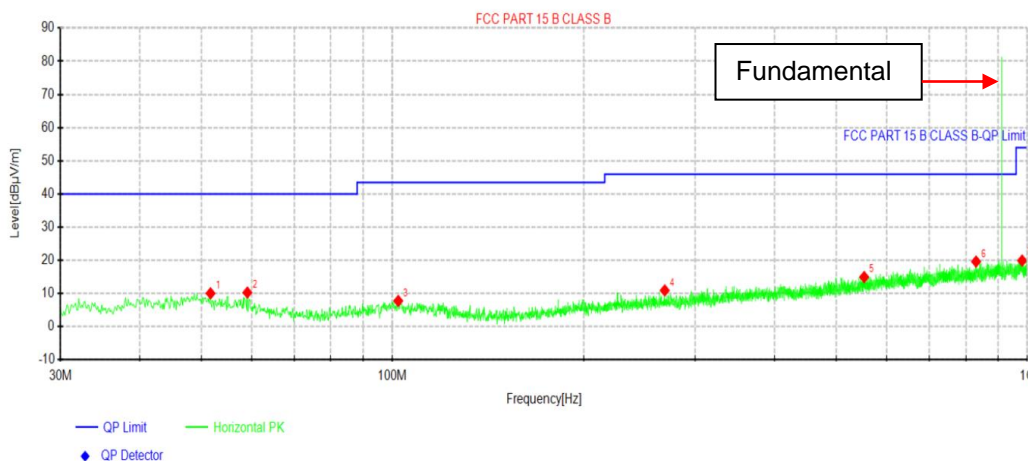

Suspected Data List

NO.	Freq. [MHz]	Reading [dBµV]	Level [dBµV/m]	Factor [dB/m]	Limit [dBµV/m]	Margin [dB]	Height [cm]	Angle [°]	Polarity
1	51.7038	26.50	10.07	-16.43	40.00	29.93	100	160	Horizontal
2	59.1	28.33	10.31	-18.02	40.00	29.69	100	10	Horizontal
3	102.143	26.27	7.80	-18.47	43.50	35.70	100	20	Horizontal
4	268.498	28.66	10.96	-17.70	46.00	35.04	100	120	Horizontal
5	553.315	28.54	14.98	-13.56	46.00	31.02	100	210	Horizontal
6	830.25	29.99	19.65	-10.34	46.00	26.35	100	330	Horizontal
7	981.327	28.57	19.95	-8.62	54.00	34.05	100	290	Horizontal

Note:

- 1.Result (dBµV/m) = Reading(dBµV/m) + Factor (dB) .
- 2.Factor (dB) = Antenna Factor (dB/m) + Cable loss (dB) - Pre Amplifier gain (dB).
- 3.Margin=Limit(dBµV/m)- Result (dBµV/m)

Test Frequency:	909.4MHz	Polarization:	Vertical
-----------------	----------	---------------	----------

Test Graph

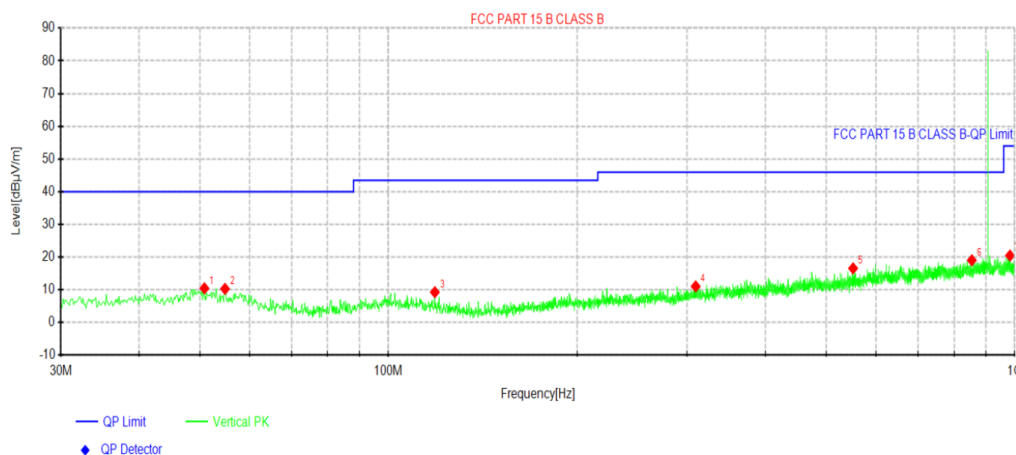

Suspected Data List

NO.	Freq. [MHz]	Reading [dBµV]	Level [dBµV/m]	Factor [dB/m]	Limit [dBµV/m]	Margin [dB]	Height [cm]	Angle [°]	Polarity
1	50.855	26.71	10.47	-16.24	40.00	29.53	100	160	Vertical
2	54.8562	27.41	10.31	-17.10	40.00	29.69	100	320	Vertical
3	118.633	29.37	9.28	-20.09	43.50	34.22	100	190	Vertical
4	309.481	28.28	11.06	-17.22	46.00	34.94	100	70	Vertical
5	551.981	30.19	16.58	-13.61	46.00	29.42	100	210	Vertical
6	854.015	28.79	19.04	-9.75	46.00	26.96	100	70	Vertical
7	982.54	29.13	20.49	-8.64	54.00	33.51	100	20	Vertical

Note:

- 1.Result (dBµV/m) = Reading(dBµV/m) + Factor (dB) .
- 2.Factor (dB) = Antenna Factor (dB/m) + Cable loss (dB) - Pre Amplifier gain (dB).
- 3.Margin=Limit(dBµV/m)- Result (dBµV/m)

For 1GHz to 10GHz

Frequency(MHz):				903.00		Polarity:			HORIZONTAL	
No.	Frequency (MHz)	Emission Level (dBuV/m)		Limit (dBuV/m)	Margin (dB)	Raw Value (dBuV)	Antenna Factor (dB/m)	Cable Factor (dB)	Pre-amplifier (dB)	Correction Factor (dB/m)
1	1806	60.58	PK	74	13.42	70.82	27.17	4.02	41.43	-10.24
1	1806	50.43	AV	54	3.57	60.67	27.17	4.02	41.43	-10.24
2	2709	45.77	PK	74	28.23	53.09	29.34	4.94	41.60	-7.32
2	2709	--	AV	54	--	--	--	--	--	--
3	3612	46.22	PK	74	27.78	50.21	32.09	5.83	41.92	-3.99
3	3612	--	AV	54	--	--	--	--	--	--

Frequency(MHz):				903.00		Polarity:			VERTICAL	
No.	Frequency (MHz)	Emission Level (dBuV/m)		Limit (dBuV/m)	Margin (dB)	Raw Value (dBuV)	Antenna Factor (dB/m)	Cable Factor (dB)	Pre-amplifier (dB)	Correction Factor (dB/m)
1	1806	61.28	PK	74	12.72	71.52	27.17	4.02	41.43	-10.24
1	1806	50.91	AV	54	3.09	61.15	27.17	4.02	41.43	-10.24
2	2709	46.55	PK	74	27.45	53.87	29.34	4.94	41.60	-7.32
2	2709	--	AV	54	--	--	--	--	--	--
3	3612	46.71	PK	74	27.29	50.70	32.09	5.83	41.92	-3.99
3	3612	--	AV	54	--	--	--	--	--	--

REMARKS:

1. Emission level (dBuV/m) = Raw Value (dBuV) + Correction Factor (dB/m)
2. Correction Factor (dB/m) = Antenna Factor (dB/m) + Cable Factor (dB) - Pre-amplifier Factor
3. Margin value = Limit value - Emission level.
4. -- Mean the PK detector measured value is below average limit.
5. The other emission levels were very low against the limit.
6. RBW1MHz VBW3MHz Peak detector is for PK value; RBW 1MHz VBW10Hz Peak detector is for AV value.
7. For fundamental frequency, RBW 3MHz VBW 3MHz Peak detector is for PK Value ; RMS detector is for AV value.

Lora 500KHz

Frequency(MHz):				909.40		Polarity:			HORIZONTAL	
No.	Frequency (MHz)	Emission Level (dBuV/m)		Limit (dBuV/m)	Margin (dB)	Raw Value (dBuV)	Antenna Factor (dB/m)	Cable Factor (dB)	Pre-amplifier (dB)	Correction Factor (dB/m)
1	1818.8	60.48	PK	74	13.52	70.63	27.24	4.03	41.42	-10.15
1	1818.8	50.49	AV	54	3.51	60.64	27.24	4.03	41.42	-10.15
2	2728.2	45.83	PK	74	28.17	53.06	29.41	4.96	41.60	-7.23
2	2728.2	--	AV	54	--	--	--	--	--	--
3	3637.6	46.30	PK	74	27.70	50.37	32.25	5.61	41.93	-4.07
3	3637.6	--	AV	54	--	--	--	--	--	--

Frequency(MHz):				909.40		Polarity:			VERTICAL	
No.	Frequency (MHz)	Emission Level (dBuV/m)		Limit (dBuV/m)	Margin (dB)	Raw Value (dBuV)	Antenna Factor (dB/m)	Cable Factor (dB)	Pre-amplifier (dB)	Correction Factor (dB/m)
1	1808.8	61.87	PK	74	12.13	72.09	27.19	4.02	41.42	-10.22
1	1808.8	51.52	AV	54	2.48	61.74	27.19	4.02	41.42	-10.22
2	2713.2	47.19	PK	74	26.81	54.49	29.36	4.94	41.60	-7.30
2	2713.2	--	AV	54	--	--	--	--	--	--
3	3617.6	47.54	PK	74	26.46	51.55	32.13	5.79	41.92	-4.01
3	3617.6	--	AV	54	--	--	--	--	--	--

REMARKS:

1. Emission level (dBuV/m) =Raw Value (dBuV)+Correction Factor (dB/m)
2. Correction Factor (dB/m) = Antenna Factor (dB/m)+Cable Factor (dB)-Pre-amplifier Factor
3. Margin value = Limit value- Emission level.
4. -- Mean the PK detector measured value is below average limit.
5. The other emission levels were very low against the limit.
6. RBW1MHz VBW3MHz Peak detector is for PK value; RBW 1MHz VBW10Hz Peak detector is for AV value.
7. For fundamental frequency, RBW 3MHz VBW 3MHz Peak detector is for PK Value ; RMS detector is for AV value.

Frequency(MHz):				914.20		Polarity:			HORIZONTAL	
No.	Frequency (MHz)	Emission Level (dBuV/m)		Limit (dBuV/m)	Margin (dB)	Raw Value (dBuV)	Antenna Factor (dB/m)	Cable Factor (dB)	Pre-amplifier (dB)	Correction Factor (dB/m)
1	1828.4	60.33	PK	74	13.67	70.42	27.30	4.04	41.42	-10.09
1	1828.4	50.30	AV	54	3.70	60.39	27.30	4.04	41.42	-10.09
2	2742.6	45.77	PK	74	28.23	52.94	29.46	4.98	41.61	-7.17
2	2742.6	--	AV	54	--	--	--	--	--	--
3	3656.8	46.49	PK	74	27.51	50.61	32.37	5.44	41.94	-4.12
3	3656.8	--	AV	54	--	--	--	--	--	--

Frequency(MHz):				914.20		Polarity:			VERTICAL	
No.	Frequency (MHz)	Emission Level (dBuV/m)		Limit (dBuV/m)	Margin (dB)	Raw Value (dBuV)	Antenna Factor (dB/m)	Cable Factor (dB)	Pre-amplifier (dB)	Correction Factor (dB/m)
1	1828.4	62.07	PK	74	11.93	72.16	27.30	4.04	41.42	-10.09
1	1828.4	51.44	AV	54	2.56	61.53	27.30	4.04	41.42	-10.09
2	2742.6	47.32	PK	74	26.68	54.49	29.46	4.98	41.61	-7.17
2	2742.6	--	AV	54	--	--	--	--	--	--
3	3656.8	47.20	PK	74	26.80	51.32	32.37	5.44	41.94	-4.12
3	3656.8	--	AV	54	--	--	--	--	--	--

REMARKS:

1. Emission level (dBuV/m) =Raw Value (dBuV)+Correction Factor (dB/m)
2. Correction Factor (dB/m) = Antenna Factor (dB/m)+Cable Factor (dB)-Pre-amplifier Factor
3. Margin value = Limit value- Emission level.
4. -- Mean the PK detector measured value is below average limit.
5. The other emission levels were very low against the limit.
6. RBW1MHz VBW3MHz Peak detector is for PK value; RBW 1MHz VBW10Hz Peak detector is for AV value.
7. For fundamental frequency, RBW 3MHz VBW 3MHz Peak detector is for PK Value; RMS detector is for AV value.

4.3 Maximum Conducted Output Power

Limit

The Maximum Peak Output Power Measurement is 30dBm.

Test Procedure

Remove the antenna from the EUT and then connect a low loss RF cable from the antenna port to the power sensor.

Test Configuration

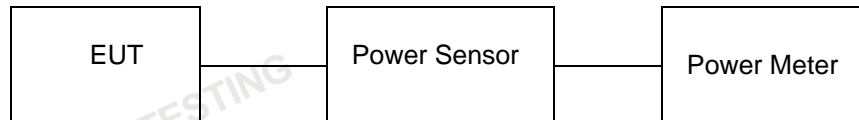

Test Results

Type	Channel	Output power (dBm)	Limit (dBm)	Result
Lora	64	8.067	30.00	Pass
	68	8.314		
	71	8.499		

4.4 Power Spectral Density

Limit

For digitally modulated systems, the power spectral density conducted from the intentional radiator to the antenna shall not be greater than 8 dBm in any 3 kHz band during any time interval of continuous transmission.

Test Procedure

1. Use this procedure when the maximum peak conducted output power in the fundamental emission is used to demonstrate compliance.
2. Set the RBW \geq 3 kHz.
3. Set the VBW \geq 3 \times RBW.
4. Set the span to 1.5 times the DTS channel bandwidth.
5. Detector = peak.
6. Sweep time = auto couple.
7. Trace mode = max hold.
8. Allow trace to fully stabilize.
9. Use the peak marker function to determine the maximum power level.
10. If measured value exceeds limit, reduce RBW (no less than 3 kHz) and repeat.
11. The resulting peak PSD level should not be more than 8dBm/3KHz.

Test Configuration



Test Results

Type	Channel	Power Spectral Density (dBm/3KHz)	Limit (dBm/3KHz)	Result
Lora	64	-4.567	8.00	Pass
	68	-4.057		
	71	-3.889		

Test plot as follows:

Lora

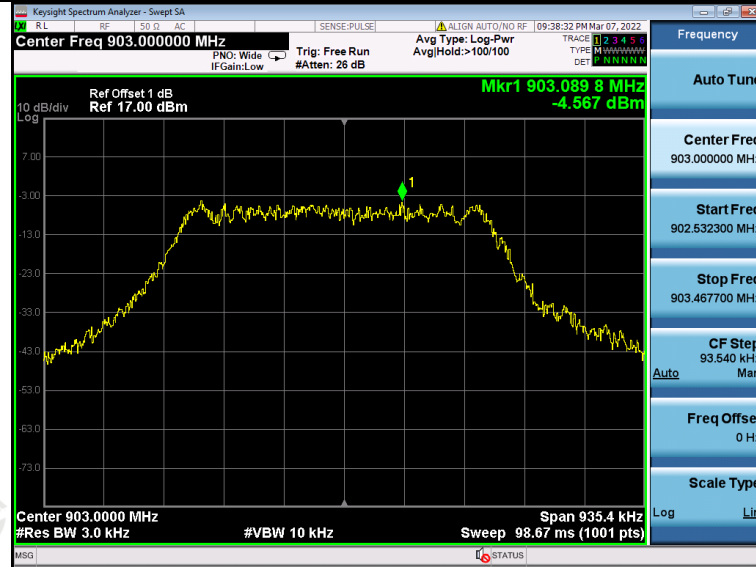

CH64

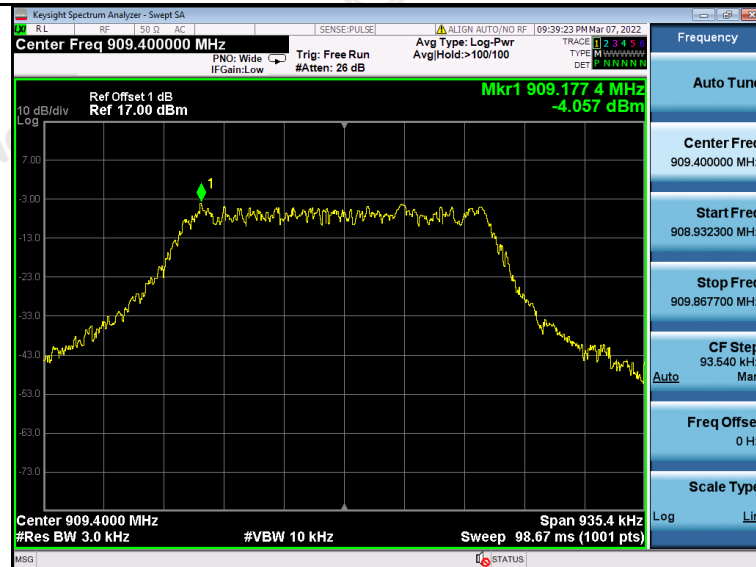

CH68

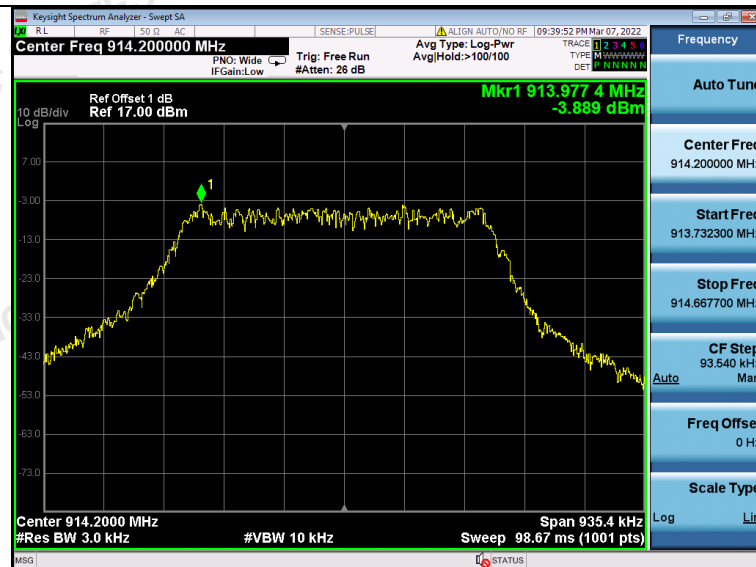

CH71

Shenzhen CTA Testing Technology Co., Ltd.

Room 106, Building 1, Yibaolai Industrial Park, Qiaotou Community, Fuhai Street, Bao'an District, Shenzhen, China
Tel:+86-755 2322 5875 E-mail:cta@cta-test.cn Web:http://www.cta-test.cn

4.5 6dB Bandwidth

Limit

For digital modulation systems, the minimum 6 dB bandwidth shall be at least 500 kHz

Test Procedure

The transmitter output was connected to the spectrum analyzer through an attenuator. The bandwidth of the fundamental frequency was measured by spectrum analyzer with 100 KHz RBW and 300 KHz VBW. The 6dB bandwidth is defined as the total spectrum the power of which is higher than peak power minus 6dB.

Test Configuration



Test Results

Type	Channel	6dB Bandwidth (MHz)	Limit (KHz)	Result
Lora	64	0.6236	≥500	Pass
	68	0.6219		
	71	0.6222		

Test plot as follows:



CH64



CH68



CH71

Shenzhen CTA Testing Technology Co., Ltd.

Room 106, Building 1, Yibaolai Industrial Park, Qiaotou Community, Fuhai Street, Bao'an District, Shenzhen, China
Tel:+86-755 2322 5875 E-mail:cta@cta-test.cn Web:http://www.cta-test.cn

4.6 99% Bandwidth

Limit

N/A

Test Procedure

The transmitter output was connected to the spectrum analyzer through an attenuator. The occupied bandwidth is the frequency bandwidth such that, below its lower and above its upper frequency limits, the mean powers are each equal to 0.5% of the total mean power of the given emission. The following procedure shall be used for measuring 99% power bandwidth:

- RBW=1% to 5% of the OBW
- VBW=approximately 3 X RBW
- Detector=Peak
- Trace Mode: Max Hold

Use the 99% power bandwidth function of the instrument to measure the Occupied Bandwidth and recorded.

Test Configuration



Test Results

Type	Channel	99% Bandwidth (MHz)	Limit (KHz)	Result
Lora	64	0.52122	N/A	Pass
	68	0.51417		
	71	0.51811		

Test plot as follows:

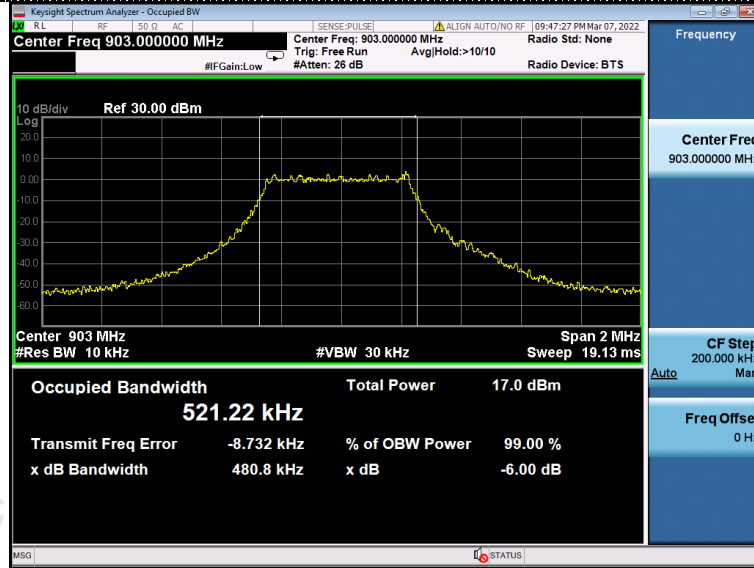

CH64

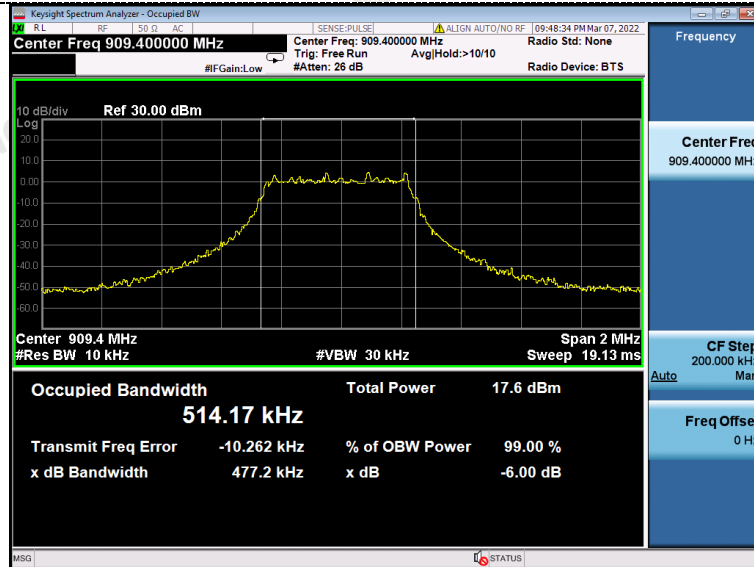

CH68

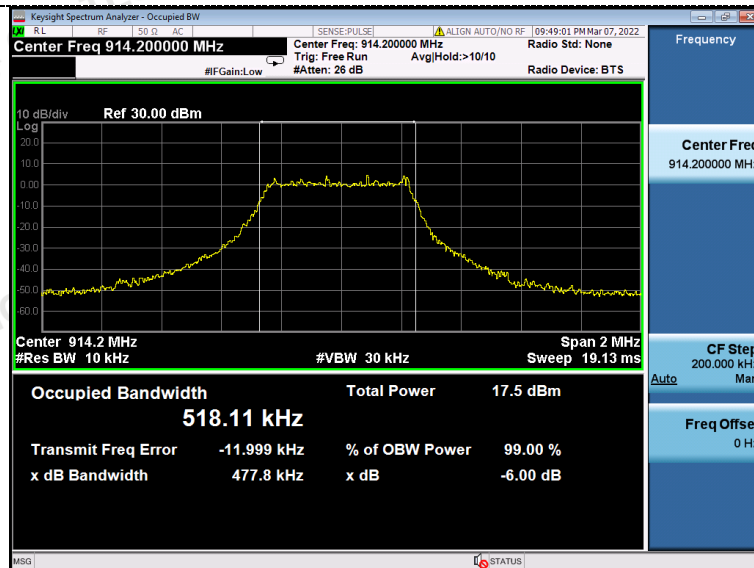

CH71

4.7 Out-of-band Emissions

Limit

In any 100 kHz bandwidth outside the frequency band in which the spread spectrum or digitally modulated intentional radiator is operating, the radio frequency power that is produced by the intentional radiator shall be at least 20 dB below that in the 100 kHz bandwidth within the band that contains the highest level of the desired power, based on either an RF conducted or a radiated measurement, provided the transmitter demonstrates compliance with the peak conducted power limits. If the transmitter complies with the conducted power limits based on the use of RMS averaging over a time interval, as permitted under paragraph (b)(3) of this section, the attenuation required under this paragraph shall be 30 dB instead of 20 dB. Attenuation below the general limits specified in §15.209(a) is not required.

Test Procedure

Connect the transmitter output to spectrum analyzer using a low loss RF cable, and set the spectrum analyzer to RBW=100 kHz, VBW= 300 kHz, peak detector, and max hold. Measurements utilizing these settings are made of the in-band reference level, band edge and out-of-band emissions.

Test Configuration



Test Results

Remark: The measurement frequency range is from 30MHz to the 10th harmonic of the fundamental frequency. The lowest, middle and highest channels are tested to verify the spurious emissions and band edge measurement data.

Test plot as follows:

Lora

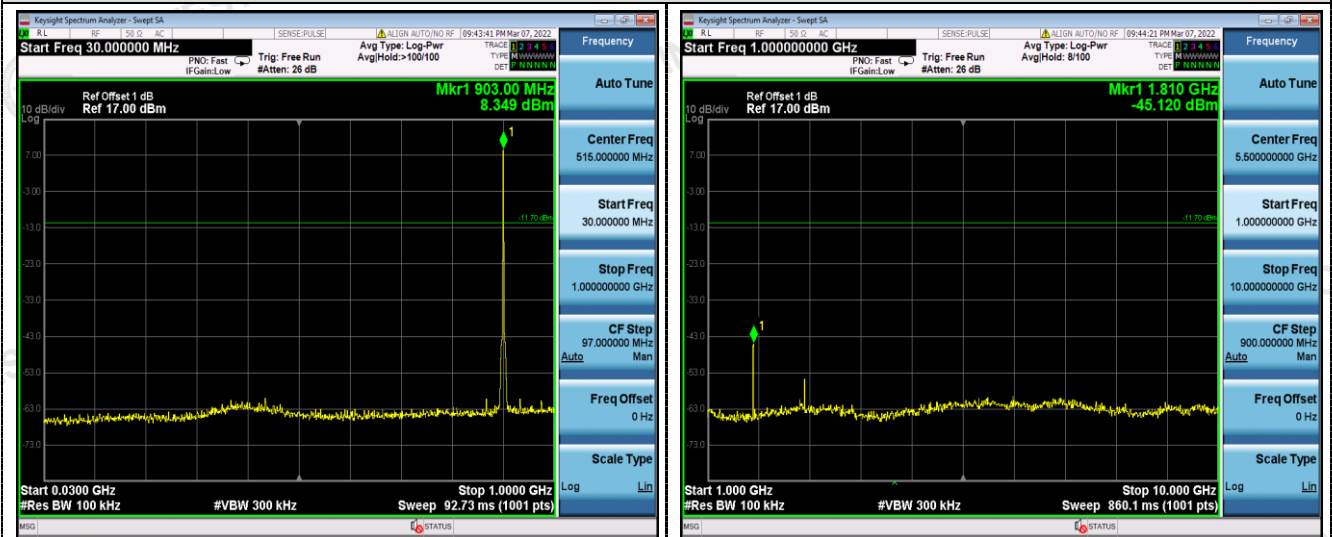

CH64

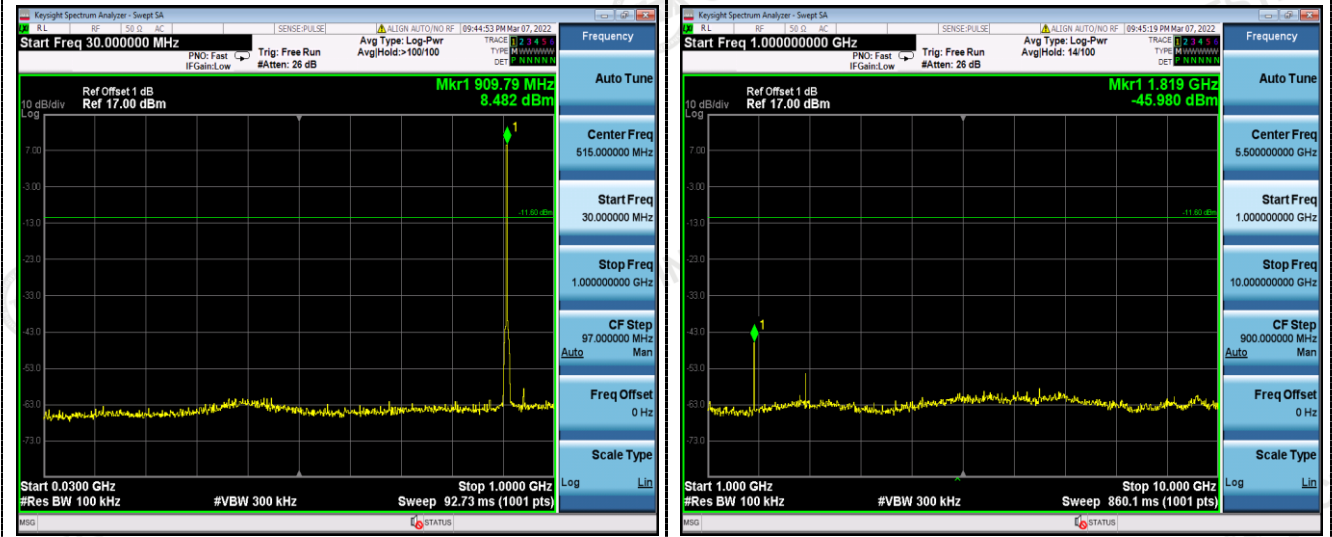

CH68



CH71

Band-edge Measurements for RF Conducted Emissions:

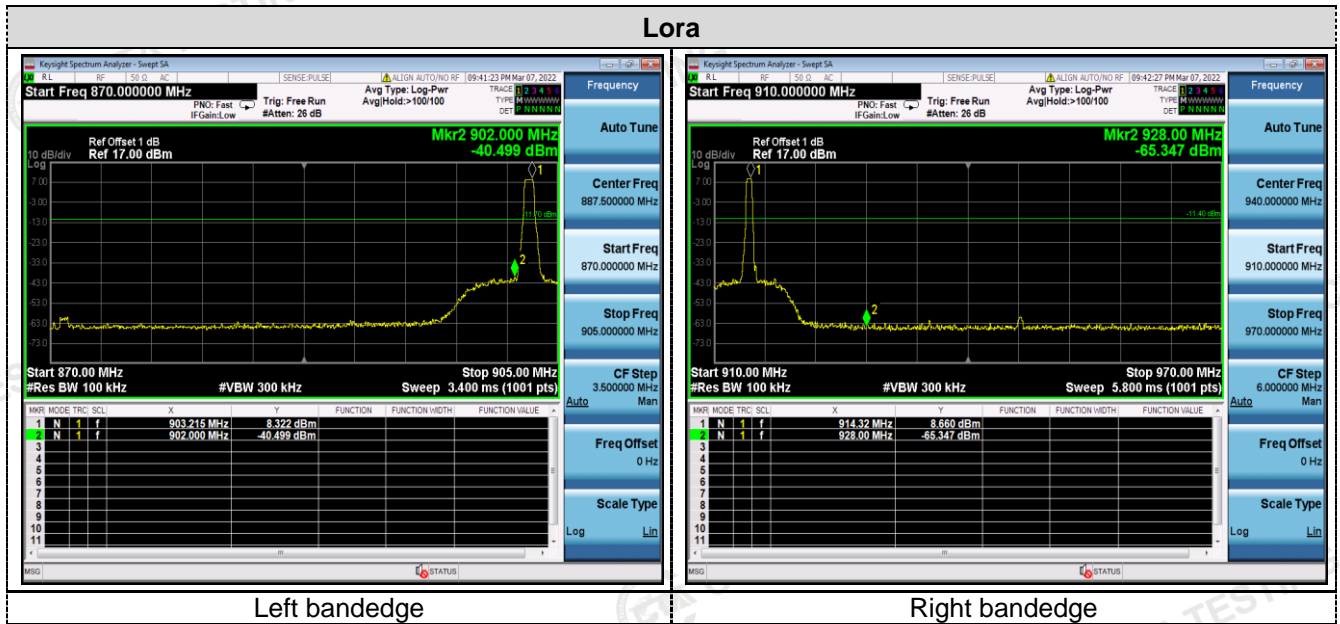

4.8 Antenna Requirement

Standard Applicable

For intentional device, according to FCC 47 CFR Section 15.203:

An intentional radiator shall be designed to ensure that no antenna other than that furnished by the responsible party shall be used with the device. The use of a permanently attached antenna or of an antenna that uses a unique coupling to the intentional radiator, the manufacturer may design the unit so that a broken antenna can be replaced by the user, but the use of a standard antenna jack or electrical connector is prohibited

FCC CFR Title 47 Part 15 Subpart C Section 15.247(c) (1) (I):

(i) Systems operating in the 2400-2483.5 MHz band that is used exclusively for fixed. Point-to-point operations may employ transmitting antennas with directional gain greater than 6dBi provided the maximum conducted output power of the intentional radiator is reduced by 1 dB for every 3 dB that the directional gain of the antenna exceeds 6dBi.

Antenna Connected Construction

The maximum gain of antenna was 1.0dBi.

5 Test Setup Photos of the EUT

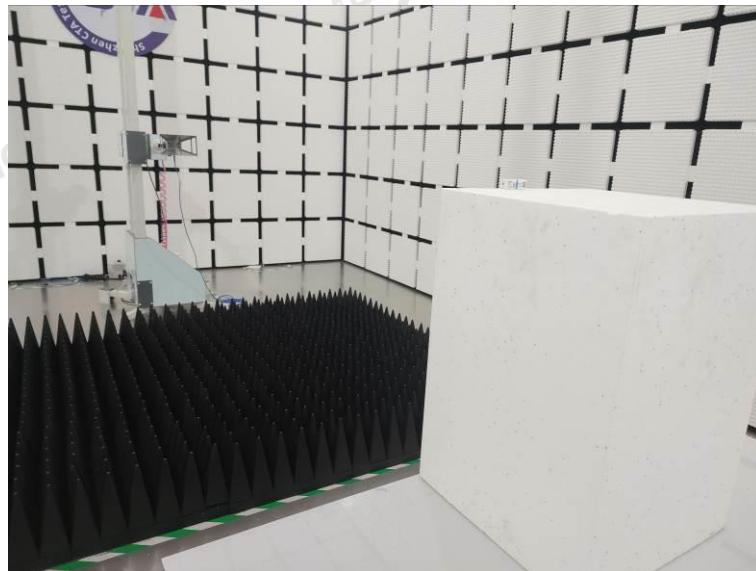
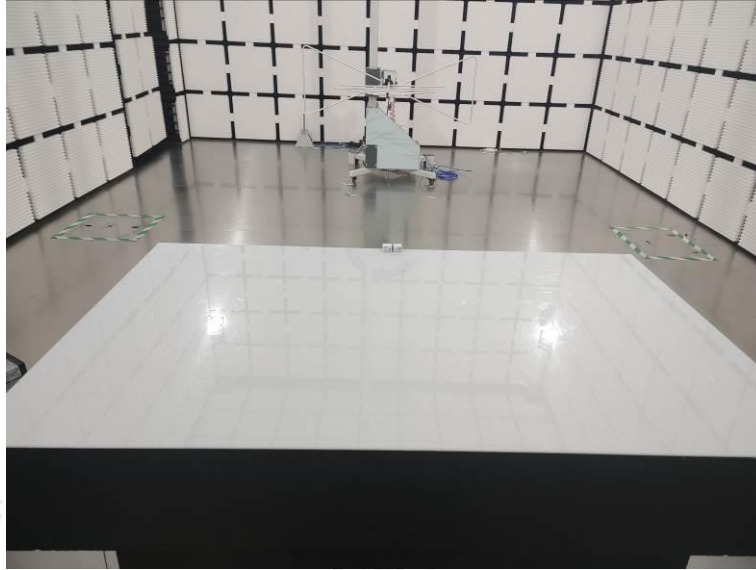

6 Photos of the EUT

Reference to the test report No. CTA22032100701.

***** End of Report *****