

FCC RADIO TEST REPORT

FCC 47 CFR PART 15 SUBPART C

Test Standard : FCC Part 15.231
Product name : WUS Sens.It Fox
Model No. : 030111
Trade name : Alligator Sens.it
Operation Freq. : TX: 314.97MHz & 433.92MHz
RX: 125kHz
Test Result : Pass
Statements of Conformity : Determination of compliance is based on the results of the compliance measurement, not taking into account measurement instrumentation uncertainty.

The test Result was tested by Compliance Certification Services Inc. The test data, data evaluation, test procedures, and equipment configurations shown in this report were given in ANSI C63.10: 2013 and compliance standards.

The test results of this report relate only to the tested sample (EUT) identified in this report.

The test Report of full or partial shall not copy. Without written approval of SGS Compliance Certification Services Inc. (Wugu Laboratory)

Approved by:



Dally Hong
Sr. Engineer

Unless otherwise stated the results shown in this test report refer only to the sample(s) tested and such sample(s) are retained for 90 days only.
除非另有說明，此報告結果僅對測試之樣品負責，同時此樣品僅保留90天。本報告未經本公司書面許可，不可部份複製。

This document is issued by the Company subject to its General Conditions of Service printed overleaf, available on request or accessible at <http://www.sgs.com.tw/Terms-and-Conditions> and, for electronic format documents, subject to Terms and Conditions for Electronic Documents at <http://www.sgs.com.tw/Terms-and-Conditions>. Attention is drawn to the limitation of liability, indemnification and jurisdiction issues defined therein. Any holder of this document is advised that information contained hereon reflects the Company's findings at the time of its intervention only and within the limits of client's instruction, if any. The Company's sole responsibility is to its Client and this document does not exonerate parties to a transaction from exercising all their rights and obligations under the transaction documents. This document cannot be reproduced, except in full, without prior written approval of the Company. Any unauthorized alteration, forgery or falsification of the content or appearance of this document is unlawful and offenders may be prosecuted to the fullest extent of the law.

Revision History

Rev.	Issue Date	Revisions	Effect Page	Revised By
00	September 18, 2024	Initial Issue	ALL	Allison Chen

Table of contents

1.	GENERAL INFORMATION	4
1.1	EUT INFORMATION	4
1.2	EUT CHANNEL INFORMATION	6
1.3	ANTENNA INFORMATION	6
1.4	MEASUREMENT UNCERTAINTY	7
1.5	FACILITIES AND TEST LOCATION	8
1.6	INSTRUMENT CALIBRATION.....	9
1.7	SUPPORT AND EUT ACCESSORIES EQUIPMENT	10
1.8	TEST METHODOLOGY AND APPLIED STANDARDS	10
2.	TEST SUMMARY	11
3.	DESCRIPTION OF TEST MODES	12
3.1	THE WORST MODE OF OPERATING CONDITION	12
3.2	THE WORST MODE OF MEASUREMENT	12
3.3	FCC PART 15.205 RESTRICTED BANDS OF OPERATIONS	13
3.4	EUT DUTY CYCLE.....	15
4.	TEST RESULT	18
4.1	AC POWER LINE CONDUCTED EMISSION	18
4.2	EMISSION BANDWIDTH	19
4.3	FIELD STRENGTH OF FUNDAMENTAL.....	22
4.4	RADIATION UNWANTED EMISSION.....	37
4.5	OPERATION RESTRICTION	66
4.6	ANTENNA REQUIREMENT	70
APPENDIX 1 – PHOTOGRAPHS OF EUT		

1. GENERAL INFORMATION

1.1 EUT INFORMATION

Applicant	Wegmann Automotive GmbH Rudolf-Diesel-Str.6 97209 Veitshoechheim Germany
Manufacturer	LID Technologies S.A.S. 3 rue GIOTTO Parc Technologique du canal, Ramonville-Saint-Agne, France 31520
Factory	SVI Public Company Limited 141-142 Moo 5 Bangkadi Industrial Park, Tiwanon Road Bangkadi, Muang, Pathumthani 12000 Thailand
Equipment	WUS Sens.It Fox
Trade Name	Alligator Sens.it
Model No.	030111
Model Discrepancy	N/A
Received Date	July 1, 2024
Date of Test	July 11 ~ 31, 2024
Periodic operation	<input type="checkbox"/> (1) A manually operated transmitter shall employ a switch that will automatically deactivate the transmitter within not more than 5 seconds of being released. <input type="checkbox"/> (2) A transmitter activated automatically shall cease transmission within 5 seconds after activation <input type="checkbox"/> (3) Periodic transmissions at regular predetermined intervals are not permitted. <input checked="" type="checkbox"/> (4) Periodic transmissions (lower field strength): each transmission is not greater than 1 sec and the silent period between transmissions is at least 30 times the duration of the transmission but in no case less than 10 sec.

Power Operation	Power from Host System: DC 3V
Operation Frequency	TX: 314.97MHz & 433.92MHz RX: 125kHz
H/W Version	321-142-1090
S/W Version	C11116010161, C14109010161, C15061010161, C22067010161, C22068010161, C22069010161

Remark:

1. For more details, please refer to the User's manual of the EUT.
2. Disclaimer: Antenna information is provided by the applicant, test results of this report are applicable to the sample EUT received.
3. Disclaimer: Variant information between/among model numbers / trademarks are provided by the applicant, test results of this report are applicable to the sample EUT received of main test model name.
4. There are 2 variants/types included. The only difference is the shape of the housing: Clamp-in type & Snap-in type.

1.2 EUT CHANNEL INFORMATION

Frequency Range	TX: 314.97MHz & 433.92MHz RX: 125kHz
-----------------	---

Transmission parameters

		Burst			
Config	Coding	Baudrate (bps +/-5%)	Emission period (s)	Number of frames in burst	
315 MHz	E814_homologation_315.bat	Manchester	9600	16	4
	9214_homologation_315.bat	Manchester	4096	16	6
	EC01_homologation_315.bat	Manchester	19200	16	3
434 MHz	E814_homologation_315.bat	Manchester	9600	16	4
	9214_homologation_315.bat	Manchester	4096	16	6
	EC01_homologation_315.bat	Manchester	19200	16	3

		Preamble				
Config	Center frequency	Modulation	Deviation	Preamble Time (ms)	Inter-preamble time (ms)	
315 MHz	E814_homologation_315.bat	314.93	ASK	/	50	112
	9214_homologation_315.bat	/	/	/	/	/
	EC01_homologation_315.bat	314.97	FSK	25KHz	25	105
434 MHz	E814_homologation_434.bat	433.86	ASK	/	50	112
	9214_homologation_434.bat	/	/	/	/	/
	EC01_homologation_434.bat	433.92	FSK	25KHz	25	105

		Frame				
Config	Center frequency	Modulation	Deviation	Frame time (ms)	Inter frame time (ms)	
315 MHz	E814_homologation_315.bat	314.97	FSK	50KHz	10.3	96-120
	9214_homologation_315.bat	314.97	ASK	/	16.8	80-140
	EC01_homologation_315.bat	314.97	FSK	25KHz	5.4	98-123
434 MHz	E814_homologation_434.bat	433.92	FSK	40KHz	10.3	96-120
	9214_homologation_434.bat	433.92	ASK	/	16.8	80-140
	EC01_homologation_434.bat	433.92	FSK	25KHz	5.4	98-123

RF transmissions are composed of 4 FRAMEs and each group of frames is called a "BURST". Below you can find a diagram which illustrates the burst and frame structure, in this example we can see 2 bursts of 4 frames.



Note: When ASK modulation is used only RF on time must be taken into account in the calculation transmission time

Remark:

Refer as ANSI 63.10:2013 clause 5.6.1 Table 4 for test channels

Number of frequencies to be tested		
Frequency range in which device operates	Number of frequencies	Location in frequency range of operation
<input checked="" type="checkbox"/> 1 MHz or less	1	Middle
<input type="checkbox"/> 1 MHz to 10 MHz	2	1 near top and 1 near bottom
<input type="checkbox"/> More than 10 MHz	3	1 near top, 1 near middle, and 1 near bottom

1.3 ANTENNA INFORMATION

Antenna Type	<input type="checkbox"/> PIFA <input type="checkbox"/> PCB <input type="checkbox"/> Dipole <input type="checkbox"/> Coils <input checked="" type="checkbox"/> Other: LOOP SMD Dual Frequency
Antenna Gain	314.97 MHz: Gain: -31 dBi 433.92 MHz: Gain: -24 dBi
Brand / Model	Brand: OMON, Model: 090390000-B0
Antenna Connector	N/A

Notes:

1. The antenna(s) of the EUT are permanently attached and there are no provisions for connection to an external antenna. So the EUT complies with the requirements of §15.203.

1.4 MEASUREMENT UNCERTAINTY

PARAMETER	UNCERTAINTY
AC Powerline Conducted Emission	± 2.213 dB
Channel Bandwidth	± 2.7 %
Radiated Emission_9kHz-30MHz	± 3.761 dB
Radiated Emission_30MHz-200MHz	± 3.473 dB
Radiated Emission_200MHz-1GHz	± 3.946 dB
Radiated Emission_1GHz-6GHz	± 4.797 dB

Remark:

- 1.This uncertainty represents an expanded uncertainty expressed at approximately the 95% confidence level using a coverage factor of k=2
2. ISO/IEC 17025 requires that an estimate of the measurement uncertainties associated with the emissions test results be included in the report.

1.5 FACILITIES AND TEST LOCATION

All measurement facilities used to collect the measurement data are located at No.11, Wugong 6th Rd., Wugu Dist., New Taipei City, Taiwan.

CAB identifier: TW1309

Test site	Test Engineer	Remark
AC Conduction Room	N/A	Not applicable, because EUT doesn't connect to AC Main Source direct.
Radiation	Tony Chao	-
RF Conducted	Jerry Chang	-

Remark: The lab has been recognized as the FCC accredited lab. under the KDB 974614 D01 and is listed in the FCC public Access Link (PAL) database, FCC Registration No. :444940, the FCC Designation No.:TW1309

1.6 INSTRUMENT CALIBRATION

966A_Radiated					
Name of Equipment	Manufacturer	Model	Serial Number	Calibration Date	Calibration Due
Signal Analyzer	KEYSIGHT	N9010A	MY52220817	2024-03-15	2025-03-14
Thermo-Hygro Meter	WISEWIND	1206	D07	2023-12-08	2024-12-07
Active Loop Antenna	SCHWARZBECK	FMZB 1513-60	1513-60-028	2023-12-13	2024-12-12
Bi-Log Antenna	Sunol Sciences	JB3	A030105	2024-07-12	2025-07-11
Preamplifier	EMEC	EM330	060609	2024-02-21	2025-02-20
Cable	Huber+Suhner	104PEA	20995+21000+182330	2024-02-21	2025-02-20
Horn Antenna	ETC	MCTD 1209	DRH13M02003	2023-12-28	2024-12-27
Preamplifier	HP	8449B	3008A00965	2023-12-22	2024-12-21
Cable	EMCI	EMC101G	221213+221011+221012	2023-10-17	2024-10-16
Horn Antenna	SCHWARZBECK	BBHA9170	1047	2023-12-13	2024-12-12
Pre-Amplifier	EMCI	EMC184045SE	980860	2023-12-12	2024-12-11
Turn Table	CCS	CC-T-1F	N/A	N.C.R	N.C.R
Controller	CCS	CC-C-1F	N/A	N.C.R	N.C.R
Antenna Tower	CCS	CC-A-1F	N/A	N.C.R	N.C.R
Software	e3 V9-210616c				

Conducted_CE					
Name of Equipment	Manufacturer	Model	Serial Number	Calibration Date	Calibration Due
Power Supply	GWINSTEK	SPS-3610	GPE880163	2023-11-16	2024-11-15
EXA Signal Analyzer	Keysight	N9010B	MY55460167	2024-01-03	2025-01-02
Software	N/A				

Remark:

1. Each piece of equipment is scheduled for calibration once a year.
2. N.C.R. = No Calibration Required.

1.7 SUPPORT AND EUT ACCESSORIES EQUIPMENT

Support Unit List						Remark
Name of Equipment	Manufacturer	Model	Serial Number	Calibration Date	Calibration Due	
NB(D)	Lenovo	ThinkPad X260	N/A	N/A	N/A	1
Adapter	Lenovo	ADLX45DLC3A	N/A	N/A	N/A	2
Programming Tool Unit (PTU)	N/A	N/A	N/A	N/A	N/A	A

Conducted						
Name of Equipment	Manufacturer	Model	Serial Number	Calibration Date	Calibration Due	Remark
NB(I)	Lenovo	X260	N/A	N/A	N/A	1
DC Power Cable	MISUMI	MCR3S-RE	N/A	N/A	N/A	2
Programming Tool	Alligator	N/A	N/A	N/A	N/A	A

1.8 TEST SETUP DIAGRAM

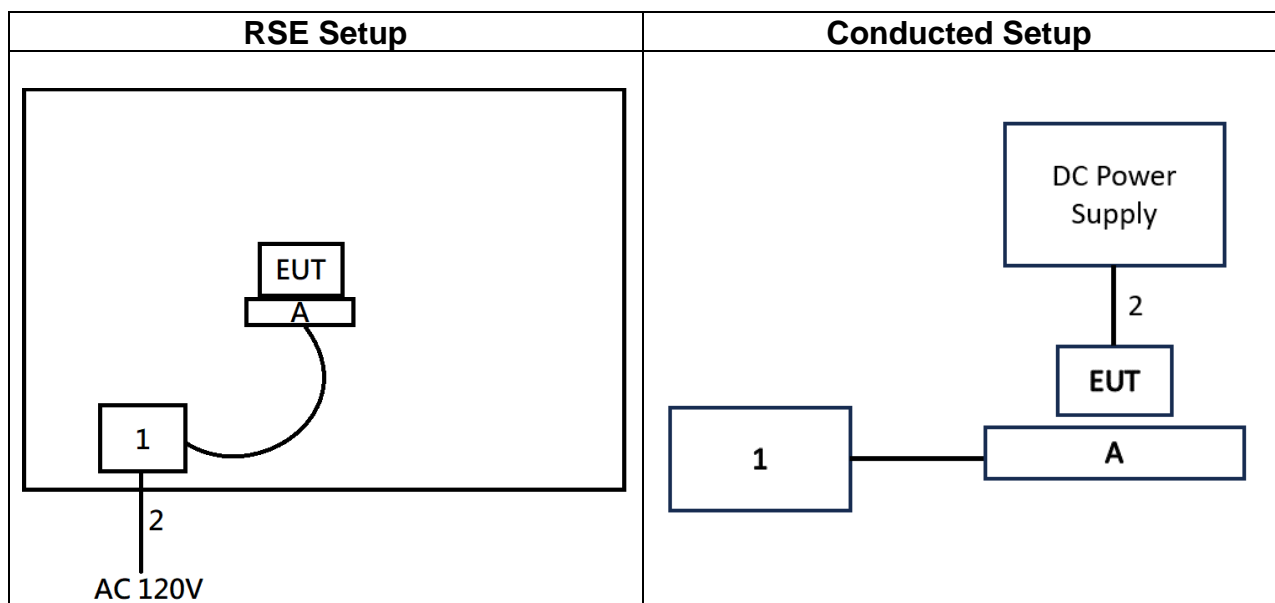

1.9 TEST METHODOLOGY AND APPLIED STANDARDS

The test methodology, setups and results comply with all requirements in accordance with ANSI C63.10:2013, FCC 15.231.

2. TEST SUMMARY

FCC Standard Sec.	Chapter	Test Item	Result
15.207	4.1	AC Power-line Conducted Emission	Not applicable
15.231(c)	4.2	Emission Bandwidth	Pass
15.231(e)	4.3	Fundamental Emission	Pass
15.209(b)	4.4	Transmitter Radiated Emission	Pass
15.231(e), 15.231(a)	4.5	Operation Restriction	Pass
15.203	4.6	Antenna Requirement	Pass

3. DESCRIPTION OF TEST MODES

3.1 THE WORST MODE OF OPERATING CONDITION

Operation mode	TX: 314.97MHz & 433.92MHz		
RF Field strength	TX 314.97MHz		
	Config	Peak (dBuv/m)	Average (dBuv/m)
	E814	77.00	62.67
	9214	79.04	63.60
	EC01	76.82	64.78
	TX 433.92MHz		
	Config	Peak (dBuv/m)	Average (dBuv/m)
	E814	81.81	67.48
	9214	81.95	66.51
	EC01	81.84	69.80

Remark: Field strength performed Average level at 3m.

3.2 THE WORST MODE OF MEASUREMENT

Radiated Emission Measurement Above 1G	
Test Condition	Radiated Emission Above 1G
Power supply Mode	Mode 1: EUT power by Host System
Worst Mode	<input checked="" type="checkbox"/> Mode 1 <input type="checkbox"/> Mode 2 <input type="checkbox"/> Mode 3 <input type="checkbox"/> Mode 4
Worst Position	<input type="checkbox"/> Placed in fixed position. <input checked="" type="checkbox"/> Placed in fixed position at X-Plane (E2-Plane) <input type="checkbox"/> Placed in fixed position at Y-Plane (E1-Plane) <input type="checkbox"/> Placed in fixed position at Z-Plane (H-Plane)
Radiated Emission Measurement Below 1G	
Test Condition	Radiated Emission Below 1G
Power supply Mode	Mode 1: EUT power by Host System
Worst Mode	<input checked="" type="checkbox"/> Mode 1 <input type="checkbox"/> Mode 2 <input type="checkbox"/> Mode 3 <input type="checkbox"/> Mode 4

Remark:

- The worst mode was record in this test report.
- EUT pre-scanned in three axis ,X,Y, Z and two polarity, for radiated measurement. The worst case(X-Plane) were recorded in this report
- 433.92MHz and 314.97MHz The following three configurations have been fully evaluated and tested:
 - E814_homologation_315.bat
 - 9214_homologation_315.bat
 - EC01_homologation_315.bat

3.3 FCC PART 15.205 RESTRICTED BANDS OF OPERATIONS

According to FCC 15.231(b), 15.231(e),

(b) In addition to the provisions of §15.205, the field strength of emissions from intentional radiators operated under this section shall not exceed the following:

Fundamental frequency (MHz)	Field strength of fundamental (microvolts/meter)	Field strength of spurious emissions (microvolts/meter)
40.66-40.70	2,250	225
70-130	1,250	125
130-174	¹ 1,250 to 3,750	¹ 125 to 375
174-260	3,750	375
260-470	¹ 3,750 to 12,500	¹ 375 to 1,250
Above 470	12,500	1,250

¹Linear interpolations.

(1) The above field strength limits are specified at a distance of 3 meters. The tighter limits apply at the band edges.

(2) Intentional radiators operating under the provisions of this section shall demonstrate compliance with the limits on the field strength of emissions, as shown in the above table, based on the average value of the measured emissions. As an alternative, compliance with the limits in the above table may be based on the use of measurement instrumentation with a CISPR quasi-peak detector. The specific method of measurement employed shall be specified in the application for equipment authorization. If average emission measurements are employed, the provisions in §15.35 for averaging pulsed emissions and for limiting peak emissions apply. Further, compliance with the provisions of §15.205 shall be demonstrated using the measurement instrumentation specified in that section.

(3) The limits on the field strength of the spurious emissions in the above table are based on the fundamental frequency of the intentional radiator. Spurious emissions shall be attenuated to the average (or, alternatively, CISPR quasi-peak) limits shown in this table or to the general limits shown in §15.209, whichever limit permits a higher field strength.

(e) Intentional radiators may operate at a periodic rate exceeding that specified in paragraph (a) of this section and may be employed for any type of operation, including operation prohibited in paragraph (a) of this section, provided the intentional radiator complies with the provisions of paragraphs (b) through (d) of this section, except the field strength table in paragraph (b) of this section is replaced by the following:

Fundamental frequency (MHz)	Field strength of fundamental (microvolts/meter)	Field strength of spurious emissions (microvolts/meter)
40.66-40.70	1,000	100
70-130	500	50
130-174	500 to 1,500 ¹	50 to 150 ¹
174-260	1,500	150
260-470	1,500 to 5,000 ¹	150 to 500 ¹
Above 470	5,000	500

¹Linear interpolations.

In addition, devices operated under the provisions of this paragraph shall be provided with a means for automatically limiting operation so that the duration of each transmission shall not be greater than one second and the silent period between transmissions shall be at least 30 times the duration of the transmission but in no case less than 10 seconds.

3.4 EUT DUTY CYCLE

Temperature: 21.8°C
 Humidity: 56% RH

Test Date: July 11, 2024
 Tested by: Jerry Chang

(1) Config: E814

Duty Cycle			
TX ON (ms)	TX All(ms)	Duty Cycle (%)	Duty Factor(dB)
19.20	100.00	0.19	-14.33

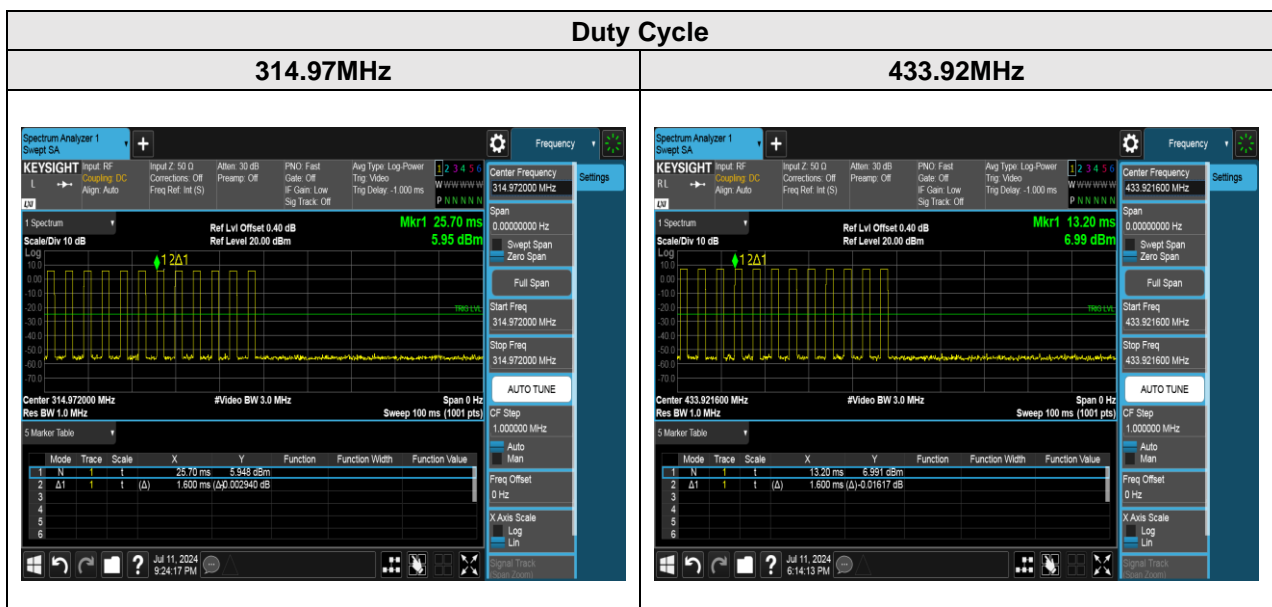

Notes:

1. The transmitter duty cycle was measured using a spectrum analyser in the time domain and calculated by $20 \log(\text{Time(on)} / [\text{Period or } 100 \text{ ms whichever is the lesser}])$
2. The EUT transmits for a Time(on) of 19.2 milliseconds within the specified 100ms period.

$20 \log(\text{Time(on)} / [\text{Period or } 100 \text{ ms whichever is the lesser}])$
 $20 \log(19.2 / 100) = -14.33 \text{ dB}$

(2) Config: 9214

Duty Cycle			
TX ON (ms)	TX All(ms)	Duty Cycle (%)	Duty Factor(dB)
16.90	100.00	0.17	-15.44

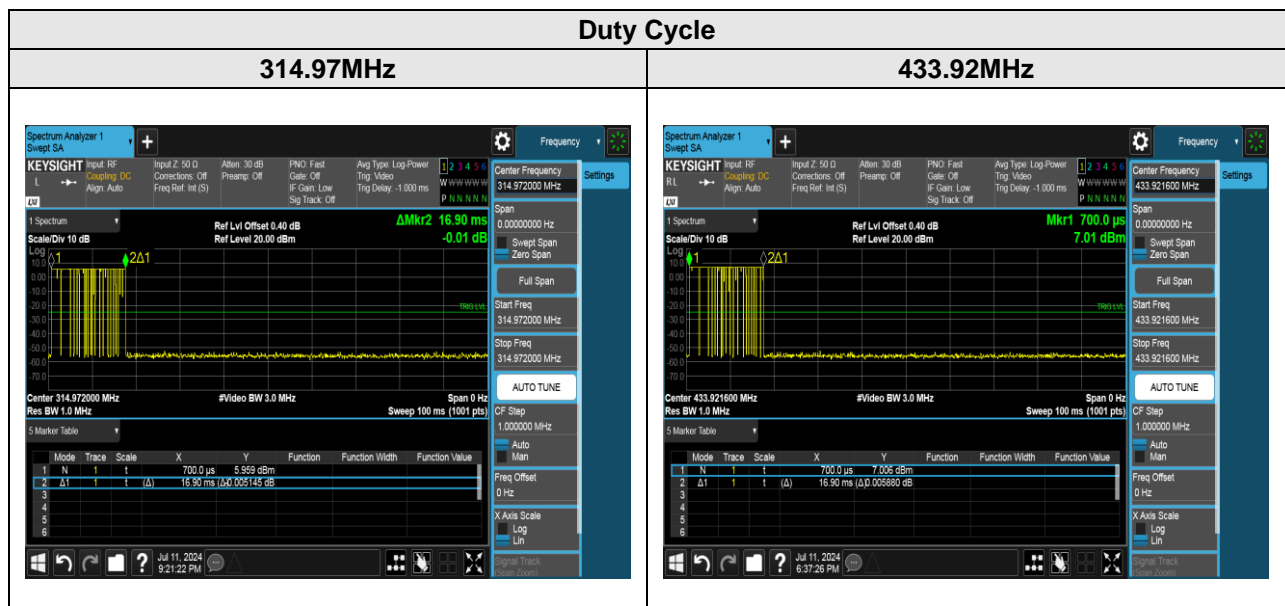

Notes:

1. The transmitter duty cycle was measured using a spectrum analyser in the time domain and calculated by $20 \log(\text{Time(on)} / [\text{Period or } 100 \text{ ms whichever is the lesser}])$
2. The EUT transmits for a Time(on) of 16.9 milliseconds within the specified 100ms period.

$$20 \log(\text{Time(on)} / [\text{Period or } 100 \text{ ms whichever is the lesser}]).$$

$$20 \log(16.9 / 100) = -15.44 \text{ dB}$$

(3) Config: EC01

Duty Cycle			
TX ON (ms)	TX All(ms)	Duty Cycle (%)	Duty Factor(dB)
25.00	100.00	0.25	-12.04

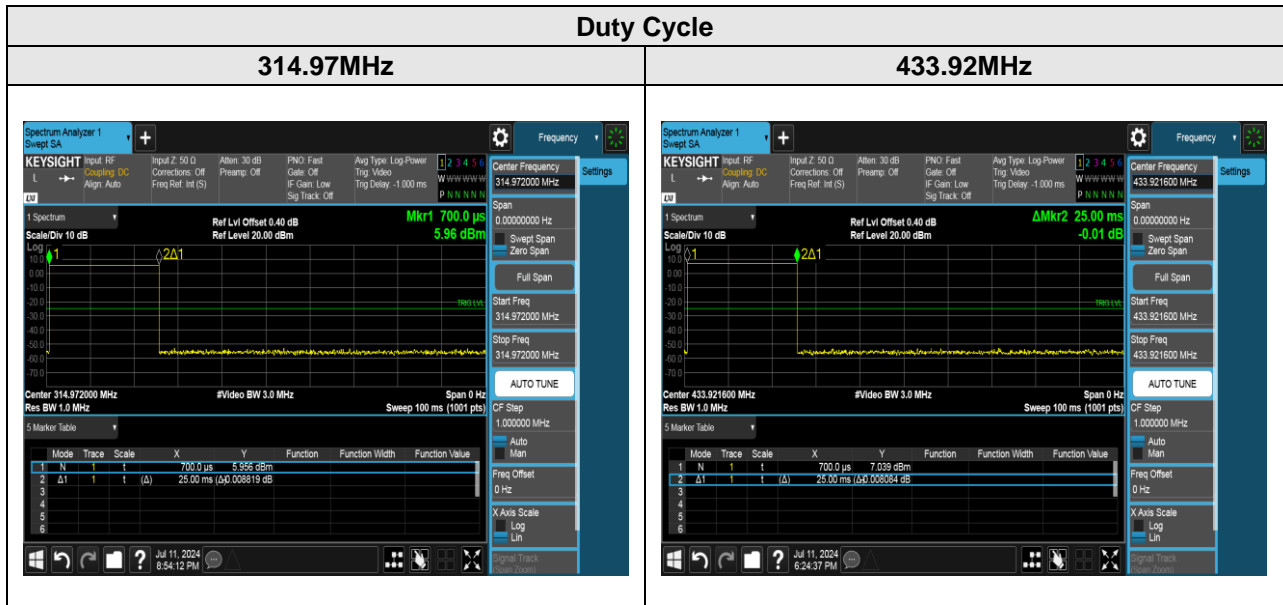

Notes:

1. The transmitter duty cycle was measured using a spectrum analyser in the time domain and calculated by $20 \log(\text{Time(on)} / [\text{Period or } 100 \text{ ms whichever is the lesser}])$
2. The EUT transmits for a Time(on) of 25 milliseconds within the specified 100ms period.

$20 \log(\text{Time(on)} / [\text{Period or } 100 \text{ ms whichever is the lesser}])$
 $20 \log(25 / 100) = -12.04 \text{ dB}$

4. TEST RESULT

4.1 AC POWER LINE CONDUCTED EMISSION

4.1.1 Test Limit

According to §15.207(a),

Frequency Range (MHz)	Limits(dBµV)	
	Quasi-peak	Average
0.15 to 0.50	66 to 56*	56 to 46*
0.50 to 5	56	46
5 to 30	60	50

* Decreases with the logarithm of the frequency.

4.1.2 Test Procedure

Test method Refer as ANSI 63.10:2013 clause 6.2,

1. The EUT was placed on a table, which is 0.8m above ground plane.
2. Maximum procedure was performed on the six highest emissions to ensure EUT compliance.
3. Repeat above procedures until all frequency measured were complete

4.1.3 Test Setup

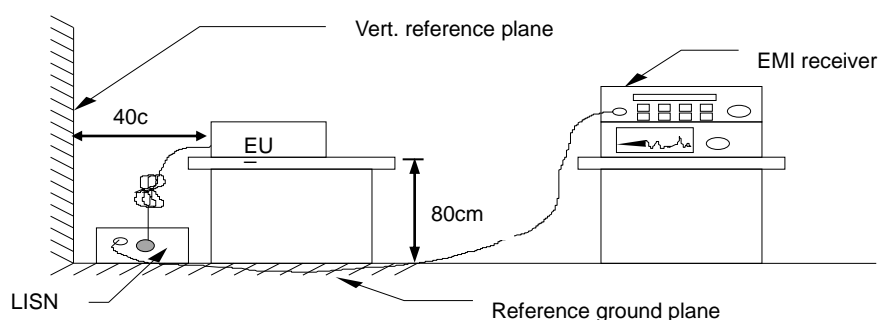

4.1.4 Test Result

Not applicable, because EUT doesn't connect to AC Main Source direct.

4.2 EMISSION BANDWIDTH

4.2.1 Test Limit

According to §15.231(c),

Limit	<input checked="" type="checkbox"/> 70 MHz – 900 MHz : $F_c * 0.25 \%$ <input type="checkbox"/> Above 900 MHz : $F_c * 0.5 \%$
-------	---

4.2.2 Test Procedure

Test method Refer as ANSI 63.10:2013 clause 6.9.2,

SA set RBW = 1% ~ 5% OBW, VBW = three times the RBW and Detector = Peak, Trace mode = Max hold, Sweep = Auto. Measure the maximum width of the emission that is constrained by the frequencies associated with the Occupied Bandwidth (99%) and 20dB Bandwidth.

4.2.3 Test Setup

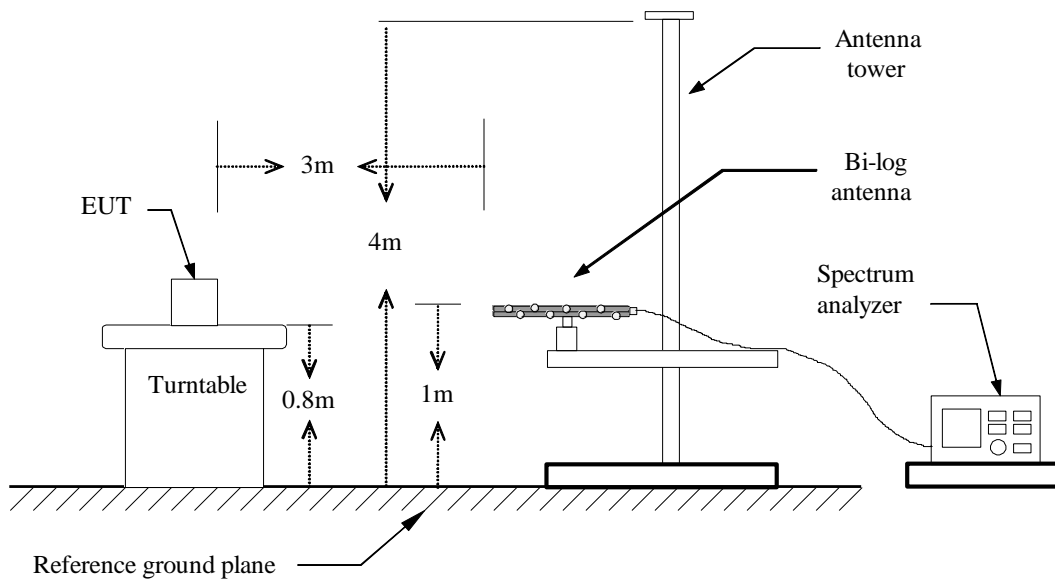

4.2.4 Test Result

Temperature: 21.8°C

Test Date: July 11, 2024

Humidity: 56% RH

Tested by: Jerry Chang

Spectrum Bandwidth					
Frequency (MHz)	Config	20dB Bandwidth (KHz)	20dB Bandwidth Limits (KHz)	99% Occupied BW (KHz)	99% Bandwidth Limits (KHz)
314.97	E814	136.8	797.425	138.22	797.425
	9214	26.15	797.425	56.918	797.425
	EC01	136.6	797.425	118.04	797.425
433.92	E814	106.9	1084.8	135.17	1084.8
	9214	25.87	1084.8	44.763	1084.8
	EC01	116.3	1084.8	109.51	1084.8

Test Data

20dB Bandwidth and 99% Occupied BW

314.97MHz

433.92MHz

(1) Config: E814

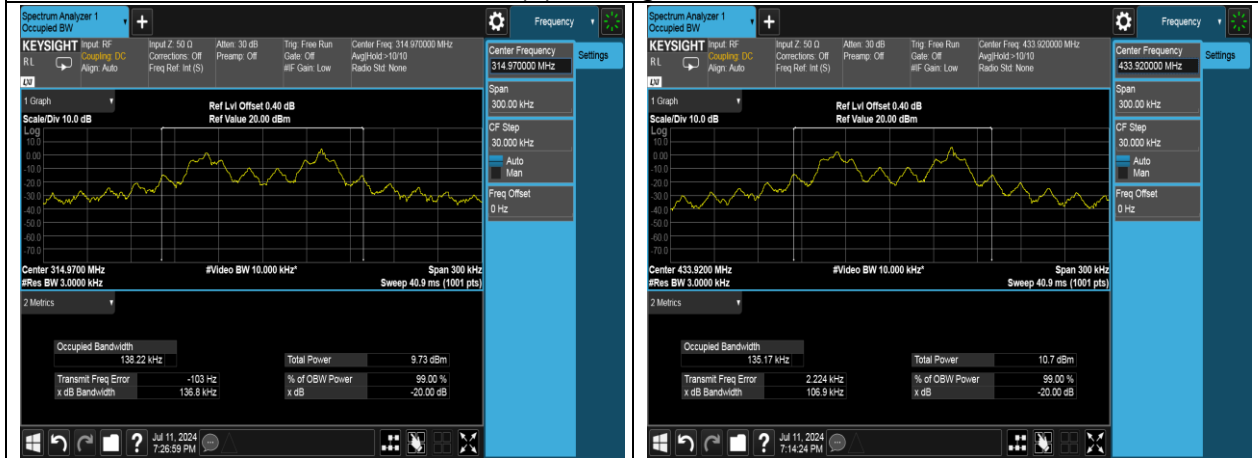

(2) Config: 9214

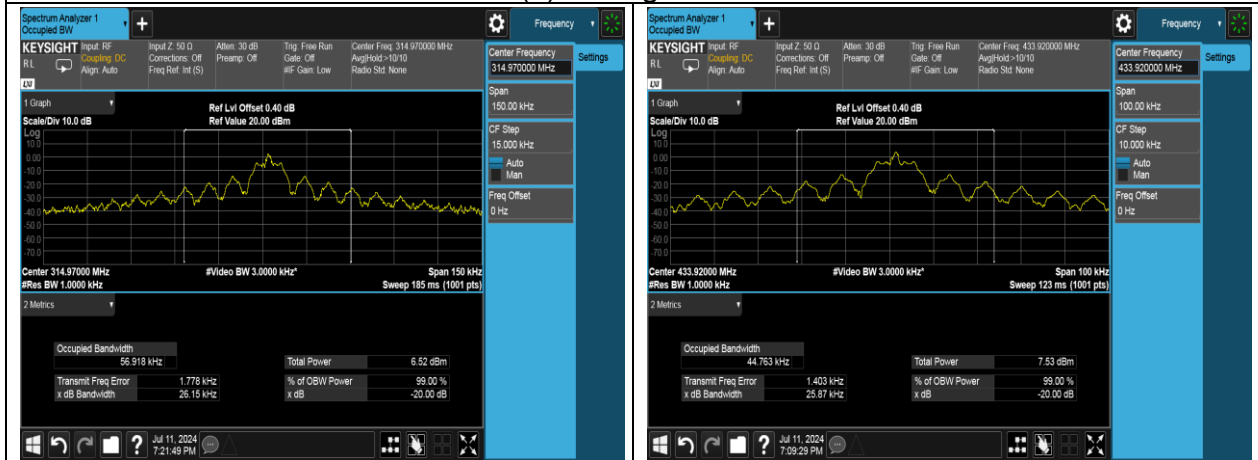

(3) Config: EC01

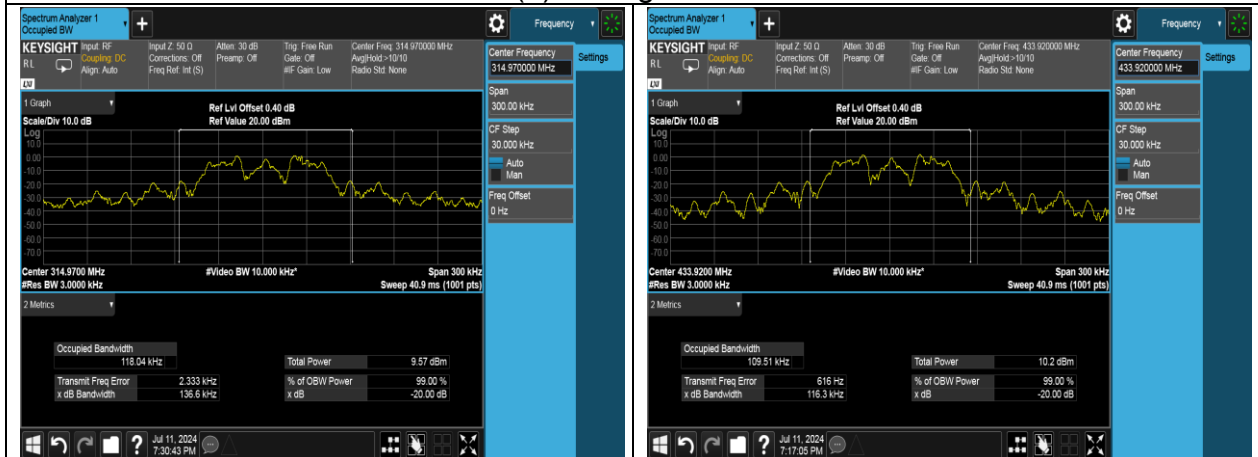

4.3 FIELD STRENGTH OF FUNDAMENTAL

4.3.1 Test Limit

According to §15.231(e)

Fundamental frequency (MHz)	Field strength of fundamental (microvolts/meter)	Field strength of spurious emissions (microvolts/meter)
40.66-40.70	1,000	100
70-130	500	50
130-174	500 to 1,500 ¹	50 to 150 ¹
174-260	1,500	150
260-470	1,500 to 5,000 ¹	150 to 500 ¹
Above 470	5,000	500

* Linear interpolation with frequency, f, in MHz:

For 130-174 MHz: Field Strength (µV/m) = (22.73 x f)-2454.55

For 260-470 MHz: Field Strength (µV/m) = (16.67 x f)-2833.33

4.3.2 Test Procedure

Test method Refer as ANSI 63.10:2013 clause 4.1.4 and clause 6.5

clause 4.1.4	<input checked="" type="checkbox"/> 4.1.4.2.2: Measurement Peak value. <input type="checkbox"/> 4.1.4.2.3: Duty cycle ≥ 100%. <input checked="" type="checkbox"/> 4.1.4.2.4: Measurement Average value.
--------------	---

4.3.3 Test Setup

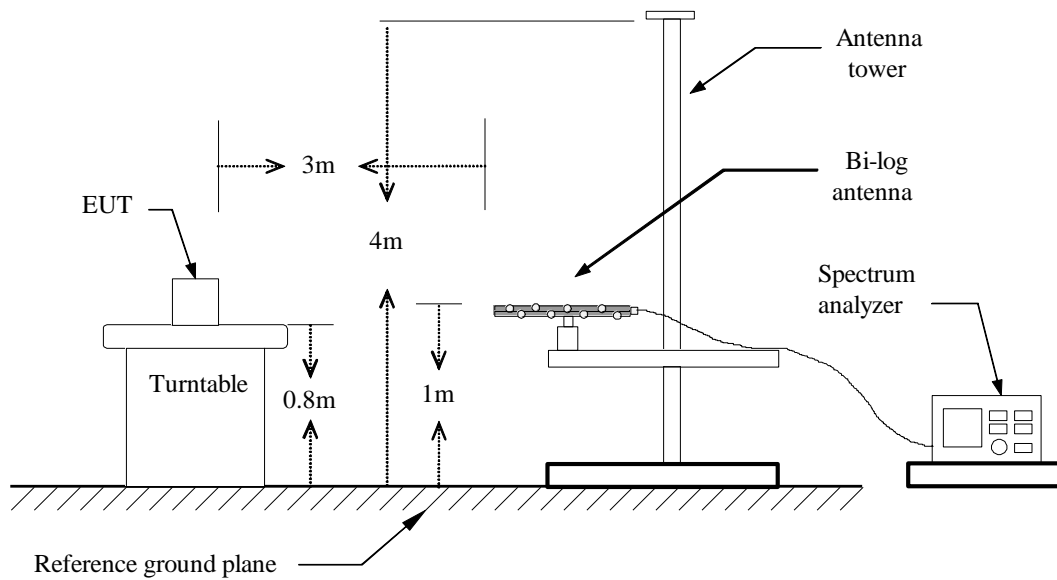

4.3.4 Test Result

Field Strength						
Frequency (MHz)	Config	Fundamental (dBuV/m) at 3m	Limit (dBuV/m) at 3m	Margin (dB)	Axis/Pol.	Remark
314.97	E814	62.67	67.66	-4.99	X/V	AVG
	9214	63.60	67.66	-4.06	X/H	AVG
	EC01	64.78	67.66	-2.88	X/H	AVG

Remark:

1. Fundamental measured method setting on spectrum, RBW=100 kHz, VBW=100kHz and Detector=Peak.
2. Average result = Peak result + Duty factor.
3. 260MHz ~ 470MHz limit is $16.67 * (\text{Frequency, MHz}) - 2833.3333$
 $\text{Limit} = 16.67 * (314.97 \text{ MHz}) - 2833.3333$
 $= 2417.2166 \text{ (uV/m)}$
 $\text{dBuV/m} = 20 \text{ Log (uV/m)} = 20 \text{ Log (2417.2166 uV/m)} = 67.66 \text{ dBuV/m}$

Field Strength						
Frequency (MHz)	Config	Fundamental (dBuV/m) at 3m	Limit (dBuV/m) at 3m	Margin (dB)	Axis/Pol.	Remark
433.92	E814	67.48	72.87	-5.37	X/V	AVG
	9214	66.51	72.87	-6.36	X/V	AVG
	EC01	69.80	72.87	-3.07	X/V	AVG

Remark:

1. Fundamental measured method setting on spectrum, RBW=100 kHz, VBW=100kHz and Detector=Peak.
2. Average result = Peak result + Duty factor.
3. 260MHz ~ 470MHz limit is $16.67 * (\text{Frequency, MHz}) - 2833.3333$
 $\text{Limit} = 16.67 * (433.92 \text{ MHz}) - 2833.3333$
 $= 4400.1131 \text{ (uV/m)}$
 $\text{dBuV/m} = 20 \text{ Log (uV/m)} = 20 \text{ Log (4400.1131 uV/m)} = 72.87 \text{ dBuV/m}$

Test Data

1. 314.97MHz (1) Config: E814

Project No	:TM-2406000275P	Test Date	:2024-07-30
Operation Band	:314.97 MHz	Temp./Humi.	:24.6/57
Frequency	:314.97 MHz	Antenna Pol.	:VERTICAL
Operation Mode	:Main	Engineer	:Tony.Chao
EUT Pol	:E2	Test Chamber	: 966A
Setting	:EUT111 & E814		

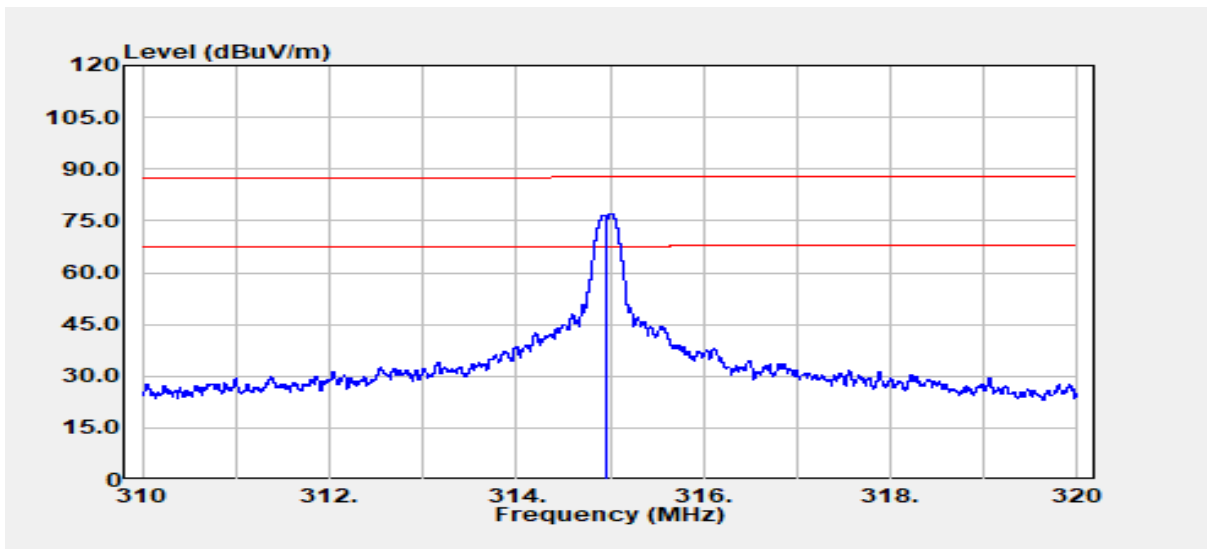

Freq. MHz	Detector Mode PK/QP/AV	Spectrum Read Level dB μ V	Factor dB	Actual FS dB μ V/m	Limit dB μ V/m	Margin dB
314.97	Peak	85.03	-8.03	77.00	87.66	-10.66
314.97	Average	--	-14.33	62.67	67.66	-4.99

(1) Config: E814

Project No	:TM-2406000275P	Test Date	:2024-07-30
Operation Band	:314.97 MHz	Temp./Humi.	:24.6/57
Frequency	:314.97 MHz	Antenna Pol.	:HORIZONTAL
Operation Mode	:Main	Engineer	:Tony.Chao
EUT Pol	:E2	Test Chamber	: 966A
Setting	:EUT111 & E814		

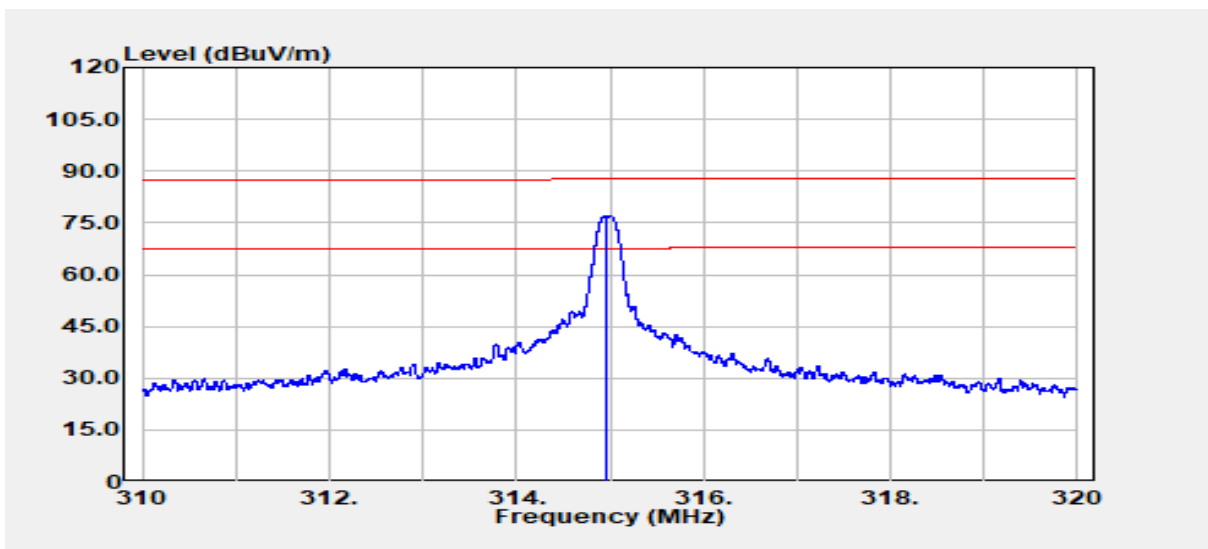

Freq. MHz	Detector Mode PK/QP/AV	Spectrum Read Level dB μ V	Factor dB	Actual FS dB μ V/m	Limit dB μ V/m	Margin dB
314.97	Peak	84.92	-8.03	76.89	87.66	-10.77
314.97	Average	--	-14.33	62.56	67.66	-5.10

(2) Config: 9214

Project No	:TM-2406000275P	Test Date	:2024-07-30
Operation Band	:314.97 MHz	Temp./Humi.	:24.6/57
Frequency	:314.97 MHz	Antenna Pol.	:VERTICAL
Operation Mode	:Main	Engineer	:Tony.Chao
EUT Pol	:E2	Test Chamber	: 966A
Setting	:EUT111 & 9214		

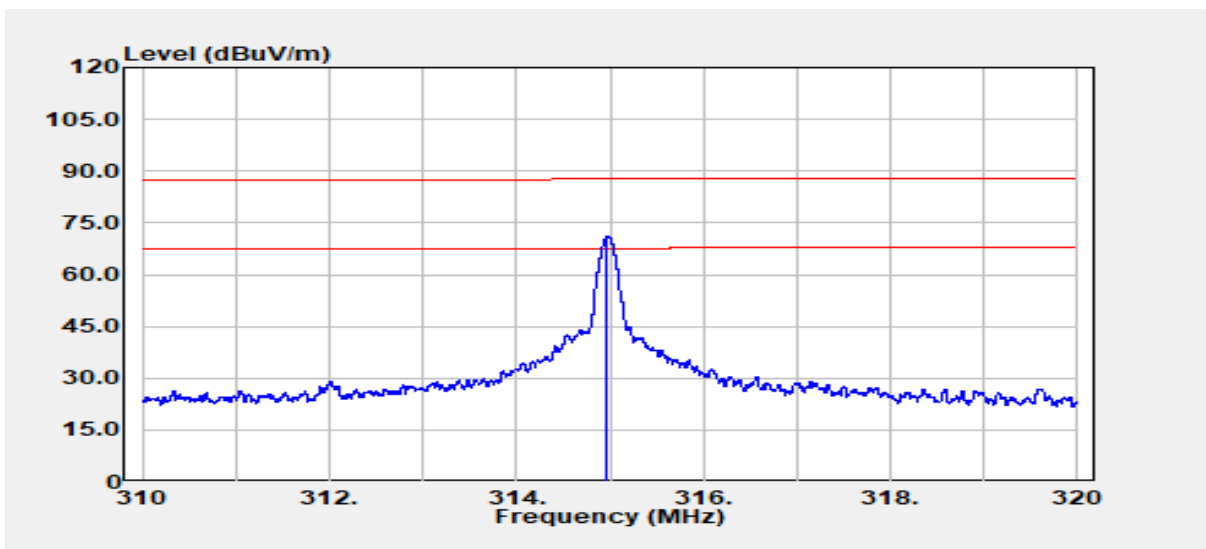

Freq. MHz	Detector Mode PK/QP/AV	Spectrum Read Level dB μ V	Factor dB	Actual FS dB μ V/m	Limit dB μ V/m	Margin dB
314.97	Peak	79.10	-8.03	71.06	87.66	-16.59
314.97	Average	--	-15.44	55.62	67.66	-12.03

(2) Config: 9214

Project No	:TM-2406000275P	Test Date	:2024-07-30
Operation Band	:314.97 MHz	Temp./Humi.	:24.6/57
Frequency	:314.97 MHz	Antenna Pol.	:HORIZONTAL
Operation Mode	:Main	Engineer	:Tony.Chao
EUT Pol	:E2	Test Chamber	: 966A
Setting	:EUT111 & 9214		

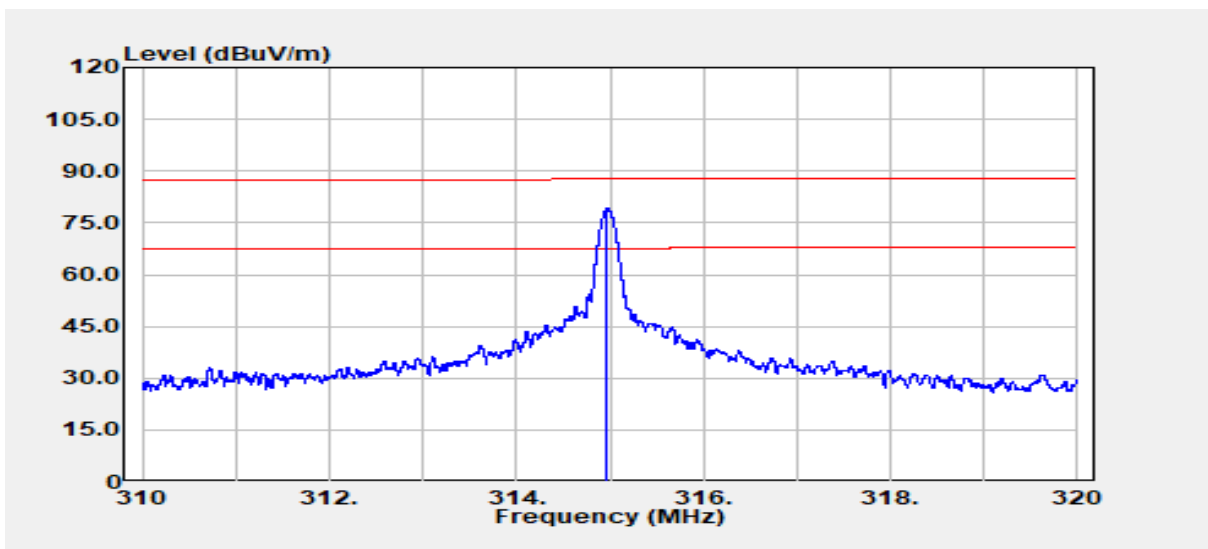

Freq. MHz	Detector Mode PK/QP/AV	Spectrum Read Level dB μ V	Factor dB	Actual FS dB μ V/m	Limit dB μ V/m	Margin dB
314.97	Peak	87.07	-8.03	79.04	87.66	-8.62
314.97	Average	--	-15.44	63.60	67.66	-4.06

(3) Config: EC01

Project No	:TM-2406000275P	Test Date	:2024-07-30
Operation Band	:314.97 MHz	Temp./Humi.	:24.6/57
Frequency	:314.97 MHz	Antenna Pol.	:VERTICAL
Operation Mode	:Main	Engineer	:Tony.Chao
EUT Pol	:E2	Test Chamber	: 966A
Setting	:EUT111 & EC01		

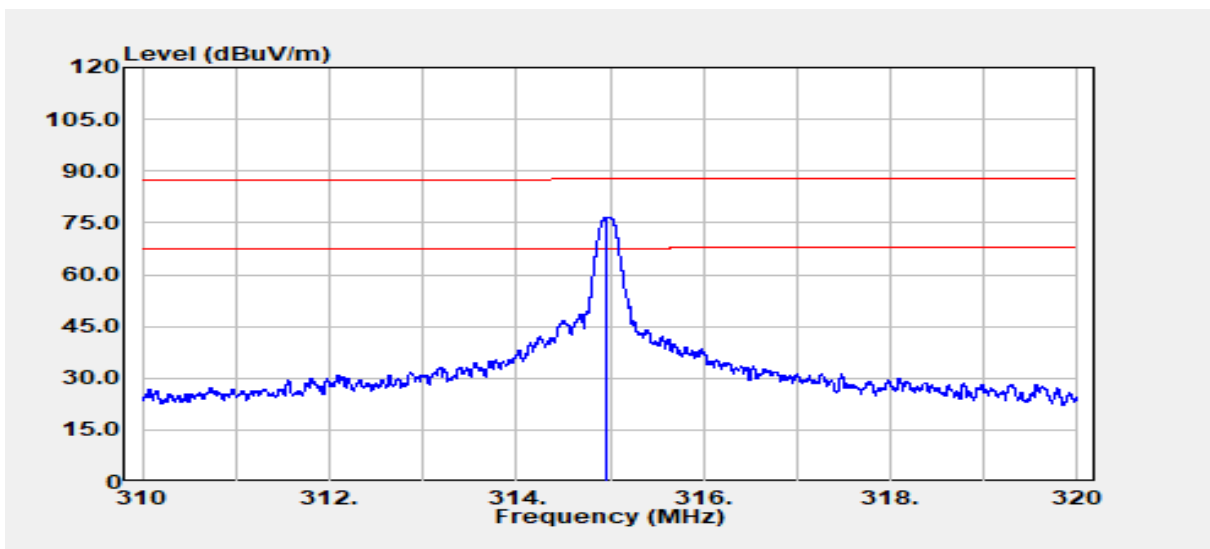

Freq. MHz	Detector Mode PK/QP/AV	Spectrum Read Level dB μ V	Factor dB	Actual FS dB μ V/m	Limit dB μ V/m	Margin dB
314.97	Peak	84.64	-8.03	76.61	87.66	-11.04
314.97	Average	--	-12.04	64.57	67.66	-3.08

(3) Config: EC01

Project No	:TM-2406000275P	Test Date	:2024-07-30
Operation Band	:314.97 MHz	Temp./Humi.	:24.6/57
Frequency	:314.97 MHz	Antenna Pol.	:HORIZONTAL
Operation Mode	:Main	Engineer	:Tony.Chao
EUT Pol	:E2	Test Chamber	: 966A
Setting	:EUT111 & EC01		

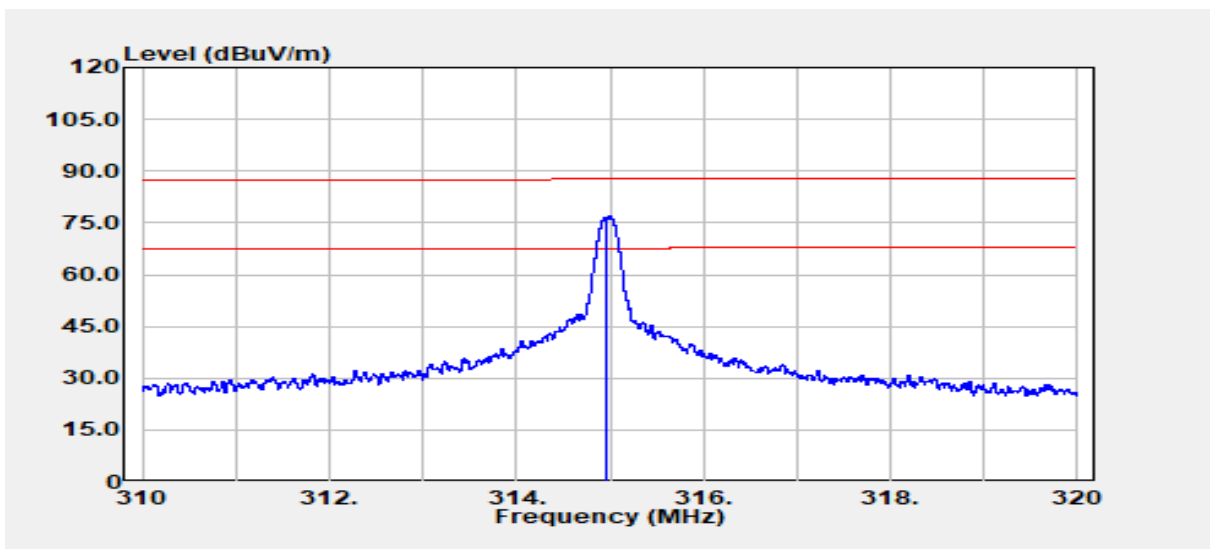

Freq. MHz	Detector Mode PK/QP/AV	Spectrum Read Level dB μ V	Factor dB	Actual FS dB μ V/m	Limit dB μ V/m	Margin dB
314.97	Peak	84.85	-8.03	76.82	87.66	-10.84
314.97	Average	--	-12.04	64.78	67.66	-2.88

Note:

Average result = Peak result + Duty factor = 83.48 – 21.31 = 62.17 (dBuV/m)

2. 433.92MHz (1) Config: E814

Project No	:TM-2406000275P	Test Date	:2024-07-30
Operation Band	:433.92 MHz	Temp./Humi.	:24.6/57
Frequency	:433.92 MHz	Antenna Pol.	:VERTICAL
Operation Mode	:Main	Engineer	:Tony.Chao
EUT Pol	:E2	Test Chamber	: 966A
Setting	:EUT111 & E814		

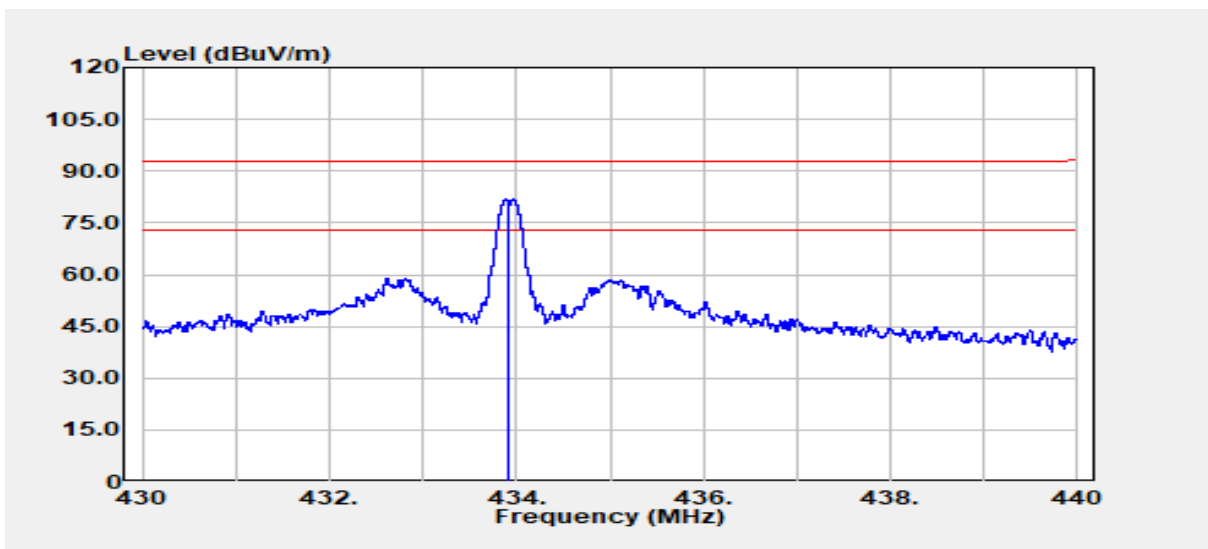

Freq. MHz	Detector Mode PK/QP/AV	Spectrum Read Level dB μ V	Factor dB	Actual FS dB μ V/m	Limit dB μ V/m	Margin dB
433.92	Peak	86.47	-4.67	81.81	92.87	-11.06
433.92	Average	--	-14.33	67.48	72.87	-5.39

(1) Config: E814

Project No	:TM-2406000275P	Test Date	:2024-07-30
Operation Band	:433.92 MHz	Temp./Humi.	:24.6/57
Frequency	:433.92 MHz	Antenna Pol.	:HORIZONTAL
Operation Mode	:Main	Engineer	:Tony.Chao
EUT Pol	:E2	Test Chamber	: 966A
Setting	:EUT111 & E814		

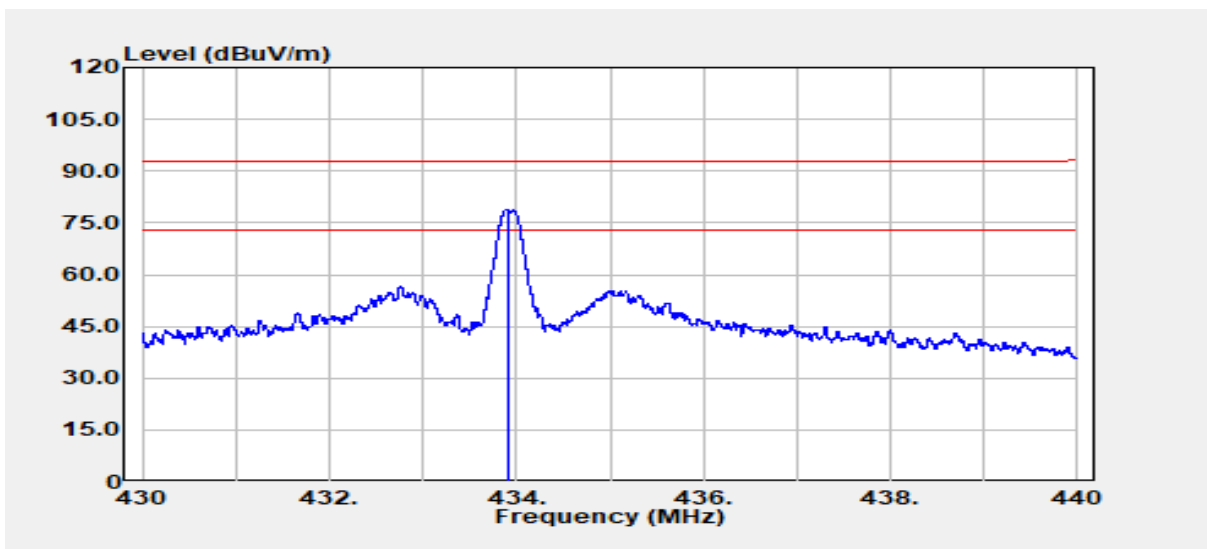

Freq. MHz	Detector Mode PK/QP/AV	Spectrum Read Level dB μ V	Factor dB	Actual FS dB μ V/m	Limit dB μ V/m	Margin dB
433.92	Peak	83.41	-4.67	78.75	92.87	-14.12
433.92	Average	--	-14.33	64.42	72.87	-8.45

(2) Config: 9214

Project No	:TM-2406000275P	Test Date	:2024-07-30
Operation Band	:433.92 MHz	Temp./Humi.	:24.6/57
Frequency	:433.92 MHz	Antenna Pol.	:VERTICAL
Operation Mode	:Main	Engineer	:Tony.Chao
EUT Pol	:E2	Test Chamber	: 966A
Setting	:EUT111 & 9214		

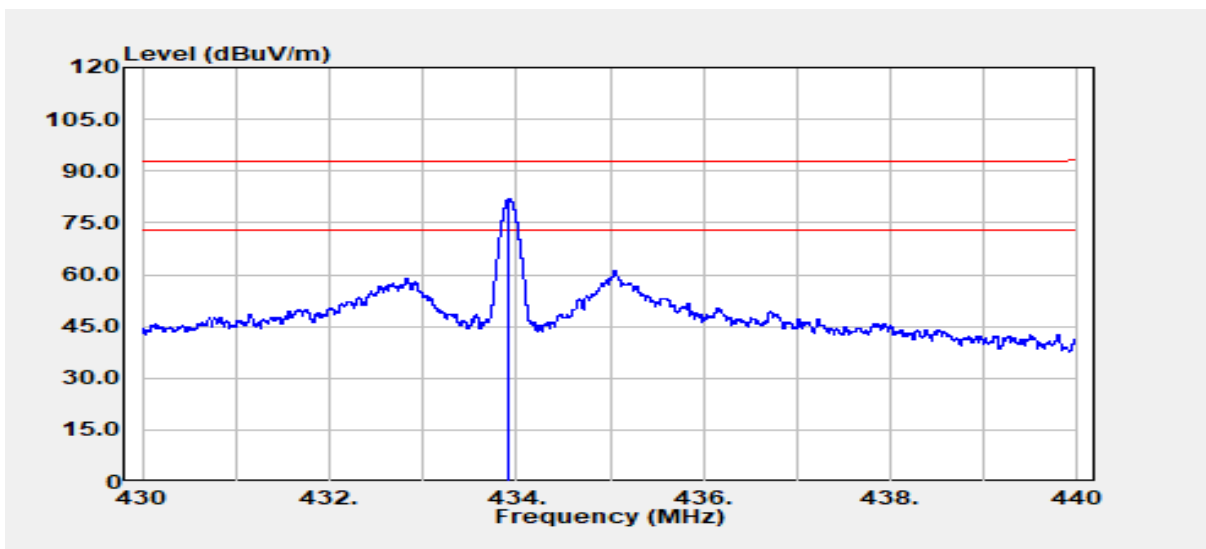

Freq. MHz	Detector Mode PK/QP/AV	Spectrum Read Level dB μ V	Factor dB	Actual FS dB μ V/m	Limit dB μ V/m	Margin dB
433.92	Peak	86.62	-4.67	81.95	92.87	-10.92
433.92	Average	--	-15.44	66.51	72.87	-6.36

(2) Config: 9214

Project No	:TM-2406000275P	Test Date	:2024-07-30
Operation Band	:433.92 MHz	Temp./Humi.	:24.6/57
Frequency	:433.92 MHz	Antenna Pol.	:HORIZONTAL
Operation Mode	:Main	Engineer	:Tony.Chao
EUT Pol	:E2	Test Chamber	: 966A
Setting	:EUT111 & 9214		

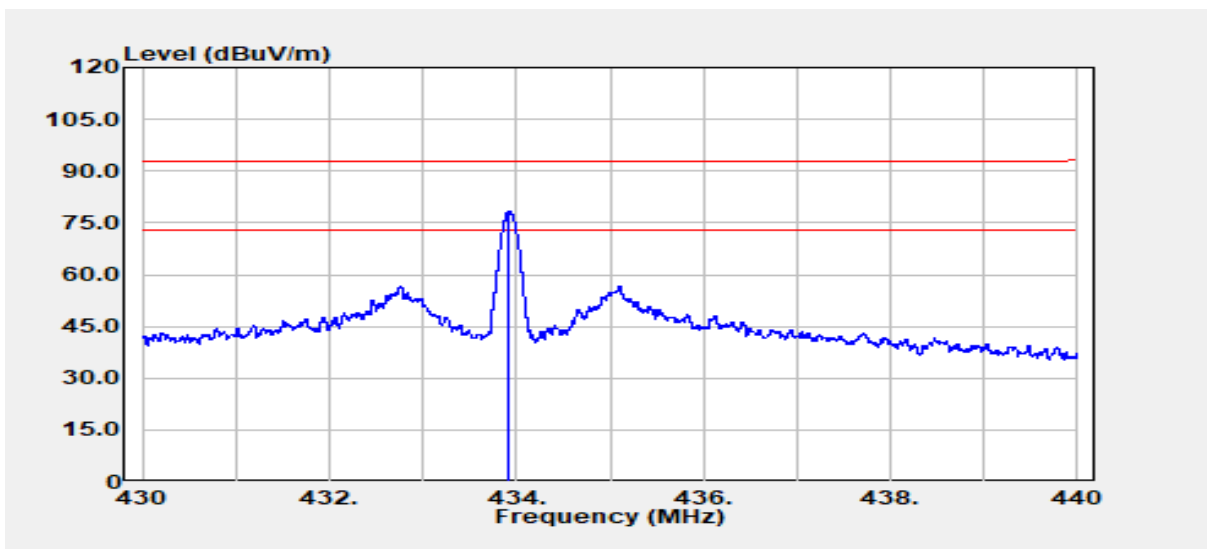

Freq. MHz	Detector Mode PK/QP/AV	Spectrum Read Level dB μ V	Factor dB	Actual FS dB μ V/m	Limit dB μ V/m	Margin dB
433.92	Peak	83.05	-4.67	78.39	92.87	-14.48
433.92	Average	--	-15.44	62.95	72.87	-9.92

(3) Config: EC01

Project No	:TM-2406000275P	Test Date	:2024-07-30
Operation Band	:433.92 MHz	Temp./Humi.	:24.6/57
Frequency	:433.92 MHz	Antenna Pol.	:VERTICAL
Operation Mode	:Main	Engineer	:Tony.Chao
EUT Pol	:E2	Test Chamber	: 966A
Setting	:EUT111 & EC01		

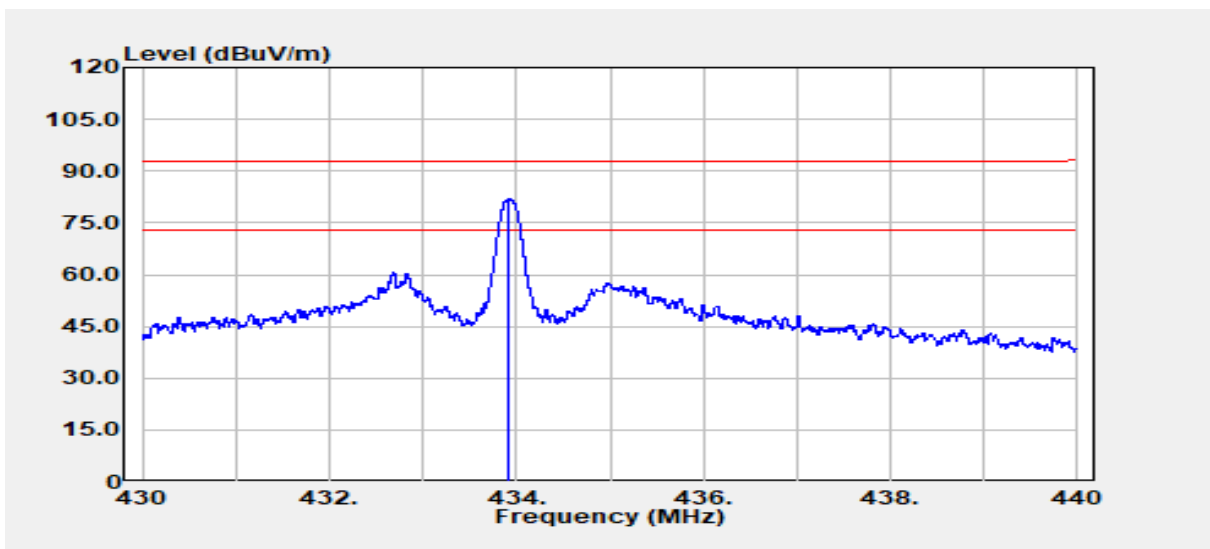

Freq. MHz	Detector Mode PK/QP/AV	Spectrum Read Level dB μ V	Factor dB	Actual FS dB μ V/m	Limit dB μ V/m	Margin dB
433.92	Peak	86.50	-4.67	81.84	92.87	-11.03
433.92	Average	--	-12.04	69.80	72.87	-3.07

(3) Config: EC01

Project No	:TM-2406000275P	Test Date	:2024-07-30
Operation Band	:433.92 MHz	Temp./Humi.	:24.6/57
Frequency	:433.92 MHz	Antenna Pol.	:HORIZONTAL
Operation Mode	:Main	Engineer	:Tony.Chao
EUT Pol	:E2	Test Chamber	: 966A
Setting	:EUT111 & EC01		

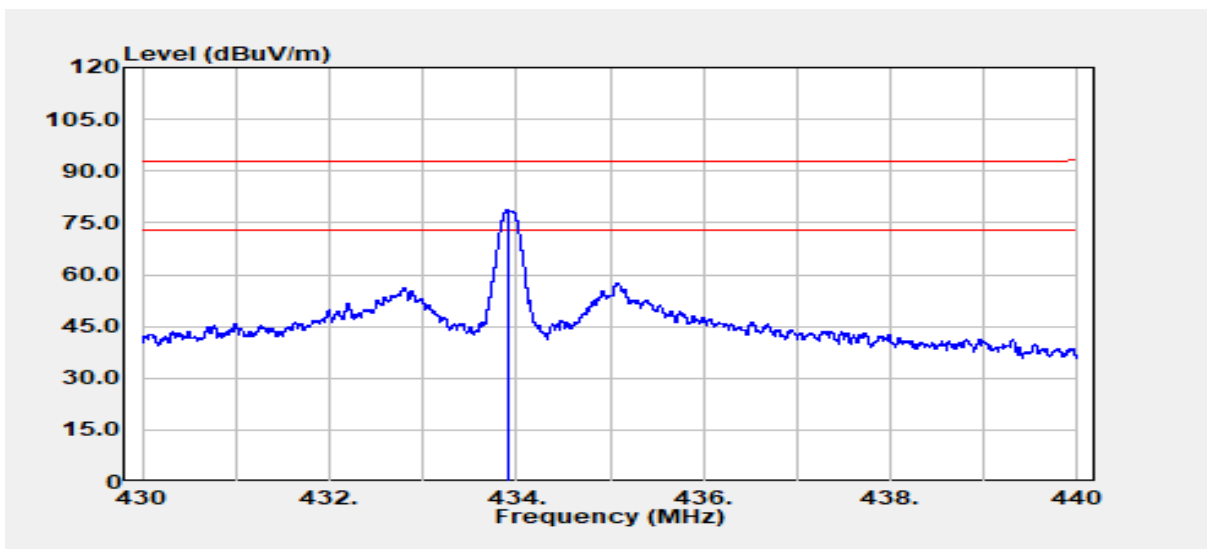

Freq. MHz	Detector Mode PK/QP/AV	Spectrum Read Level dB μ V	Factor dB	Actual FS dB μ V/m	Limit dB μ V/m	Margin dB
433.92	Peak	83.27	-4.67	78.60	92.87	-14.26
433.92	Average	--	-12.04	66.56	72.87	-6.30

4.4 RADIATION UNWANTED EMISSION

4.4.1 Test Limit

According to §15.231(e) and §15.209, §15.205

Unwanted emissions limit follow the table or the FCC Part 15.209, whichever limit permits higher field strength.

According to §15.231(e)

Fundamental frequency (MHz)	Field strength of fundamental (microvolts/meter)	Field strength of spurious emissions (microvolts/meter)
40.66-40.70	1,000	100
70-130	500	50
130-174	500 to 1,500 ¹	50 to 150 ¹
174-260	1,500	150
260-470	1,500 to 5,000 ¹	150 to 500 ¹
Above 470	5,000	500

* Linear interpolation with frequency, f, in MHz:

For 130-174 MHz: Field Strength ($\mu\text{V}/\text{m}$) = $(22.73 \times f) - 2454.55$

For 260-470 MHz: Field Strength ($\mu\text{V}/\text{m}$) = $(16.67 \times f) - 2833.33$

Below 30MHz

Frequency (MHz)	Field Strength				
	($\mu\text{V/m}$)	($\text{dB}\mu\text{V/m}$)	Measurement Distance (meter)	($\text{dB}\mu\text{V/m}$)	Measurement Distance (meter)
0.009 - 0.490	2400/F(kHz)	48.52 – 13.80	300	128.52–104.84	3
0.490 - 1.705	24000/F(kHz)	33.80 – 22.97	30	73.80– 62.97	3
1.705 – 30.0	30	29.54	30	69.54	3

Above 30MHz

Frequency (MHz)	Field Strength		Measurement Distance (meter)
	($\mu\text{V/m}$)	($\text{dB}\mu\text{V/m}$)	
30-88	100	40.0	3
88-216	150	43.5	3
216-960	200	46.0	3
Above 960	500	54.0	3

4.4.2 Test Procedure

Test method Refer as ANSI 63.10:2013

<input checked="" type="checkbox"/> Unwanted Emission	<input checked="" type="checkbox"/> clause 4.1.4.2.2: Measurement Peak value. <input type="checkbox"/> clause 4.1.4.2.3: Duty cycle \geq 100%. <input checked="" type="checkbox"/> clause 4.1.4.2.4: Measurement Average value.
---	---

<input checked="" type="checkbox"/> Radiated Emission	<input checked="" type="checkbox"/> clause 6.4: below 30 MHz and test distance is 3m. <input checked="" type="checkbox"/> clause 6.5: below 30 MHz -1 GHz and test distance is 3m. <input checked="" type="checkbox"/> clause 6.6: Above 30 MHz and test distance is 3m.
---	--

1. The EUT is placed on a turntable, which is 0.8m for test below 1GHz and 1.5m for test above 1GHz, above ground plane.
2. The turntable shall be rotated for 360 degrees to determine the position of maximum emission level.
3. EUT is set 3m away from the receiving antenna, which is varied from 1m to 4m to find out the highest emissions.
4. Maximum procedure was performed on the six highest emissions to ensure EUT compliance.
5. And also, each emission was to be maximized by changing the polarization of receiving antenna both horizontal and vertical.
6. Set the spectrum analyzer in the following setting as:

Below 1GHz:

RBW=100kHz / VBW=300kHz / Sweep=AUTO

Above 1GHz:

(a)PEAK: RBW=1MHz / VBW=3MHz / Sweep=AUTO

(b)AVERAGE: RBW=1MHz,

7. Repeat above procedures until the measurements for all frequencies are complete.

Remark.

1. Although these tests were performed other than open area test site, adequate comparison measurements were confirmed against 30 m open area test site. Therefore sufficient tests were made to demonstrate that the alternative site produces results that correlate with the ones of tests made in an open field based on KDB 414788.
2. No emission found between lowest internal used/generated frequency to 30MHz (9kHz~30MHz).

4.4.3 Test Setup

9kHz ~ 30MHz

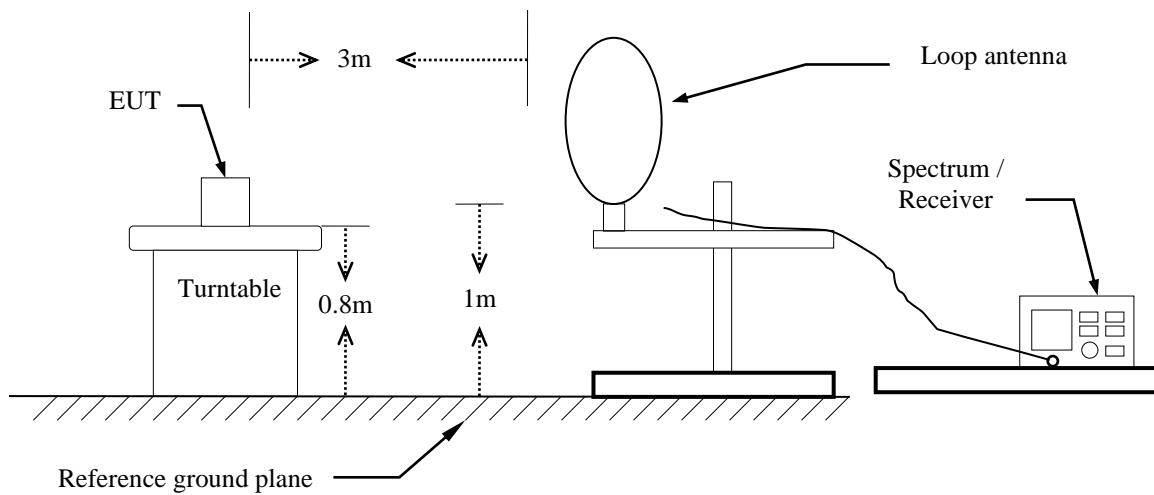

30MHz ~ 1 GHz

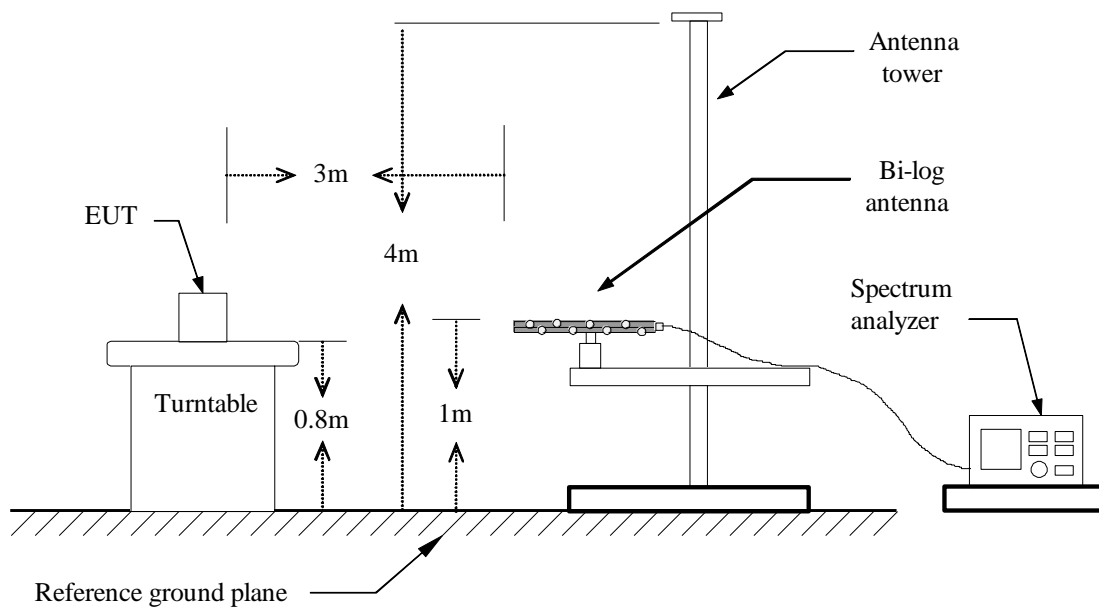

Above 1 GHz

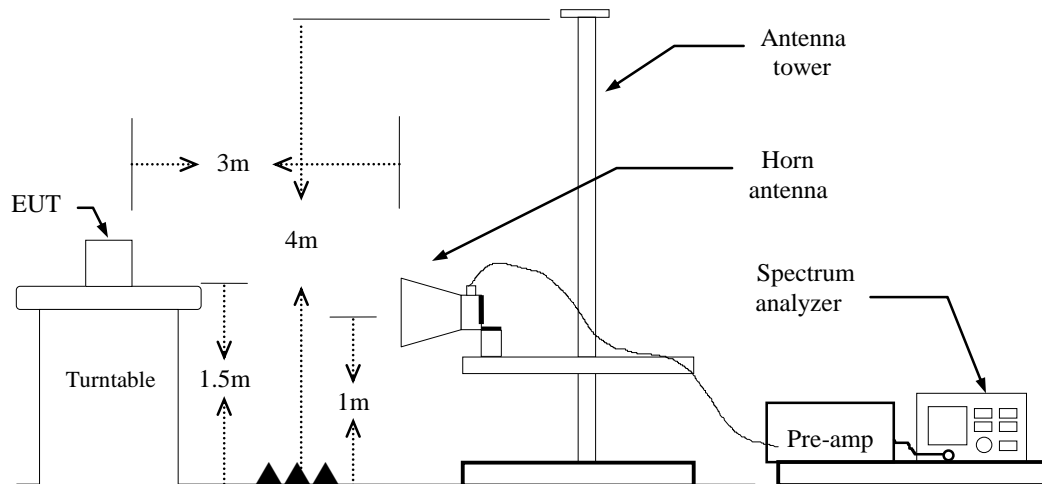

4.4.4 Test Result

Pass.

1. 314.97MHz, (1) Config: E814

Below 1GHz

Project No	:TM-2406000275P	Test Date	:2024-07-30
Operation Band	:314.97 MHz	Temp./Humi.	:24.6/57
Frequency	:314.97 MHz	Antenna Pol.	:VERTICAL
Operation Mode	:TX	Engineer	:Tony.Chao
EUT Pol	:E2	Test Chamber	: 966A
Setting	:EUT111 & E814		

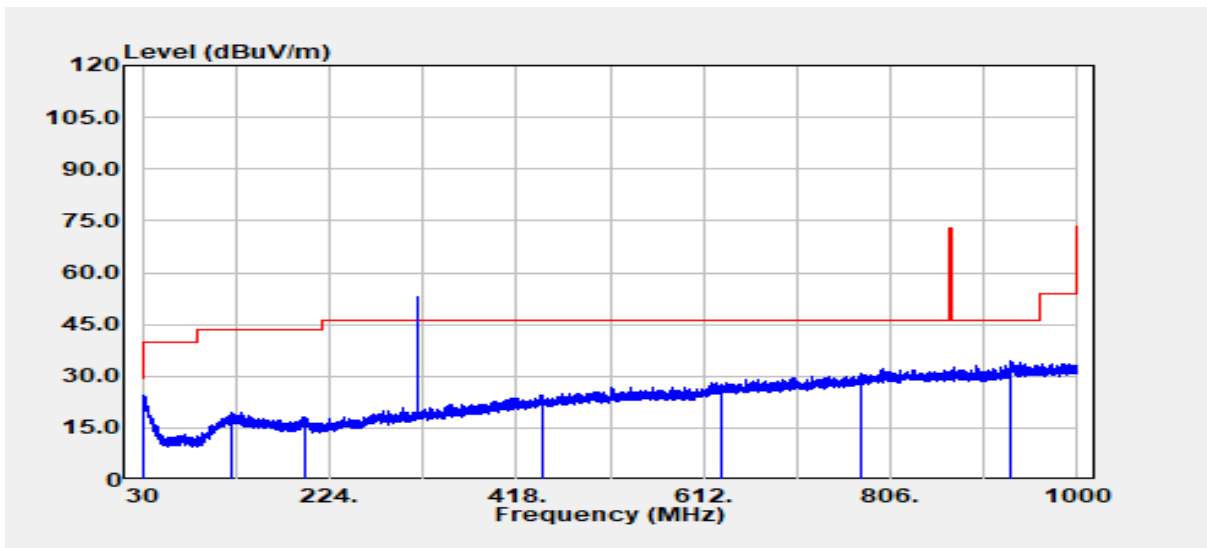

Freq. MHz	Detector Mode PK/QP/AV	Spectrum Read Level dB μ V	Factor dB	Actual FS dB μ V/m	Limit dB μ V/m	Margin dB
30.85	Peak	27.76	-3.17	24.58	40.00	-15.42
121.42	Peak	28.81	-9.16	19.65	43.50	-23.85
199.63	Peak	27.88	-9.57	18.31	43.50	-25.19
443.95	Peak	28.81	-4.41	24.40	46.00	-21.60
629.94	Peak	28.89	-0.60	28.29	46.00	-17.71
776.66	Peak	29.14	1.50	30.65	46.00	-15.35
930.65	Peak	30.47	3.82	34.29	46.00	-11.71

Project No	:TM-2406000275P	Test Date	:2024-07-30
Operation Band	:314.97 MHz	Temp./Humi.	:24.6/57
Frequency	:314.97 MHz	Antenna Pol.	:HORIZONTAL
Operation Mode	:TX	Engineer	:Tony.Chao
EUT Pol	:E2	Test Chamber	: 966A
Setting	:EUT111 & E814		

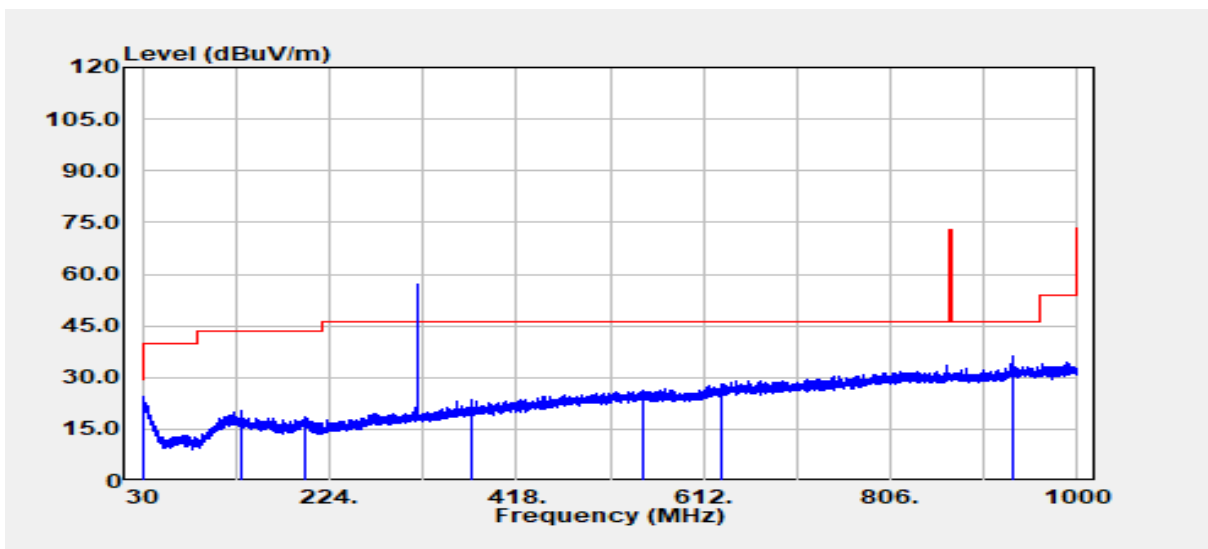

Freq. MHz	Detector Mode PK/QP/AV	Spectrum Read Level dB μ V	Factor dB	Actual FS dB μ V/m	Limit dB μ V/m	Margin dB
30.00	Peak	26.84	-2.40	24.44	29.54	-5.10
133.06	Peak	29.55	-9.36	20.19	43.50	-23.31
199.39	Peak	28.18	-9.59	18.59	43.50	-24.91
372.65	Peak	30.11	-6.69	23.41	46.00	-22.59
548.83	Peak	28.63	-2.52	26.10	46.00	-19.90
629.94	Peak	29.04	-0.60	28.43	46.00	-17.57
933.43	Peak	32.14	3.90	36.04	46.00	-9.96

Above 1GHz

Project No	:TM-2406000275P	Test Date	:2024-07-31
Operation Band	:314.97 MHz	Temp./Humi.	:24.6/57
Frequency	:314.97 MHz	Antenna Pol.	:VERTICAL
Operation Mode	:TX	Engineer	:Ray.Li
EUT Pol	:E2	Test Chamber	: 966A
Setting	:EUT111 & E814		

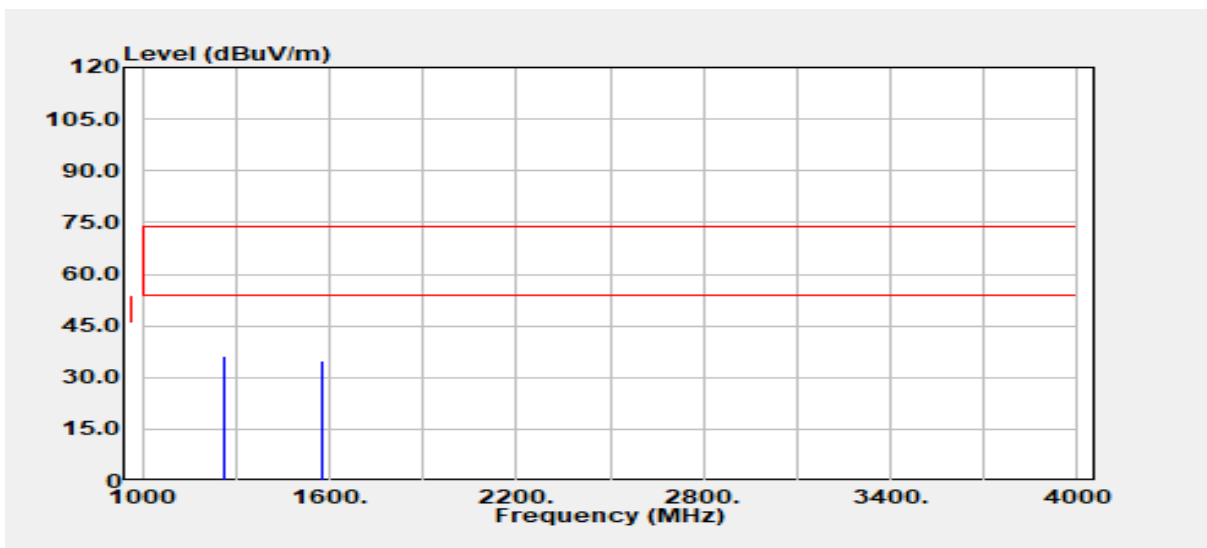

Freq. MHz	Detector Mode PK/QP/AV	Spectrum Read Level dB μ V	Factor dB	Actual FS dB μ V/m	Limit dB μ V/m	Margin dB
1259.88	Peak	43.88	-7.65	36.24	74.00	-37.76
1574.85	Peak	42.06	-7.11	34.95	74.00	-39.05

Remark:

1. Measuring frequencies from 1 GHz to the 10th harmonic of highest fundamental frequency.
2. For above 1GHz, the EUT peak value was under average limit, therefore the Average value compliance with the average limit.

Project No	:TM-2406000275P	Test Date	:2024-07-31
Operation Band	:314.97 MHz	Temp./Humi.	:24.6/57
Frequency	:314.97 MHz	Antenna Pol.	:HORIZONTAL
Operation Mode	:TX	Engineer	:Ray.Li
EUT Pol	:E2	Test Chamber	: 966A
Setting	:EUT111 & E814		

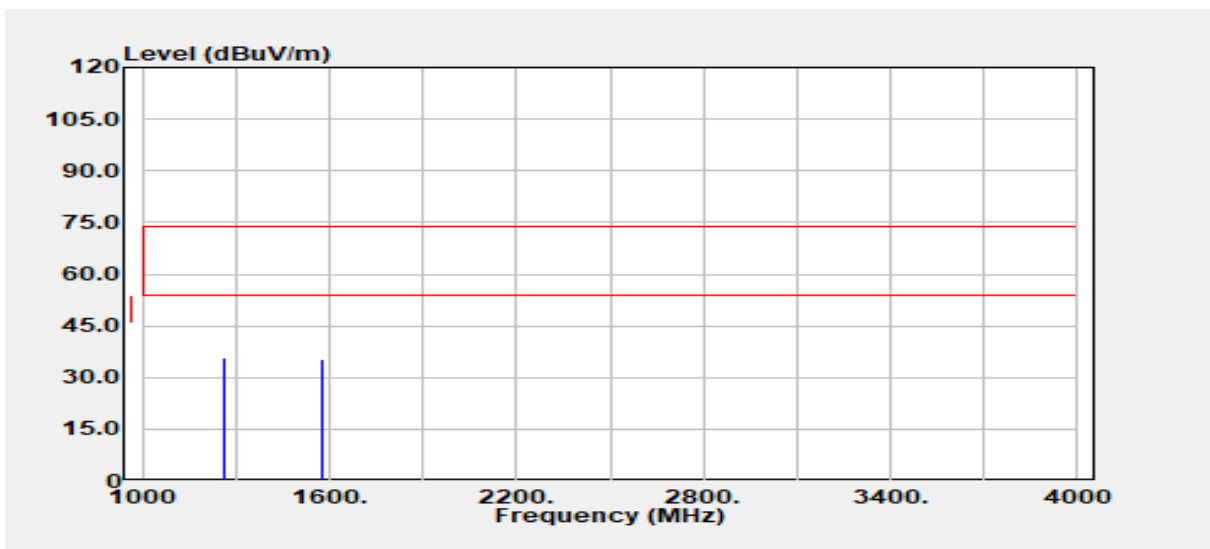

Freq. MHz	Detector Mode PK/QP/AV	Spectrum Read Level dB μ V	Factor dB	Actual FS dB μ V/m	Limit dB μ V/m	Margin dB
1259.88	Peak	43.62	-7.65	35.97	74.00	-38.03
1574.85	Peak	42.46	-7.11	35.35	74.00	-38.65

Remark:

1. Measuring frequencies from 1 GHz to the 10th harmonic of highest fundamental frequency.
2. For above 1GHz, the EUT peak value was under average limit, therefore the Average value compliance with the average limit.

1. 314.97MHz, (2) Config: 9214

Below 1GHz

Project No	:TM-2406000275P	Test Date	:2024-07-30
Operation Band	:314.97 MHz	Temp./Humi.	:24.6/57
Frequency	:314.97 MHz	Antenna Pol.	:VERTICAL
Operation Mode	:TX	Engineer	:Tony.Chao
EUT Pol	:E2	Test Chamber	: 966A
Setting	:EUT111 & 9214		

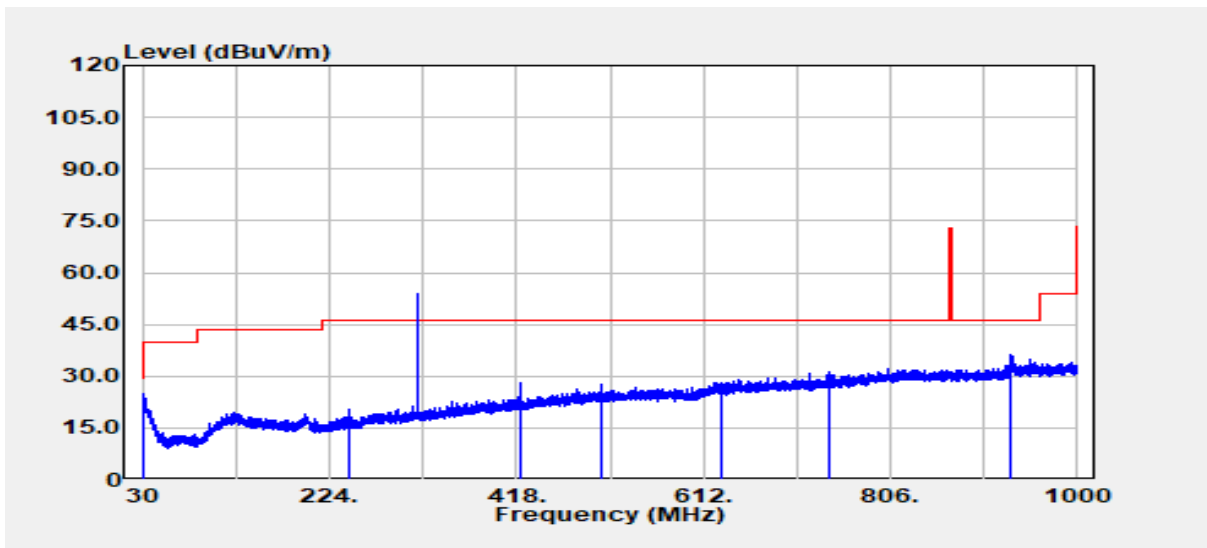

Freq. MHz	Detector Mode PK/QP/AV	Spectrum Read Level dB μ V	Factor dB	Actual FS dB μ V/m	Limit dB μ V/m	Margin dB
30.00	Peak	27.49	-2.40	25.09	29.54	-4.45
244.37	Peak	30.74	-10.55	20.19	46.00	-25.81
421.64	Peak	33.04	-5.04	27.99	46.00	-18.01
506.15	Peak	30.92	-3.32	27.60	46.00	-18.40
629.94	Peak	28.97	-0.60	28.37	46.00	-17.63
743.68	Peak	30.17	0.98	31.15	46.00	-14.85
931.49	Peak	32.48	3.84	36.33	46.00	-9.67

Project No	:TM-2406000275P	Test Date	:2024-07-30
Operation Band	:314.97 MHz	Temp./Humi.	:24.6/57
Frequency	:314.97 MHz	Antenna Pol.	:HORIZONTAL
Operation Mode	:TX	Engineer	:Tony.Chao
EUT Pol	:E2	Test Chamber	: 966A
Setting	:EUT111 & 9214		

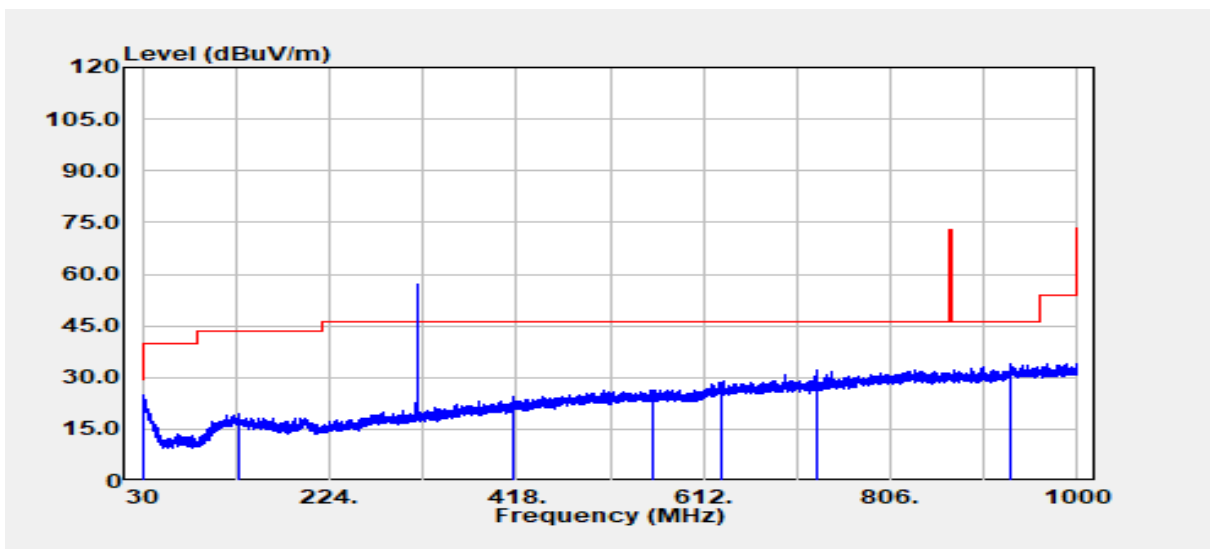

Freq. MHz	Detector Mode PK/QP/AV	Spectrum Read Level dB μ V	Factor dB	Actual FS dB μ V/m	Limit dB μ V/m	Margin dB
30.24	Peak	27.43	-2.62	24.80	40.00	-15.20
129.30	Peak	28.79	-9.17	19.62	43.50	-23.88
414.61	Peak	29.84	-5.26	24.58	46.00	-21.42
558.41	Peak	28.86	-2.37	26.49	46.00	-19.51
629.94	Peak	29.49	-0.60	28.89	46.00	-17.11
730.34	Peak	31.52	0.84	32.36	46.00	-13.64
930.52	Peak	30.33	3.82	34.14	46.00	-11.86

Above 1GHz

Project No	:TM-2406000275P	Test Date	:2024-07-31
Operation Band	:314.97 MHz	Temp./Humi.	:24.6/57
Frequency	:314.97 MHz	Antenna Pol.	:VERTICAL
Operation Mode	:TX	Engineer	:Ray.Li
EUT Pol	:E2	Test Chamber	: 966A
Setting	:EUT111 & 9214		

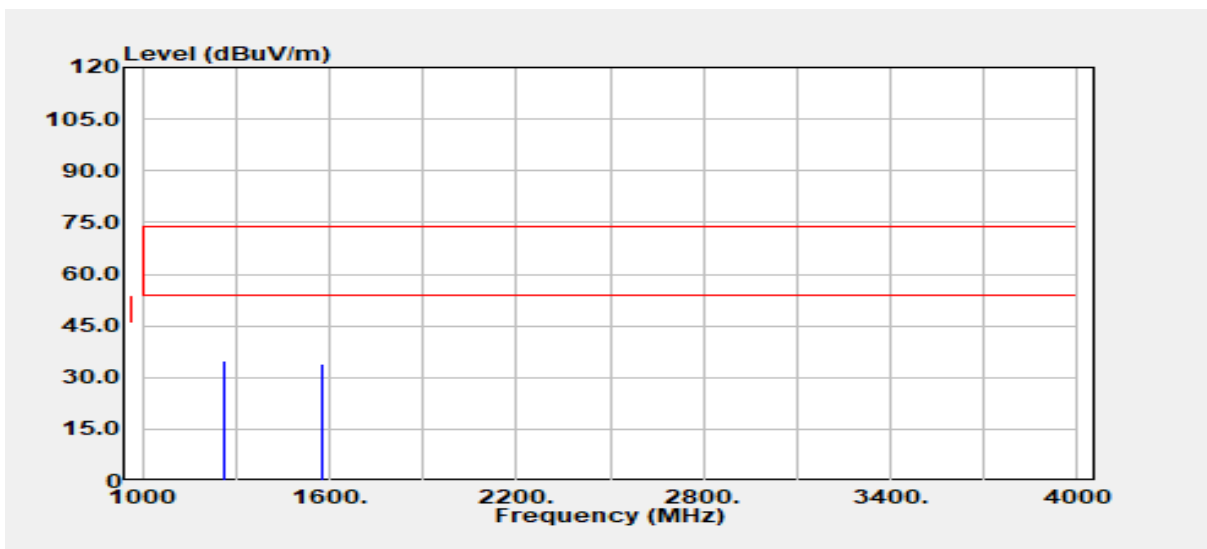

Freq. MHz	Detector Mode PK/QP/AV	Spectrum Read Level dB μ V	Factor dB	Actual FS dB μ V/m	Limit dB μ V/m	Margin dB
1259.88	Peak	42.72	-7.65	35.07	74.00	-38.93
1574.85	Peak	41.28	-7.11	34.17	74.00	-39.83

Remark:

1. Measuring frequencies from 1 GHz to the 10th harmonic of highest fundamental frequency.
2. For above 1GHz, the EUT peak value was under average limit, therefore the Average value compliance with the average limit.

Project No :TM-2406000275P
 Operation Band :314.97 MHz
 Frequency :314.97 MHz
 Operation Mode :TX
 EUT Pol :E2
 Setting :EUT111 & 9214

Test Date :2024-07-31
 Temp./Humi. :24.6/57
 Antenna Pol. :HORIZONTAL
 Engineer :Ray.Li
 Test Chamber : 966A

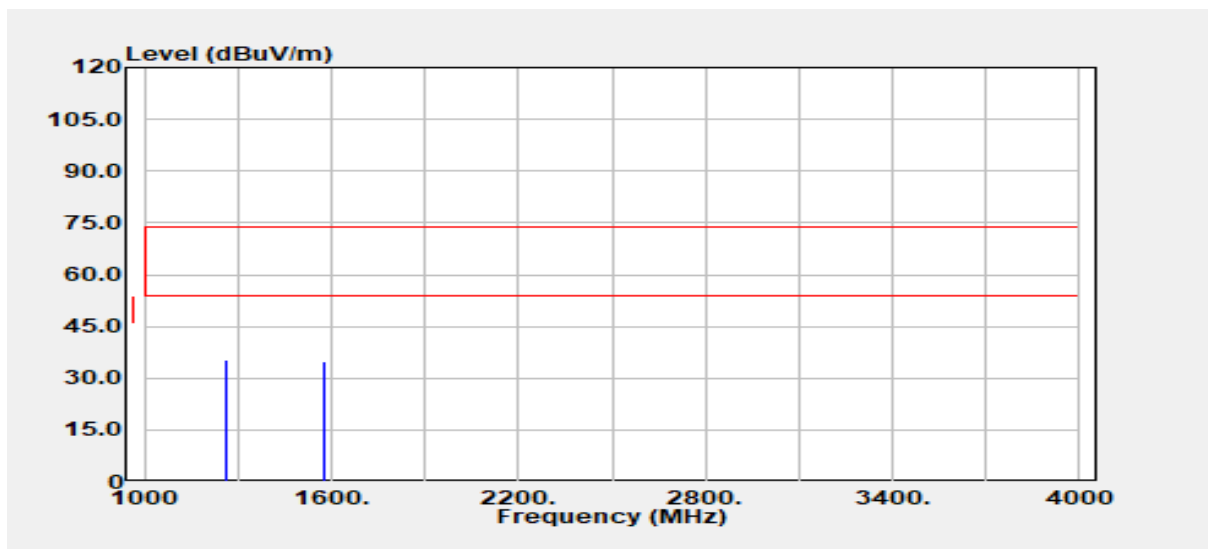

Freq. MHz	Detector Mode PK/QP/AV	Spectrum Read Level d μ V	Factor dB	Actual FS d μ V/m	Limit d μ V/m	Margin dB
1259.88	Peak	42.95	-7.65	35.30	74.00	-38.70
1574.85	Peak	41.94	-7.11	34.83	74.00	-39.17

Remark:

1. Measuring frequencies from 1 GHz to the 10th harmonic of highest fundamental frequency.
2. For above 1GHz, the EUT peak value was under average limit, therefore the Average value compliance with the average limit.

1. 314.97MHz, (3) Config: EC01

Below 1GHz

Project No	:TM-2406000275P	Test Date	:2024-07-30
Operation Band	:314.97 MHz	Temp./Humi.	:24.6/57
Frequency	:314.97 MHz	Antenna Pol.	:VERTICAL
Operation Mode	:TX	Engineer	:Tony.Chao
EUT Pol	:E2	Test Chamber	: 966A
Setting	:EUT111 & EC01		

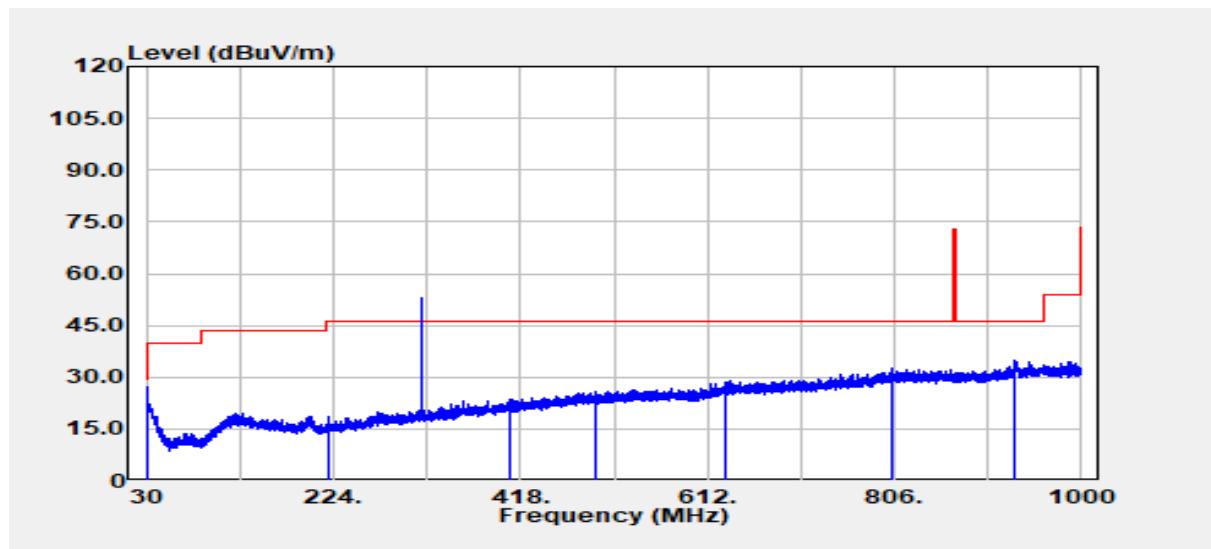

Freq. MHz	Detector Mode PK/QP/AV	Spectrum Read Level dB μ V	Factor dB	Actual FS dB μ V/m	Limit dB μ V/m	Margin dB
30.12	Peak	27.26	-2.51	24.75	40.00	-15.25
217.82	Peak	30.55	-11.79	18.76	46.00	-27.24
407.21	Peak	29.24	-5.47	23.77	46.00	-22.23
496.57	Peak	29.27	-3.26	26.00	46.00	-20.00
629.94	Peak	29.48	-0.60	28.88	46.00	-17.12
802.24	Peak	30.44	1.95	32.39	46.00	-13.61
931.37	Peak	31.16	3.84	35.00	46.00	-11.00

Project No	:TM-2406000275P	Test Date	:2024-07-30
Operation Band	:314.97 MHz	Temp./Humi.	:24.6/57
Frequency	:314.97 MHz	Antenna Pol.	:HORIZONTAL
Operation Mode	:TX	Engineer	:Tony.Chao
EUT Pol	:E2	Test Chamber	: 966A
Setting	:EUT111 & EC01		

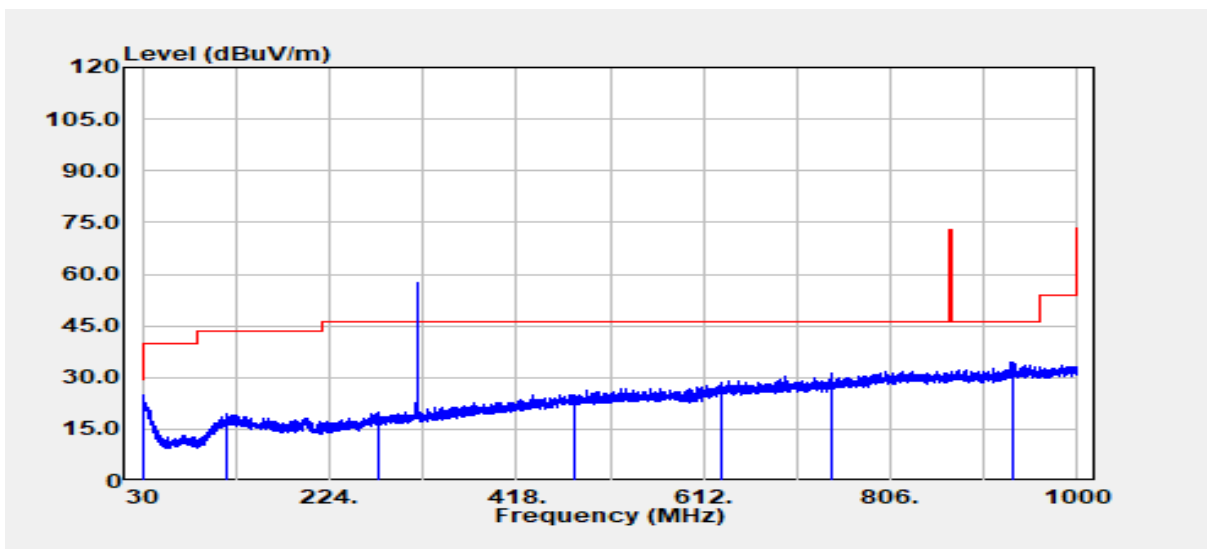

Freq. MHz	Detector Mode PK/QP/AV	Spectrum Read Level dB μ V	Factor dB	Actual FS dB μ V/m	Limit dB μ V/m	Margin dB
30.97	Peak	28.00	-3.28	24.72	40.00	-15.28
116.45	Peak	29.00	-9.59	19.41	43.50	-24.09
275.53	Peak	28.42	-8.68	19.74	46.00	-26.26
479.11	Peak	28.55	-3.44	25.10	46.00	-20.90
629.94	Peak	29.49	-0.60	28.89	46.00	-17.11
745.62	Peak	30.35	1.02	31.37	46.00	-14.63
933.68	Peak	30.72	3.91	34.63	46.00	-11.37

Above 1GHz

Project No	:TM-2406000275P	Test Date	:2024-07-31
Operation Band	:314.97 MHz	Temp./Humi.	:24.6/57
Frequency	:314.97 MHz	Antenna Pol.	:VERTICAL
Operation Mode	:TX	Engineer	:Ray.Li
EUT Pol	:E2	Test Chamber	: 966A
Setting	:EUT111 & EC01		

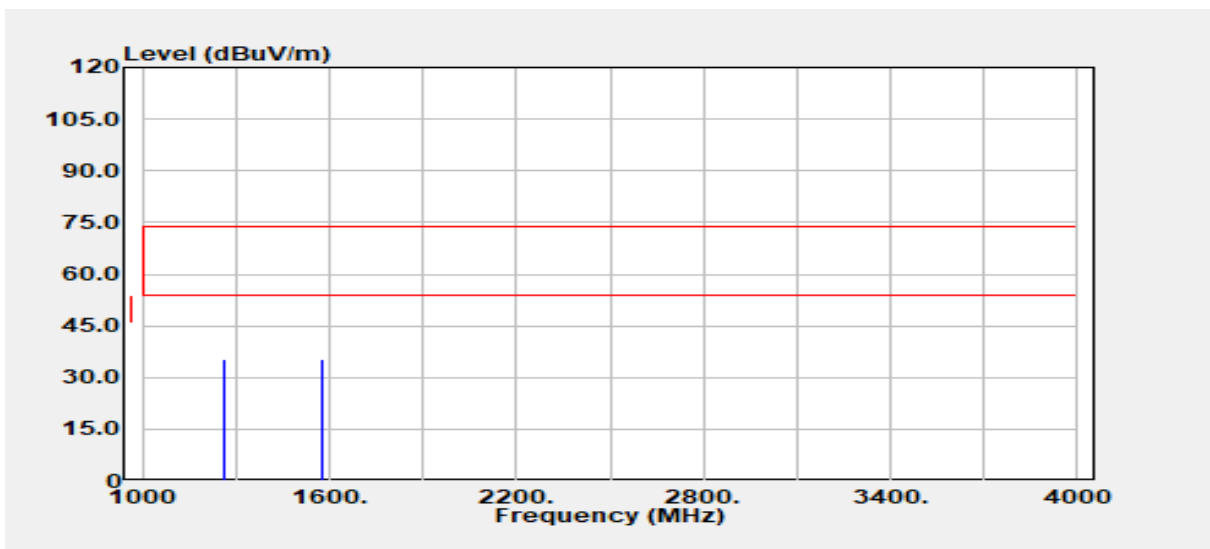

Freq. MHz	Detector Mode PK/QP/AV	Spectrum Read Level dB μ V	Factor dB	Actual FS dB μ V/m	Limit dB μ V/m	Margin dB
1259.88	Peak	42.83	-7.65	35.18	74.00	-38.82
1574.85	Peak	42.38	-7.11	35.27	74.00	-38.73

Remark:

1. Measuring frequencies from 1 GHz to the 10th harmonic of highest fundamental frequency.
2. For above 1GHz, the EUT peak value was under average limit, therefore the Average value compliance with the average limit.

Project No	:TM-2406000275P	Test Date	:2024-07-31
Operation Band	:314.97 MHz	Temp./Humi.	:24.6/57
Frequency	:314.97 MHz	Antenna Pol.	:HORIZONTAL
Operation Mode	:TX	Engineer	:Ray.Li
EUT Pol	:E2	Test Chamber	: 966A
Setting	:EUT111 & EC01		

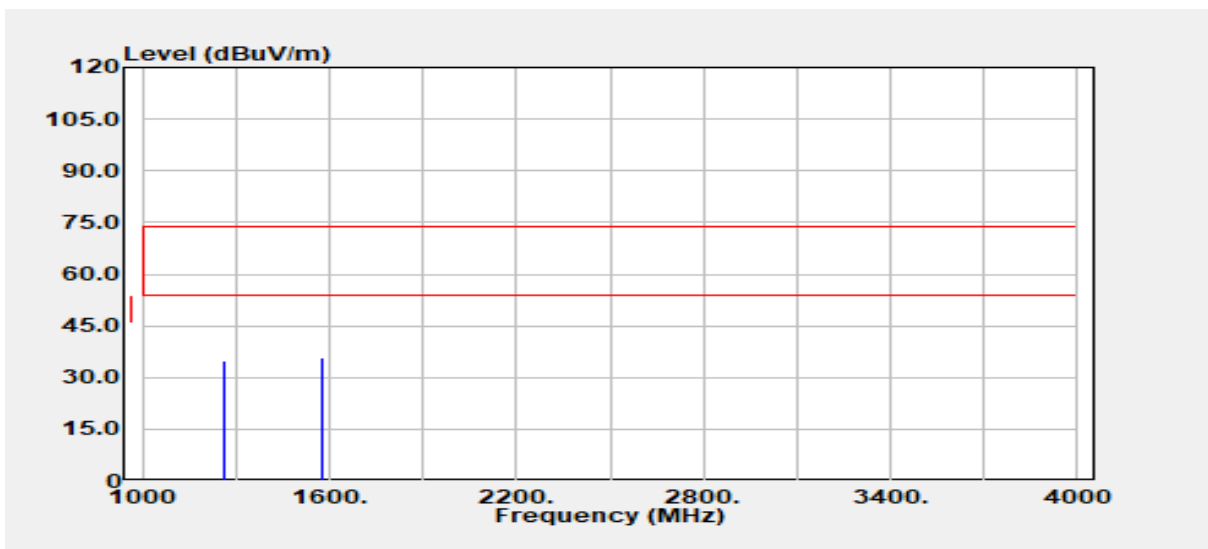

Freq. MHz	Detector Mode PK/QP/AV	Spectrum Read Level dB μ V	Factor dB	Actual FS dB μ V/m	Limit dB μ V/m	Margin dB
1259.88	Peak	42.53	-7.65	34.88	74.00	-39.12
1574.85	Peak	42.78	-7.11	35.67	74.00	-38.33

Remark:

1. Measuring frequencies from 1 GHz to the 10th harmonic of highest fundamental frequency.
2. For above 1GHz, the EUT peak value was under average limit, therefore the Average value compliance with the average limit.

2. 433.92MHz, (1) Config: E814

Below 1GHz

Project No	:TM-2406000275P	Test Date	:2024-07-30
Operation Band	:433.92 MHz	Temp./Humi.	:24.6/57
Frequency	:433.92 MHz	Antenna Pol.	:VERTICAL
Operation Mode	:TX	Engineer	:Tony.Chao
EUT Pol	:E2	Test Chamber	: 966A
Setting	:EUT111 & E814		

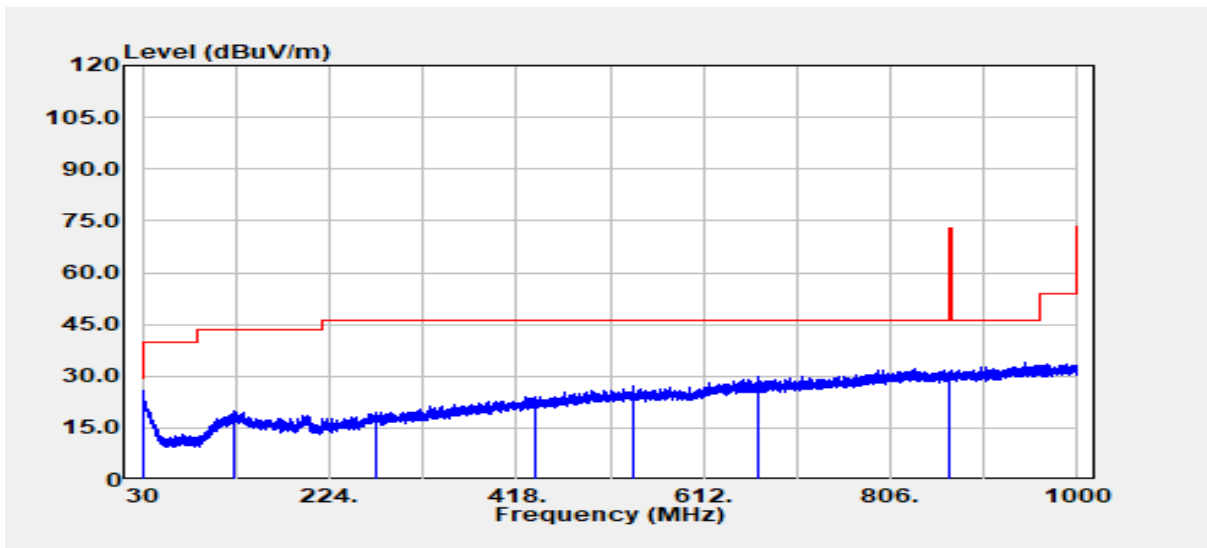

Freq. MHz	Detector Mode PK/QP/AV	Spectrum Read Level dB μ V	Factor dB	Actual FS dB μ V/m	Limit dB μ V/m	Margin dB
30.61	Peak	28.72	-2.95	25.77	40.00	-14.23
123.73	Peak	28.97	-9.13	19.84	43.50	-23.66
271.65	Peak	28.36	-8.77	19.59	46.00	-26.41
438.73	Peak	28.71	-4.54	24.17	46.00	-21.83
540.22	Peak	29.79	-2.66	27.12	46.00	-18.88
667.65	Peak	30.09	-0.42	29.67	46.00	-16.33
867.84	Peak	28.69	2.96	31.65	72.87	-41.22

Project No	:TM-2406000275P	Test Date	:2024-07-30
Operation Band	:433.92 MHz	Temp./Humi.	:24.6/57
Frequency	:433.92 MHz	Antenna Pol.	:HORIZONTAL
Operation Mode	:TX	Engineer	:Tony.Chao
EUT Pol	:E2	Test Chamber	: 966A
Setting	:EUT111 & E814		

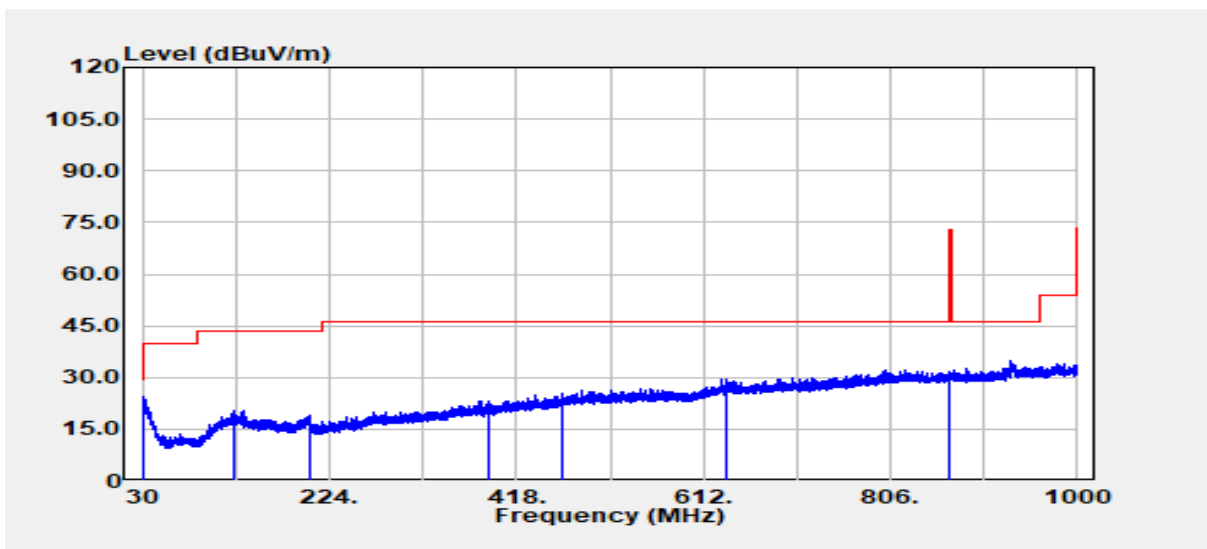

Freq. MHz	Detector Mode PK/QP/AV	Spectrum Read Level dB μ V	Factor dB	Actual FS dB μ V/m	Limit dB μ V/m	Margin dB
30.36	Peak	27.18	-2.73	24.45	40.00	-15.55
123.97	Peak	29.67	-9.13	20.54	43.50	-22.96
203.27	Peak	29.90	-10.95	18.95	43.50	-24.55
390.36	Peak	29.32	-6.20	23.13	46.00	-22.87
464.92	Peak	29.06	-3.82	25.24	46.00	-20.76
635.77	Peak	30.05	-0.52	29.53	46.00	-16.47
867.84	Peak	29.04	2.96	32.00	72.87	-40.87

Above 1GHz

Project No	:TM-2406000275P	Test Date	:2024-07-31
Operation Band	:433.92 MHz	Temp./Humi.	:24.6/57
Frequency	:433.92 MHz	Antenna Pol.	:VERTICAL
Operation Mode	:TX	Engineer	:Ray.Li
EUT Pol	:E2	Test Chamber	: 966A
Setting	:EUT111 & E814		

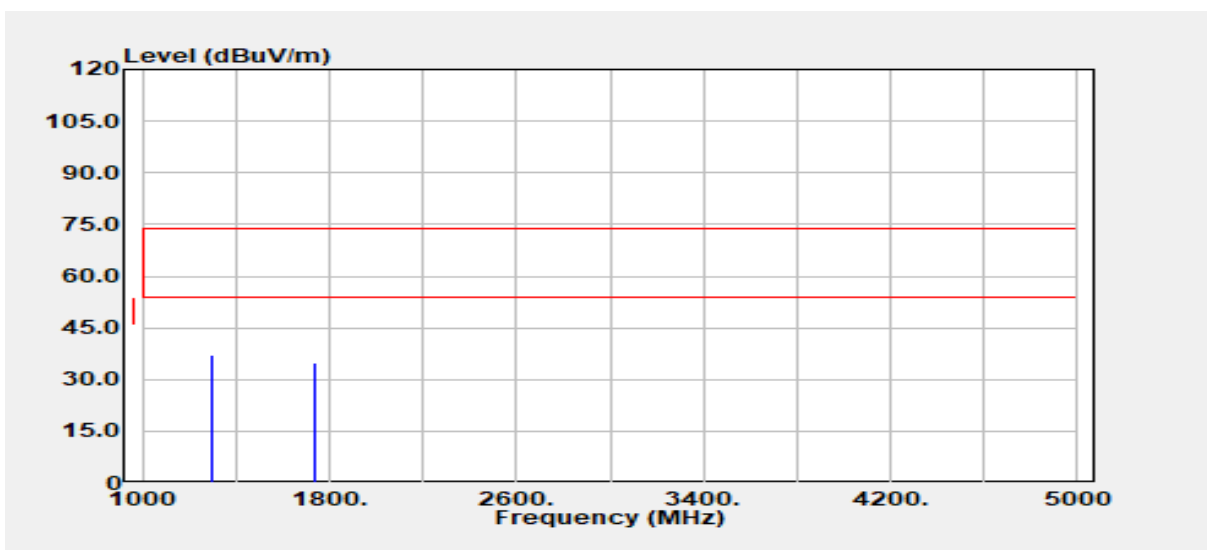

Freq. MHz	Detector Mode PK/QP/AV	Spectrum Read Level dB μ V	Factor dB	Actual FS dB μ V/m	Limit dB μ V/m	Margin dB
1301.76	Peak	44.75	-7.48	37.27	74.00	-36.73
1735.68	Peak	41.10	-6.34	34.76	74.00	-39.24

Remark:

1. Measuring frequencies from 1 GHz to the 10th harmonic of highest fundamental frequency.
2. For above 1GHz, the EUT peak value was under average limit, therefore the Average value compliance with the average limit.

Project No	:TM-2406000275P	Test Date	:2024-07-31
Operation Band	:433.92 MHz	Temp./Humi.	:24.6/57
Frequency	:433.92 MHz	Antenna Pol.	:HORIZONTAL
Operation Mode	:TX	Engineer	:Ray.Li
EUT Pol	:E2	Test Chamber	: 966A
Setting	:EUT111 & E814		

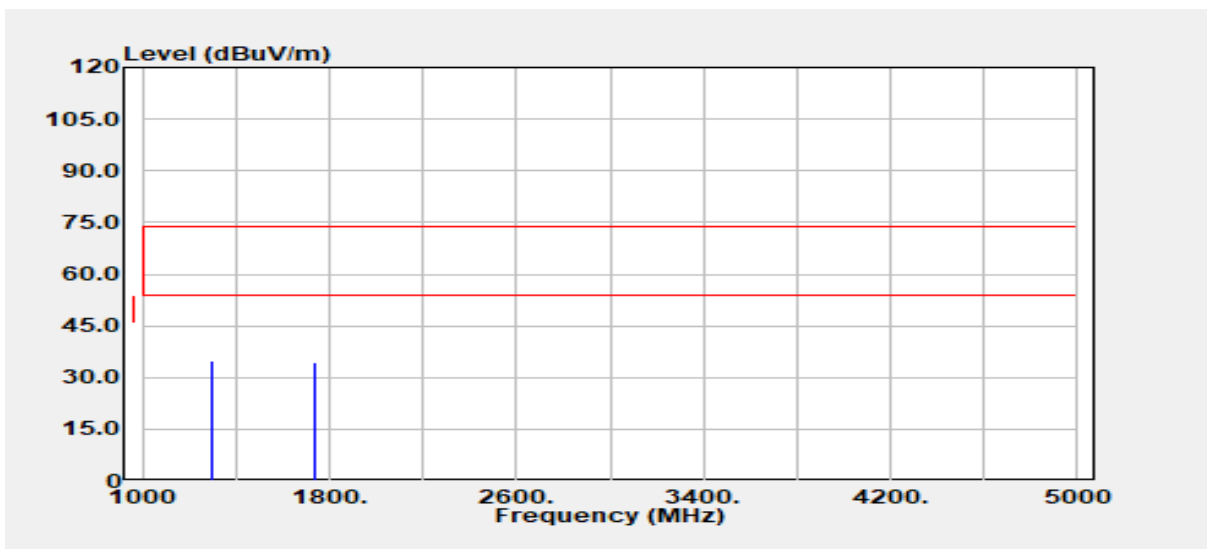

Freq. MHz	Detector Mode PK/QP/AV	Spectrum Read Level dB μ V	Factor dB	Actual FS dB μ V/m	Limit dB μ V/m	Margin dB
1301.76	Peak	42.43	-7.48	34.95	74.00	-39.05
1735.68	Peak	40.75	-6.34	34.41	74.00	-39.59

Remark:

1. Measuring frequencies from 1 GHz to the 10th harmonic of highest fundamental frequency.
2. For above 1GHz, the EUT peak value was under average limit, therefore the Average value compliance with the average limit.

2. 433.92MHz, (2) Config: 9214

Below 1GHz

Project No	:TM-2406000275P	Test Date	:2024-07-30
Operation Band	:433.92 MHz	Temp./Humi.	:24.6/57
Frequency	:433.92 MHz	Antenna Pol.	:VERTICAL
Operation Mode	:TX	Engineer	:Tony.Chao
EUT Pol	:E2	Test Chamber	: 966A
Setting	:EUT111 & 9214		

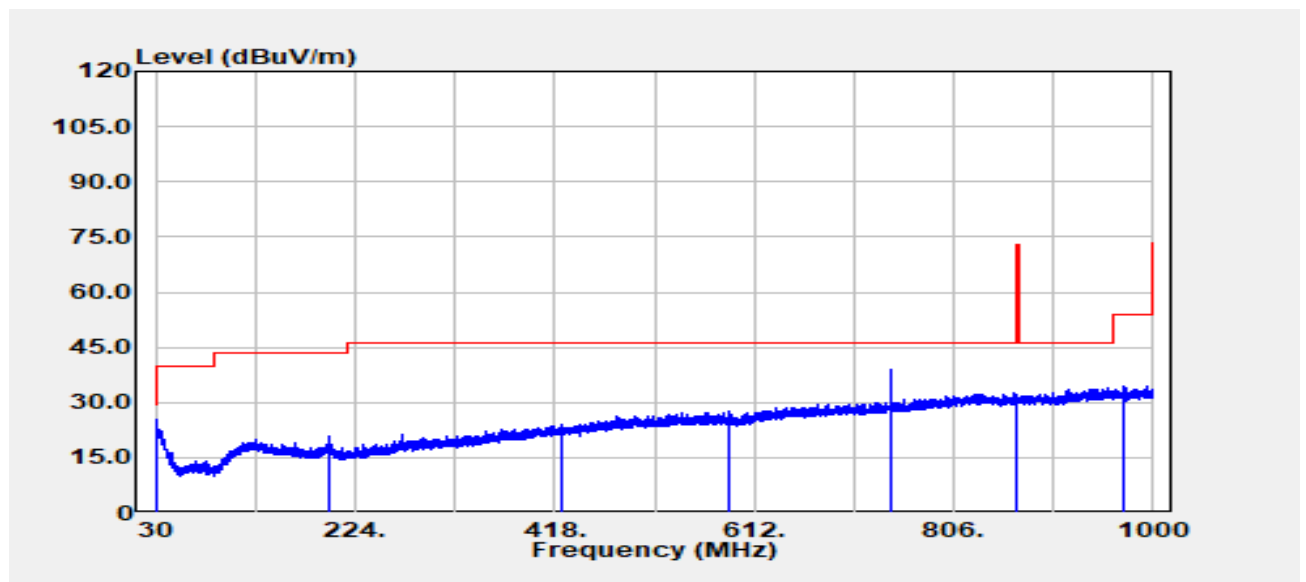

Freq. MHz	Detector Mode PK/QP/AV	Spectrum Read Level dB μ V	Factor dB	Actual FS dB μ V/m	Limit dB μ V/m	Margin dB
30.49	Peak	28.30	-2.84	25.46	40.00	-14.54
198.54	Peak	30.40	-9.73	20.67	43.50	-22.83
424.31	Peak	29.05	-4.99	24.06	46.00	-21.94
587.63	Peak	29.66	-2.12	27.54	46.00	-18.46
745.25	Peak	38.12	1.01	39.12	46.00	-6.88
867.84	Peak	29.44	2.96	32.40	72.87	-40.47
970.05	Peak	30.45	3.94	34.40	54.00	-19.60

Project No :TM-2406000275P
 Operation Band :433.92 MHz
 Frequency :433.92 MHz
 Operation Mode :TX
 EUT Pol :E2
 Setting :EUT111 & 9214

Test Date :2024-07-30
 Temp./Humi. :24.6/57
 Antenna Pol. :HORIZONTAL
 Engineer :Tony.Chao
 Test Chamber : 966A

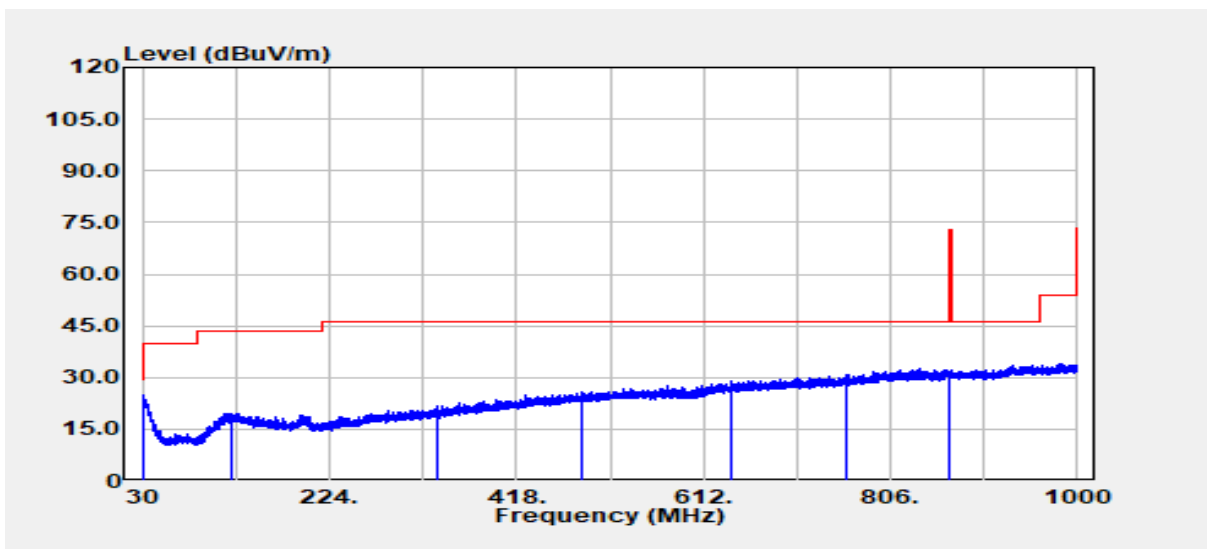

Freq. MHz	Detector Mode PK/QP/AV	Spectrum Read Level dB μ V	Factor dB	Actual FS dB μ V/m	Limit dB μ V/m	Margin dB
30.00	Peak	27.53	-2.40	25.13	29.54	-4.41
122.27	Peak	28.54	-9.07	19.47	43.50	-24.03
335.19	Peak	29.73	-7.82	21.92	46.00	-24.08
485.54	Peak	29.42	-3.43	25.99	46.00	-20.01
639.52	Peak	28.67	-0.42	28.24	46.00	-17.76
761.14	Peak	29.71	1.20	30.91	46.00	-15.09
867.84	Peak	29.21	2.96	32.17	72.87	-40.70

Above 1GHz

Project No	:TM-2406000275P	Test Date	:2024-07-31
Operation Band	:433.92 MHz	Temp./Humi.	:24.6/57
Frequency	:433.92 MHz	Antenna Pol.	:VERTICAL
Operation Mode	:TX	Engineer	:Ray.Li
EUT Pol	:E2	Test Chamber	: 966A
Setting	:EUT111 & 9214		

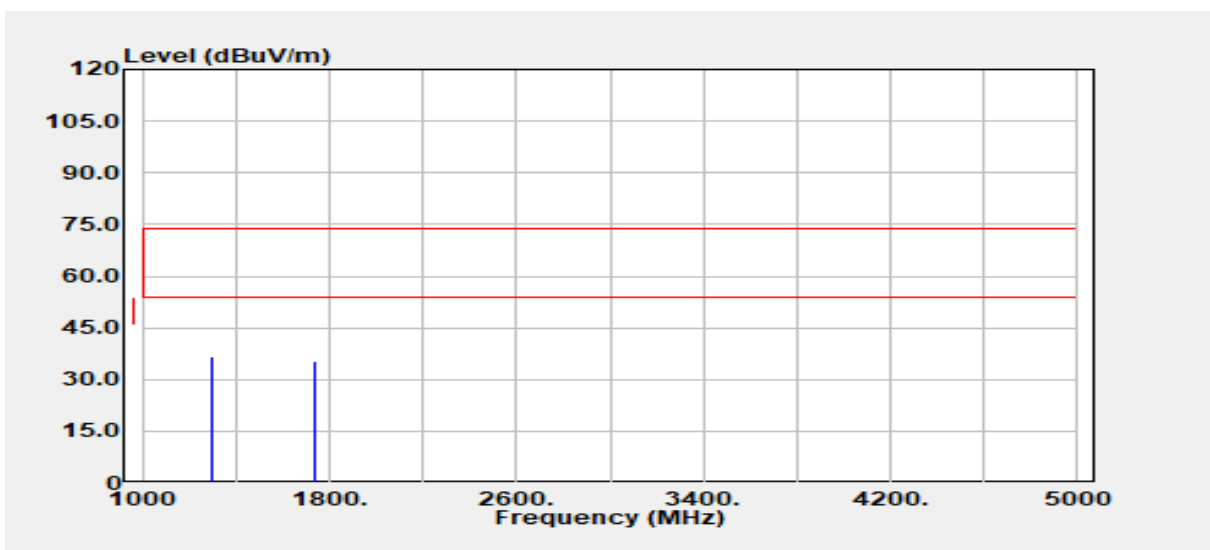

Freq. MHz	Detector Mode PK/QP/AV	Spectrum Read Level dB μ V	Factor dB	Actual FS dB μ V/m	Limit dB μ V/m	Margin dB
1301.76	Peak	44.14	-7.48	36.66	74.00	-37.34
1735.68	Peak	41.54	-6.34	35.20	74.00	-38.80

Remark:

1. Measuring frequencies from 1 GHz to the 10th harmonic of highest fundamental frequency.
2. For above 1GHz, the EUT peak value was under average limit, therefore the Average value compliance with the average limit.

Project No :TM-2406000275P
 Operation Band :433.92 MHz
 Frequency :433.92 MHz
 Operation Mode :TX
 EUT Pol :E2
 Setting :EUT111 & 9214

Test Date :2024-07-31
 Temp./Humi. :24.6/57
 Antenna Pol. :HORIZONTAL
 Engineer :Ray.Li
 Test Chamber : 966A

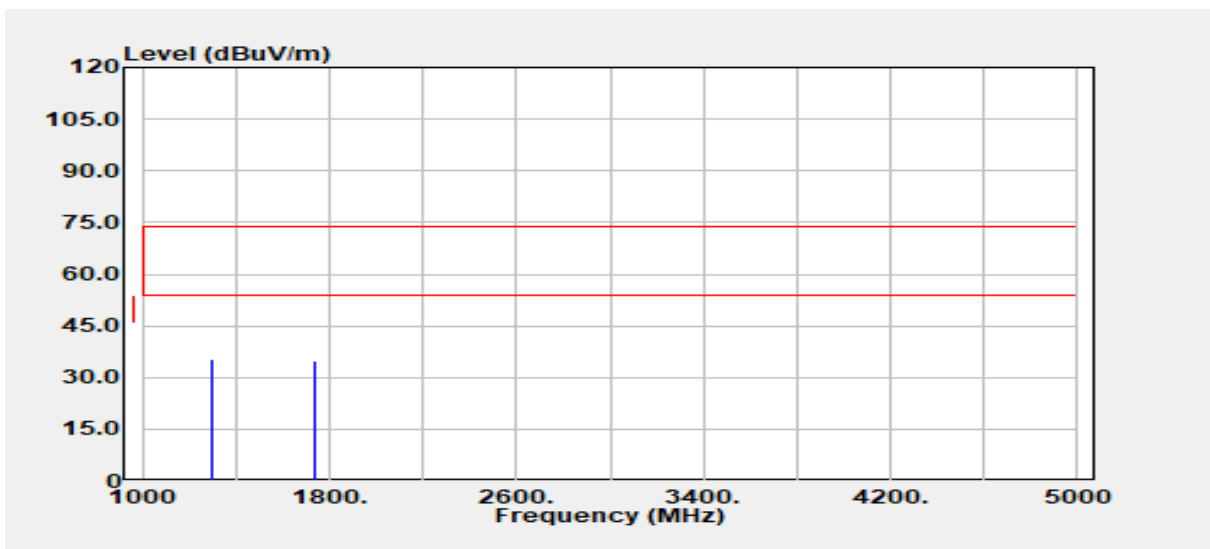

Freq. MHz	Detector Mode PK/QP/AV	Spectrum Read Level dB μ V	Factor dB	Actual FS dB μ V/m	Limit dB μ V/m	Margin dB
1301.76	Peak	42.79	-7.48	35.31	74.00	-38.69
1735.68	Peak	41.33	-6.34	35.00	74.00	-39.00

Remark:

1. Measuring frequencies from 1 GHz to the 10th harmonic of highest fundamental frequency.
2. For above 1GHz, the EUT peak value was under average limit, therefore the Average value compliance with the average limit.

2. 433.92MHz, (3) Config: EC01

Below 1GHz

Project No	:TM-2406000275P	Test Date	:2024-07-30
Operation Band	:433.92 MHz	Temp./Humi.	:24.6/57
Frequency	:433.92 MHz	Antenna Pol.	:VERTICAL
Operation Mode	:TX	Engineer	:Tony.Chao
EUT Pol	:E2	Test Chamber	: 966A
Setting	:EUT111 & EC01		

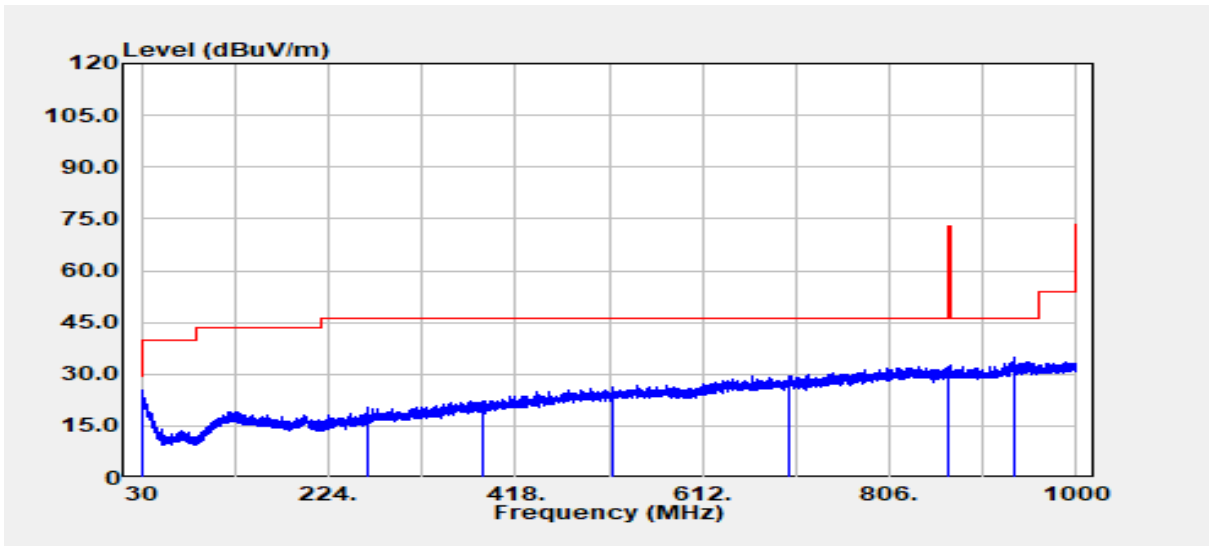

Freq. MHz	Detector Mode PK/QP/AV	Spectrum Read Level dB μ V	Factor dB	Actual FS dB μ V/m	Limit dB μ V/m	Margin dB
30.36	Peak	27.95	-2.73	25.22	40.00	-14.78
264.98	Peak	29.63	-9.22	20.41	46.00	-25.59
383.93	Peak	28.65	-6.39	22.26	46.00	-23.74
519.00	Peak	29.15	-3.08	26.07	46.00	-19.93
700.51	Peak	29.07	0.25	29.32	46.00	-16.68
867.84	Peak	29.49	2.96	32.45	72.87	-40.42
934.53	Peak	30.94	3.94	34.88	46.00	-11.12

Project No	:TM-2406000275P	Test Date	:2024-07-30
Operation Band	:433.92 MHz	Temp./Humi.	:24.6/57
Frequency	:433.92 MHz	Antenna Pol.	:HORIZONTAL
Operation Mode	:TX	Engineer	:Tony.Chao
EUT Pol	:E2	Test Chamber	: 966A
Setting	:EUT111 & EC01		

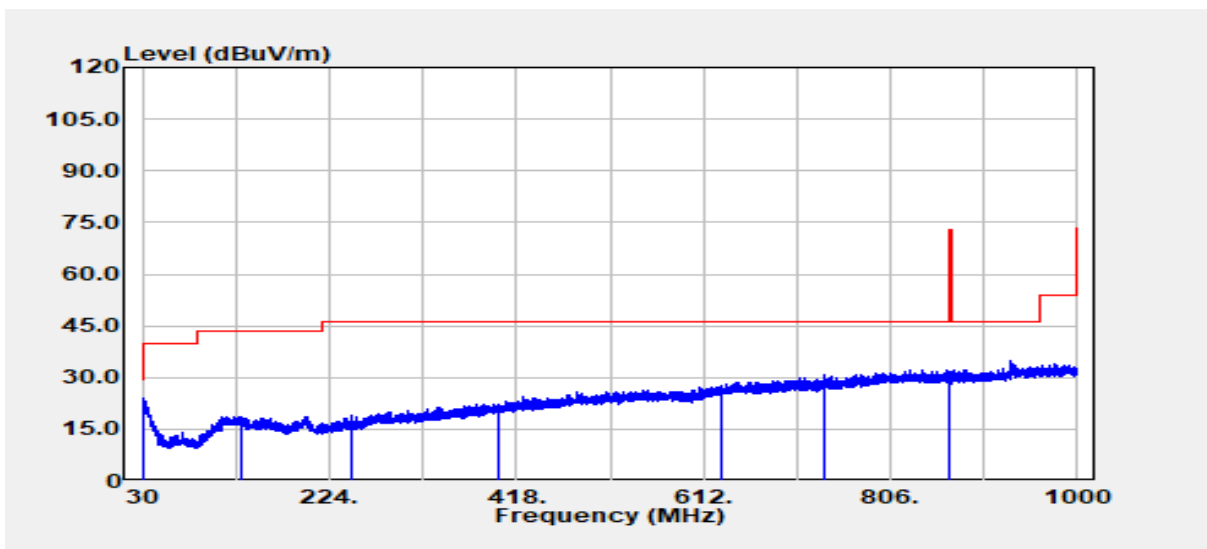

Freq. MHz	Detector Mode PK/QP/AV	Spectrum Read Level dB μ V	Factor dB	Actual FS dB μ V/m	Limit dB μ V/m	Margin dB
30.24	Peak	26.52	-2.62	23.90	40.00	-16.10
131.37	Peak	27.88	-9.26	18.62	43.50	-24.88
247.16	Peak	29.50	-10.56	18.94	46.00	-27.06
400.42	Peak	28.08	-5.69	22.39	46.00	-23.61
629.46	Peak	27.87	-0.62	27.25	46.00	-18.75
737.01	Peak	29.88	0.79	30.67	46.00	-15.33
867.84	Peak	29.20	2.96	32.16	72.87	-40.71

Above 1GHz

Project No	:TM-2406000275P	Test Date	:2024-07-31
Operation Band	:433.92 MHz	Temp./Humi.	:24.6/57
Frequency	:433.92 MHz	Antenna Pol.	:VERTICAL
Operation Mode	:TX	Engineer	:Ray.Li
EUT Pol	:E2	Test Chamber	: 966A
Setting	:EUT111 & EC01		

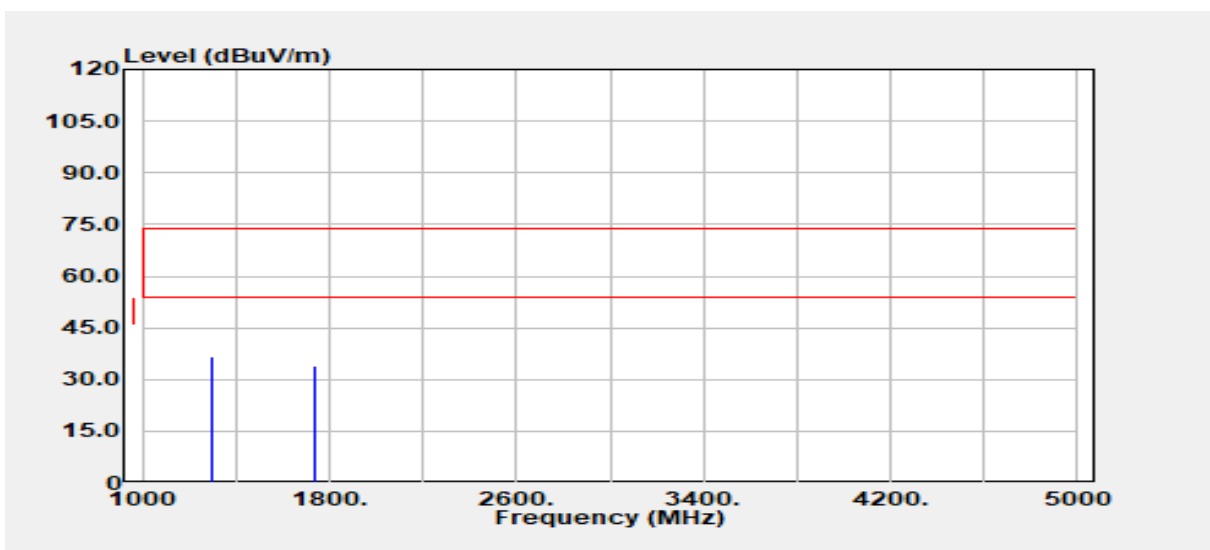

Freq. MHz	Detector Mode PK/QP/AV	Spectrum Read Level dB μ V	Factor dB	Actual FS dB μ V/m	Limit dB μ V/m	Margin dB
1301.76	Peak	44.27	-7.48	36.79	74.00	-37.21
1735.68	Peak	40.22	-6.34	33.89	74.00	-40.11

Remark:

1. Measuring frequencies from 1 GHz to the 10th harmonic of highest fundamental frequency.
2. For above 1GHz, the EUT peak value was under average limit, therefore the Average value compliance with the average limit.

Project No	:TM-2406000275P	Test Date	:2024-07-31
Operation Band	:433.92 MHz	Temp./Humi.	:24.6/57
Frequency	:433.92 MHz	Antenna Pol.	:HORIZONTAL
Operation Mode	:TX	Engineer	:Ray.Li
EUT Pol	:E2	Test Chamber	: 966A
Setting	:EUT111 & EC01		

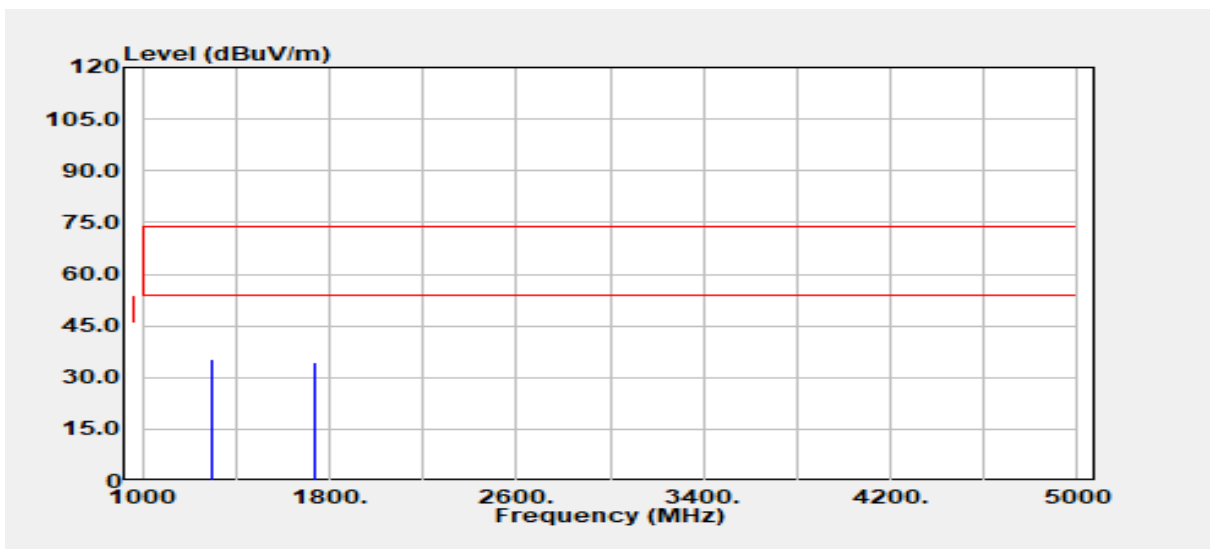

Freq. MHz	Detector Mode PK/QP/AV	Spectrum Read Level dB μ V	Factor dB	Actual FS dB μ V/m	Limit dB μ V/m	Margin dB
1301.76	Peak	42.66	-7.48	35.18	74.00	-38.82
1735.68	Peak	40.64	-6.34	34.30	74.00	-39.70

Remark:

1. Measuring frequencies from 1 GHz to the 10th harmonic of highest fundamental frequency.
2. For above 1GHz, the EUT peak value was under average limit, therefore the Average value compliance with the average limit.

4.5 OPERATION RESTRICTION

4.5.1 Test Limit

According to §15.231(e)

In addition, devices operated under the provisions of this paragraph shall be provided with a means for automatically limiting operation so that the duration of each transmission shall not be greater than one second and the silent period between transmissions shall be at least 30 times the duration of the transmission but in no case less than 10 seconds.

According to §15.231(a)(3)

Periodic transmissions at regular predetermined intervals are not permitted. However, polling or supervision transmissions, including data, to determine system integrity of transmitters used in security or safety applications are allowed if the total duration of transmissions does not exceed more than two seconds per hour for each transmitter. There is no limit on the number of individual transmissions, provided the total transmission time does not exceed two seconds per hour.

4.5.2 Test Procedure

Test method Refer as ANSI 63.10:2013 clause 7.4

Set the RBW=1MHz, VBW=1MHz, Detector = Peak, Trace mode = Max hold, Sweep = 1s. Measure

4.5.3 Test Setup

Refer to section 1.8.

4.5.4 Test Result

Temperature: 21.8°C

Test Date: July 11, 2024

Humidity: 56% RH

Tested by: Jerry Chang

Dwell Time				
Frequency (MHz)	Config	Total Pulse On Time (ms)	Off Time (ms)	Result
314.97	E814	60	16100	Pass
	9214	100.8	16100	Pass
	EC01	41.2	16100	Pass
433.92	E814	60	16080	Pass
	9214	100.8	16080	Pass
	EC01	41.2	16080	Pass

Test Data Duty Cycle

314.97MHz	433.92MHz
------------------	------------------

(1) Config: E814

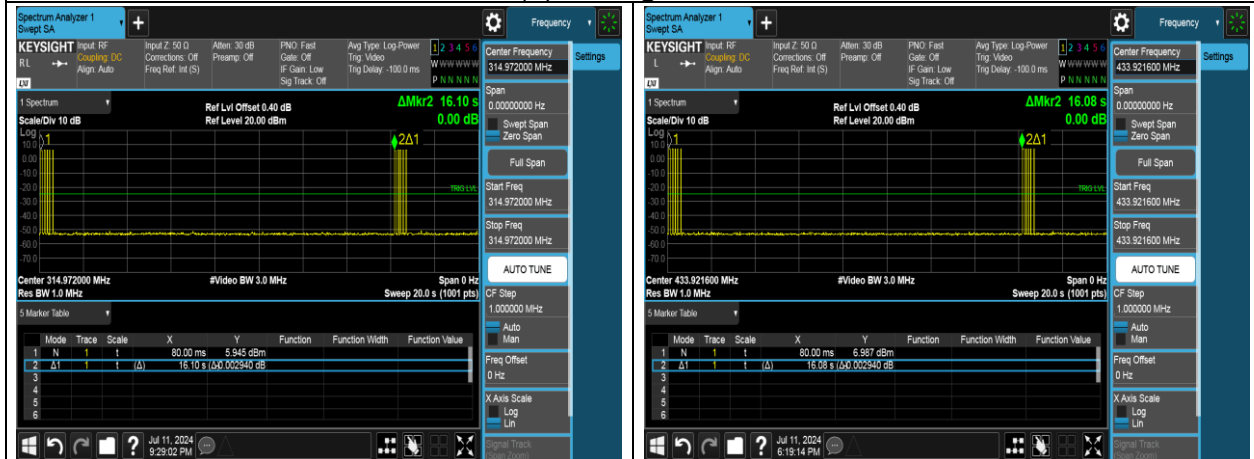

(2) Config: 9214

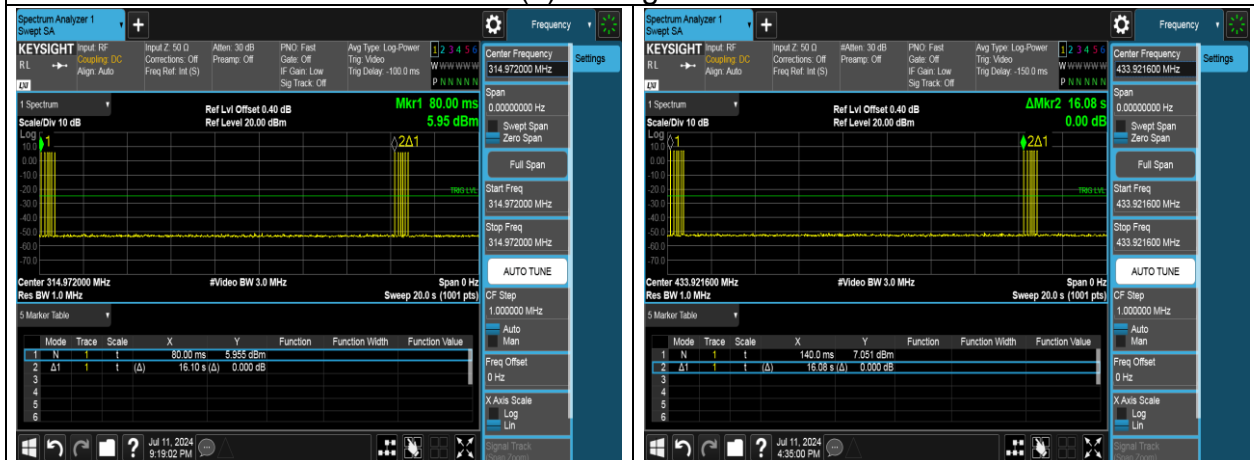

(3) Config: EC01

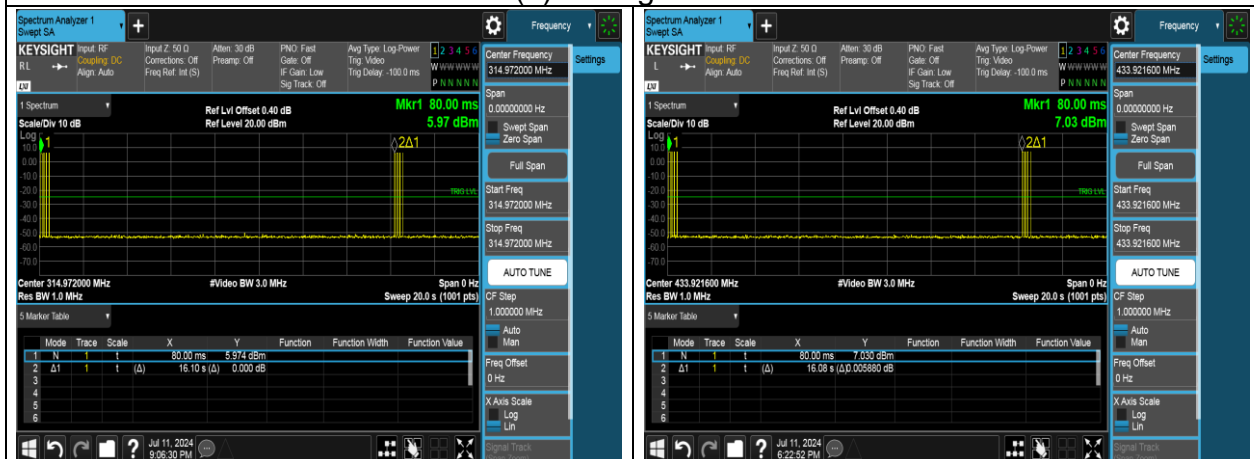

4.6 ANTENNA REQUIREMENT

§ 15.203 Antenna requirement.

An intentional radiator shall be designed to ensure that no antenna other than that furnished by the responsible party shall be used with the device. The use of a permanently attached antenna or of an antenna that uses a unique coupling to the intentional radiator shall be considered sufficient to comply with the provisions of this section. The manufacturer may design the unit so that a broken antenna can be replaced by the user, but the use of a standard antenna jack or electrical connector is prohibited. This requirement does not apply to carrier current devices or to devices operated under the provisions of §15.211, §15.213, §15.217, §15.219, or §15.221. Further, this requirement does not apply to intentional radiators that must be professionally installed, such as perimeter protection systems and some field disturbance sensors, or to other intentional radiators which, in accordance with §15.31(d), must be measured at the installation site. However, the installer shall be responsible for ensuring that the proper antenna is employed so that the limits in this part are not exceeded.

Antenna Type	<input type="checkbox"/> PIFA <input type="checkbox"/> PCB <input type="checkbox"/> Dipole <input type="checkbox"/> Coils <input checked="" type="checkbox"/> Other: LOOP SMD Dual Frequency
Antenna Gain	314.97 MHz: Gain: -31 dBi 433.92 MHz: Gain: -24 dBi

Remark:

1.The antenna(s) of the EUT are permanently attached and there are no provisions for connection to an external antenna. So the EUT complies with the requirements of §15.203.

- End of Test Report -