



FCC RF Test Report

APPLICANT : Realme Chongqing Mobile Telecommunications Corp., Ltd.
EQUIPMENT : Mobile Phone
BRAND NAME : realme
MODEL NAME : RMX3999
FCC ID : 2AUYFRMX3999
STANDARD : 47 CFR Part 2, 27(M)
CLASSIFICATION : PCS Licensed Transmitter Held to Ear (PCE)
TEST DATE(S) : Dec. 27, 2023 ~ Jan. 08, 2024

We, Sporton International Inc. (Shenzhen), would like to declare that the tested sample has been evaluated in accordance with the procedures given in ANSI C63.26-2015 and shown compliance with the applicable technical standards.

The test results in this report apply exclusively to the tested model / sample. Without written approval of Sporton International Inc. (Shenzhen), the test report shall not be reproduced except in full.

Jason Jia



Approved by: Jason Jia

Sporton International Inc. (ShenZhen)

1/F, 2/F, Bldg 5, Shiling Industrial Zone, Xinwei Village, Xili, Nanshan, Shenzhen, 518055

People's Republic of China



TABLE OF CONTENTS

REVISION HISTORY 3
SUMMARY OF TEST RESULT 4
1 GENERAL DESCRIPTION 5
1.1 Applicant 5
1.2 Manufacturer 5
1.3 Product Feature of Equipment Under Test 5
1.4 Product Specification of Equipment Under Test 5
1.5 Modification of EUT 6
1.6 Maximum ERP/EIRP Power and Emission Designator 7
1.7 Testing Location 9
1.8 Test Software 9
1.9 Applicable Standards 9
2 TEST CONFIGURATION OF EQUIPMENT UNDER TEST 10
2.1 Test Mode 10
2.2 Connection Diagram of Test System 12
2.3 Support Unit used in test configuration and system 12
2.4 Measurement Results Explanation Example 13
2.5 Frequency List of Low/Middle/High Channels 13
3 CONDUCTED TEST ITEMS 17
3.1 Measuring Instruments 17
3.2 Test Setup 17
3.3 Test Result of Conducted Test 17
3.4 Conducted Output Power and ERP/EIRP 18
3.5 Peak-to-Average Ratio 19
3.6 Occupied Bandwidth 20
3.7 Conducted Band Edge 21
3.8 Conducted Spurious Emission 22
3.9 Frequency Stability 23
4 RADIATED TEST ITEMS 24
4.1 Measuring Instruments 24
4.2 Test Setup 24
4.3 Test Result of Radiated Test 25
4.4 Radiated Spurious Emission 26
5 LIST OF MEASURING EQUIPMENT 27
6 MEASUREMENT UNCERTAINTY 28
APPENDIX A. TEST RESULTS OF CONDUCTED TEST
APPENDIX B. TEST RESULTS OF RADIATED TEST
APPENDIX C. TEST SETUP PHOTOGRAPHS



SUMMARY OF TEST RESULT

Report Section	FCC Rule	Description	Limit	Result	Remark
3.4	§2.1046	Conducted Output Power	-	Report Only	-
	§27.50(h)(2)	Equivalent Isotropic Radiated Power (Band 7) (Band 38) (Band 41)	EIRP < 2Watt		-
3.5	§24.232(d)	Peak-to-Average Ratio	<13 dB	PASS	-
3.6	§2.1049	Occupied Bandwidth	-	Report Only	-
3.7	§27.53(m)(4)	Conducted Band Edge Measurement (Band 7) (Band 38) (Band 41)	§27.53(m)(4)	PASS	-
3.8	§2.1051 §27.53(m)(4)	Conducted Spurious Emission (Band 7) (Band 38) (Band 41)	< 55+10log ₁₀ (P[Watts])	PASS	-
3.9	§2.1055 §22.355	Frequency Stability Temperature & Voltage	< 2.5 ppm for Part 22	PASS	-
	§2.1055 §24.235 §27.54		Within Authorized Band		
4.4	§2.1053 §27.53(m)(4)	Radiated Spurious Emission (Band 7) (Band 38) (Band 41)	< 55+10log ₁₀ (P[Watts])	PASS	Under limit 25.18 dB at 10296.40 MHz

Conformity Assessment Condition:

- The test results (PASS/FAIL) with all measurement uncertainty excluded are presented against the regulation limits or in accordance with the requirements stipulated by the applicant/manufacturer who shall bear all the risks of non-compliance that may potentially occur if measurement uncertainty is taken into account.
- The measurement uncertainty please refer to each test result in the section "Measurement Uncertainty"

Disclaimer:

The product specifications of the EUT presented in the test report that may affect the test assessments are declared by the manufacturer who shall take full responsibility for the authenticity.



1 General Description

1.1 Applicant

Realme Chongqing Mobile Telecommunications Corp., Ltd.
No.178 Yulong Avenue, Yufengshan, Yubei District, Chongqing, China

1.2 Manufacturer

Realme Chongqing Mobile Telecommunications Corp., Ltd.
No.178 Yulong Avenue, Yufengshan, Yubei District, Chongqing, China

1.3 Product Feature of Equipment Under Test

Product Feature	
Equipment	Mobile Phone
Brand Name	realme
Model Name	RMX3999
FCC ID	2AUYFRMX3999
IMEI Code	Conducted: 863155070029978/863155070029960 Radiation: 863155070031834/863155070031826
HW Version	11
SW Version	realme UI 5.0
EUT Stage	Production Unit

1.4 Product Specification of Equipment Under Test

Standards-related Product Specification	
Tx Frequency	LTE Band 7 : 2500 MHz ~ 2570 MHz LTE Band 38 : 2570 MHz ~ 2620 MHz LTE Band 41 : 2496 MHz ~ 2690 MHz
Rx Frequency	LTE Band 7 : 2620 MHz ~ 2690 MHz LTE Band 38 : 2570 MHz ~ 2620 MHz LTE Band 41 : 2496 MHz ~ 2690 MHz
Bandwidth	LTE Band 7 : 5MHz/ 10MHz / 15MHz / 20MHz LTE Band 38 : 5MHz / 10MHz / 15MHz / 20MHz LTE Band 41 : 5MHz / 10MHz / 15MHz / 20MHz
Maximum Output Power to Antenna	Ant.0 LTE Band 7 : 22.78 dBm LTE Band 38 : 23.39 dBm LTE Band 41 : 23.91 dBm Ant.1 LTE Band 7 : 22.84 dBm LTE Band 38 : 23.25 dBm LTE Band 41 : 17.36 dBm Ant.2 LTE Band 7 : 22.24 dBm LTE Band 38 : 22.08 dBm LTE Band 41 : 22.85 dBm



Antenna Gain	Ant.0 LTE Band 7 : 0.32 dBi LTE Band 38 : 0.32 dBi LTE Band 41 : 0.35 dBi
	Ant.1 LTE Band 7 : -0.72 dBi LTE Band 38 : -0.72 dBi LTE Band 41 : -0.70 dBi
	Ant.2 LTE Band 7 : -3.12 dBi LTE Band 38 : -3.40 dBi LTE Band 41 : -3.40 dBi
	Type of Modulation : QPSK / 16QAM / 64QAM

Remark:

1. WWAN Antenna 0/1/2 only support antenna switch, not support MIMO.
2. The maximum EIRP is calculated from max output power and max antenna gain, only the maximum EIRP of Ant.0 for LTE Band 7/38/41/7C/38C/41C are shown in the report.
3. LTE Band 7/38/41 support two PAs, both the PA are full tested, only the maximum EIRP of main PA is shown in the report.

1.5 Modification of EUT

No modifications are made to the EUT during all test items.



1.6 Maximum ERP/EIRP Power and Emission Designator

LTE Band 7		QPSK		16QAM/64QAM	
BW (MHz)	Frequency Range (MHz)	Maximum EIRP(W)	Emission Designator (99%OBW)	Maximum EIRP(W)	Emission Designator (99%OBW)
5	2502.5 ~ 2567.5	0.1977	4M50G7D	0.1854	4M50W7D
10	2505.0 ~ 2565.0	0.1982	9M05G7D	0.1862	9M05W7D
15	2507.5 ~ 2562.5	0.1995	13M5G7D	0.1871	13M5W7D
20	2510.0 ~ 2560.0	0.2042	17M9G7D	0.1854	18M0W7D
LTE Band 38		QPSK		16QAM/64QAM	
BW (MHz)	Frequency Range (MHz)	Maximum EIRP(W)	Emission Designator (99%OBW)	Maximum EIRP(W)	Emission Designator (99%OBW)
5	2572.5 ~ 2617.5	0.2333	4M51G7D	0.1936	4M49W7D
10	2575.0 ~ 2615.0	0.2307	9M07G7D	0.1936	9M05W7D
15	2577.5 ~ 2612.5	0.2339	13M5G7D	0.1897	13M5W7D
20	2580.0 ~ 2610.0	0.2350	17M9G7D	0.1919	17M9W7D
LTE Band 41		QPSK		16QAM/64QAM	
BW (MHz)	Frequency Range (MHz)	Maximum EIRP(W)	Emission Designator (99%OBW)	Maximum EIRP(W)	Emission Designator (99%OBW)
5	2498.5 ~ 2687.5	0.2636	4M51G7D	0.1932	4M49W7D
10	2501.0 ~ 2685.0	0.2655	9M07G7D	0.1914	9M05W7D
15	2503.5 ~ 2682.5	0.2661	13M5G7D	0.1919	13M5W7D
20	2506.0 ~ 2680.0	0.2612	17M9G7D	0.1928	17M9W7D

LTE Band 7 CA	QPSK		16QAM/64QAM	
BW (MHz)	Maximum EIRP(W)	Emission Designator (99%OBW)	Maximum EIRP(W)	Emission Designator (99%OBW)
10MHz+20MHz	0.1928	27M9G7D	0.1726	28M2W7D
15MHz+15MHz	0.1923	28M5G7D	0.1738	28M7W7D
15MHz+20MHz	0.1910	32M7G7D	0.1730	32M4W7D
15MHz+10MHz	0.1928	23M4G7D	0.1734	23M1W7D
20MHz+10MHz	0.1919	27M9G7D	0.1738	27M8W7D
20MHz+15MHz	0.1932	32M7G7D	0.1742	33M0W7D
20MHz+20MHz	0.1941	37M7G7D	0.1746	37M2W7D



LTE Band 38 CA	QPSK		16QAM/64QAM	
BW (MHz)	Maximum EIRP(W)	Emission Designator (99%OBW)	Maximum EIRP(W)	Emission Designator (99%OBW)
15MHz+15MHz	0.1892	28M6G7D	0.1542	28M6W7D
20MHz+20MHz	0.1923	37M7G7D	0.1556	37M5W7D

LTE Band 41 CA	QPSK		16QAM/64QAM	
BW (MHz)	Maximum EIRP(W)	Emission Designator (99%OBW)	Maximum EIRP(W)	Emission Designator (99%OBW)
5MHz+20MHz	0.2198	23M1G7D	0.1782	23M3W7D
10MHz+20MHz	0.2213	28M1G7D	0.1782	27M8W7D
10MHz+15MHz	0.2203	23M3G7D	0.1795	23M2W7D
15MHz+15MHz	0.2193	28M6G7D	0.1786	28M6W7D
15MHz+20MHz	0.2203	32M5G7D	0.1782	32M5W7D
15MHz+10MHz	0.2198	23M3G7D	0.1782	23M5W7D
20MHz+5MHz	0.2208	23M2G7D	0.1786	23M1W7D
20MHz+10MHz	0.2208	27M9G7D	0.1795	28M0W7D
20MHz+15MHz	0.2218	32M6G7D	0.1803	32M9W7D
20MHz+20MHz	0.2228	37M7G7D	0.1816	37M5W7D

Note: LTE Band 41 overlaps the entire frequency range of LTE Band 38. Therefore, the test results provided in this report covers Band 41 as well as Band 38.



1.7 Testing Location

Sporton International Inc. (ShenZhen) is accredited to ISO/IEC 17025:2017 by American Association for Laboratory Accreditation with Certificate Number 5145.01.

Test Firm	Sporton International Inc. (ShenZhen)		
Test Site Location	1/F, 2/F, Bldg 5, Shiling Industrial Zone, Xinwei Village, Xili, Nanshan, Shenzhen, 518055 People's Republic of China TEL: +86-755-86379589 FAX: +86-755-86379595		
Test Site No.	Sporton Site No.	FCC Designation No.	FCC Test Firm Registration No.
	TH01-SZ	CN1256	421272

Test Firm	Sporton International Inc. (ShenZhen)		
Test Site Location	101, 1st Floor, Block B, Building 1, No. 2, Tengfeng 4th Road, Fenghuang Community, Fuyong Street, Baoan District, Shenzhen City, Guangdong Province 518103 People's Republic of China TEL: +86-755-86066985		
Test Site No.	Sporton Site No.	FCC Designation No.	FCC Test Firm Registration No.
	03CH01-SZ	CN1256	421272

1.8 Test Software

Item	Site	Manufacture	Name	Version
1.	03CH01-SZ	AUDIX	E3	6.2009-8-24

1.9 Applicable Standards

According to the specifications of the manufacturer, the EUT must comply with the requirements of the following standards:

- ♦ 47 CFR Part 2, 27(M)
- ♦ ANSI C63.26-2015
- ♦ FCC KDB 971168 D01 Power Meas License Digital Systems v03r01
- ♦ FCC KDB 412172 D01 Determining ERP and EIRP v01r01

Remark:

1. All test items were verified and recorded according to the standards and without any deviation during the test.
2. This EUT has also been tested and complied with the requirements of FCC Part 15, Subpart B, recorded in a separate test report.



2 Test Configuration of Equipment Under Test

2.1 Test Mode

Antenna port conducted and radiated test items listed below are performed according to KDB 971168 D01 Power Meas License Digital Systems v03r01 with maximum output power.

Radiated measurements are performed by rotating the EUT in three different orthogonal test planes to find the maximum emission. (Y Plane)

Test Items	Band	Bandwidth (MHz)						Modulation			RB #			Test Channel			
		1.4	3	5	10	15	20	QPSK	16 QAM	64 QAM	1	Half	Full	L	M	H	
Max. Output Power	7	-	-	v	v	v	v	v	v	v	v	v	v	v	v	v	
	38	-	-	v	v	v	v	v	v	v	v	v	v	v	v	v	
	41	-	-	v	v	v	v	v	v	v	v	v	v	v	v	v	
Peak-to-Average Ratio	7	-	-				v	v	v	v			v		v		
	41	-	-				v	v	v	v			v		v		
26dB and 99% Bandwidth	7	-	-	v	v	v	v	v	v				v		v		
	41	-	-	v	v	v	v	v	v				v		v		
Conducted Band Edge	7	-	-	v	v	v	v	v	v	v	v		v	v		v	
	41	-	-	v	v	v	v	v	v	v	v		v	v		v	
Conducted Spurious Emission	7	-	-	v	v	v	v	v				v		v	v	v	
	41	-	-	v	v	v	v	v				v		v	v	v	
Frequency Stability	7	-	-		v			v					v		v		
	41	-	-		v			v					v		v		
E.R.P / E.I.R.P	7	-	-	v	v	v	v	v	v	v	v			v	v	v	
	41	-	-	v	v	v	v	v	v	v	v			v	v	v	
Radiated Spurious Emission	7	Worst Case														v	
	41	Worst Case														v	
Note	<ol style="list-style-type: none"> The mark "v" means that this configuration is chosen for testing The mark "-" means that this bandwidth is not supported. The device is investigated from 30MHz to 10 times of fundamental signal for radiated spurious emission test under different RB size/offset and modulations in exploratory test. Subsequently, only the worst case emissions are reported. 																



Test Items	Band	Bandwidth (MHz)									Modulation			RB #			Test Channel			
		20+20	20+15	15+20	20+10	10+20	20+5	5+20	15+15	15+10	10+15	QPSK	16QAM	64QAM	1	Half	Full	L	M	H
Max. Output Power	7C_CA	v	v	v	v	v	-	-	v	v	-	v	v		v	v	v	v	v	v
	38C_CA	v	-	-	-	-	-	-	v	-	-	v	v		v	v	v	v	v	v
	41C_CA	v	v	v	v	v	v	v	v	v	v	v	v		v	v	v	v	v	v
26dB and 99% Bandwidth	7C_CA	v	v	v	v	v	-	-	v	v	-	v	v	v			v		v	
	38C_CA	v	-	-	-	-	-	-	v	-	-	v	v	v			v		v	
	41C_CA	v	v	v	v	v	v	v	v	v	v	v	v	v			v		v	
Conducted Band Edge	7C_CA	v	v	v	v	v	-	-	v	v	-	v	v	v	v		v	v		v
	38C_CA	v	-	-	-	-	-	-	v	-	-	v	v	v	v		v	v		v
	41C_CA	v	v	v	v	v	v	v	v	v	v	v	v	v	v		v	v		v
Conducted Spurious Emission	7C_CA	v	v	v	v	v	-	-	v	v	-	v			v			v	v	v
	38C_CA	v	-	-	-	-	-	-	v	-	-	v			v			v	v	v
	41C_CA	v	v	v	v	v	v	v	v	v	v	v			v			v	v	v
E.I.R.P.	7C_CA	v	v	v	v	v	-	-	v	v	-	v	v	v	v			v	v	v
	38C_CA	v	-	-	-	-	-	-	v	-	-	v	v	v	v			v	v	v
	41C_CA	v	v	v	v	v	v	v	v	v	v	v	v	v	v			v	v	v
Radiated Spurious Emission	7C_CA	Worst Case																		v
	38C_CA	Worst Case																		v
	41C_CA	Worst Case																		v
Note	1. The mark "v" means that this configuration is chosen for testing 2. The mark "-" means that this bandwidth is not supported. 3. The device is investigated from 30MHz to 10 times of fundamental signal for radiated spurious emission test under different RB size/offset and modulations in exploratory test. Subsequently, only the worst case emissions are reported.																			

2.2 Connection Diagram of Test System

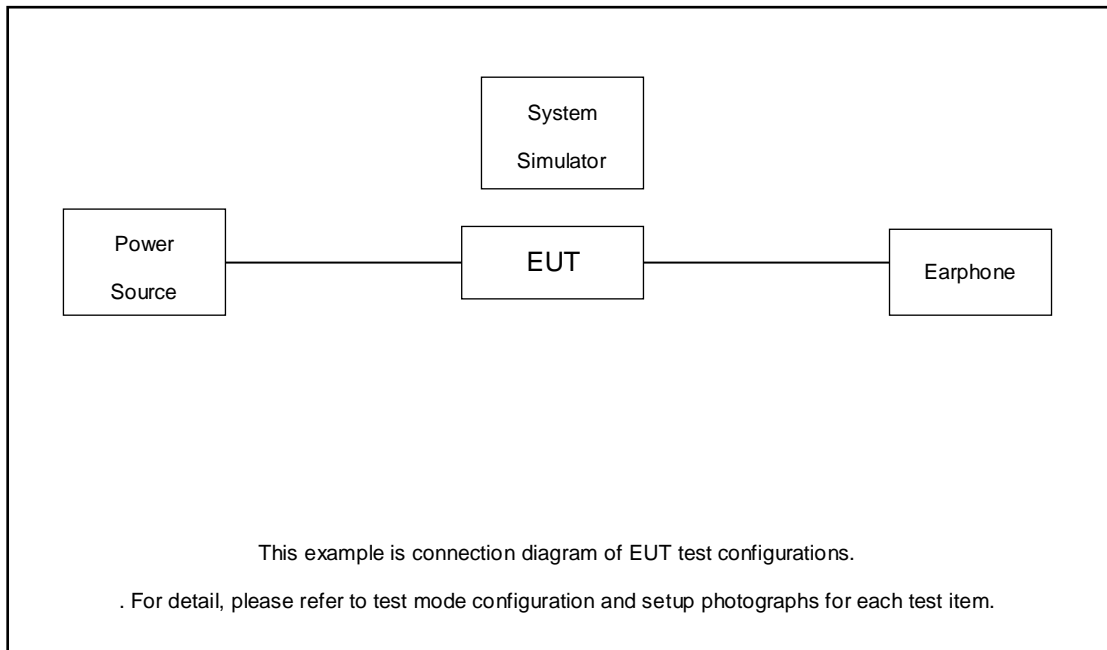

2.3 Support Unit used in test configuration and system

Item	Equipment	Trade Name	Model No.	FCC ID	Data Cable	Power Cord
1.	Power Supply	GWINSTEK	PSS-2002	N/A	N/A	Unshielded, 1.8 m
2.	LTE Base Station	Anritsu	MT8820C	N/A	N/A	Unshielded, 1.8 m
3.	LTE Base Station	Anritsu	MT8821C	N/A	N/A	Unshielded, 1.8 m
4.	Earphone	N/A	N/A	N/A	N/A	N/A



2.4 Measurement Results Explanation Example

For all conducted test items:

The offset level is set in the spectrum analyzer to compensate the RF cable loss and attenuator factor between EUT conducted output port and spectrum analyzer. With the offset compensation, the spectrum analyzer reading level is exactly the EUT RF output level.

The spectrum analyzer offset is derived from RF cable loss and attenuator factor.

$$\text{Offset} = \text{RF cable loss} + \text{attenuator factor}.$$

Following shows an offset computation example with cable loss 5.0 dB and 10dB attenuator.

Example :

$$\begin{aligned} \text{Offset(dB)} &= \text{RF cable loss(dB)} + \text{attenuator factor(dB)} \\ &= 5.0 + 10 = 15.0 \text{ (dB)} \end{aligned}$$

2.5 Frequency List of Low/Middle/High Channels

LTE Band 7 Channel and Frequency List				
BW [MHz]	Channel/Frequency(MHz)	Lowest	Middle	Highest
20	Channel	20850	21100	21350
	Frequency	2510	2535	2560
15	Channel	20825	21100	21375
	Frequency	2507.5	2535	2562.5
10	Channel	20800	21100	21400
	Frequency	2505	2535	2565
5	Channel	20775	21100	21425
	Frequency	2502.5	2535	2567.5

LTE Band 38 Channel and Frequency List				
BW [MHz]	Channel/Frequency(MHz)	Lowest	Middle	Highest
20	Channel	37850	38000	38150
	Frequency	2580	2595	2610
15	Channel	37825	38000	38175
	Frequency	2577.5	2595	2612.5
10	Channel	37800	38000	38200
	Frequency	2575	2595	2615
5	Channel	37775	38000	38225
	Frequency	2572.5	2595	2617.5



LTE Band 41 Channel and Frequency List				
BW [MHz]	Channel/Frequency(MHz)	Lowest	Middle	Highest
20	Channel	39750	40620	41490
	Frequency	2506	2593	2680
15	Channel	39725	40620	41515
	Frequency	2503.5	2593	2682.5
10	Channel	39700	40620	41540
	Frequency	2501	2593	2685
5	Channel	39675	40620	41565
	Frequency	2498.5	2593	2687.5

LTE Band 7C_CA Channel and Frequency List					
BW [MHz]	Channel/Frequency(MHz)	Lowest	Middle	Highest	
20 + 20	PCC	Channel	20850	21001	21152
		Frequency	2510.0	2525.1	2540.2
	SCC	Channel	21048	21199	21350
		Frequency	2529.8	2544.9	2560.0
20 + 15	PCC	Channel	20850	21026	21201
		Frequency	2510.0	2527.6	2545.1
	SCC	Channel	21021	21197	21372
		Frequency	2527.1	2544.7	2562.2
15 + 20	PCC	Channel	20828	21003	21179
		Frequency	2507.8	2525.3	2542.9
	SCC	Channel	20999	21174	21350
		Frequency	2524.9	2542.4	2560.0
20 + 10	PCC	Channel	20850	21051	21251
		Frequency	2510.0	2530.1	2550.1
	SCC	Channel	20994	21195	21395
		Frequency	2524.4	2544.5	2564.5
10 + 20	PCC	Channel	20805	21006	21206
		Frequency	2505.5	2525.6	2545.6
	SCC	Channel	20949	21150	21350
		Frequency	2519.9	2540.0	2560.0
15 + 15	PCC	Channel	20825	21025	21225
		Frequency	2507.5	2527.5	2547.5
	SCC	Channel	20975	21175	21375
		Frequency	2522.5	2542.5	2562.5
15 + 10	PCC	Channel	20825	21051	21277
		Frequency	2507.5	2530.1	2552.7
	SCC	Channel	20945	21171	21397
		Frequency	2519.5	2542.1	2564.7



LTE Band 38C_CA Channel and Frequency List					
BW [MHz]	Channel/Frequency(MHz)		Lowest	Middle	Highest
20 + 20	PCC	Channel	37850	37901	37952
		Frequency	2580.0	2585.1	2590.2
	SCC	Channel	38048	38099	38150
		Frequency	2599.8	2604.9	2610.0
15+ 15	PCC	Channel	37825	37925	38025
		Frequency	2577.5	2587.5	2597.5
	SCC	Channel	37975	38075	38175
		Frequency	2592.5	2602.5	2612.5

LTE Band 41C_CA Channel and Frequency List					
BW [MHz]	Channel/Frequency(MHz)		Lowest	Middle	Highest
20 + 20	PCC	Channel	39750	40521	41292
		Frequency	2506.0	2583.1	2660.2
	SCC	Channel	39948	40719	41490
		Frequency	2525.8	2602.9	2680.0
20 + 15	PCC	Channel	39750	40546	41341
		Frequency	2506.0	2585.6	2665.1
	SCC	Channel	39921	40717	41512
		Frequency	2523.1	2602.7	2682.2
15 + 20	PCC	Channel	39728	40523	41319
		Frequency	2503.8	2593.3	2662.9
	SCC	Channel	39899	40694	41490
		Frequency	2520.9	2600.4	2680.0
20 + 10	PCC	Channel	39750	40571	41391
		Frequency	2506.0	2588.1	2670.1
	SCC	Channel	39894	40715	41535
		Frequency	2520.4	2602.5	2684.5
10 + 20	PCC	Channel	39705	40526	41346
		Frequency	2501.5	2583.6	2665.6
	SCC	Channel	39849	40670	41490
		Frequency	2515.9	2598.0	2680.0



LTE Band 41C_CA Channel and Frequency List					
20 + 5	PCC	Channel	39750	40595	41440
		Frequency	2506.0	2590.5	2675.0
	SCC	Channel	39867	40712	41557
		Frequency	2517.7	2602.2	2686.7
5 + 20	PCC	Channel	39683	40528	41373
		Frequency	2499.3	2583.8	2668.3
	SCC	Channel	39800	40645	41490
		Frequency	2511.0	2595.5	2680.0
15 + 15	PCC	Channel	39725	40545	41365
		Frequency	2503.5	2585.5	2667.5
	SCC	Channel	39875	40695	41515
		Frequency	2518.5	2600.5	2682.5
10 + 15	PCC	Channel	39703	40549	41395
		Frequency	2501.3	2585.9	2670.5
	SCC	Channel	39823	40669	41515
		Frequency	2513.3	2597.9	2682.5
15 + 10	PCC	Channel	39725	40571	41417
		Frequency	2503.5	2588.1	2672.7
	SCC	Channel	39845	40691	41537
		Frequency	2515.5	2600.1	2684.7

3 Conducted Test Items

3.1 Measuring Instruments

See list of measuring instruments of this test report.

3.2 Test Setup

3.2.1 Conducted Output Power

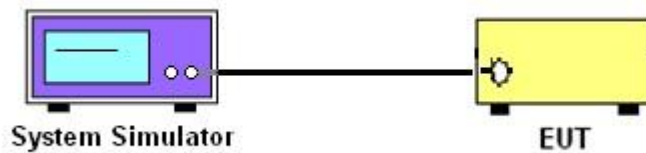

3.2.2 Peak-to-Average Ratio, Occupied Bandwidth ,Conducted Band-Edge and Conducted Spurious Emission



3.2.3 Frequency Stability

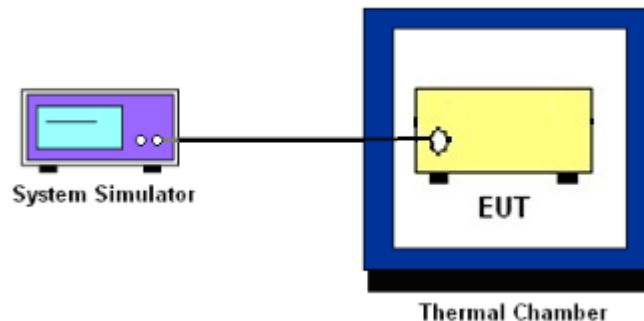

3.3 Test Result of Conducted Test

Please refer to Appendix A.



3.4 Conducted Output Power and ERP/EIRP

3.4.1 Description of the Conducted Output Power Measurement and ERP/EIRP Measurement

A system simulator was used to establish communication with the EUT. Its parameters were set to force the EUT transmitting at maximum output power. The measured power in the radio frequency on the transmitter output terminals shall be reported.

The EIRP of mobile transmitters must not exceed 2 Watts for LTE Band 7 and Band 38 and Band 41.

According to KDB 412172 D01 Power Approach,

$EIRP = P_T + G_T - L_C$, $ERP = EIRP - 2.15$, where

P_T = transmitter output power in dBm

G_T = gain of the transmitting antenna in dBi

L_C = signal attenuation in the connecting cable between the transmitter and antenna in dB

3.4.2 Test Procedures

1. The testing follows ANSI C63.26 Section 5.2
2. The transmitter output port was connected to the system simulator.
3. Set EUT at maximum power through the system simulator.
4. Select different combination of RB offset (1RB, Partial RB, Full RB), each supported bandwidth, and each supported modulation.
5. Select lowest, middle, and highest channels for each band.
6. For LTE ULCA bands, the above step 4 & step 5 are configured at each Cells (PCC & SCC).
7. Measure and record the power level from the system simulator, for LTE ULCA bands, the total power is summed of PCC & SCC.



3.5 Peak-to-Average Ratio

3.5.1 Description of the PAR Measurement

Power Complementary Cumulative Distribution Function (CCDF) curves provide a means for characterizing the power peaks of a digitally modulated signal on a statistical basis. A CCDF curve depicts the probability of the peak signal amplitude exceeding the average power level. Most contemporary measurement instrumentation include the capability to produce CCDF curves for an input signal provided that the instrument's resolution bandwidth can be set wide enough to accommodate the entire input signal bandwidth. In measuring transmissions in this band using an average power technique, the peak-to-average ratio (PAR) of the transmission may not exceed 13 dB.

3.5.2 Test Procedures

1. The testing follows ANSI C63.26 Section 5.2.3.4 (CCDF).
2. The EUT was connected to spectrum and system simulator via a power divider.
3. Set the CCDF (Complementary Cumulative Distribution Function) option in spectrum analyzer.
4. The highest RF powers were measured and recorded the maximum PAPR level associated with a probability of 0.1 %.
5. Record the deviation as Peak to Average Ratio.



3.6 Occupied Bandwidth

3.6.1 Description of Occupied Bandwidth Measurement

The occupied bandwidth is the width of a frequency band such that, below the lower and above the upper frequency limits, the mean powers emitted are each equal to a specified percentage 0.5% of the total mean transmitted power.

The 26 dB emission bandwidth is defined as the frequency range between two points, one above and one below the carrier frequency, at which the spectral density of the emission is attenuated 26 dB below the maximum in-band spectral density of the modulated signal. Spectral density (power per unit bandwidth) is to be measured with a detector of resolution bandwidth equal to approximately 1.0% of the emission bandwidth.

3.6.2 Test Procedures

1. The testing follows ANSI C63.26 Section 5.4
2. The EUT was connected to spectrum analyzer and system simulator via a power divider.
3. The spectrum analyzer center frequency is set to the nominal EUT channel center frequency. The span range for the spectrum analyzer shall be between two and five times the anticipated OBW.
4. The nominal resolution bandwidth (RBW) shall be in the range of 1 to 5 % of the anticipated OBW, and the VBW shall be at least 3 times the RBW.
5. Set the detection mode to peak, and the trace mode to max hold.
6. Determine the reference value: Set the EUT to transmit a modulated signal. Allow the trace to stabilize. Set the spectrum analyzer marker to the highest level of the displayed trace.
(this is the reference value)
7. Determine the “-26 dB down amplitude” as equal to (Reference Value – X).
8. Place two markers, one at the lowest and the other at the highest frequency of the envelope of the spectral display such that each marker is at or slightly below the “-X dB down amplitude” determined in step 6. If a marker is below this “-X dB down amplitude” value it shall be placed as close as possible to this value. The OBW is the positive frequency difference between the two markers.
9. Use the 99 % power bandwidth function of the spectrum analyzer and report the measured bandwidth.



3.7 Conducted Band Edge

3.7.1 Description of Conducted Band Edge Measurement

27.53(m)(4)

For mobile digital stations, the attenuation factor shall be not less than $40 + 10 \log (P)$ dB on all frequencies between the channel edge and 5 megahertz from the channel edge, $43 + 10 \log (P)$ dB on all frequencies between 5 megahertz and X megahertz from the channel edge, and $55 + 10 \log (P)$ dB on all frequencies more than X megahertz from the channel edge, where X is the greater of 6 megahertz or the actual emission bandwidth as defined in paragraph (m)(6) of this section. In addition, the attenuation factor shall not be less that $43 + 10 \log (P)$ dB on all frequencies between 2490.5 MHz and 2496 MHz and $55 + 10 \log (P)$ dB at or below 2490.5 MHz. Mobile Satellite Service licensees operating on frequencies below 2495 MHz may also submit a documented interference complaint against BRS licensees operating on channel BRS Channel 1 on the same terms and conditions as adjacent channel BRS or EBS licensees.

3.7.2 Test Procedures

1. The testing follows ANSI C63.26 section 5.7
2. The EUT was connected to spectrum analyzer and system simulator via a power divider.
3. The band edges of low and high channels for the highest RF powers were measured.
4. Set RBW \geq 1% EBW in the 1MHz band immediately outside and adjacent to the band edge.
5. Beyond the 1 MHz band from the band edge, RBW=1MHz was used or a narrower RBW was used and the measured power was integrated over the full required measurement bandwidth of 1 MHz.
6. Set spectrum analyzer with RMS detector.
7. The RF fundamental frequency should be excluded against the limit line in the operating frequency band.
8. Checked that all the results comply with the emission limit line.

Example:

$$\begin{aligned} &\text{The limit line is derived from } 43 + 10\log(P)\text{dB below the transmitter power P(Watts)} \\ &= P(W) - [43 + 10\log(P)] \text{ (dB)} \\ &= [30 + 10\log(P)] \text{ (dBm)} - [43 + 10\log(P)] \text{ (dB)} = -13\text{dBm}. \end{aligned}$$

9. When using the integration method, the starting frequency of the integration shall be centered at one-half of the RBW away from the band edge.



3.8 Conducted Spurious Emission

3.8.1 Description of Conducted Spurious Emission Measurement

The power of any emission outside of the authorized operating frequency ranges must be lower than the transmitter power (P) by a factor of at least $43 + 10 \log (P)$ dB.

For Band 7,38,41:

The power of any emission outside of the authorized operating frequency ranges must be lower than the transmitter power (P) by a factor of at least $55 + 10 \log (P)$ dB.

It is measured by means of a calibrated spectrum analyzer and scanned from 30 MHz up to a frequency including its 10th harmonic.

3.8.2 Test Procedures

1. The testing follows ANSI C63.26 section 5.7
2. The EUT was connected to spectrum analyzer and system simulator via a power divider.
3. The RF output of EUT was connected to the spectrum analyzer by RF cable and attenuator. The path loss was compensated to the results for each measurement.
4. The middle channel for the highest RF power within the transmitting frequency was measured.
5. The conducted spurious emission for the whole frequency range was taken.
6. Make the measurement with the spectrum analyzer's RBW = 1MHz, VBW = 3MHz.
7. Set spectrum analyzer with RMS detector.
8. Taking the record of maximum spurious emission.
9. The RF fundamental frequency should be excluded against the limit line in the operating frequency band.
10. The limit line is derived from $43 + 10\log(P)$ dB below the transmitter power P(Watts)
 $= P(W) - [43 + 10\log(P)]$ (dB)
 $= [30 + 10\log(P)]$ (dBm) - $[43 + 10\log(P)]$ (dB)
 $= -13$ dBm.
11. For Band 7, 38, 41
The limit line is derived from $55 + 10\log(P)$ dB below the transmitter power P(Watts)
 $= P(W) - [55 + 10\log(P)]$ (dB)
 $= [30 + 10\log(P)]$ (dBm) - $[55 + 10\log(P)]$ (dB)
 $= -25$ dBm.



3.9 Frequency Stability

3.9.1 Description of Frequency Stability Measurement

The frequency stability shall be measured by variation of ambient temperature and variation of primary supply voltage to ensure that the fundamental emission stays within the authorized frequency block. The frequency stability of the transmitter shall be maintained within $\pm 0.00025\%$ ($\pm 2.5\text{ppm}$) of the center frequency.

3.9.2 Test Procedures for Temperature Variation

1. The testing follows ANSI C63.26 section 5.6.4
2. The EUT was set up in the thermal chamber and connected with the system simulator.
3. With power OFF, the temperature was decreased to -30°C and the EUT was stabilized before testing. Power was applied and the maximum change in frequency was recorded within one minute.
4. With power OFF, the temperature was raised in 10°C step up to 50°C . The EUT was stabilized at each step for at least half an hour. Power was applied and the maximum frequency change was recorded within one minute.

3.9.3 Test Procedures for Voltage Variation

1. The testing follows ANSI C63.26 section 5.6.5
2. The EUT was placed in a temperature chamber at $20\pm 5^{\circ}\text{C}$ and connected with the system simulator.
3. The power supply voltage to the EUT was varied from 85% to 115% of the nominal value for other than hand carried battery equipment.
4. For hand carried, battery powered equipment, reduce the primary ac or dc supply voltage to the battery operating end point, which shall be specified by the manufacturer.
5. The variation in frequency was measured for the worst case.

4 Radiated Test Items

4.1 Measuring Instruments

See list of measuring instruments of this test report.

4.2 Test Setup

4.2.1 For radiated test below 30MHz

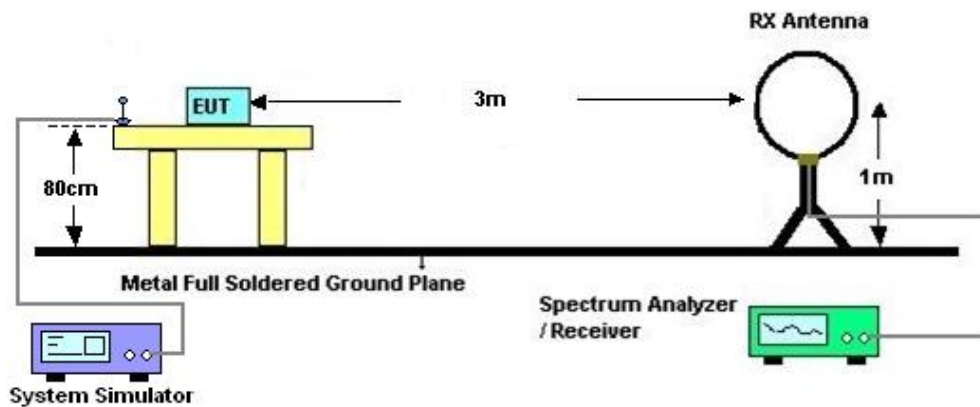

4.2.2 For radiated test from 30MHz to 1GHz

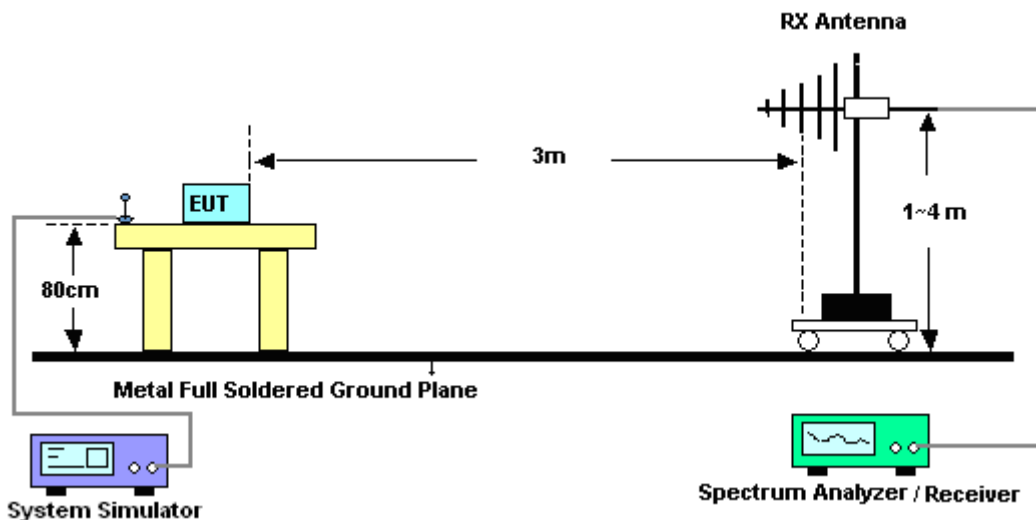

4.2.3 For radiated test above 1GHz

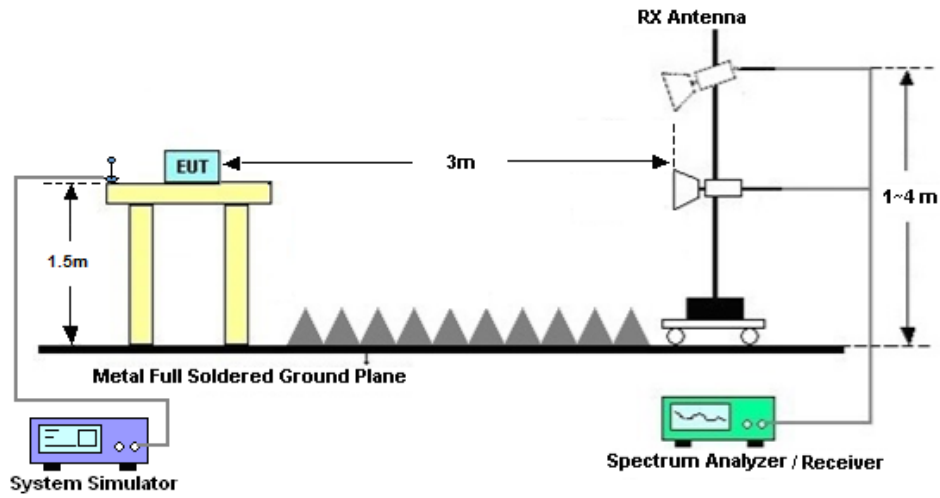

4.3 Test Result of Radiated Test

The low frequency, which started from 9 kHz to 30MHz, was pre-scanned and the result which was 20dB lower than the limit line was not reported.

Please refer to Appendix B.



4.4 Radiated Spurious Emission

4.4.1 Description of Radiated Spurious Emission

The radiated spurious emission was measured by substitution method according to ANSI C63.26.

For Band 7, 38, 41

The power of any emission outside of the authorized operating frequency ranges must be attenuated below the transmitter power (P) by a factor of at least $55 + 10 \log (P)$ dB.

The spectrum is scanned from 30 MHz up to a frequency including its 10th harmonic.

4.4.2 Test Procedures

1. The testing follows ANSI C63.26 Section 5.5
2. The EUT was placed on a turntable with 0.8 meter height for frequency below 1GHz and 1.5 meter height for frequency above 1GHz respectively above ground.
3. The EUT was set 3 meters from the receiving antenna mounted on the antenna tower.
4. The table was rotated 360 degrees to determine the position of the highest spurious emission.
5. The height of the receiving antenna is varied between 1m to 4m to search the maximum spurious emission for both horizontal and vertical polarizations.
6. During the measurement, the system simulator parameters were set to force the EUT transmitting at maximum output power.
7. Make the measurement with the spectrum analyzer's RBW = 1MHz, VBW = 3MHz, taking the record of maximum spurious emission.
8. A horn antenna was substituted in place of the EUT and was driven by a signal generator.
9. Tune the output power of signal generator to the same emission level with EUT maximum spurious emission.
10. $EIRP (dBm) = S.G. Power - Tx Cable Loss + Tx Antenna Gain$
11. $ERP (dBm) = EIRP - 2.15$
12. The RF fundamental frequency should be excluded against the limit line in the operating frequency band.
13. For Band 7, 38, 41:

The limit line is derived from $55 + 10\log(P)$ dB below the transmitter power P(Watts)



5 List of Measuring Equipment

Instrument	Manufacturer	Model No.	Serial No.	Characteristics	Calibration Date	Test Date	Due Date	Remark
Spectrum Analyzer	R&S	FSV40	101078	10Hz~40GHz	Apr. 06, 2023	Dec. 27, 2023~Jan. 04, 2024	Apr. 05, 2024	Conducted (TH01-SZ)
DC Power Supply	TTI	PL330P	290070	Max 32V , 3A	Oct. 16, 2023	Dec. 27, 2023~Jan. 04, 2024	Oct. 15, 2024	Conducted (TH01-SZ)
Power Divider	TOJOIN	PS-2SM-04 265	60.06.020.007 7	0.4GHz~26.5GHz	Dec. 24, 2023	Dec. 27, 2023~Jan. 04, 2024	Dec. 23, 2024	Conducted (TH01-SZ)
Thermal Chamber	Ten Billion Hongzhangroup	LP-150U	H2014081803	-40~+150°C	Jul. 05, 2023	Dec. 27, 2023~Jan. 04, 2024	Jul. 04, 2024	Conducted (TH01-SZ)
EMI Test Receiver&SA	Agilent	N9038A	MY52260185	20Hz~26.5GHz	Dec. 25, 2023	Jan. 08, 2024	Dec. 24, 2024	Radiation (03CH01-SZ)
EXA Spectrum Analyzer	KEYSIGHT	N9010A	MY55150213	10Hz~44GHz	Jul. 07, 2023	Jan. 08, 2024	Jul. 06, 2024	Radiation (03CH01-SZ)
Loop Antenna	R&S	HFH2-Z2	100354	9kHz~30MHz	Jul. 28, 2022	Jan. 08, 2024	Jul. 27, 2024	Radiation (03CH01-SZ)
Bilog Antenna	TeseQ	CBL6112D	35407	30MHz-2GHz	Oct. 24, 2023	Jan. 08, 2024	Oct. 23, 2025	Radiation (03CH01-SZ)
Double Ridge Horn Antenna	ETS-Lindgren	3117	00119436	1GHz~18GHz	Jul. 08, 2023	Jan. 08, 2024	Jul. 07, 2024	Radiation (03CH01-SZ)
SHF-EHF Horn	com-power	AH-840	101071	18GHz-40GHz	Apr. 08, 2023	Jan. 08, 2024	Apr. 07, 2024	Radiation (03CH01-SZ)
LF Amplifier	Burgeon	BPA-530	102209	0.01~3000Mhz	Apr. 04, 2023	Jan. 08, 2024	Apr. 03, 2024	Radiation (03CH01-SZ)
HF Amplifier	MITEQ	AMF-7D-00 101800-30-1 0P-R	1943528	1GHz~18GHz	Oct. 18, 2023	Jan. 08, 2024	Oct. 17, 2024	Radiation (03CH01-SZ)
HF Amplifier	KEYSIGHT	83017A	MY53270105	0.5GHz~26.5Ghz	Oct. 18, 2023	Jan. 08, 2024	Oct. 17, 2024	Radiation (03CH01-SZ)
HF Amplifier	MITEQ	TTA1840-35 -HG	1871923	18GHz~40GHz	Jul. 07, 2023	Jan. 08, 2024	Jul. 06, 2024	Radiation (03CH01-SZ)
AC Power Source	Chroma	61601	616010001985	N/A	Oct. 18, 2023	Jan. 08, 2024	Oct. 17, 2024	Radiation (03CH01-SZ)
Turn Table	EM	EM1000	N/A	0~360 degree	NCR	Jan. 08, 2024	NCR	Radiation (03CH01-SZ)
Antenna Mast	EM	EM1000	N/A	1 m~4 m	NCR	Jan. 08, 2024	NCR	Radiation (03CH01-SZ)

NCR: No Calibration Required.



6 Measurement Uncertainty

The measurement uncertainties shown below were calculated in accordance with the requirements of ANSI 63.26-2015. All the measurement uncertainty value were shown with a coverage K=2 to indicate 95% level of confidence. The measurement data show herein meets or exceeds the CISPR measurement uncertainty values specified in CISPR 16-4-2 and can be compared directly to specified limit to determine compliance.

Uncertainty of Conducted Measurement

Test Item	Uncertainty
Conducted Spurious Emission & Bandedge	±1.34 dB
Occupied Channel Bandwidth	±0.012 MHz
Conducted Power	±1.34 dB
Peak to Average Ratio	±1.34 dB
Frequency Stability	±1.3 Hz

Uncertainty of Radiated Emission Measurement (9 KHz ~ 30 MHz)

Measuring Uncertainty for a Level of Confidence of 95% (U = 2Uc(y))	2.48
---	------

Uncertainty of Radiated Emission Measurement (30 MHz ~ 1000 MHz)

Measuring Uncertainty for a Level of Confidence of 95% (U = 2Uc(y))	3.53
---	------

Uncertainty of Radiated Emission Measurement (1 GHz ~ 40 GHz)

Measuring Uncertainty for a Level of Confidence of 95% (U = 2Uc(y))	4.02
---	------

----- THE END -----



Appendix A. Test Results of Conducted Test

Test Engineer :	Hank Lin	Temperature :	24~26°C
		Relative Humidity :	50~53%

Conducted Output Power(Average power)

LTE Band 7_Ant.0:

BW [MHz]	Modulation	RB Size	RB Offset	Power Low Ch. / Freq.	Power Middle Ch. / Freq.	Power High Ch. / Freq.
Channel				20850	21100	21350
Frequency (MHz)				2510	2535	2560
20	QPSK	1	0	22.65	22.66	22.56
20	QPSK	1	49	22.69	22.78	22.62
20	QPSK	1	99	22.62	22.57	22.58
20	QPSK	50	0	22.23	22.17	22.11
20	QPSK	50	24	22.26	22.27	22.12
20	QPSK	50	50	22.18	22.08	22.07
20	QPSK	100	0	22.19	22.40	22.09
20	16QAM	1	0	22.18	22.22	22.17
20	16QAM	1	49	22.24	22.33	22.31
20	16QAM	1	99	22.19	22.36	22.25
20	16QAM	50	0	20.97	21.01	20.99
20	16QAM	50	24	21.01	21.07	21.04
20	16QAM	50	50	20.98	21.04	21.13
20	16QAM	100	0	20.99	21.04	21.05
20	64QAM	1	0	21.14	21.09	21.07
20	64QAM	1	49	21.15	21.22	21.20
20	64QAM	1	99	21.10	21.20	21.39
20	64QAM	50	0	19.98	20.01	19.98
20	64QAM	50	24	20.02	20.05	20.03
20	64QAM	50	50	19.96	20.06	20.11
20	64QAM	100	0	19.97	20.05	20.05
Channel				20825	21100	21375
Frequency (MHz)				2507.5	2535	2562.5
15	QPSK	1	0	22.50	22.55	22.52
15	QPSK	1	37	22.57	22.58	22.65
15	QPSK	1	74	22.46	22.53	22.68
15	QPSK	36	0	22.02	22.05	22.05
15	QPSK	36	20	22.02	22.07	22.14
15	QPSK	36	39	22.06	22.08	22.18
15	QPSK	75	0	22.03	22.07	22.12
15	16QAM	1	0	22.27	22.29	22.27



15	16QAM	1	37	22.32	22.39	22.40
15	16QAM	1	74	22.25	22.38	22.30
15	16QAM	36	0	21.04	21.04	21.08
15	16QAM	36	20	21.03	21.06	21.12
15	16QAM	36	39	21.04	21.08	21.18
15	16QAM	75	0	21.04	21.10	21.14
15	64QAM	1	0	21.21	21.25	21.15
15	64QAM	1	37	21.24	21.30	21.34
15	64QAM	1	74	21.16	21.27	21.38
15	64QAM	36	0	20.07	20.08	20.09
15	64QAM	36	20	20.05	20.09	20.15
15	64QAM	36	39	20.07	20.07	20.20
15	64QAM	75	0	20.03	20.09	20.15
Channel				20800	21100	21400
Frequency (MHz)				2505	2535	2565
10	QPSK	1	0	22.65	22.54	22.61
10	QPSK	1	25	22.56	22.53	22.65
10	QPSK	1	49	22.60	22.38	22.52
10	QPSK	25	0	22.06	22.07	22.13
10	QPSK	25	12	22.06	22.08	22.15
10	QPSK	25	25	22.08	22.09	22.20
10	QPSK	50	0	22.08	22.07	22.16
10	16QAM	1	0	22.38	22.33	22.35
10	16QAM	1	25	22.28	22.35	22.36
10	16QAM	1	49	22.31	22.22	22.32
10	16QAM	25	0	21.07	21.07	21.14
10	16QAM	25	12	21.03	21.07	21.16
10	16QAM	25	25	21.09	21.09	21.22
10	16QAM	50	0	21.09	21.09	21.16
10	64QAM	1	0	21.26	21.26	21.32
10	64QAM	1	25	21.19	21.27	21.32
10	64QAM	1	49	21.25	21.29	21.24
10	64QAM	25	0	20.08	20.07	20.12
10	64QAM	25	12	20.06	20.06	20.14
10	64QAM	25	25	20.07	20.09	20.22
10	64QAM	50	0	20.07	20.10	20.16
Channel				20775	21100	21425
Frequency (MHz)				2502.5	2535	2567.5
5	QPSK	1	0	22.62	22.62	22.61
5	QPSK	1	12	22.61	22.58	22.55
5	QPSK	1	24	22.64	22.42	22.47
5	QPSK	12	0	22.21	22.15	22.27
5	QPSK	12	7	22.18	22.16	22.30
5	QPSK	12	13	22.18	22.15	22.33
5	QPSK	25	0	22.17	22.16	22.32
5	16QAM	1	0	22.22	22.21	22.24
5	16QAM	1	12	22.23	22.23	22.31



5	16QAM	1	24	22.09	22.24	22.36
5	16QAM	12	0	21.24	21.19	21.28
5	16QAM	12	7	21.19	21.17	21.30
5	16QAM	12	13	21.19	21.15	21.31
5	16QAM	25	0	21.18	21.17	21.30
5	64QAM	1	0	21.40	21.31	21.39
5	64QAM	1	12	21.33	21.37	21.31
5	64QAM	1	24	21.31	21.38	21.31
5	64QAM	12	0	20.23	20.23	20.30
5	64QAM	12	7	20.21	20.24	20.33
5	64QAM	12	13	20.19	20.20	20.33
5	64QAM	25	0	20.18	20.18	20.29

LTE Band 38_Ant.0:

BW [MHz]	Modulation	RB Size	RB Offset	Power Low Ch. / Freq.	Power Middle Ch. / Freq.	Power High Ch. / Freq.
Channel				37850	38000	38150
Frequency (MHz)				2580	2595	2610
20	QPSK	1	0	23.35	23.25	23.25
20	QPSK	1	49	23.38	23.39	23.28
20	QPSK	1	99	23.20	23.18	22.90
20	QPSK	50	0	22.31	22.23	22.27
20	QPSK	50	24	22.33	22.34	22.32
20	QPSK	50	50	22.27	22.22	22.26
20	QPSK	100	0	22.29	22.35	22.28
20	16QAM	1	0	22.26	22.37	22.33
20	16QAM	1	49	22.45	22.51	22.51
20	16QAM	1	99	22.40	22.42	22.38
20	16QAM	50	0	21.29	21.36	21.36
20	16QAM	50	24	21.39	21.36	21.37
20	16QAM	50	50	21.40	21.39	21.35
20	16QAM	100	0	21.33	21.39	21.41
20	64QAM	1	0	20.99	21.11	21.06
20	64QAM	1	49	21.16	21.20	21.19
20	64QAM	1	99	21.13	21.12	21.08
20	64QAM	50	0	20.27	20.31	20.32
20	64QAM	50	24	20.35	20.35	20.38
20	64QAM	50	50	20.35	20.36	20.32
20	64QAM	100	0	20.31	20.37	20.38
Channel				37825	38000	38175
Frequency (MHz)				2577.5	2595	2612.5
15	QPSK	1	0	23.22	23.28	23.14
15	QPSK	1	37	23.37	23.35	23.11
15	QPSK	1	74	23.35	23.22	23.02
15	QPSK	36	0	22.28	22.28	22.23



15	QPSK	36	20	22.32	22.25	22.24
15	QPSK	36	39	22.33	22.30	22.23
15	QPSK	75	0	22.29	22.27	22.26
15	16QAM	1	0	22.26	22.35	22.25
15	16QAM	1	37	22.42	22.43	22.30
15	16QAM	1	74	22.46	22.42	22.29
15	16QAM	36	0	21.31	21.29	21.25
15	16QAM	36	20	21.37	21.32	21.28
15	16QAM	36	39	21.39	21.33	21.29
15	16QAM	75	0	21.41	21.38	21.35
15	64QAM	1	0	21.11	21.16	21.04
15	64QAM	1	37	21.23	21.23	21.07
15	64QAM	1	74	21.28	21.22	21.09
15	64QAM	36	0	20.32	20.31	20.30
15	64QAM	36	20	20.35	20.32	20.30
15	64QAM	36	39	20.40	20.35	20.30
15	64QAM	75	0	20.38	20.36	20.34
Channel				37800	38000	38200
Frequency (MHz)				2575	2595	2615
10	QPSK	1	0	23.28	23.17	22.83
10	QPSK	1	25	23.31	23.29	23.03
10	QPSK	1	49	23.26	23.12	22.90
10	QPSK	25	0	22.38	22.37	22.32
10	QPSK	25	12	22.40	22.39	22.33
10	QPSK	25	25	22.44	22.40	22.33
10	QPSK	50	0	22.39	22.39	22.32
10	16QAM	1	0	22.50	22.39	22.40
10	16QAM	1	25	22.46	22.50	22.36
10	16QAM	1	49	22.55	22.46	22.39
10	16QAM	25	0	21.38	21.38	21.33
10	16QAM	25	12	21.39	21.38	21.35
10	16QAM	25	25	21.44	21.38	21.36
10	16QAM	50	0	21.42	21.38	21.33
10	64QAM	1	0	21.18	21.10	21.12
10	64QAM	1	25	21.15	21.22	21.10
10	64QAM	1	49	21.26	21.18	21.10
10	64QAM	25	0	20.38	20.40	20.35
10	64QAM	25	12	20.41	20.38	20.34
10	64QAM	25	25	20.47	20.41	20.35
10	64QAM	50	0	20.36	20.36	20.30
Channel				37775	38000	38225
Frequency (MHz)				2572.5	2595	2617.5
5	QPSK	1	0	23.32	23.36	23.29
5	QPSK	1	12	23.36	23.36	23.08
5	QPSK	1	24	23.35	23.25	22.98
5	QPSK	12	0	22.40	22.40	22.38
5	QPSK	12	7	22.35	22.42	22.37



5	QPSK	12	13	22.35	22.42	22.36
5	QPSK	25	0	22.40	22.44	22.36
5	16QAM	1	0	22.50	22.45	22.41
5	16QAM	1	12	22.43	22.55	22.44
5	16QAM	1	24	22.48	22.50	22.42
5	16QAM	12	0	21.36	21.37	21.34
5	16QAM	12	7	21.33	21.37	21.32
5	16QAM	12	13	21.33	21.36	21.33
5	16QAM	25	0	21.42	21.44	21.41
5	64QAM	1	0	21.23	21.16	21.12
5	64QAM	1	12	21.18	21.23	21.08
5	64QAM	1	24	21.17	21.18	21.12
5	64QAM	12	0	20.37	20.41	20.35
5	64QAM	12	7	20.34	20.40	20.35
5	64QAM	12	13	20.33	20.40	20.34
5	64QAM	25	0	20.41	20.44	20.38

LTE Band 41_Ant.0:

BW [MHz]	Modulation	RB Size	RB Offset	Power Low Ch. / Freq.	Power Middle Ch. / Freq.	Power High Ch. / Freq.
Channel				39750	40620	41490
Frequency (MHz)				2506	2593	2680
20	QPSK	1	0	23.68	23.80	23.45
20	QPSK	1	49	23.72	23.82	23.55
20	QPSK	1	99	23.70	23.73	22.98
20	QPSK	50	0	22.13	22.28	22.35
20	QPSK	50	24	22.16	22.31	22.38
20	QPSK	50	50	22.10	22.20	22.36
20	QPSK	100	0	22.29	22.23	22.38
20	16QAM	1	0	22.17	22.39	22.08
20	16QAM	1	49	22.23	22.50	22.16
20	16QAM	1	99	22.18	22.42	22.14
20	16QAM	50	0	21.14	21.37	21.11
20	16QAM	50	24	21.15	21.41	21.09
20	16QAM	50	50	21.15	21.38	21.06
20	16QAM	100	0	21.19	21.37	21.09
20	64QAM	1	0	20.88	21.09	20.79
20	64QAM	1	49	20.90	21.20	20.88
20	64QAM	1	99	20.89	21.11	20.82
20	64QAM	50	0	20.12	20.32	20.05
20	64QAM	50	24	20.16	20.40	20.06
20	64QAM	50	50	20.12	20.36	20.01
20	64QAM	100	0	20.17	20.36	20.08
Channel				39725	40620	41515
Frequency (MHz)				2503.5	2593	2682.5



15	QPSK	1	0	23.61	23.84	23.51
15	QPSK	1	37	23.71	23.90	23.34
15	QPSK	1	74	23.70	23.88	23.13
15	QPSK	36	0	22.14	22.33	22.06
15	QPSK	36	20	22.16	22.37	22.07
15	QPSK	36	39	22.14	22.33	22.05
15	QPSK	75	0	22.15	22.32	22.07
15	16QAM	1	0	22.19	22.39	22.12
15	16QAM	1	37	22.24	22.48	22.17
15	16QAM	1	74	22.21	22.45	22.14
15	16QAM	36	0	21.08	21.27	21.00
15	16QAM	36	20	21.08	21.30	20.99
15	16QAM	36	39	21.08	21.28	20.97
15	16QAM	75	0	21.16	21.32	21.08
15	64QAM	1	0	20.88	21.10	20.82
15	64QAM	1	37	20.94	21.19	20.84
15	64QAM	1	74	20.89	21.12	20.85
15	64QAM	36	0	20.11	20.30	20.02
15	64QAM	36	20	20.11	20.31	20.01
15	64QAM	36	39	20.10	20.29	19.99
15	64QAM	75	0	20.14	20.29	20.05
Channel				39700	40620	41540
Frequency (MHz)				2501	2593	2685
10	QPSK	1	0	23.47	23.89	23.29
10	QPSK	1	25	23.64	23.85	23.12
10	QPSK	1	49	23.65	23.82	22.86
10	QPSK	25	0	22.16	22.37	22.11
10	QPSK	25	12	22.13	22.37	22.10
10	QPSK	25	25	22.14	22.36	22.11
10	QPSK	50	0	22.15	22.35	22.13
10	16QAM	1	0	22.23	22.44	22.20
10	16QAM	1	25	22.19	22.47	22.19
10	16QAM	1	49	22.21	22.42	22.22
10	16QAM	25	0	21.16	21.39	21.14
10	16QAM	25	12	21.16	21.38	21.14
10	16QAM	25	25	21.16	21.37	21.14
10	16QAM	50	0	21.16	21.37	21.14
10	64QAM	1	0	20.94	21.16	20.86
10	64QAM	1	25	20.91	21.17	20.88
10	64QAM	1	49	20.91	21.13	20.90
10	64QAM	25	0	20.19	20.39	20.16
10	64QAM	25	12	20.17	20.38	20.14
10	64QAM	25	25	20.19	20.37	20.13
10	64QAM	50	0	20.13	20.32	20.10
Channel				39675	40620	41565
Frequency (MHz)				2498.5	2593	2687.5
5	QPSK	1	0	23.71	23.85	23.46



5	QPSK	1	12	23.70	23.86	23.16
5	QPSK	1	24	23.69	23.83	23.01
5	QPSK	12	0	22.26	22.42	22.14
5	QPSK	12	7	22.25	22.42	22.14
5	QPSK	12	13	22.22	22.42	22.11
5	QPSK	25	0	22.23	22.41	22.17
5	16QAM	1	0	22.27	22.43	22.20
5	16QAM	1	12	22.30	22.48	22.24
5	16QAM	1	24	22.26	22.51	22.23
5	16QAM	12	0	21.22	21.33	21.09
5	16QAM	12	7	21.16	21.36	21.09
5	16QAM	12	13	21.16	21.36	21.07
5	16QAM	25	0	21.25	21.41	21.17
5	64QAM	1	0	20.99	21.17	20.92
5	64QAM	1	12	20.99	21.17	20.92
5	64QAM	1	24	20.97	21.20	20.92
5	64QAM	12	0	20.23	20.37	20.13
5	64QAM	12	7	20.21	20.39	20.14
5	64QAM	12	13	20.19	20.39	20.10
5	64QAM	25	0	20.24	20.40	20.14



CA Power

CA_7C_Ant 0							
Combination 20MHz+20MHz (100RB+100RB)							
PCC Channel	SCC Channel	Modulation	PCC		SCC		Measured Power (dBm)
			RB Size	RB offset	RB Size	RB offset	
20850	21048	QPSK	100	0	100	0	20.57
			1	0	1	99	14.24
			1	99	1	0	22.53
		16QAM	100	0	100	0	19.59
			1	0	1	99	14.74
			1	99	1	0	22.03
		64QAM	100	0	100	0	19.70
			1	0	1	99	14.64
			1	99	1	0	19.91
21001	21199	QPSK	100	0	100	0	20.60
			1	0	1	99	14.22
			1	99	1	0	22.51
		16QAM	100	0	100	0	19.60
			1	0	1	99	14.74
			1	99	1	0	22.04
		64QAM	100	0	100	0	19.72
			1	0	1	99	14.63
			1	99	1	0	19.91
21152	21350	QPSK	100	0	100	0	20.63
			1	0	1	99	14.29
			1	99	1	0	22.56
		16QAM	100	0	100	0	19.66
			1	0	1	99	14.75
			1	99	1	0	22.10
		64QAM	100	0	100	0	19.73
			1	0	1	99	14.66
			1	99	1	0	19.93

CA_7C_Ant 0							
Combination 20MHz+15MHz (100RB+75RB)							
PCC Channel	SCC Channel	Modulation	PCC		SCC		Measured Power (dBm)
			RB Size	RB offset	RB Size	RB offset	
20850	21021	QPSK	100	0	75	0	20.55
			1	0	1	74	14.17
			1	99	1	0	22.53
		16QAM	100	0	75	0	19.57
			1	0	1	74	14.66
			1	99	1	0	22.04
		64QAM	100	0	75	0	19.64
			1	0	1	74	14.54
			1	99	1	0	19.83
21026	21197	QPSK	100	0	75	0	20.57
			1	0	1	74	14.22
			1	99	1	0	22.54



21201	21372	16QAM	100	0	75	0	19.62		
			1	0	1	74	14.71		
			1	99	1	0	22.09		
		64QAM	100	0	75	0	19.70		
			1	0	1	74	14.60		
			1	99	1	0	19.87		
		21201	21372	QPSK	100	0	75	0	20.51
					1	0	1	74	14.18
					1	99	1	0	22.53
16QAM	100			0	75	0	19.57		
	1			0	1	74	14.66		
	1			99	1	0	22.02		
64QAM	100			0	75	0	19.64		
	1			0	1	74	14.58		
	1			99	1	0	19.86		
Combination 15MHz+20MHz (75RB+100RB)									
PCC Channel	SCC Channel	Modulation	PCC		SCC		Measured Power (dBm)		
			RB Size	RB offset	RB Size	RB offset			
20828	20999	QPSK	75	0	100	0	20.56		
			1	0	1	99	14.21		
			1	74	1	0	22.48		
		16QAM	75	0	100	0	19.55		
			1	0	1	99	14.69		
			1	74	1	0	22.05		
		64QAM	75	0	100	0	19.65		
			1	0	1	99	14.53		
			1	74	1	0	19.86		
21003	21174	QPSK	75	0	100	0	20.52		
			1	0	1	99	14.16		
			1	74	1	0	22.49		
		16QAM	75	0	100	0	19.57		
			1	0	1	99	14.64		
			1	74	1	0	22.06		
		64QAM	75	0	100	0	19.63		
			1	0	1	99	14.58		
			1	74	1	0	19.86		
21179	21350	QPSK	75	0	100	0	20.51		
			1	0	1	99	14.18		
			1	74	1	0	22.47		
		16QAM	75	0	100	0	19.55		
			1	0	1	99	14.67		
			1	74	1	0	22.02		
		64QAM	75	0	100	0	19.69		
			1	0	1	99	14.58		
			1	74	1	0	19.84		
Combination 20MHz+10MHz (100RB+50RB)									
PCC Channel	SCC Channel	Modulation	PCC		SCC		Measured Power (dBm)		
			RB Size	RB offset	RB Size	RB offset			
20850	20994	QPSK	100	0	50	0	20.50		
			1	0	1	49	14.19		
			1	99	1	0	22.49		
		16QAM	100	0	50	0	19.57		



			1	0	1	49	14.65
			1	99	1	0	22.03
		64QAM	100	0	50	0	19.64
			1	0	1	49	14.57
			1	99	1	0	19.85
21051	21195	QPSK	100	0	50	0	20.53
			1	0	1	49	14.15
			1	99	1	0	22.50
		16QAM	100	0	50	0	19.61
			1	0	1	49	14.67
			1	99	1	0	22.05
		64QAM	100	0	50	0	19.63
			1	0	1	49	14.53
			1	99	1	0	19.83
21251	21395	QPSK	100	0	50	0	20.55
			1	0	1	49	14.17
			1	99	1	0	22.51
		16QAM	100	0	50	0	19.56
			1	0	1	49	14.64
			1	99	1	0	22.08
		64QAM	100	0	50	0	19.69
			1	0	1	49	14.57
			1	99	1	0	19.84
Combination 10MHz+20MHz (50RB+100RB)							
PCC Channel	SCC Channel	Modulation	PCC		SCC		Measured Power (dBm)
			RB Size	RB offset	RB Size	RB offset	
20805	20949	QPSK	50	0	100	0	20.51
			1	0	1	99	14.15
			1	49	1	0	22.49
		16QAM	50	0	100	0	19.55
			1	0	1	99	14.68
			1	49	1	0	22.03
		64QAM	50	0	100	0	19.63
			1	0	1	99	14.56
			1	49	1	0	19.85
21006	21150	QPSK	50	0	100	0	20.51
			1	0	1	99	14.15
			1	49	1	0	22.53
		16QAM	50	0	100	0	19.58
			1	0	1	99	14.68
			1	49	1	0	22.02
		64QAM	50	0	100	0	19.68
			1	0	1	99	14.58
			1	49	1	0	19.81
21206	21350	QPSK	50	0	100	0	20.54
			1	0	1	99	14.19
			1	49	1	0	22.51
		16QAM	50	0	100	0	19.55
			1	0	1	99	14.64
			1	49	1	0	22.05
		64QAM	50	0	100	0	19.65
			1	0	1	99	14.57



				1	49	1	0	19.81
Combination 15MHz+15MHz (75RB+75RB)								
PCC Channel	SCC Channel	Modulation	PCC		SCC		Measured Power (dBm)	
			RB Size	RB offset	RB Size	RB offset		
20825	20975	QPSK	75	0	75	0	20.56	
			1	0	1	74	14.21	
			1	74	1	0	22.52	
		16QAM	75	0	75	0	19.60	
			1	0	1	74	14.67	
			1	74	1	0	22.08	
		64QAM	75	0	75	0	19.67	
			1	0	1	74	14.59	
			1	74	1	0	19.86	
21025	21175	QPSK	75	0	75	0	20.51	
			1	0	1	74	14.20	
			1	74	1	0	22.49	
		16QAM	75	0	75	0	19.55	
			1	0	1	74	14.70	
			1	74	1	0	22.08	
		64QAM	75	0	75	0	19.69	
			1	0	1	74	14.56	
			1	74	1	0	19.85	
21225	21375	QPSK	75	0	75	0	20.54	
			1	0	1	74	14.21	
			1	74	1	0	22.52	
		16QAM	75	0	75	0	19.60	
			1	0	1	74	14.67	
			1	74	1	0	22.02	
		64QAM	75	0	75	0	19.65	
			1	0	1	74	14.53	
			1	74	1	0	19.80	
Combination 15MHz+10MHz (75RB+50RB)								
PCC Channel	SCC Channel	Modulation	PCC		SCC		Measured Power (dBm)	
			RB Size	RB offset	RB Size	RB offset		
20825	20945	QPSK	75	0	50	0	20.55	
			1	0	1	49	14.19	
			1	74	1	0	22.53	
		16QAM	75	0	50	0	19.57	
			1	0	1	49	14.68	
			1	74	1	0	22.04	
		64QAM	75	0	50	0	19.63	
			1	0	1	49	14.59	
			1	74	1	0	19.85	
21051	21171	QPSK	75	0	50	0	20.51	
			1	0	1	49	14.20	
			1	74	1	0	22.48	
		16QAM	75	0	50	0	19.55	
			1	0	1	49	14.65	
			1	74	1	0	22.02	
		64QAM	75	0	50	0	19.69	
			1	0	1	49	14.59	
			1	74	1	0	19.85	
21277	21397	QPSK	75	0	50	0	20.53	



			1	0	1	49	14.21
			1	74	1	0	22.49
		16QAM	75	0	50	0	19.57
			1	0	1	49	14.67
		64QAM	1	74	1	0	22.07
			75	0	50	0	19.69
			1	0	1	49	14.57
			1	74	1	0	19.86

CA_38C_Ant 0							
Combination 20MHz+20MHz (100RB+100RB)							
PCC Channel	SCC Channel	Modulation	PCC		SCC		Measured Power (dBm)
			RB Size	RB offset	RB Size	RB offset	
37850	38048	QPSK	100	0	100	0	20.62
			1	0	1	99	14.04
			1	99	1	0	22.52
		16QAM	100	0	100	0	19.66
			1	0	1	99	14.02
			1	99	1	0	21.60
		64QAM	100	0	100	0	19.65
			1	0	1	99	13.89
			1	99	1	0	19.43
37901	38099	QPSK	100	0	100	0	20.55
			1	0	1	99	14.00
			1	99	1	0	22.51
		16QAM	100	0	100	0	19.62
			1	0	1	99	13.95
			1	99	1	0	21.59
		64QAM	100	0	100	0	19.59
			1	0	1	99	13.83
			1	99	1	0	19.42
37952	38150	QPSK	100	0	100	0	20.59
			1	0	1	99	14.01
			1	99	1	0	22.49
		16QAM	100	0	100	0	19.59
			1	0	1	99	14.00
			1	99	1	0	21.53
		64QAM	100	0	100	0	19.61
			1	0	1	99	13.83
			1	99	1	0	19.38



CA_41C_Ant 0							
Combination 20MHz+20MHz (100RB+100RB)							
PCC Channel	SCC Channel	Modulation	PCC		SCC		Measured Power (dBm)
			RB Size	RB offset	RB Size	RB offset	
39790	39988	QPSK	100	0	100	0	21.07
			1	0	1	99	14.58
			1	99	1	0	23.07
		16QAM	100	0	100	0	20.10
			1	0	1	99	14.57
			1	99	1	0	22.21
		64QAM	100	0	100	0	20.11
			1	0	1	99	14.46
			1	99	1	0	20.04
39750	39948	QPSK	100	0	100	0	21.16
			1	0	1	99	14.63
			1	99	1	0	23.13
		16QAM	100	0	100	0	20.20
			1	0	1	99	14.62
			1	99	1	0	22.24
		64QAM	100	0	100	0	20.22
			1	0	1	99	14.59
			1	99	1	0	20.04
40521	40719	QPSK	100	0	100	0	21.13
			1	0	1	99	14.56
			1	99	1	0	23.12
		16QAM	100	0	100	0	20.14
			1	0	1	99	14.59
			1	99	1	0	22.20
		64QAM	100	0	100	0	20.20
			1	0	1	99	14.57
			1	99	1	0	20.01
41292	41490	QPSK	100	0	100	0	21.12
			1	0	1	99	14.61
			1	99	1	0	23.08
		16QAM	100	0	100	0	20.16
			1	0	1	99	14.57
			1	99	1	0	22.17
		64QAM	100	0	100	0	20.17
			1	0	1	99	14.53
			1	99	1	0	19.97



CA_41C_Ant 0							
Combination 20MHz+15MHz (100RB+75RB)							
PCC Channel	SCC Channel	Modulation	PCC		SCC		Measured Power (dBm)
			RB Size	RB offset	RB Size	RB offset	
39750	39921	QPSK	100	0	75	0	21.10
			1	0	1	74	14.62
			1	99	1	0	23.11
		16QAM	100	0	75	0	20.13
			1	0	1	74	14.55
			1	99	1	0	22.21
		64QAM	100	0	75	0	20.20
			1	0	1	74	14.53
			1	99	1	0	19.97
40546	40717	QPSK	100	0	75	0	21.04
			1	0	1	74	14.61
			1	99	1	0	23.05
		16QAM	100	0	75	0	20.10
			1	0	1	74	14.52
			1	99	1	0	22.17
		64QAM	100	0	75	0	20.13
			1	0	1	74	14.47
			1	99	1	0	19.93
41341	41512	QPSK	100	0	75	0	21.08
			1	0	1	74	14.55
			1	99	1	0	23.09
		16QAM	100	0	75	0	20.10
			1	0	1	74	14.51
			1	99	1	0	22.14
		64QAM	100	0	75	0	20.13
			1	0	1	74	14.52
			1	99	1	0	19.95
Combination 15MHz+20MHz (75RB+100RB)							
PCC Channel	SCC Channel	Modulation	PCC		SCC		Measured Power (dBm)
			RB Size	RB offset	RB Size	RB offset	
39728	39899	QPSK	75	0	100	0	21.09
			1	0	1	99	14.60
			1	74	1	0	23.08
		16QAM	75	0	100	0	20.08
			1	0	1	99	14.49
			1	74	1	0	22.14
		64QAM	75	0	100	0	20.14
			1	0	1	99	14.48
			1	74	1	0	19.92
40523	40694	QPSK	75	0	100	0	21.00
			1	0	1	99	14.54
			1	74	1	0	22.98
		16QAM	75	0	100	0	20.03
			1	0	1	99	14.48
			1	74	1	0	22.16
		64QAM	75	0	100	0	20.12
			1	0	1	99	14.44



			1	74	1	0	19.89
41319	41490	QPSK	75	0	100	0	21.03
			1	0	1	99	14.51
			1	74	1	0	23.04
		16QAM	75	0	100	0	20.06
			1	0	1	99	14.49
			1	74	1	0	22.08
		64QAM	75	0	100	0	20.08
			1	0	1	99	14.45
			1	74	1	0	19.88
Combination 20MHz+10MHz (100RB+50RB)							
PCC Channel	SCC Channel	Modulation	PCC		SCC		Measured Power (dBm)
			RB Size	RB offset	RB Size	RB offset	
39750	39894	QPSK	100	0	50	0	21.03
			1	0	1	49	14.55
			1	99	1	0	23.09
		16QAM	100	0	50	0	20.08
			1	0	1	49	14.48
			1	99	1	0	22.19
		64QAM	100	0	50	0	20.16
			1	0	1	49	14.52
			1	99	1	0	19.95
40571	40715	QPSK	100	0	50	0	20.99
			1	0	1	49	14.59
			1	99	1	0	23.03
		16QAM	100	0	50	0	20.03
			1	0	1	49	14.51
			1	99	1	0	22.13
		64QAM	100	0	50	0	20.06
			1	0	1	49	14.43
			1	99	1	0	19.92
41391	41535	QPSK	100	0	50	0	21.03
			1	0	1	49	14.52
			1	99	1	0	23.05
		16QAM	100	0	50	0	20.04
			1	0	1	49	14.47
			1	99	1	0	22.12
		64QAM	100	0	50	0	20.06
			1	0	1	49	14.51
			1	99	1	0	19.92
Combination 10MHz+20MHz (50RB+100RB)							
PCC Channel	SCC Channel	Modulation	PCC		SCC		Measured Power (dBm)
			RB Size	RB offset	RB Size	RB offset	
39705	39849	QPSK	50	0	100	0	21.08
			1	0	1	99	14.59
			1	49	1	0	23.10
		16QAM	50	0	100	0	20.11
			1	0	1	99	14.54
			1	49	1	0	22.16
		64QAM	50	0	100	0	20.16
			1	0	1	99	14.50



			1	49	1	0	19.93
40526	40670	QPSK	50	0	100	0	21.00
			1	0	1	99	14.55
			1	49	1	0	22.98
		16QAM	50	0	100	0	20.08
			1	0	1	99	14.49
			1	49	1	0	22.13
		64QAM	50	0	100	0	20.07
			1	0	1	99	14.44
			1	49	1	0	19.88
41346	41490	QPSK	50	0	100	0	21.04
			1	0	1	99	14.53
			1	49	1	0	23.02
		16QAM	50	0	100	0	20.05
			1	0	1	99	14.47
			1	49	1	0	22.11
		64QAM	50	0	100	0	20.09
			1	0	1	99	14.45
			1	49	1	0	19.90
Combination 20MHz+5MHz (100RB+25RB)							
PCC Channel	SCC Channel	Modulation	PCC		SCC		Measured Power (dBm)
39750	39867	QPSK	100	0	25	0	21.08
			1	0	1	24	14.58
			1	99	1	0	23.09
		16QAM	100	0	25	0	20.08
			1	0	1	24	14.53
			1	99	1	0	22.17
		64QAM	100	0	25	0	20.14
			1	0	1	24	14.46
			1	99	1	0	19.94
40595	40712	QPSK	100	0	25	0	21.03
			1	0	1	24	14.59
			1	99	1	0	23.02
		16QAM	100	0	25	0	20.05
			1	0	1	24	14.45
			1	99	1	0	22.13
		64QAM	100	0	25	0	20.11
			1	0	1	24	14.41
			1	99	1	0	19.88
41440	41557	QPSK	100	0	25	0	21.04
			1	0	1	24	14.51
			1	99	1	0	23.08
		16QAM	100	0	25	0	20.04
			1	0	1	24	14.46
			1	99	1	0	22.09
		64QAM	100	0	25	0	20.07
			1	0	1	24	14.48
			1	99	1	0	19.88
Combination 5MHz+20MHz (25RB+100RB)							
PCC Channel	SCC Channel	Modulation	PCC		SCC		Measured Power (dBm)
			RB Size	RB offset	RB Size	RB offset	



39683	39800	QPSK	25	0	100	0	21.08
			1	0	1	99	14.56
			1	24	1	0	23.04
		16QAM	25	0	100	0	20.12
			1	0	1	99	14.48
			1	24	1	0	22.16
		64QAM	25	0	100	0	20.17
			1	0	1	99	14.46
			1	24	1	0	19.91
40528	40645	QPSK	25	0	100	0	20.98
			1	0	1	99	14.60
			1	24	1	0	23.03
		16QAM	25	0	100	0	20.04
			1	0	1	99	14.49
			1	24	1	0	22.10
		64QAM	25	0	100	0	20.07
			1	0	1	99	14.46
			1	24	1	0	19.92
41373	41490	QPSK	25	0	100	0	21.03
			1	0	1	99	14.50
			1	24	1	0	23.07
		16QAM	25	0	100	0	20.07
			1	0	1	99	14.45
			1	24	1	0	22.08
		64QAM	25	0	100	0	20.12
			1	0	1	99	14.47
			1	24	1	0	19.92
Combination 15MHz+10MHz (75RB+50RB)							
PCC Channel	SCC Channel	Modulation	PCC		SCC		Measured Power (dBm)
			RB Size	RB offset	RB Size	RB offset	
39725	39845	QPSK	75	0	50	0	21.09
			1	0	1	49	14.55
			1	74	1	0	23.06
		16QAM	75	0	50	0	20.08
			1	0	1	49	14.52
			1	74	1	0	22.16
		64QAM	75	0	50	0	20.17
			1	0	1	49	14.48
			1	74	1	0	19.94
40571	40691	QPSK	75	0	50	0	21.02
			1	0	1	49	14.59
			1	74	1	0	23.00
		16QAM	75	0	50	0	20.04
			1	0	1	49	14.50
			1	74	1	0	22.14
		64QAM	75	0	50	0	20.07
			1	0	1	49	14.40
			1	74	1	0	19.89
41417	41537	QPSK	75	0	50	0	21.01
			1	0	1	49	14.52
			1	74	1	0	23.07
		16QAM	75	0	50	0	20.03



			1	0	1	49	14.49
			1	74	1	0	22.08
		64QAM	75	0	50	0	20.06
			1	0	1	49	14.48
			1	74	1	0	19.90
Combination 10MHz+15MHz (50RB+75RB)							
PCC Channel	SCC Channel	Modulation	PCC		SCC		Measured Power (dBm)
			RB Size	RB offset	RB Size	RB offset	
39703	39823	QPSK	50	0	75	0	21.08
			1	0	1	74	14.57
			1	49	1	0	23.08
		16QAM	50	0	75	0	20.07
			1	0	1	74	14.54
			1	49	1	0	22.19
		64QAM	50	0	75	0	20.18
			1	0	1	74	14.49
			1	49	1	0	19.90
40549	40669	QPSK	50	0	75	0	20.97
			1	0	1	74	14.57
			1	49	1	0	23.00
		16QAM	50	0	75	0	20.09
			1	0	1	74	14.47
			1	49	1	0	22.15
		64QAM	50	0	75	0	20.07
			1	0	1	74	14.42
			1	49	1	0	19.86
41395	41515	QPSK	50	0	75	0	21.06
			1	0	1	74	14.50
			1	49	1	0	23.08
		16QAM	50	0	75	0	20.03
			1	0	1	74	14.47
			1	49	1	0	22.08
		64QAM	50	0	75	0	20.07
			1	0	1	74	14.51
			1	49	1	0	19.93
Combination 15MHz+15MHz (75RB+75RB)							
PCC Channel	SCC Channel	Modulation	PCC		SCC		Measured Power (dBm)
			RB Size	RB offset	RB Size	RB offset	
39725	39875	QPSK	75	0	75	0	21.04
			1	0	1	74	14.60
			1	74	1	0	23.06
		16QAM	75	0	75	0	20.11
			1	0	1	74	14.54
			1	74	1	0	22.17
		64QAM	75	0	75	0	20.16
			1	0	1	74	14.46
			1	74	1	0	19.96
40545	40695	QPSK	75	0	75	0	20.98
			1	0	1	74	14.54
			1	74	1	0	22.99
		16QAM	75	0	75	0	20.09



			1	0	1	74	14.49
			1	74	1	0	22.12
		64QAM	75	0	75	0	20.11
			1	0	1	74	14.45
			1	74	1	0	19.92
41365	41515	QPSK	75	0	75	0	21.07
			1	0	1	74	14.48
			1	74	1	0	23.02
		16QAM	75	0	75	0	20.04
			1	0	1	74	14.44
			1	74	1	0	22.09
		64QAM	75	0	75	0	20.10
			1	0	1	74	14.50
			1	74	1	0	19.93



ERP/EIRP

LTE Band 7 (GT - LC = 0.32 dB) QPSK			
Bandwidth	5M		
Channel	20775	21100	21425
	(Low)	(Mid)	(High)
Frequency (MHz)	2502.5	2535	2567.5
	Conducted Power (dBm)	22.64	22.42
Conducted Power (Watts)	0.1837	0.1746	0.1766
EIRP(dBm)	22.96	22.74	22.79
EIRP(Watts)	0.1977	0.1879	0.1901

LTE Band 7 (GT - LC = 0.32 dB) QPSK									
Bandwidth	10M			15M			20M		
Channel	20800	21100	21400	20825	21100	21375	20850	21100	21350
	(Low)	(Mid)	(High)	(Low)	(Mid)	(High)	(Low)	(Mid)	(High)
Frequency (MHz)	2505	2535	2565	2507.5	2535	2562.5	2510	2535	2560
	Conducted Power (dBm)	22.65	22.54	22.61	22.46	22.53	22.68	22.69	22.78
Conducted Power (Watts)	0.1841	0.1795	0.1824	0.1762	0.1791	0.1854	0.1858	0.1897	0.1828
EIRP(dBm)	22.97	22.86	22.93	22.78	22.85	23.00	23.01	23.10	22.94
EIRP(Watts)	0.1982	0.1932	0.1963	0.1897	0.1928	0.1995	0.2000	0.2042	0.1968



LTE Band 7 (GT - LC = 0.32 dB) 16QAM			
Bandwidth	5M		
Channel	20775	21100	21425
	(Low)	(Mid)	(High)
Frequency	2502.5	2535	2567.5
(MHz)			
Conducted Power (dBm)	22.09	22.24	22.36
Conducted Power (Watts)	0.1618	0.1675	0.1722
EIRP(dBm)	22.41	22.56	22.68
EIRP(Watts)	0.1742	0.1803	0.1854

LTE Band 7 (GT - LC = 0.32 dB) 16QAM									
Bandwidth	10M			15M			20M		
Channel	20800	21100	21400	20825	21100	21375	20850	21100	21350
	(Low)	(Mid)	(High)	(Low)	(Mid)	(High)	(Low)	(Mid)	(High)
Frequency	2505	2535	2565	2507.5	2535	2562.5	2510	2535	2560
(MHz)									
Conducted Power (dBm)	22.38	22.33	22.35	22.32	22.39	22.40	22.19	22.36	22.25
Conducted Power (Watts)	0.1730	0.1710	0.1718	0.1706	0.1734	0.1738	0.1656	0.1722	0.1679
EIRP(dBm)	22.70	22.65	22.67	22.64	22.71	22.72	22.51	22.68	22.57
EIRP(Watts)	0.1862	0.1841	0.1849	0.1837	0.1866	0.1871	0.1782	0.1854	0.1807



LTE Band 7 (GT - LC = 0.32 dB) 64QAM			
Bandwidth	5M		
Channel	20775	21100	21425
	(Low)	(Mid)	(High)
Frequency (MHz)	2502.5	2535	2567.5
	Conducted Power (dBm)	21.40	21.31
Conducted Power (Watts)	0.1380	0.1352	0.1377
EIRP(dBm)	21.72	21.63	21.71
EIRP(Watts)	0.1486	0.1455	0.1483

LTE Band 7 (GT - LC = 0.32 dB) 64QAM									
Bandwidth	10M			15M			20M		
Channel	20800	21100	21400	20825	21100	21375	20850	21100	21350
	(Low)	(Mid)	(High)	(Low)	(Mid)	(High)	(Low)	(Mid)	(High)
Frequency (MHz)	2505	2535	2565	2507.5	2535	2562.5	2510	2535	2560
	Conducted Power (dBm)	21.19	21.27	21.32	21.16	21.27	21.38	21.10	21.20
Conducted Power (Watts)	0.1315	0.1340	0.1355	0.1306	0.1340	0.1374	0.1288	0.1318	0.1377
EIRP(dBm)	21.51	21.59	21.64	21.48	21.59	21.70	21.42	21.52	21.71
EIRP(Watts)	0.1416	0.1442	0.1459	0.1406	0.1442	0.1479	0.1387	0.1419	0.1483



LTE Band 38 (GT - LC = 0.32 dB) QPSK			
Bandwidth	5M		
Channel	37775	38000	38225
	(Low)	(Mid)	(High)
Frequency (MHz)	2572.5	2595	2617.5
	Conducted Power (dBm)	23.36	23.36
Conducted Power (Watts)	0.2168	0.2168	0.2032
EIRP(dBm)	23.68	23.68	23.40
EIRP(Watts)	0.2333	0.2333	0.2188

LTE Band 38 (GT - LC = 0.32 dB) QPSK									
Bandwidth	10M			15M			20M		
Channel	37800	38000	38200	37825	38000	38175	37850	38000	38150
	(Low)	(Mid)	(High)	(Low)	(Mid)	(High)	(Low)	(Mid)	(Mid)
Frequency (MHz)	2575	2595	2615	2577.5	2595	2612.5	2580	2595	2610
	Conducted Power (dBm)	23.31	23.29	23.03	23.37	23.35	23.11	23.38	23.39
Conducted Power (Watts)	0.2143	0.2133	0.2009	0.2173	0.2163	0.2046	0.2178	0.2183	0.2128
EIRP(dBm)	23.63	23.61	23.35	23.69	23.67	23.43	23.70	23.71	23.60
EIRP(Watts)	0.2307	0.2296	0.2163	0.2339	0.2328	0.2203	0.2344	0.2350	0.2291



LTE Band 38 (GT - LC = 0.32 dB) 16QAM			
Bandwidth	5M		
Channel	37775	38000	38225
	(Low)	(Mid)	(High)
Frequency	2572.5	2595	2617.5
(MHz)			
Conducted Power (dBm)	22.43	22.55	22.44
Conducted Power (Watts)	0.1750	0.1799	0.1754
EIRP(dBm)	22.75	22.87	22.76
EIRP(Watts)	0.1884	0.1936	0.1888

LTE Band 38 (GT - LC = 0.32 dB) 16QAM									
Bandwidth	10M			15M			20M		
Channel	37800	38000	38200	37825	38000	38175	37850	38000	38150
	(Low)	(Mid)	(High)	(Low)	(Mid)	(High)	(Low)	(Mid)	(Mid)
Frequency	2575	2595	2615	2577.5	2595	2612.5	2580	2595	2610
(MHz)									
Conducted Power (dBm)	22.55	22.46	22.39	22.46	22.42	22.29	22.45	22.51	22.51
Conducted Power (Watts)	0.1799	0.1762	0.1734	0.1762	0.1746	0.1694	0.1758	0.1782	0.1782
EIRP(dBm)	22.87	22.78	22.71	22.78	22.74	22.61	22.77	22.83	22.83
EIRP(Watts)	0.1936	0.1897	0.1866	0.1897	0.1879	0.1824	0.1892	0.1919	0.1919



LTE Band 38 (GT - LC = 0.32 dB) 64QAM			
Bandwidth	5M		
Channel	37775	38000	38225
	(Low)	(Mid)	(High)
Frequency (MHz)	2572.5	2595	2617.5
	Conducted Power (dBm)	21.18	21.23
Conducted Power (Watts)	0.1312	0.1327	0.1282
EIRP(dBm)	21.50	21.55	21.40
EIRP(Watts)	0.1413	0.1429	0.1380

LTE Band 38 (GT - LC = 0.32 dB) 64QAM									
Bandwidth	10M			15M			20M		
Channel	37800	38000	38200	37825	38000	38175	37850	38000	38150
	(Low)	(Mid)	(High)	(Low)	(Mid)	(High)	(Low)	(Mid)	(Mid)
Frequency (MHz)	2575	2595	2615	2577.5	2595	2612.5	2580	2595	2610
	Conducted Power (dBm)	21.26	21.18	21.10	21.28	21.22	21.09	21.16	21.20
Conducted Power (Watts)	0.1337	0.1312	0.1288	0.1343	0.1324	0.1285	0.1306	0.1318	0.1315
EIRP(dBm)	21.58	21.50	21.42	21.60	21.54	21.41	21.48	21.52	21.51
EIRP(Watts)	0.1439	0.1413	0.1387	0.1445	0.1426	0.1384	0.1406	0.1419	0.1416



LTE Band 41 (G _T - L _C = 0.35 dB) QPSK									
Bandwidth	5M			10M			15M		
Channel	39675	40620	41565	39700	40620	41540	39725	40620	41515
	(Low)	(Mid)	(High)	(Low)	(Mid)	(High)	(Low)	(Mid)	(High)
Frequency	2498.5	2593	2687.5	2501	2593	2685	2503.5	2593	2682.5
(MHz)									
Conducted Power (dBm)	23.70	23.86	23.16	23.47	23.89	23.29	23.71	23.90	23.34
Conducted Power (Watts)	0.2344	0.2432	0.2070	0.2223	0.2449	0.2133	0.2350	0.2455	0.2158
EIRP(dBm)	24.05	24.21	23.51	23.82	24.24	23.64	24.06	24.25	23.69
EIRP(Watts)	0.2541	0.2636	0.2244	0.2410	0.2655	0.2312	0.2547	0.2661	0.2339

LTE Band 41 (G _T - L _C = 0.35 dB) QPSK			
Bandwidth	20M		
Channel	39750	40620	41490
	(Low)	(Mid)	(High)
Frequency	2506	2593	2680
(MHz)			
Conducted Power (dBm)	23.72	23.82	23.55
Conducted Power (Watts)	0.2355	0.2410	0.2265
EIRP(dBm)	24.07	24.17	23.90
EIRP(Watts)	0.2553	0.2612	0.2455



LTE Band 41 (G _T - L _C = 0.35 dB) 16QAM									
Bandwidth	5M			10M			15M		
Channel	39675	40620	41565	39700	40620	41540	39725	40620	41515
	(Low)	(Mid)	(High)	(Low)	(Mid)	(High)	(Low)	(Mid)	(High)
Frequency	2498.5	2593	2687.5	2501	2593	2685	2503.5	2593	2682.5
(MHz)									
Conducted Power (dBm)	22.26	22.51	22.23	22.19	22.47	22.19	22.24	22.48	22.17
Conducted Power (Watts)	0.1683	0.1782	0.1671	0.1656	0.1766	0.1656	0.1675	0.1770	0.1648
EIRP(dBm)	22.61	22.86	22.58	22.54	22.82	22.54	22.59	22.83	22.52
EIRP(Watts)	0.1824	0.1932	0.1811	0.1795	0.1914	0.1795	0.1816	0.1919	0.1786

LTE Band 41 (G _T - L _C = 0.35 dB) 16QAM			
Bandwidth	20M		
Channel	39750	40620	41490
	(Low)	(Mid)	(High)
Frequency	2506	2593	2680
(MHz)			
Conducted Power (dBm)	22.23	22.50	22.16
Conducted Power (Watts)	0.1671	0.1778	0.1644
EIRP(dBm)	22.58	22.85	22.51
EIRP(Watts)	0.1811	0.1928	0.1782



LTE Band 41 (G _T - L _C = 0.35 dB) 64QAM									
Bandwidth	5M			10M			15M		
Channel	39675	40620	41565	39700	40620	41540	39725	40620	41515
	(Low)	(Mid)	(High)	(Low)	(Mid)	(High)	(Low)	(Mid)	(High)
Frequency	2498.5	2593	2687.5	2501	2593	2685	2503.5	2593	2682.5
(MHz)									
Conducted Power (dBm)	20.97	21.20	20.92	20.91	21.17	20.88	20.94	21.19	20.84
Conducted Power (Watts)	0.1250	0.1318	0.1236	0.1233	0.1309	0.1225	0.1242	0.1315	0.1213
EIRP(dBm)	21.32	21.55	21.27	21.26	21.52	21.23	21.29	21.54	21.19
EIRP(Watts)	0.1355	0.1429	0.1340	0.1337	0.1419	0.1327	0.1346	0.1426	0.1315

LTE Band 41 (G _T - L _C = 0.35 dB) 64QAM			
Bandwidth	20M		
Channel	39750	40620	41490
	(Low)	(Mid)	(High)
Frequency	2506	2593	2680
(MHz)			
Conducted Power (dBm)	20.90	21.20	20.88
Conducted Power (Watts)	0.1230	0.1318	0.1225
EIRP(dBm)	21.25	21.55	21.23
EIRP(Watts)	0.1334	0.1429	0.1327



CA EIRP

LTE Band CA_7C (GT - LC = 0.32 dB) QPSK									
Bandwidth	15M + 15M			10M + 20M			20M+10M		
Channel PCC	20825	21025	21225	20805	21006	21206	20850	21051	21251
	(Low)	(Mid)	(High)	(Low)	(Mid)	(High)	(Low)	(Mid)	(High)
Channel SCC	20975	21175	21375	20949	21150	21350	20994	21195	21395
	(Low)	(Mid)	(High)	(Low)	(Mid)	(High)	(Low)	(Mid)	(High)
Conducted Power (dBm)	22.52	22.49	22.52	22.49	22.53	22.51	22.49	22.50	22.51
Conducted Power (Watts)	0.1786	0.1774	0.1786	0.1774	0.1791	0.1782	0.1774	0.1778	0.1782
EIRP(dBm)	22.84	22.81	22.84	22.81	22.85	22.83	22.81	22.82	22.83
EIRP(Watts)	0.1923	0.1910	0.1923	0.1910	0.1928	0.1919	0.1910	0.1914	0.1919

LTE Band CA_7C (GT - LC = 0.32 dB) QPSK									
Bandwidth	15M+20M			20M+15M			20M + 20M		
Channel PCC	20828	21003	21179	20850	21026	21201	20850	21001	21152
	(Low)	(Mid)	(High)	(Low)	(Mid)	(High)	(Low)	(Mid)	(High)
Channel SCC	20999	21174	21350	21021	21197	21372	21048	21199	21350
	(Low)	(Mid)	(High)	(Low)	(Mid)	(High)	(Low)	(Mid)	(High)
Conducted Power (dBm)	22.48	22.49	22.47	22.53	22.54	22.53	22.53	22.51	22.56
Conducted Power (Watts)	0.1770	0.1774	0.1766	0.1791	0.1795	0.1791	0.1791	0.1782	0.1803
EIRP(dBm)	22.80	22.81	22.79	22.85	22.86	22.85	22.85	22.83	22.88
EIRP(Watts)	0.1905	0.1910	0.1901	0.1928	0.1932	0.1928	0.1928	0.1919	0.1941



LTE Band CA_7C (GT - LC = 0.32 dB) 16QAM									
Bandwidth	15M + 15M			10M + 20M			20M+10M		
Channel PCC	20825	21025	21225	20805	21006	21206	20850	21051	21251
	(Low)	(Mid)	(High)	(Low)	(Mid)	(High)	(Low)	(Mid)	(High)
Channel SCC	20975	21175	21375	20949	21150	21350	20994	21195	21395
	(Low)	(Mid)	(High)	(Low)	(Mid)	(High)	(Low)	(Mid)	(High)
Conducted Power (dBm)	22.08	22.08	22.02	22.03	22.02	22.05	22.03	22.05	22.08
Conducted Power (Watts)	0.1614	0.1614	0.1592	0.1596	0.1592	0.1603	0.1596	0.1603	0.1614
EIRP(dBm)	22.40	22.40	22.34	22.35	22.34	22.37	22.35	22.37	22.40
EIRP(Watts)	0.1738	0.1738	0.1714	0.1718	0.1714	0.1726	0.1718	0.1726	0.1738

LTE Band CA_7C (GT - LC = 0.32 dB) 16QAM									
Bandwidth	15M+20M			20M+15M			20M + 20M		
Channel PCC	20828	21003	21179	20850	21026	21201	20850	21001	21152
	(Low)	(Mid)	(High)	(Low)	(Mid)	(High)	(Low)	(Mid)	(High)
Channel SCC	20999	21174	21350	21021	21197	21372	21048	21199	21350
	(Low)	(Mid)	(High)	(Low)	(Mid)	(High)	(Low)	(Mid)	(High)
Conducted Power (dBm)	22.05	22.06	22.02	22.04	22.09	22.02	22.03	22.04	22.10
Conducted Power (Watts)	0.1603	0.1607	0.1592	0.1600	0.1618	0.1592	0.1596	0.1600	0.1622
EIRP(dBm)	22.37	22.38	22.34	22.36	22.41	22.34	22.35	22.36	22.42
EIRP(Watts)	0.1726	0.1730	0.1714	0.1722	0.1742	0.1714	0.1718	0.1722	0.1746



LTE Band CA_7C (GT - LC = 0.32 dB) 64QAM									
Bandwidth	15M + 15M			10M + 20M			20M+10M		
Channel PCC	20825	21025	21225	20805	21006	21206	20850	21051	21251
	(Low)	(Mid)	(High)	(Low)	(Mid)	(High)	(Low)	(Mid)	(High)
Channel SCC	20975	21175	21375	20949	21150	21350	20994	21195	21395
	(Low)	(Mid)	(High)	(Low)	(Mid)	(High)	(Low)	(Mid)	(High)
Conducted Power (dBm)	19.86	19.85	19.80	19.85	19.81	19.81	19.85	19.83	19.84
Conducted Power (Watts)	0.0968	0.0966	0.0955	0.0966	0.0957	0.0957	0.0966	0.0962	0.0964
EIRP(dBm)	20.18	20.17	20.12	20.17	20.13	20.13	20.17	20.15	20.16
EIRP(Watts)	0.1042	0.1040	0.1028	0.1040	0.1030	0.1030	0.1040	0.1035	0.1038

LTE Band CA_7C (GT - LC = 0.32 dB) 64QAM									
Bandwidth	15M+20M			20M+15M			20M + 20M		
Channel PCC	20828	21003	21179	20850	21026	21201	20850	21001	21152
	(Low)	(Mid)	(High)	(Low)	(Mid)	(High)	(Low)	(Mid)	(High)
Channel SCC	20999	21174	21350	21021	21197	21372	21048	21199	21350
	(Low)	(Mid)	(High)	(Low)	(Mid)	(High)	(Low)	(Mid)	(High)
Conducted Power (dBm)	19.86	19.86	19.84	19.83	19.87	19.86	19.91	19.91	19.93
Conducted Power (Watts)	0.0968	0.0968	0.0964	0.0962	0.0971	0.0968	0.0979	0.0979	0.0984
EIRP(dBm)	20.18	20.18	20.16	20.15	20.19	20.18	20.23	20.23	20.25
EIRP(Watts)	0.1042	0.1042	0.1038	0.1035	0.1045	0.1042	0.1054	0.1054	0.1059



LTE Band CA_7C (GT - LC = 0.32 dB) QPSK			
Bandwidth	15M + 10M		
Channel PCC	20825	21025	21225
	(Low)	(Mid)	(High)
Channel SCC	20975	21175	21375
	(Low)	(Mid)	(High)
Conducted Power (dBm)	22.53	22.48	22.49
Conducted Power (Watts)	0.1791	0.1770	0.1774
EIRP(dBm)	22.85	22.80	22.81
EIRP(Watts)	0.1928	0.1905	0.1910

LTE Band CA_7C (GT - LC = 0.32 dB) 16QAM			
Bandwidth	15M + 10M		
Channel PCC	20825	21025	21225
	(Low)	(Mid)	(High)
Channel SCC	20975	21175	21375
	(Low)	(Mid)	(High)
Conducted Power (dBm)	22.04	22.02	22.07
Conducted Power (Watts)	0.1600	0.1592	0.1611
EIRP(dBm)	22.36	22.34	22.39
EIRP(Watts)	0.1722	0.1714	0.1734

LTE Band CA_7C (GT - LC = 0.32 dB) 64QAM			
Bandwidth	15M + 10M		
Channel PCC	20825	21025	21225
	(Low)	(Mid)	(High)
Channel SCC	20975	21175	21375
	(Low)	(Mid)	(High)
Conducted Power (dBm)	19.85	19.85	19.86
Conducted Power (Watts)	0.0966	0.0966	0.0968
EIRP(dBm)	20.17	20.17	20.18
EIRP(Watts)	0.1040	0.1040	0.1042



LTE Band CA_38C (GT - LC = 0.32 dB) QPSK						
Bandwidth	15M + 15M			20M+20M		
Channel PCC	37825	37925	38025	37850	37901	37952
	(Low)	(Mid)	(High)	(Low)	(Mid)	(High)
Channel SCC	37975	38075	38175	38048	38099	38150
	(Low)	(Mid)	(High)	(Low)	(Mid)	(High)
Conducted Power (dBm)	22.45	22.44	22.41	22.52	22.51	22.49
Conducted Power (Watts)	0.1758	0.1754	0.1742	0.1786	0.1782	0.1774
EIRP(dBm)	22.77	22.76	22.73	22.84	22.83	22.81
EIRP(Watts)	0.1892	0.1888	0.1875	0.1923	0.1919	0.1910

LTE Band CA_38C (GT - LC = 0.32 dB) 16QAM						
Bandwidth	15M + 15M			20M+20M		
Channel PCC	37825	37925	38025	37850	37901	37952
	(Low)	(Mid)	(High)	(Low)	(Mid)	(High)
Channel SCC	37975	38075	38175	38048	38099	38150
	(Low)	(Mid)	(High)	(Low)	(Mid)	(High)
Conducted Power (dBm)	21.56	21.49	21.52	21.60	21.59	21.53
Conducted Power (Watts)	0.1432	0.1409	0.1419	0.1445	0.1442	0.1422
EIRP(dBm)	21.88	21.81	21.84	21.92	21.91	21.85
EIRP(Watts)	0.1542	0.1517	0.1528	0.1556	0.1552	0.1531

LTE Band CA_38C (GT - LC = 0.32 dB) 64QAM						
Bandwidth	15M + 15M			20M+20M		
Channel PCC	37825	37925	38025	37850	37901	37952
	(Low)	(Mid)	(High)	(Low)	(Mid)	(High)
Channel SCC	37975	38075	38175	38048	38099	38150
	(Low)	(Mid)	(High)	(Low)	(Mid)	(High)
Conducted Power (dBm)	19.60	19.59	19.55	19.65	19.59	19.61
Conducted Power (Watts)	0.0912	0.0910	0.0902	0.0923	0.0910	0.0914
EIRP(dBm)	19.92	19.91	19.87	19.97	19.91	19.93
EIRP(Watts)	0.0982	0.0979	0.0971	0.0993	0.0979	0.0984



LTE Band 41 CA (GT - LC = 0.35 dB) QPSK									
Bandwidth	15M + 15M			5M + 20M			20M + 5M		
Channel PCC	39725	40545	41365	39683	40528	41373	39750	40595	41440
	(Low)	(Mid)	(High)	(Low)	(Mid)	(High)	(Low)	(Mid)	(High)
Channel SCC	39875	40695	41515	39800	40645	41490	39867	40712	41557
	(Low)	(Mid)	(High)	(Low)	(Mid)	(High)	(Low)	(Mid)	(High)
Conducted Power (dBm)	23.06	22.99	23.02	23.04	23.03	23.07	23.09	23.02	23.08
Conducted Power (Watts)	0.2023	0.1991	0.2004	0.2014	0.2009	0.2028	0.2037	0.2004	0.2032
EIRP(dBm)	23.41	23.34	23.37	23.39	23.38	23.42	23.44	23.37	23.43
EIRP(Watts)	0.2193	0.2158	0.2173	0.2183	0.2178	0.2198	0.2208	0.2173	0.2203

LTE Band 41 CA (GT - LC = 0.35 dB) QPSK									
Bandwidth	10M + 20M			20M + 10M			15M + 20M		
Channel PCC	39705	40526	41346	39750	40571	41391	39728	40523	41319
	(Low)	(Mid)	(High)	(Low)	(Mid)	(High)	(Low)	(Mid)	(High)
Channel SCC	39849	40670	41490	39894	40715	41535	39899	40694	41490
	(Low)	(Mid)	(High)	(Low)	(Mid)	(High)	(Low)	(Mid)	(High)
Conducted Power (dBm)	23.10	22.98	23.02	23.09	23.03	23.05	23.08	22.98	23.04
Conducted Power (Watts)	0.2042	0.1986	0.2004	0.2037	0.2009	0.2018	0.2032	0.1986	0.2014
EIRP(dBm)	23.45	23.33	23.37	23.44	23.38	23.40	23.43	23.33	23.39
EIRP(Watts)	0.2213	0.2153	0.2173	0.2208	0.2178	0.2188	0.2203	0.2153	0.2183



LTE Band 41 CA (GT - LC = 0.35 dB) QPSK						
Bandwidth	20M+15M			20M+20M		
Channel PCC	39750	40546	41341	39750	40521	41292
	(Low)	(Mid)	(High)	(Low)	(Mid)	(High)
Channel SCC	39921	40717	41512	39948	40719	41490
	(Low)	(Mid)	(High)	(Low)	(Mid)	(High)
Conducted Power (dBm)	23.11	23.05	23.09	23.13	23.12	23.08
Conducted Power (Watts)	0.2046	0.2018	0.2037	0.2056	0.2051	0.2032
EIRP(dBm)	23.46	23.40	23.44	23.48	23.47	23.43
EIRP(Watts)	0.2218	0.2188	0.2208	0.2228	0.2223	0.2203

LTE Band 41 CA (GT - LC = 0.35 dB) QPSK						
Bandwidth	15M+10M			10M+15M		
Channel PCC	39725	40571	41417	39703	40549	41395
	(Low)	(Mid)	(High)	(Low)	(Mid)	(High)
Channel SCC	39845	40691	41537	39823	40669	41490
	(Low)	(Mid)	(High)	(Low)	(Mid)	(High)
Conducted Power (dBm)	23.06	23.00	23.07	23.08	23.00	23.08
Conducted Power (Watts)	0.2023	0.1995	0.2028	0.2032	0.1995	0.2032
EIRP(dBm)	23.41	23.35	23.42	23.43	23.35	23.43
EIRP(Watts)	0.2193	0.2163	0.2198	0.2203	0.2163	0.2203



LTE Band 41 CA (GT - LC = 0.35 dB) 16QAM									
Bandwidth	15M + 15M			5M + 20M			20M + 5M		
Channel PCC	39725	40545	41365	39683	40528	41373	39750	40595	41440
	(Low)	(Mid)	(High)	(Low)	(Mid)	(High)	(Low)	(Mid)	(High)
Channel SCC	39875	40695	41515	39800	40645	41490	39867	40712	41557
	(Low)	(Mid)	(High)	(Low)	(Mid)	(High)	(Low)	(Mid)	(High)
Conducted Power (dBm)	22.17	22.12	22.09	22.16	22.10	22.08	22.17	22.13	22.09
Conducted Power (Watts)	0.1648	0.1629	0.1618	0.1644	0.1622	0.1614	0.1648	0.1633	0.1618
EIRP(dBm)	22.52	22.47	22.44	22.51	22.45	22.43	22.52	22.48	22.44
EIRP(Watts)	0.1786	0.1766	0.1754	0.1782	0.1758	0.1750	0.1786	0.1770	0.1754

LTE Band 41 CA (GT - LC = 0.35 dB) 16QAM									
Bandwidth	10M + 20M			20M + 10M			15M + 20M		
Channel PCC	39705	40526	41346	39750	40571	41391	39728	40523	41319
	(Low)	(Mid)	(High)	(Low)	(Mid)	(High)	(Low)	(Mid)	(High)
Channel SCC	39849	40670	41490	39894	40715	41535	39899	40694	41490
	(Low)	(Mid)	(High)	(Low)	(Mid)	(High)	(Low)	(Mid)	(High)
Conducted Power (dBm)	22.16	22.13	22.11	22.19	22.13	22.12	22.14	22.16	22.08
Conducted Power (Watts)	0.1644	0.1633	0.1626	0.1656	0.1633	0.1629	0.1637	0.1644	0.1614
EIRP(dBm)	22.51	22.48	22.46	22.54	22.48	22.47	22.49	22.51	22.43
EIRP(Watts)	0.1782	0.1770	0.1762	0.1795	0.1770	0.1766	0.1774	0.1782	0.1750



LTE Band 41 CA (GT - LC = 0.35 dB) 16QAM						
Bandwidth	20M+15M			20M+20M		
Channel PCC	39750	40546	41341	39750	40521	41292
	(Low)	(Mid)	(High)	(Low)	(Mid)	(High)
Channel SCC	39921	40717	41512	39948	40719	41490
	(Low)	(Mid)	(High)	(Low)	(Mid)	(High)
Conducted Power (dBm)	22.21	22.17	22.14	22.24	22.20	22.17
Conducted Power (Watts)	0.1663	0.1648	0.1637	0.1675	0.1660	0.1648
EIRP(dBm)	22.56	22.52	22.49	22.59	22.55	22.52
EIRP(Watts)	0.1803	0.1786	0.1774	0.1816	0.1799	0.1786

LTE Band 41 CA (GT - LC = 0.35 dB) 16QAM						
Bandwidth	15M+10M			10M+15M		
Channel PCC	39725	40571	41417	39703	40549	41395
	(Low)	(Mid)	(High)	(Low)	(Mid)	(High)
Channel SCC	39845	40691	41537	39823	40669	41490
	(Low)	(Mid)	(High)	(Low)	(Mid)	(High)
Conducted Power (dBm)	22.16	22.14	22.08	22.19	22.15	22.08
Conducted Power (Watts)	0.1644	0.1637	0.1614	0.1656	0.1641	0.1614
EIRP(dBm)	22.51	22.49	22.43	22.54	22.50	22.43
EIRP(Watts)	0.1782	0.1774	0.1750	0.1795	0.1778	0.1750



LTE Band 41 CA (GT - LC = 0.35 dB) 64QAM									
Bandwidth	15M + 15M			5M + 20M			20M + 5M		
Channel PCC	39725	40545	41365	39683	40528	41373	39750	40595	41440
	(Low)	(Mid)	(High)	(Low)	(Mid)	(High)	(Low)	(Mid)	(High)
Channel SCC	39875	40695	41515	39800	40645	41490	39867	40712	41557
	(Low)	(Mid)	(High)	(Low)	(Mid)	(High)	(Low)	(Mid)	(High)
Conducted Power (dBm)	20.16	20.11	20.10	20.17	20.07	20.12	20.14	20.11	20.07
Conducted Power (Watts)	0.1038	0.1026	0.1023	0.1040	0.1016	0.1028	0.1033	0.1026	0.1016
EIRP(dBm)	20.51	20.46	20.45	20.52	20.42	20.47	20.49	20.46	20.42
EIRP(Watts)	0.1125	0.1112	0.1109	0.1127	0.1102	0.1114	0.1119	0.1112	0.1102

LTE Band 41 CA (GT - LC = 0.35 dB) 64QAM									
Bandwidth	10M + 20M			20M + 10M			15M + 20M		
Channel PCC	39705	40526	41346	39750	40571	41391	39728	40523	41319
	(Low)	(Mid)	(High)	(Low)	(Mid)	(High)	(Low)	(Mid)	(High)
Channel SCC	39849	40670	41490	39894	40715	41535	39899	40694	41490
	(Low)	(Mid)	(High)	(Low)	(Mid)	(High)	(Low)	(Mid)	(High)
Conducted Power (dBm)	20.16	20.07	20.09	20.16	20.06	20.06	20.14	20.12	20.08
Conducted Power (Watts)	0.1038	0.1016	0.1021	0.1038	0.1014	0.1014	0.1033	0.1028	0.1019
EIRP(dBm)	20.51	20.42	20.44	20.51	20.41	20.41	20.49	20.47	20.43
EIRP(Watts)	0.1125	0.1102	0.1107	0.1125	0.1099	0.1099	0.1119	0.1114	0.1104

LTE Band 41 CA (GT - LC = 0.35 dB) 64QAM						
Bandwidth	20M+15M			20M+20M		
Channel PCC	39750	40546	41341	39750	40521	41292
	(Low)	(Mid)	(High)	(Low)	(Mid)	(High)
Channel SCC	39921	40717	41512	39948	40719	41490
	(Low)	(Mid)	(High)	(Low)	(Mid)	(High)
Conducted Power (dBm)	20.20	20.13	20.13	20.22	22.20	22.17
Conducted Power (Watts)	0.1047	0.1030	0.1030	0.1052	0.1660	0.1648
EIRP(dBm)	20.55	20.48	20.48	20.57	22.55	22.52
EIRP(Watts)	0.1135	0.1117	0.1117	0.1140	0.1799	0.1786



LTE Band 41 CA (GT - LC = 0.35 dB) 64QAM						
Bandwidth	15M+10M			10M+15M		
Channel PCC	39725	40571	41417	39703	40549	41395
	(Low)	(Mid)	(High)	(Low)	(Mid)	(High)
Channel SCC	39845	40691	41537	39823	40669	41490
	(Low)	(Mid)	(High)	(Low)	(Mid)	(High)
Conducted Power (dBm)	20.17	20.07	20.06	20.18	20.07	20.07
Conducted Power (Watts)	0.1040	0.1016	0.1014	0.1042	0.1016	0.1016
EIRP(dBm)	20.52	20.42	20.41	20.53	20.42	20.42
EIRP(Watts)	0.1127	0.1102	0.1099	0.1130	0.1102	0.1102



LTE Band 7(Main PA)

Peak-to-Average Ratio

Mode	LTE Band 7 / 20MHz			
Mod.	QPSK	16QAM	64QAM	Limit: 13dB
RB Size	Full RB	Full RB	Full RB	Result
Middle CH	4.96	5.97	6.35	PASS

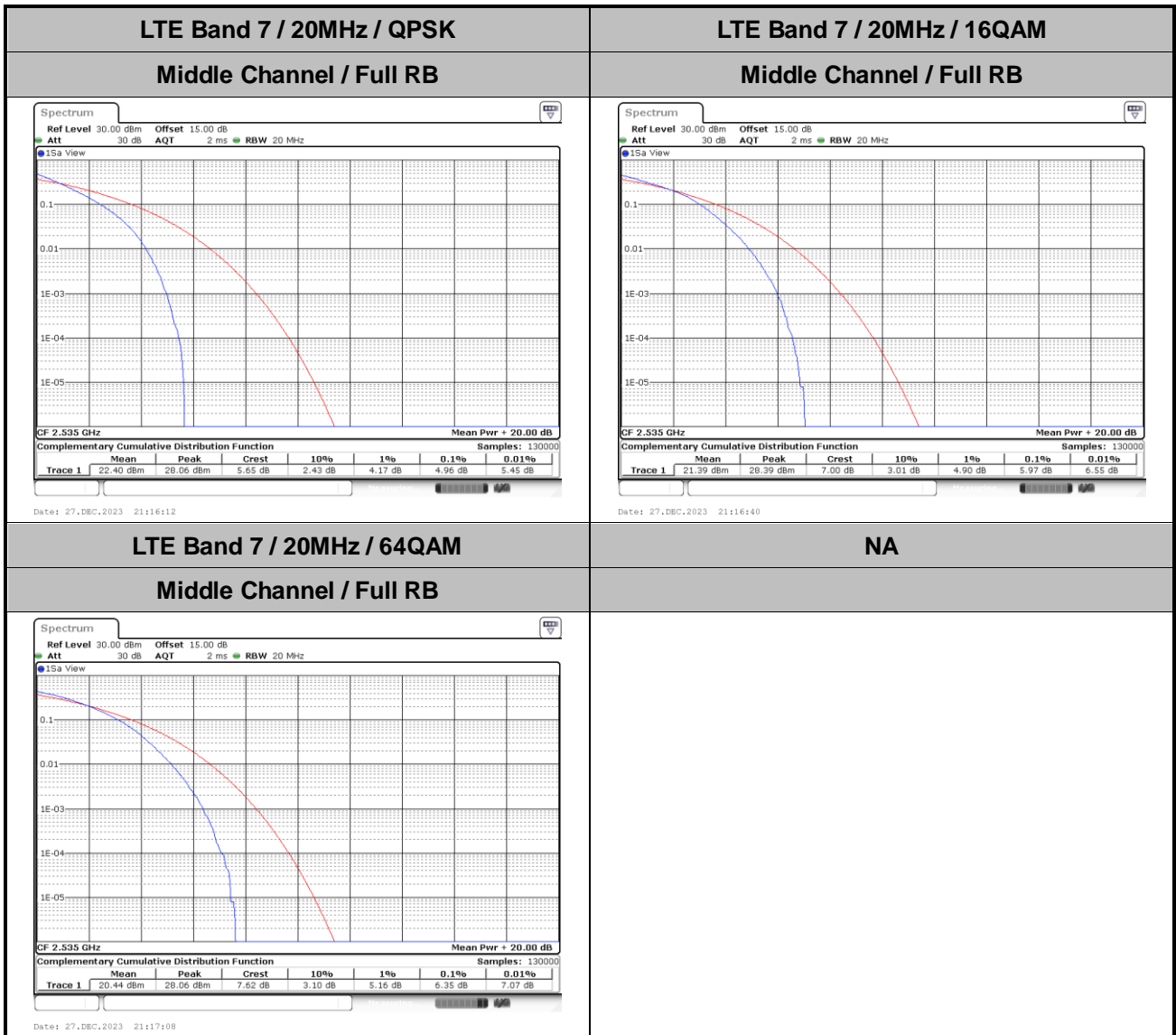



26dB Bandwidth

Mode	LTE Band 7 : 26dB BW(MHz)											
	-				5MHz		10MHz		15MHz		20MHz	
BW	-	-	-	-	5MHz	10MHz	10MHz	10MHz	15MHz	15MHz	20MHz	20MHz
Mod.	-	-	-	-	QPSK	16QAM	QPSK	16QAM	QPSK	16QAM	QPSK	16QAM
Middle CH	-	-	-	-	4.97	4.84	9.67	9.69	14.27	14.45	19.10	18.70

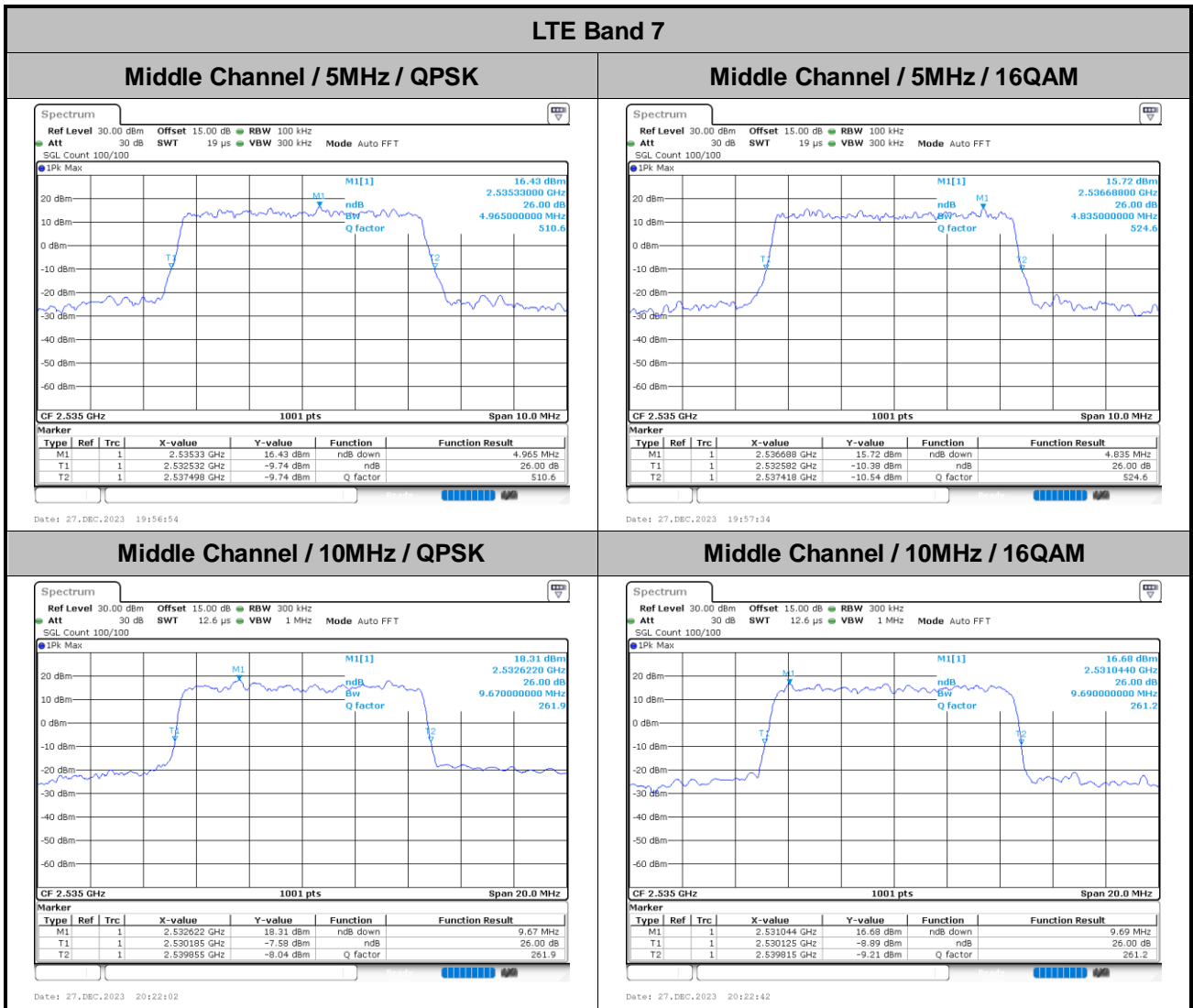



Middle Channel / 15MHz / QPSK

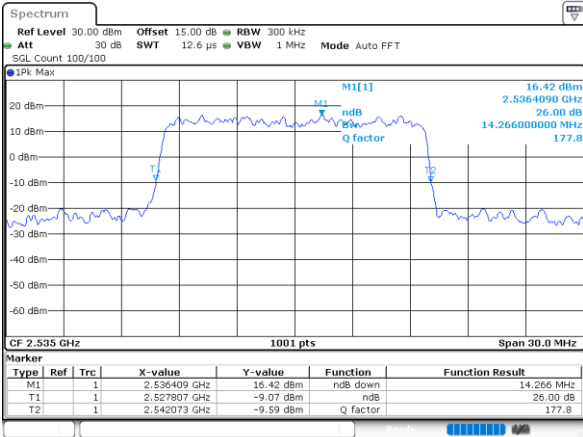

Date: 27.DEC.2023 20:41:10

Middle Channel / 15MHz / 16QAM

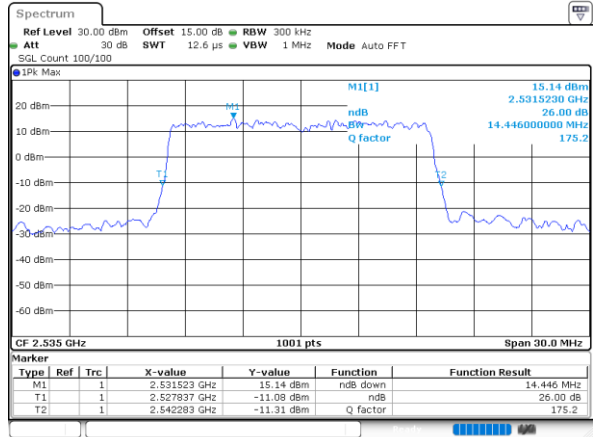

Date: 27.DEC.2023 20:41:50

LTE Band 7

Middle Channel / 20MHz / QPSK

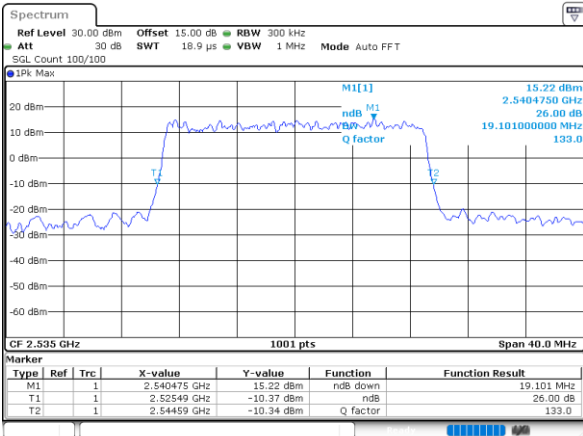

Date: 27.DEC.2023 21:15:05

Middle Channel / 20MHz / 16QAM

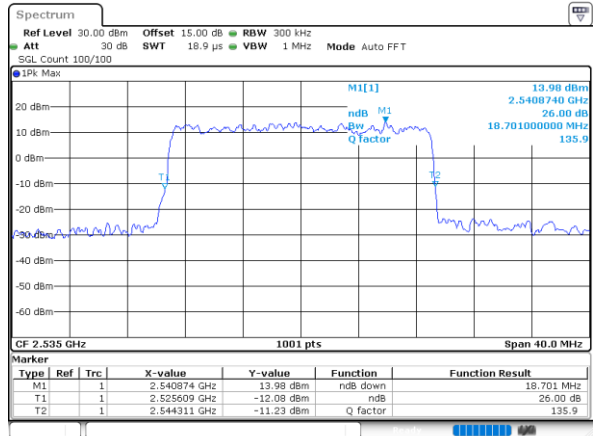

Date: 27.DEC.2023 21:15:45



Occupied Bandwidth

Mode	LTE Band 7 : 99%OBW(MHz)											
	-				5MHz		10MHz		15MHz		20MHz	
BW	-				5MHz	10MHz	10MHz	15MHz	15MHz	20MHz	20MHz	
Mod.	-				QPSK	16QAM	QPSK	16QAM	QPSK	16QAM	QPSK	16QAM
Middle CH	-				4.47	4.48	8.99	9.03	13.46	13.49	17.90	17.98

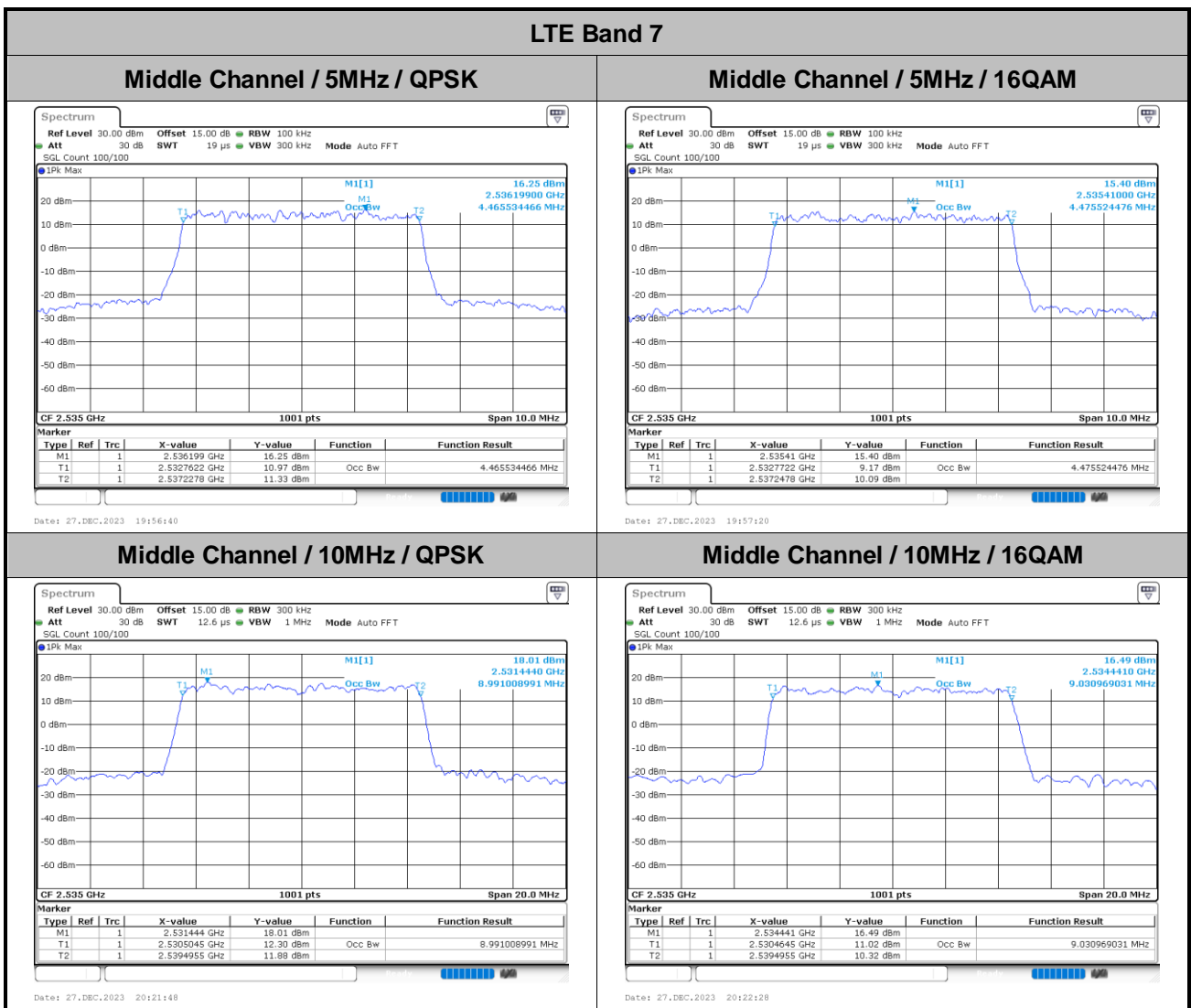



Middle Channel / 15MHz / QPSK

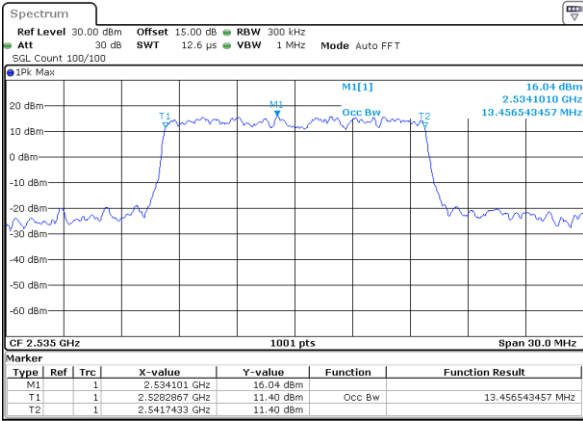

Date: 27.DEC.2023 20:40:56

Middle Channel / 15MHz / 16QAM

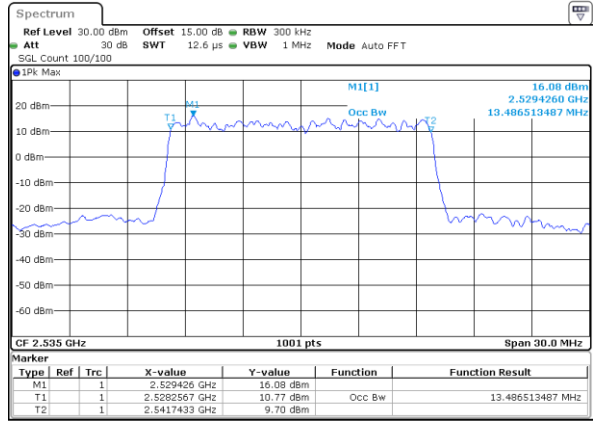

Date: 27.DEC.2023 20:41:36

LTE Band 7

Middle Channel / 20MHz / QPSK

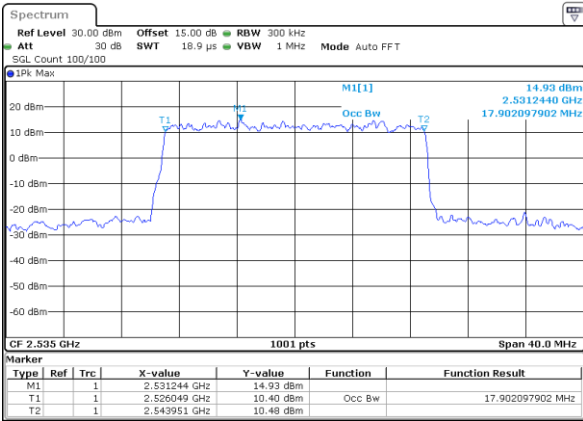

Date: 27.DEC.2023 21:14:51

Middle Channel / 20MHz / 16QAM

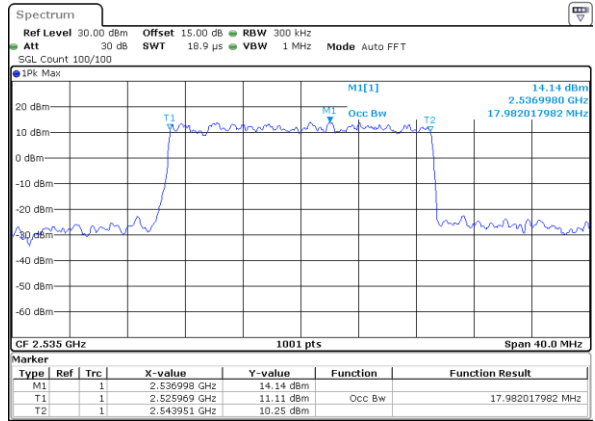

Date: 27.DEC.2023 21:15:31



Conducted Band Edge

LTE Band 7 / 5MHz / QPSK

Lowest Band Edge / 1 RB

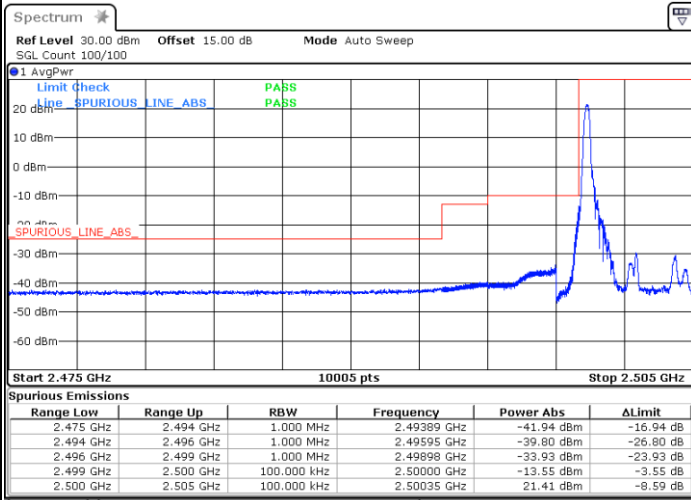

Date: 27.DEC.2023 21:36:20

Highest Band Edge / 1 RB

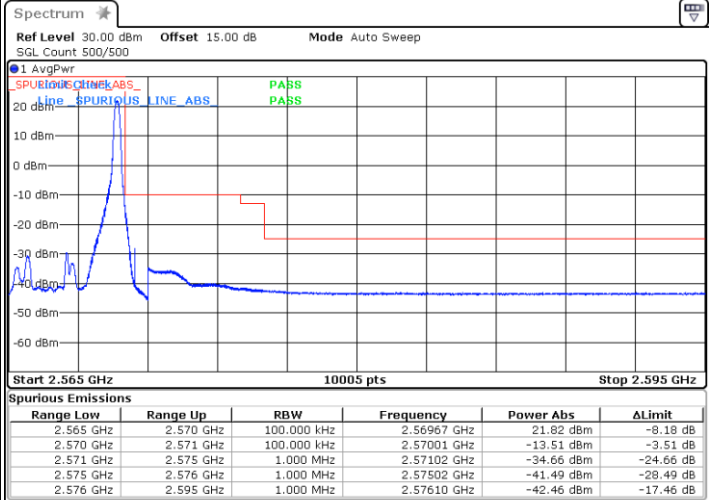

Date: 27.DEC.2023 21:40:25

Lowest Band Edge / Full RB

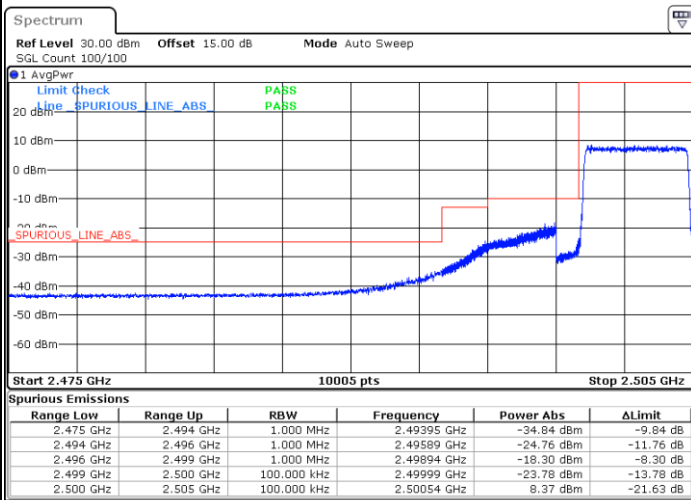

Date: 27.DEC.2023 19:51:49

Highest Band Edge / Full RB

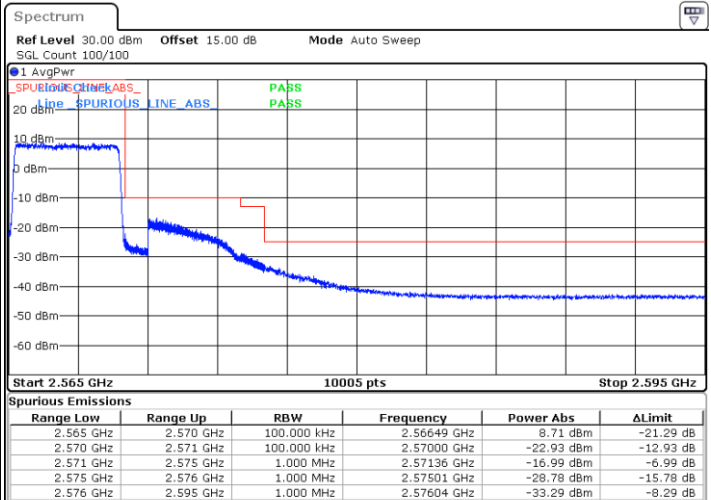

Date: 27.DEC.2023 20:01:40



LTE Band 7 / 5MHz / 16QAM

Lowest Band Edge / 1RB

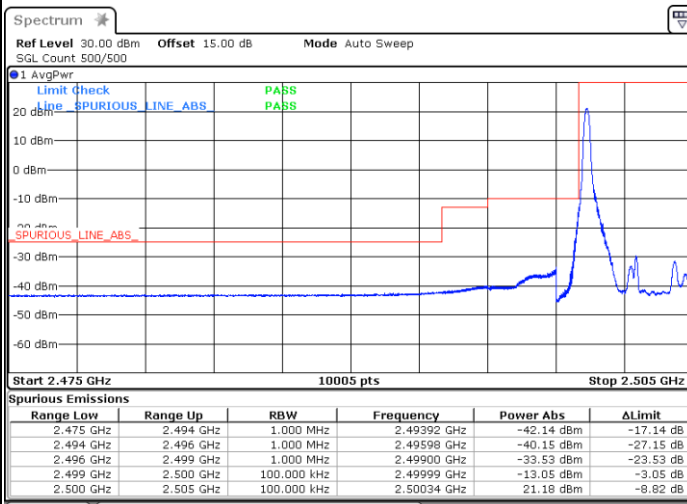

Date: 27.DEC.2023 21:37:46

Highest Band Edge / 1 RB

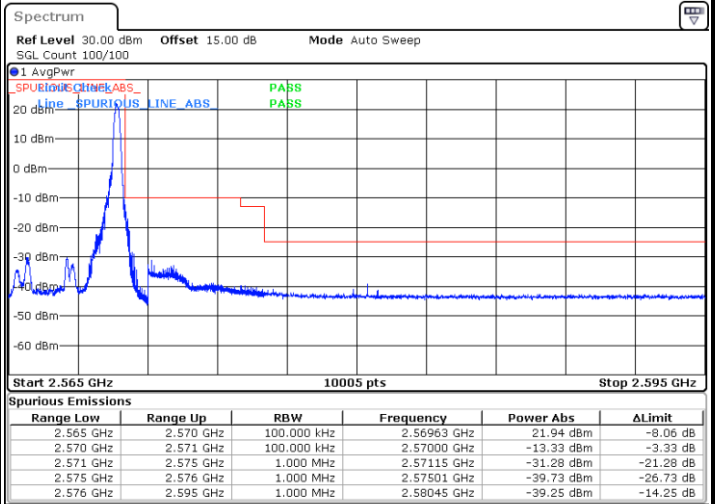

Date: 27.DEC.2023 21:41:29

Lowest Band Edge / Full RB

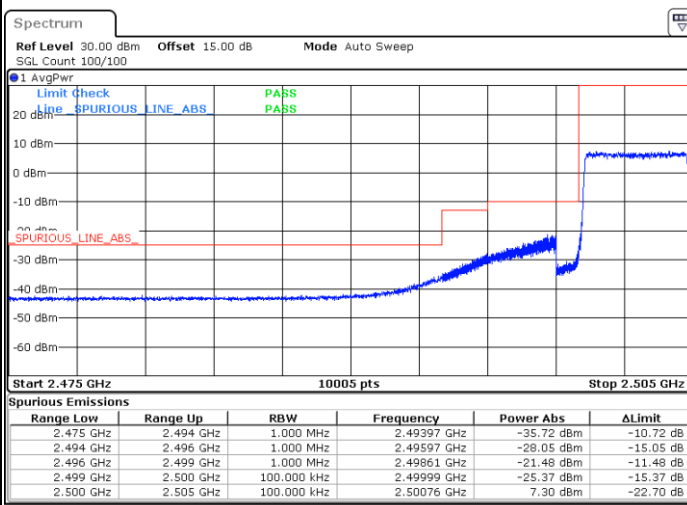

Date: 27.DEC.2023 19:52:51

Highest Band Edge / Full RB

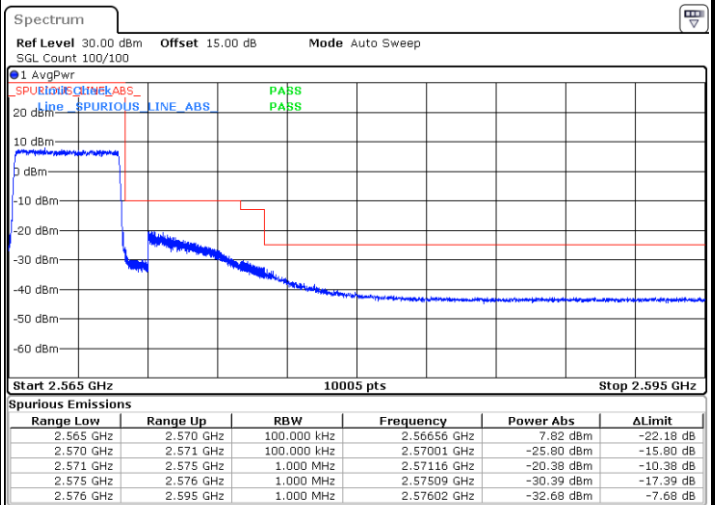

Date: 27.DEC.2023 20:02:42



LTE Band 7 / 5MHz / 64QAM

Lowest Band Edge / 1RB

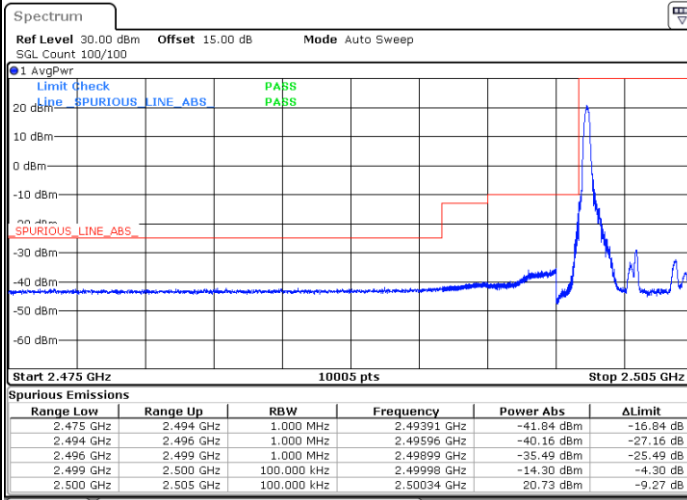

Date: 27.DEC.2023 19:50:46

Highest Band Edge / 1 RB

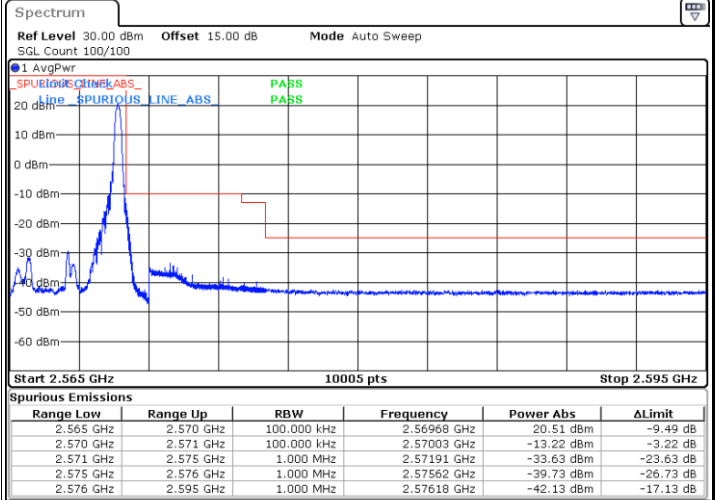

Date: 27.DEC.2023 21:42:03

Lowest Band Edge / Full RB

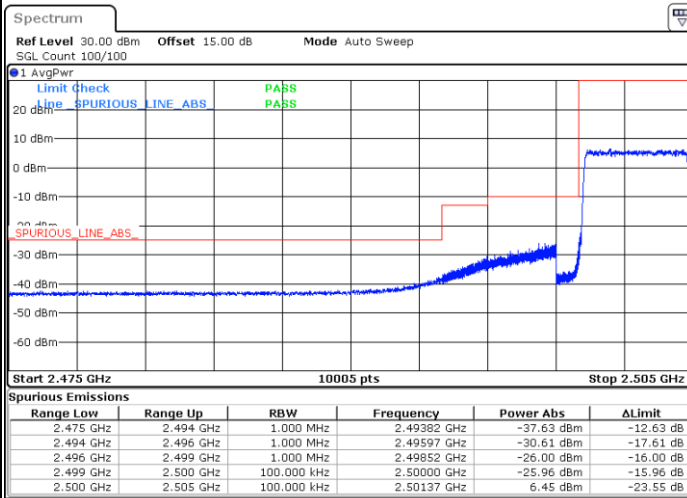

Date: 27.DEC.2023 19:53:53

Highest Band Edge / Full RB

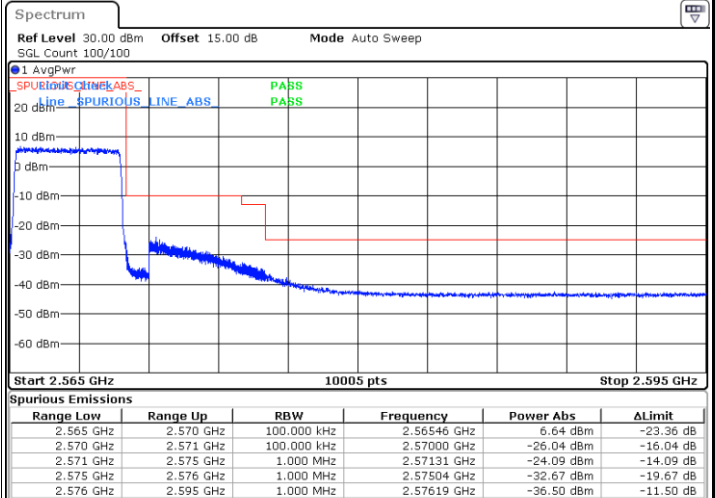

Date: 27.DEC.2023 20:03:44



LTE Band 7 / 10MHz / QPSK

Lowest Band Edge / 1 RB

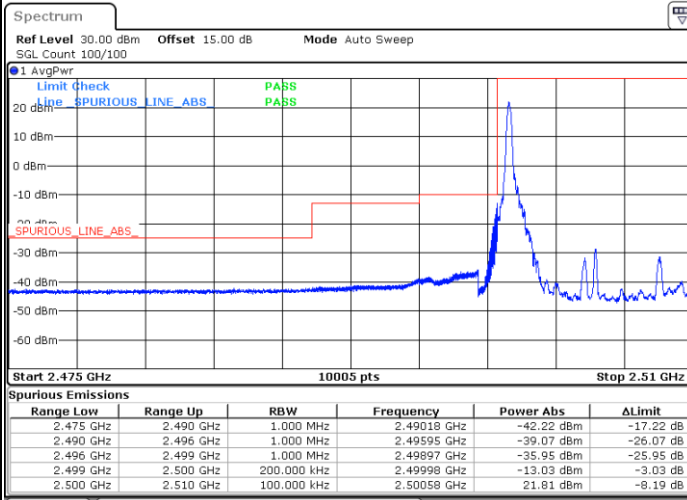

Date: 27.DEC.2023 20:13:52

Highest Band Edge / 1 RB

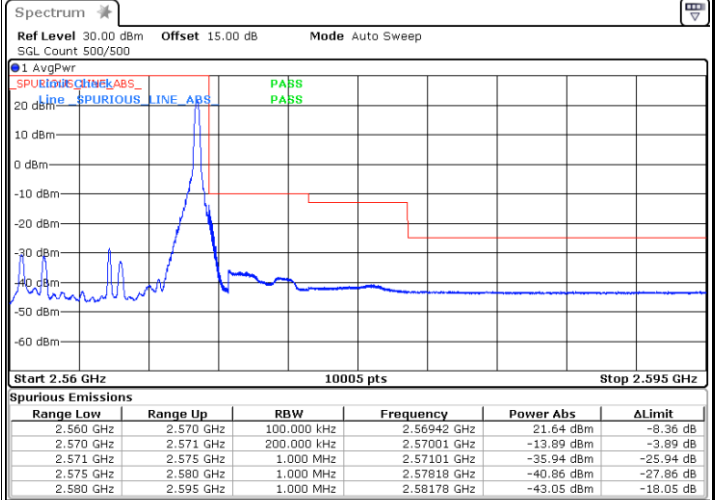

Date: 27.DEC.2023 21:47:49

Lowest Band Edge / Full RB

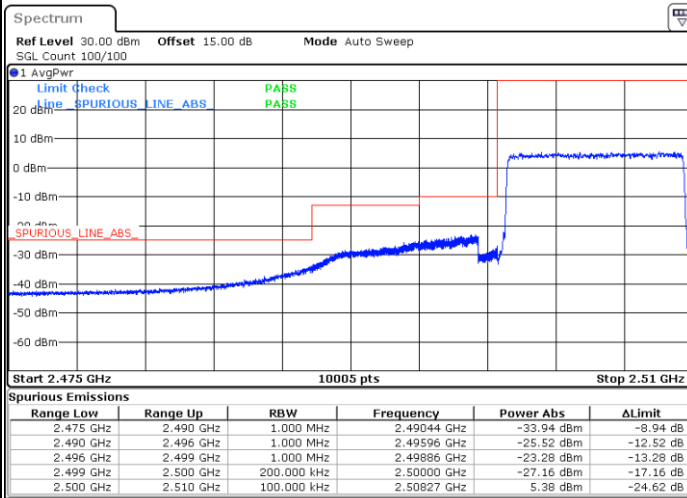

Date: 27.DEC.2023 20:16:58

Highest Band Edge / Full RB

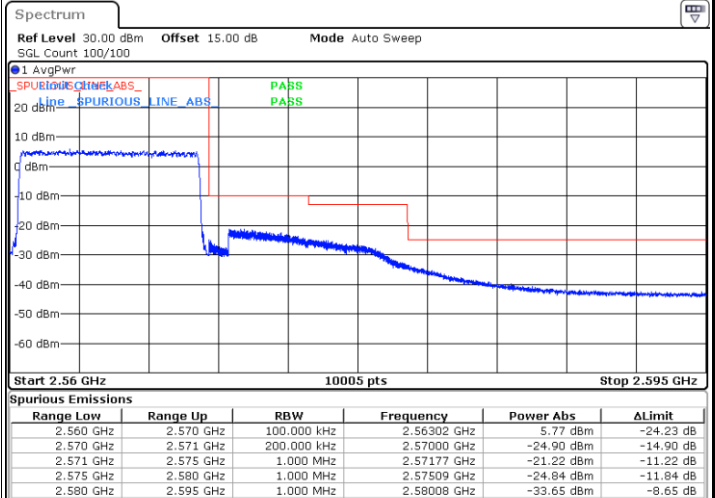

Date: 27.DEC.2023 20:26:49



LTE Band 7 / 10MHz / 16QAM

Lowest Band Edge / 1RB

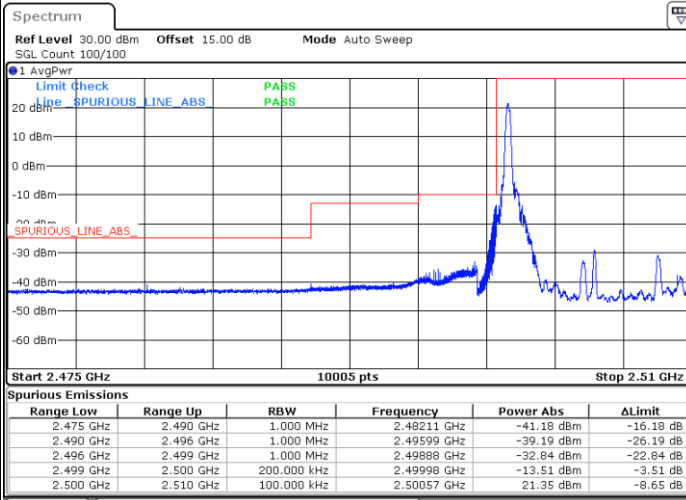

Date: 27.DEC.2023 20:14:54

Highest Band Edge / 1 RB

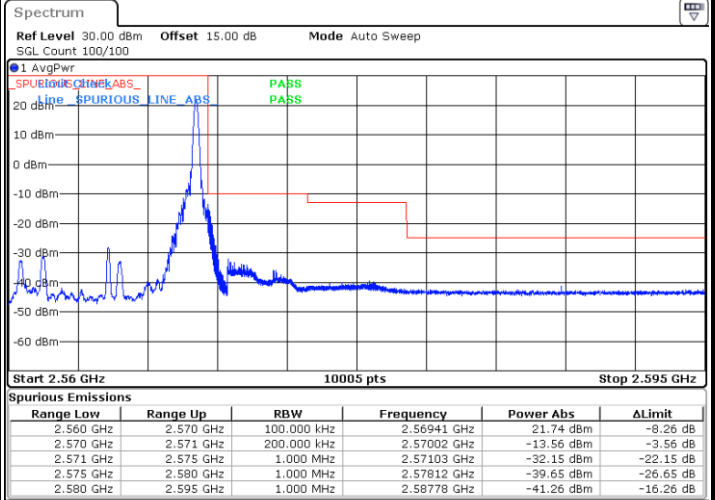

Date: 27.DEC.2023 20:24:45

Lowest Band Edge / Full RB

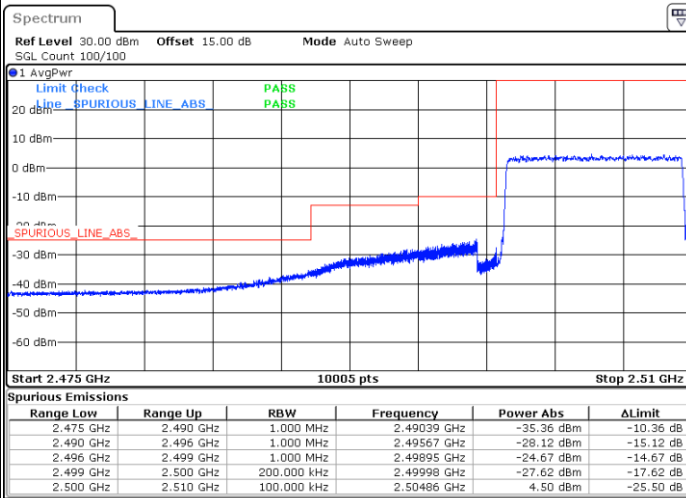

Date: 27.DEC.2023 20:18:00

Highest Band Edge / Full RB

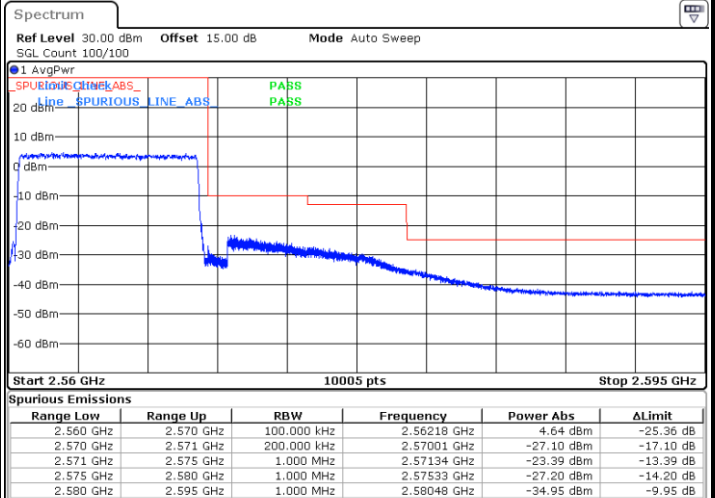

Date: 27.DEC.2023 20:27:51



LTE Band 7 / 10MHz / 64QAM

Lowest Band Edge / 1RB

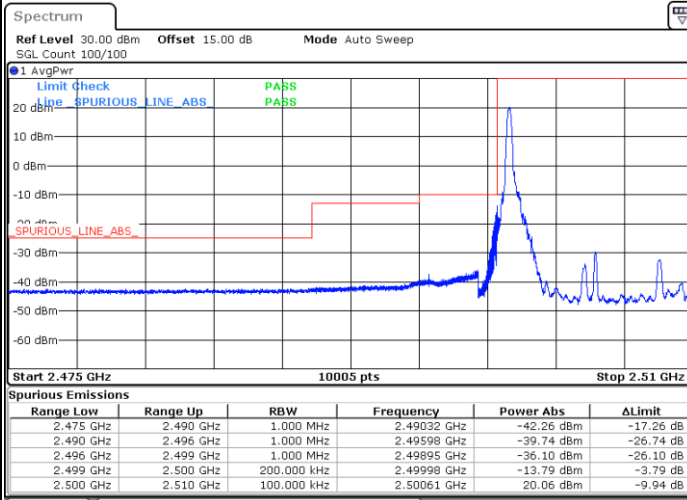

Date: 27.DEC.2023 21:46:23

Highest Band Edge / 1 RB

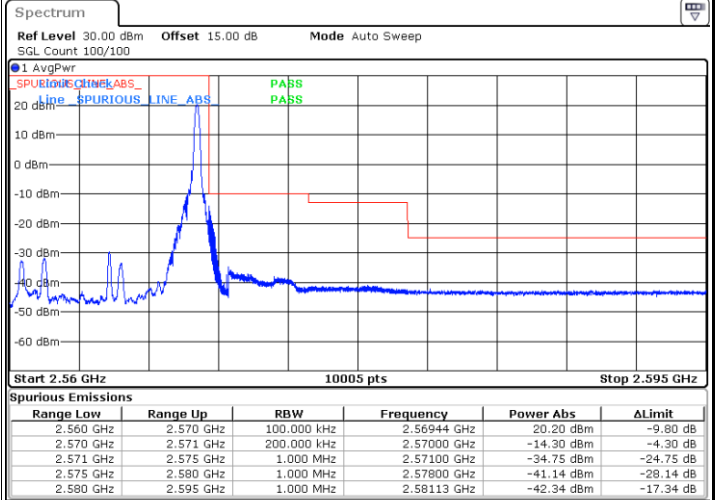

Date: 27.DEC.2023 20:25:46

Lowest Band Edge / Full RB

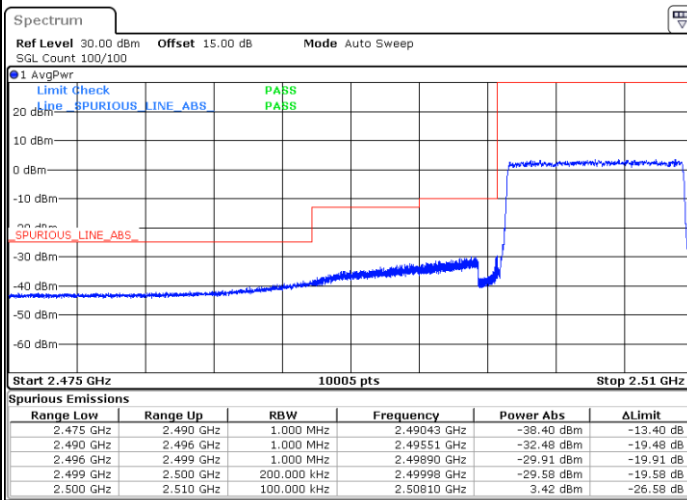

Date: 27.DEC.2023 20:19:02

Highest Band Edge / Full RB

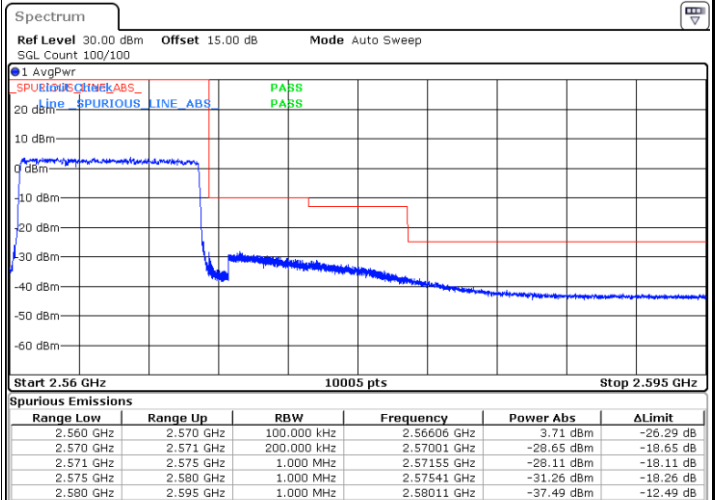

Date: 27.DEC.2023 20:28:53



LTE Band 7 / 15MHz / QPSK

Lowest Band Edge / 1 RB

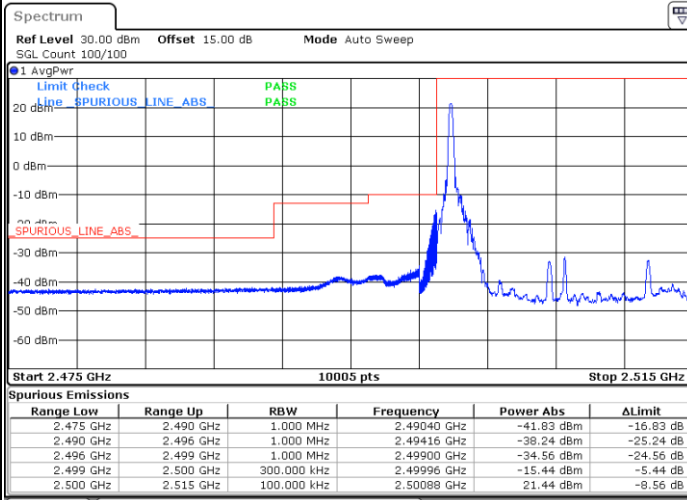

Date: 27.DEC.2023 20:32:59

Highest Band Edge / 1 RB

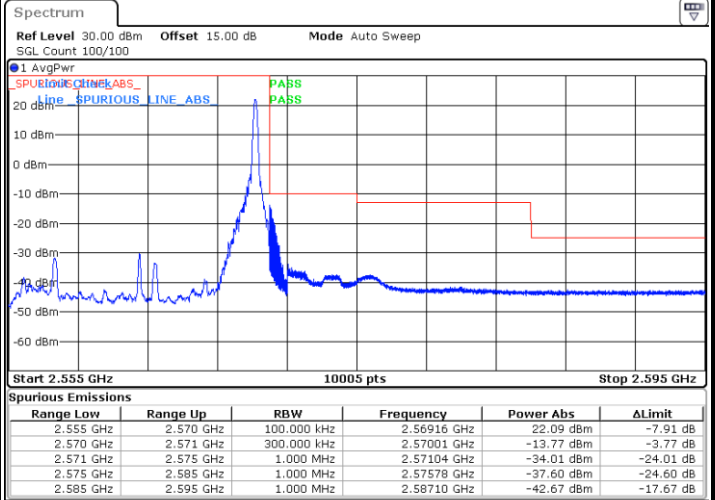

Date: 27.DEC.2023 20:42:51

Lowest Band Edge / Full RB

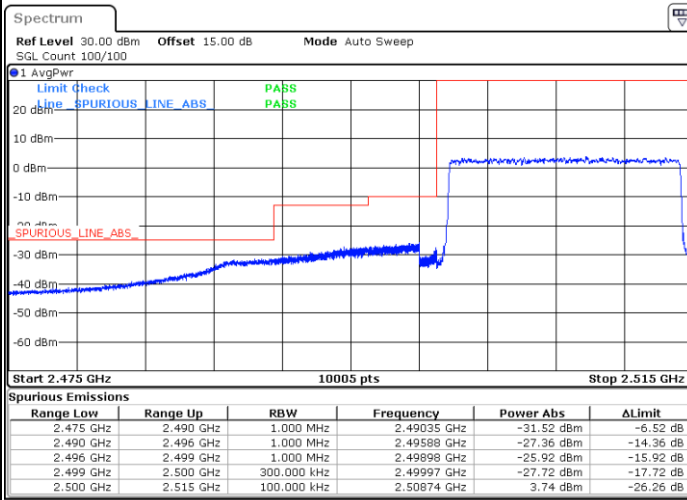

Date: 27.DEC.2023 20:36:04

Highest Band Edge / Full RB

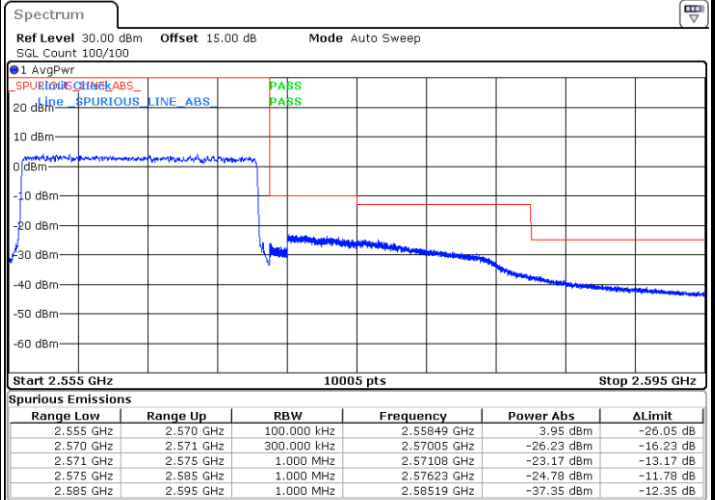

Date: 27.DEC.2023 20:45:57



LTE Band 7 / 15MHz / 16QAM

Lowest Band Edge / 1RB

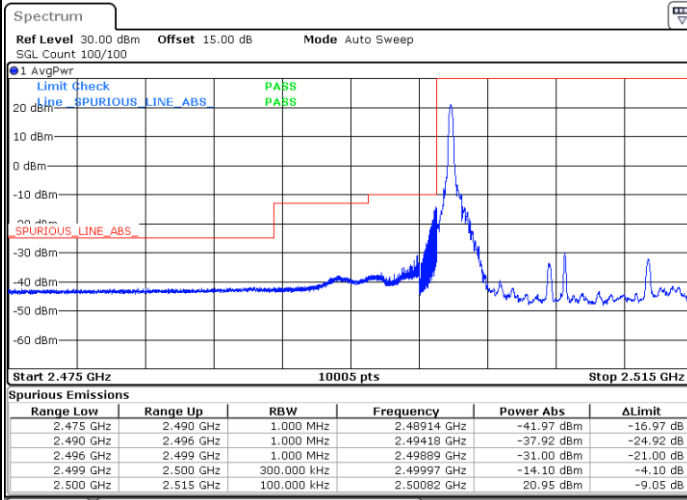

Date: 27.DEC.2023 20:34:00

Highest Band Edge / 1 RB

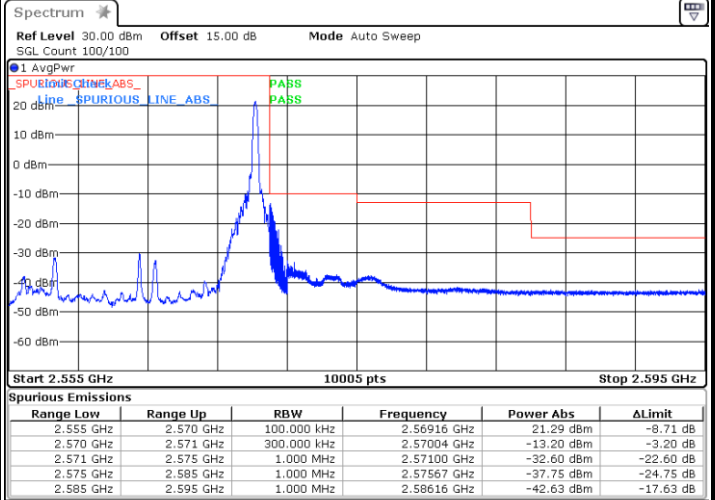

Date: 27.DEC.2023 21:50:15

Lowest Band Edge / Full RB

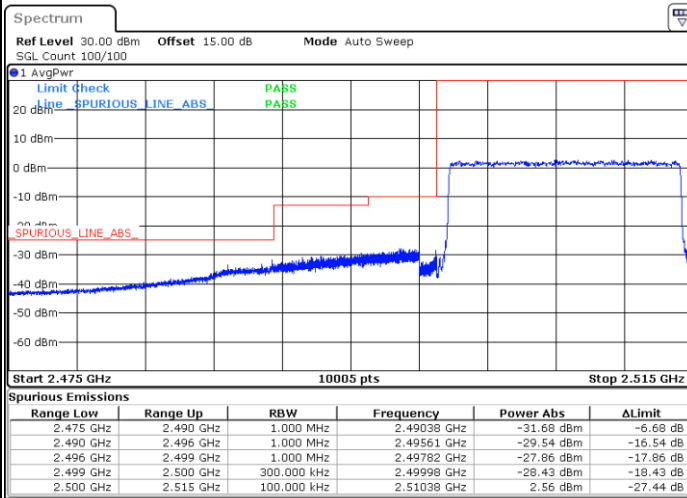

Date: 27.DEC.2023 20:37:06

Highest Band Edge / Full RB

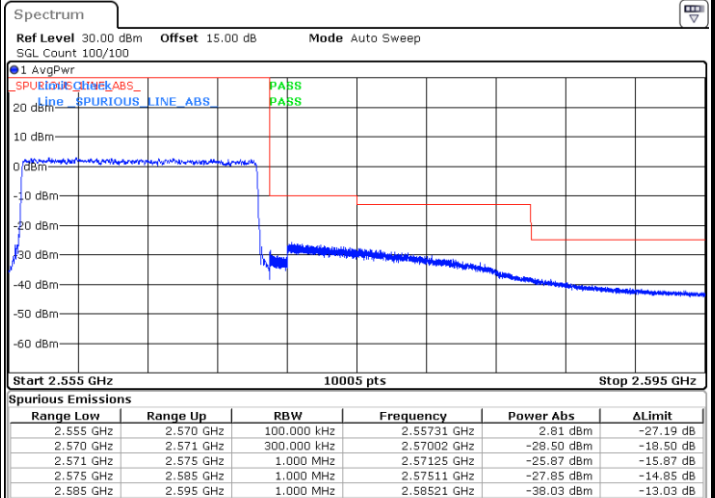

Date: 27.DEC.2023 20:46:58



LTE Band 7 / 15MHz / 64QAM

Lowest Band Edge / 1RB

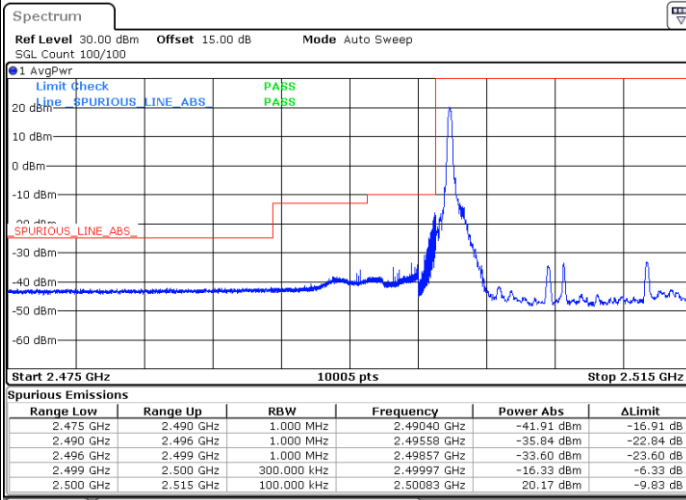

Date: 27.DEC.2023 20:35:02

Highest Band Edge / 1 RB

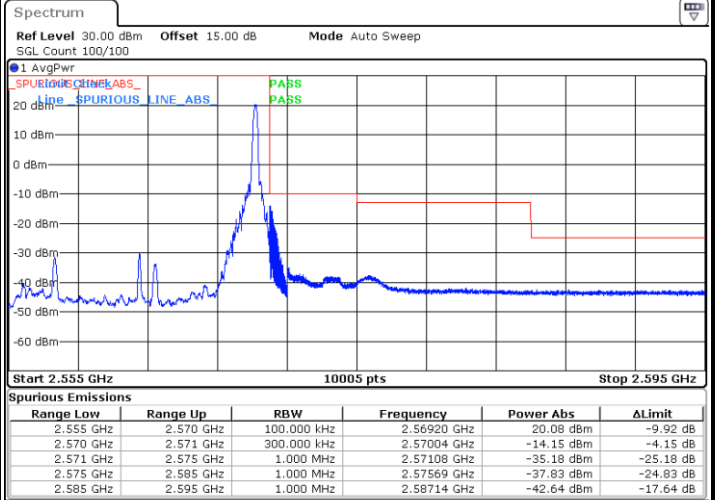

Date: 27.DEC.2023 20:44:55

Lowest Band Edge / Full RB

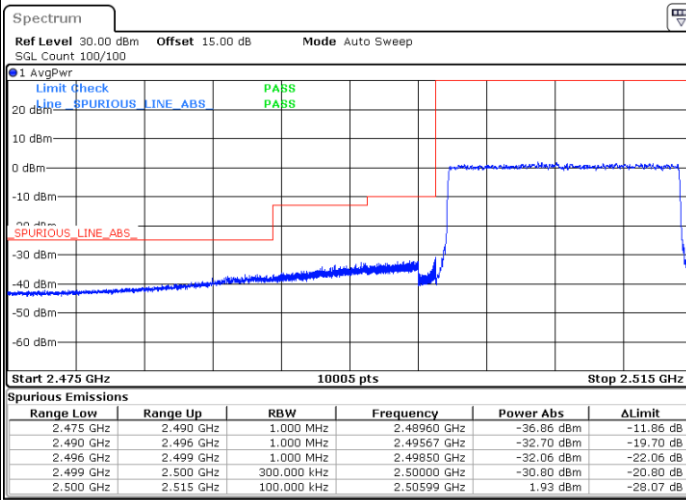

Date: 27.DEC.2023 20:38:08

Highest Band Edge / Full RB

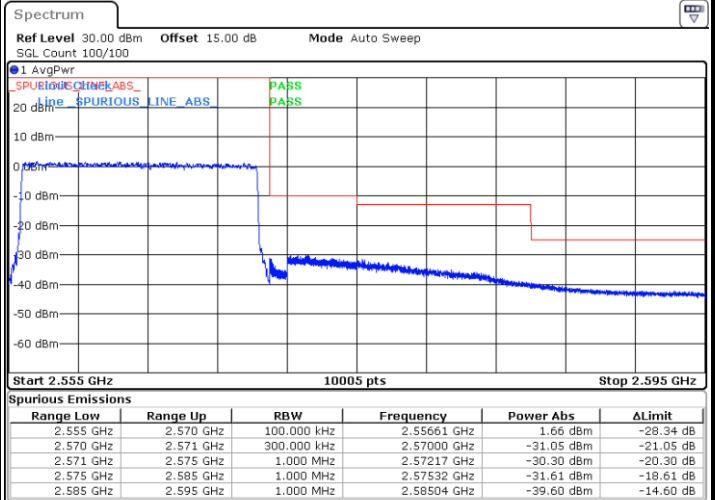

Date: 27.DEC.2023 21:02:50



LTE Band 7 / 20MHz / QPSK

Lowest Band Edge / 1 RB

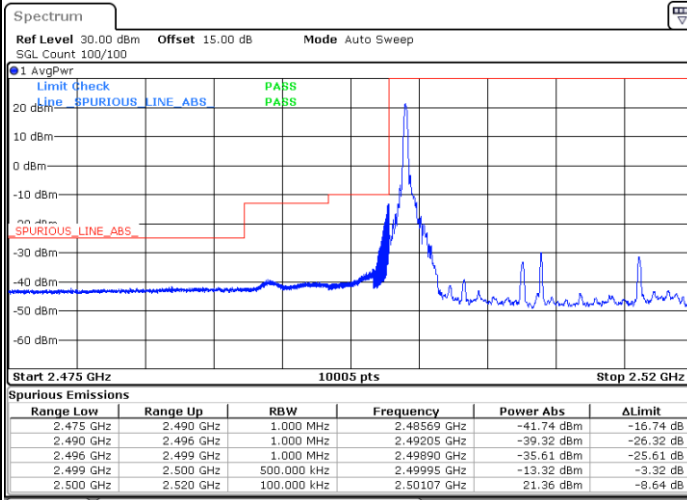

Date: 27.DEC.2023 21:52:54

Highest Band Edge / 1 RB

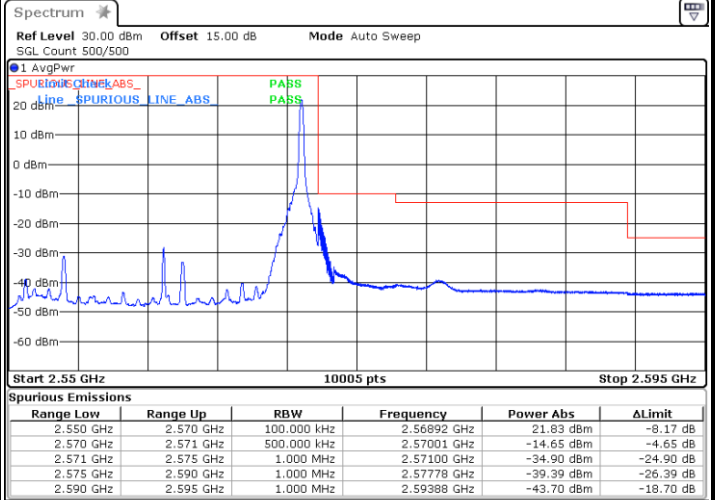

Date: 27.DEC.2023 21:56:42

Lowest Band Edge / Full RB

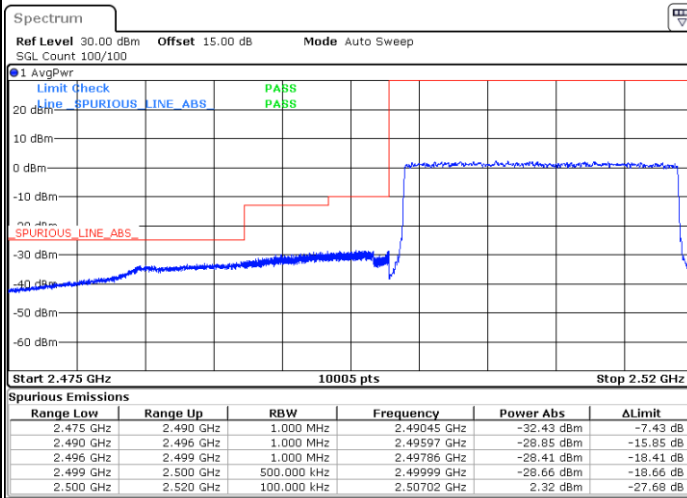

Date: 27.DEC.2023 21:10:00

Highest Band Edge / Full RB

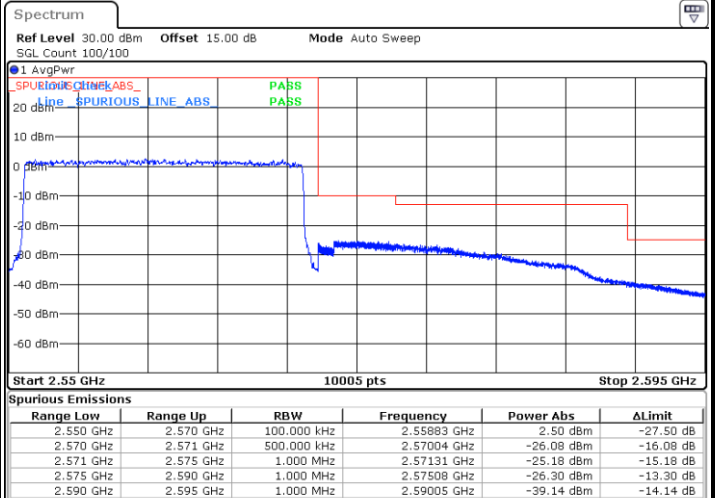

Date: 27.DEC.2023 21:21:15



LTE Band 7 / 20MHz / 16QAM

Lowest Band Edge / 1RB

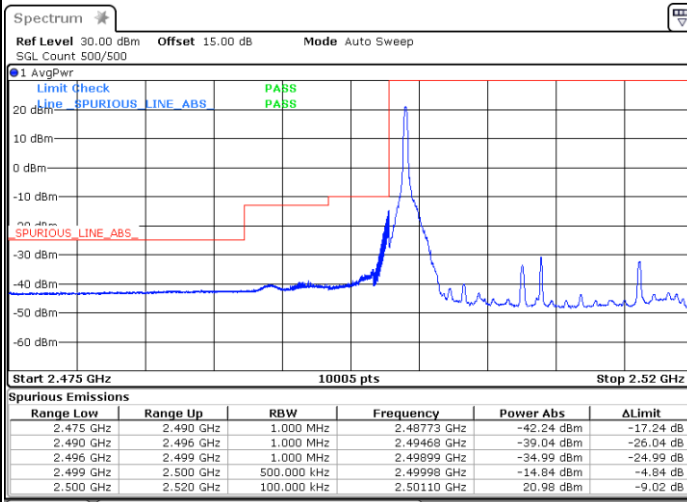

Date: 27.DEC.2023 21:53:59

Highest Band Edge / 1 RB

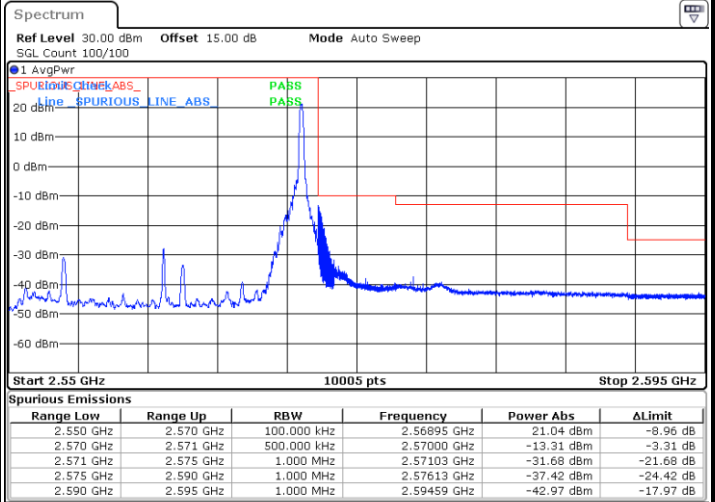

Date: 27.DEC.2023 21:19:11

Lowest Band Edge / Full RB

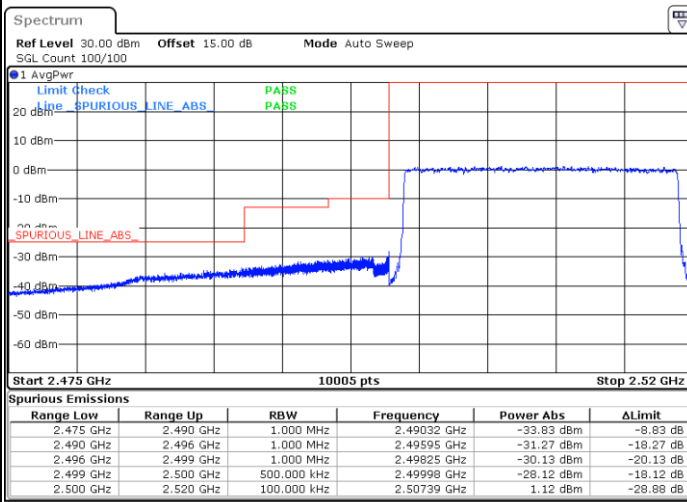

Date: 27.DEC.2023 21:11:02

Highest Band Edge / Full RB

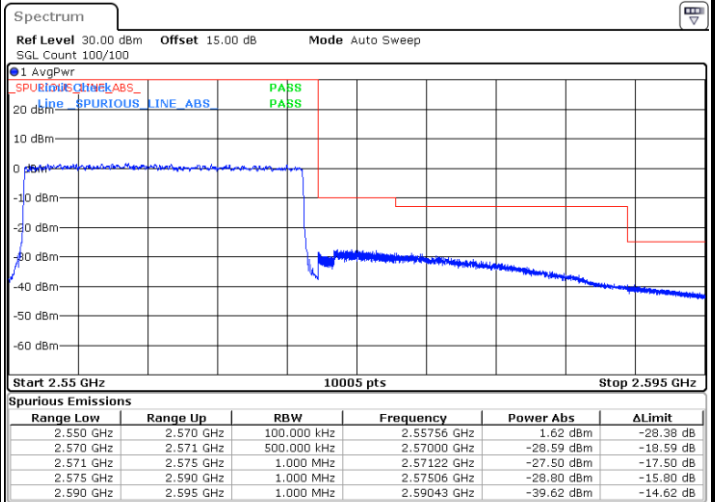

Date: 27.DEC.2023 21:22:17



LTE Band 7 / 20MHz / 64QAM

Lowest Band Edge / 1RB

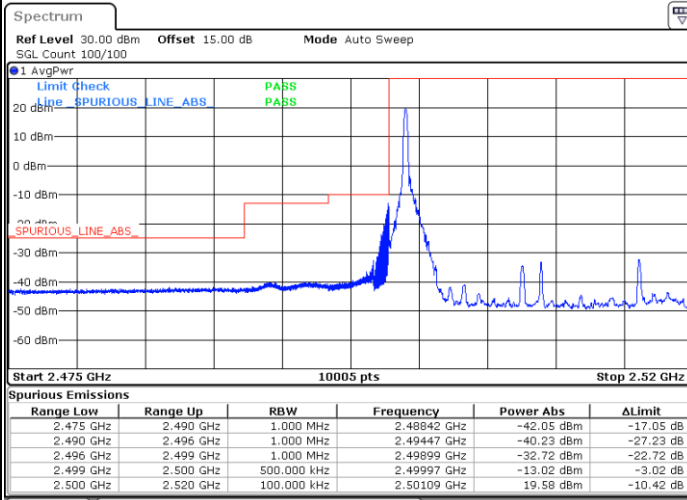

Date: 27.DEC.2023 21:08:58

Highest Band Edge / 1 RB

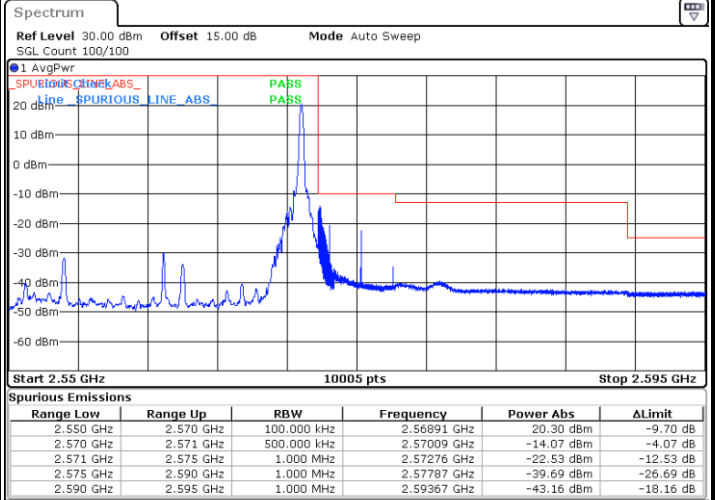

Date: 27.DEC.2023 21:57:20

Lowest Band Edge / Full RB

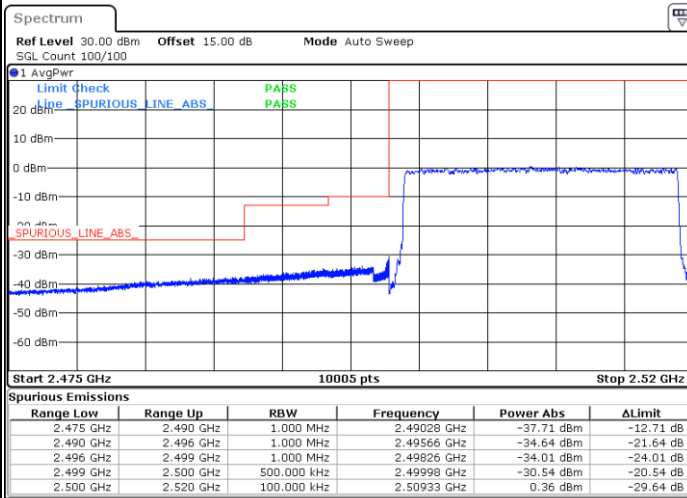

Date: 27.DEC.2023 21:12:04

Highest Band Edge / Full RB

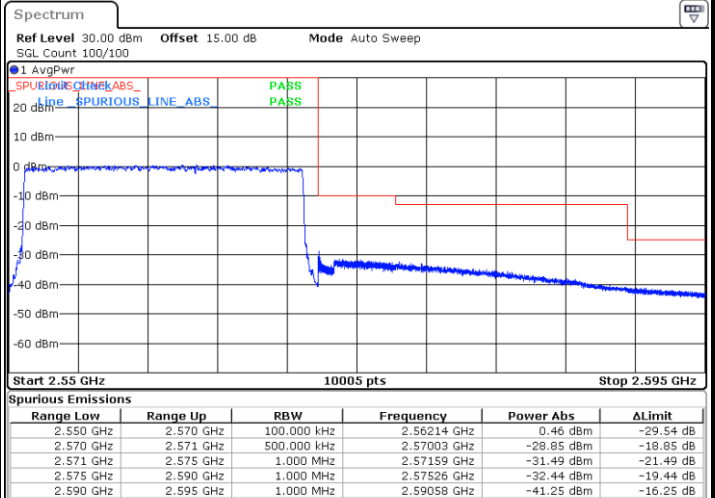

Date: 27.DEC.2023 21:23:19



Conducted Spurious Emission

LTE Band 7 / 5MHz

Lowest Channel / QPSK

Middle Channel / QPSK

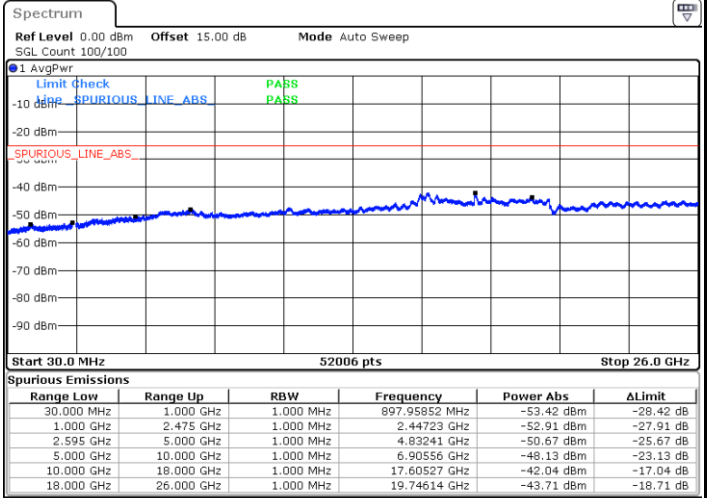
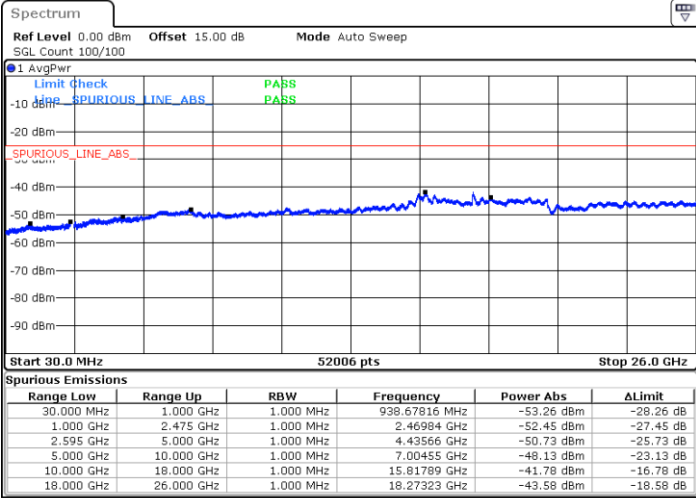

Date: 27.DEC.2023 19:55:03

Date: 27.DEC.2023 19:56:13

Highest Channel / QPSK

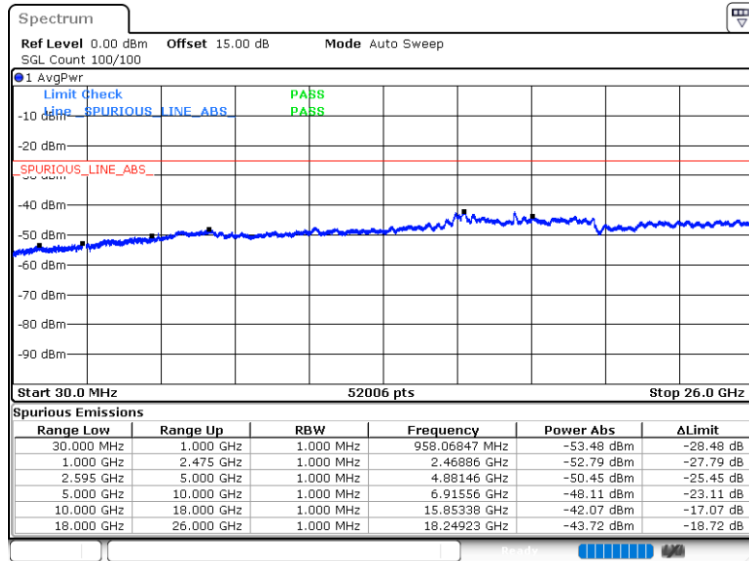

Date: 27.DEC.2023 20:04:54



LTE Band 7 / 10MHz

Lowest Channel / QPSK

Middle Channel / QPSK

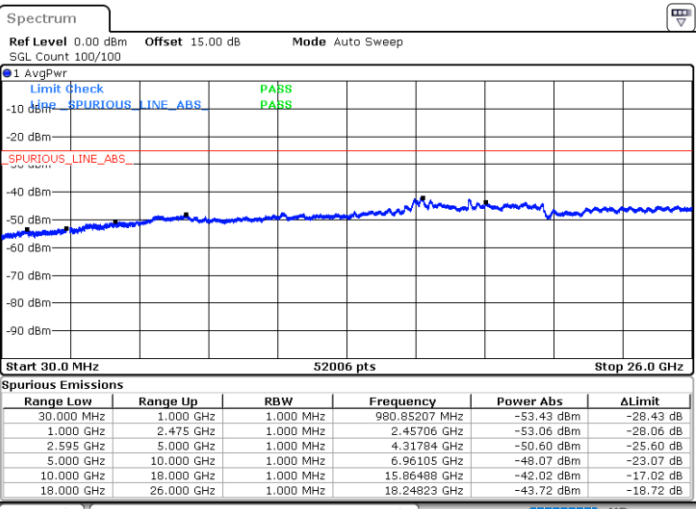
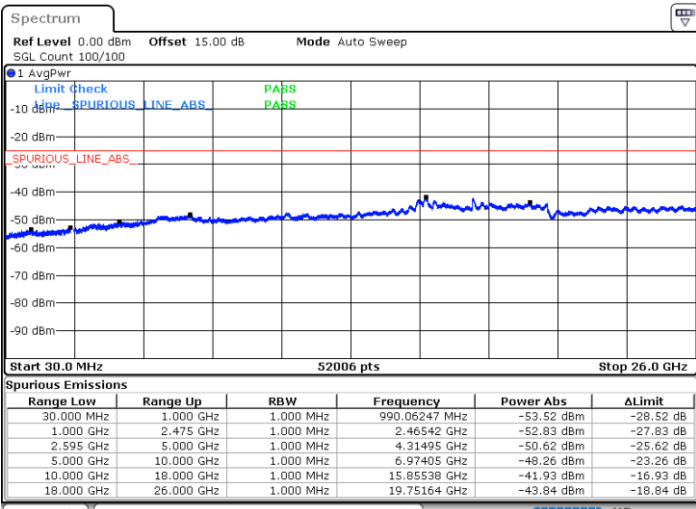

Date: 27.DEC.2023 20:20:12

Date: 27.DEC.2023 20:21:22

Highest Channel / QPSK

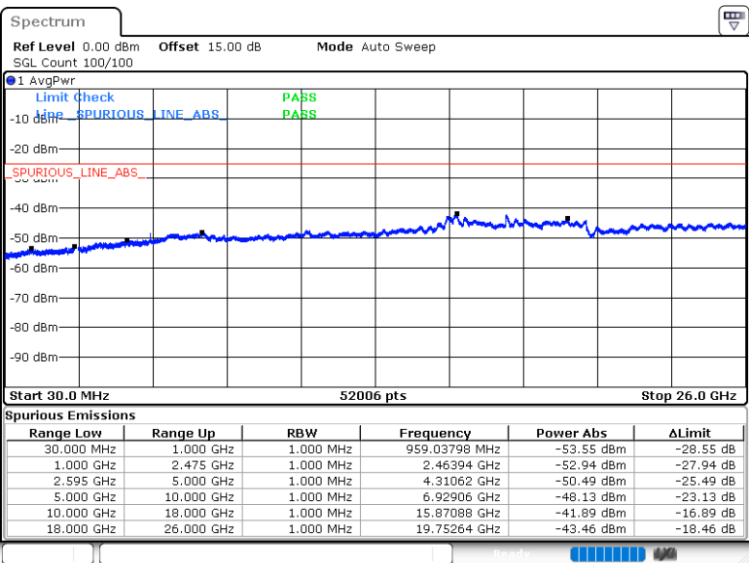

Date: 27.DEC.2023 20:30:03



LTE Band 7 / 15MHz

Lowest Channel / QPSK

Middle Channel / QPSK

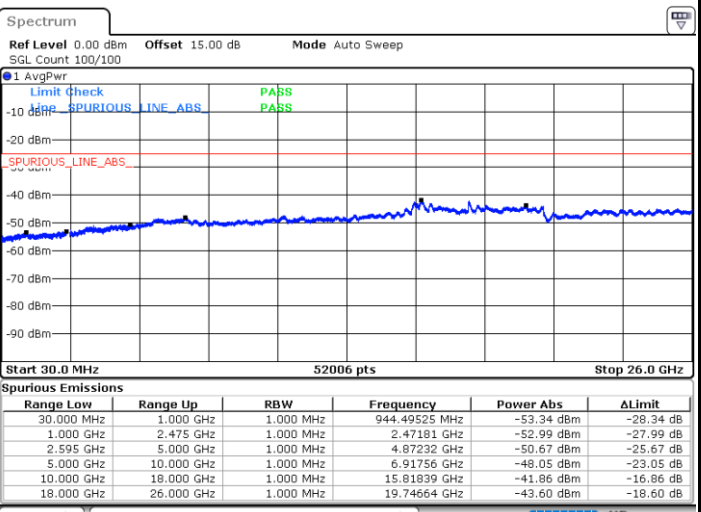
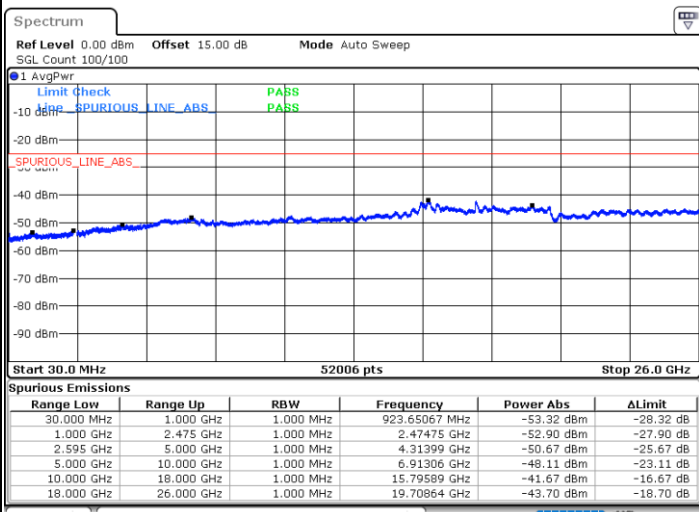

Date: 27.DEC.2023 20:39:20

Date: 27.DEC.2023 20:40:30

Highest Channel / QPSK

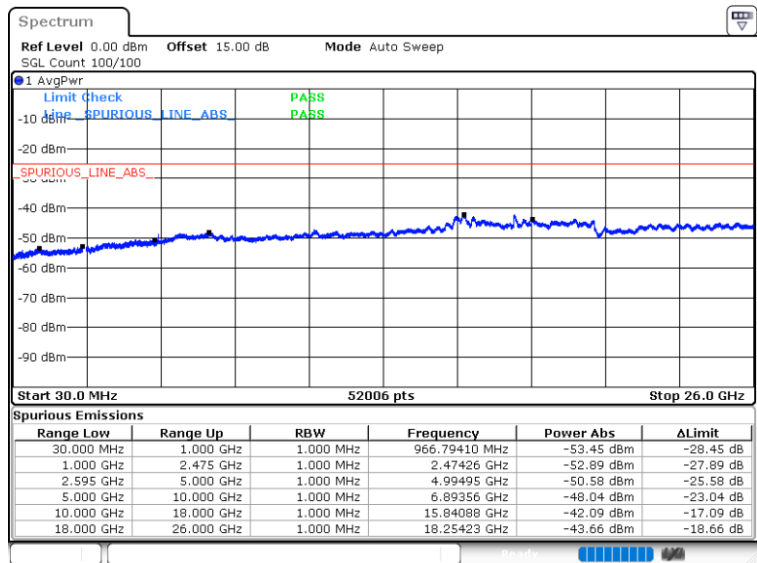

Date: 27.DEC.2023 21:04:00