



# FCC RF Test Report

**APPLICANT** : Realme Chongqing Mobile  
Telecommunications Corp., Ltd.  
**EQUIPMENT** : Mobile Phone  
**BRAND NAME** : realme  
**MODEL NAME** : RMX3999  
**FCC ID** : 2AUYFRMX3999  
**STANDARD** : 47 CFR Part 2, and 90(S)  
**CLASSIFICATION** : PCS Licensed Transmitter Held to Ear (PCE)  
**TEST DATE(S)** : Dec. 28, 2023 ~ Jan. 08, 2024

We, Sporton International Inc. (Shenzhen), would like to declare that the tested sample has been evaluated in accordance with the procedures given in ANSI C63.26-2015 and shown compliance with the applicable technical standards.

The test results in this report apply exclusively to the tested model / sample. Without written approval of Sporton International Inc. (Shenzhen), the test report shall not be reproduced except in full.

Jason Jia



Approved by: Jason Jia

**Sporton International Inc. (ShenZhen)**

**1/F, 2/F, Bldg 5, Shiling Industrial Zone, Xinwei Village, Xili, Nanshan, Shenzhen, 518055**

**People's Republic of China**



# TABLE OF CONTENTS

**REVISION HISTORY..... 3**

**SUMMARY OF TEST RESULT ..... 4**

**1 GENERAL DESCRIPTION ..... 5**

    1.1 Applicant..... 5

    1.2 Manufacturer ..... 5

    1.3 Feature of Equipment Under Test..... 5

    1.4 Product Specification of Equipment Under Test ..... 5

    1.5 Modification of EUT ..... 5

    1.6 Maximum Conducted Power and Emission Designator ..... 6

    1.7 Testing Site..... 6

    1.8 Test Software ..... 6

    1.9 Applied Standards ..... 7

**2 TEST CONFIGURATION OF EQUIPMENT UNDER TEST ..... 8**

    2.1 Test Mode..... 8

    2.2 Connection Diagram of Test System ..... 9

    2.3 Support Unit used in test configuration and system ..... 9

    2.4 Measurement Results Explanation Example ..... 9

    2.5 Frequency List of Low/Middle/High Channels ..... 10

**3 TEST RESULT ..... 11**

    3.1 Conducted Output Power Measurement ..... 11

    3.2 99% Occupied Bandwidth and 26dB Bandwidth Measurement..... 12

    3.3 Emissions Mask Measurement ..... 13

    3.4 Emissions Mask – Out Of Band Emissions Measurement..... 15

    3.5 Field Strength of Spurious Radiation Measurement ..... 16

    3.6 Frequency Stability Measurement..... 19

**4 LIST OF MEASURING EQUIPMENT ..... 21**

**5 MEASUREMENT UNCERTAINTY ..... 22**

**APPENDIX A. TEST RESULTS OF CONDUCTED TEST**

**APPENDIX B. TEST RESULTS OF RADIATED TEST**

**APPENDIX C. TEST SETUP PHOTOGRAPHS**





### SUMMARY OF TEST RESULT

Report Section	FCC Rule	Description	Limit	Result	Remark
3.1	§2.1046	Conducted Output Power	—	Report only	-
3.2	§2.1049 §90.209	Occupied Bandwidth and 26dB Bandwidth	—	Report only	-
3.3	§2.1051 §90.691	Emission masks – In-band emissions	$< 50+10\log_{10}(P[\text{Watts}])$	PASS	-
3.4	§2.1051 §90.691	Emission masks – Out of band emissions	$< 43+10\log_{10}(P[\text{Watts}])$	PASS	-
3.5	§2.1053 §90.691	Field Strength of Spurious Radiation	$< 43+10\log_{10}(P[\text{Watts}])$	PASS	Under limit 43.10 dB at 3258.00 MHz
3.6	§2.1055 §90.213	Frequency Stability for Temperature & Voltage	$< 2.5 \text{ ppm}$	PASS	-

**Conformity Assessment Condition:**

1. The test results (PASS/FAIL) with all measurement uncertainty excluded are presented against the regulation limits or in accordance with the requirements stipulated by the applicant/matrix manufacturer who shall bear all the risks of non-compliance that may potentially occur if measurement uncertainty is taken into account.
2. The measurement uncertainty please refer to each test result in the section "Measurement Uncertainty"

**Disclaimer:**

The product specifications of the EUT presented in the test report that may affect the test assessments are declared by the manufacturer who shall take full responsibility for the authenticity.



# 1 General Description

## 1.1 Applicant

Realme Chongqing Mobile Telecommunications Corp., Ltd.  
No.178 Yulong Avenue, Yufengshan, Yubei District, Chongqing, China

## 1.2 Manufacturer

Realme Chongqing Mobile Telecommunications Corp., Ltd.  
No.178 Yulong Avenue, Yufengshan, Yubei District, Chongqing, China

## 1.3 Feature of Equipment Under Test

Product Feature	
Equipment	Mobile Phone
Brand Name	realme
Model Name	RMX3999
FCC ID	2AUYFRMX3999
IMEI Code	Conducted: 863155070029978/863155070029960 Radiation: 863155070031834/863155070031826
HW Version	11
SW Version	realme UI 5.0
EUT Stage	Production Unit

Remark: The above EUT's information was declared by manufacturer. Please refer to the specifications or user's manual for more detailed description.

## 1.4 Product Specification of Equipment Under Test

Product Specification subjective to this standard	
Tx Frequency	814 ~ 824 MHz
Rx Frequency	859 ~ 869 MHz
Bandwidth	1.4MHz / 3MHz / 5MHz / 10MHz / 15MHz
Maximum Output Power to Antenna	Ant.0 :23.02 dBm Ant.1 :23.05 dBm
Antenna Gain	Ant.0 : -2.60 dBi Ant.1 : -1.71 dBi
Type of Modulation	QPSK / 16QAM / 64QAM

Note: Only maximum conducted Power of Ant.1 is shown in the report.

## 1.5 Modification of EUT

No modifications are made to the EUT during all test items.



### 1.6 Maximum Conducted Power and Emission Designator

LTE Band 26		QPSK		16QAM/64QAM	
BW (MHz)	Frequency Range (MHz)	Maximum Conducted power (W)	Emission Designator (99%OBW)	Maximum Conducted power (W)	Emission Designator (99%OBW)
1.4	814.7 ~ 823.3	0.1854	1M09G7D	0.1538	1M08W7D
3	815.5 ~ 822.5	0.1828	2M72G7D	0.1535	2M73W7D
5	816.5 ~ 821.5	0.1858	4M48G7D	0.1552	4M50W7D
10	819.0	0.1862	9M03G7D	0.1560	9M03W7D
15	824	0.2018	13M4G7D	0.1592	13M4W7D

Note: All modulations have been tested, and only the worst test results are shown in the report.

### 1.7 Testing Site

Sporton International Inc. (ShenZhen) is accredited to ISO/IEC 17025:2017 by American Association for Laboratory Accreditation with Certificate Number 5145.01.

<b>Test Firm</b>	Sporton International Inc. (ShenZhen)		
<b>Test Site Location</b>	1/F, 2/F, Bldg 5, Shiling Industrial Zone, Xinwei Village, Xili, Nanshan, Shenzhen, 518055 People’s Republic of China TEL: +86-755-86379589 FAX: +86-755-86379595		
<b>Test Site No.</b>	<b>Sporton Site No.</b>	<b>FCC Designation No.</b>	<b>FCC Test Firm Registration No.</b>
	TH01-SZ	CN1256	421272

<b>Test Firm</b>	Sporton International Inc. (ShenZhen)		
<b>Test Site Location</b>	101, 1st Floor, Block B, Building 1, No. 2, Tengfeng 4th Road, Fenghuang Community, Fuyong Street, Baoan District, Shenzhen City, Guangdong Province 518103 People’s Republic of China TEL: +86-755-86066985		
<b>Test Site No.</b>	<b>Sporton Site No.</b>	<b>FCC Designation No.</b>	<b>FCC Test Firm Registration No.</b>
	03CH01-SZ	CN1256	421272

### 1.8 Test Software

Item	Site	Manufacture	Name	Version
1.	03CH01-SZ	AUDIX	E3	6.2009-8-24



## 1.9 Applied Standards

According to the specifications of the manufacturer, the EUT must comply with the requirements of the following standards:

- ♦ 47 CFR Part 2, 90(S)
- ♦ ANSI C63.26-2015
- ♦ FCC KDB 971168 D01 Power Meas. License Digital Systems v03r01
- ♦ FCC KDB 971168 D02 Misc Rev Approv License Devices v02r01

### **Remark:**

1. All test items were verified and recorded according to the standards and without any deviation during the test.
2. This EUT has also been tested and complied with the requirements of FCC Part 15, Subpart B, recorded in a separate test report.



## 2 Test Configuration of Equipment Under Test

### 2.1 Test Mode

During all testing, EUT is in link mode with base station emulator at maximum power level. The spurious emission measurements were carried out in semi-anechoic chamber with 3-meter test range, and EUT is rotated on three test planes to find out the worst emission.

Frequency range investigated for radiated emission is 30 MHz to 9000 MHz. (Y Plane)

Test Items	Band	Bandwidth (MHz)						Modulation				RB #			Test Channel		
		1.4	3	5	10	15	20	QPSK	16 QAM	64 QAM	256 QAM	1	Half	Full	L	M	H
Max. Output Power	26	v	v	v	v	v	-	v	v	v	-	v	v	v	v	v	v
26dB and 99% Bandwidth	26	v	v	v	v	v	-	v	v					v		v	v
Emission masks In-band emissions	26	v	v	v	v	v	-	v	v	v			v		v		v
Emission masks – Out of band emissions	26	v	v	v	v	v	-	v					v			v	v
Frequency Stability	26				v		-	v							v		v
						v		v						v	v		
Radiated Spurious Emission	26				v		-	v					v				v
						v		v					v				
Note	<ol style="list-style-type: none"> <li>The mark “v ” means that this configuration is chosen for testing</li> <li>The mark “-“ means that this bandwidth is not supported.</li> <li>LTE Band26 transmit frequency for part22 rule is 824MHz-849MHz, for part90 rule is 814MHz-824MHz. ERP over 15MHz bandwidth complies the ERP limit line of part22 rule, therefore ERP of the partial frequency spectrum which falls within part 22 also complies.</li> <li>For QAM modulation mode, the whole testing has assessed 16QAM&amp;64QAM mode by referring to the higher conducted power.</li> </ol>																



## 2.2 Connection Diagram of Test System

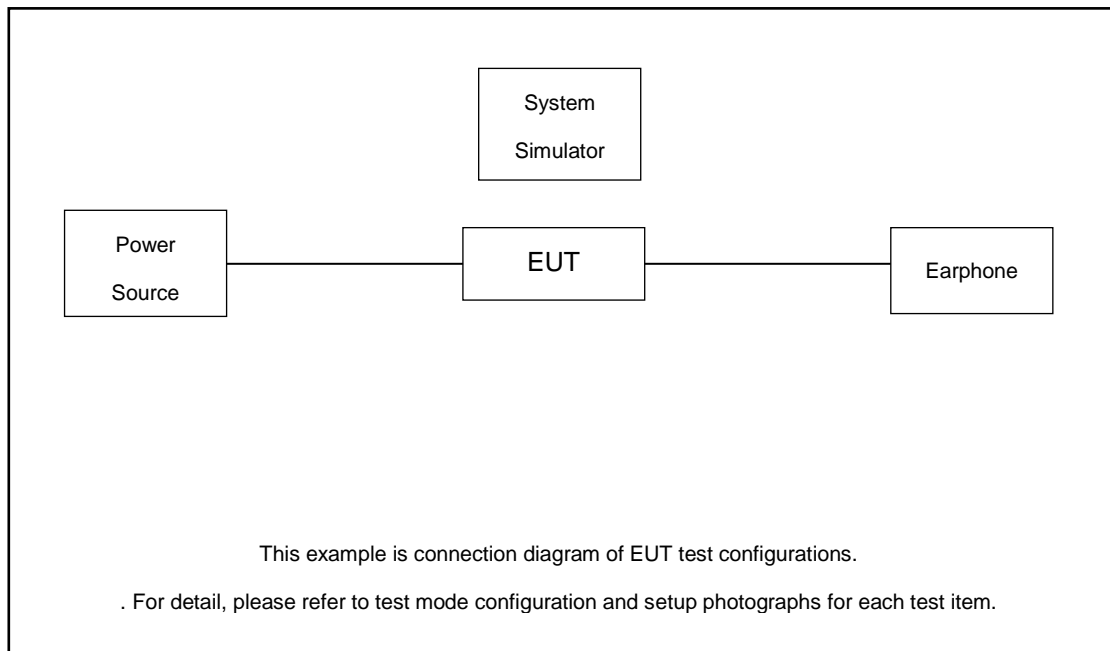

## 2.3 Support Unit used in test configuration and system

Item	Equipment	Trade Name	Model No.	FCC ID	Data Cable	Power Cord
1.	System Simulator	Anritsu	MT8820C	N/A	N/A	Unshielded, 1.8 m

## 2.4 Measurement Results Explanation Example

**For all conducted test items:**

The offset level is set in the spectrum analyzer to compensate the RF cable loss and attenuator factor between RF conducted output port and spectrum analyzer. With the offset compensation, the spectrum analyzer reading level will be exactly the RF output level.

The spectrum analyzer offset is derived from RF cable loss and attenuator factor.

*Offset = RF cable loss + attenuator factor.*

The following shows an offset computation example with RF cable loss 4.0 dB and a 10dB attenuator.

Example :

$$\begin{aligned} \text{Offset(dB)} &= \text{RF cable loss(dB)} + \text{attenuator factor(dB)}. \\ &= 4.0 + 10 = 14.0 \text{ (dB)} \end{aligned}$$



### 2.5 Frequency List of Low/Middle/High Channels

LTE Band 26 Channel and Frequency List				
BW [MHz]	Channel/Frequency(MHz)	Lowest	Middle	Highest
10	Channel	-	26740	-
	Frequency	-	819	-
5	Channel	26715	26740	26765
	Frequency	816.5	819	821.5
3	Channel	26705	26740	26775
	Frequency	815.5	819	822.5
1.4	Channel	26697	26740	26783
	Frequency	814.7	819	823.3

LTE Band 26 Cross-rule Channel and Frequency List				
BW [MHz]	Channel/Frequency(MHz)	-	Middle	-
15	Channel	-	26790	-
	Frequency	-	824	-
10	Channel	-	26790	-
	Frequency	-	824	-
5	Channel	-	26790	-
	Frequency	-	824	-
3	Channel	-	26790	-
	Frequency	-	824	-
1.4	Channel	-	26790	-
	Frequency	-	824	-

### 3 Test Result

#### 3.1 Conducted Output Power Measurement

##### 3.1.1 Description of the Conducted Output Power Measurement

A system simulator was used to establish communication with the EUT. Its parameters were set to enforce EUT transmitting at the maximum power. The measured power in the radio frequency on the transmitter output terminals shall be reported.

##### 3.1.2 Measuring Instruments

The measuring equipment is listed in the section 4 of this test report.

##### 3.1.3 Test Procedures

1. The transmitter output port was connected to the system simulator.
2. Set EUT at maximum power through the system simulator.
3. Select lowest, middle, and highest channels for each band and different modulation.
4. Measure and record the power level from the system simulator.

##### 3.1.4 Test Setup



##### 3.1.5 Test Result of Conducted Output Power

Please refer to Appendix A.

## 3.2 99% Occupied Bandwidth and 26dB Bandwidth Measurement

### 3.2.1 Description of (Occupied) Bandwidth Limitations Measurement

The 99% occupied bandwidth is the width of a frequency band such that, below the lower and above the upper frequency limits, the mean powers emitted are each equal to a specified percentage 0.5% of the total mean transmitted power.

The emission bandwidth is defined as the width of the signal between two points, located at the 2 sides of the carrier frequency, outside of which all emissions are attenuated at least 26 dB below the transmitter power.

### 3.2.2 Measuring Instruments

The measuring equipment is listed in the section 4 of this test report.

### 3.2.3 Test Procedures

1. The EUT was connected to spectrum analyzer and system simulator via a power divider.
2. The 26dB and 99% occupied bandwidth (BW) of the middle channel for the highest RF power with full RB sizes were measured.

### 3.2.4 Test Setup

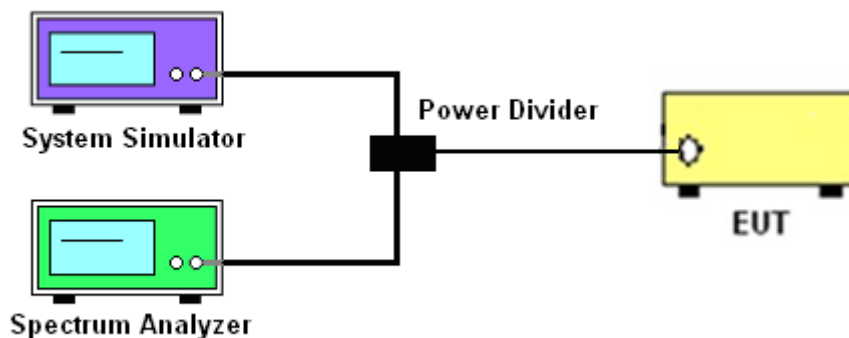

### 3.2.5 Test Result of 99% Occupied Bandwidth and 26dB Bandwidth

Please refer to Appendix A.



### 3.3 Emissions Mask Measurement

#### 3.3.1 Description of Emissions Mask Measurement

Equipment used in this licensed to EA or non-EA systems shall comply with the emission mask provisions of FCC Part 90.691.(a):

(a) Out-of-band emission requirement shall apply only to the “outer” channels included in an EA license and to spectrum adjacent to interior channels used by incumbent licensees. The emission limits are as follows:

(1) For any frequency removed from the EA licensee's frequency block by up to and including 37.5 kHz, the power of any emission shall be attenuated below the transmitter power (P) in watts by at least  $116 \text{ Log}_{10}(f/6.1)$  decibels or  $50 + 10 \text{ Log}_{10}(P)$  decibels or 80 decibels, whichever is the lesser attenuation, where f is the frequency removed from the center of the outer channel in the block in kilohertz and where f is greater than 12.5 kHz.

(2) For any frequency removed from the EA licensee's frequency block greater than 37.5 kHz, the power of any emission shall be attenuated below the transmitter power (P) in watts by at least  $43 + 10 \text{ Log}_{10}(P)$  decibels or 80 decibels, whichever is the lesser attenuation, where f is the frequency removed from the center of the outer channel in the block in kilohertz and where f is greater than 37.5 kHz.

#### 3.3.2 Measuring Instruments

The measuring equipment is listed in the section 4 of this test report.

#### 3.3.3 Test Procedures

1. The EUT was connected to spectrum analyzer and base station via power divider.
2. The emissions mask of low and high channels for the highest RF powers were measured.
3. The measured RBW and the VBW set 3 times of RBW are then set in spectrum analyzer, and the RBW correction factor  $10 \text{ log} (1\% \text{ of OBW/measured RBW})(\text{dB})$  was compensated, if required.
4. The test results were shown below plots with a correction offset factor including cable loss, insertion loss of power divider.

### 3.3.4 Test Setup

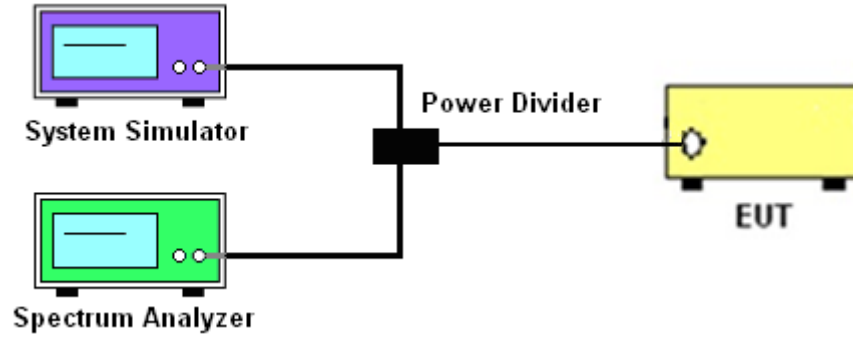

### 3.3.5 Test Result (Plots) of Conducted Emissions Mask

Please refer to Appendix A.

### 3.4 Emissions Mask – Out Of Band Emissions Measurement

#### 3.4.1 Description of Conducted Emissions Out of band emissions measurement

The power of any emission FCC Part 90.691 (a)(2) on any frequency removed from the assigned frequency by out of the authorized bandwidth at least  $43 + 10 \log (P)$  dB. It is measured by means of a calibrated spectrum analyzer and scanned from 30 MHz up to a frequency including its 10<sup>th</sup> harmonic.

#### 3.4.2 Measuring Instruments

The measuring equipment is listed in the section 4 of this test report.

#### 3.4.3 Test Procedures

1. The EUT was connected to spectrum analyzer and system simulator via a power divider.
2. The RF output of EUT was connected to the spectrum analyzer by RF cable and attenuator. The path loss was compensated to the results for each measurement.
3. The middle channel for the highest RF power within the transmitting frequency was measured.
4. The conducted spurious emission for the whole frequency range was taken.
5. Make the measurement with the spectrum analyzer's RBW = 1MHz, VBW = 3MHz, taking the record of maximum spurious emission.
6. The RF fundamental frequency should be excluded against the limit line in the operating frequency band.
7. The limit line is derived from  $43 + 10\log(P)$ dB below the transmitter power P(Watts)

#### 3.4.4 Test Setup

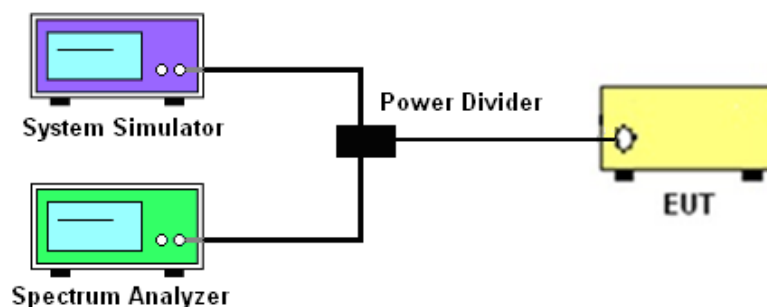

#### 3.4.5 Test Result (Plots) of Conducted Emission

Please refer to Appendix A.



### 3.5 Field Strength of Spurious Radiation Measurement

#### 3.5.1 Description of Field Strength of Spurious Radiated Measurement

The radiated spurious emission was measured by substitution method according to ANSI/TIA-603-E. The power of any emission FCC Part 90.691 on any frequency removed from the assigned frequency by more than 250 percent of the authorized bandwidth at least  $43 + 10 \log (P)$  dB. The spectrum is scanned from 30 MHz up to a frequency including its 10th harmonic.

The power of any emission outside of the authorized operating frequency ranges must be attenuated below the transmitter power (P) by a factor of at least  $43+10\log_{10}(P[\text{Watts}])$  dB. The spectrum is scanned from 30 MHz up to a frequency including its 10th harmonic.

#### 3.5.2 Measuring Instruments

The measuring equipment is listed in the section 4 of this test report.

#### 3.5.3 Test Procedures

1. The EUT was placed on a turntable with 0.8 meter for frequency below 1GHz and 1.5 meter for frequency above 1GHz respectively above ground.
2. The EUT was set 3 meters from the receiving antenna, which was mounted on the antenna tower.
3. The table was rotated 360 degrees to determine the position of the highest spurious emission.
4. The height of the receiving antenna is varied between one meter and four meters to search the maximum spurious emission for both horizontal and vertical polarizations.
5. Make the measurement with the spectrum analyzer's RBW = 1MHz, VBW = 3MHz, Sweep = 500ms, Taking the record of maximum spurious emission.
6. A horn antenna was substituted in place of the EUT and was driven by a signal generator.
7. Tune the output power of signal generator to the same emission level with EUT maximum spurious emission.
8. Taking the record of output power at antenna port.
9. Repeat step 7 to step 8 for another polarization.
10.  $EIRP \text{ (dBm)} = S.G. \text{ Power} - Tx \text{ Cable Loss} + Tx \text{ Antenna Gain}$
11.  $ERP \text{ (dBm)} = EIRP - 2.15$
12. The RF fundamental frequency should be excluded against the limit line in the operating frequency band.
13. The limit line is derived from  $43 + 10\log(P)$  dB below the transmitter power P(Watts)



### 3.5.4 Test Setup

For radiated test from 30MHz

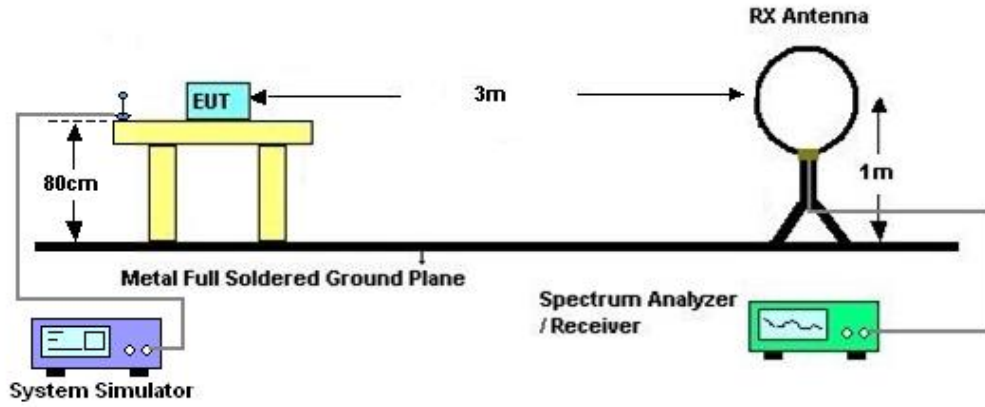

For radiated test from 30MHz to 1GHz

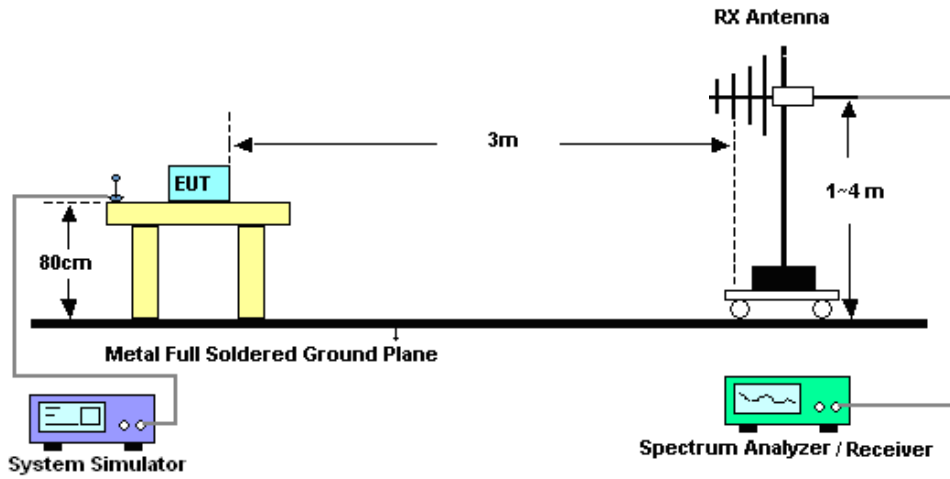

For radiated test above 1GHz



### 3.5.5 Test Result of Field Strength of Spurious Radiated

The low frequency, which started from 9 kHz to 30MHz, was pre-scanned and the result which was 20dB lower than the limit line was not reported.

Please refer to Appendix B.

## 3.6 Frequency Stability Measurement

### 3.6.1 Description of Frequency Stability Measurement

The frequency stability shall be measured by variation of ambient temperature and variation of primary supply voltage to ensure that the fundamental emission stays within the authorized frequency block. The frequency stability of the transmitter shall be maintained within  $\pm 0.00025\%$  ( $\pm 2.5\text{ppm}$ ) of the center frequency according to FCC Part 90.213.

### 3.6.2 Measuring Instruments

The measuring equipment is listed in the section 4 of this test report.

### 3.6.3 Test Procedures for Temperature Variation

1. The EUT was set up in the thermal chamber and connected with the base station.
2. With power OFF, the temperature was decreased to  $-30^{\circ}\text{C}$  and the EUT was stabilized for three hours. Power was applied and the maximum change in frequency was recorded within one minute.
3. With power OFF, the temperature was raised in  $10^{\circ}\text{C}$  step up to  $50^{\circ}\text{C}$ . The EUT was stabilized at each step for at least half an hour. Power was applied and the maximum frequency change was recorded within one minute.

### 3.6.4 Test Procedures for Voltage Variation

1. The EUT was placed in a temperature chamber at  $20\pm 5^{\circ}\text{C}$  and connected with the system simulator.
2. The power supply voltage to the EUT was varied from 85% to 115% of the nominal value for other than hand carried battery equipment.
3. For hand carried, battery powered equipment, reduce the primary ac or dc supply voltage to the
4. battery operating end point, which shall be specified by the manufacturer.
5. The variation in frequency was measured for the worst case.

### 3.6.5 Test Setup



### 3.6.6 Test Result of Temperature Variation

Please refer to Appendix A.



## 4 List of Measuring Equipment

Instrument	Manufacturer	Model No.	Serial No.	Characteristics	Calibration Date	Test Date	Due Date	Remark
Spectrum Analyzer	R&S	FSV40	101078	10Hz~40GHz	Apr. 06, 2023	Dec. 28, 2023	Apr. 05, 2024	Conducted (TH01-SZ)
DC Power Supply	TTI	PL330P	290070	Max 32V , 3A	Oct. 16, 2023	Dec. 28, 2023	Oct. 15, 2024	Conducted (TH01-SZ)
Power Divider	TOJOIN	PS-2SM-04 265	60.06.020.0 077	0.4GHz~26.5G Hz	Dec. 24, 2023	Dec. 28, 2023	Dec. 23, 2024	Conducted (TH01-SZ)
Thermal Chamber	Ten Billion Hongzhangrou P	LP-150U	H201408180 3	-40~+150°C	Jul. 05, 2023	Dec. 28, 2023	Jul. 04, 2024	Conducted (TH01-SZ)
EMI Test Receiver&SA	Agilent	N9038A	MY5226018 5	20Hz~26.5GHz	Dec. 25, 2023	Jan. 08, 2024	Dec. 24, 2024	Radiation (03CH01-SZ)
Loop Antenna	R&S	HFH2-Z2	100354	9kHz~30MHz	Jul. 28, 2022	Jan. 08, 2024	Jul. 27, 2024	Radiation (03CH01-SZ)
Bilog Antenna	TeseQ	CBL6112D	35407	30MHz~2GHz	Oct. 24, 2023	Jan. 08, 2024	Oct. 23, 2025	Radiation (03CH01-SZ)
Double Ridge Horn Antenna	ETS-Lindgren	3117	00119436	1GHz~18GHz	Jul. 08, 2023	Jan. 08, 2024	Jul. 07, 2024	Radiation (03CH01-SZ)
SHF-EHF Horn	com-power	AH-840	101071	18Ghz~40GHz	Apr. 08, 2023	Jan. 08, 2024	Apr. 07, 2024	Radiation (03CH01-SZ)
LF Amplifier	Burgeon	BPA-530	102209	0.01~3000Mhz	Apr. 04, 2023	Jan. 08, 2024	Apr. 03, 2024	Radiation (03CH01-SZ)
HF Amplifier	MITEQ	AMF-7D-00 101800-30- 10P-R	1943528	1GHz~18GHz	Oct. 18, 2023	Jan. 08, 2024	Oct. 17, 2024	Radiation (03CH01-SZ)
HF Amplifier	KEYSIGHT	83017A	MY5327010 5	0.5GHz~26.5Gh z	Oct. 18, 2023	Jan. 08, 2024	Oct. 17, 2024	Radiation (03CH01-SZ)
HF Amplifier	MITEQ	TTA1840-35 -HG	1871923	18GHz~40GHz	Jul. 07, 2023	Jan. 08, 2024	Jul. 06, 2024	Radiation (03CH01-SZ)
AC Power Source	Chroma	61601	6160100019 85	N/A	Oct. 18, 2023	Jan. 08, 2024	Oct. 17, 2024	Radiation (03CH01-SZ)
Turn Table	EM	EM1000	N/A	0~360 degree	NCR	Jan. 08, 2024	NCR	Radiation (03CH01-SZ)
Antenna Mast	EM	EM1000	N/A	1 m~4 m	NCR	Jan. 08, 2024	NCR	Radiation (03CH01-SZ)

NCR: No Calibration Required



## 5 Measurement Uncertainty

The measurement uncertainties shown below were calculated in accordance with the requirements of ANSI 63.26-2015. All the measurement uncertainty value were shown with a coverage K=2 to indicate 95% level of confidence. The measurement data show herein meets or exceeds the CISPR measurement uncertainty values specified in CISPR 16-4-2 and can be compared directly to specified limit to determine compliance.

### Uncertainty of Conducted Measurement

Test Item	Uncertainty
Conducted Spurious Emission & Bandedge	±1.34 dB
Occupied Channel Bandwidth	±0.012 MHz
Conducted Power	±1.34 dB
Peak to Average Ratio	±1.34 dB
Frequency Stability	±1.3 Hz

### Uncertainty of Radiated Emission Measurement (9 KHz ~ 30 MHz)

Measuring Uncertainty for a Level of Confidence of 95% (U = 2Uc(y))	2.48
---------------------------------------------------------------------	------

### Uncertainty of Radiated Emission Measurement (30 MHz ~ 1000 MHz)

Measuring Uncertainty for a Level of Confidence of 95% (U = 2Uc(y))	3.53
---------------------------------------------------------------------	------

### Uncertainty of Radiated Emission Measurement (1 GHz ~ 40 GHz)

Measuring Uncertainty for a Level of Confidence of 95% (U = 2Uc(y))	4.02
---------------------------------------------------------------------	------

----- THE END -----



### Appendix A. Test Results of Conducted Test

Test Engineer :	Hank Lin	Temperature :	24~26°C
		Relative Humidity :	50~53%

### Conducted Output Power (Average power)

<LTE Band 26\_Part 90S\_Ant.1>

BW [MHz]	Modulation	RB Size	RB Offset	Power Low Ch. / Freq.	Power Middle Ch. / Freq.	Power High Ch. / Freq.
Channel				26790		
Frequency (MHz)				824		
15	QPSK	1	0	22.96		
15	QPSK	1	37	23.05		
15	QPSK	1	74	22.93		
15	QPSK	36	0	21.92		
15	QPSK	36	20	21.95		
15	QPSK	36	39	21.94		
15	QPSK	75	0	21.92		
15	16QAM	1	0	21.90		
15	16QAM	1	37	22.02		
15	16QAM	1	74	21.87		
15	16QAM	36	0	20.58		
15	16QAM	36	20	20.60		
15	16QAM	36	39	20.62		
15	16QAM	75	0	20.63		
15	64QAM	1	0	20.81		
15	64QAM	1	37	20.91		
15	64QAM	1	74	20.79		
15	64QAM	36	0	19.59		
15	64QAM	36	20	19.61		
15	64QAM	36	39	19.66		
15	64QAM	75	0	19.63		
Channel					26740	
Frequency (MHz)					819	
10	QPSK	1	0		22.57	
10	QPSK	1	25		22.70	
10	QPSK	1	49		22.57	
10	QPSK	25	0		21.66	
10	QPSK	25	12		21.63	
10	QPSK	25	25		21.63	
10	QPSK	50	0		21.63	
10	16QAM	1	0		21.87	



10	16QAM	1	25		21.93	
10	16QAM	1	49		21.86	
10	16QAM	25	0		20.65	
10	16QAM	25	12		20.61	
10	16QAM	25	25		20.62	
10	16QAM	50	0		20.62	
10	64QAM	1	0		20.81	
10	64QAM	1	25		20.88	
10	64QAM	1	49		20.77	
10	64QAM	25	0		19.62	
10	64QAM	25	12		19.59	
10	64QAM	25	25		19.61	
10	64QAM	50	0		19.61	
Channel				26715	26740	26765
Frequency (MHz)				816.5	819	821.5
5	QPSK	1	0	22.63	22.56	22.58
5	QPSK	1	12	22.66	22.69	22.58
5	QPSK	1	24	22.58	22.61	22.58
5	QPSK	12	0	21.63	21.63	21.62
5	QPSK	12	7	21.63	21.61	21.58
5	QPSK	12	13	21.62	21.63	21.53
5	QPSK	25	0	21.66	21.66	21.64
5	16QAM	1	0	21.85	21.80	21.88
5	16QAM	1	12	21.91	21.90	21.84
5	16QAM	1	24	21.87	21.89	21.84
5	16QAM	12	0	20.63	20.63	20.62
5	16QAM	12	7	20.62	20.62	20.60
5	16QAM	12	13	20.63	20.63	20.55
5	16QAM	25	0	20.66	20.64	20.61
5	64QAM	1	0	20.75	20.73	20.78
5	64QAM	1	12	20.78	20.83	20.79
5	64QAM	1	24	20.80	20.79	20.76
5	64QAM	12	0	19.67	19.66	19.64
5	64QAM	12	7	19.64	19.68	19.61
5	64QAM	12	13	19.65	19.63	19.56
5	64QAM	25	0	19.64	19.62	19.58
Channel				26705	26740	26775
Frequency (MHz)				815.5	819	822.5
3	QPSK	1	0	22.56	22.54	22.52
3	QPSK	1	8	22.54	22.62	22.44
3	QPSK	1	14	22.53	22.61	22.54
3	QPSK	8	0	21.57	21.57	21.56
3	QPSK	8	4	21.57	21.60	21.54
3	QPSK	8	7	21.60	21.60	21.53
3	QPSK	15	0	21.57	21.59	21.53
3	16QAM	1	0	21.79	21.86	21.77
3	16QAM	1	8	21.77	21.80	21.73





3	16QAM	1	14	21.78	21.83	21.74
3	16QAM	8	0	20.61	20.62	20.60
3	16QAM	8	4	20.63	20.63	20.58
3	16QAM	8	7	20.64	20.63	20.55
3	16QAM	15	0	20.61	20.63	20.56
3	64QAM	1	0	20.70	20.69	20.69
3	64QAM	1	8	20.67	20.72	20.66
3	64QAM	1	14	20.69	20.76	20.68
3	64QAM	8	0	19.61	19.64	19.60
3	64QAM	8	4	19.62	19.63	19.57
3	64QAM	8	7	19.61	19.64	19.55
3	64QAM	15	0	19.58	19.60	19.53
Channel				26697	26740	26783
Frequency (MHz)				814.7	819	823.3
1.4	QPSK	1	0	22.64	22.68	22.54
1.4	QPSK	1	3	22.61	22.62	22.55
1.4	QPSK	1	5	22.60	22.63	22.51
1.4	QPSK	3	0	22.58	22.58	22.56
1.4	QPSK	3	1	22.57	22.57	22.52
1.4	QPSK	3	3	22.65	22.59	22.55
1.4	QPSK	6	0	21.60	21.62	21.55
1.4	16QAM	1	0	21.84	21.85	21.74
1.4	16QAM	1	3	21.87	21.80	21.77
1.4	16QAM	1	5	21.86	21.82	21.80
1.4	16QAM	3	0	21.58	21.60	21.51
1.4	16QAM	3	1	21.58	21.59	21.50
1.4	16QAM	3	3	21.57	21.59	21.48
1.4	16QAM	6	0	20.66	20.68	20.62
1.4	64QAM	1	0	20.76	20.81	20.66
1.4	64QAM	1	3	20.74	20.72	20.65
1.4	64QAM	1	5	20.75	20.75	20.68
1.4	64QAM	3	0	20.69	20.71	20.66
1.4	64QAM	3	1	20.68	20.68	20.61
1.4	64QAM	3	3	20.73	20.66	20.64
1.4	64QAM	6	0	19.58	19.60	19.49



# LTE Band 26\_Part 90S

## 26dB Bandwidth

Mode	LTE Band 26 : 26dB BW(MHz)											
	1.4MHz		3MHz		5MHz		10MHz		15MHz		-	
BW	1.4MHz	16QAM	3MHz	16QAM	5MHz	16QAM	10MHz	16QAM	15MHz	16QAM	-	-
Mod.	QPSK	16QAM	QPSK	16QAM	QPSK	16QAM	QPSK	16QAM	QPSK	16QAM	-	-
Middle CH	1.28	1.27	2.96	3.02	4.92	4.92	9.67	9.97	-	-	-	-
High CH	-	-	-	-	-	-	-	-	14.33	14.63	-	-

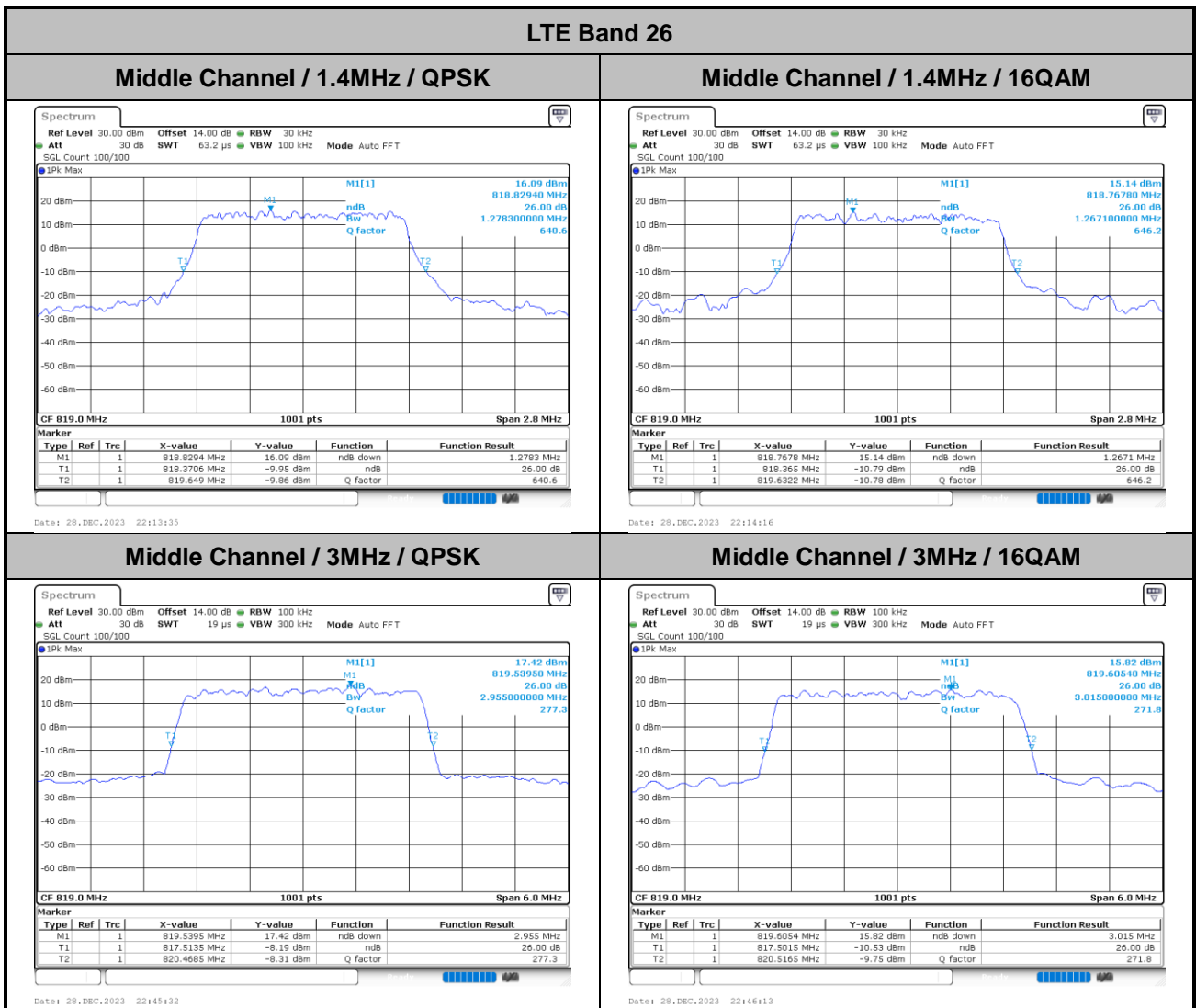



Middle Channel / 5MHz / QPSK

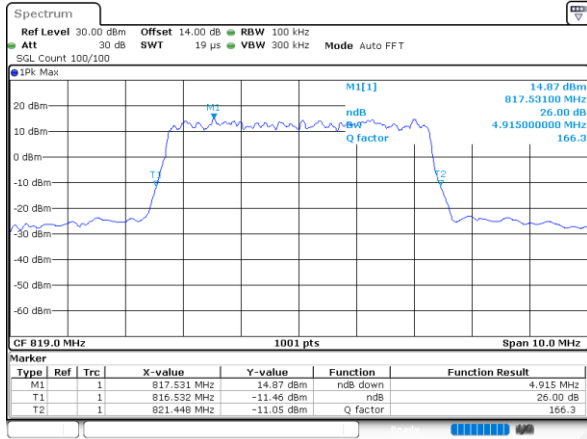

Date: 28, DEC, 2023 23:05:46

Middle Channel / 5MHz / 16QAM

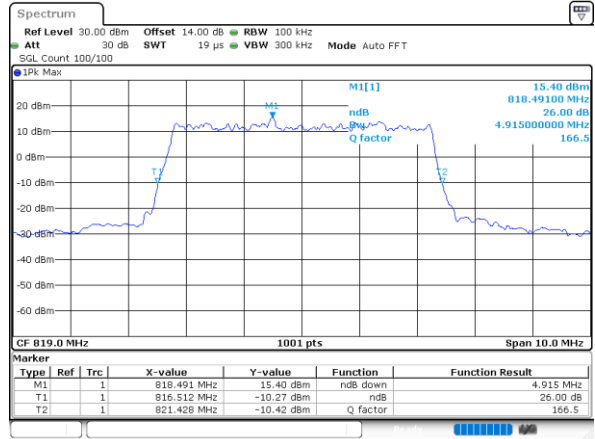

Date: 28, DEC, 2023 23:06:27

LTE Band 26

Middle Channel / 10MHz / QPSK

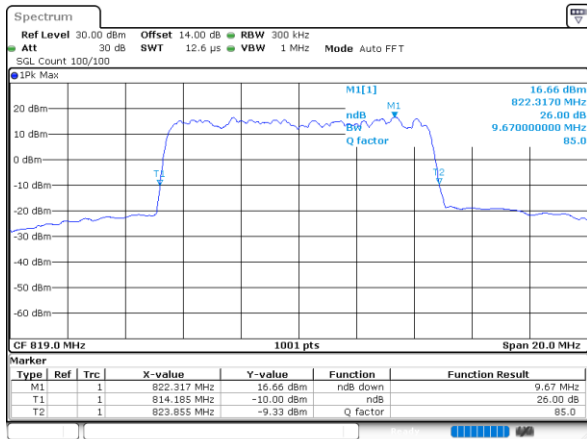

Date: 28, DEC, 2023 23:27:18

Middle Channel / 10MHz / 16QAM

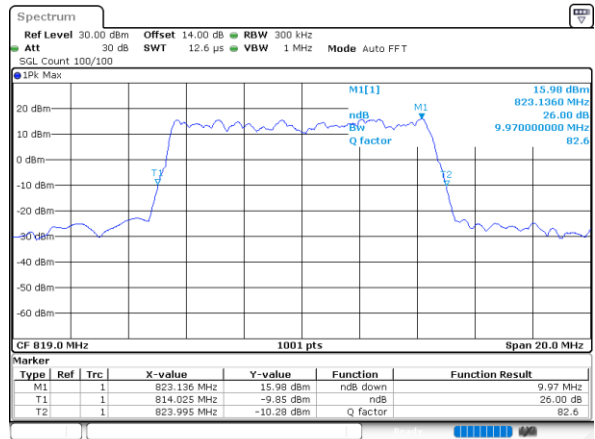

Date: 28, DEC, 2023 23:27:59

High Channel / 15MHz / QPSK

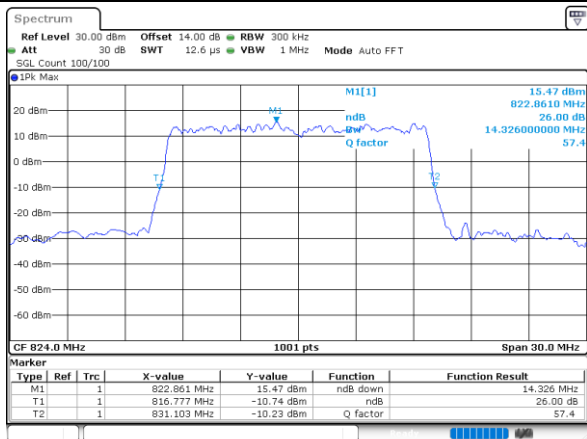

Date: 28, DEC, 2023 23:55:00

High Channel / 15MHz / 16QAM

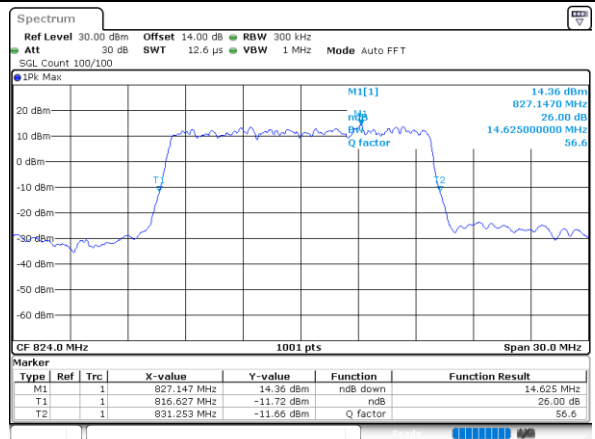

Date: 28, DEC, 2023 23:55:27



# Occupied Bandwidth

Mode	LTE Band 26 : 99%OBW(MHz)											
	1.4MHz		3MHz		5MHz		10MHz		15MHz		-	
Mod.	QPSK	16QAM	QPSK	16QAM	QPSK	16QAM	QPSK	16QAM	QPSK	16QAM	-	-
Middle CH	1.09	1.08	2.72	2.73	4.48	4.50	9.03	9.03	-	-	-	-
high CH	-	-	-	-	-	-	-	-	13.43	13.43	-	-

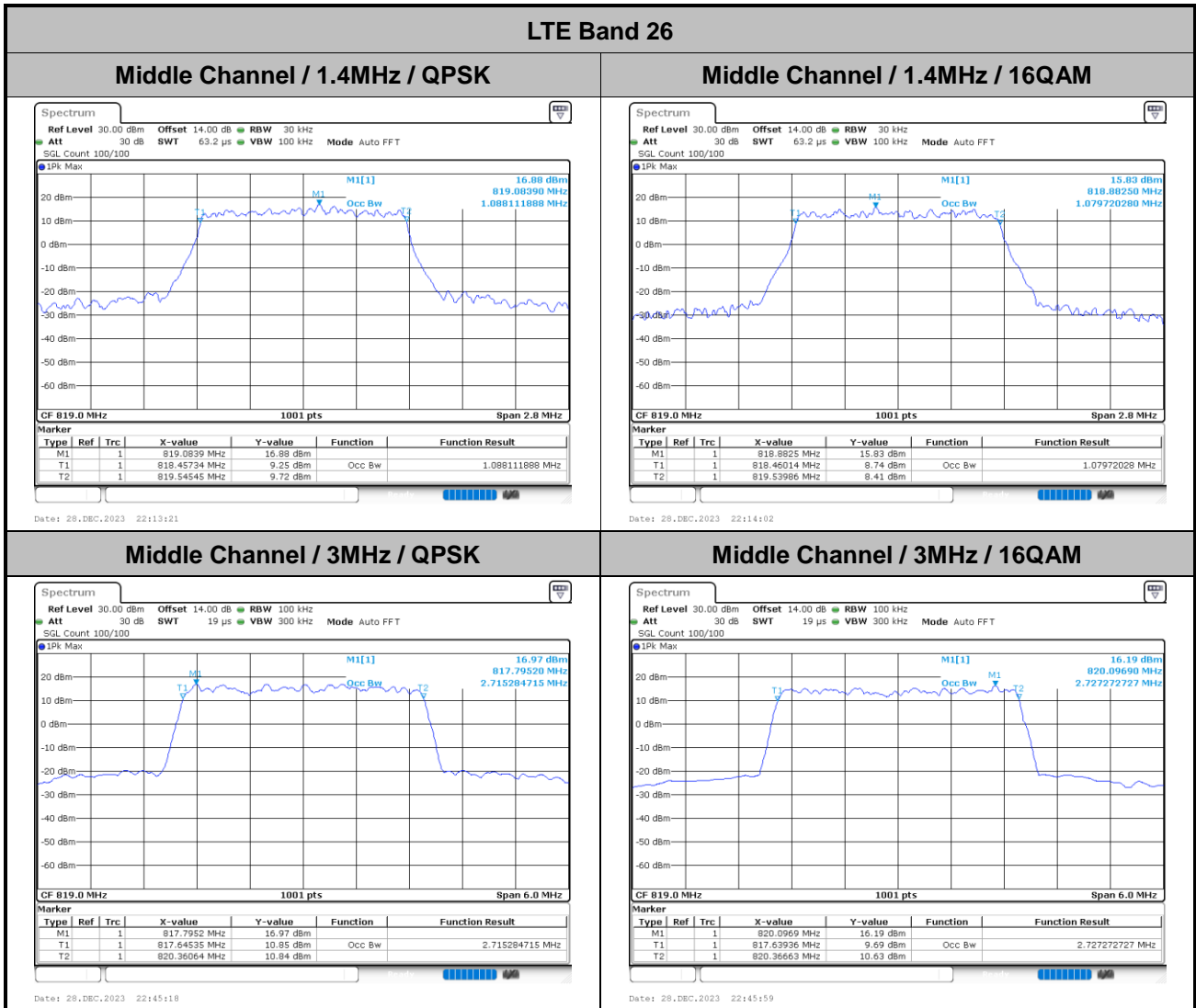



Middle Channel / 5MHz / QPSK

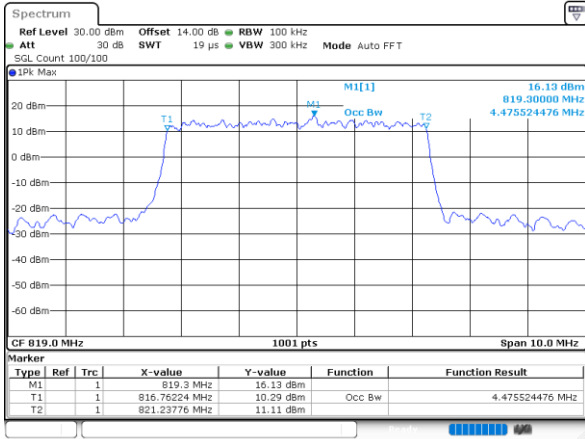

Date: 28, DEC, 2023 23:05:32

Middle Channel / 5MHz / 16QAM

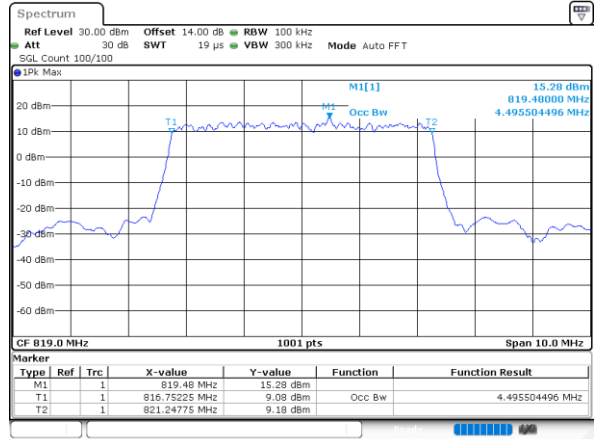

Date: 28, DEC, 2023 23:06:12

LTE Band 26

Middle Channel / 10MHz / QPSK

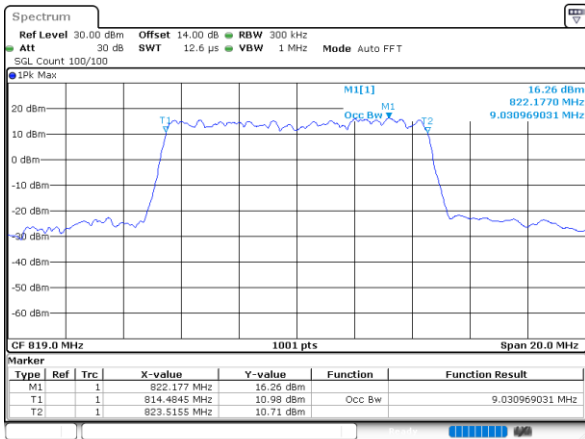

Date: 28, DEC, 2023 23:27:04

Middle Channel / 10MHz / 16QAM

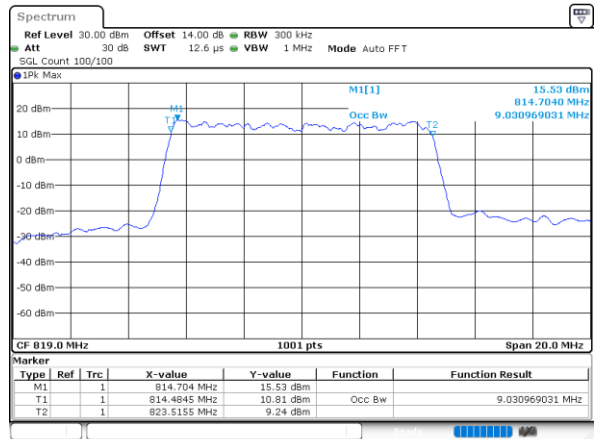

Date: 28, DEC, 2023 23:27:45

High Channel / 15MHz / QPSK

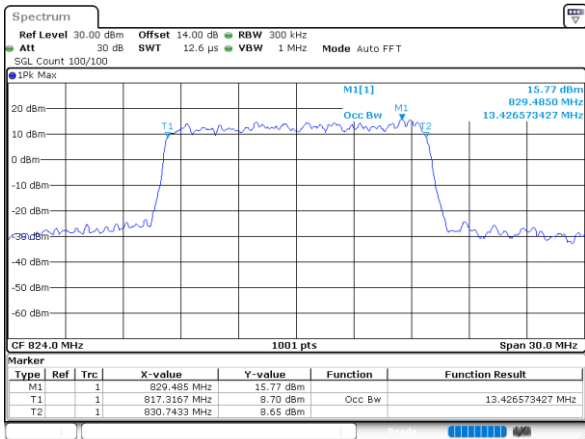

Date: 28, DEC, 2023 23:54:46

High Channel / 15MHz / 16QAM

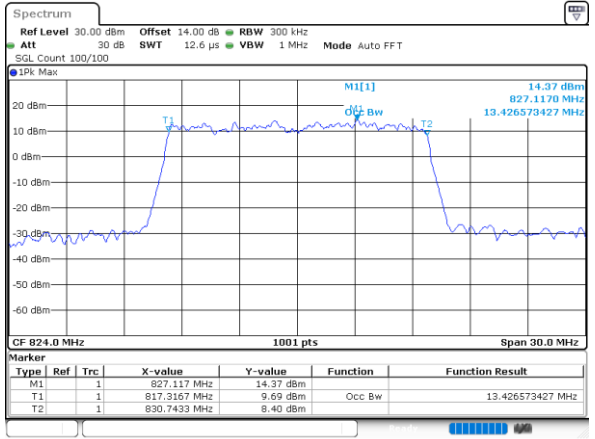

Date: 28, DEC, 2023 23:55:41



# Emission masks – In-band emissions

## LTE Band 26 / 1.4MHz / QPSK

### Lowest Band Edge / 1RB

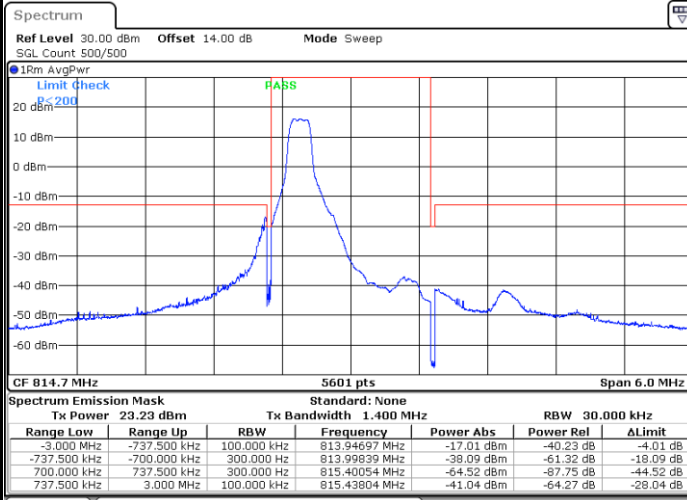

Date: 28.DEC.2023 23:33:58

### Highest Band Edge / 1RB

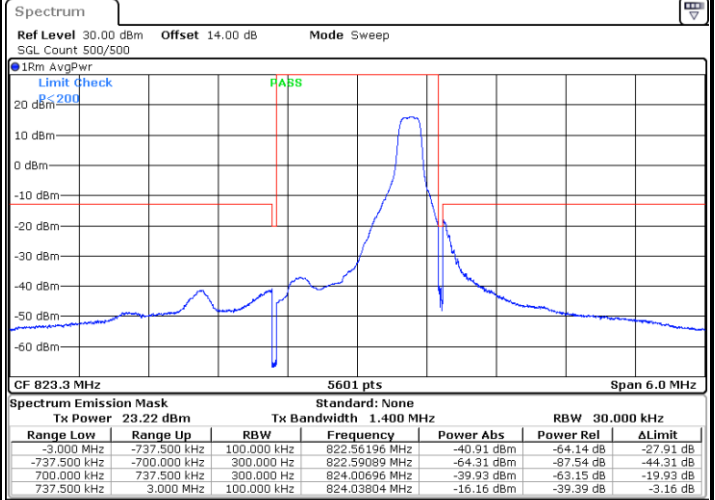

Date: 28.DEC.2023 23:35:59

### Lowest Band Edge / Full RB

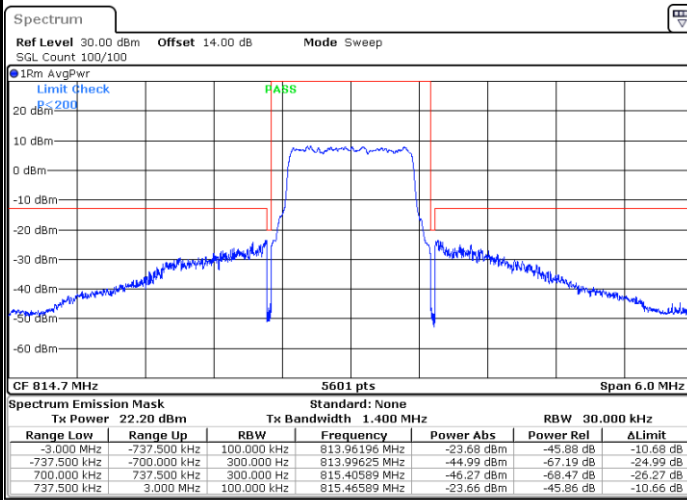

Date: 28.DEC.2023 22:10:28

### Highest Band Edge / Full RB

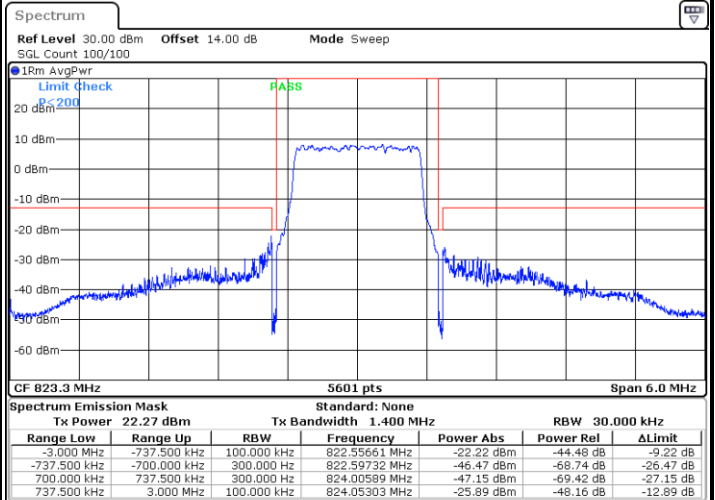

Date: 28.DEC.2023 22:20:20



LTE Band 26 / 1.4MHz / 16QAM

Lowest Band Edge / 1 RB

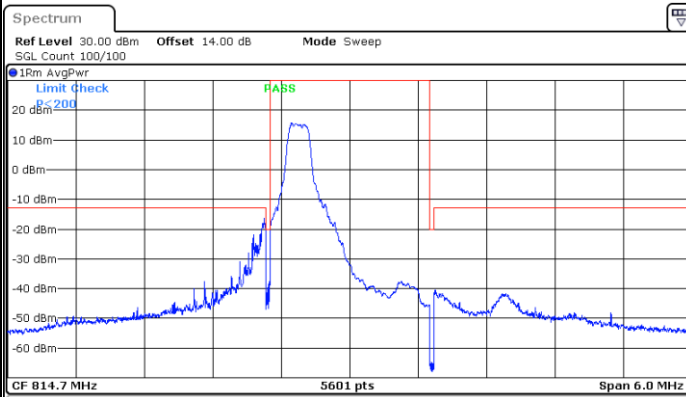

Spectrum Emission Mask		Standard: None		Tx Bandwidth 1.400 MHz		RBW 30.000 kHz	
Range Low	Range Up	RBW	Frequency	Power Abs	Power Rel	ΔLimit	
-3.000 MHz	-737.500 kHz	100.000 kHz	813.94804 MHz	-16.35 dBm	-38.88 dB	-3.35 dB	
-737.500 kHz	-700.000 kHz	300.000 kHz	813.99732 MHz	-37.60 dBm	-60.13 dB	-17.60 dB	
700.000 kHz	737.500 kHz	300.000 kHz	815.41125 MHz	-64.80 dBm	-87.33 dB	-44.80 dB	
737.500 kHz	3.000 MHz	100.000 kHz	815.44661 MHz	-40.41 dBm	-62.94 dB	-27.41 dB	

Date: 28.DEC.2023 22:06:23

Highest Band Edge / 1 RB

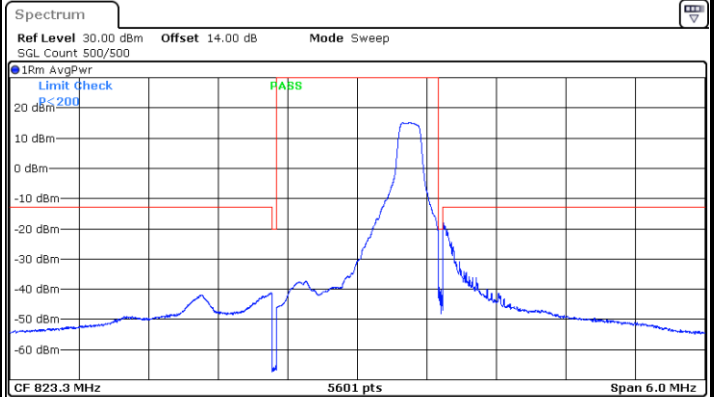

Spectrum Emission Mask		Standard: None		Tx Bandwidth 1.400 MHz		RBW 30.000 kHz	
Range Low	Range Up	RBW	Frequency	Power Abs	Power Rel	ΔLimit	
-3.000 MHz	-737.500 kHz	100.000 kHz	822.55768 MHz	-41.24 dBm	-63.68 dB	-28.24 dB	
-737.500 kHz	-700.000 kHz	300.000 kHz	822.59304 MHz	-65.34 dBm	-87.79 dB	-45.34 dB	
700.000 kHz	737.500 kHz	300.000 kHz	824.00268 MHz	-39.40 dBm	-61.85 dB	-19.40 dB	
737.500 kHz	3.000 MHz	100.000 kHz	824.03804 MHz	-17.20 dBm	-39.65 dB	-4.20 dB	

Date: 28.DEC.2023 23:37:46

Lowest Band Edge / Full RB

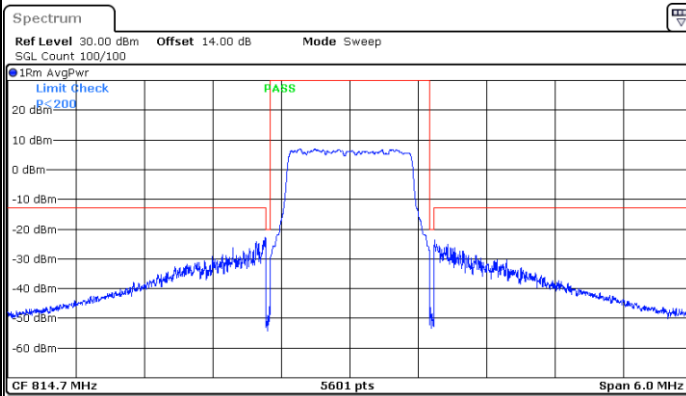

Spectrum Emission Mask		Standard: None		Tx Bandwidth 1.400 MHz		RBW 30.000 kHz	
Range Low	Range Up	RBW	Frequency	Power Abs	Power Rel	ΔLimit	
-3.000 MHz	-737.500 kHz	100.000 kHz	813.95875 MHz	-22.66 dBm	-43.93 dB	-9.66 dB	
-737.500 kHz	-700.000 kHz	300.000 kHz	813.99411 MHz	-46.22 dBm	-67.50 dB	-26.22 dB	
700.000 kHz	737.500 kHz	300.000 kHz	815.40696 MHz	-46.46 dBm	-67.74 dB	-26.46 dB	
737.500 kHz	3.000 MHz	100.000 kHz	815.44232 MHz	-23.55 dBm	-44.82 dB	-10.55 dB	

Date: 28.DEC.2023 22:09:27

Highest Band Edge / Full RB

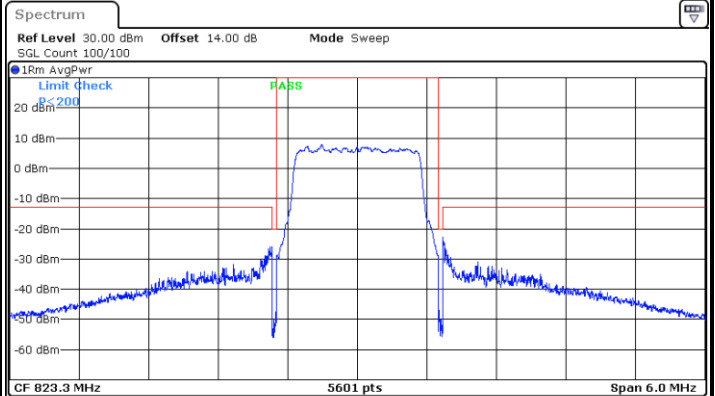

Spectrum Emission Mask		Standard: None		Tx Bandwidth 1.400 MHz		RBW 30.000 kHz	
Range Low	Range Up	RBW	Frequency	Power Abs	Power Rel	ΔLimit	
-3.000 MHz	-737.500 kHz	100.000 kHz	822.56196 MHz	-25.86 dBm	-47.20 dB	-12.86 dB	
-737.500 kHz	-700.000 kHz	300.000 kHz	822.59411 MHz	-47.65 dBm	-68.99 dB	-27.65 dB	
700.000 kHz	737.500 kHz	300.000 kHz	824.00696 MHz	-47.02 dBm	-68.36 dB	-27.02 dB	
737.500 kHz	3.000 MHz	100.000 kHz	824.03804 MHz	-22.82 dBm	-44.15 dB	-9.82 dB	

Date: 28.DEC.2023 22:19:20



LTE Band 26 / 1.4MHz / 64QAM

Lowest Band Edge / 1 RB

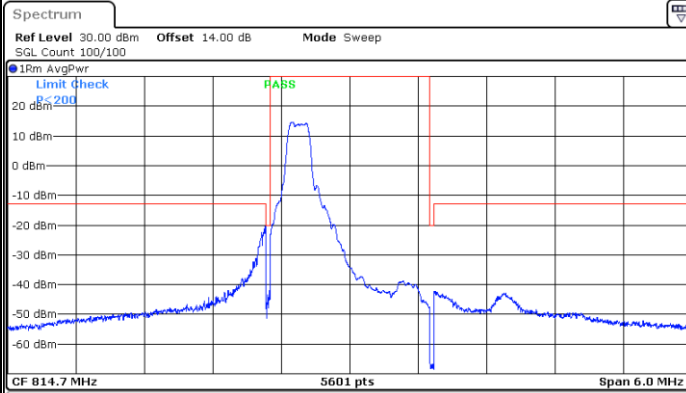

Spectrum Emission Mask		Standard: None		Tx Power 21.56 dBm		Tx Bandwidth 1.400 MHz		RBW 30.000 kHz		Power Abs		Power Rel		ΔLimit	
Range Low	Range Up	RBW	Frequency	Power Abs	Power Rel	ΔLimit	Range Low	Range Up	RBW	Frequency	Power Abs	Power Rel	ΔLimit	Range Low	Range Up
-3.000 MHz	-737.500 kHz	100.000 kHz	813.96196 MHz	-19.35 dBm	-39.91 dB	-5.35 dB	-3.000 MHz	-737.500 kHz	100.000 kHz	813.96196 MHz	-19.35 dBm	-39.91 dB	-5.35 dB	-3.000 MHz	-737.500 kHz
-737.500 kHz	-700.000 kHz	300.000 kHz	813.99732 MHz	-41.89 dBm	-63.45 dB	-21.89 dB	-737.500 kHz	-700.000 kHz	300.000 kHz	813.99732 MHz	-41.89 dBm	-63.45 dB	-21.89 dB	-737.500 kHz	-700.000 kHz
700.000 kHz	737.500 kHz	300.000 kHz	815.40161 MHz	-65.11 dBm	-86.66 dB	-45.11 dB	700.000 kHz	737.500 kHz	300.000 kHz	815.40161 MHz	-65.11 dBm	-86.66 dB	-45.11 dB	700.000 kHz	737.500 kHz
737.500 kHz	3.000 MHz	100.000 kHz	815.43804 MHz	-42.17 dBm	-63.73 dB	-29.17 dB	737.500 kHz	3.000 MHz	100.000 kHz	815.43804 MHz	-42.17 dBm	-63.73 dB	-29.17 dB	737.500 kHz	3.000 MHz

Date: 28.DEC.2023 22:07:25

Highest Band Edge / 1 RB

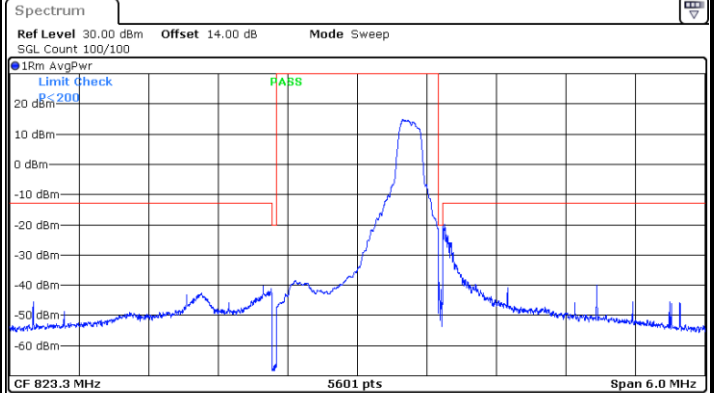

Spectrum Emission Mask		Standard: None		Tx Power 21.40 dBm		Tx Bandwidth 1.400 MHz		RBW 30.000 kHz		Power Abs		Power Rel		ΔLimit	
Range Low	Range Up	RBW	Frequency	Power Abs	Power Rel	ΔLimit	Range Low	Range Up	RBW	Frequency	Power Abs	Power Rel	ΔLimit	Range Low	Range Up
-3.000 MHz	-737.500 kHz	100.000 kHz	822.48805 MHz	-40.30 dBm	-61.70 dB	-27.30 dB	-3.000 MHz	-737.500 kHz	100.000 kHz	822.48805 MHz	-40.30 dBm	-61.70 dB	-27.30 dB	-3.000 MHz	-737.500 kHz
-737.500 kHz	-700.000 kHz	300.000 kHz	822.59304 MHz	-66.20 dBm	-87.60 dB	-46.20 dB	-737.500 kHz	-700.000 kHz	300.000 kHz	822.59304 MHz	-66.20 dBm	-87.60 dB	-46.20 dB	-737.500 kHz	-700.000 kHz
700.000 kHz	737.500 kHz	300.000 kHz	824.00589 MHz	-39.22 dBm	-60.62 dB	-19.22 dB	700.000 kHz	737.500 kHz	300.000 kHz	824.00589 MHz	-39.22 dBm	-60.62 dB	-19.22 dB	700.000 kHz	737.500 kHz
737.500 kHz	3.000 MHz	100.000 kHz	824.03804 MHz	-17.76 dBm	-39.15 dB	-4.76 dB	737.500 kHz	3.000 MHz	100.000 kHz	824.03804 MHz	-17.76 dBm	-39.15 dB	-4.76 dB	737.500 kHz	3.000 MHz

Date: 28.DEC.2023 22:17:18

Lowest Band Edge / Full RB

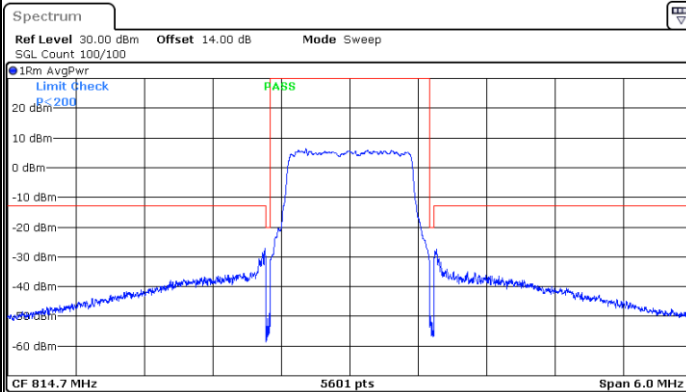

Spectrum Emission Mask		Standard: None		Tx Power 20.23 dBm		Tx Bandwidth 1.400 MHz		RBW 30.000 kHz		Power Abs		Power Rel		ΔLimit	
Range Low	Range Up	RBW	Frequency	Power Abs	Power Rel	ΔLimit	Range Low	Range Up	RBW	Frequency	Power Abs	Power Rel	ΔLimit	Range Low	Range Up
-3.000 MHz	-737.500 kHz	100.000 kHz	813.95447 MHz	-27.16 dBm	-47.39 dB	-14.16 dB	-3.000 MHz	-737.500 kHz	100.000 kHz	813.95447 MHz	-27.16 dBm	-47.39 dB	-14.16 dB	-3.000 MHz	-737.500 kHz
-737.500 kHz	-700.000 kHz	300.000 kHz	813.99518 MHz	-49.11 dBm	-69.34 dB	-29.11 dB	-737.500 kHz	-700.000 kHz	300.000 kHz	813.99518 MHz	-49.11 dBm	-69.34 dB	-29.11 dB	-737.500 kHz	-700.000 kHz
700.000 kHz	737.500 kHz	300.000 kHz	815.40268 MHz	-49.86 dBm	-70.09 dB	-29.86 dB	700.000 kHz	737.500 kHz	300.000 kHz	815.40268 MHz	-49.86 dBm	-70.09 dB	-29.86 dB	700.000 kHz	737.500 kHz
737.500 kHz	3.000 MHz	100.000 kHz	815.46053 MHz	-27.54 dBm	-47.77 dB	-14.54 dB	737.500 kHz	3.000 MHz	100.000 kHz	815.46053 MHz	-27.54 dBm	-47.77 dB	-14.54 dB	737.500 kHz	3.000 MHz

Date: 28.DEC.2023 22:08:26

Highest Band Edge / Full RB

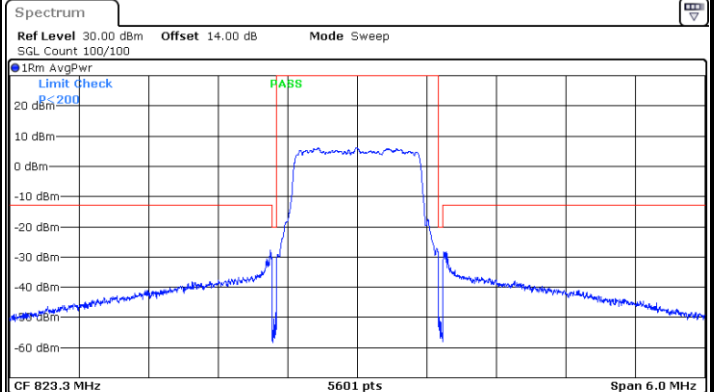

Spectrum Emission Mask		Standard: None		Tx Power 20.15 dBm		Tx Bandwidth 1.400 MHz		RBW 30.000 kHz		Power Abs		Power Rel		ΔLimit	
Range Low	Range Up	RBW	Frequency	Power Abs	Power Rel	ΔLimit	Range Low	Range Up	RBW	Frequency	Power Abs	Power Rel	ΔLimit	Range Low	Range Up
-3.000 MHz	-737.500 kHz	100.000 kHz	822.54804 MHz	-27.79 dBm	-47.94 dB	-14.79 dB	-3.000 MHz	-737.500 kHz	100.000 kHz	822.54804 MHz	-27.79 dBm	-47.94 dB	-14.79 dB	-3.000 MHz	-737.500 kHz
-737.500 kHz	-700.000 kHz	300.000 kHz	822.59519 MHz	-48.53 dBm	-68.69 dB	-28.53 dB	-737.500 kHz	-700.000 kHz	300.000 kHz	822.59519 MHz	-48.53 dBm	-68.69 dB	-28.53 dB	-737.500 kHz	-700.000 kHz
700.000 kHz	737.500 kHz	300.000 kHz	824.00696 MHz	-49.82 dBm	-69.96 dB	-29.82 dB	700.000 kHz	737.500 kHz	300.000 kHz	824.00696 MHz	-49.82 dBm	-69.96 dB	-29.82 dB	700.000 kHz	737.500 kHz
737.500 kHz	3.000 MHz	100.000 kHz	824.04768 MHz	-28.31 dBm	-48.46 dB	-15.31 dB	737.500 kHz	3.000 MHz	100.000 kHz	824.04768 MHz	-28.31 dBm	-48.46 dB	-15.31 dB	737.500 kHz	3.000 MHz

Date: 28.DEC.2023 22:18:19





LTE Band 26 / 3MHz / QPSK

Lowest Band Edge / 1RB

Highest Band Edge / 1RB

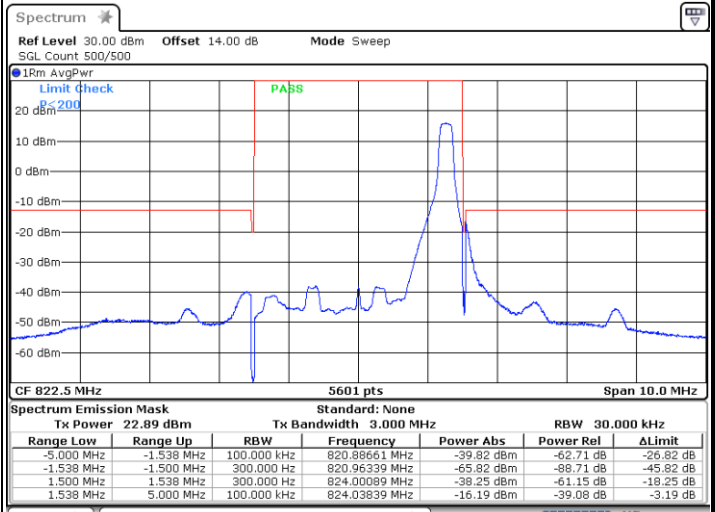
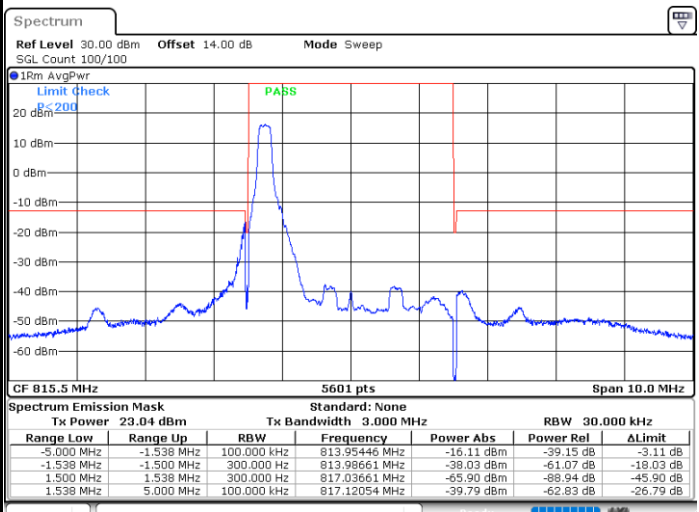

Date: 28.DEC.2023 22:37:19

Date: 28.DEC.2023 23:43:46

Lowest Band Edge / Full RB

Highest Band Edge / Full RB

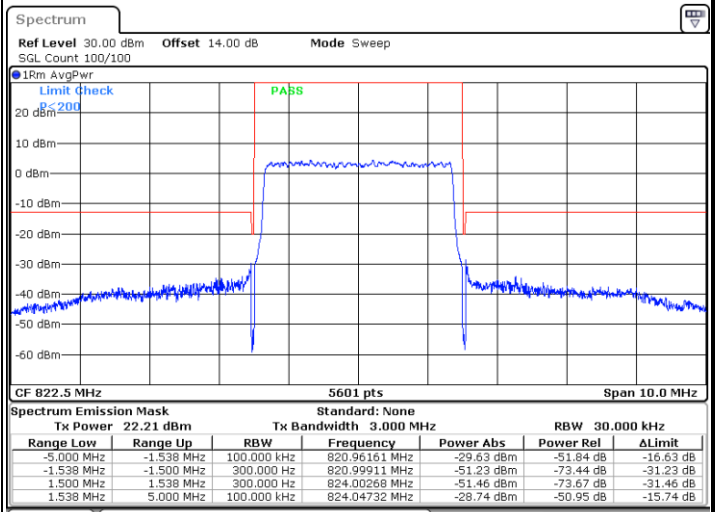
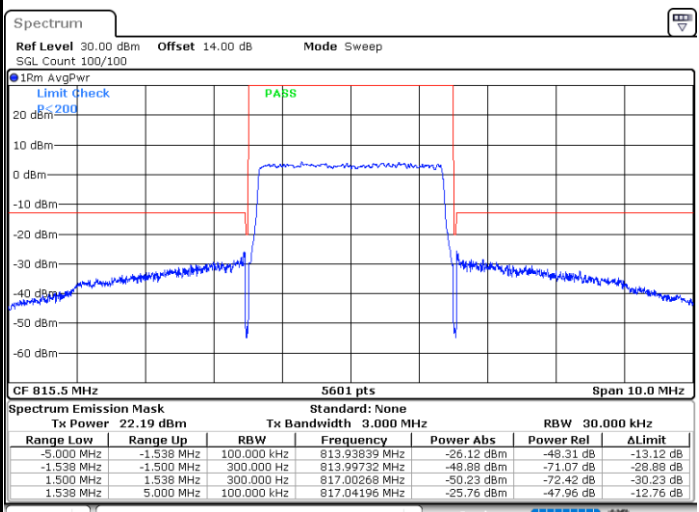

Date: 28.DEC.2023 22:42:25

Date: 28.DEC.2023 22:52:20



LTE Band 26 / 3MHz / 16QAM

Lowest Band Edge / 1 RB

Highest Band Edge / 1 RB

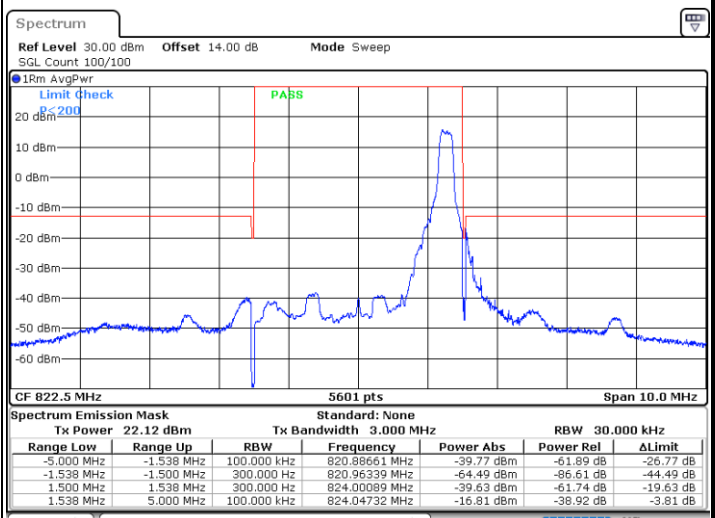
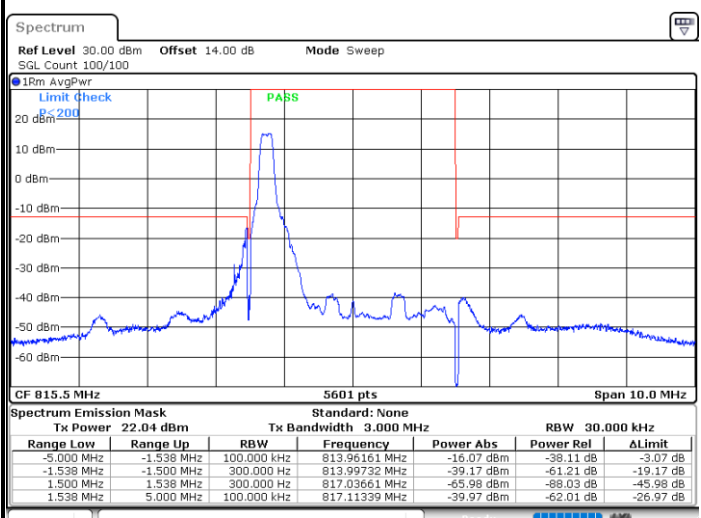

Date: 28.DEC.2023 22:38:20

Date: 28.DEC.2023 22:48:15

Lowest Band Edge / Full RB

Highest Band Edge / Full RB

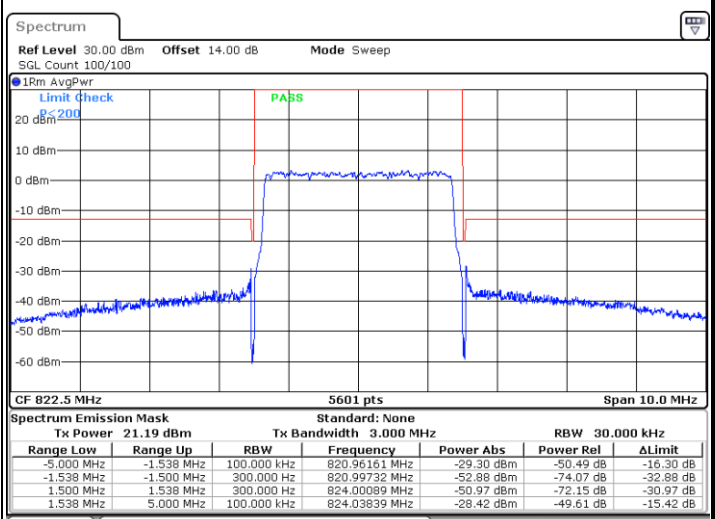
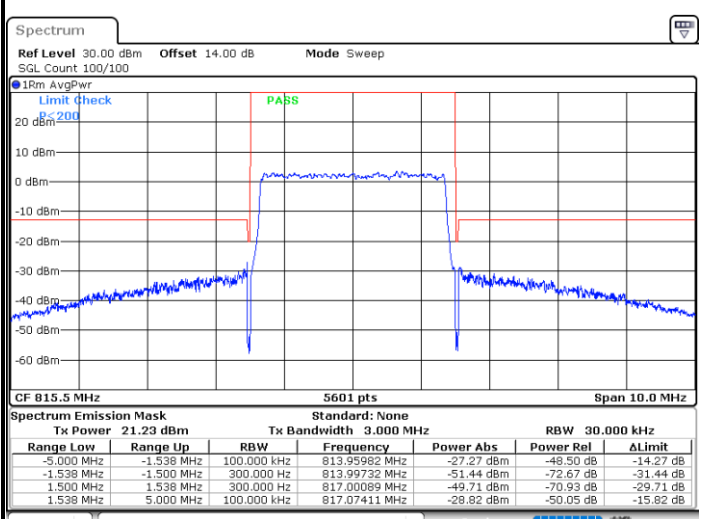

Date: 28.DEC.2023 22:41:23

Date: 28.DEC.2023 22:51:18



LTE Band 26 / 3MHz / 64QAM

Lowest Band Edge / 1 RB

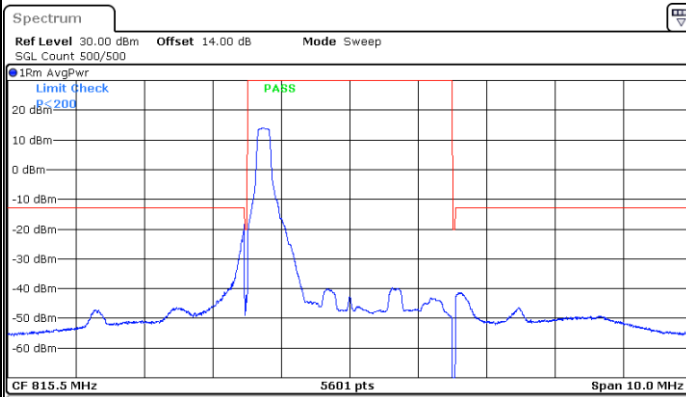

Spectrum Emission Mask		Standard: None		Tx Power 21.10 dBm		Tx Bandwidth 3.000 MHz		RBW 30.000 kHz	
Range Low	Range Up	RBW	Frequency	Power Abs	Power Rel	$\Delta$ Limit			
-5.000 MHz	-1.538 MHz	100.000 kHz	813.95804 MHz	-18.41 dBm	-39.52 dB	-5.41 dB			
-1.538 MHz	-1.500 MHz	300.000 Hz	813.99911 MHz	-41.87 dBm	-62.98 dB	-21.87 dB			
1.500 MHz	1.538 MHz	300.000 Hz	817.03482 MHz	-65.73 dBm	-86.84 dB	-45.73 dB			
1.538 MHz	5.000 MHz	100.000 kHz	817.09196 MHz	-41.38 dBm	-62.48 dB	-28.38 dB			

Date: 28.DEC.2023 23:40:28

Highest Band Edge / 1 RB

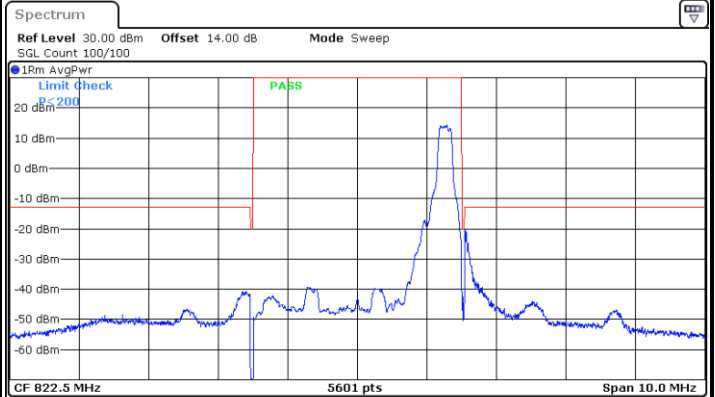

Spectrum Emission Mask		Standard: None		Tx Power 20.89 dBm		Tx Bandwidth 3.000 MHz		RBW 30.000 kHz	
Range Low	Range Up	RBW	Frequency	Power Abs	Power Rel	$\Delta$ Limit			
-5.000 MHz	-1.538 MHz	100.000 kHz	820.84554 MHz	-40.80 dBm	-61.69 dB	-27.80 dB			
-1.538 MHz	-1.500 MHz	300.000 Hz	820.96696 MHz	-66.34 dBm	-87.23 dB	-46.34 dB			
1.500 MHz	1.538 MHz	300.000 Hz	824.00446 MHz	-40.73 dBm	-61.62 dB	-20.73 dB			
1.538 MHz	5.000 MHz	100.000 kHz	824.04911 MHz	-20.55 dBm	-41.44 dB	-7.55 dB			

Date: 28.DEC.2023 22:49:16

Lowest Band Edge / Full RB

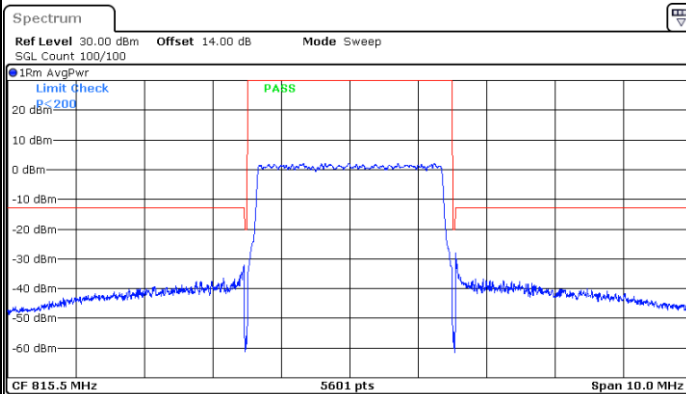

Spectrum Emission Mask		Standard: None		Tx Power 20.22 dBm		Tx Bandwidth 3.000 MHz		RBW 30.000 kHz	
Range Low	Range Up	RBW	Frequency	Power Abs	Power Rel	$\Delta$ Limit			
-5.000 MHz	-1.538 MHz	100.000 kHz	813.96161 MHz	-32.02 dBm	-52.24 dB	-19.02 dB			
-1.538 MHz	-1.500 MHz	300.000 Hz	813.99911 MHz	-52.83 dBm	-73.05 dB	-32.83 dB			
1.500 MHz	1.538 MHz	300.000 Hz	817.00268 MHz	-52.41 dBm	-72.63 dB	-32.41 dB			
1.538 MHz	5.000 MHz	100.000 kHz	817.04554 MHz	-27.90 dBm	-48.12 dB	-14.90 dB			

Date: 28.DEC.2023 22:40:22

Highest Band Edge / Full RB

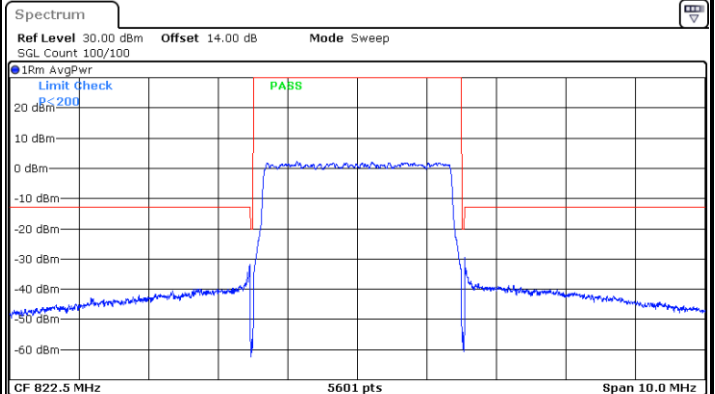

Spectrum Emission Mask		Standard: None		Tx Power 20.20 dBm		Tx Bandwidth 3.000 MHz		RBW 30.000 kHz	
Range Low	Range Up	RBW	Frequency	Power Abs	Power Rel	$\Delta$ Limit			
-5.000 MHz	-1.538 MHz	100.000 kHz	820.96161 MHz	-31.90 dBm	-52.09 dB	-18.90 dB			
-1.538 MHz	-1.500 MHz	300.000 Hz	820.99911 MHz	-53.11 dBm	-73.30 dB	-33.11 dB			
1.500 MHz	1.538 MHz	300.000 Hz	824.00268 MHz	-52.65 dBm	-72.85 dB	-32.65 dB			
1.538 MHz	5.000 MHz	100.000 kHz	824.03839 MHz	-29.59 dBm	-49.79 dB	-16.59 dB			

Date: 28.DEC.2023 22:50:17



LTE Band 26 / 5MHz / QPSK

Lowest Band Edge / 1RB

Highest Band Edge / 1RB

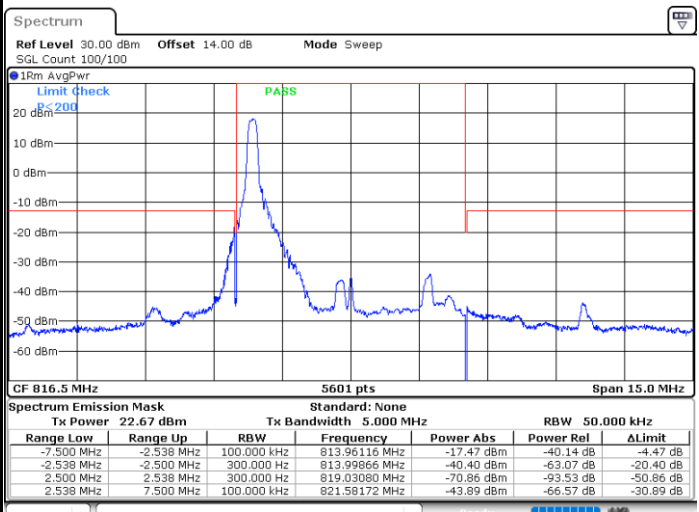

Date: 28.DEC.2023 22:57:34

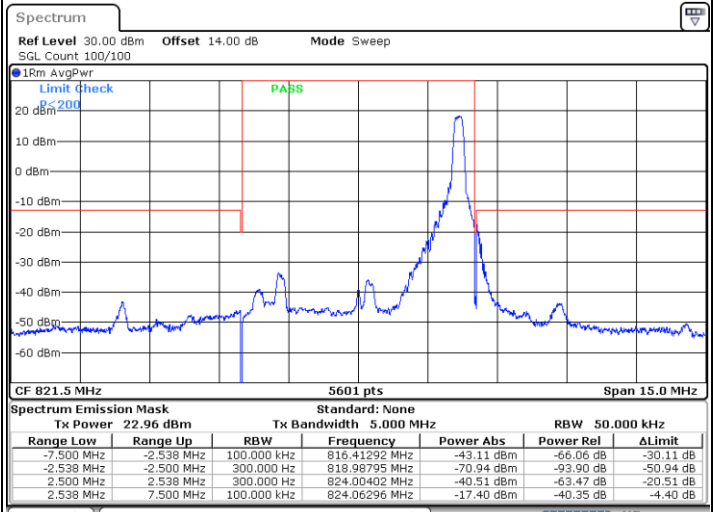

Date: 28.DEC.2023 23:07:27

Lowest Band Edge / Full RB

Highest Band Edge / Full RB

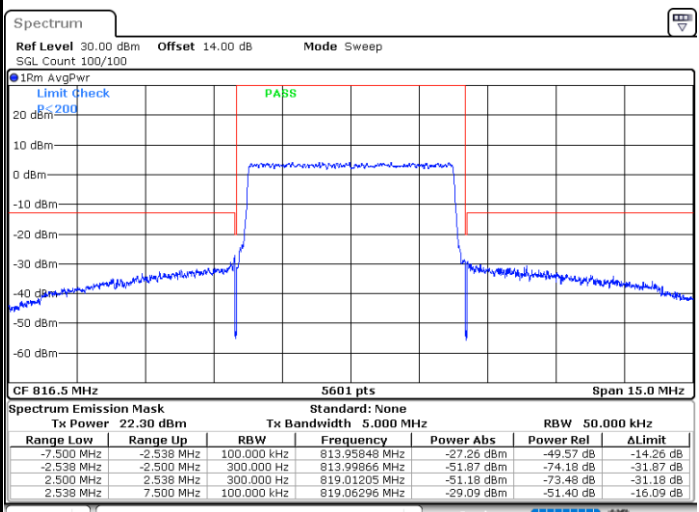

Date: 28.DEC.2023 23:02:39

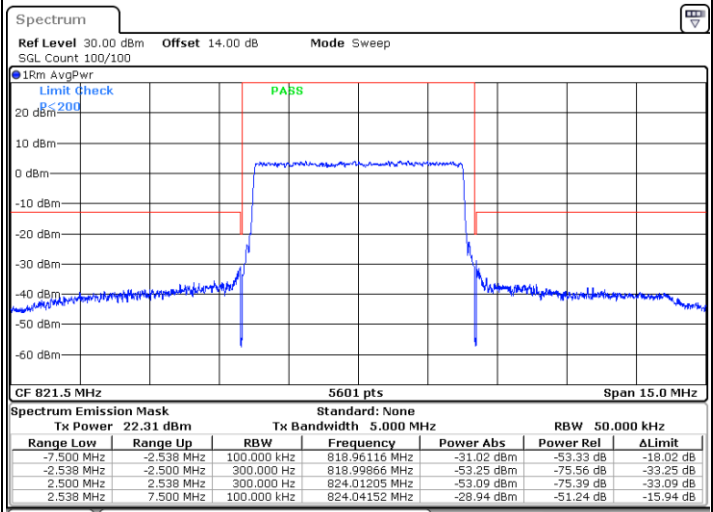

Date: 28.DEC.2023 23:12:33



LTE Band 26 / 5MHz / 16QAM

Lowest Band Edge / 1 RB

Highest Band Edge / 1 RB

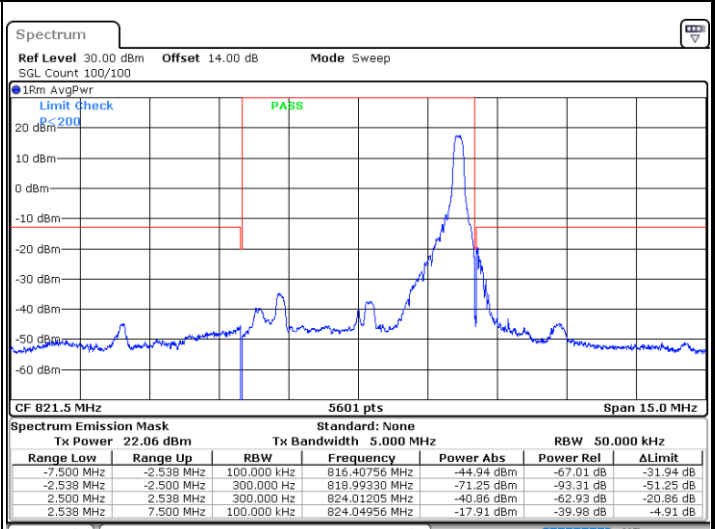
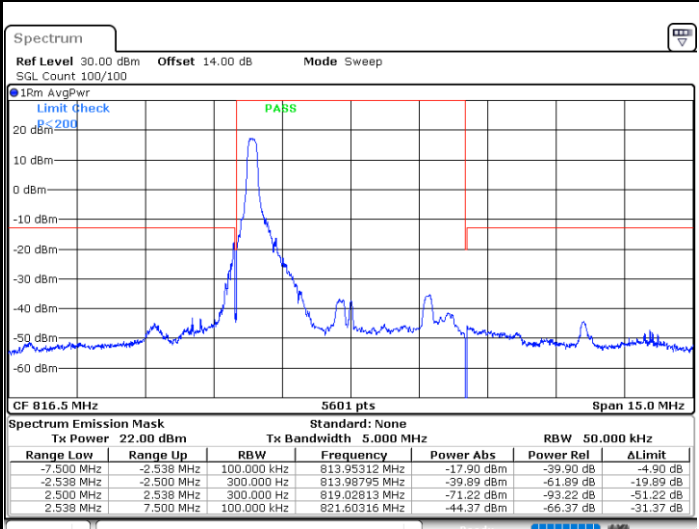

Date: 28.DEC.2023 22:58:35

Date: 28.DEC.2023 23:08:28

Lowest Band Edge / Full RB

Highest Band Edge / Full RB

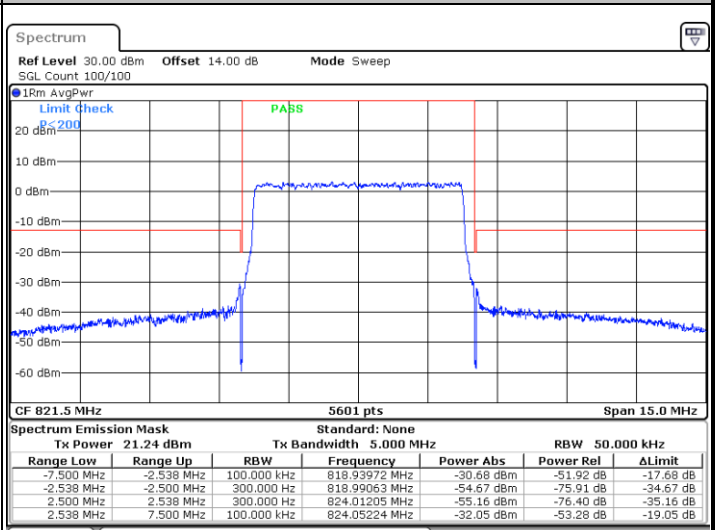
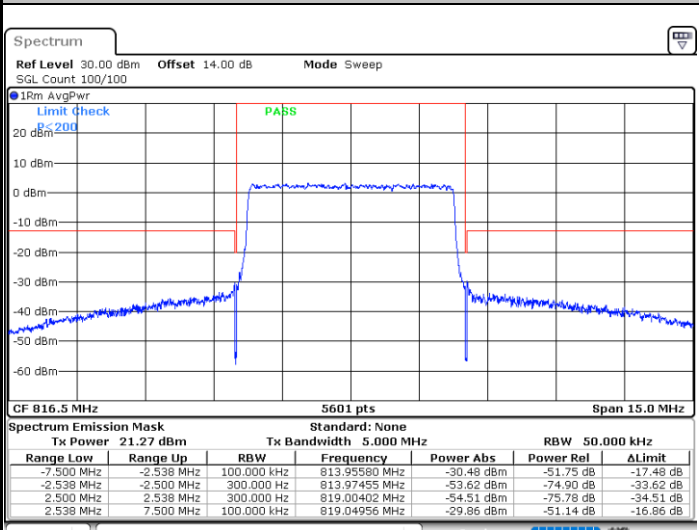

Date: 28.DEC.2023 23:01:38

Date: 28.DEC.2023 23:11:32



LTE Band 26 / 5MHz / 64QAM

Lowest Band Edge / 1 RB

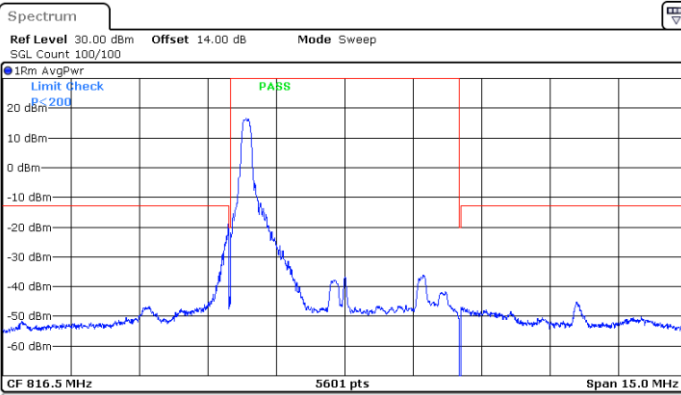

CF 816.5 MHz 5601 pts Span 15.0 MHz

Spectrum Emission Mask		Standard: None		Tx Bandwidth 5.000 MHz		RBW 50.000 kHz	
Range Low	Range Up	RBW	Frequency	Power Abs	Power Rel	ΔLimit	
-7.500 MHz	-2.538 MHz	100.000 kHz	813.94776 MHz	-19.36 dBm	-39.33 dB	-5.36 dB	
-2.538 MHz	-2.500 MHz	300.000 kHz	813.99865 MHz	-42.44 dBm	-63.42 dB	-22.44 dB	
2.500 MHz	2.538 MHz	300.000 kHz	819.01205 MHz	-71.74 dBm	-92.72 dB	-51.74 dB	
2.538 MHz	7.500 MHz	100.000 kHz	821.58172 MHz	-45.24 dBm	-66.21 dB	-32.24 dB	

Date: 28.DEC.2023 22:59:36

Highest Band Edge / 1 RB

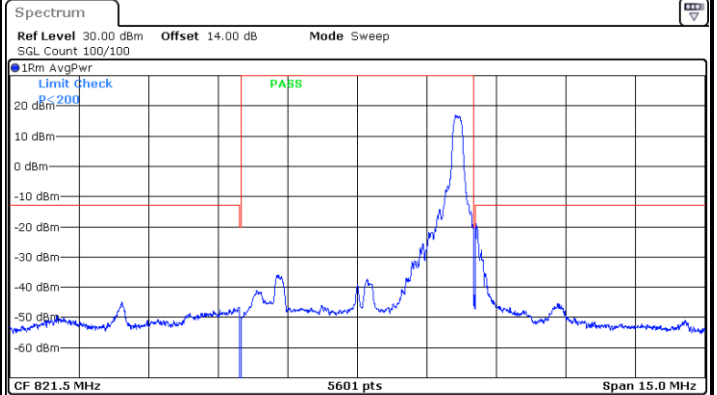

CF 821.5 MHz 5601 pts Span 15.0 MHz

Spectrum Emission Mask		Standard: None		Tx Bandwidth 5.000 MHz		RBW 50.000 kHz	
Range Low	Range Up	RBW	Frequency	Power Abs	Power Rel	ΔLimit	
-7.500 MHz	-2.538 MHz	100.000 kHz	816.41828 MHz	-45.04 dBm	-66.31 dB	-32.04 dB	
-2.538 MHz	-2.500 MHz	300.000 kHz	818.99063 MHz	-71.62 dBm	-92.99 dB	-51.62 dB	
2.500 MHz	2.538 MHz	300.000 kHz	824.00134 MHz	-40.84 dBm	-62.11 dB	-20.84 dB	
2.538 MHz	7.500 MHz	100.000 kHz	824.06564 MHz	-18.83 dBm	-40.10 dB	-8.83 dB	

Date: 28.DEC.2023 23:09:29

Lowest Band Edge / Full RB

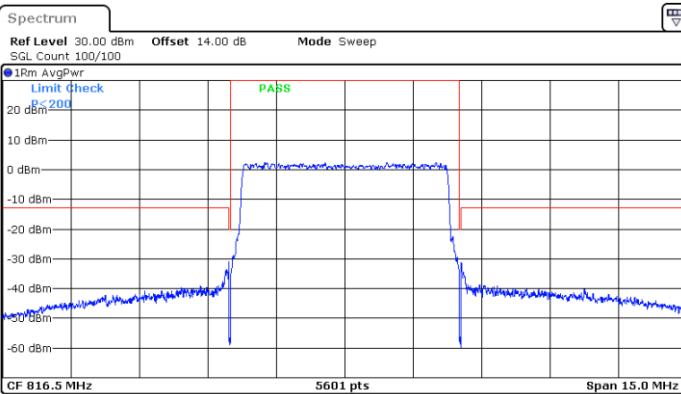

CF 816.5 MHz 5601 pts Span 15.0 MHz

Spectrum Emission Mask		Standard: None		Tx Bandwidth 5.000 MHz		RBW 50.000 kHz	
Range Low	Range Up	RBW	Frequency	Power Abs	Power Rel	ΔLimit	
-7.500 MHz	-2.538 MHz	100.000 kHz	813.96116 MHz	-30.99 dBm	-51.36 dB	-17.99 dB	
-2.538 MHz	-2.500 MHz	300.000 kHz	813.98795 MHz	-55.36 dBm	-75.72 dB	-35.36 dB	
2.500 MHz	2.538 MHz	300.000 kHz	819.00402 MHz	-55.85 dBm	-76.22 dB	-35.85 dB	
2.538 MHz	7.500 MHz	100.000 kHz	819.05224 MHz	-31.30 dBm	-51.66 dB	-18.30 dB	

Date: 28.DEC.2023 23:00:37

Highest Band Edge / Full RB

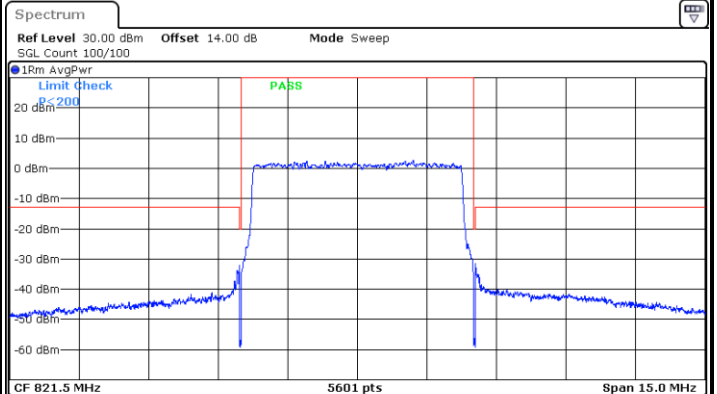

CF 821.5 MHz 5601 pts Span 15.0 MHz

Spectrum Emission Mask		Standard: None		Tx Bandwidth 5.000 MHz		RBW 50.000 kHz	
Range Low	Range Up	RBW	Frequency	Power Abs	Power Rel	ΔLimit	
-7.500 MHz	-2.538 MHz	100.000 kHz	818.96116 MHz	-32.19 dBm	-52.43 dB	-19.19 dB	
-2.538 MHz	-2.500 MHz	300.000 kHz	819.98795 MHz	-55.62 dBm	-75.86 dB	-35.62 dB	
2.500 MHz	2.538 MHz	300.000 kHz	824.00402 MHz	-56.34 dBm	-76.58 dB	-36.34 dB	
2.538 MHz	7.500 MHz	100.000 kHz	824.03884 MHz	-31.41 dBm	-51.65 dB	-18.41 dB	

Date: 28.DEC.2023 23:10:30



LTE Band 26 / 10MHz / QPSK

Lowest Band Edge / 1RB

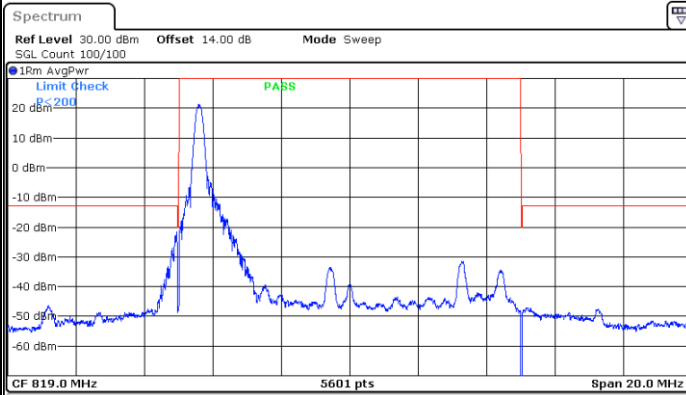

Spectrum Emission Mask		Standard: None		Tx Power 22.63 dBm		Tx Bandwidth 10.000 MHz		RBW 100.000 kHz	
Range Low	Range Up	RBW	Frequency	Power Abs	Power Rel	ΔLimit			
-10.000 MHz	-5.038 MHz	100.000 kHz	813.93570 MHz	-21.66 dBm	-44.29 dB	-8.66 dB			
-5.038 MHz	-5.000 MHz	300.000 Hz	813.99813 MHz	-46.69 dBm	-69.31 dB	-26.69 dB			
5.000 MHz	5.038 MHz	300.000 Hz	824.03188 MHz	-73.12 dBm	-95.74 dB	-53.12 dB			
5.038 MHz	10.000 MHz	100.000 kHz	824.17862 MHz	-47.16 dBm	-69.79 dB	-34.16 dB			

Date: 28.DEC.2023 23:18:29

Lowest Band Edge / 1RB

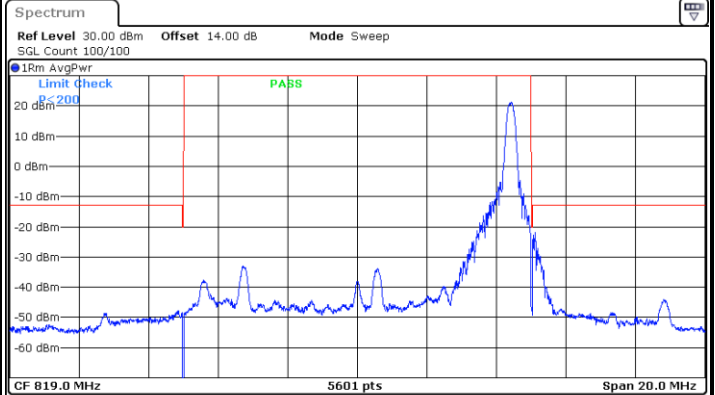

Spectrum Emission Mask		Standard: None		Tx Power 22.82 dBm		Tx Bandwidth 10.000 MHz		RBW 100.000 kHz	
Range Low	Range Up	RBW	Frequency	Power Abs	Power Rel	ΔLimit			
-10.000 MHz	-5.038 MHz	100.000 kHz	813.84639 MHz	-47.73 dBm	-70.54 dB	-34.73 dB			
-5.038 MHz	-5.000 MHz	300.000 Hz	813.99812 MHz	-74.26 dBm	-97.07 dB	-54.26 dB			
5.000 MHz	5.038 MHz	300.000 Hz	824.00188 MHz	-46.54 dBm	-69.36 dB	-26.54 dB			
5.038 MHz	10.000 MHz	100.000 kHz	824.11074 MHz	-21.98 dBm	-44.80 dB	-8.98 dB			

Date: 28.DEC.2023 23:23:33

Lowest Band Edge / Full RB

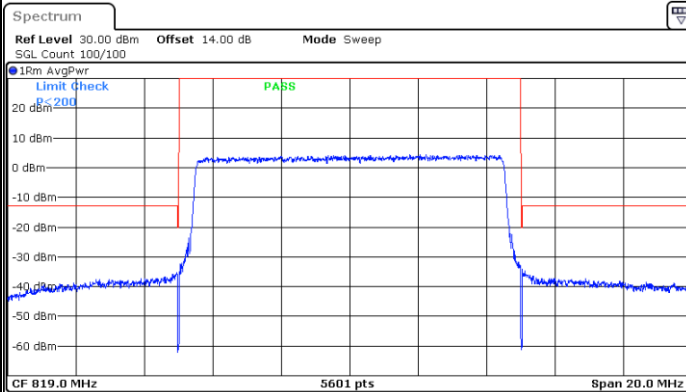

Spectrum Emission Mask		Standard: None		Tx Power 22.24 dBm		Tx Bandwidth 10.000 MHz		RBW 100.000 kHz	
Range Low	Range Up	RBW	Frequency	Power Abs	Power Rel	ΔLimit			
-10.000 MHz	-5.038 MHz	100.000 kHz	813.93213 MHz	-35.30 dBm	-57.55 dB	-22.30 dB			
-5.038 MHz	-5.000 MHz	300.000 Hz	813.98688 MHz	-59.64 dBm	-81.89 dB	-39.64 dB			
5.000 MHz	5.038 MHz	300.000 Hz	824.01688 MHz	-57.83 dBm	-80.07 dB	-37.83 dB			
5.038 MHz	10.000 MHz	100.000 kHz	824.03929 MHz	-34.18 dBm	-56.42 dB	-21.18 dB			

Date: 28.DEC.2023 23:24:34

NA



LTE Band 26 / 10MHz / 16QAM

Lowest Band Edge / 1 RB

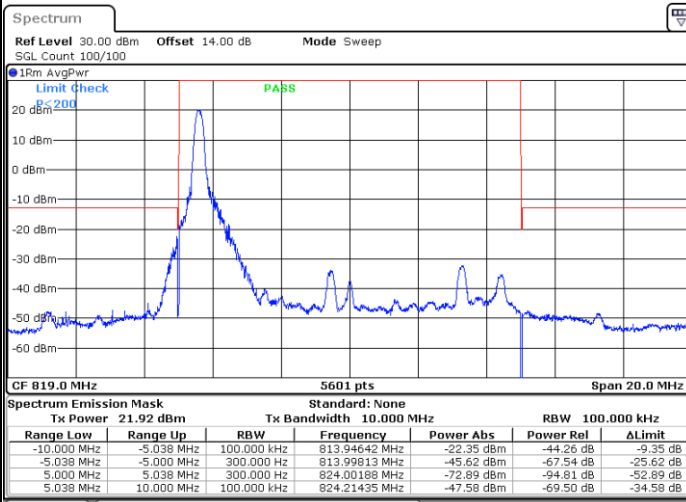

Date: 28.DEC.2023 23:19:30

Lowest Band Edge / 1 RB

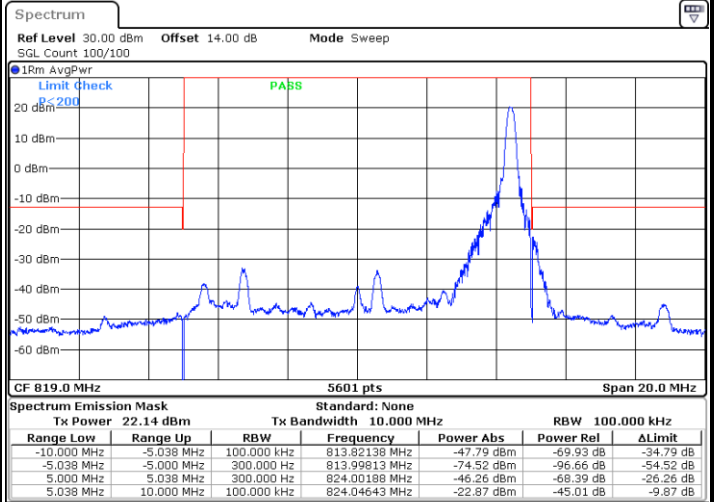

Date: 28.DEC.2023 23:22:32

Lowest Band Edge / Full RB

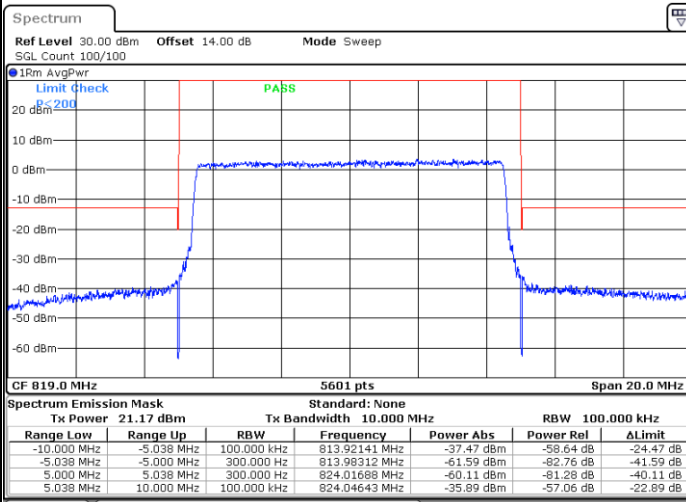

Date: 28.DEC.2023 23:25:35

NA





LTE Band 26 / 10MHz / 64QAM

Lowest Band Edge / 1 RB

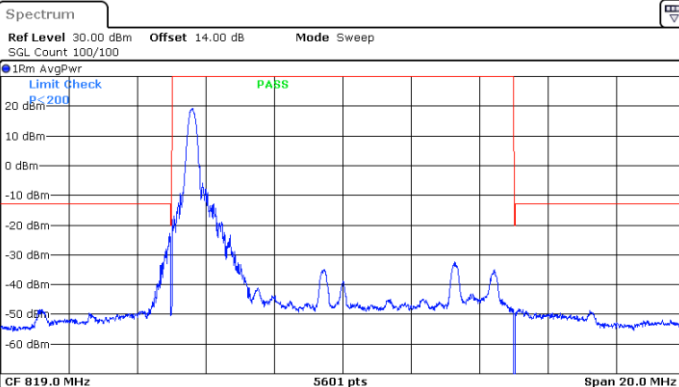

Spectrum Emission Mask		Standard: None		Tx Power 20.86 dBm		Tx Bandwidth 10.000 MHz		RBW 100.000 kHz	
Range Low	Range Up	RBW	Frequency	Power Abs	Power Rel	$\Delta$ Limit			
-10.000 MHz	-5.038 MHz	100.000 kHz	813.94642 MHz	-22.78 dBm	-43.64 dB	-9.78 dB			
-5.038 MHz	-5.000 MHz	300.000 Hz	813.98688 MHz	-47.53 dBm	-68.39 dB	-27.53 dB			
5.000 MHz	5.038 MHz	300.000 Hz	824.00563 MHz	-73.77 dBm	-94.63 dB	-53.77 dB			
5.038 MHz	10.000 MHz	100.000 kHz	824.14647 MHz	-48.12 dBm	-68.98 dB	-35.12 dB			

Date: 28.DEC.2023 23:20:30

Lowest Band Edge / 1 RB

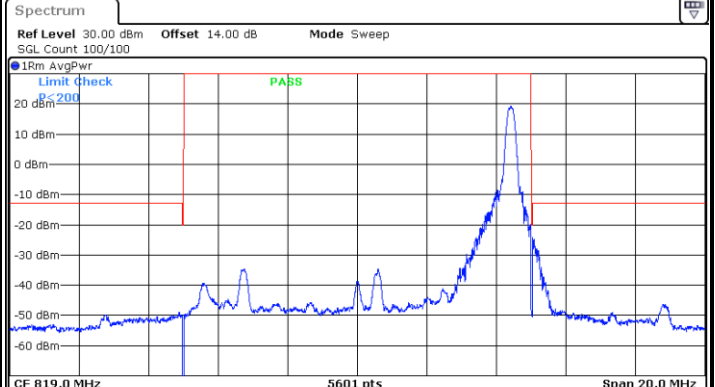

Spectrum Emission Mask		Standard: None		Tx Power 20.94 dBm		Tx Bandwidth 10.000 MHz		RBW 100.000 kHz	
Range Low	Range Up	RBW	Frequency	Power Abs	Power Rel	$\Delta$ Limit			
-10.000 MHz	-5.038 MHz	100.000 kHz	813.87497 MHz	-48.94 dBm	-69.89 dB	-35.94 dB			
-5.038 MHz	-5.000 MHz	300.000 Hz	813.98312 MHz	-74.70 dBm	-95.64 dB	-54.70 dB			
5.000 MHz	5.038 MHz	300.000 Hz	824.00937 MHz	-48.48 dBm	-69.42 dB	-28.48 dB			
5.038 MHz	10.000 MHz	100.000 kHz	824.03929 MHz	-24.26 dBm	-45.21 dB	-11.26 dB			

Date: 28.DEC.2023 23:21:31

Lowest Band Edge / Full RB

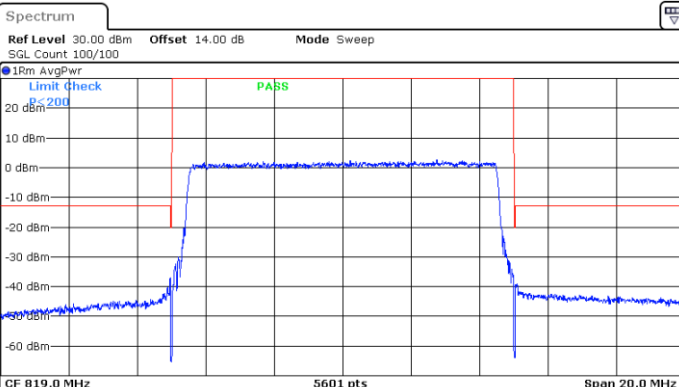

Spectrum Emission Mask		Standard: None		Tx Power 20.17 dBm		Tx Bandwidth 10.000 MHz		RBW 100.000 kHz	
Range Low	Range Up	RBW	Frequency	Power Abs	Power Rel	$\Delta$ Limit			
-10.000 MHz	-5.038 MHz	100.000 kHz	813.95357 MHz	-37.11 dBm	-57.28 dB	-24.11 dB			
-5.038 MHz	-5.000 MHz	300.000 Hz	813.98688 MHz	-63.49 dBm	-83.65 dB	-43.49 dB			
5.000 MHz	5.038 MHz	300.000 Hz	824.00188 MHz	-61.70 dBm	-81.87 dB	-41.70 dB			
5.038 MHz	10.000 MHz	100.000 kHz	824.08216 MHz	-38.99 dBm	-59.16 dB	-25.99 dB			

Date: 28.DEC.2023 23:26:36

NA



LTE Band 26 / 15MHz

Highest Band Edge / 1RB QPSK

Highest Band Edge / Full RB QPSK

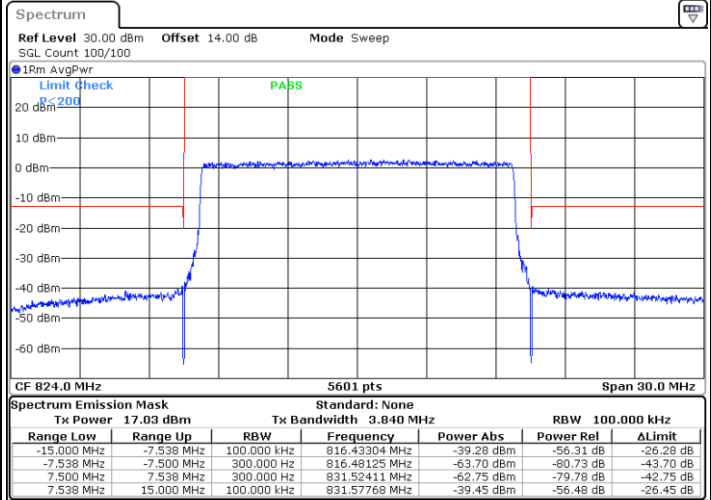
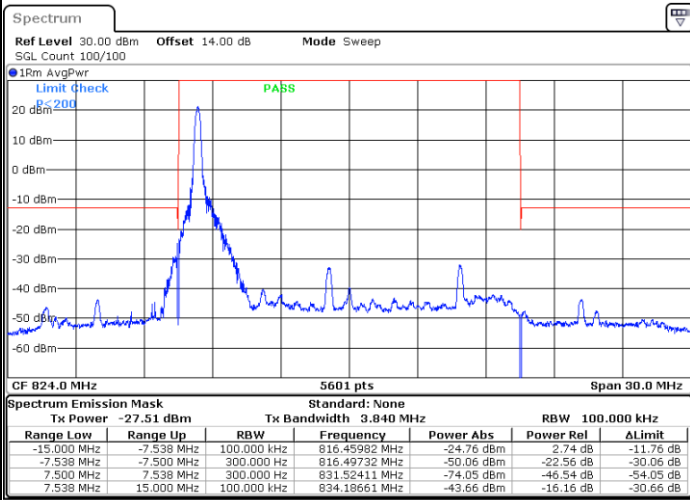

Date: 28.DEC.2023 23:48:02

Date: 28.DEC.2023 23:53:05

Highest Band Edge / 1 RB 16QAM

Highest Band Edge / Full RB 16QAM

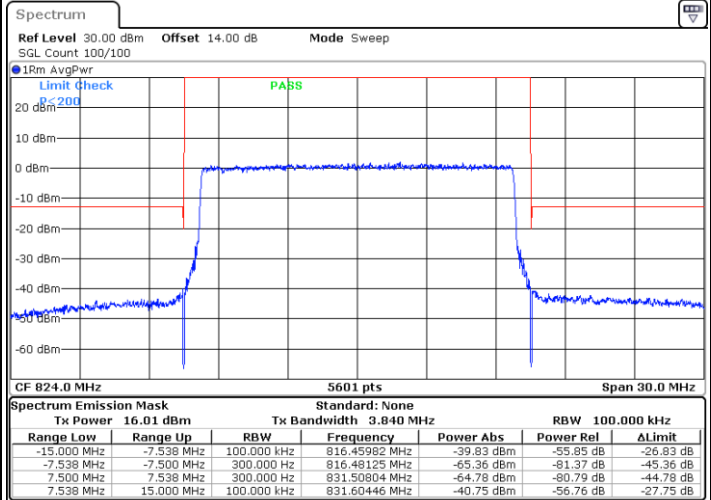
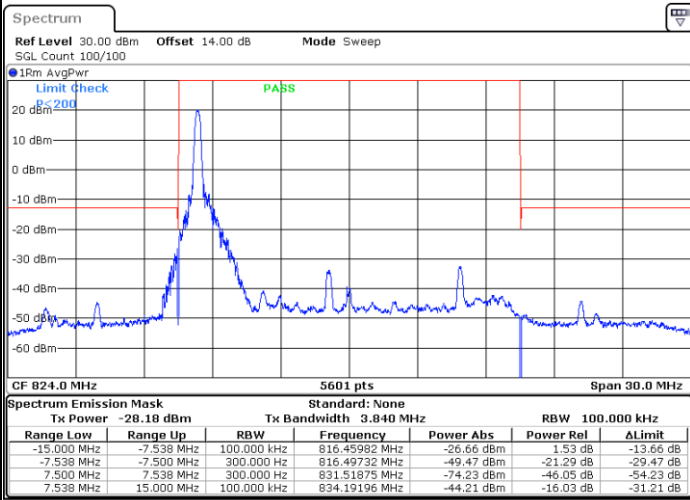

Date: 28.DEC.2023 23:49:02

Date: 28.DEC.2023 23:52:04



LTE Band 26 / 15MHz

Highest Band Edge / 1 RB 64QAM

Highest Band Edge / Full RB 64QAM

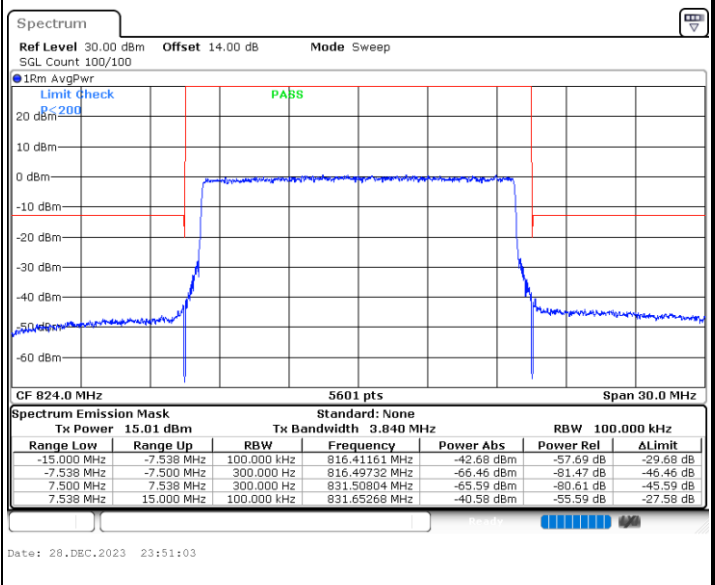
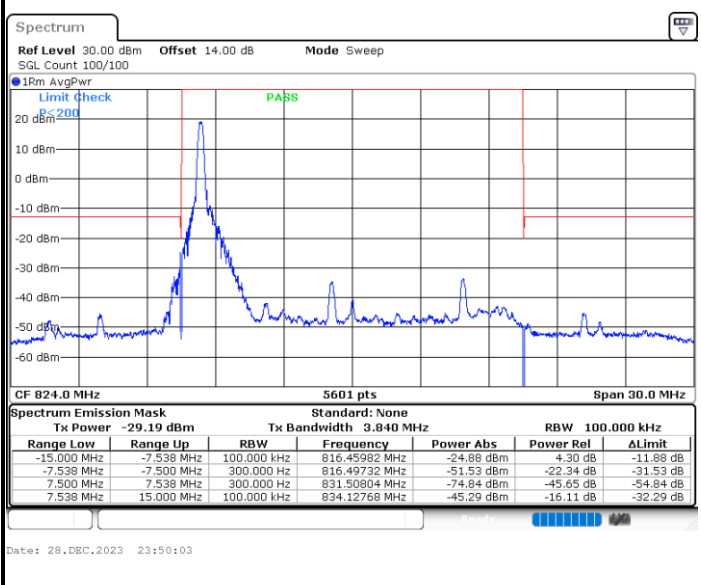



# Emission masks – Out of band emissions





LTE Band 26 / 3MHz

Lowest Channel / QPSK

Middle Channel / QPSK

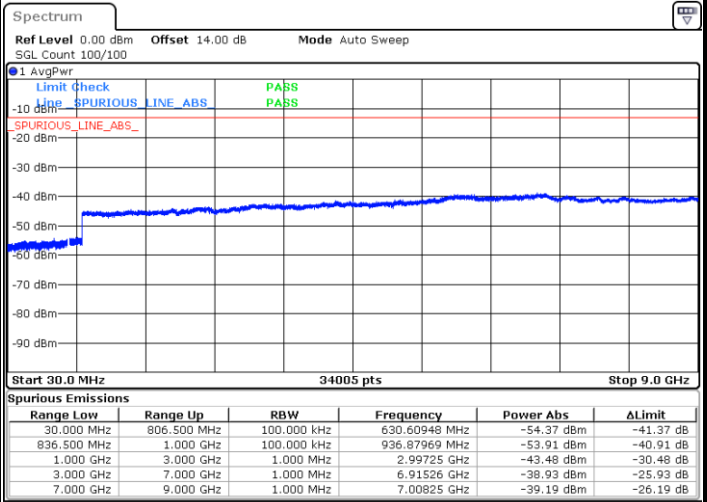
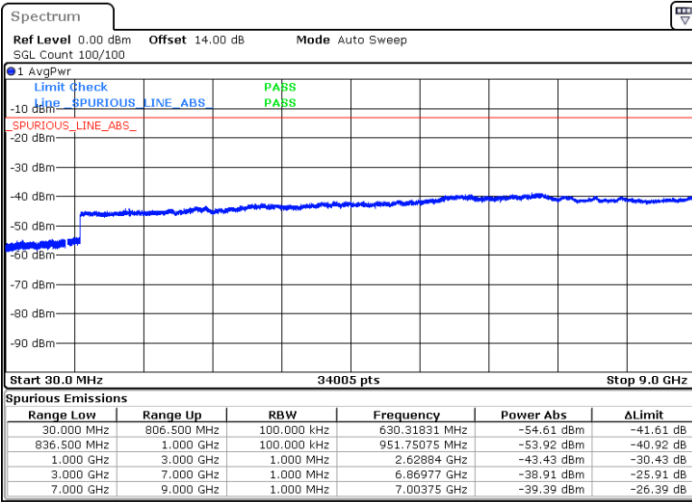

Date: 28.DEC.2023 22:43:38

Date: 28.DEC.2023 22:44:51

Highest Channel / QPSK

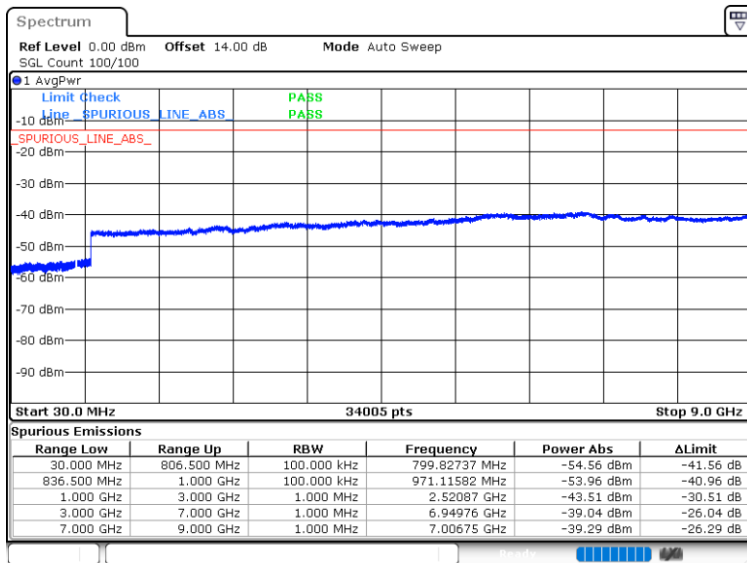

Date: 28.DEC.2023 22:53:32



LTE Band 26 / 5MHz

Lowest Channel / QPSK

Middle Channel / QPSK

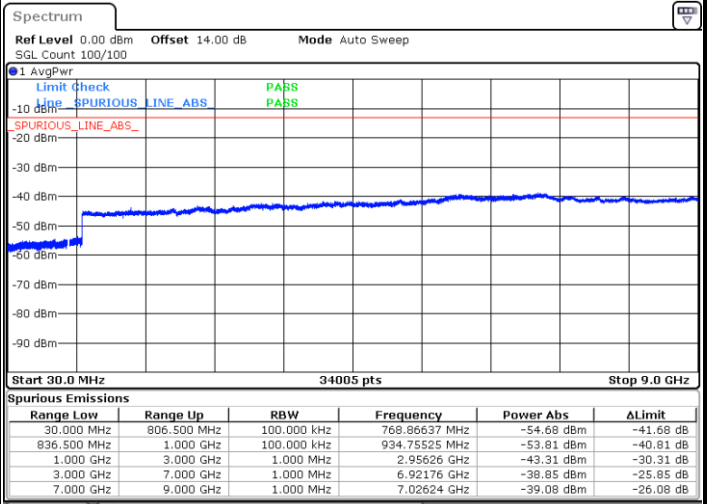
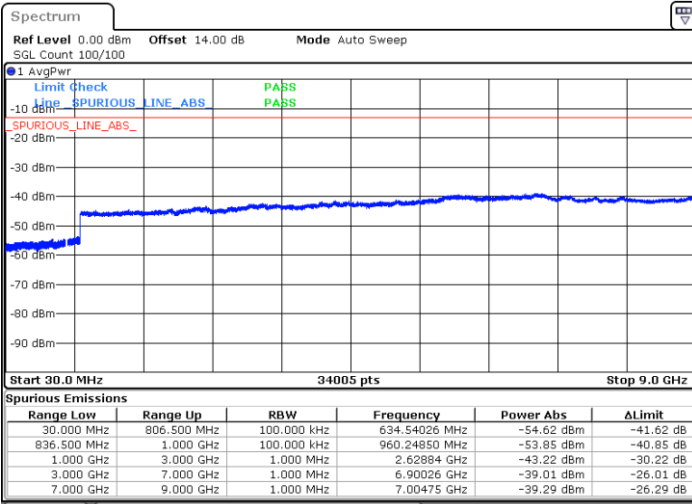

Date: 28.DEC.2023 23:03:52

Date: 28.DEC.2023 23:05:04

Highest Channel / QPSK

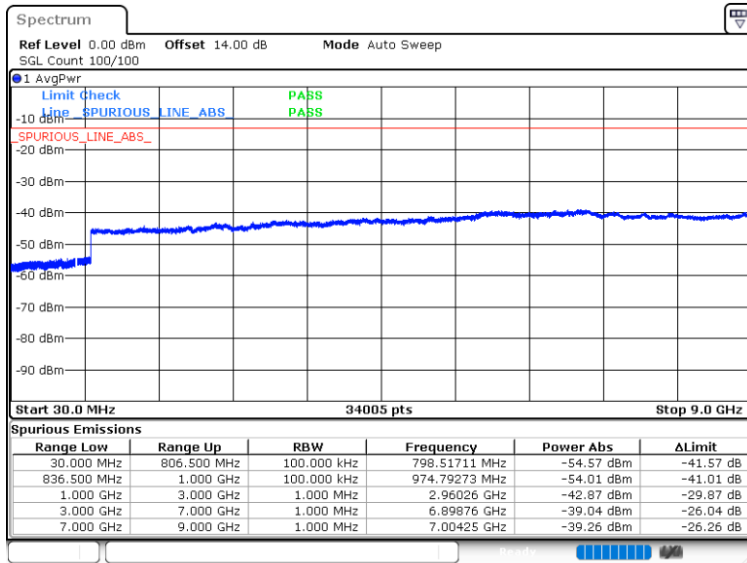

Date: 28.DEC.2023 23:13:45



LTE Band 26 / 10MHz

Middle Channel / QPSK

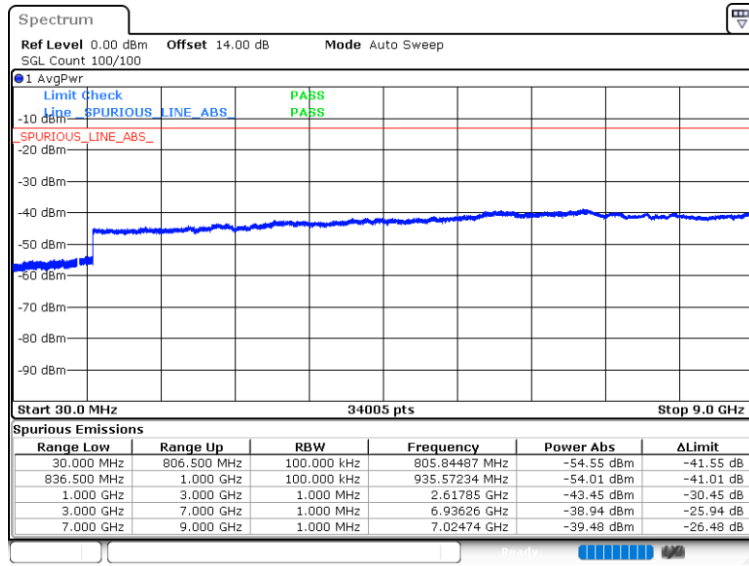

Date: 28.DEC.2023 23:30:35

LTE Band 26 / 15MHz

High Channel / QPSK

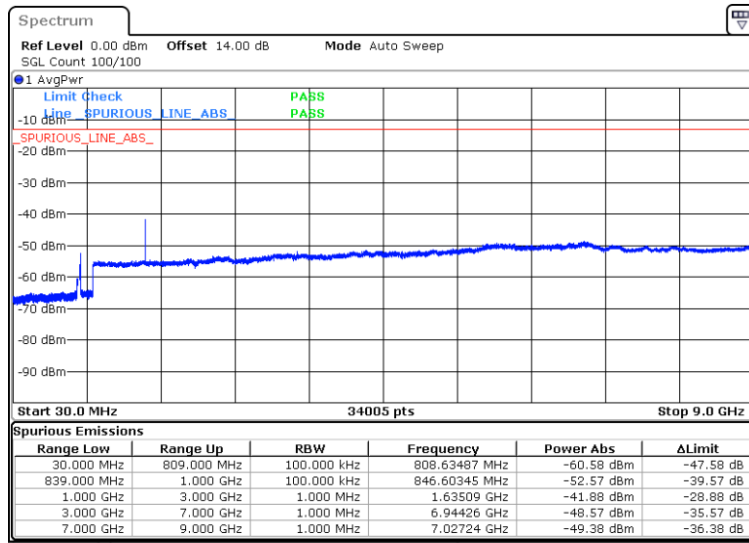

Date: 28.DEC.2023 23:54:18



### Frequency Stability

Test Conditions		LTE Band 26 (QPSK) / Middle Channel	Limit
Temperature (°C)	Voltage (Volt)	BW 10MHz	Note 2.
		Deviation (ppm)	Result
50	Normal Voltage	0.0008	PASS
40	Normal Voltage	0.0007	
30	Normal Voltage	0.0002	
20(Ref.)	Normal Voltage	0.0000	
10	Normal Voltage	0.0006	
0	Normal Voltage	0.0005	
-10	Normal Voltage	0.0008	
-20	Normal Voltage	0.0012	
-30	Normal Voltage	0.0008	
20	Maximum Voltage	0.0005	
20	Normal Voltage	0.0000	
20	Battery End Point	0.0003	

**Note:**

1. Normal Voltage = 3.89 V. ; Battery End Point (BEP) = 3.4 V. ; Maximum Voltage = 4.48 V.
2. The frequency fundamental emissions stay within the authorized frequency block.





Test Conditions		LTE Band 26 (QPSK) / Low Channel	Limit
Temperature (°C)	Voltage (Volt)	BW 15MHz	Note 2.
		Deviation (ppm)	Result
50	Normal Voltage	0.0006	PASS
40	Normal Voltage	0.0003	
30	Normal Voltage	0.0002	
20(Ref.)	Normal Voltage	0.0000	
10	Normal Voltage	0.0005	
0	Normal Voltage	0.0003	
-10	Normal Voltage	0.0007	
-20	Normal Voltage	0.0011	
-30	Normal Voltage	0.0009	
20	Maximum Voltage	0.0002	
20	Normal Voltage	0.0000	
20	Battery End Point	0.0003	

**Note:**

- 1. Normal Voltage = 3.89 V. ; Battery End Point (BEP) = 3.4 V. ; Maximum Voltage = 4.48 V.
- 2. The frequency fundamental emissions stay within the authorized frequency block.



## Appendix B. Test Results of Radiated Test

### Radiated Spurious Emission

Test Engineer :	HuaCong Liang	Temperature :	22~25°C
		Relative Humidity :	48~52%

Note: Pre-scanned harmonic for the different antennas, we choose the worst antenna mode to perform final test and record in the report.

LTE Band 26 / 10MHz / QPSK / Ant. 0									
Channel	Frequency ( MHz )	ERP ( dBm )	Limit ( dBm )	Over Limit ( dB )	SPA Reading (dBm)	S.G. Power ( dBm )	TX Cable loss ( dB )	TX Antenna Gain (dBi)	Polarization (H/V)
Middle	1629	-64.01	-13	-51.01	-76.04	-67.26	4.00	9.40	H
	2443.5	-58.89	-13	-45.89	-77.87	-62.46	4.88	10.60	H
	3258	-57.60	-13	-44.60	-78.46	-62.53	5.52	12.60	H
	1629	-63.32	-13	-50.32	-75.95	-66.57	4.00	9.40	V
	2443.5	-58.48	-13	-45.48	-77.90	-62.05	4.88	10.60	V
	3258	-56.10	-13	-43.10	-78.23	-61.03	5.52	12.60	V

Remark: Spurious emissions within 30-1000MHz were found more than 20dB below limit line.

LTE Band 26 / 15MHz / QPSK / Ant. 0									
Channel	Frequency ( MHz )	ERP ( dBm )	Limit ( dBm )	Over Limit ( dB )	SPA Reading (dBm)	S.G. Power ( dBm )	TX Cable loss ( dB )	TX Antenna Gain (dBi)	Polarization (H/V)
High	1634.5	-63.84	-13	-50.84	-75.87	-67.01	4.10	9.42	H
	2451.75	-59.04	-13	-46.04	-78.02	-62.62	4.90	10.63	H
	3269	-57.46	-13	-44.46	-78.32	-62.38	5.55	12.62	H
	1634.5	-63.37	-13	-50.37	-76.00	-66.54	4.10	9.42	V
	2451.75	-58.36	-13	-45.36	-77.78	-61.94	4.90	10.63	V
	3269	-56.24	-13	-43.24	-78.37	-61.16	5.55	12.62	V

Remark: Spurious emissions within 30-1000MHz were found more than 20dB below limit line.