

TEST REPORT

Applicant: Realme Chongqing Mobile Telecommunications Corp., Ltd.
Address: No.178 Yulong Avenue, Yufengshan, Yubei District, Chongqing, China
Equipment Type: Mobile Phone
Model Name: RMX3988
Brand Name: realme
FCC ID: 2AUYFRMX3988
Test Standard: 47 CFR Part 15 Subpart C (refer to section 3.1)
Sample Arrival Date: Apr. 28, 2024
Test Date: Apr. 30, 2024 – Jun. 03, 2024
Date of Issue: Jun. 28, 2024

ISSUED BY:

Shenzhen BALUN Technology Co., Ltd.

Tested by: Julie zhu

Checked by: Ye Hongji

Approved by: Liao Jianming
(Technical Director)

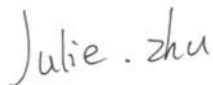

Revision History		
Version	Issue Date	Revisions
<u>Rev. 01</u>	<u>Jun. 28, 2024</u>	<u>Initial Issue</u>

TABLE OF CONTENTS

1	GENERAL INFORMATION	4
1.1	Test Laboratory	4
1.2	Test Location	4
2	PRODUCT INFORMATION	5
2.1	Applicant Information	5
2.2	Manufacturer Information	5
2.3	General Description for Equipment under Test (EUT)	5
2.4	Technical Information	6
3	SUMMARY OF TEST RESULTS	8
3.1	Test Standards	8
3.2	Test Verdict	9
4	GENERAL TEST CONFIGURATIONS	10
4.1	Test Environments	10
4.2	Test Equipment List	10
4.3	Test Software List	10
4.4	Measurement Uncertainty	11
4.5	Description of Test Setup	11
4.6	Measurement Results Explanation Example	14
5	TEST ITEMS	15
5.1	Antenna Requirements	15
5.2	Output Power	16
5.3	Occupied Bandwidth	18
5.4	Conducted Spurious Emission	19
5.5	Band Edge (Authorized-band band-edge)	21

5.6	Conducted Emission	23
5.7	Radiated Spurious Emission	24
5.8	Band Edge (Restricted-band band-edge).....	29
5.9	Power Spectral density (PSD).....	30
ANNEX A	TEST RESULT	31
A.1	Output Power, Duty Cycle	31
A.2	Occupied Bandwidth	36
A.3	Conducted Spurious Emissions	43
A.4	Band Edge (Authorized-band band-edge).....	56
A.5	Conducted Emissions.....	61
A.6	Radiated Spurious Emission	64
A.7	Band Edge (Restricted-band band-edge).....	90
A.8	Power Spectral Density (PSD)	98
ANNEX B	TEST SETUP PHOTOS	103
ANNEX C	EUT EXTERNAL PHOTOS	103
ANNEX D	EUT INTERNAL PHOTOS	103

1 GENERAL INFORMATION

1.1 Test Laboratory

Name	Shenzhen BALUN Technology Co., Ltd.
Address	Block B, 1/F, Baisha Science and Technology Park, Shahe Xi Road, Nanshan District, Shenzhen, Guangdong Province, P. R. China
Phone Number	+86 755 6685 0100

1.2 Test Location

Name	Shenzhen BALUN Technology Co., Ltd.
Location	<input checked="" type="checkbox"/> Block B, 1/F, Baisha Science and Technology Park, Shahe Xi Road, Nanshan District, Shenzhen, Guangdong Province, P. R. China
	<input type="checkbox"/> 1/F, Building B, Ganghongji High-tech Intelligent Industrial Park, No. 1008, Songbai Road, Yangguang Community, Xili Sub-district, Nanshan District, Shenzhen, Guangdong Province, P. R. China
Accreditation Certificate	The laboratory is a testing organization accredited by FCC as a accredited testing laboratory. The designation number is CN1196.

2 PRODUCT INFORMATION

2.1 Applicant Information

Applicant	Realme Chongqing Mobile Telecommunications Corp., Ltd.
Address	No.178 Yulong Avenue, Yufengshan, Yubei District, Chongqing, China

2.2 Manufacturer Information

Manufacturer	Realme Chongqing Mobile Telecommunications Corp., Ltd.
Address	No.178 Yulong Avenue, Yufengshan, Yubei District, Chongqing, China

2.3 General Description for Equipment under Test (EUT)

EUT Name	Mobile Phone
Model Name Under Test	RMX3988
Series Model Name	N/A
Description of Model name differentiation	N/A
Hardware Version	11
Software Version	Color OS 14.0.0
Dimensions (Approx.)	/
Weight (Approx.)	/
EUT ID	/
IMEI Number	/

2.4 Technical Information

Network and Wireless connectivity	<p>2G Network GSM/GPRS/EDGE 850/1900 MHz</p> <p>3G Network WCDMA/HSDPA/HSUPA Band 2/4/5</p> <p>4G Network LTE FDD Band 2/4/5/7/12/13/17/26/66 LTE TDD Band 38/41</p> <p>LTE CA Uplink (UL): CA_7C, CA_38C, CA_41C</p> <p>5G Network</p> <p>SA: NR n5/n7/n38/n41/n66</p> <p>NSA(EN-DC): DC_2A_n66A, DC_5A_n7A, DC_5A_n66A, DC_7A_n5A, DC_7A_n66A, DC_26A_n41A, DC_66A_n5A, DC_66A_n7A</p> <p>Bluetooth (BR+EDR+BLE)</p> <p>2.4G WIFI 802.11b, 802.11g, 802.11n(HT20/40), VHT20/40 and 802.11ax(HE20/40)</p> <p>5G WIFI 802.11a, 802.11n(HT20/40), 802.11ac(VHT20/40/80/160) and 802.11ax(HE20/40/80/160)</p> <p>U-NII-1/2A/2C/3, GPS, GLONASS, BDS, Galileo, SBAS, NFC</p>
-----------------------------------	---

The requirement for the following technical information of the EUT was tested in this report:

Modulation Technology	DTS	
Modulation Type	GFSK	
Product Type	<input type="checkbox"/> Mobile <input checked="" type="checkbox"/> Portable <input type="checkbox"/> Fix Location	
Transfer Rate	1 Mbps, 2 Mbps	
Frequency Range	The frequency range used is 2400 MHz to 2483.5 MHz.	
Number of Channel	40 (at intervals of 2 MHz) ^{Note 1}	
Tested Channel	1 Mbps: 0 (2402 MHz), 19 (2440 MHz), 39 (2480 MHz) 2 Mbps: 1 (2404 MHz), 19 (2440 MHz), 38 (2478 MHz)	
Antenna Type	IFA Antenna	
Antenna	ANT 0	0.2 dBi
Gain	ANT 1	-4.0 dBi
Antenna Impedance	50Ω	
Antenna System (MIMO Smart Antenna)	N/A	
Note 1: 2 Mbps does not support Channel 0, Channel 12, and Channel 39.		

All channel was listed on the following table:

BLE 1M:

Channel number	Freq. (MHz)	Channel number	Freq. (MHz)	Channel number	Freq. (MHz)	Channel number	Freq. (MHz)
0	2402	10	2422	20	2442	30	2462
1	2404	11	2424	21	2444	31	2464
2	2406	12	2426	22	2446	32	2466
3	2408	13	2428	23	2448	33	2468
4	2410	14	2430	24	2450	34	2470
5	2412	15	2432	25	2452	35	2472
6	2414	16	2434	26	2454	36	2474
7	2416	17	2436	27	2456	37	2476
8	2418	18	2438	28	2458	38	2478
9	2420	19	2440	29	2460	39	2480

BLE 2M:

Channel number	Freq. (MHz)	Channel number	Freq. (MHz)	Channel number	Freq. (MHz)	Channel number	Freq. (MHz)
\	\	10	2422	20	2442	30	2462
1	2404	11	2424	21	2444	31	2464
2	2406	\	\	22	2446	32	2466
3	2408	13	2428	23	2448	33	2468
4	2410	14	2430	24	2450	34	2470
5	2412	15	2432	25	2452	35	2472
6	2414	16	2434	26	2454	36	2474
7	2416	17	2436	27	2456	37	2476
8	2418	18	2438	28	2458	38	2478
9	2420	19	2440	29	2460	\	\

3 SUMMARY OF TEST RESULTS

3.1 Test Standards

No.	Identity	Document Title
1	47 CFR Part 15, Subpart C	Intentional radiators of radio frequency equipment
2	ANSI C63.10-2013	American National Standard for Testing Unlicensed Wireless Devices
3	KDB 558074 D01 15.247 Meas Guidance v05r02	Guidance for compliance measurements on digital transmission system, frequency hopping spread spectrum system, and hybrid system devices operating under section 15.247 of the FCC rules

3.2 Test Verdict

No.	Description	FCC Part No.	Channel	Test Result	Verdict
1	Antenna Requirement	15.203	N/A	--	Pass ^{Note1}
2	Output Power	15.247(b)	Low/Middle/High	ANNEX A.1	Pass
3	Occupied Bandwidth	15.247(a)	Low/Middle/High	ANNEX A.2	Pass
4	Conducted Spurious Emission	15.247(d)	Low/Middle/High	ANNEX A.3	Pass
5	Band Edge(Authorized-band band-edge)	15.247(d)	Low/High	ANNEX A.4	Pass
6	Conducted Emission	15.207	Low/Middle/High	ANNEX A.5	Pass
7	Radiated Spurious Emission	15.209 15.247(d)	Low/Middle/High	ANNEX A.6	Pass
8	Band Edge(Restricted-band band-edge)	15.209 15.247(d)	Low/High	ANNEX A.7	Pass
9	Power spectral density (PSD)	15.247(e)	Low/Middle/High	ANNEX A.8	Pass

Note ¹: The EUT has a permanently and irreplaceable attached antenna, which complies with the requirement FCC 15.203.

Note ²: Compared with the EUT of test report BL-SZ2441396-602, the changes of the EUT of this report as below:

1. Changed model name from RMX3921 to RMX3988;
2. Changed FCC ID from FCC ID: 2AUYFRMX3921 to FCC ID: 2AUYFRMX3988;
3. Changed the rear camera specifications;
4. Changed the battery, USB Line and adapter.

Other hardware circuit and software are the same as EUT referred in test report BL-SZ2441396-602.

Therefore, in addition to the above differences, all test data and EUT information are derived from the report BL-SZ2441396-602 published by Shenzhen BALUN Technology Co., Ltd. on Jun. 19, 2024.

4 GENERAL TEST CONFIGURATIONS

4.1 Test Environments

During the measurement, the normal environmental conditions were within the listed ranges:

Relative Humidity	45% to 67%	
Atmospheric Pressure	100 kPa to 102 kPa	
Temperature	NT (Normal Temperature)	+20.3°C to +24.4°C
Working Voltage of the EUT	NV (Normal Voltage)	3.87 V

4.2 Test Equipment List

Description	Manufacturer	Model	Serial No.	Cal. Date	Cal. Due
Spectrum Analyzer	KEYSIGHT	N9020A	MY50330200	2023.05.16	2024.05.15
				2024.05.08	2025.05.07
Spectrum Analyzer	KEYSIGHT	N9020A	MY52510065	2023.09.05	2024.09.04
Test Antenna-Horn	SCHWARZBECK	BBHA 9120D	01631	2022.02.23	2025.02.22
Test Antenna-Horn	A-INFO	LB-180400KF	J211060273	2021.07.02	2024.07.01
Anechoic Chamber	RAINFORD	9m*6m*6m	144	2022.02.19	2024.09.03
Amplifier	COM-MV	LSCX_LNA1-12G-01	180602	2023.09.05	2024.09.04
Amplifier	COM-MV	XKu_LNA7-18G-01	180601	2023.09.05	2024.09.04
EMI Receiver	ROHDE&SCHWARZ	ESRP	101036	2023.09.05	2024.09.04
Test Antenna-Loop	SCHWARZBECK	FMZB 1519	1519-037	2024.01.23	2025.01.22
Amplifier	COM-MV	ZT30-1000M	B2018054558	2023.12.05	2024.12.04
Anechoic Chamber	EMC Electronic Co., Ltd	20.10*11.60*7.35m	130	2021.08.15	2024.08.14
EMI Receiver	KEYSIGHT	N9038A	MY53220118	2023.09.05	2024.09.04
Test Antenna-Bi-Log	SCHWARZBECK	VULB 9163	9163-624	2021.08.20	2024.08.19
Amplifier	COM-MV	ZT30-1000M	B2017119082	2023.12.05	2024.12.04
Anechoic Chamber	RAINFORD	9m*6m*6m	101	2023.03.04	2026.03.03
EMI Receiver	KEYSIGHT	N9010B	MY57110309	2023.09.05	2024.09.04
LISN	SCHWARZBECK	NSLK 8127	8127-687	2023.05.16	2024.05.15
				2024.05.08	2025.05.07
Shielded Enclosure	YiHeng Electronic Co., Ltd	3.5m*3.1m*2.8m	112	2022.02.19	2025.02.18

4.3 Test Software List

Description	Manufacturer	Software Version	Serial No.	Applicable test Setup
BL410R	BALUN	V2.1.1.488	N/A	The section 4.5.1
BL410E	BALUN	V22.930	N/A	The section 4.5.2&4.5.3&4.5.4&4.5.5

4.4 Measurement Uncertainty

The following measurement uncertainty levels have been estimated for tests performed on the EUT as specified in CISPR 16-4-2.

This uncertainty represents an expanded uncertainty expressed at approximately the 95% confidence level using a coverage factor of k=2.

Parameters	Uncertainty
Occupied Channel Bandwidth	2.8%
RF output power, conducted	1.28 dB
Power Spectral Density, conducted	1.30 dB
Unwanted Emissions, conducted	1.84 dB
All emissions, radiated	5.36 dB
Temperature	0.8°C
Humidity	4%

4.5 Description of Test Setup

4.5.1 For Antenna Port Test

$$\text{Conducted value (dBm)} = \text{Measurement value (dBm)} + \text{cable loss (dB)}$$

For example: the measurement value is 10 dBm and the cable 0.5dBm used, then the final result of EUT:

$$\text{Conducted value (dBm)} = 10 \text{ dBm} + 0.5 \text{ dB} = 10.5 \text{ dBm}$$

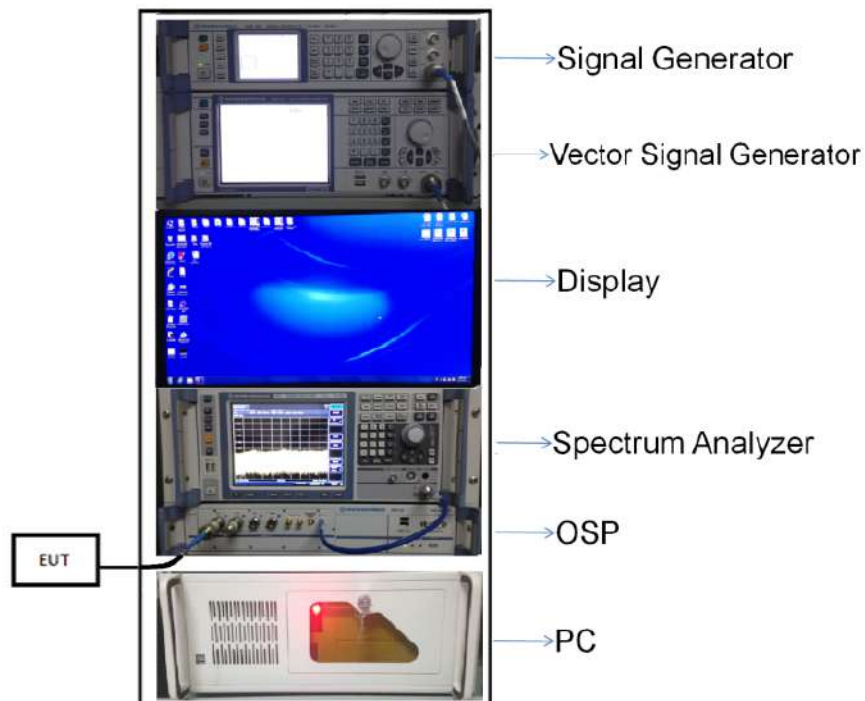

(Diagram 1)

4.5.2 For AC Power Supply Port Test

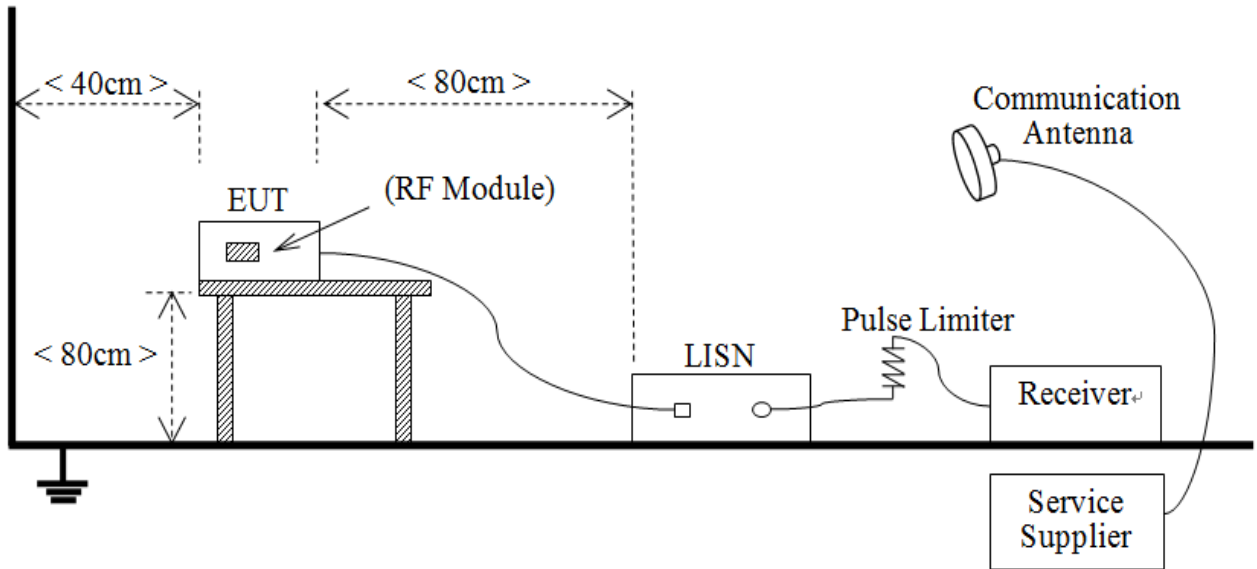

(Diagram 2)

4.5.3 For Radiated Test (Below 30 MHz)

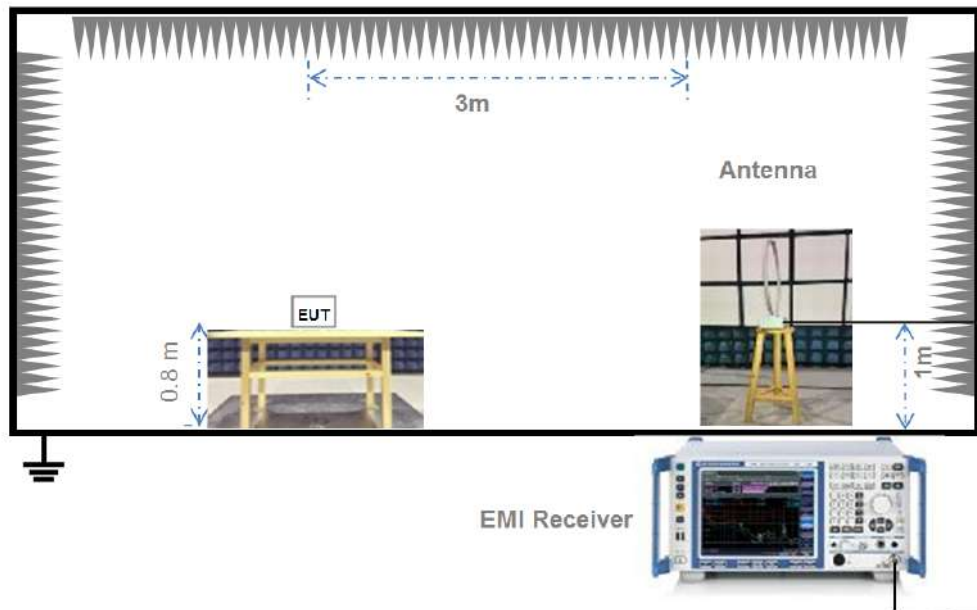

(Diagram 3)

4.5.4 For Radiated Test (30 MHz-1 GHz)

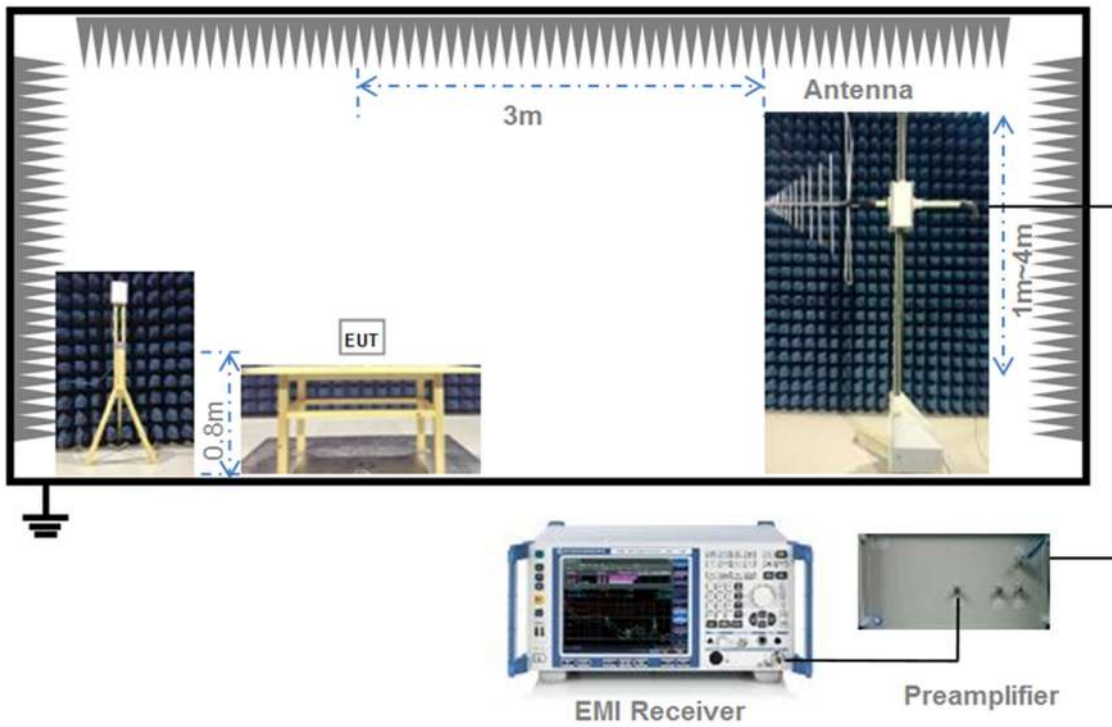

(Diagram 4)

4.5.5 For Radiated Test (Above 1 GHz)

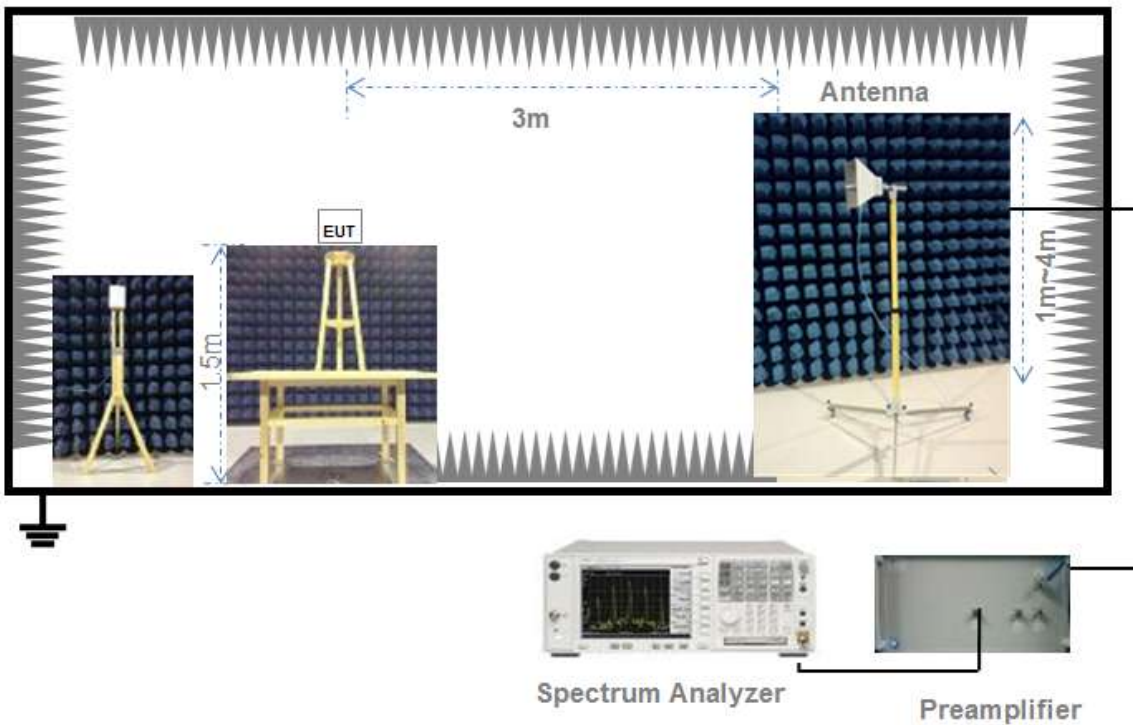

(Diagram 5)

4.6 Measurement Results Explanation Example

4.6.1 For conducted test items:

The offset level is set in the spectrum analyzer to compensate the RF cable loss and attenuator between EUT conducted output port and spectrum analyzer. With the offset compensation, the spectrum analyzer reading level is exactly the EUT RF output level.

The spectrum analyzer offset is derived from RF cable loss and attenuator factor.

Offset = RF cable loss + attenuator factor.

4.6.2 For radiated band edges and spurious emission test:

$$E = \text{EIRP} - 20\log D + 104.8$$

where:

E = electric field strength in dB μ V/m,

EIRP = equivalent isotropic radiated power in dBm

D = specified measurement distance in meters.

5 TEST ITEMS

5.1 Antenna Requirements

5.1.1 Relevant Standards

FCC §15.203 & 15.247(b)

An intentional radiator shall be designed to ensure that no antenna other than that furnished by the responsible party shall be used with the device. The use of a permanently attached antenna or of an antenna that uses a unique coupling to the intentional radiator shall be considered sufficient to comply with the provisions of this section. The manufacturer may design the unit so that a broken antenna can be replaced by the user, but the use of a standard antenna jack or electrical connector is prohibited. This requirement does not apply to carrier current devices or to devices operated under the provisions of § 15.211, § 15.213, § 15.217, § 15.219, or § 15.221. Further, this requirement does not apply to intentional radiators that must be professionally installed, such as perimeter protection systems and some field disturbance sensors, or to other intentional radiators which, in accordance with § 15.31(d), must be measured at the installation site. However, the installer shall be responsible for ensuring that the proper antenna is employed so that the limits in this part are not exceeded.

If directional gain of transmitting antennas is greater than 6 dBi, the power shall be reduced by the same level in dB comparing to gain minus 6 dBi. For the fixed point-to-point operation, the power shall be reduced by one dB for every 3 dB that the directional gain of the antenna exceeds 6 dBi. The use of a permanently attached antenna or of an antenna that uses a unique coupling to the intentional radiator shall be considered sufficient to comply with the FCC rule.

5.1.2 Antenna Anti-Replacement Construction

The Antenna Anti-Replacement as following method:

Protected Method	Description
The antenna is embedded in the product.	An embedded-in antenna design is used.

Reference Documents	Item
Photo	Please refer to the EUT Photo documents.

5.1.3 Antenna Gain

The antenna peak gain of EUT is less than 6 dBi. Therefore, it is not necessary to reduce maximum peak output power limit.

5.2 Output Power

5.2.1 Test Limit

FCC § 15.247(b)

For systems using digital modulation in the 902-928 MHz, 2400-2483.5 MHz, and 5725-5850 MHz bands: 1 Watt. As an alternative to a peak power measurement, compliance with the one Watt limit can be based on a measurement of the maximum conducted output power. Maximum Conducted Output Power is defined as the total transmit power delivered to all antennas and antenna elements averaged across all symbols in the signaling alphabet when the transmitter is operating at its maximum power control level. Power must be summed across all antennas and antenna elements.

5.2.2 Test Setup

See section 4.5.1 for test setup description for the antenna port. The photo of test setup please refer to ANNEX B.

5.2.3 Test Procedure

a) Maximum peak conducted output power

This procedure shall be used when the measurement instrument has available a resolution bandwidth that is greater than the DTS bandwidth.

Set the $RBW \geq DTS$ bandwidth.

Set $VBW \geq 3 \times RBW$.

Set span $\geq 3 \times RBW$

Sweep time = auto couple.

Detector = peak.

Trace mode = max hold.

Allow trace to fully stabilize.

Use peak marker function to determine the peak amplitude level.

b) Measurements of duty cycle

The zero-span mode on a spectrum analyzer or EMI receiver if the response time and spacing between bins on the sweep are sufficient to permit accurate measurements of the on and off times of the transmitted signal.

Set the center frequency of the instrument to the center frequency of the transmission.

Set $RBW \geq OBW$ if possible; otherwise, set RBW to the largest available value.

Set $VBW \geq RBW$. Set detector = peak or average.

The zero-span measurement method shall not be used unless both RBW and VBW are $> 50/T$ and the number of sweep points across duration T exceeds 100. (For example, if VBW and/or RBW are limited to 3 MHz, then the zero-span method of measuring duty cycle shall not be used if $T \leq 16.7$ microseconds.)

5.2.4 Test Result

Please refer to ANNEX A.1.

5.3 Occupied Bandwidth

5.3.1 Limit

FCC §15.247(a)

Make the measurement with the spectrum analyzer's resolution bandwidth (RBW) = 100 kHz. In order to make an accurate measurement, set the span greater than RBW. The 6 dB bandwidth must be greater than 500 kHz.

5.3.2 Test Setup

See section 4.5.1 for test setup description for the antenna port. The photo of test setup please refer to ANNEX B.

5.3.3 Test Procedure

Use the following spectrum analyzer settings:

Set RBW = 100 kHz.

Set the video bandwidth (VBW) ≥ 3 RBW.

Detector = Peak.

Trace mode = max hold.

Sweep = auto couple.

Allow the trace to stabilize.

Measure the maximum width of the emission that is constrained by the frequencies associated with the two outermost amplitude points (upper and lower frequencies) that are attenuated by 6 dB relative to the maximum level measured in the fundamental emission.

5.3.4 Test Result

Please refer to ANNEX A.2.

5.4 Conducted Spurious Emission

5.4.1 Limit

FCC §15.247(d)

In any 100 kHz bandwidth outside the frequency band in which the spread spectrum or digitally modulated intentional radiator is operating, the radio frequency power that is produced by the intentional radiator shall be at least 20 dB below that in the 100 kHz bandwidth within the band that contains the highest level of the desired power, based on either an RF conducted or a radiated measurement.

5.4.2 Test Setup

See section 4.5.1 for test setup description for the antenna port. The photo of test setup please refer to ANNEX B.

5.4.3 Test Procedure

The DTS rules specify that in any 100 kHz bandwidth outside of the authorized frequency band, the power shall be attenuated according to the following conditions:

- a) If the maximum peak conducted output power procedure was used to demonstrate compliance as described in 9.1, then the peak output power measured in any 100 kHz bandwidth outside of the authorized frequency band shall be attenuated by at least 20 dB relative to the maximum in-band peak PSD level in 100 kHz (i.e., 20 dBc).
- b) If maximum conducted (average) output power was used to demonstrate compliance as described in 9.2, then the peak power in any 100 kHz bandwidth outside of the authorized frequency band shall be attenuated by at least 30 dB relative to the maximum in-band peak PSD level in 100 kHz (i.e., 30 dBc).
- c) In either case, attenuation to levels below the 15.209 general radiated emissions limits is not required.

The following procedures shall be used to demonstrate compliance to these limits. Note that these procedures can be used in either an antenna-port conducted or radiated test set-up. Radiated tests must conform to the test site requirements and utilize maximization procedures defined herein.

Reference level measurement:

Establish a reference level by using the following procedure:

Set instrument center frequency to DTS channel center frequency.

Set the span to ≥ 1.5 times the DTS bandwidth.

Set the RBW = 100 kHz.

Set the VBW $\geq 3 \times$ RBW.

Detector = peak.

Sweep time = auto couple.

Trace mode = max hold.

Allow trace to fully stabilize.

Use the peak marker function to determine the maximum PSD level.

Emission level measurement:

Use the following spectrum analyzer settings:

Span = wide enough to capture the peak level of the in-band emission and all spurious emissions (e.g., harmonics) from the lowest frequency generated in the EUT up through the 10th harmonic. Typically, several plots are required to cover this entire span.

Set the RBW = 100 kHz.

Set the VBW $\geq 3 \times$ RBW.

Detector = peak.

Sweep time = auto couple.

Trace mode = max hold.

Allow trace to fully stabilize.

Use the peak marker function to determine the maximum amplitude level.

Ensure that the amplitude of all unwanted emissions outside of the authorized frequency band (excluding restricted frequency bands) are attenuated by at least the minimum requirements specified in 11.1 a) or 11.1 b). Report the three highest emissions relative to the limit.

5.4.4 Test Result

Please refer to ANNEX A.3.

5.5 Band Edge (Authorized-band band-edge)

5.5.1 Limit

FCC §15.247(d)

In any 100 kHz bandwidth outside the frequency band in which the spread spectrum or digitally modulated intentional radiator is operating, the radio frequency power that is produced by the intentional radiator shall be at least 20 dB below that in the 100 kHz bandwidth within the band that contains the highest level of the desired power, based on either an RF conducted or a radiated measurement.

5.5.2 Test Setup

See section 4.5.1 for test setup description for the antenna port. The photo of test setup please refer to ANNEX B.

5.5.3 Test Procedure

The following procedures may be used to determine the peak or average field strength or power of an unwanted emission that is within 2 MHz of the authorized band edge. If a peak detector is utilized, use the procedure described in 13.2.1. Use the procedure described in 13.2.2 when using an average detector and the EUT can be configured to transmit continuously (i.e., duty cycle $\geq 98\%$). Use the procedure described in 13.2.3 when using an average detector and the EUT cannot be configured to transmit continuously but the duty cycle is constant (i.e., duty cycle variations are less than ± 2 percent). Use the procedure described in 13.2.4 when using an average detector for those cases where the EUT cannot be configured to transmit continuously and the duty cycle is not constant (duty cycle variations equal or exceed 2 percent).

When using a peak detector to measure unwanted emissions at or near the band edge (within 2 MHz of the authorized band), the following integration procedure can be used.

Set instrument center frequency to the frequency of the emission to be measured (must be within 2 MHz of the authorized band edge).

Set span to 2 MHz

RBW = 100 kHz.

VBW $\geq 3 \times$ RBW.

Detector = peak.

Sweep time = auto.

Trace mode = max hold.

Allow sweep to continue until the trace stabilizes (required measurement time may increase for low duty cycle applications)

Compute the power by integrating the spectrum over 1 MHz using the analyzer's band power measurement function with band limits set equal to the emission frequency (femission) ± 0.5 MHz. If the instrument does not have a band power function, then sum the amplitude levels (in power units) at 100 kHz intervals extending across the 1 MHz spectrum defined by femission ± 0.5 MHz.

5.5.4 Test Result

Please refer to ANNEX A.4.

5.6 Conducted Emission

5.6.1 Limit

FCC §15.207

For an intentional radiator that is designed to be connected to the public utility (AC) power line, the radio frequency voltage that is conducted back onto the AC power line on any frequency within the band 150 kHz to 30 MHz shall not exceed the limits in the following table, as measured using a 50 μ H/50 Ω line impedance stabilization network (LISN).

Frequency range (MHz)	Conducted Limit (dB μ V)	
	Quai-peak	Average
0.15 - 0.50	66 to 56	56 to 46
0.50 - 5	56	46
0.50 - 30	60	50

5.6.2 Test Setup

See section 4.5.2 for test setup description for the AC power supply port. The photo of test setup please refer to ANNEX B.

5.6.3 Test Procedure

The maximum conducted interference is searched using Peak (PK), if the emission levels more than the AV and QP limits, and that have narrow margins from the AV and QP limits will be re-measured with AV and QP detectors. Tests for both L phase and N phase lines of the power mains connected to the EUT are performed. Refer to recorded points and plots below.

Devices subject to Part 15 must be tested for all available U.S. voltages and frequencies (such as a nominal 120 VAC, 50/60 Hz and 240 VAC, 50/60 Hz) for which the device is capable of operation. A device rated for 50/60 Hz operation need not be tested at both frequencies provided the radiated and line conducted emissions are the same at both frequencies.

5.6.4 Test Result

Please refer to ANNEX A.5.

5.7 Radiated Spurious Emission

5.7.1 Limit

FCC §15.209&15.247(d)

Radiated emission outside the frequency band attenuation below the general limits specified in FCC section 15.209(a) is not required. In addition, radiated emissions which fall in the restricted bands, as defined in FCC section 15.205(a), must also comply with the radiated emission limits specified in FCC section 15.209(a).

According to FCC section 15.209 (a), except as provided elsewhere in this subpart, the emissions from an intentional radiator shall not exceed the field strength levels specified in the following table:

Frequency (MHz)	Field Strength ($\mu\text{V}/\text{m}$)	Measurement Distance (m)
0.009 - 0.490	2400/F(kHz)	300
0.490 - 1.705	24000/F(kHz)	30
1.705 - 30.0	30	30
30 - 88	100	3
88 - 216	150	3
216 - 960	200	3
Above 960	500	3

Note:

1. Field Strength (dB $\mu\text{V}/\text{m}$) = 20*log[Field Strength ($\mu\text{V}/\text{m}$)].
2. In the emission tables above, the tighter limit applies at the band edges.
3. For Above 1000 MHz, the emission limit in this paragraph is based on measurement instrumentation employing an average detector, measurement using instrumentation with a peak detector function, corresponding to 20dB above the maximum permitted average limit.
4. For above 1000 MHz, limit field strength of harmonics: 54dBuV/m@3m (AV) and 74dBuV/m@3m (PK).

5.7.2 Test Setup

See section 4.5.3 to 4.5.5 for test setup description for the antenna port. The photo of test setup please refer to ANNEX B.

5.7.3 Test Procedure

Since the emission limits are specified in terms of radiated field strength levels, measurements performed to demonstrate compliance have traditionally relied on a radiated test configuration. Radiated measurements remain the principal method for demonstrating compliance to the specified limits; however antenna-port conducted measurements are also now acceptable to demonstrate compliance (see below for details). When radiated measurements are utilized, test site requirements and procedures for maximizing and measuring radiated emissions that are described in ANSI C63.10 shall be followed.

Antenna-port conducted measurements may also be used as an alternative to radiated measurements

for demonstrating compliance in the restricted frequency bands. If conducted measurements are performed, then proper impedance matching must be ensured and an additional radiated test for cabinet/case spurious emissions is required.

General Procedure for conducted measurements in restricted bands:

- a) Measure the conducted output power (in dBm) using the detector specified (see guidance regarding measurement procedures for determining quasi-peak, peak, and average conducted output power, respectively).
- b) Add the maximum transmit antenna gain (in dBi) to the measured output power level to determine the EIRP level (see guidance on determining the applicable antenna gain)
- c) Add the appropriate maximum ground reflection factor to the EIRP level (6 dB for frequencies ≤ 30 MHz, 4.7 dB for frequencies between 30 MHz and 1000 MHz, inclusive and 0 dB for frequencies > 1000 MHz).
- d) For devices with multiple antenna-ports, measure the power of each individual chain and sum the EIRP of all chains in linear terms (e.g., Watts, mW).
- e) Convert the resultant EIRP level to an equivalent electric field strength using the following relationship:

$$E = \text{EIRP} - 20\log D + 104.8$$

where:

E = electric field strength in dB μ V/m,

EIRP = equivalent isotropic radiated power in dBm

D = specified measurement distance in meters.

- f) Compare the resultant electric field strength level to the applicable limit.
- g) Perform radiated spurious emission test.

Quasi-Peak measurement procedure

The specifications for measurements using the CISPR quasi-peak detector can be found in Publication 16 of the International Special Committee on Radio Frequency Interference (CISPR) of the International Electrotechnical Commission.

As an alternative to CISPR quasi-peak measurement, compliance can be demonstrated to the applicable emission limits using a peak detector.

Peak power measurement procedure:

Peak emission levels are measured by setting the instrument as follows:

- a) RBW = as specified in Table 1.
- b) VBW $\geq 3 \times$ RBW.

- c) Detector = Peak.
- d) Sweep time = auto.
- e) Trace mode = max hold.
- f) Allow sweeps to continue until the trace stabilizes. (Note that the required measurement time may be longer for low duty cycle applications).

Table 1—RBW as a function of frequency

Frequency	RBW
9-150 kHz	200-300 Hz
0.15-30 MHz	9-10 kHz
30-1000 MHz	100-120 kHz
> 1000 MHz	1 MHz

If the peak-detected amplitude can be shown to comply with the average limit, then it is not necessary to perform a separate average measurement.

Trace averaging across on and off times of the EUT transmissions followed by duty cycle correction:

If continuous transmission of the EUT (i.e., duty cycle ≥ 98 percent) cannot be achieved and the duty cycle is constant (i.e., duty cycle variations are less than ± 2 percent), then the following procedure shall be used:

- a) The EUT shall be configured to operate at the maximum achievable duty cycle.
- b) Measure the duty cycle, x , of the transmitter output signal as described in section 6.0.
- c) RBW = 1 MHz (unless otherwise specified).
- d) VBW $\geq 3 \times$ RBW.
- e) Detector = RMS, if $\text{span}/(\# \text{ of points in sweep}) \leq (\text{RBW}/2)$. Satisfying this condition may require increasing the number of points in the sweep or reducing the span. If this condition cannot be satisfied, then the detector mode shall be set to peak.
- f) Averaging type = power (i.e., RMS).
 - 1) As an alternative, the detector and averaging type may be set for linear voltage averaging.
 - 2) Some instruments require linear display mode in order to use linear voltage averaging. Log or dB averaging shall not be used.
- g) Sweep time = auto.
- h) Perform a trace average of at least 100 traces.
- i) A correction factor shall be added to the measurement results prior to comparing to the emission limit in order to compute the emission level that would have been measured had the test been performed at 100 percent duty cycle. The correction factor is computed as follows:

- 1) If power averaging (RMS) mode was used in step f), then the applicable correction factor is $10 \log(1/x)$, where x is the duty cycle.
- 2) If linear voltage averaging mode was used in step f), then the applicable correction factor is $20 \log(1/x)$, where x is the duty cycle.
- 3) If a specific emission is demonstrated to be continuous (≥ 98 percent duty cycle) rather than turning on and off with the transmit cycle, then no duty cycle correction is required for that emission.

NOTE: Reduction of the measured emission amplitude levels to account for operational duty factor is not permitted. Compliance is based on emission levels occurring during transmission - not on an average across on and off times of the transmitter.

Determining the applicable transmit antenna gain:

A conducted power measurement will determine the maximum output power associated with a restricted band emission; however, in order to determine the associated EIRP level, the gain of the transmitting antenna (in dBi) must be added to the measured output power (in dBm).

Since the out-of-band characteristics of the EUT transmit antenna will often be unknown, the use of a conservative antenna gain value is necessary. Thus, when determining the EIRP based on the measured conducted power, the upper bound on antenna gain for a device with a single RF output shall be selected as the maximum in-band gain of the antenna across all operating bands, or 2 dBi, whichever is greater. However, for devices that operate in multiple frequency bands while using the same transmit antenna, the highest gain of the antenna within the operating band nearest in frequency to the restricted band emission being measured may be used in lieu of the overall highest gain when the emission is at a frequency that is within 20 percent of the nearest band edge frequency, but in no case shall a value less than 2 dBi be used.

See KDB 662911 for guidance on calculating the additional array gain term when determining the effective antenna gain for a EUT with multiple outputs occupying the same or overlapping frequency ranges in the same band.

Radiated spurious emission test:

An additional consideration when performing conducted measurements of restricted band emissions is that unwanted emissions radiating from the EUT cabinet, control circuits, power leads, or intermediate circuit elements will likely go undetected in a conducted measurement configuration. To address this concern, a radiated test shall be performed to ensure that emissions emanating from the EUT cabinet (rather than the antenna port) also comply with the applicable limits.

For these cabinet radiated spurious emission measurements the EUT transmit antenna may be replaced with a termination matching the nominal impedance of the antenna. Procedures for performing radiated measurements are specified in ANSI C63.10. All detected emissions shall comply with the applicable limits.

The measurement frequency range is from 30MHz to the 10th harmonic of the fundamental frequency. The Turn Table is actuated to turn from 0° to 360° , and both horizontal and vertical polarizations of the

Test Antenna are used to find the maximum radiated power. Mid channels on all channel bandwidth verified. Only the worst RB size/offset presented.

The power of the EUT transmitting frequency should be ignored.

All Spurious Emission tests were performed in X, Y, Z axis direction. And only the worst axis test condition was recorded in this test report.

Use the following spectrum analyzer settings:

Span = wide enough to fully capture the emission being measured

RBW = 1 MHz for $f \geq 1$ GHz, 100 kHz for $f < 1$ GHz

VBW \geq RBW

Sweep = auto

Detector function = peak

Trace = max hold

5.7.4 Test Result

Please refer to ANNEX A.6.

5.8 Band Edge (Restricted-band band-edge)

5.8.1 Limit

FCC §15.209&15.247(d)

Radiated emission outside the frequency band attenuation below the general limits specified in FCC section 15.209(a) is not required. In addition, radiated emissions which fall in the restricted bands, as defined in FCC section 15.205(a), must also comply with the radiated emission limits specified in FCC section 15.209(a).

5.8.2 Test Setup

See section 4.5.3 to 4.5.5 for test setup description for the antenna port. The photo of test setup please refer to ANNEX B.

5.8.3 Test Procedure

The measurement frequency range is from 9 kHz to the 10th harmonic of the fundamental frequency. The Turn Table is actuated to turn from 0° to 360°, and both horizontal and vertical polarizations of the Test Antenna are used to find the maximum radiated power. Mid channels on all channel bandwidth verified. Only the worst RB size/offset presented.

The power of the EUT transmitting frequency should be ignored.

All Spurious Emission tests were performed in X, Y, Z axis direction. And only the worst axis test condition was recorded in this test report.

Use the following spectrum analyzer settings:

Span = wide enough to fully capture the emission being measured

RBW = 1 MHz for $f \geq 1$ GHz, 100 kHz for $f < 1$ GHz

VBW \geq RBW

Sweep = auto

Detector function = peak

Trace = max hold

For measurement below 1GHz, If the emission level of the EUT measured by the peak detector is 3 dB lower than the applicable limit, the peak emission level will be reported, Otherwise, the emission measurement will be repeated using the quasi-peak detector and reported.

For transmitters operating above 1 GHz repeat the measurement with an average detector.

5.8.4 Test Result

Please refer to ANNEX A.7.

5.9 Power Spectral density (PSD)

5.9.1 Limit

FCC §15.247(e)

The same method of determining the conducted output power shall be used to determine the power spectral density. If a peak output power is measured, then a peak power spectral density measurement is required. If an average output power is measured, then an average power spectral density measurement should be used.

The transmitter power spectral density conducted from the transmitter to the antenna shall not be greater than 8 dBm in any 3 kHz band during any time interval of continuous transmission. This power spectral density shall be determined in accordance with the provisions of Section 5.4(4), (i.e. the power spectral density shall be determined using the same method as is used to determine the conducted output power).

5.9.2 Test Setup

See section 4.5.1 (Diagram 1) for test setup description for the antenna port. The photo of test setup please refer to ANNEX B.

5.9.3 Test Procedure

Set analyzer center frequency to DTS channel center frequency.

Set the span to 1.5 times the DTS bandwidth.

Set the RBW to: $3 \text{ kHz} \leq \text{RBW} \leq 100 \text{ kHz}$.

Set the VBW ≥ 3 RBW.

Detector = peak.

Sweep time = auto couple.

Trace mode = max hold.

Allow trace to fully stabilize.

Use the peak marker function to determine the maximum amplitude level within the RBW.

If measured value exceeds limit, reduce RBW (no less than 3 kHz) and repeat.

5.9.4 Test Result

Please refer to ANNEX A.8.

ANNEX A TEST RESULT

A.1 Output Power, Duty Cycle

Peak Power Test Data

ANT 0:

Channel	Measured Output Peak Power		Limit		Verdict
	GFSK (BLE 1Mbps)		dBm	mW	
	dBm	mW			
Low Channel	7.22	5.27	30	1000	Pass
Middle Channel	7.18	5.22			Pass
High Channel	5.12	3.25			Pass

Channel	Measured Output Peak Power		Limit		Verdict
	GFSK (BLE 2Mbps)		dBm	mW	
	dBm	mW			
Low Channel	7.70	5.89	30	1000	Pass
Middle Channel	7.49	5.61			Pass
High Channel	5.85	3.85			Pass

ANT 1:

Channel	Measured Output Peak Power		Limit		Verdict
	GFSK (BLE 1Mbps)		dBm	mW	
	dBm	mW			
Low Channel	5.36	3.44	30	1000	Pass
Middle Channel	6.03	4.01			Pass
High Channel	5.37	3.44			Pass

Channel	Measured Output Peak Power		Limit		Verdict
	GFSK (BLE 2Mbps)		dBm	mW	
	dBm	mW			
Low Channel	6.10	4.07	30	1000	Pass
Middle Channel	6.40	4.37			Pass
High Channel	5.97	3.95			Pass

Test Plots

ANT 0:

GFSK (BLE 1Mbps) LOW CHANNEL

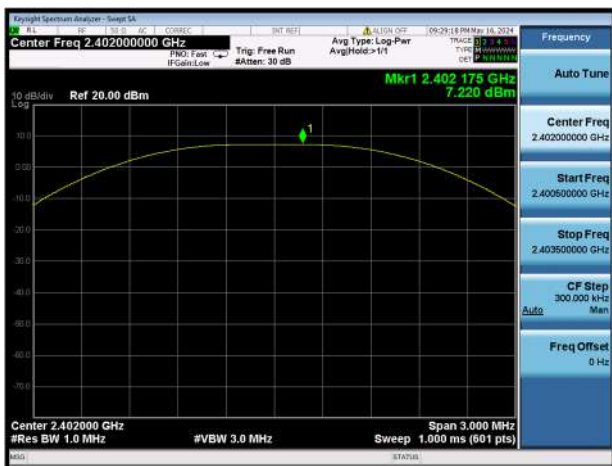

GFSK (BLE 1Mbps) MIDDLE CHANNEL

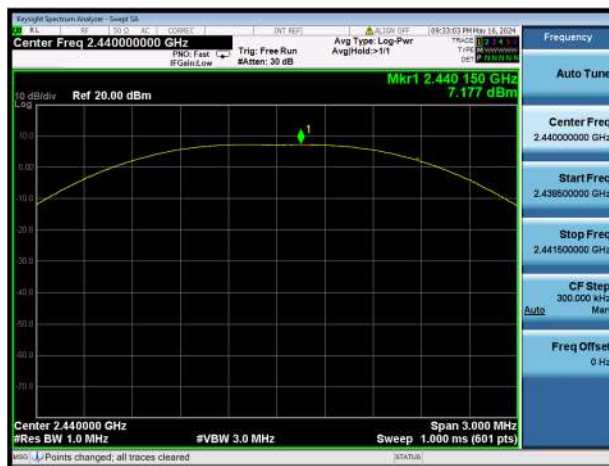

GFSK (BLE 1Mbps) HIGH CHANNEL



GFSK (BLE 2Mbps) LOW CHANNEL

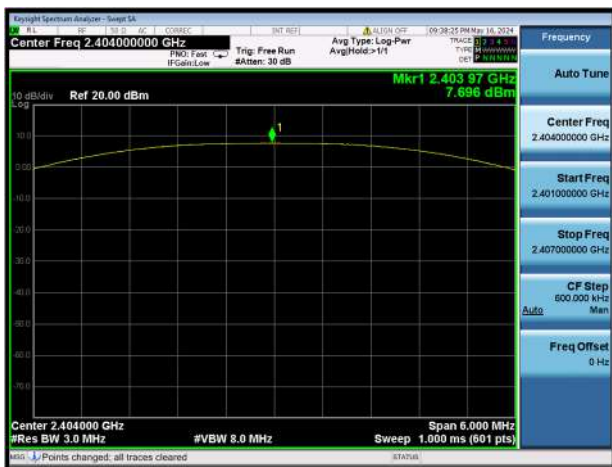

GFSK (BLE 2Mbps) MIDDLE CHANNEL



GFSK (BLE 2Mbps) HIGH CHANNEL

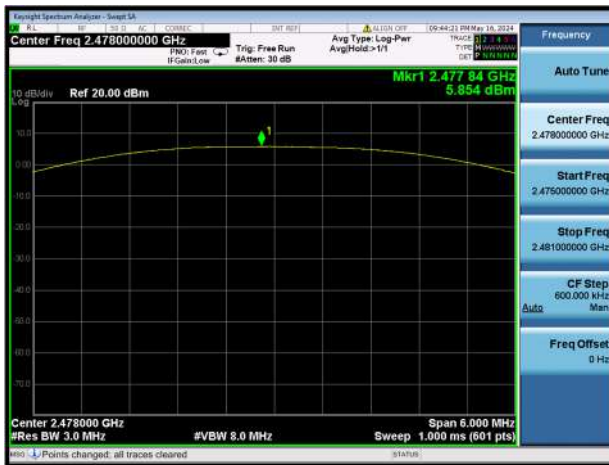

ANT 1:

GFSK (BLE 1Mbps) LOW CHANNEL



GFSK (BLE 1Mbps) MIDDLE CHANNEL



GFSK (BLE 1Mbps) HIGH CHANNEL



GFSK (BLE 2Mbps) LOW CHANNEL

GFSK (BLE 2Mbps) MIDDLE CHANNEL



GFSK (BLE 2Mbps) HIGH CHANNEL



Duty Cycle Test Data

Band	On Time (ms)	On+Off Time (ms)	Duty Cycle (%)
GFSK (BLE 1Mbps)	0.390	0.625	62.40%
GFSK (BLE 2Mbps)	0.205	0.625	32.80%

Test Plots

ANT 0:

GFSK (BLE 1Mbps)

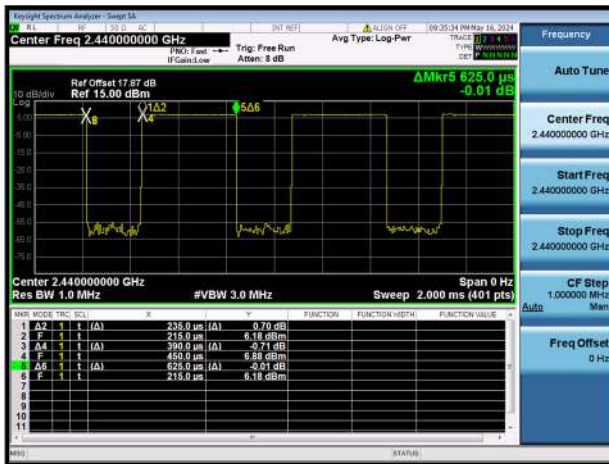

GFSK (BLE 2Mbps)

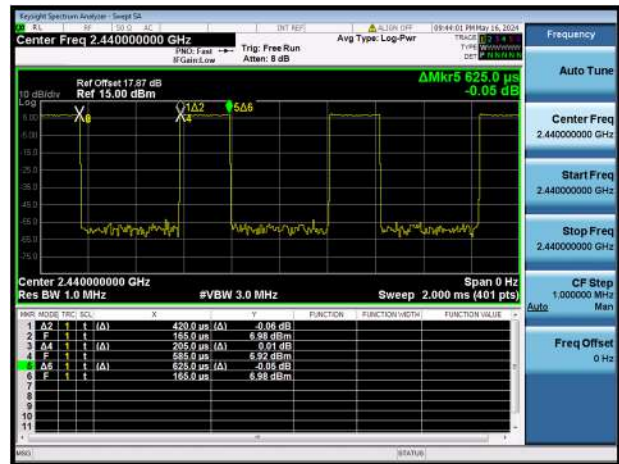

ANT 1:

GFSK (BLE 1Mbps)

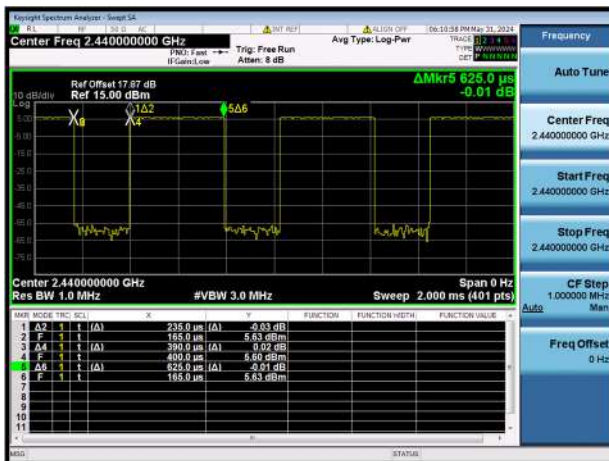

GFSK (BLE 2Mbps)

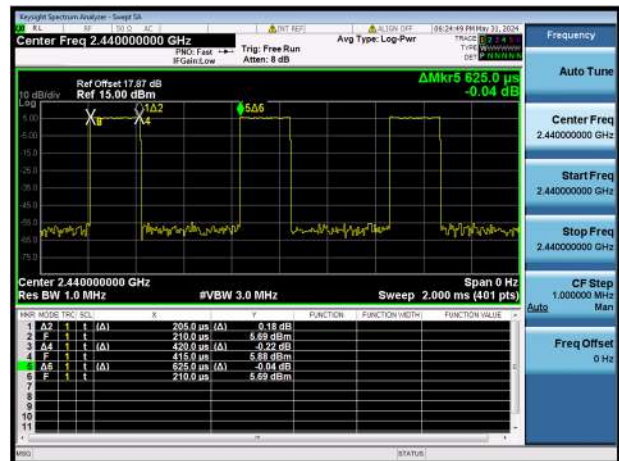

A.2 Occupied Bandwidth

Test Data

ANT 0:

Test Mode	GFSK (BLE 1Mbps)		
Channel	6 dB Bandwidth (kHz)	99% Bandwidth (kHz)	6 dB Bandwidth Limits (kHz)
Low Channel	675.000	1028.700	≥500
Middle Channel	675.000	1018.400	≥500
High Channel	675.000	1015.800	≥500

Test Mode	GFSK (BLE 2Mbps)		
Channel	6 dB Bandwidth (kHz)	99% Bandwidth (kHz)	6 dB Bandwidth Limits (kHz)
Low Channel	1185.000	2011.000	≥500
Middle Channel	1170.000	2009.700	≥500
High Channel	1170.000	1996.800	≥500

ANT 1:

Test Mode	GFSK (BLE 1Mbps)		
Channel	6 dB Bandwidth (kHz)	99% Bandwidth (kHz)	6 dB Bandwidth Limits (kHz)
Low Channel	675.000	1034.400	≥500
Middle Channel	675.000	1034.300	≥500
High Channel	675.000	1032.100	≥500

Test Mode	GFSK (BLE 2Mbps)		
Channel	6 dB Bandwidth (kHz)	99% Bandwidth (kHz)	6 dB Bandwidth Limits (kHz)
Low Channel	1185.000	2017.900	≥500
Middle Channel	1185.000	2016.100	≥500
High Channel	1170.000	2010.400	≥500

Test Plots

ANT 0:

6 dB Bandwidth

GFSK (BLE 1Mbps) LOW CHANNEL

GFSK (BLE 1Mbps) MIDDLE CHANNEL



GFSK (BLE 1Mbps) HIGH CHANNEL



GFSK (BLE 2Mbps) LOW CHANNEL

GFSK (BLE 2Mbps) MIDDLE CHANNEL



GFSK (BLE 2Mbps) HIGH CHANNEL



99% Bandwidth

GFSK (BLE 1Mbps) LOW CHANNEL



GFSK (BLE 1Mbps) MIDDLE CHANNEL



GFSK (BLE 1Mbps) HIGH CHANNEL



GFSK (BLE 2Mbps) LOW CHANNEL



GFSK (BLE 2Mbps) MIDDLE CHANNEL



GFSK (BLE 2Mbps) HIGH CHANNEL



ANT 1:

6 dB Bandwidth

GFSK (BLE 1Mbps) LOW CHANNEL



GFSK (BLE 1Mbps) MIDDLE CHANNEL



GFSK (BLE 1Mbps) HIGH CHANNEL



GFSK (BLE 2Mbps) LOW CHANNEL



GFSK (BLE 2Mbps) MIDDLE CHANNEL



GFSK (BLE 2Mbps) HIGH CHANNEL



99% Bandwidth

GFSK (BLE 1Mbps) LOW CHANNEL



GFSK (BLE 1Mbps) MIDDLE CHANNEL



GFSK (BLE 1Mbps) HIGH CHANNEL



GFSK (BLE 2Mbps) LOW CHANNEL



GFSK (BLE 2Mbps) MIDDLE CHANNEL



GFSK (BLE 2Mbps) HIGH CHANNEL



A.3 Conducted Spurious Emissions

Test Data

ANT 0:

GFSK (BLE 1Mbps)				
Channel	Measured Max. Out of Band Emission (dBm)	Limit (dBm)		Verdict
		Carrier Level	Calculated 20 dBc Limit	
Low Channel	-24.49	6.70	-13.30	Pass
Middle Channel	-23.74	6.65	-13.35	Pass
High Channel	-24.70	4.56	-15.44	Pass

GFSK (BLE 2Mbps)				
Channel	Measured Max. Out of Band Emission (dBm)	Limit (dBm)		Verdict
		Carrier Level	Calculated 20 dBc Limit	
Low Channel	-23.82	6.89	-13.11	Pass
Middle Channel	-23.70	6.65	-13.35	Pass
High Channel	-24.68	4.94	-15.06	Pass

ANT 1:

GFSK (BLE 1Mbps)				
Channel	Measured Max. Out of Band Emission (dBm)	Limit (dBm)		Verdict
		Carrier Level	Calculated 20 dBc Limit	
Low Channel	-23.33	4.94	-15.06	Pass
Middle Channel	-22.92	4.59	-15.41	Pass
High Channel	-23.81	4.94	-15.06	Pass

GFSK (BLE 2Mbps)				
Channel	Measured Max. Out of Band Emission (dBm)	Limit (dBm)		Verdict
		Carrier Level	Calculated 20 dBc Limit	
Low Channel	-23.97	5.39	-14.62	Pass
Middle Channel	-23.96	5.64	-14.36	Pass
High Channel	-24.32	5.34	-14.66	Pass

Test Plots

ANT 0:

GFSK (BLE 1Mbps) LOW CHANNEL,
CARRIER LEVEL



GFSK (BLE 1Mbps) LOW CHANNEL,
SPURIOUS 30 MHz ~ 3 GHz

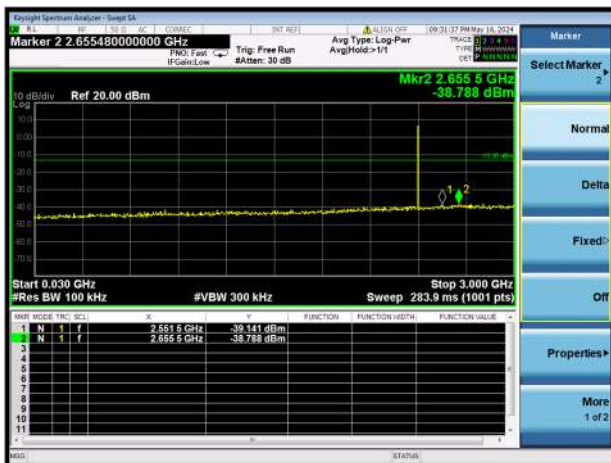

GFSK (BLE 1Mbps) LOW CHANNEL,
SPURIOUS 2 GHz ~ 25 GHz



GFSK (BLE 1Mbps) MIDDLE CHANNEL,
CARRIER LEVEL



GFSK (BLE 1Mbps) MIDDLE CHANNEL,
SPURIOUS 30 MHz ~ 3 GHz

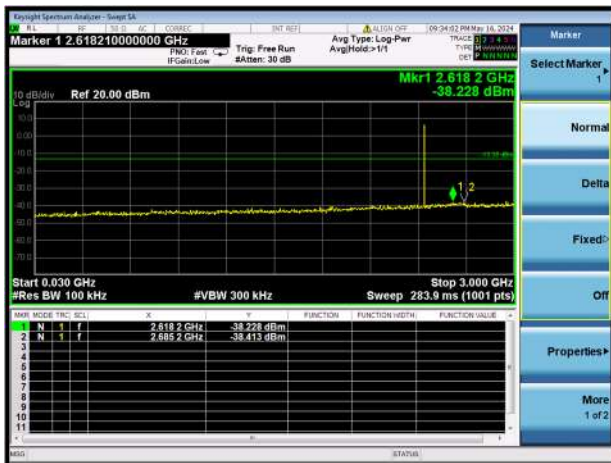

GFSK (BLE 1Mbps) MIDDLE CHANNEL,
SPURIOUS 2 GHz ~ 25 GHz



GFSK (BLE 1Mbps) HIGH CHANNEL,
CARRIER LEVEL



GFSK (BLE 1Mbps) HIGH CHANNEL,
SPURIOUS 30 MHz ~ 3 GHz

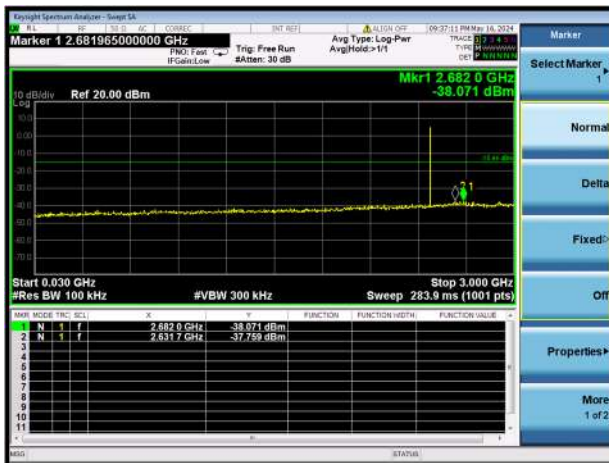

GFSK (BLE 1Mbps) HIGH CHANNEL,
SPURIOUS 2 GHz ~ 25 GHz



GFSK (BLE 2Mbps) LOW CHANNEL,
CARRIER LEVEL



GFSK (BLE 2Mbps) LOW CHANNEL,
SPURIOUS 30 MHz ~ 3 GHz

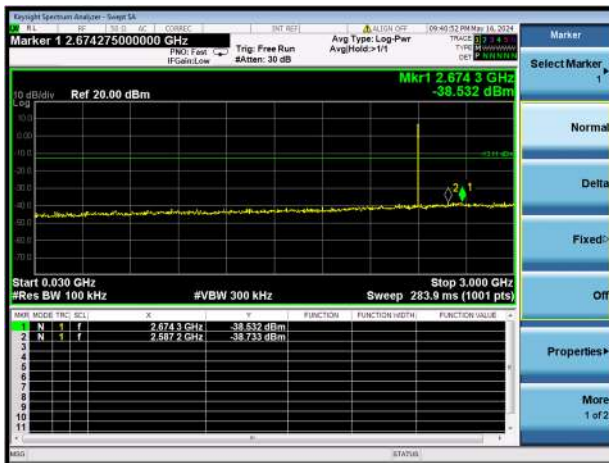

GFSK (BLE 2Mbps) LOW CHANNEL,
SPURIOUS 2 GHz ~ 25 GHz



GFSK (BLE 2Mbps) MIDDLE CHANNEL,
CARRIER LEVEL



GFSK (BLE 2Mbps) MIDDLE CHANNEL,
SPURIOUS 30 MHz ~ 3 GHz

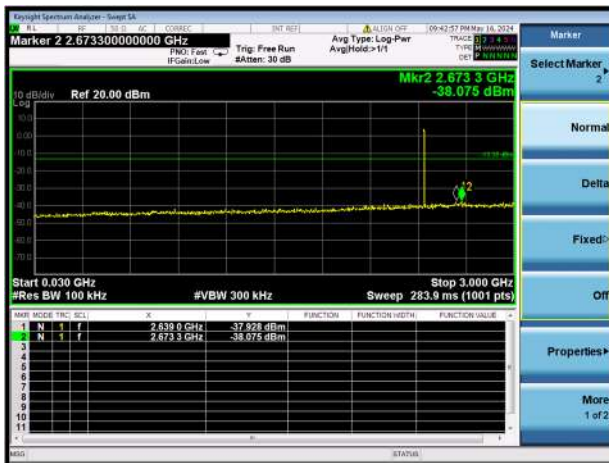

GFSK (BLE 2Mbps) MIDDLE CHANNEL,
SPURIOUS 2 GHz ~ 25 GHz



GFSK (BLE 2Mbps) HIGH CHANNEL,
CARRIER LEVEL



GFSK (BLE 2Mbps) HIGH CHANNEL,
SPURIOUS 30 MHz ~ 3 GHz

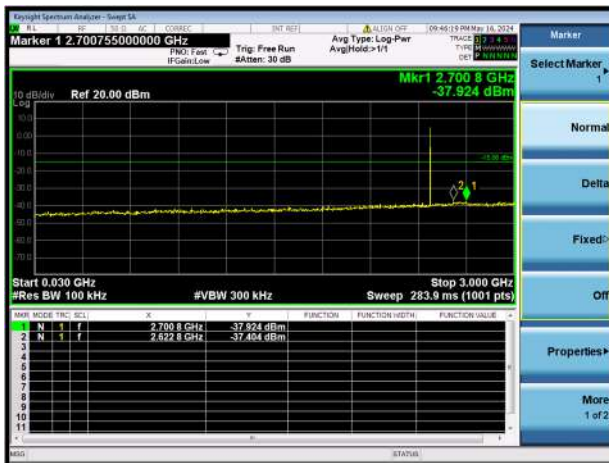

GFSK (BLE 2Mbps) HIGH CHANNEL,
SPURIOUS 2 GHz ~ 25 GHz



ANT 1:

GFSK (BLE 1Mbps) LOW CHANNEL,
CARRIER LEVEL

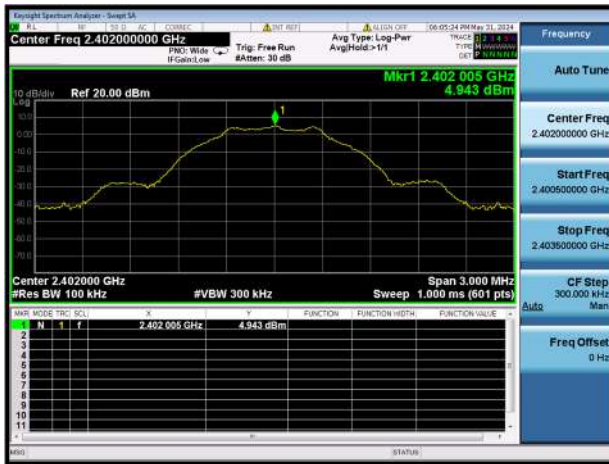

GFSK (BLE 1Mbps) LOW CHANNEL,
SPURIOUS 30 MHz ~ 3 GHz

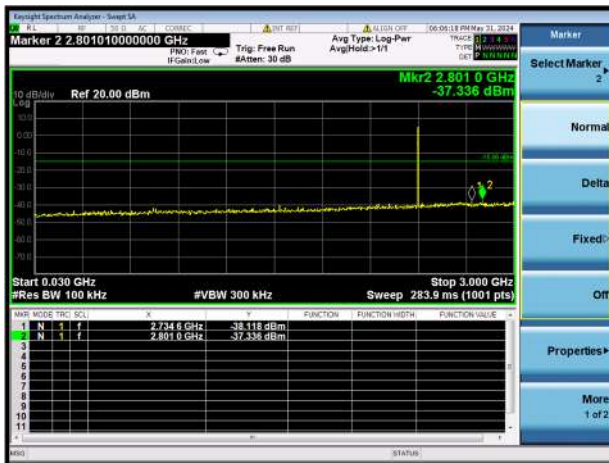

GFSK (BLE 1Mbps) LOW CHANNEL,
SPURIOUS 2 GHz ~ 25 GHz



GFSK (BLE 1Mbps) MIDDLE CHANNEL,
CARRIER LEVEL



GFSK (BLE 1Mbps) MIDDLE CHANNEL,
SPURIOUS 30 MHz ~ 3 GHz

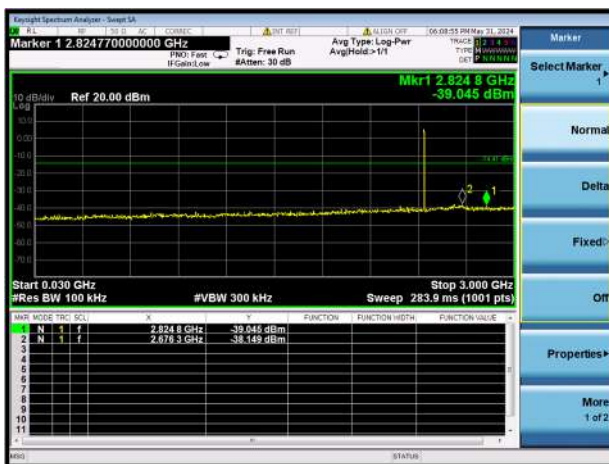

GFSK (BLE 1Mbps) MIDDLE CHANNEL,
SPURIOUS 2 GHz ~ 25 GHz



GFSK (BLE 1Mbps) HIGH CHANNEL,
CARRIER LEVEL

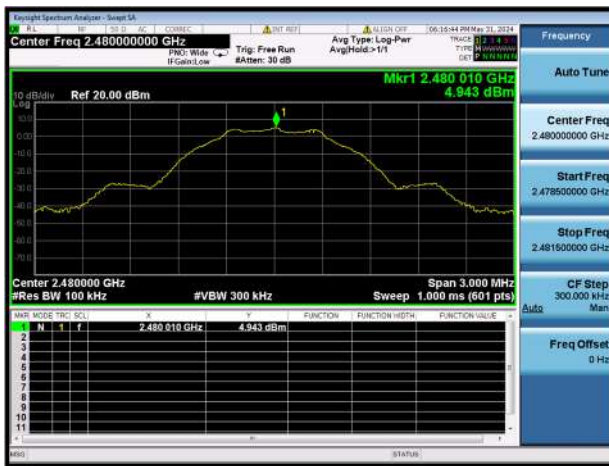

GFSK (BLE 1Mbps) HIGH CHANNEL,
SPURIOUS 30 MHz ~ 3 GHz

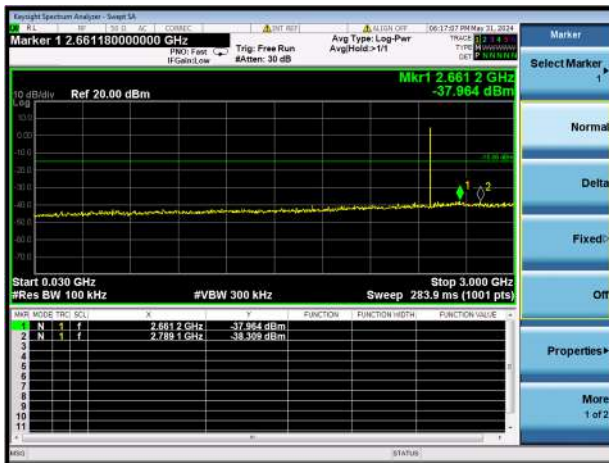

GFSK (BLE 1Mbps) HIGH CHANNEL,
SPURIOUS 2 GHz ~ 25 GHz



GFSK (BLE 2Mbps) LOW CHANNEL,
CARRIER LEVEL



GFSK (BLE 2Mbps) LOW CHANNEL,
SPURIOUS 30 MHz ~ 3 GHz

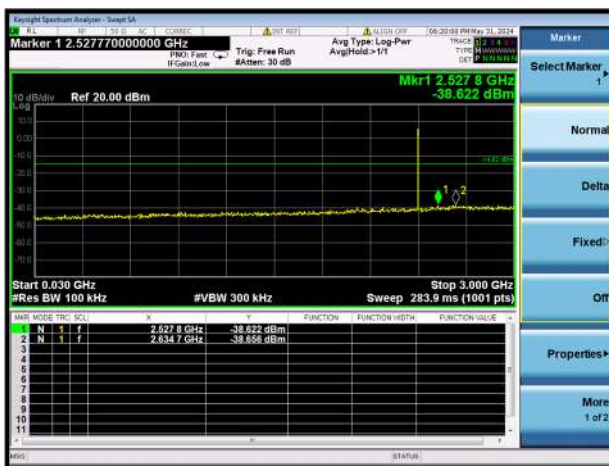

GFSK (BLE 2Mbps) LOW CHANNEL,
SPURIOUS 2 GHz ~ 25 GHz



GFSK (BLE 2Mbps) MIDDLE CHANNEL,
CARRIER LEVEL

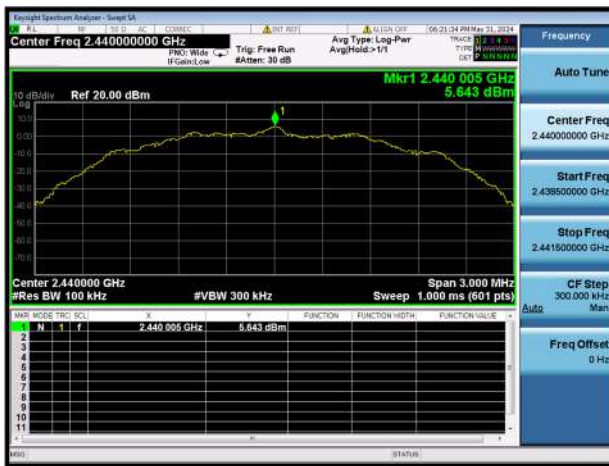

GFSK (BLE 2Mbps) MIDDLE CHANNEL,
SPURIOUS 30 MHz ~ 3 GHz

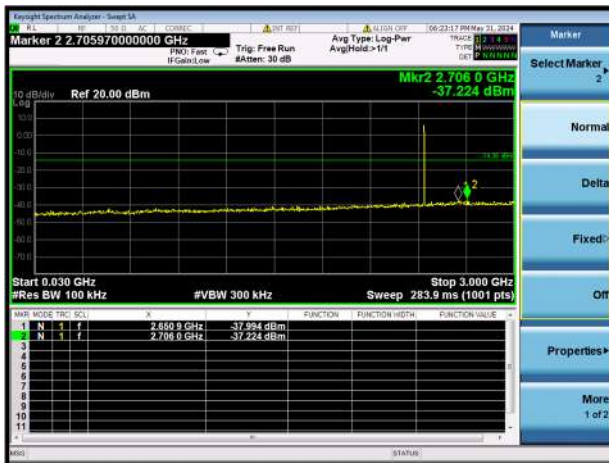

GFSK (BLE 2Mbps) MIDDLE CHANNEL,
SPURIOUS 2 GHz ~ 25 GHz



GFSK (BLE 2Mbps) HIGH CHANNEL,
CARRIER LEVEL



GFSK (BLE 2Mbps) HIGH CHANNEL,
SPURIOUS 30 MHz ~ 3 GHz

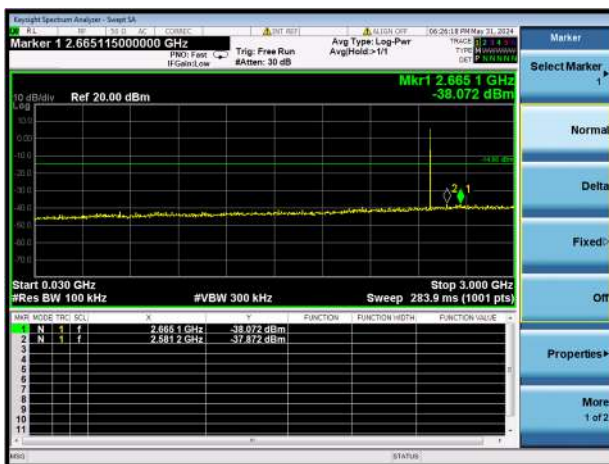

GFSK (BLE 2Mbps) HIGH CHANNEL,
SPURIOUS 2 GHz ~ 25 GHz



A.4 Band Edge (Authorized-band band-edge)

Note: The lowest and highest channels are tested to verify the band edge emissions. Please refer to the following the plots for emissions values.

Test Data

ANT 0:

GFSK (BLE 1Mbps)				
Channel	Measured Max. Band Edge Emission (dBm)	Limit (dBm)		Verdict
		Carrier Level	Calculated 20 dBc Limit	
Low Channel	-40.10	6.70	-13.30	Pass
High Channel	-45.62	4.56	-15.44	Pass

GFSK (BLE 2Mbps)				
Channel	Measured Max. Band Edge Emission (dBm)	Limit (dBm)		Verdict
		Carrier Level	Calculated 20 dBc Limit	
Low Channel	-39.94	6.89	-13.11	Pass
High Channel	-46.41	4.94	-15.06	Pass

ANT 1:

GFSK (BLE 1Mbps)				
Channel	Measured Max. Band Edge Emission (dBm)	Limit (dBm)		Verdict
		Carrier Level	Calculated 20 dBc Limit	
Low Channel	-40.17	4.94	-15.06	Pass
High Channel	-45.92	4.94	-15.06	Pass

GFSK (BLE 2Mbps)				
Channel	Measured Max. Band Edge Emission (dBm)	Limit (dBm)		Verdict
		Carrier Level	Calculated 20 dBc Limit	
Low Channel	-40.07	5.39	-14.62	Pass
High Channel	-46.92	5.34	-14.66	Pass

Test Plots

ANT 0:

GFSK (BLE 1Mbps) LOW CHANNEL, CARRIER LEVEL



GFSK (BLE 1Mbps) LOW CHANNEL, BAND EDGE

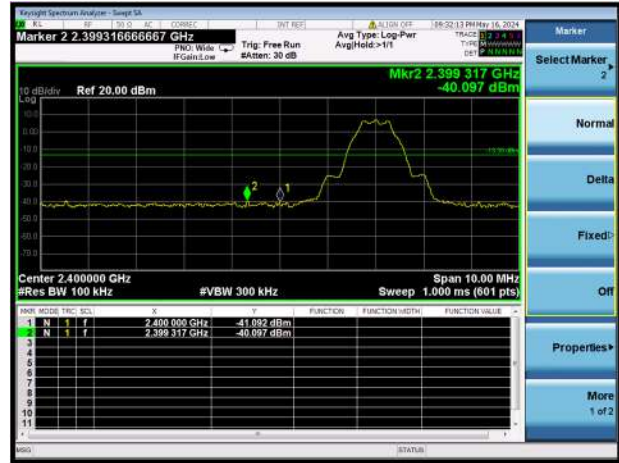

GFSK (BLE 1Mbps) HIGH CHANNEL, CARRIER LEVEL



GFSK (BLE 1Mbps) HIGH CHANNEL, BAND EDGE

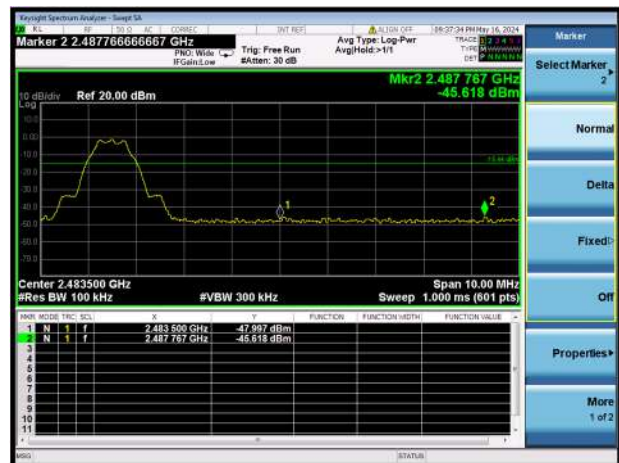

GFSK (BLE 2Mbps) LOW CHANNEL, CARRIER LEVEL



GFSK (BLE 2Mbps) LOW CHANNEL, BAND EDGE



GFSK (BLE 2Mbps) HIGH CHANNEL, CARRIER LEVEL



GFSK (BLE 2Mbps) HIGH CHANNEL, BAND EDGE

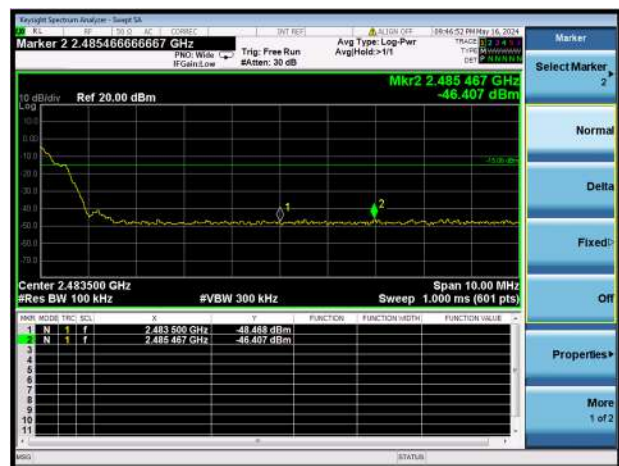

ANT 1:

GFSK (BLE 1Mbps) LOW CHANNEL, CARRIER LEVEL

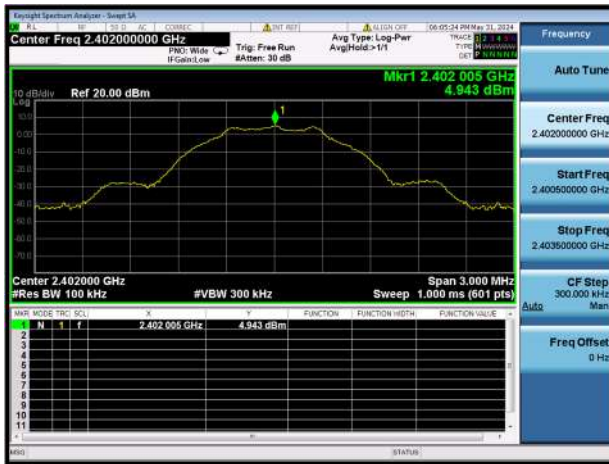

GFSK (BLE 1Mbps) LOW CHANNEL, BAND EDGE

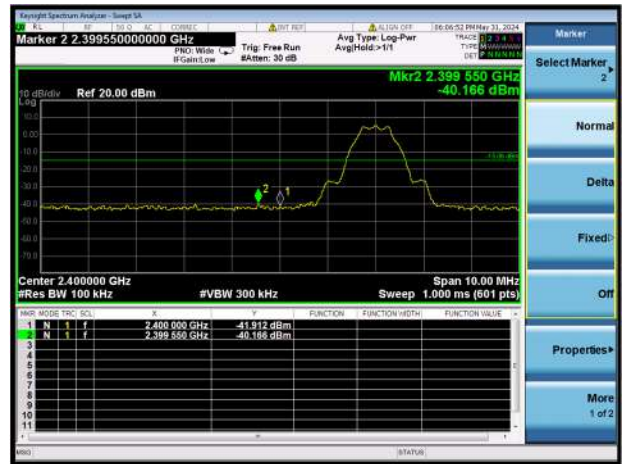

GFSK (BLE 1Mbps) HIGH CHANNEL, CARRIER LEVEL

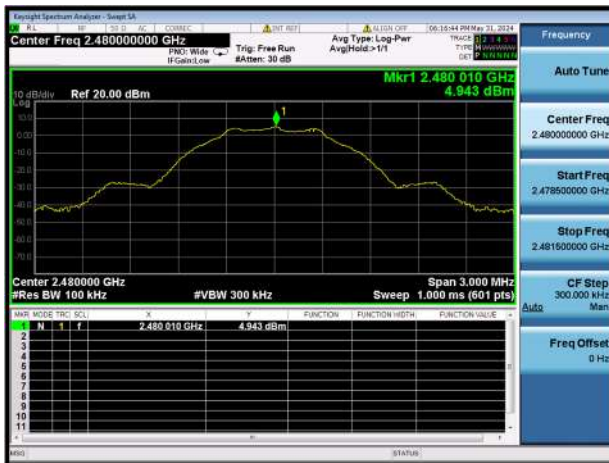

GFSK (BLE 1Mbps) HIGH CHANNEL, BAND EDGE

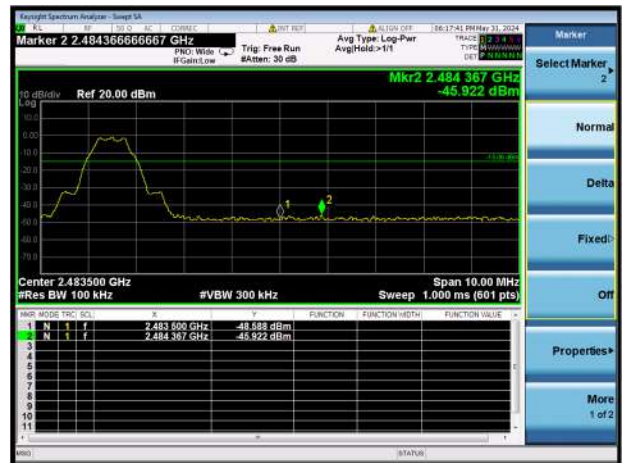

GFSK (BLE 2Mbps) LOW CHANNEL, CARRIER LEVEL



GFSK (BLE 2Mbps) LOW CHANNEL, BAND EDGE

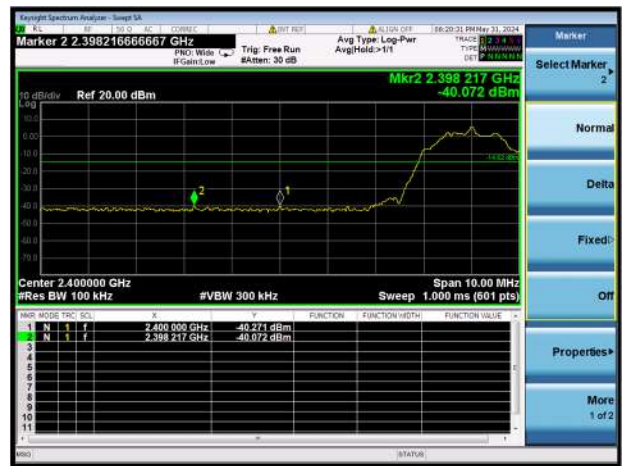

GFSK (BLE 2Mbps) HIGH CHANNEL, CARRIER LEVEL



GFSK (BLE 2Mbps) HIGH CHANNEL, BAND EDGE

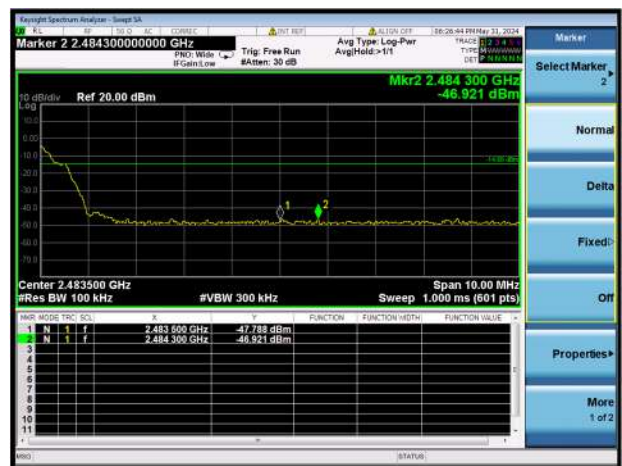

A.5 Conducted Emissions

Note ¹: The EUT is working in the Normal link mode. All modes have been tested and normal link mode is worst.

Note ²: Devices subject to Part 15 must be tested for all available U.S. voltages and frequencies (such as a nominal 120 VAC, 60 Hz and 240 VAC, 50 Hz) for which the device is capable of operation. So, The configuration 120 VAC, 60 Hz and 240 VAC, 50 Hz were tested respectively, but only the worst configuration (120 VAC, 60 Hz) shown here.

Note ³: Results (dBuV) = Original reading level of Spectrum Analyzer (dBuV) + Factor (dB)

Test Data and Plots

PHASE L

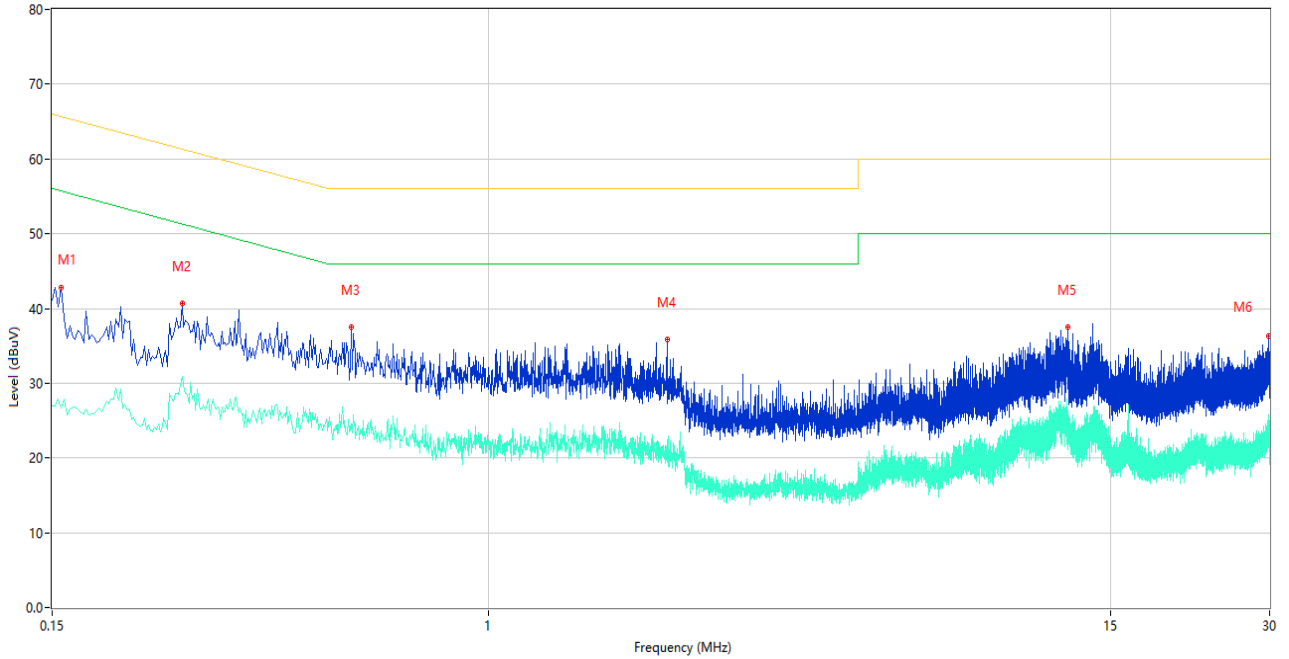

No.	Frequency (MHz)	Results (dBuV)	Factor (dB)	Limit (dBuV)	Margin (dB)	Detector	Line	Verdict
1	0.156	42.77	10.10	65.67	22.90	Peak	L	Pass
1**	0.156	26.67	10.10	55.67	29.00	AV	L	Pass
2	0.264	40.62	10.06	61.30	20.68	Peak	L	Pass
2**	0.264	30.82	10.06	51.30	20.48	AV	L	Pass
3	0.552	37.47	10.49	56.00	18.53	Peak	L	Pass
3**	0.552	24.59	10.49	46.00	21.41	AV	L	Pass
4	2.178	35.79	10.68	56.00	20.21	Peak	L	Pass
4**	2.178	21.84	10.68	46.00	24.16	AV	L	Pass
5	12.448	37.48	11.98	60.00	22.52	Peak	L	Pass
5**	12.448	25.59	11.98	50.00	24.41	AV	L	Pass
6	29.910	36.36	14.61	60.00	23.64	Peak	L	Pass
6**	29.910	23.67	14.61	50.00	26.33	AV	L	Pass

PHASE N

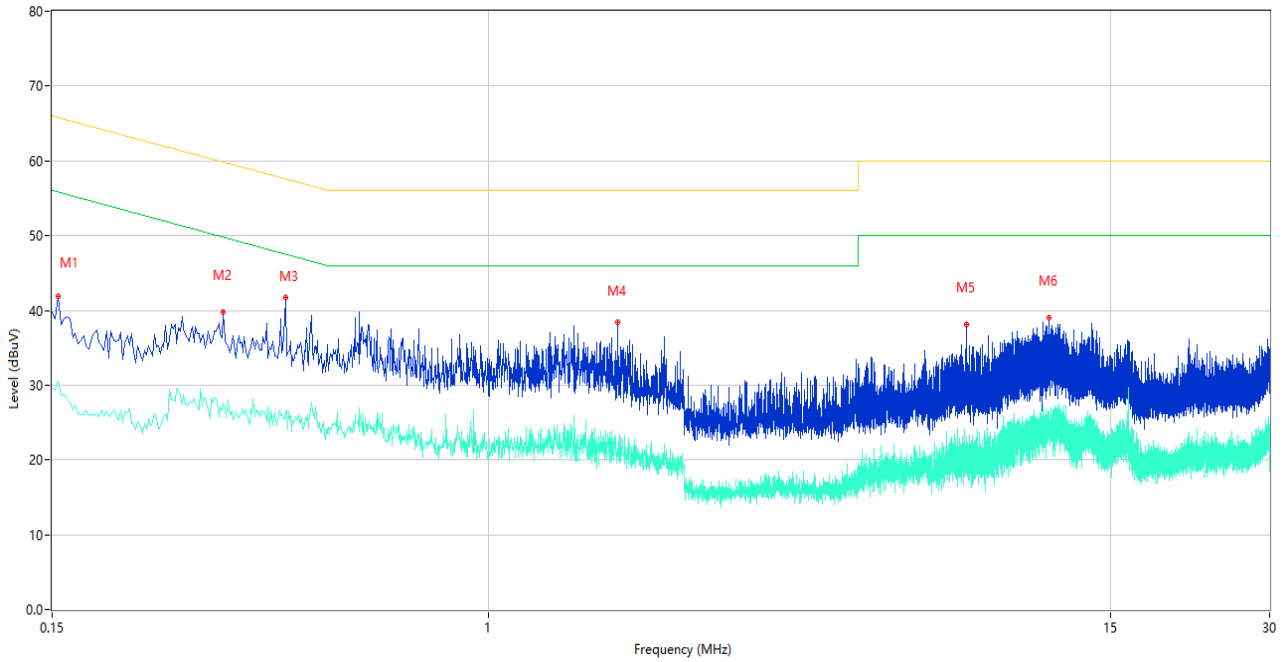

No.	Frequency (MHz)	Results (dBuV)	Factor (dB)	Limit (dBuV)	Margin (dB)	Detector	Line	Verdict
1	0.154	41.84	10.11	65.78	23.94	Peak	N	Pass
1**	0.154	30.56	10.11	55.78	25.22	AV	N	Pass
2	0.316	39.76	10.04	59.81	20.05	Peak	N	Pass
2**	0.316	27.60	10.04	49.81	22.21	AV	N	Pass
3	0.414	41.76	10.63	57.57	15.81	Peak	N	Pass
3**	0.414	26.39	10.63	47.57	21.18	AV	N	Pass
4	1.760	38.46	10.52	56.00	17.54	Peak	N	Pass
4**	1.760	21.20	10.52	46.00	24.80	AV	N	Pass
5	8.006	38.06	11.26	60.00	21.94	Peak	N	Pass
5**	8.006	23.08	11.26	50.00	26.92	AV	N	Pass
6	11.508	39.05	11.88	60.00	20.95	Peak	N	Pass
6**	11.508	25.92	11.88	50.00	24.08	AV	N	Pass

A.6 Radiated Spurious Emission

Note ¹: The symbol of "--" in the table which means not application.

Note ²: For the test data above 1 GHz, according the ANSI C63.4-2014, where limits are specified for both average and peak (or quasi-peak) detector functions, if the peak (or quasi-peak) measured value complies with the average limit, it is unnecessary to perform an average measurement.

Note ³: The low frequency, which started from 9 kHz to 30 MHz, was pre-scanned and the result which was 20 dB lower than the limit line per 15.31(o) was not reported.

Note ⁴: The EUT is working in the Normal link mode below 1 GHz. All modes have been tested and BLE 1M-Low channel mode is the worst.

Note ⁵: Results (dBuV/m) = Original reading level of Spectrum Analyzer (dBuV/m) + Factor (dB)

Test Data and Plots

30 MHz to 1 GHz, ANT H

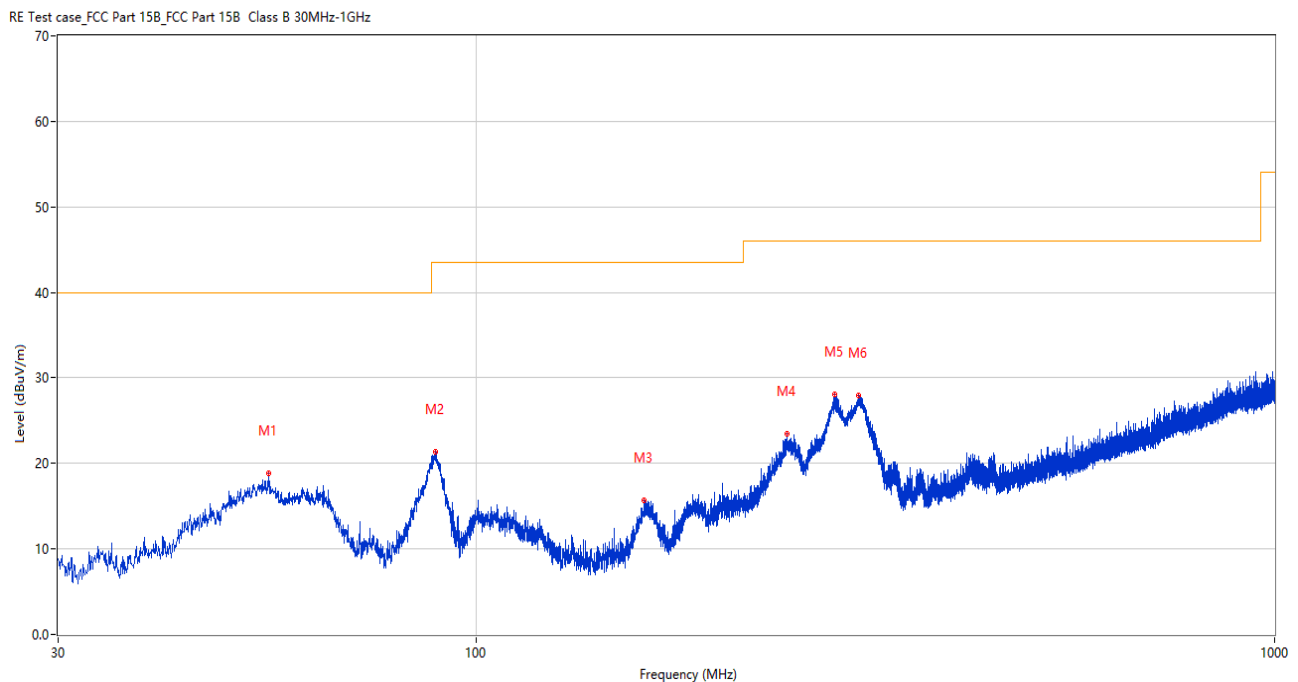

No.	Frequency (MHz)	Results (dBuV/m)	Factor (dB)	Limit (dBuV/m)	Margin (dB)	Detector	Table (Degree)	Height (cm)	Antenna	Verdict
1	54.977	18.80	-25.78	40.0	21.20	Peak	8.00	100	Horizontal	Pass
2	88.976	21.39	-28.85	43.5	22.11	Peak	155.00	200	Horizontal	Pass
3	162.599	15.70	-29.48	43.5	27.80	Peak	133.00	200	Horizontal	Pass
4	245.194	23.42	-25.04	46.0	22.58	Peak	59.00	100	Horizontal	Pass
5	281.375	28.05	-24.15	46.0	17.95	Peak	49.00	100	Horizontal	Pass
6	301.794	27.91	-23.75	46.0	18.09	Peak	218.00	100	Horizontal	Pass

30 MHz to 1 GHz, ANT V

RE Test case_FCC Part 15B_FCC Part 15B Class B 30MHz-1GHz

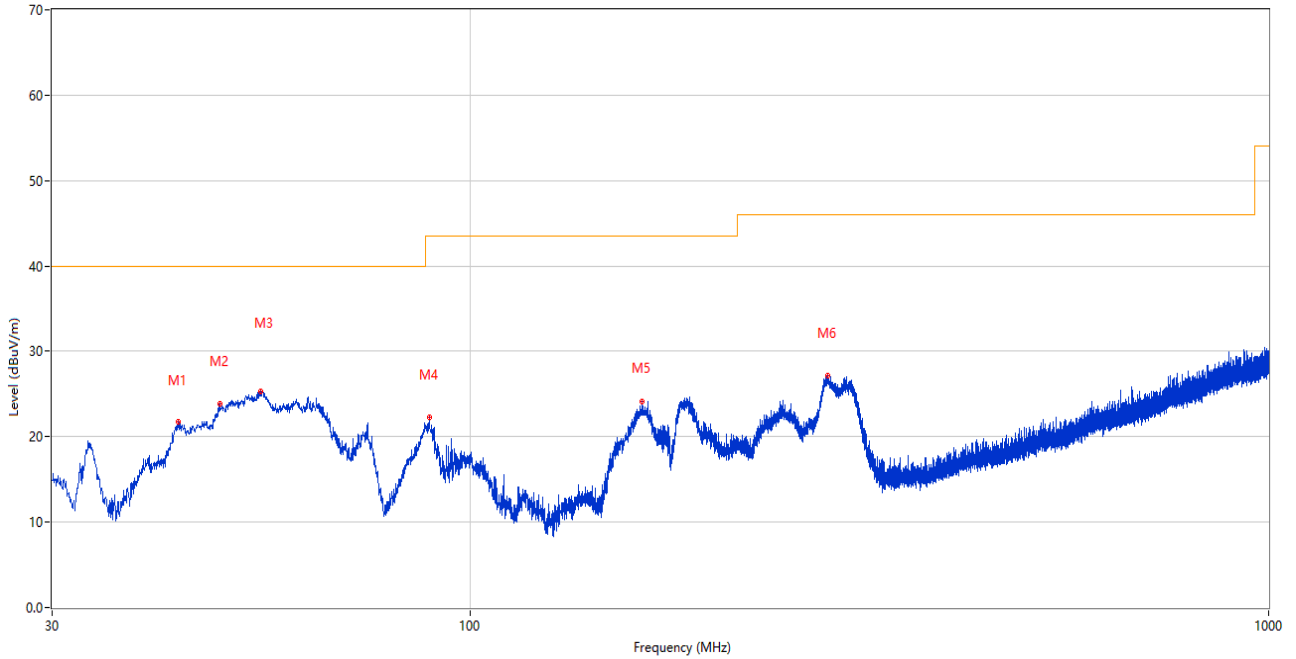

No.	Frequency (MHz)	Results (dBuV/m)	Factor (dB)	Limit (dBuV/m)	Margin (dB)	Detector	Table (Degree)	Height (cm)	Antenna	Verdict
1	43.095	21.70	-25.79	40.0	18.30	Peak	2.00	100	Vertical	Pass
2	48.624	23.82	-25.35	40.0	16.18	Peak	15.00	100	Vertical	Pass
3	54.735	25.29	-25.69	40.0	14.71	Peak	316.00	100	Vertical	Pass
4	88.927	22.23	-28.86	43.5	21.27	Peak	59.00	100	Vertical	Pass
5	164.442	24.14	-29.34	43.5	19.36	Peak	228.00	100	Vertical	Pass
6	280.648	27.16	-24.10	46.0	18.84	Peak	183.00	200	Vertical	Pass

Note 1: The marked spikes near 2400 MHz with circle should be ignored because they are Fundamental signal.

Note 2: The spurious from 18GHz-25GHz is noise only, do not show on the report.

ANT 0:

GFSK (BLE 1Mbps) LOW CHANNEL 1 GHz to 18 GHz, ANT H

RE Test case_FCC Part 15C_FCC 15.247(2.4G)_1GHz-18GHz

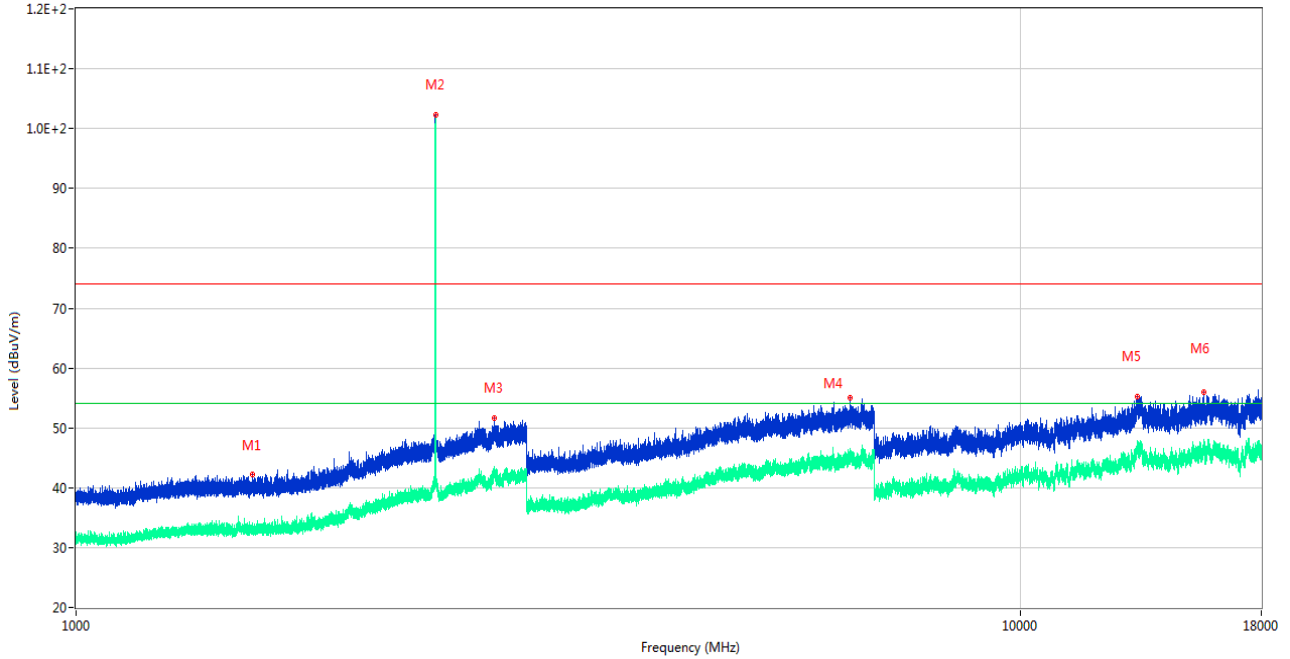

No.	Frequency (MHz)	Results (dBuV/m)	Factor (dB)	Limit (dBuV/m)	Margin (dB)	Detector	Table (Degree)	Height (cm)	Antenna	Verdict
1	1536.300	42.18	-16.93	74.0	31.82	Peak	284.00	200	Horizontal	Pass
1**	1536.300	33.99	-16.93	54.0	20.01	AV	284.00	200	Horizontal	Pass
2	2402.200	102.34	-9.74	74.0	-28.34	Peak	79.00	200	Horizontal	N/A
2**	2402.200	101.66	-9.74	54.0	-47.66	AV	79.00	200	Horizontal	N/A
3	2771.600	51.73	-8.52	74.0	22.27	Peak	205.00	100	Horizontal	Pass
3**	2771.600	43.22	-8.52	54.0	10.78	AV	205.00	100	Horizontal	Pass
4	6610.800	54.94	0.74	74.0	19.06	Peak	85.00	200	Horizontal	Pass
4**	6610.800	45.92	0.74	54.0	8.08	AV	85.00	200	Horizontal	Pass
5	13310.701	55.24	0.86	74.0	18.76	Peak	34.00	150	Horizontal	Pass
5**	13310.701	46.37	0.86	54.0	7.63	AV	34.00	150	Horizontal	Pass
6	15663.750	55.95	1.32	74.0	18.05	Peak	278.00	300	Horizontal	Pass
6**	15663.750	45.63	1.32	54.0	8.37	AV	278.00	300	Horizontal	Pass

GFSK (BLE 1Mbps) LOW CHANNEL 1 GHz to 18 GHz, ANT V

RE Test case_FCC Part 15C_FCC 15.247(2.4G)_1GHz-18GHz

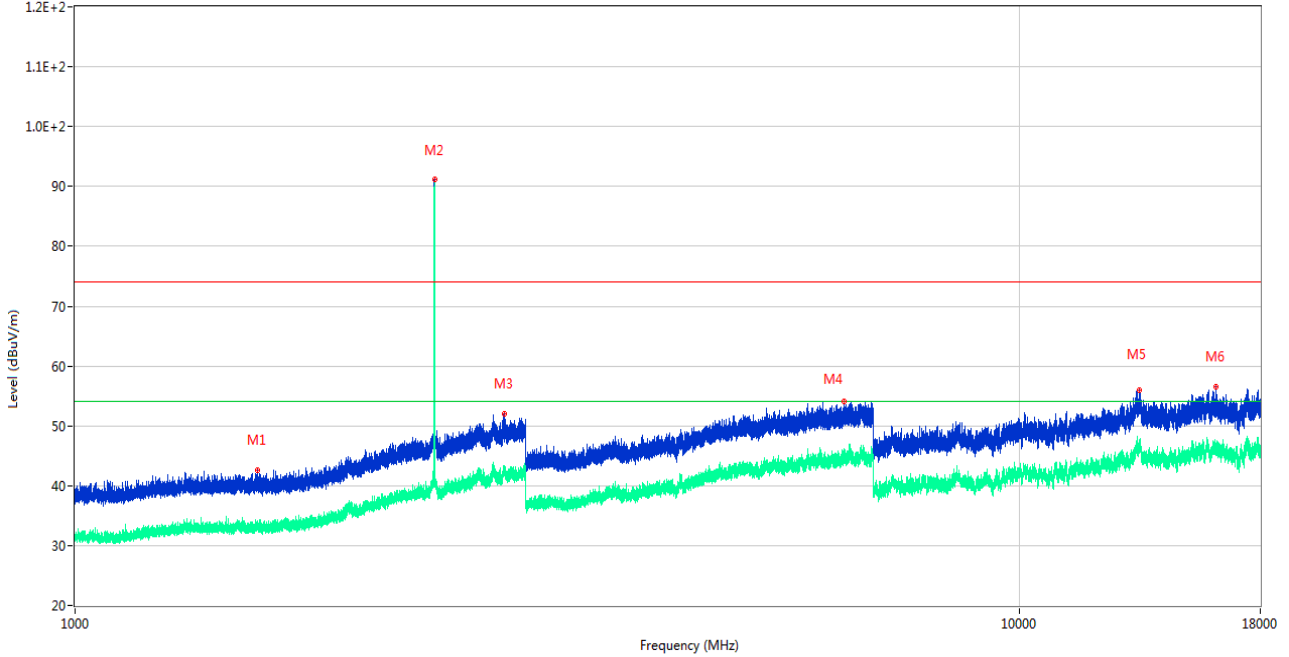

No.	Frequency (MHz)	Results (dBuV/m)	Factor (dB)	Limit (dBuV/m)	Margin (dB)	Detector	Table (Degree)	Height (cm)	Antenna	Verdict
1	1561.000	42.62	-16.84	74.0	31.38	Peak	159.00	200	Vertical	Pass
1**	1561.000	32.66	-16.84	54.0	21.34	AV	159.00	200	Vertical	Pass
2	2402.200	91.16	-9.74	74.0	-17.16	Peak	268.00	100	Vertical	N/A
2**	2402.200	90.24	-9.74	54.0	-36.24	AV	268.00	100	Vertical	N/A
3	2845.700	52.01	-8.46	74.0	21.99	Peak	93.00	200	Vertical	Pass
3**	2845.700	41.89	-8.46	54.0	12.11	AV	93.00	200	Vertical	Pass
4	6520.600	54.04	0.29	74.0	19.96	Peak	177.00	400	Vertical	Pass
4**	6520.600	45.31	0.29	54.0	8.69	AV	177.00	400	Vertical	Pass
5	13418.325	56.01	0.40	74.0	17.99	Peak	0.00	150	Vertical	Pass
5**	13418.325	46.75	0.40	54.0	7.25	AV	0.00	150	Vertical	Pass
6	16172.213	56.57	1.23	74.0	17.43	Peak	128.00	100	Vertical	Pass
6**	16172.213	46.08	1.23	54.0	7.92	AV	128.00	100	Vertical	Pass

GFSK (BLE 1Mbps) MIDDLE CHANNEL 1 GHz to 18 GHz, ANT H

RE Test case_FCC Part 15C_FCC 15.247(2.4G)_1GHz-18GHz

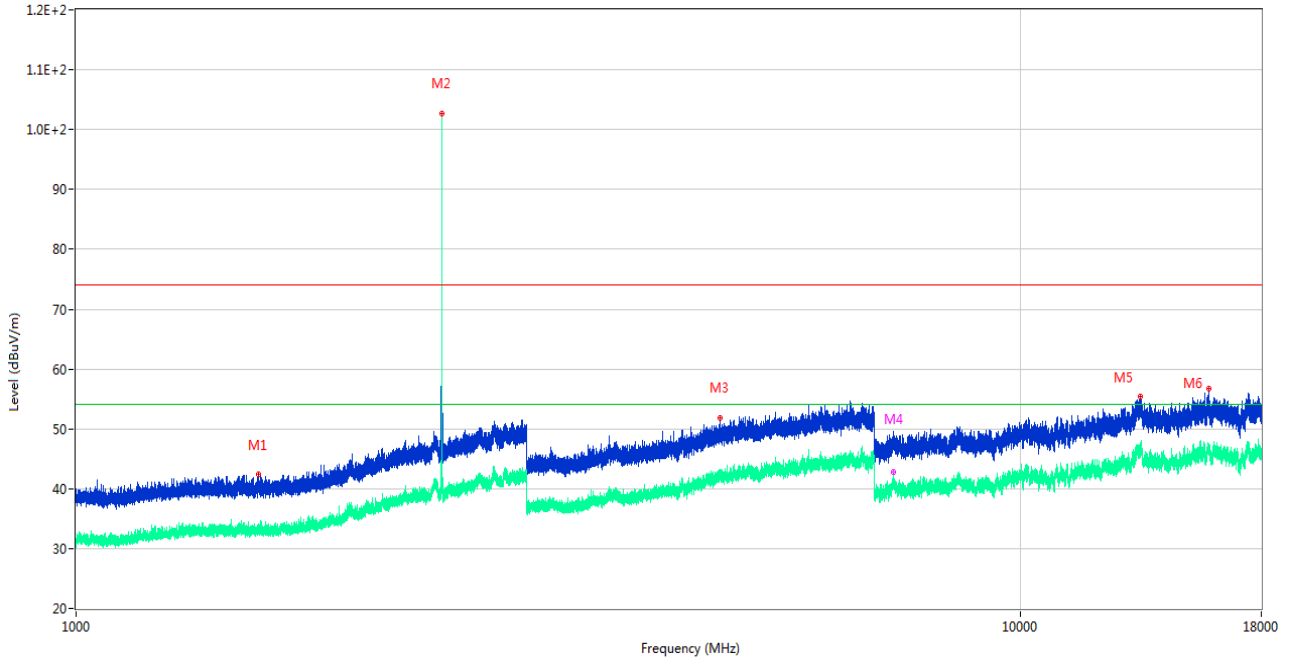

No.	Frequency (MHz)	Results (dBuV/m)	Factor (dB)	Limit (dBuV/m)	Margin (dB)	Detector	Table (Degree)	Height (cm)	Antenna	Verdict
1	1559.000	42.34	-16.97	74.0	31.66	Peak	137.00	300	Horizontal	Pass
1**	1559.000	33.01	-16.97	54.0	20.99	AV	137.00	300	Horizontal	Pass
2	2439.800	102.74	-12.40	74.0	-28.74	Peak	63.00	150	Horizontal	N/A
2**	2439.800	101.56	-12.40	54.0	-47.56	AV	63.00	150	Horizontal	N/A
3	4812.200	51.90	-2.10	74.0	22.10	Peak	154.00	100	Horizontal	Pass
3**	4812.200	42.55	-2.10	54.0	11.45	AV	154.00	100	Horizontal	Pass
4	7334.075	47.12	-3.17	74.0	26.88	Peak	296.00	150	Horizontal	Pass
4**	7334.075	42.83	-3.17	54.0	11.17	AV	296.00	150	Horizontal	Pass
5	13408.612	55.32	0.52	74.0	18.68	Peak	128.00	150	Horizontal	Pass
5**	13408.612	47.09	0.52	54.0	6.91	AV	128.00	150	Horizontal	Pass
6	15837.000	56.76	1.45	74.0	17.24	Peak	109.00	200	Horizontal	Pass
6**	15837.000	46.48	1.45	54.0	7.52	AV	109.00	200	Horizontal	Pass

GFSK (BLE 1Mbps) MIDDLE CHANNEL 1 GHz to 18 GHz, ANT V

RE Test case_FCC Part 15C_FCC 15.247(2.4G)_1GHz-18GHz

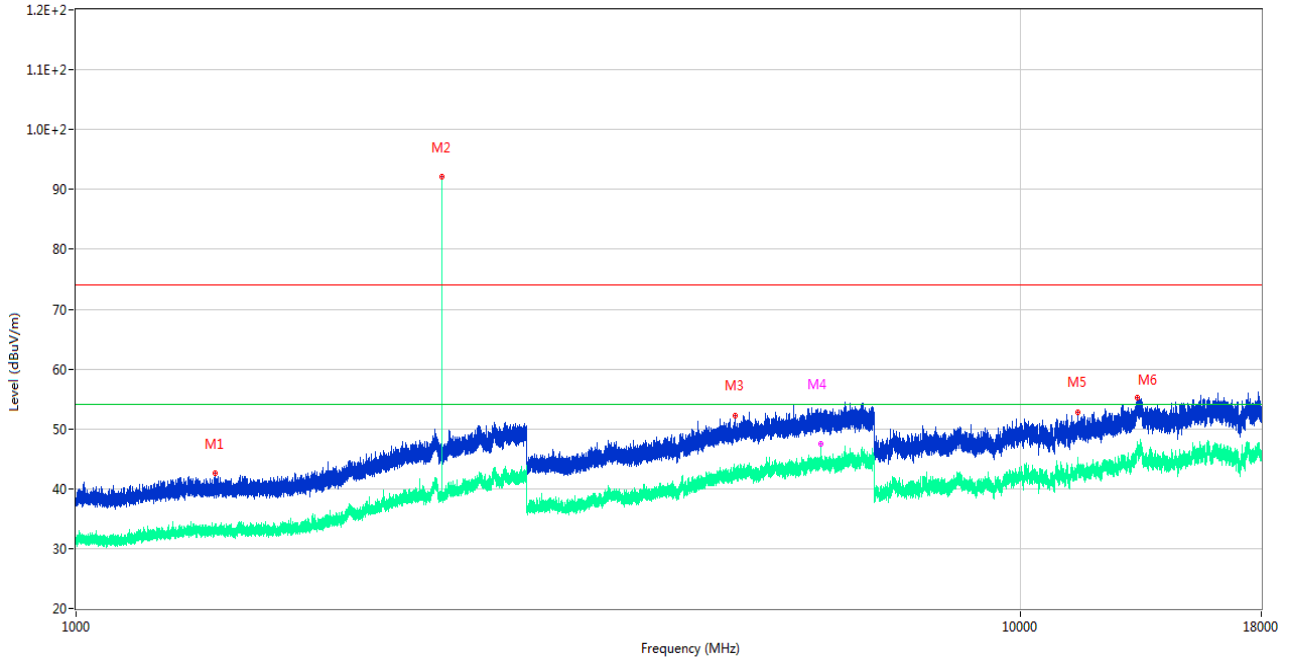

No.	Frequency (MHz)	Results (dBuV/m)	Factor (dB)	Limit (dBuV/m)	Margin (dB)	Detector	Table (Degree)	Height (cm)	Antenna	Verdict
1	1404.700	42.55	-16.99	74.0	31.45	Peak	238.00	200	Vertical	Pass
1**	1404.700	34.14	-16.99	54.0	19.86	AV	238.00	200	Vertical	Pass
2	2439.800	92.04	-12.40	74.0	-18.04	Peak	262.00	200	Vertical	N/A
2**	2439.800	90.84	-12.40	54.0	-36.84	AV	262.00	200	Vertical	N/A
3	4985.200	52.24	-1.98	74.0	21.76	Peak	205.00	150	Vertical	Pass
3**	4985.200	42.62	-1.98	54.0	11.38	AV	205.00	150	Vertical	Pass
4	6152.800	52.35	0.33	74.0	21.65	Peak	205.00	150	Vertical	Pass
4**	6152.800	47.48	0.33	54.0	6.52	AV	205.00	150	Vertical	Pass
5	11513.750	52.71	-0.31	74.0	21.29	Peak	360.00	150	Vertical	Pass
5**	11513.750	42.98	-0.31	54.0	11.02	AV	360.00	150	Vertical	Pass
6	13305.975	55.18	0.87	74.0	18.82	Peak	0.00	100	Vertical	Pass
6**	13305.975	46.13	0.87	54.0	7.87	AV	0.00	100	Vertical	Pass

GFSK (BLE 1Mbps) HIGH CHANNEL 1 GHz to 18 GHz, ANT H

RE Test case_FCC Part 15C_FCC 15.247(2.4G)_1GHz-18GHz

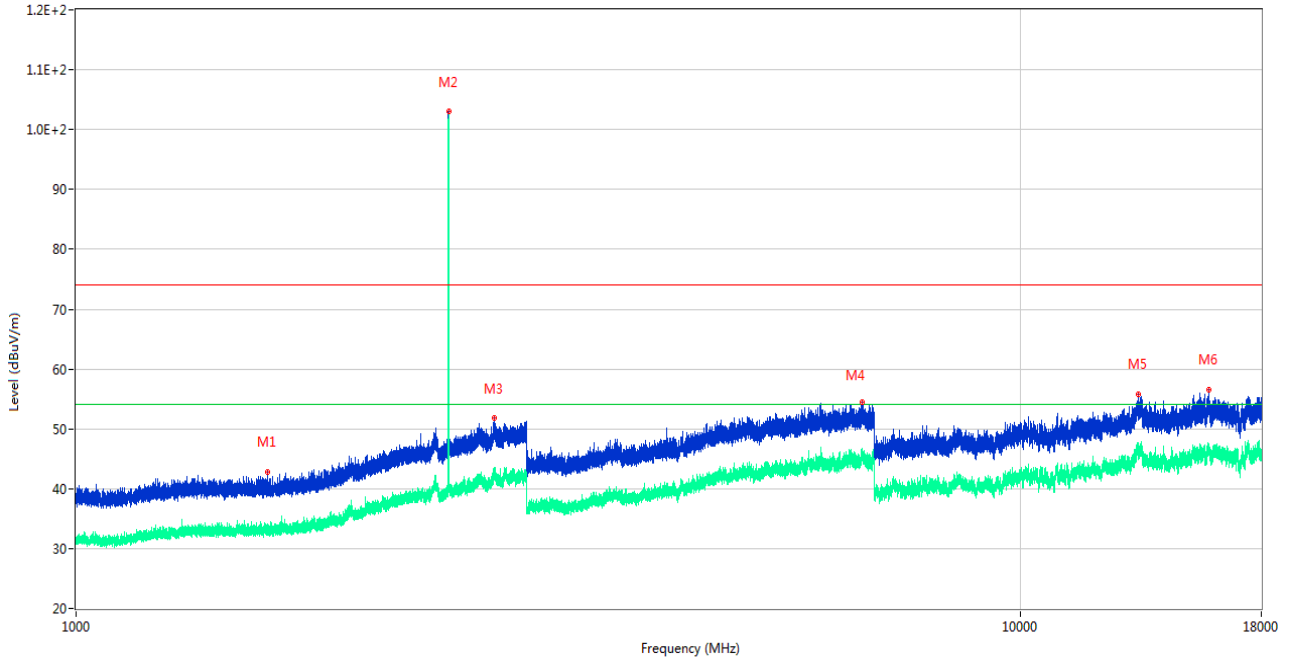

No.	Frequency (MHz)	Results (dBuV/m)	Factor (dB)	Limit (dBuV/m)	Margin (dB)	Detector	Table (Degree)	Height (cm)	Antenna	Verdict
1	1595.200	42.85	-17.23	74.0	31.15	Peak	29.00	300	Horizontal	Pass
1**	1595.200	33.09	-17.23	54.0	20.91	AV	29.00	300	Horizontal	Pass
2	2479.800	102.96	-11.33	74.0	-28.96	Peak	76.00	150	Horizontal	N/A
2**	2479.800	102.09	-11.33	54.0	-48.09	AV	76.00	150	Horizontal	N/A
3	2770.100	51.82	-8.56	74.0	22.18	Peak	360.00	150	Horizontal	Pass
3**	2770.100	42.31	-8.56	54.0	11.69	AV	360.00	150	Horizontal	Pass
4	6805.400	54.49	2.00	74.0	19.51	Peak	38.00	200	Horizontal	Pass
4**	6805.400	45.27	2.00	54.0	8.73	AV	38.00	200	Horizontal	Pass
5	13335.113	55.69	1.01	74.0	18.31	Peak	0.00	150	Horizontal	Pass
5**	13335.113	46.12	1.01	54.0	7.88	AV	0.00	150	Horizontal	Pass
6	15829.650	56.62	1.51	74.0	17.38	Peak	237.00	400	Horizontal	Pass
6**	15829.650	46.56	1.51	54.0	7.44	AV	237.00	400	Horizontal	Pass

GFSK (BLE 1Mbps) HIGH CHANNEL 1 GHz to 18 GHz, ANT V

RE Test case_FCC Part 15C_FCC 15.247(2.4G)_1GHz-18GHz

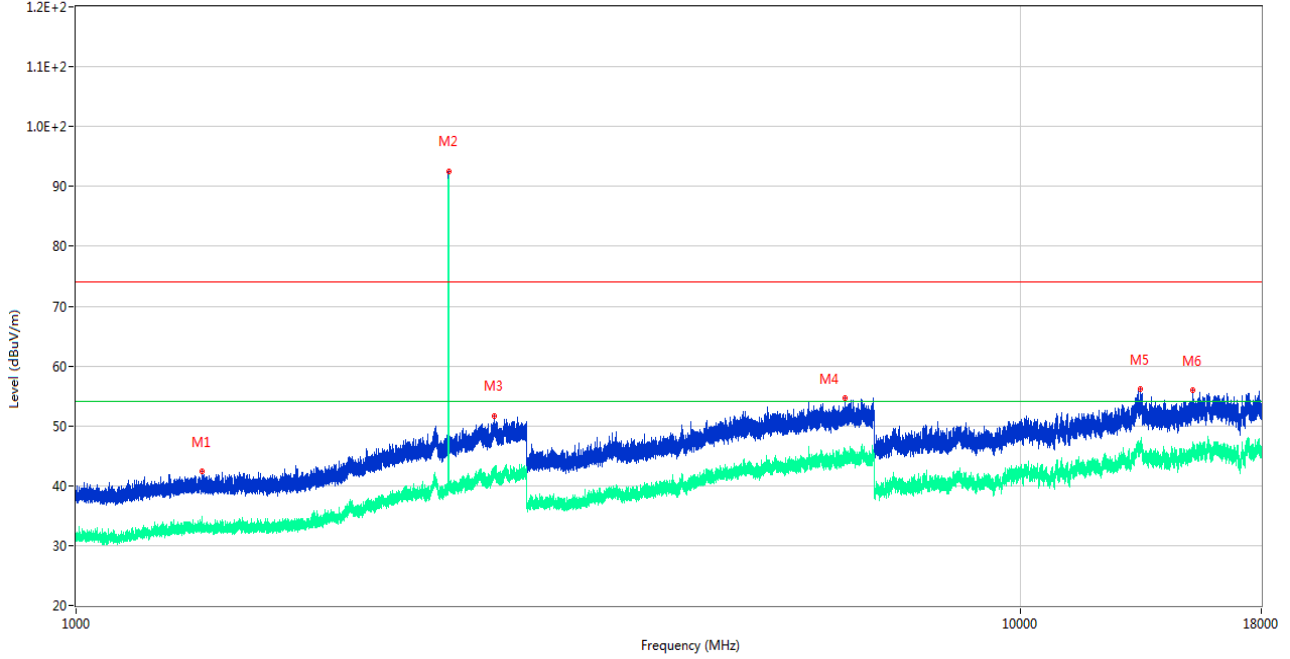

No.	Frequency (MHz)	Results (dBuV/m)	Factor (dB)	Limit (dBuV/m)	Margin (dB)	Detector	Table (Degree)	Height (cm)	Antenna	Verdict
1	1358.600	42.34	-17.13	74.0	31.66	Peak	305.00	100	Vertical	Pass
1**	1358.600	32.81	-17.13	54.0	21.19	AV	305.00	100	Vertical	Pass
2	2479.800	92.51	-11.33	74.0	-18.51	Peak	130.00	200	Vertical	N/A
2**	2479.800	91.75	-11.33	54.0	-37.75	AV	130.00	200	Vertical	N/A
3	2773.600	51.65	-8.98	74.0	22.35	Peak	136.00	100	Vertical	Pass
3**	2773.600	41.85	-8.98	54.0	12.15	AV	136.00	100	Vertical	Pass
4	6519.200	54.66	0.24	74.0	19.34	Peak	360.00	300	Vertical	Pass
4**	6519.200	44.83	0.24	54.0	9.17	AV	360.00	300	Vertical	Pass
5	13415.700	56.14	0.41	74.0	17.86	Peak	92.00	100	Vertical	Pass
5**	13415.700	46.60	0.41	54.0	7.40	AV	92.00	100	Vertical	Pass
6	15235.875	55.90	1.01	74.0	18.10	Peak	129.00	150	Vertical	Pass
6**	15235.875	47.32	1.01	54.0	6.68	AV	129.00	150	Vertical	Pass

GFSK (BLE 2Mbps) LOW CHANNEL 1 GHz to 18 GHz, ANT H

RE Test case_FCC Part 15C_FCC 15.247(2.4G)_1GHz-18GHz

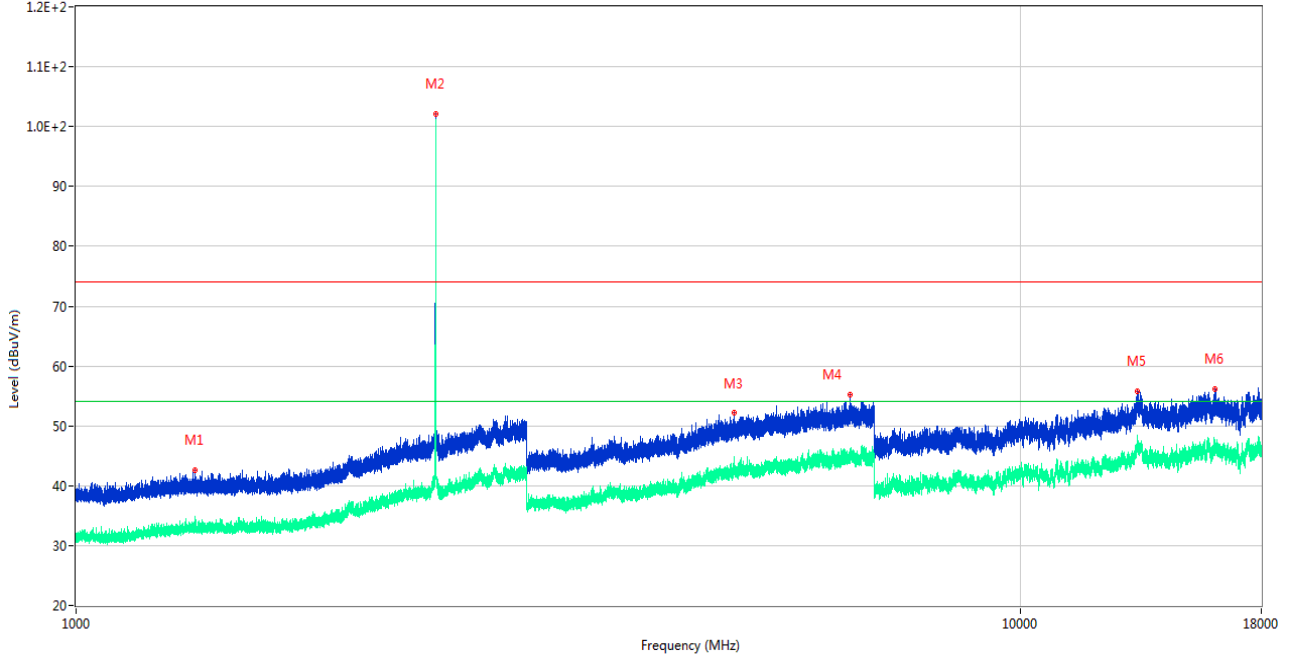

No.	Frequency (MHz)	Results (dBuV/m)	Factor (dB)	Limit (dBuV/m)	Margin (dB)	Detector	Table (Degree)	Height (cm)	Antenna	Verdict
1	1335.500	42.69	-17.06	74.0	31.31	Peak	139.00	100	Horizontal	Pass
1**	1335.500	32.41	-17.06	54.0	21.59	AV	139.00	100	Horizontal	Pass
2	2403.500	102.11	-9.69	74.0	-28.11	Peak	77.00	200	Horizontal	N/A
2**	2403.500	100.27	-9.69	54.0	-46.27	AV	77.00	200	Horizontal	N/A
3	4978.600	52.17	-1.61	74.0	21.83	Peak	18.00	100	Horizontal	Pass
3**	4978.600	42.74	-1.61	54.0	11.26	AV	18.00	100	Horizontal	Pass
4	6606.000	55.30	-0.12	74.0	18.70	Peak	60.00	400	Horizontal	Pass
4**	6606.000	45.36	-0.12	54.0	8.64	AV	60.00	400	Horizontal	Pass
5	13297.838	55.74	0.85	74.0	18.26	Peak	332.00	150	Horizontal	Pass
5**	13297.838	46.12	0.85	54.0	7.88	AV	332.00	150	Horizontal	Pass
6	16077.187	56.21	1.58	74.0	17.79	Peak	88.00	100	Horizontal	Pass
6**	16077.187	46.98	1.58	54.0	7.02	AV	88.00	100	Horizontal	Pass

GFSK (BLE 2Mbps) LOW CHANNEL 1 GHz to 18 GHz, ANT V

RE Test case_FCC Part 15C_FCC 15.247(2.4G)_1GHz-18GHz

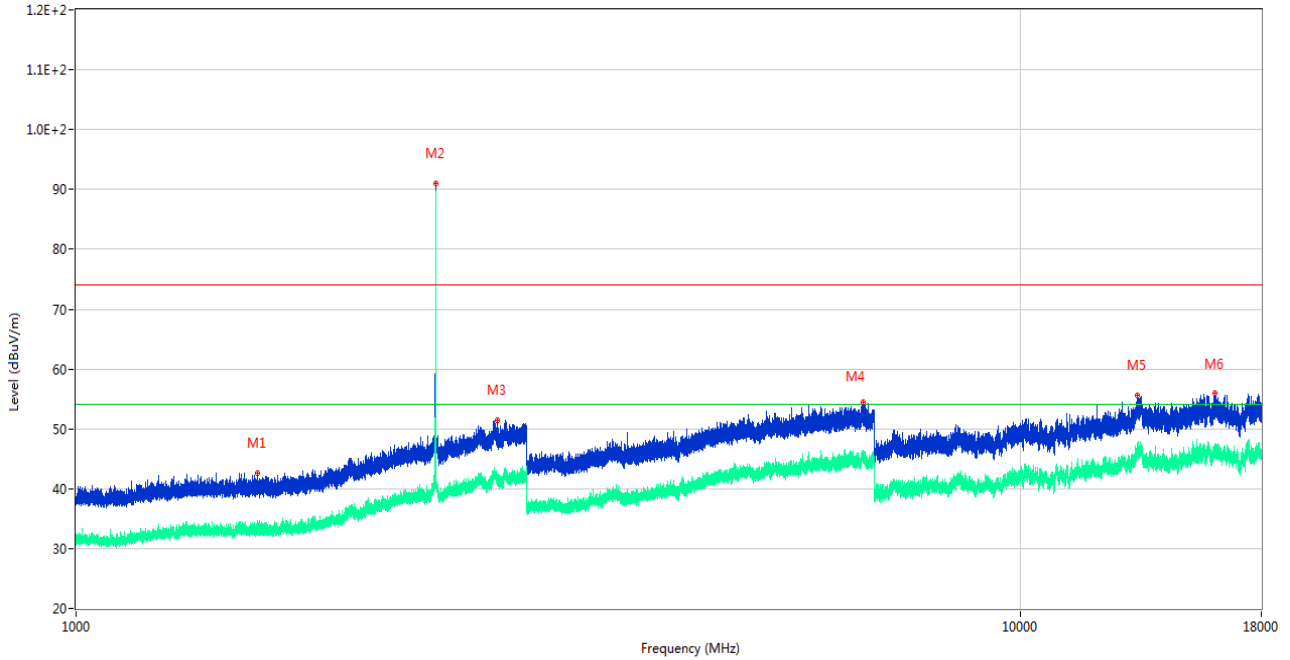

No.	Frequency (MHz)	Results (dBuV/m)	Factor (dB)	Limit (dBuV/m)	Margin (dB)	Detector	Table (Degree)	Height (cm)	Antenna	Verdict
1	1558.200	42.66	-16.99	74.0	31.34	Peak	314.00	400	Vertical	Pass
1**	1558.200	32.93	-16.99	54.0	21.07	AV	314.00	400	Vertical	Pass
2	2403.500	91.03	-9.69	74.0	-17.03	Peak	130.00	150	Vertical	N/A
2**	2403.500	87.99	-9.69	54.0	-33.99	AV	130.00	150	Vertical	N/A
3	2792.300	51.53	-9.90	74.0	22.47	Peak	357.00	100	Vertical	Pass
3**	2792.300	41.71	-9.90	54.0	12.29	AV	357.00	100	Vertical	Pass
4	6812.200	54.49	1.11	74.0	19.51	Peak	44.00	100	Vertical	Pass
4**	6812.200	45.70	1.11	54.0	8.30	AV	44.00	100	Vertical	Pass
5	13310.175	55.60	0.86	74.0	18.40	Peak	175.00	150	Vertical	Pass
5**	13310.175	46.14	0.86	54.0	7.86	AV	175.00	150	Vertical	Pass
6	16091.625	55.91	1.40	74.0	18.09	Peak	254.00	400	Vertical	Pass
6**	16091.625	46.11	1.40	54.0	7.89	AV	254.00	400	Vertical	Pass

GFSK (BLE 2Mbps) MIDDLE CHANNEL 1 GHz to 18 GHz, ANT H

RE Test case_FCC Part 15C_FCC 15.247(2.4G)_1GHz-18GHz

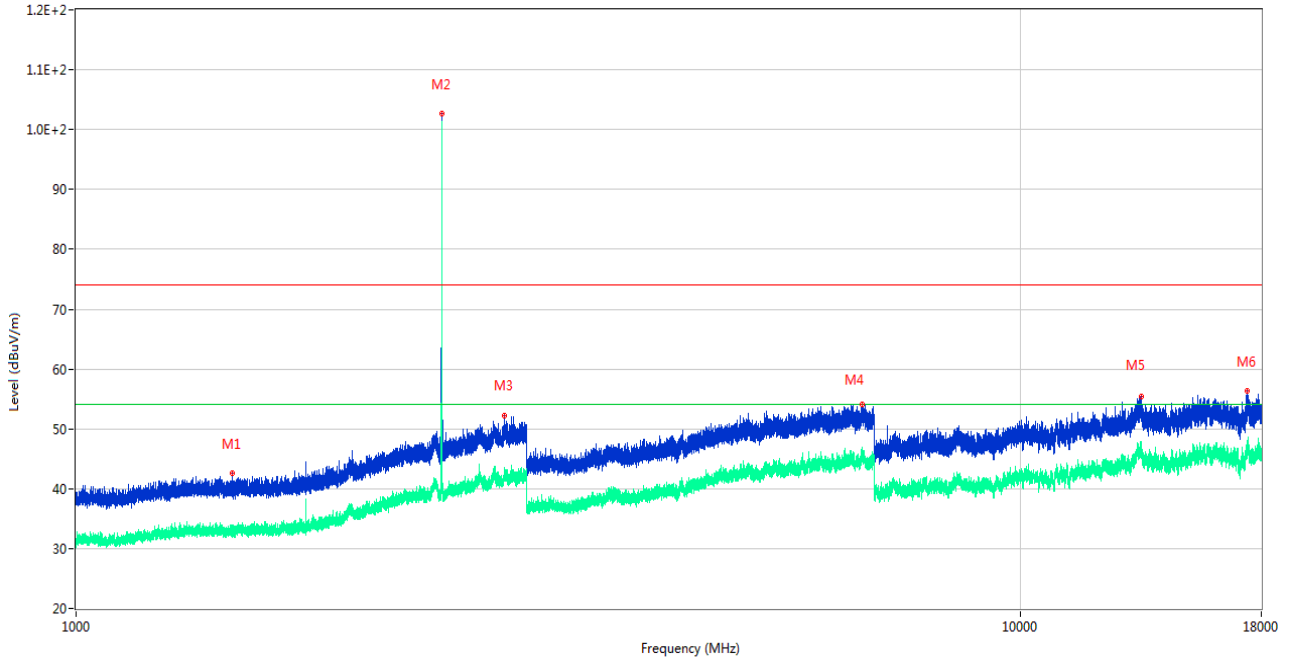

No.	Frequency (MHz)	Results (dBuV/m)	Factor (dB)	Limit (dBuV/m)	Margin (dB)	Detector	Table (Degree)	Height (cm)	Antenna	Verdict
1	1462.100	42.57	-17.33	74.0	31.43	Peak	76.00	300	Horizontal	Pass
1**	1462.100	32.53	-17.33	54.0	21.47	AV	76.00	300	Horizontal	Pass
2	2439.500	102.60	-12.37	74.0	-28.60	Peak	60.00	100	Horizontal	N/A
2**	2439.500	98.88	-12.37	54.0	-44.88	AV	60.00	100	Horizontal	N/A
3	2841.200	52.24	-8.69	74.0	21.76	Peak	267.00	100	Horizontal	Pass
3**	2841.200	42.22	-8.69	54.0	11.78	AV	267.00	100	Horizontal	Pass
4	6793.000	54.04	1.06	74.0	19.96	Peak	119.00	300	Horizontal	Pass
4**	6793.000	46.87	1.06	54.0	7.13	AV	119.00	300	Horizontal	Pass
5	13430.138	55.45	0.40	74.0	18.55	Peak	201.00	150	Horizontal	Pass
5**	13430.138	46.64	0.40	54.0	7.36	AV	201.00	150	Horizontal	Pass
6	17400.713	56.27	3.20	74.0	17.73	Peak	127.00	300	Horizontal	Pass
6**	17400.713	46.59	3.20	54.0	7.41	AV	127.00	300	Horizontal	Pass

GFSK (BLE 2Mbps) MIDDLE CHANNEL 1 GHz to 18 GHz, ANT V

RE Test case_FCC Part 15C_FCC 15.247(2.4G)_1GHz-18GHz

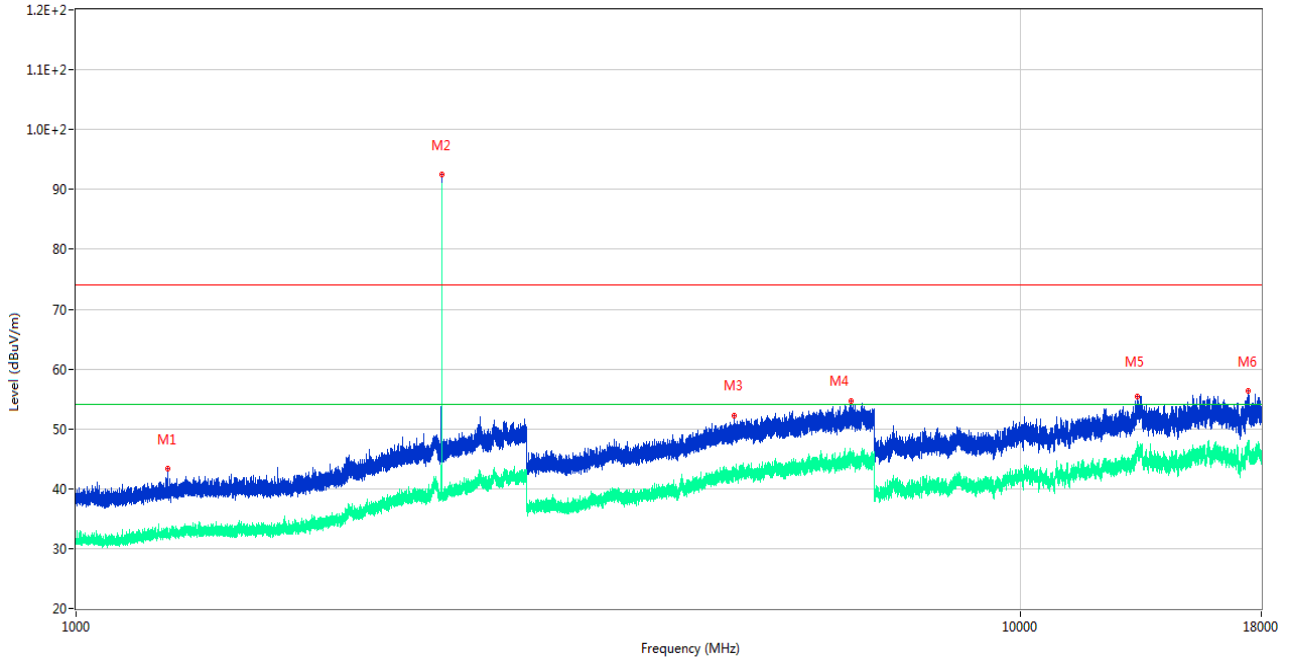

No.	Frequency (MHz)	Results (dBuV/m)	Factor (dB)	Limit (dBuV/m)	Margin (dB)	Detector	Table (Degree)	Height (cm)	Antenna	Verdict
1	1250.900	43.31	-17.32	74.0	30.69	Peak	238.00	300	Vertical	Pass
1**	1250.900	32.28	-17.32	54.0	21.72	AV	238.00	300	Vertical	Pass
2	2439.500	92.47	-12.37	74.0	-18.47	Peak	319.00	200	Vertical	N/A
2**	2439.500	89.38	-12.37	54.0	-35.38	AV	319.00	200	Vertical	N/A
3	4983.400	52.29	-1.68	74.0	21.71	Peak	360.00	100	Vertical	Pass
3**	4983.400	43.14	-1.68	54.0	10.86	AV	360.00	100	Vertical	Pass
4	6611.600	54.72	0.64	74.0	19.28	Peak	144.00	100	Vertical	Pass
4**	6611.600	45.52	0.64	54.0	8.48	AV	144.00	100	Vertical	Pass
5	13306.500	55.39	0.87	74.0	18.61	Peak	77.00	150	Vertical	Pass
5**	13306.500	46.68	0.87	54.0	7.32	AV	77.00	150	Vertical	Pass
6	17448.225	56.33	2.84	74.0	17.67	Peak	16.00	400	Vertical	Pass
6**	17448.225	47.48	2.84	54.0	6.52	AV	16.00	400	Vertical	Pass

GFSK (BLE 2Mbps) HIGH CHANNEL 1 GHz to 18 GHz, ANT H

RE Test case_FCC Part 15C_FCC 15.247(2.4G)_1GHz-18GHz

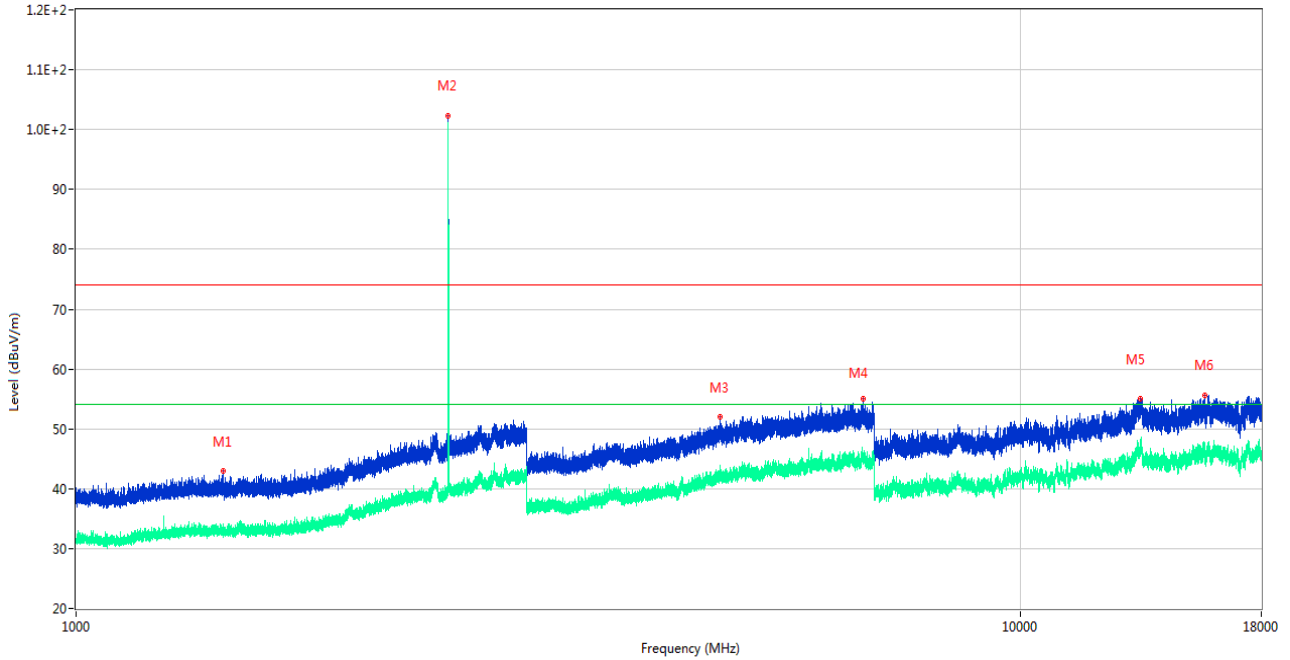

No.	Frequency (MHz)	Results (dBuV/m)	Factor (dB)	Limit (dBuV/m)	Margin (dB)	Detector	Table (Degree)	Height (cm)	Antenna	Verdict
1	1430.000	42.94	-17.02	74.0	31.06	Peak	298.00	400	Horizontal	Pass
1**	1430.000	32.21	-17.02	54.0	21.79	AV	298.00	400	Horizontal	Pass
2	2478.500	102.38	-11.53	74.0	-28.38	Peak	75.00	200	Horizontal	N/A
2**	2478.500	99.96	-11.53	54.0	-45.96	AV	75.00	200	Horizontal	N/A
3	4807.800	51.97	-2.25	74.0	22.03	Peak	344.00	100	Horizontal	Pass
3**	4807.800	42.61	-2.25	54.0	11.39	AV	344.00	100	Horizontal	Pass
4	6816.600	54.98	0.61	74.0	19.02	Peak	233.00	100	Horizontal	Pass
4**	6816.600	45.03	0.61	54.0	8.97	AV	233.00	100	Horizontal	Pass
5	13413.862	55.06	0.43	74.0	18.94	Peak	243.00	150	Horizontal	Pass
5**	13413.862	47.11	0.43	54.0	6.89	AV	243.00	150	Horizontal	Pass
6	15676.875	55.62	1.55	74.0	18.38	Peak	72.00	400	Horizontal	Pass
6**	15676.875	46.43	1.55	54.0	7.57	AV	72.00	400	Horizontal	Pass

GFSK (BLE 2Mbps) HIGH CHANNEL 1 GHz to 18 GHz, ANT V

RE Test case_FCC Part 15C_FCC 15.247(2.4G)_1GHz-18GHz

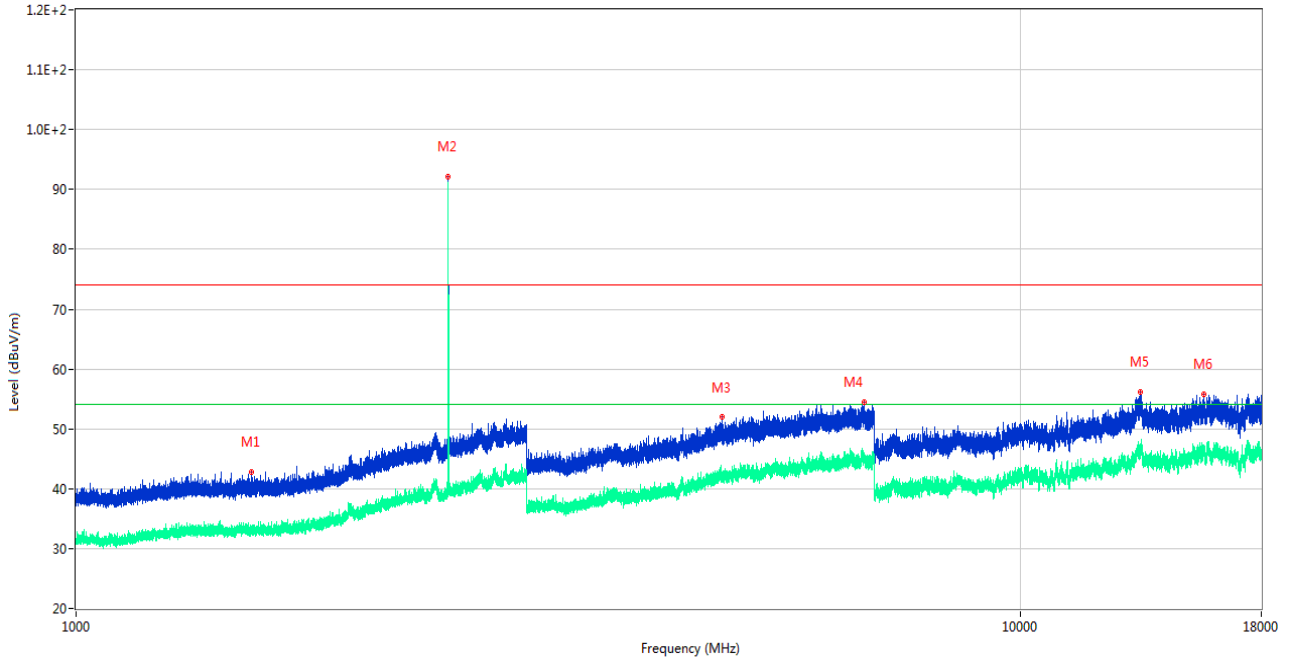

No.	Frequency (MHz)	Results (dBuV/m)	Factor (dB)	Limit (dBuV/m)	Margin (dB)	Detector	Table (Degree)	Height (cm)	Antenna	Verdict
1	1535.200	42.78	-17.07	74.0	31.22	Peak	45.00	400	Vertical	Pass
1**	1535.200	33.27	-17.07	54.0	20.73	AV	45.00	400	Vertical	Pass
2	2478.500	92.12	-11.53	74.0	-18.12	Peak	323.00	100	Vertical	N/A
2**	2478.500	89.62	-11.53	54.0	-35.62	AV	323.00	100	Vertical	N/A
3	4831.800	51.92	-2.69	74.0	22.08	Peak	93.00	150	Vertical	Pass
3**	4831.800	42.30	-2.69	54.0	11.70	AV	93.00	150	Vertical	Pass
4	6841.400	54.49	0.94	74.0	19.51	Peak	360.00	100	Vertical	Pass
4**	6841.400	45.99	0.94	54.0	8.01	AV	360.00	100	Vertical	Pass
5	13407.037	56.16	0.53	74.0	17.84	Peak	56.00	200	Vertical	Pass
5**	13407.037	47.00	0.53	54.0	7.00	AV	56.00	200	Vertical	Pass
6	15638.287	55.84	1.42	74.0	18.16	Peak	0.00	150	Vertical	Pass
6**	15638.287	45.91	1.42	54.0	8.09	AV	0.00	150	Vertical	Pass

ANT 1:

FSK (BLE 1Mbps) LOW CHANNEL 1 GHz to 18 GHz, ANT H

RE Test case_FCC Part 15C_FCC 15.247(2.4G)_1GHz-18GHz

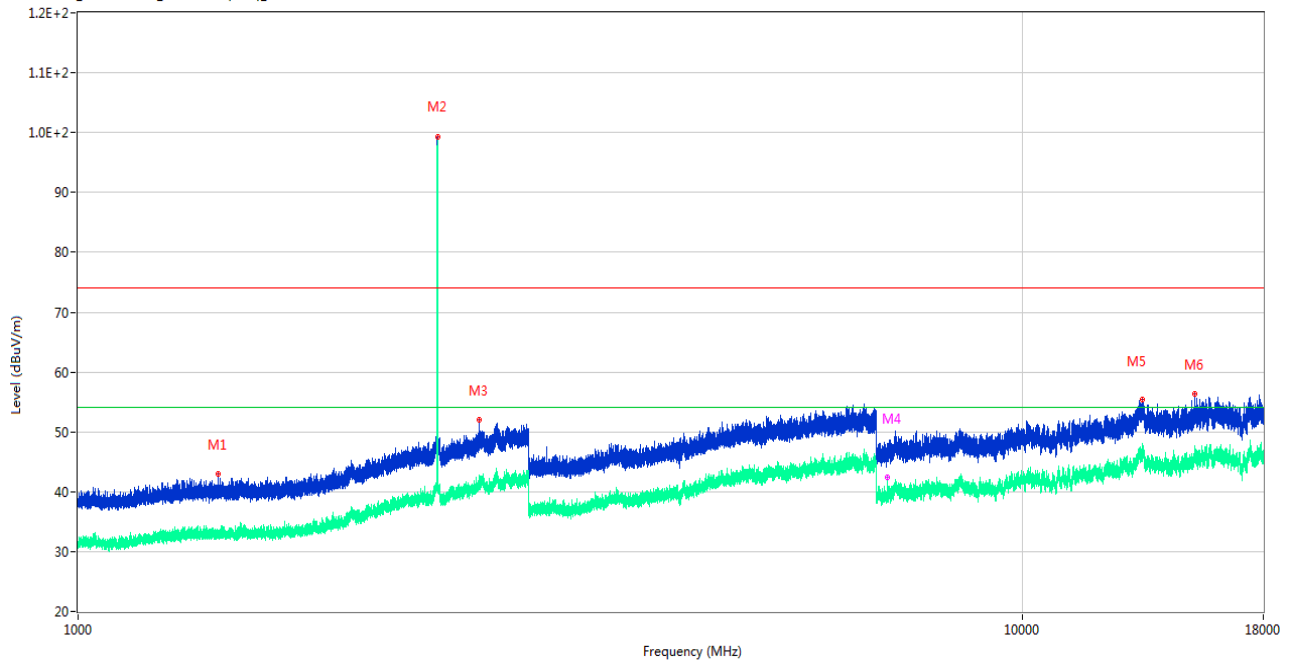

No.	Frequency (MHz)	Results (dBuV/m)	Factor (dB)	Limit (dBuV/m)	Margin (dB)	Detector	Table (Degree)	Height (cm)	Antenna	Verdict
1	1406.500	42.89	-16.95	74.0	31.11	Peak	65.00	200	Horizontal	Pass
1**	1406.500	33.17	-16.95	54.0	20.83	AV	65.00	200	Horizontal	Pass
2	2402.300	99.33	-9.73	74.0	-25.33	Peak	119.00	200	Horizontal	N/A
2**	2402.300	98.78	-9.73	54.0	-44.78	AV	119.00	200	Horizontal	N/A
3	2662.000	51.96	-10.92	74.0	22.04	Peak	304.00	150	Horizontal	Pass
3**	2662.000	40.43	-10.92	54.0	13.57	AV	304.00	150	Horizontal	Pass
4	7196.362	46.82	-3.53	74.0	27.18	Peak	0.00	150	Horizontal	Pass
4**	7196.362	42.37	-3.53	54.0	11.63	AV	0.00	150	Horizontal	Pass
5	13404.412	55.33	0.55	74.0	18.67	Peak	315.00	150	Horizontal	Pass
5**	13404.412	47.24	0.55	54.0	6.76	AV	315.00	150	Horizontal	Pass
6	15234.562	56.27	1.01	74.0	17.73	Peak	36.00	100	Horizontal	Pass
6**	15234.562	45.96	1.01	54.0	8.04	AV	36.00	100	Horizontal	Pass

GFSK (BLE 1Mbps) LOW CHANNEL 1 GHz to 18 GHz, ANT V

RE Test case_FCC Part 15C_FCC 15.247(2.4G)_1GHz-18GHz

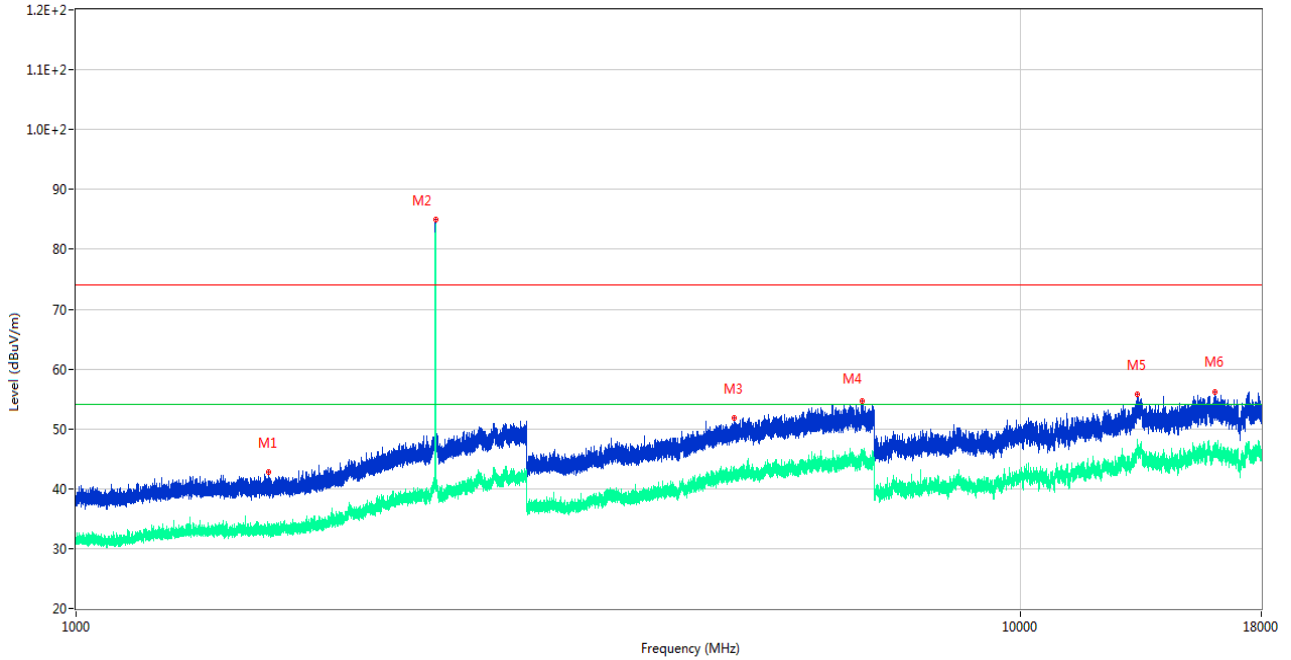

No.	Frequency (MHz)	Results (dBuV/m)	Factor (dB)	Limit (dBuV/m)	Margin (dB)	Detector	Table (Degree)	Height (cm)	Antenna	Verdict
1	1598.800	42.73	-17.37	74.0	31.27	Peak	333.00	300	Vertical	Pass
1**	1598.800	32.72	-17.37	54.0	21.28	AV	333.00	300	Vertical	Pass
2	2402.200	84.88	-9.74	74.0	-10.88	Peak	295.00	200	Vertical	N/A
2**	2402.200	84.06	-9.74	54.0	-30.06	AV	295.00	200	Vertical	N/A
3	4977.000	51.76	-1.77	74.0	22.24	Peak	129.00	200	Vertical	Pass
3**	4977.000	42.14	-1.77	54.0	11.86	AV	129.00	200	Vertical	Pass
4	6808.200	54.56	1.76	74.0	19.44	Peak	221.00	300	Vertical	Pass
4**	6808.200	45.04	1.76	54.0	8.96	AV	221.00	300	Vertical	Pass
5	13316.737	55.74	0.89	74.0	18.26	Peak	241.00	150	Vertical	Pass
5**	13316.737	47.04	0.89	54.0	6.96	AV	241.00	150	Vertical	Pass
6	16077.187	56.24	1.58	74.0	17.76	Peak	70.00	300	Vertical	Pass
6**	16077.187	46.58	1.58	54.0	7.42	AV	70.00	300	Vertical	Pass

GFSK (BLE 1Mbps) MIDDLE CHANNEL 1 GHz to 18 GHz, ANT H

RE Test case_FCC Part 15C_FCC 15.247(2.4G)_1GHz-18GHz

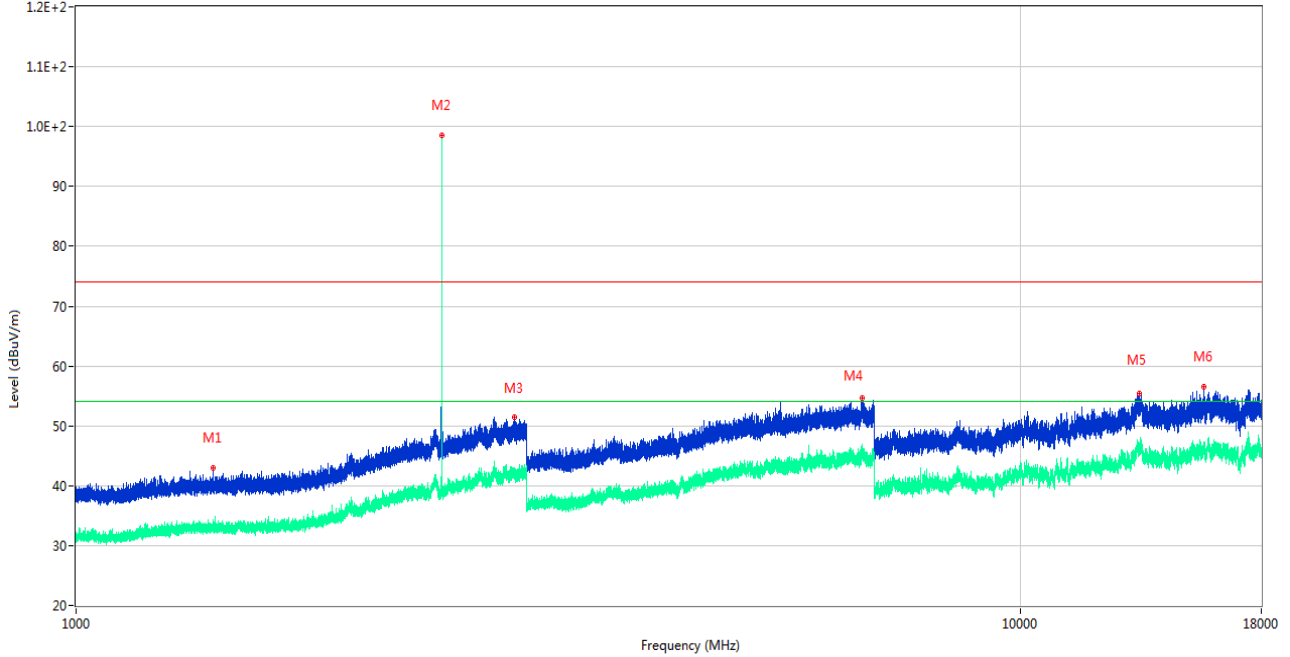

No.	Frequency (MHz)	Results (dBuV/m)	Factor (dB)	Limit (dBuV/m)	Margin (dB)	Detector	Table (Degree)	Height (cm)	Antenna	Verdict
1	1397.900	43.03	-17.23	74.0	30.97	Peak	272.00	300	Horizontal	Pass
1**	1397.900	32.79	-17.23	54.0	21.21	AV	272.00	300	Horizontal	Pass
2	2440.300	98.62	-12.39	74.0	-24.62	Peak	121.00	200	Horizontal	N/A
2**	2440.300	97.63	-12.39	54.0	-43.63	AV	121.00	200	Horizontal	N/A
3	2911.600	51.42	-9.09	74.0	22.58	Peak	71.00	150	Horizontal	Pass
3**	2911.600	41.73	-9.09	54.0	12.27	AV	71.00	150	Horizontal	Pass
4	6807.000	54.61	2.15	74.0	19.39	Peak	190.00	300	Horizontal	Pass
4**	6807.000	45.77	2.15	54.0	8.23	AV	190.00	300	Horizontal	Pass
5	13376.588	55.37	0.67	74.0	18.63	Peak	143.00	150	Horizontal	Pass
5**	13376.588	45.57	0.67	54.0	8.43	AV	143.00	150	Horizontal	Pass
6	15655.875	56.57	1.20	74.0	17.43	Peak	170.00	100	Horizontal	Pass
6**	15655.875	45.80	1.20	54.0	8.20	AV	170.00	100	Horizontal	Pass

GFSK (BLE 1Mbps) MIDDLE CHANNEL 1 GHz to 18 GHz, ANT V

RE Test case_FCC Part 15C_FCC 15.247(2.4G)_1GHz-18GHz

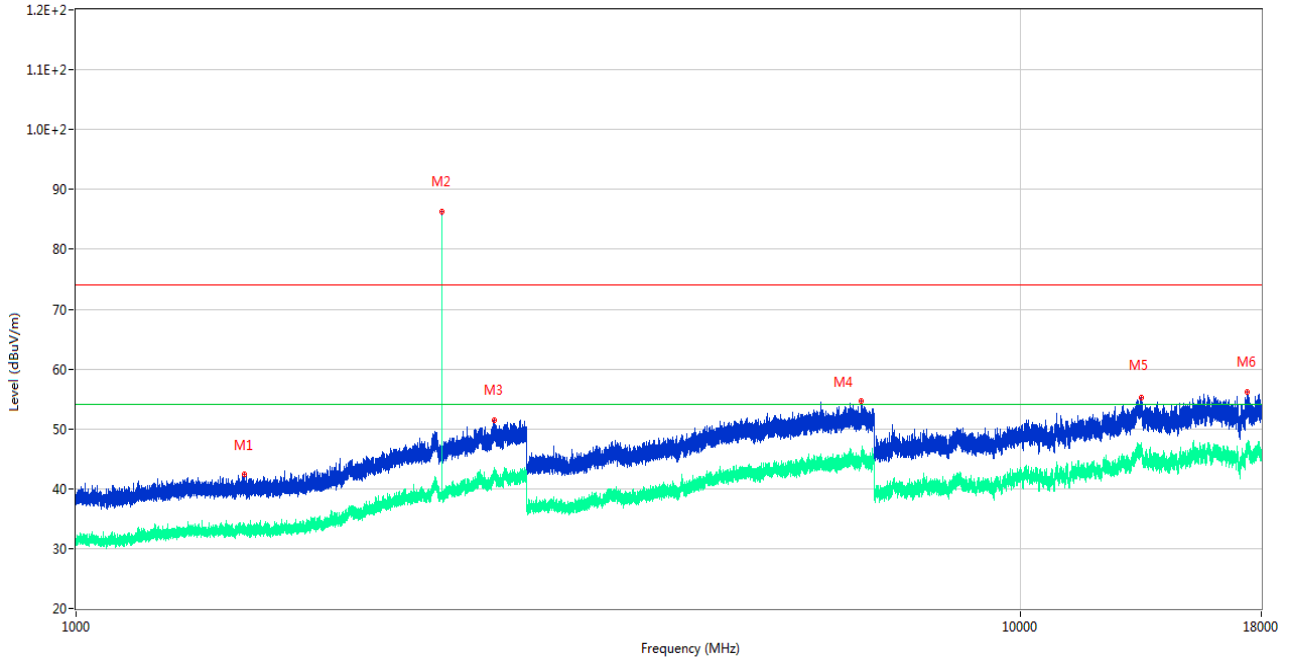

No.	Frequency (MHz)	Results (dBuV/m)	Factor (dB)	Limit (dBuV/m)	Margin (dB)	Detector	Table (Degree)	Height (cm)	Antenna	Verdict
1	1506.800	42.32	-16.82	74.0	31.68	Peak	323.00	400	Vertical	Pass
1**	1506.800	32.98	-16.82	54.0	21.02	AV	323.00	400	Vertical	Pass
2	2439.800	86.29	-12.40	74.0	-12.29	Peak	305.00	150	Vertical	N/A
2**	2439.800	84.97	-12.40	54.0	-30.97	AV	305.00	150	Vertical	N/A
3	2770.700	51.54	-8.49	74.0	22.46	Peak	247.00	200	Vertical	Pass
3**	2770.700	42.45	-8.49	54.0	11.55	AV	247.00	200	Vertical	Pass
4	6792.600	54.72	1.01	74.0	19.28	Peak	185.00	100	Vertical	Pass
4**	6792.600	45.52	1.01	54.0	8.48	AV	185.00	100	Vertical	Pass
5	13422.262	55.24	0.40	74.0	18.76	Peak	339.00	150	Vertical	Pass
5**	13422.262	46.09	0.40	54.0	7.91	AV	339.00	150	Vertical	Pass
6	17400.187	56.20	3.18	74.0	17.80	Peak	256.00	100	Vertical	Pass
6**	17400.187	46.58	3.18	54.0	7.42	AV	256.00	100	Vertical	Pass

GFSK (BLE 1Mbps) HIGH CHANNEL 1 GHz to 18 GHz, ANT H

RE Test case_FCC Part 15C_FCC 15.247(2.4G)_1GHz-18GHz

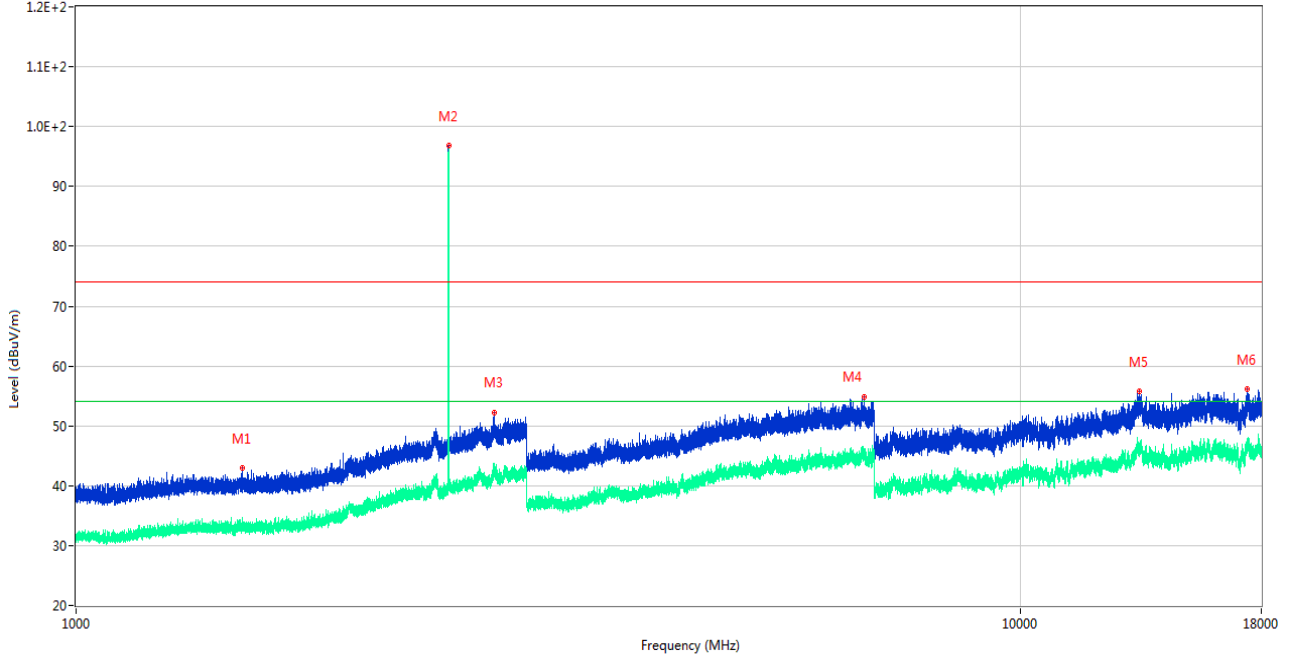

No.	Frequency (MHz)	Results (dBuV/m)	Factor (dB)	Limit (dBuV/m)	Margin (dB)	Detector	Table (Degree)	Height (cm)	Antenna	Verdict
1	1501.000	42.95	-16.90	74.0	31.05	Peak	284.00	200	Horizontal	Pass
1**	1501.000	34.75	-16.90	54.0	19.25	AV	284.00	200	Horizontal	Pass
2	2479.800	96.76	-11.33	74.0	-22.76	Peak	117.00	200	Horizontal	N/A
2**	2479.800	96.16	-11.33	54.0	-42.16	AV	117.00	200	Horizontal	N/A
3	2774.100	52.27	-9.02	74.0	21.73	Peak	200.00	100	Horizontal	Pass
3**	2774.100	41.84	-9.02	54.0	12.16	AV	200.00	100	Horizontal	Pass
4	6838.600	54.78	0.59	74.0	19.22	Peak	347.00	300	Horizontal	Pass
4**	6838.600	44.91	0.59	54.0	9.09	AV	347.00	300	Horizontal	Pass
5	13372.125	55.69	0.69	74.0	18.31	Peak	37.00	150	Horizontal	Pass
5**	13372.125	46.20	0.69	54.0	7.80	AV	37.00	150	Horizontal	Pass
6	17406.489	56.10	3.36	74.0	17.90	Peak	18.00	200	Horizontal	Pass
6**	17406.489	47.16	3.36	54.0	6.84	AV	18.00	200	Horizontal	Pass

GFSK (BLE 1Mbps) HIGH CHANNEL 1 GHz to 18 GHz, ANT V

RE Test case_FCC Part 15C_FCC 15.247(2.4G)_1GHz-18GHz

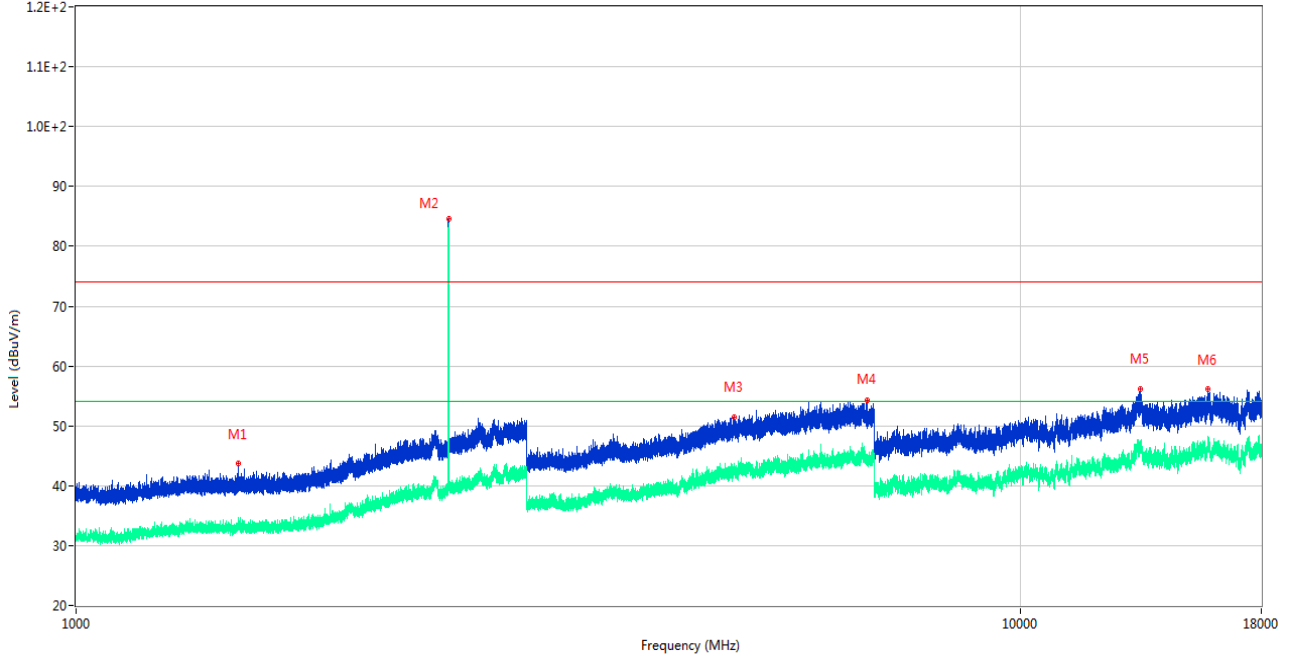

No.	Frequency (MHz)	Results (dBuV/m)	Factor (dB)	Limit (dBuV/m)	Margin (dB)	Detector	Table (Degree)	Height (cm)	Antenna	Verdict
1	1485.300	43.67	-16.69	74.0	30.33	Peak	54.00	400	Vertical	Pass
1**	1485.300	33.52	-16.69	54.0	20.48	AV	54.00	400	Vertical	Pass
2	2480.200	84.59	-11.29	74.0	-10.59	Peak	304.00	150	Vertical	N/A
2**	2480.200	83.49	-11.29	54.0	-29.49	AV	304.00	150	Vertical	N/A
3	4977.400	51.50	-1.73	74.0	22.50	Peak	74.00	150	Vertical	Pass
3**	4977.400	42.89	-1.73	54.0	11.11	AV	74.00	150	Vertical	Pass
4	6892.000	54.26	-0.23	74.0	19.74	Peak	247.00	200	Vertical	Pass
4**	6892.000	43.79	-0.23	54.0	10.21	AV	247.00	200	Vertical	Pass
5	13405.463	56.16	0.55	74.0	17.84	Peak	305.00	300	Vertical	Pass
5**	13405.463	46.26	0.55	54.0	7.74	AV	305.00	300	Vertical	Pass
6	15800.513	56.15	2.33	74.0	17.85	Peak	128.00	150	Vertical	Pass
6**	15800.513	46.97	2.33	54.0	7.03	AV	128.00	150	Vertical	Pass

GFSK (BLE 2Mbps) LOW CHANNEL 1 GHz to 18 GHz, ANT H

RE Test case_FCC Part 15C_FCC 15.247(2.4G)_1GHz-18GHz

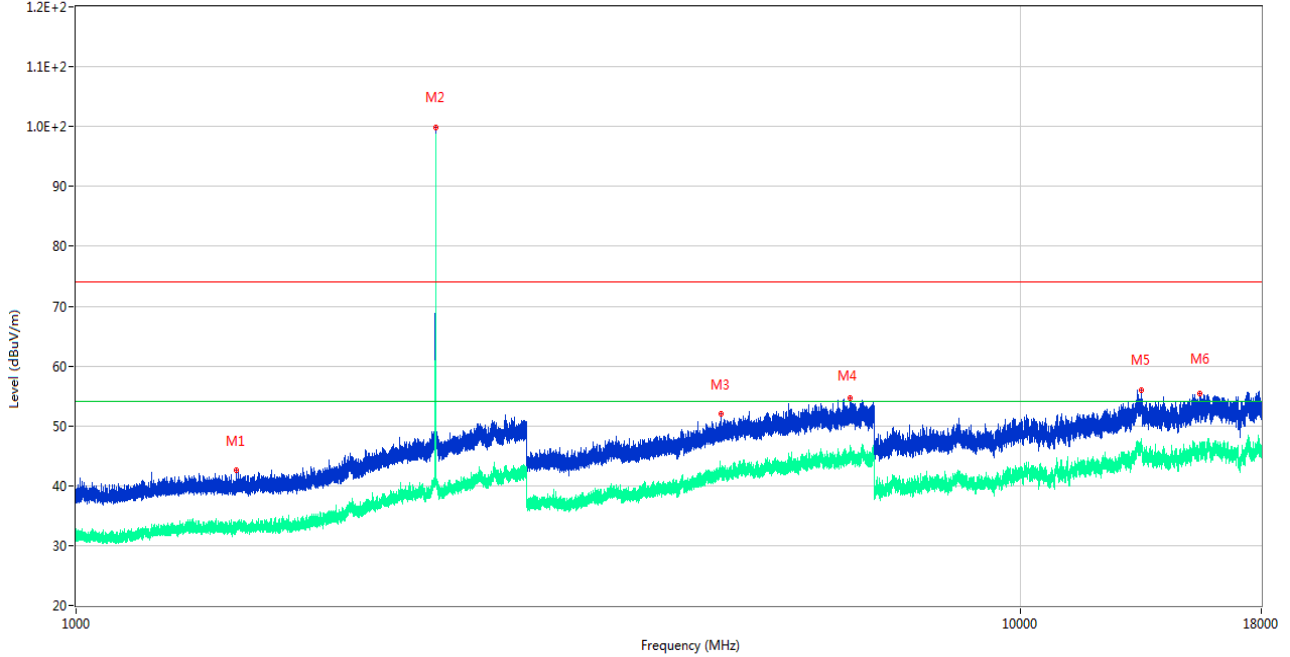

No.	Frequency (MHz)	Results (dBuV/m)	Factor (dB)	Limit (dBuV/m)	Margin (dB)	Detector	Table (Degree)	Height (cm)	Antenna	Verdict
1	1477.800	42.55	-17.20	74.0	31.45	Peak	92.00	200	Horizontal	Pass
1**	1477.800	32.91	-17.20	54.0	21.09	AV	92.00	200	Horizontal	Pass
2	2404.500	99.89	-9.99	74.0	-25.89	Peak	123.00	200	Horizontal	N/A
2**	2404.500	97.53	-9.99	54.0	-43.53	AV	123.00	200	Horizontal	N/A
3	4822.200	51.98	-2.12	74.0	22.02	Peak	132.00	100	Horizontal	Pass
3**	4822.200	41.97	-2.12	54.0	12.03	AV	132.00	100	Horizontal	Pass
4	6610.800	54.59	0.74	74.0	19.41	Peak	234.00	200	Horizontal	Pass
4**	6610.800	45.07	0.74	54.0	8.93	AV	234.00	200	Horizontal	Pass
5	13444.838	55.98	0.56	74.0	18.02	Peak	238.00	400	Horizontal	Pass
5**	13444.838	46.09	0.56	54.0	7.91	AV	238.00	400	Horizontal	Pass
6	15506.775	55.38	1.34	74.0	18.62	Peak	16.00	150	Horizontal	Pass
6**	15506.775	46.03	1.34	54.0	7.97	AV	16.00	150	Horizontal	PassN

GFSK (BLE 2Mbps) LOW CHANNEL 1 GHz to 18 GHz, ANT V

RE Test case_FCC Part 15C_FCC 15.247(2.4G)_1GHz-18GHz

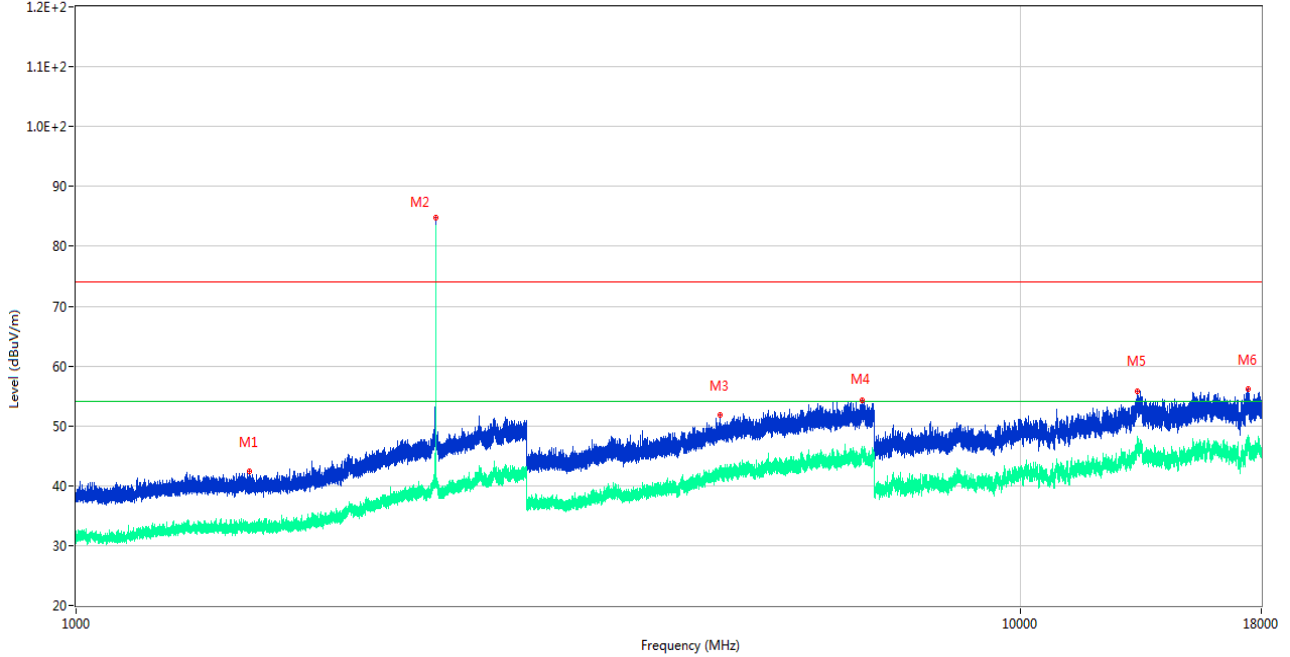

No.	Frequency (MHz)	Results (dBuV/m)	Factor (dB)	Limit (dBuV/m)	Margin (dB)	Detector	Table (Degree)	Height (cm)	Antenna	Verdict
1	1525.900	42.32	-17.34	74.0	31.68	Peak	34.00	200	Vertical	Pass
1**	1525.900	33.31	-17.34	54.0	20.69	AV	34.00	200	Vertical	Pass
2	2404.500	84.82	-9.99	74.0	-10.82	Peak	297.00	150	Vertical	N/A
2**	2404.500	81.31	-9.99	54.0	-27.31	AV	297.00	150	Vertical	N/A
3	4812.200	51.79	-2.10	74.0	22.21	Peak	40.00	200	Vertical	Pass
3**	4812.200	42.29	-2.10	54.0	11.71	AV	40.00	200	Vertical	Pass
4	6806.400	54.32	2.33	74.0	19.68	Peak	360.00	200	Vertical	Pass
4**	6806.400	45.93	2.33	54.0	8.07	AV	360.00	200	Vertical	Pass
5	13298.362	55.74	0.86	74.0	18.26	Peak	119.00	150	Vertical	Pass
5**	13298.362	46.57	0.86	54.0	7.43	AV	119.00	150	Vertical	Pass
6	17431.687	56.07	3.39	74.0	17.93	Peak	360.00	400	Vertical	Pass
6**	17431.687	47.91	3.39	54.0	6.09	AV	360.00	400	Vertical	Pass

GFSK (BLE 2Mbps) MIDDLE CHANNEL 1 GHz to 18 GHz, ANT H

RE Test case_FCC Part 15C_FCC 15.247(2.4G)_1GHz-18GHz

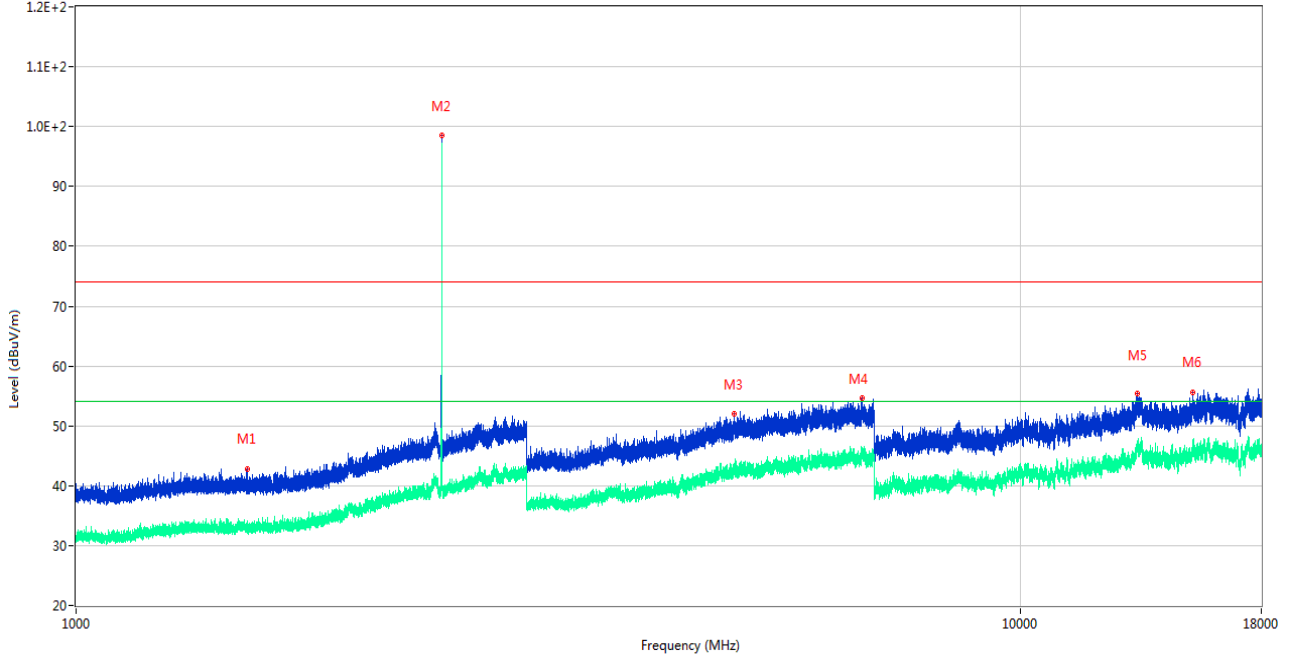

No.	Frequency (MHz)	Results (dBuV/m)	Factor (dB)	Limit (dBuV/m)	Margin (dB)	Detector	Table (Degree)	Height (cm)	Antenna	Verdict
1	1519.500	42.80	-17.27	74.0	31.20	Peak	119.00	400	Horizontal	Pass
1**	1519.500	32.81	-17.27	54.0	21.19	AV	119.00	400	Horizontal	Pass
2	2439.500	98.46	-12.37	74.0	-24.46	Peak	133.00	100	Horizontal	N/A
2**	2439.500	94.69	-12.37	54.0	-40.69	AV	133.00	100	Horizontal	N/A
3	4978.600	51.94	-1.61	74.0	22.06	Peak	151.00	100	Horizontal	Pass
3**	4978.600	43.31	-1.61	54.0	10.69	AV	151.00	100	Horizontal	Pass
4	6797.600	54.66	1.11	74.0	19.34	Peak	151.00	100	Horizontal	Pass
4**	6797.600	45.60	1.11	54.0	8.40	AV	151.00	100	Horizontal	Pass
5	13305.187	55.37	0.87	74.0	18.63	Peak	79.00	150	Horizontal	Pass
5**	13305.187	47.34	0.87	54.0	6.66	AV	79.00	150	Horizontal	Pass
6	15241.912	55.65	0.92	74.0	18.35	Peak	37.00	300	Horizontal	Pass
6**	15241.912	46.14	0.92	54.0	7.86	AV	37.00	300	Horizontal	Pass

GFSK (BLE 2Mbps) MIDDLE CHANNEL 1 GHz to 18 GHz, ANT V

RE Test case_FCC Part 15C_FCC 15.247(2.4G)_1GHz-18GHz

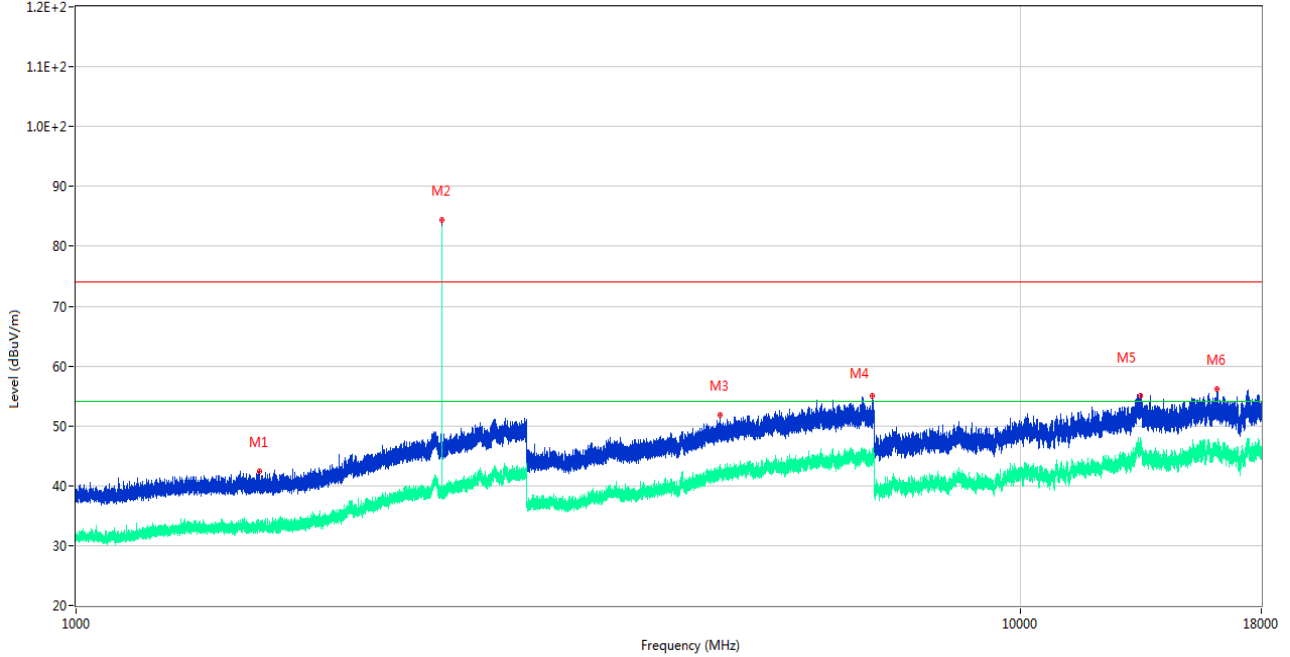

No.	Frequency (MHz)	Results (dBuV/m)	Factor (dB)	Limit (dBuV/m)	Margin (dB)	Detector	Table (Degree)	Height (cm)	Antenna	Verdict
1	1562.600	42.40	-16.87	74.0	31.60	Peak	39.00	300	Vertical	Pass
1**	1562.600	33.21	-16.87	54.0	20.79	AV	39.00	300	Vertical	Pass
2	2439.600	84.38	-12.38	74.0	-10.38	Peak	294.00	150	Vertical	N/A
2**	2439.600	81.58	-12.38	54.0	-27.58	AV	294.00	150	Vertical	N/A
3	4809.200	51.74	-2.10	74.0	22.26	Peak	250.00	100	Vertical	Pass
3**	4809.200	42.51	-2.10	54.0	11.49	AV	250.00	100	Vertical	Pass
4	6978.200	55.11	1.81	74.0	18.89	Peak	160.00	200	Vertical	Pass
4**	6978.200	45.05	1.81	54.0	8.95	AV	160.00	200	Vertical	Pass
5	13390.763	54.96	0.68	74.0	19.04	Peak	72.00	150	Vertical	Pass
5**	13390.763	45.44	0.68	54.0	8.56	AV	72.00	150	Vertical	Pass
6	16155.938	56.11	0.93	74.0	17.89	Peak	72.00	100	Vertical	Pass
6**	16155.938	45.13	0.93	54.0	8.87	AV	72.00	100	Vertical	Pass

GFSK (BLE 2Mbps) HIGH CHANNEL 1 GHz to 18 GHz, ANT H

RE Test case_FCC Part 15C_FCC 15.247(2.4G)_1GHz-18GHz

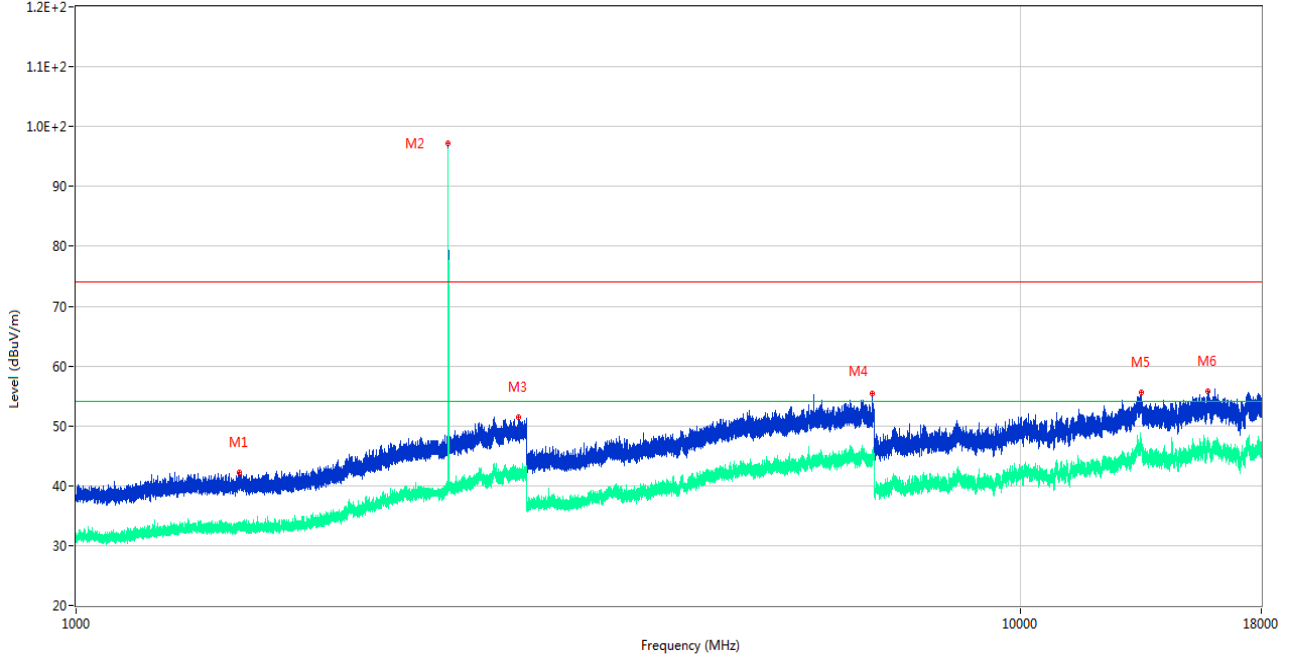

No.	Frequency (MHz)	Results (dBuV/m)	Factor (dB)	Limit (dBuV/m)	Margin (dB)	Detector	Table (Degree)	Height (cm)	Antenna	Verdict
1	1488.900	42.18	-16.77	74.0	31.82	Peak	342.00	150	Horizontal	Pass
1**	1488.900	33.66	-16.77	54.0	20.34	AV	342.00	150	Horizontal	Pass
2	2477.400	97.23	-11.61	74.0	-23.23	Peak	111.00	150	Horizontal	N/A
2**	2477.400	94.31	-11.61	54.0	-40.31	AV	111.00	150	Horizontal	N/A
3	2943.900	51.49	-9.32	74.0	22.51	Peak	175.00	200	Horizontal	Pass
3**	2943.900	41.57	-9.32	54.0	12.43	AV	175.00	200	Horizontal	Pass
4	6974.800	55.35	1.37	74.0	18.65	Peak	65.00	100	Horizontal	Pass
4**	6974.800	45.42	1.37	54.0	8.58	AV	65.00	100	Horizontal	Pass
5	13423.313	55.60	0.40	74.0	18.40	Peak	339.00	150	Horizontal	Pass
5**	13423.313	46.20	0.40	54.0	7.80	AV	339.00	150	Horizontal	Pass
6	15807.863	55.78	2.21	74.0	18.22	Peak	15.00	400	Horizontal	Pass
6**	15807.863	45.67	2.21	54.0	8.33	AV	15.00	400	Horizontal	Pass

GFSK (BLE 2Mbps) HIGH CHANNEL 1 GHz to 18 GHz, ANT V

RE Test case_FCC Part 15C_FCC 15.247(2.4G)_1GHz-18GHz

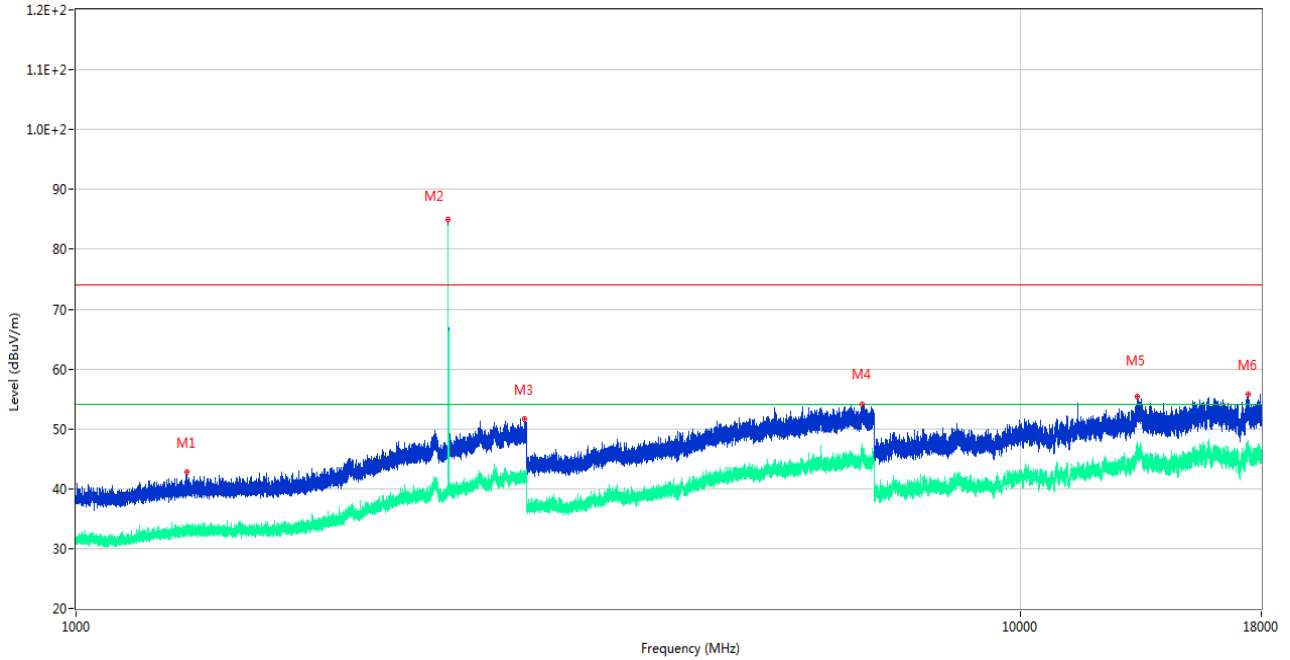

No.	Frequency (MHz)	Results (dBuV/m)	Factor (dB)	Limit (dBuV/m)	Margin (dB)	Detector	Table (Degree)	Height (cm)	Antenna	Verdict
1	1309.900	42.74	-16.97	74.0	31.26	Peak	58.00	300	Vertical	Pass
1**	1309.900	34.24	-16.97	54.0	19.76	AV	58.00	300	Vertical	Pass
2	2477.500	85.01	-11.61	74.0	-11.01	Peak	309.00	200	Vertical	N/A
2**	2477.500	82.25	-11.61	54.0	-28.25	AV	309.00	200	Vertical	N/A
3	2986.100	51.60	-9.05	74.0	22.40	Peak	219.00	200	Vertical	Pass
3**	2986.100	42.48	-9.05	54.0	11.52	AV	219.00	200	Vertical	Pass
4	6794.400	54.17	1.05	74.0	19.83	Peak	153.00	100	Vertical	Pass
4**	6794.400	45.00	1.05	54.0	9.00	AV	153.00	100	Vertical	Pass
5	13300.725	55.33	0.87	74.0	18.67	Peak	68.00	150	Vertical	Pass
5**	13300.725	45.77	0.87	54.0	8.23	AV	68.00	150	Vertical	Pass
6	17448.225	55.73	2.84	74.0	18.27	Peak	0.00	300	Vertical	Pass
6**	17448.225	45.67	2.84	54.0	8.33	AV	0.00	300	Vertical	Pass

A.7 Band Edge (Restricted-band band-edge)

Note ¹: The lowest and highest channels are tested to verify the band edge emissions. Please refer to the following the plots for emissions values.

Note ²: The test data all are tested in the vertical and horizontal antenna which the trace is max hold. So these plots have shown the worst case.

Note ³: According the ANSI C63.10-2013, where limits are specified for both average and peak (or quasi-peak) detector functions, if the peak (or quasi-peak) measured value complies with the average limit, it is unnecessary to perform an average measurement.

Note ⁴: The Level (dBuV/m) has been corrected by factor.

Test Data and Plots

ANT 0:

GFSK (BLE 1Mbps) LOW CHANNEL

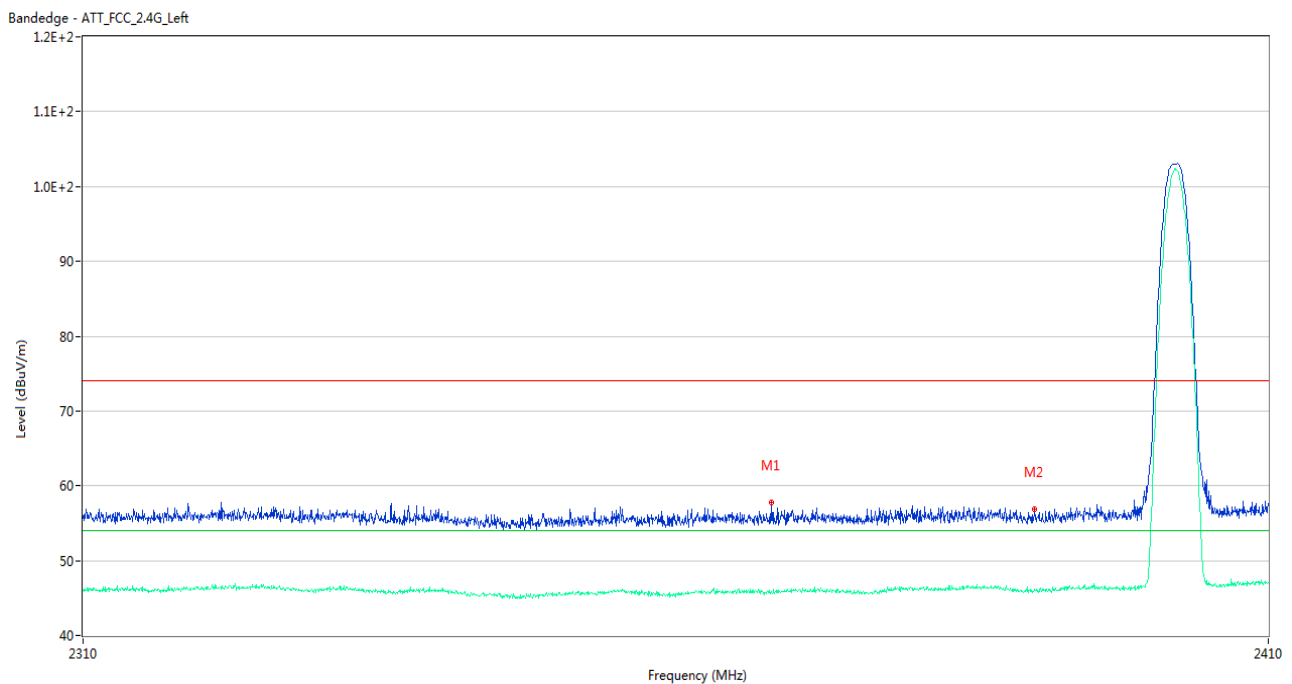

No.	Frequency (MHz)	Results (dBuV/m)	Factor (dB)	Limit (dBuV/m)	Margin (dB)	Detector	Table (Degree)	Height (cm)	Antenna	Verdict
1	2367.600	57.77	1.74	74.0	16.23	Peak	6.00	150	Horizontal	Pass
1**	2367.600	45.80	1.74	54.0	8.20	AV	6.00	150	Horizontal	Pass
2	2389.950	56.81	1.92	74.0	17.19	Peak	221.00	150	Horizontal	Pass
2**	2389.950	46.17	1.92	54.0	7.83	AV	221.00	150	Horizontal	Pass

GFSK (BLE 1Mbps) HIGH CHANNEL

Bandedge - ATT_FCC_2.4G_Right

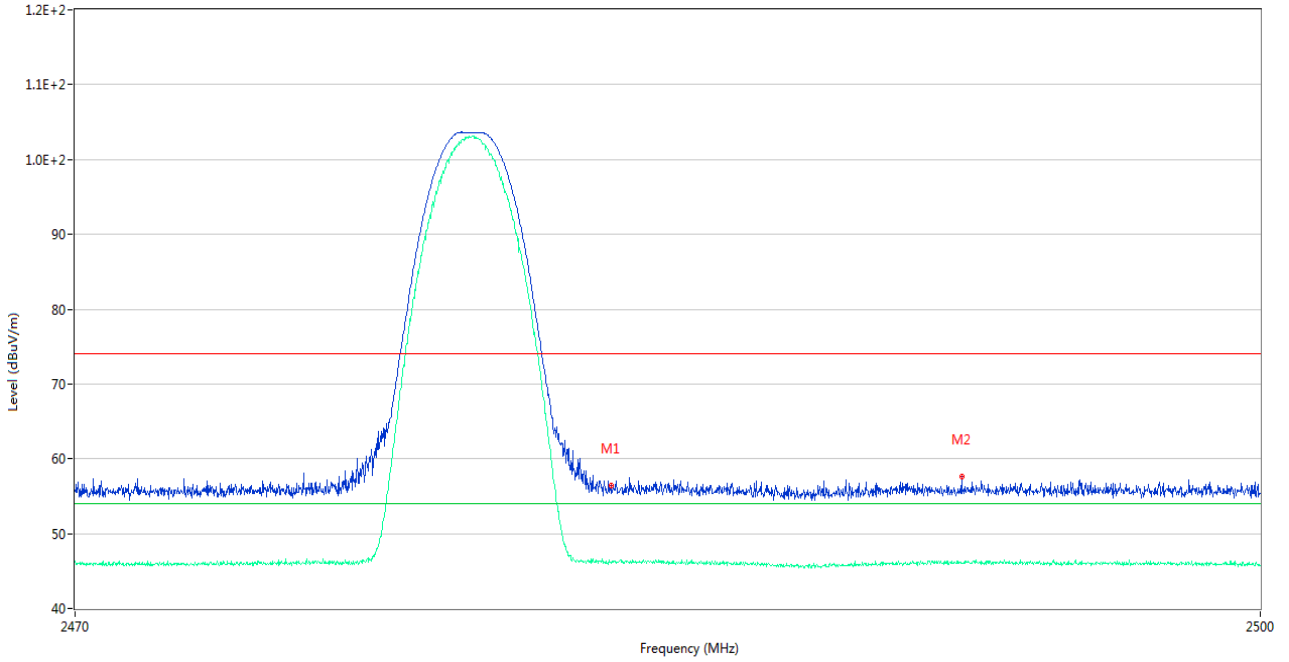

No.	Frequency (MHz)	Results (dBuV/m)	Factor (dB)	Limit (dBuV/m)	Margin (dB)	Detector	Table (Degree)	Height (cm)	Antenna	Verdict
1	2483.515	56.44	2.11	74.0	17.56	Peak	103.00	100	Horizontal	Pass
1**	2483.515	46.05	2.11	54.0	7.95	AV	103.00	100	Horizontal	Pass
2	2492.410	57.60	1.91	74.0	16.40	Peak	222.00	200	Horizontal	Pass
2**	2492.410	46.03	1.91	54.0	7.97	AV	222.00	200	Horizontal	Pass

GFSK (BLE 2Mbps) LOW CHANNEL

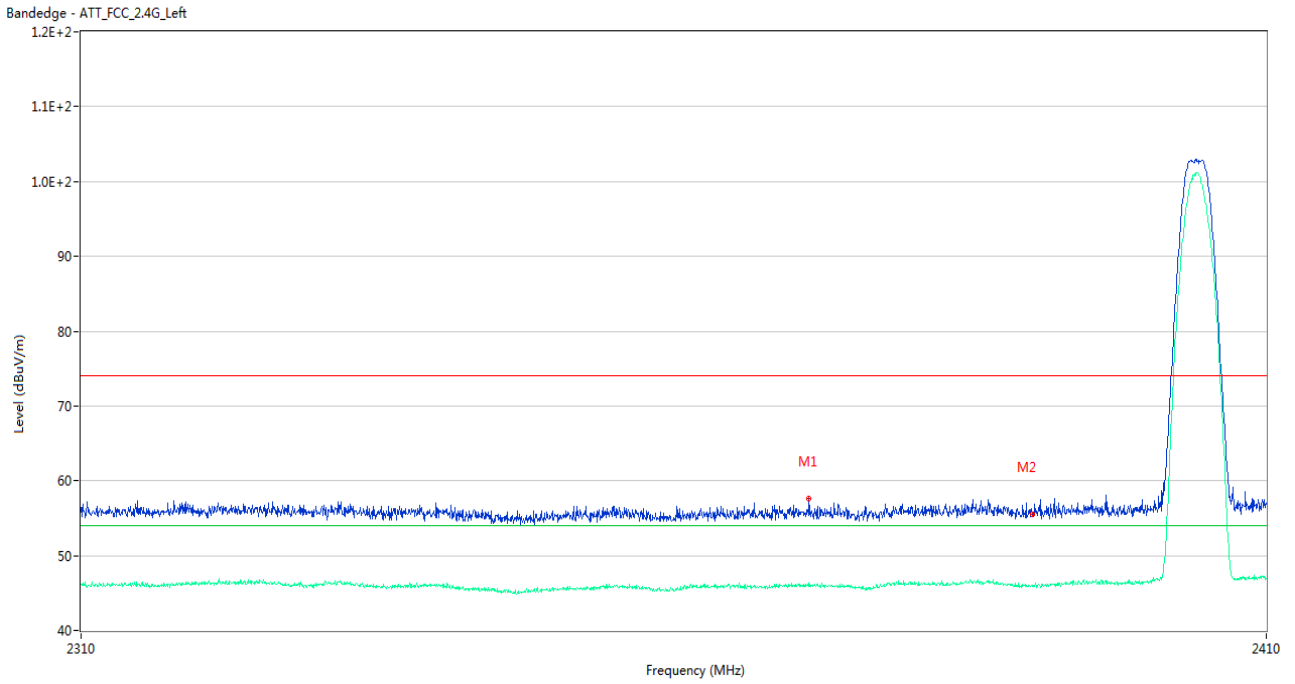

No.	Frequency (MHz)	Results (dBuV/m)	Factor (dB)	Limit (dBuV/m)	Margin (dB)	Detector	Table (Degree)	Height (cm)	Antenna	Verdict
1	2370.900	57.61	1.98	74.0	16.39	Peak	163.00	150	Horizontal	Pass
1**	2370.900	45.88	1.98	54.0	8.12	AV	163.00	150	Horizontal	Pass
2	2389.950	55.56	1.92	74.0	18.44	Peak	184.00	100	Horizontal	Pass
2**	2389.950	46.04	1.92	54.0	7.96	AV	184.00	100	Horizontal	Pass

GFSK (BLE 2Mbps) HIGH CHANNEL

Bandedge - ATT_FCC_2.4G_Right

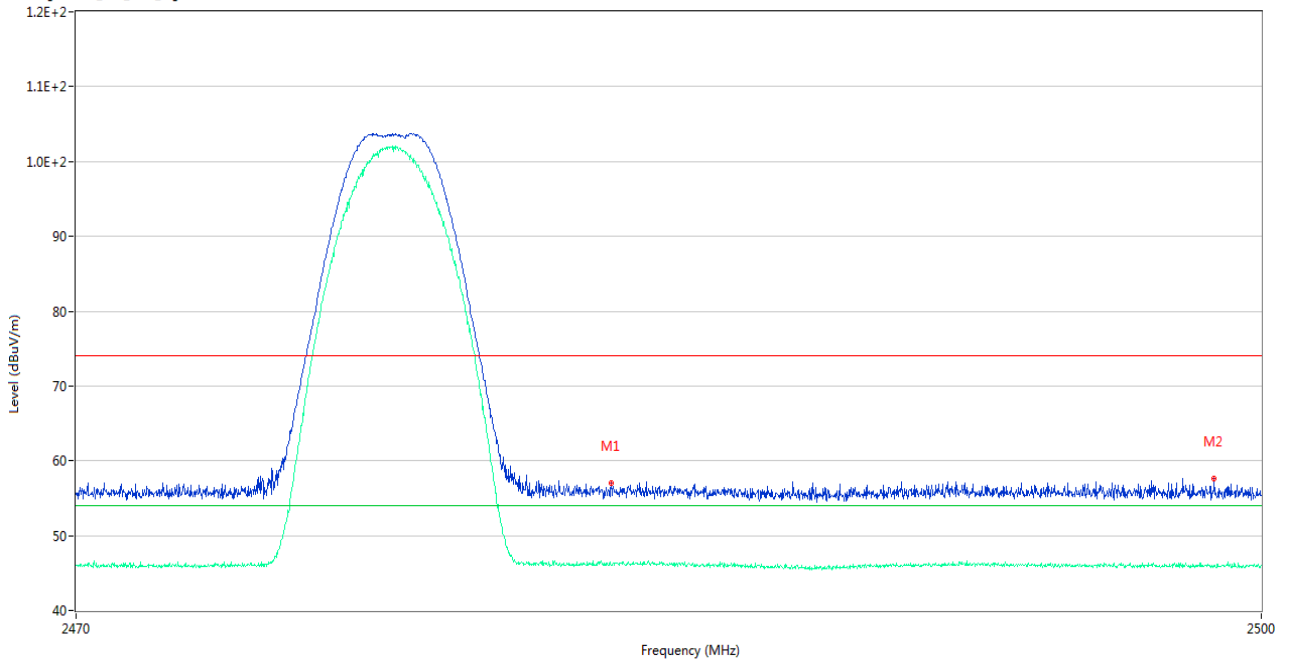

No.	Frequency (MHz)	Results (dBuV/m)	Factor (dB)	Limit (dBuV/m)	Margin (dB)	Detector	Table (Degree)	Height (cm)	Antenna	Verdict
1	2483.500	57.00	2.11	74.0	17.00	Peak	53.00	150	Horizontal	Pass
1**	2483.500	46.01	2.11	54.0	7.99	AV	53.00	150	Horizontal	Pass
2	2498.800	57.61	1.65	74.0	16.39	Peak	275.00	150	Horizontal	Pass
2**	2498.800	45.85	1.65	54.0	8.15	AV	275.00	150	Horizontal	Pass

ANT 1:

GFSK (BLE 1Mbps) LOW CHANNEL

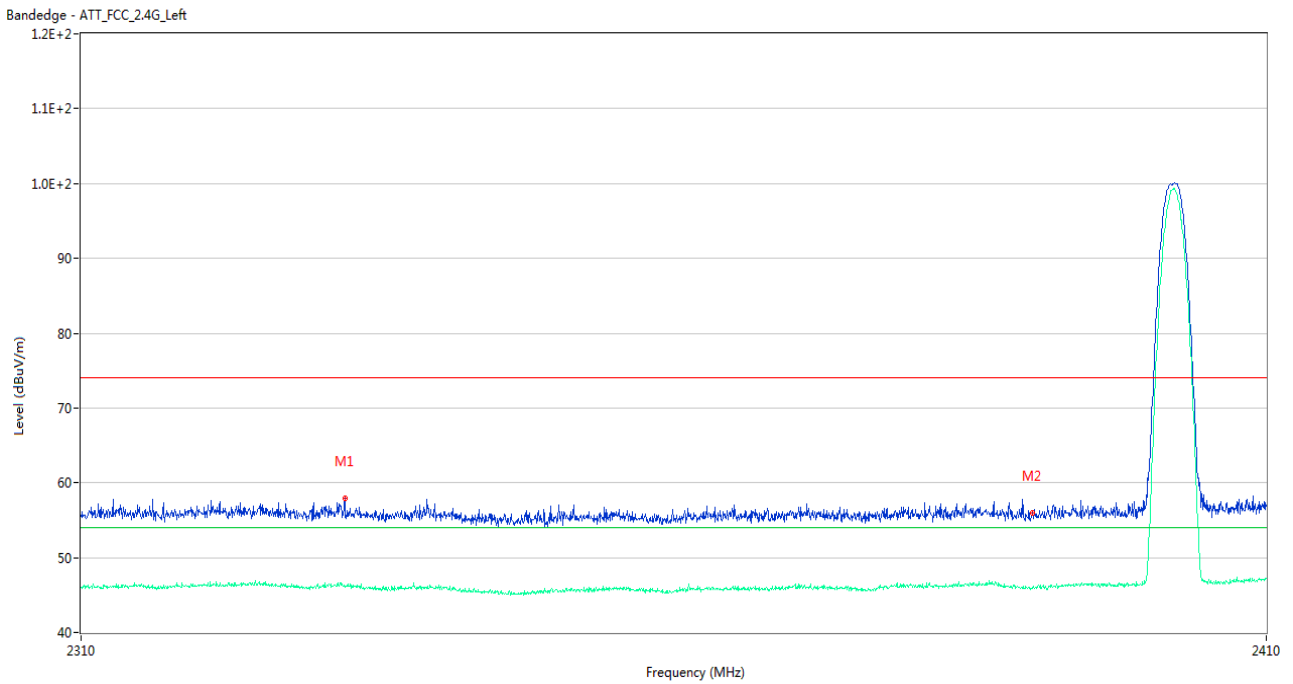

No.	Frequency (MHz)	Results (dBuV/m)	Factor (dB)	Limit (dBuV/m)	Margin (dB)	Detector	Table (Degree)	Height (cm)	Antenna	Verdict
1	2331.900	57.86	1.49	74.0	16.14	Peak	359.00	200	Horizontal	Pass
1**	2331.900	46.09	1.49	54.0	7.91	AV	359.00	200	Horizontal	Pass
2	2389.950	56.01	1.92	74.0	17.99	Peak	198.00	150	Horizontal	Pass
2**	2389.950	46.09	1.92	54.0	7.91	AV	198.00	150	Horizontal	Pass

GFSK (BLE 1Mbps) HIGH CHANNEL

Bandedge - ATT_FCC_2.4G_Right

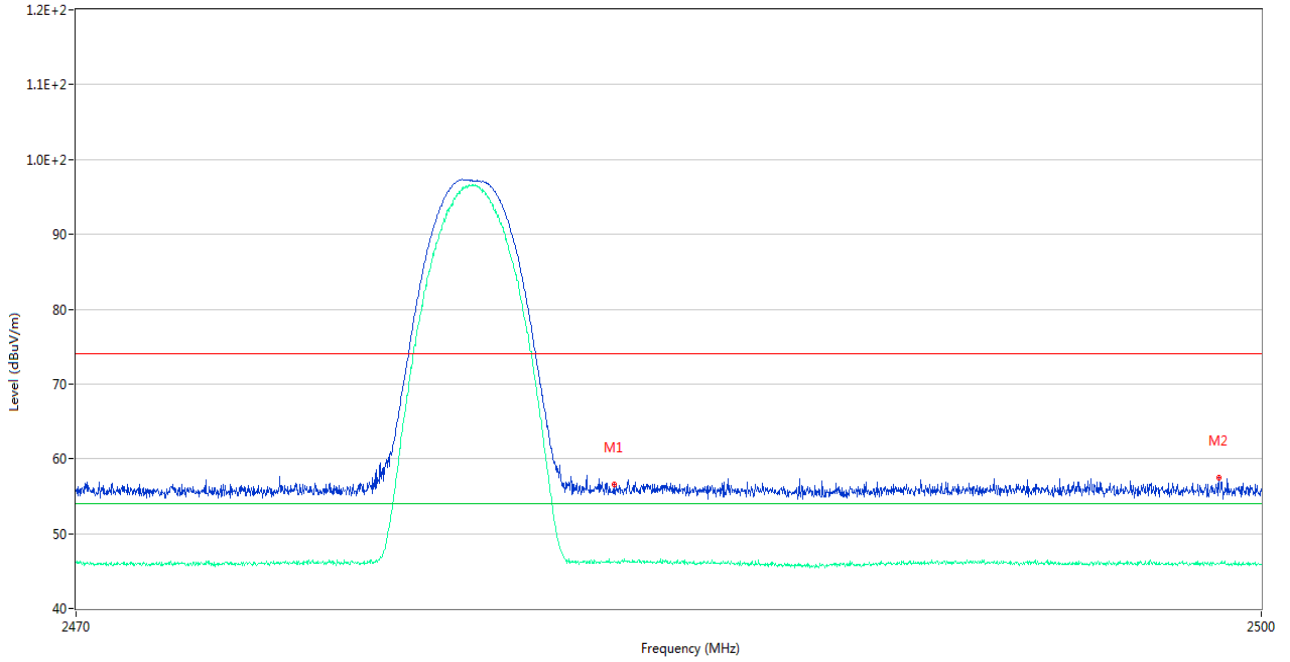

No.	Frequency (MHz)	Results (dBuV/m)	Factor (dB)	Limit (dBuV/m)	Margin (dB)	Detector	Table (Degree)	Height (cm)	Antenna	Verdict
1	2483.575	56.57	2.11	74.0	17.43	Peak	118.00	150	Horizontal	Pass
1**	2483.575	46.32	2.11	54.0	7.68	AV	118.00	150	Horizontal	Pass
2	2498.920	57.50	1.65	74.0	16.50	Peak	328.00	200	Horizontal	Pass
2**	2498.920	45.88	1.65	54.0	8.12	AV	328.00	200	Horizontal	Pass

GFSK (BLE 2Mbps) LOW CHANNEL

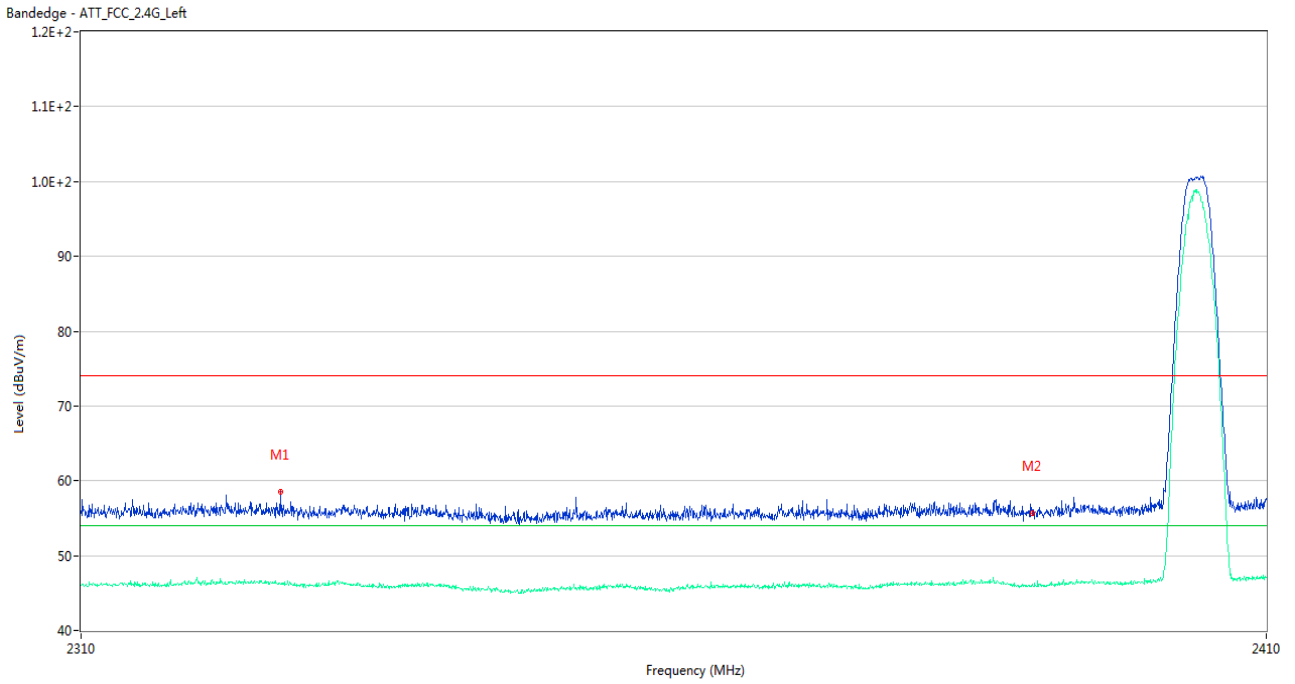

No.	Frequency (MHz)	Results (dBuV/m)	Factor (dB)	Limit (dBuV/m)	Margin (dB)	Detector	Table (Degree)	Height (cm)	Antenna	Verdict
1	2326.500	58.56	1.49	74.0	15.44	Peak	118.00	100	Horizontal	Pass
1**	2326.500	46.15	1.49	54.0	7.85	AV	118.00	100	Horizontal	Pass
2	2389.950	55.72	1.92	74.0	18.28	Peak	157.00	100	Horizontal	Pass
2**	2389.950	46.13	1.92	54.0	7.87	AV	157.00	100	Horizontal	Pass

GFSK (BLE 2Mbps) HIGH CHANNEL

Bandedge - ATT_FCC_2.4G_Right

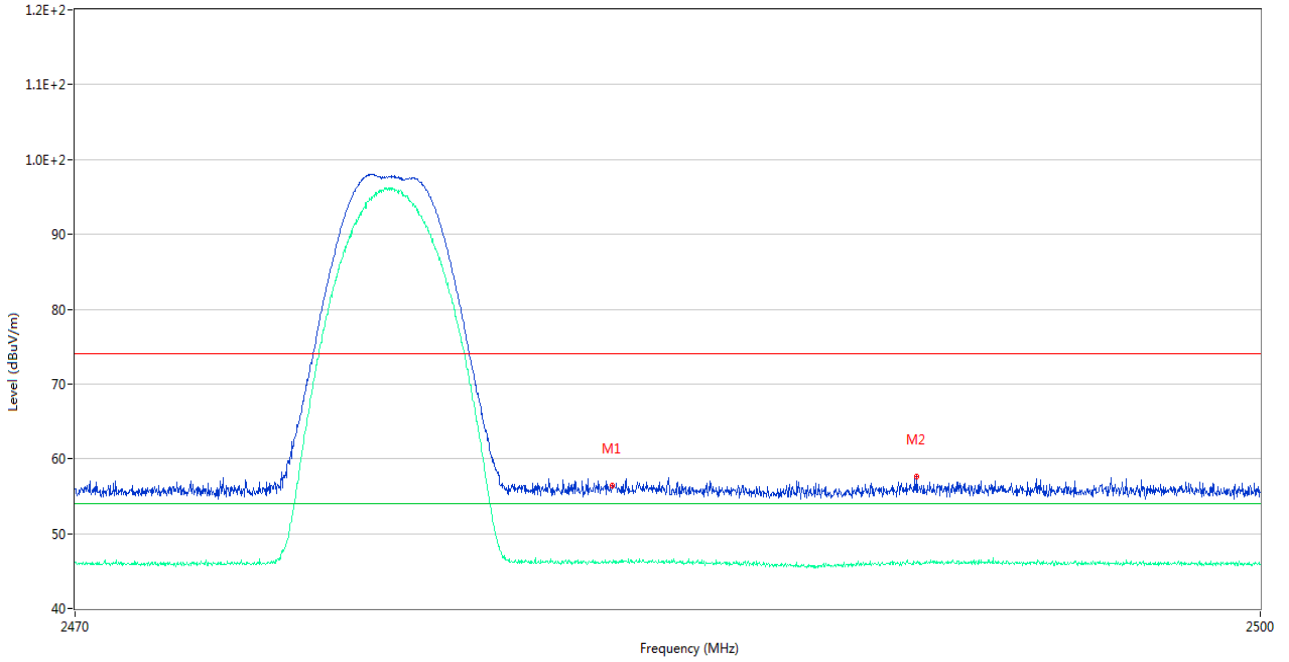

No.	Frequency (MHz)	Results (dBuV/m)	Factor (dB)	Limit (dBuV/m)	Margin (dB)	Detector	Table (Degree)	Height (cm)	Antenna	Verdict
1	2483.560	56.37	2.11	74.0	17.63	Peak	298.00	200	Horizontal	Pass
1**	2483.560	46.16	2.11	54.0	7.84	AV	298.00	200	Horizontal	Pass
2	2491.270	57.59	1.85	74.0	16.41	Peak	360.00	200	Horizontal	Pass
2**	2491.270	46.19	1.85	54.0	7.81	AV	360.00	200	Horizontal	Pass

A.8 Power Spectral Density (PSD)

Test Data

ANT 0:

GFSK (BLE 1Mbps)			
Channel	Spectral power density (dBm/3kHz)	Limit (dBm/3kHz)	Verdict
Low Channel	-7.89	8	Pass
Middle Channel	-7.93	8	Pass
High Channel	-10.01	8	Pass

GFSK (BLE 2Mbps)			
Channel	Spectral power density (dBm/3kHz)	Limit (dBm/3kHz)	Verdict
Low Channel	-10.35	8	Pass
Middle Channel	-10.57	8	Pass
High Channel	-12.20	8	Pass

ANT 1:

GFSK (BLE 1Mbps)			
Channel	Spectral power density (dBm/3kHz)	Limit (dBm/3kHz)	Verdict
Low Channel	-9.55	8	Pass
Middle Channel	-8.80	8	Pass
High Channel	-9.60	8	Pass

GFSK (BLE 2Mbps)			
Channel	Spectral power density (dBm/3kHz)	Limit (dBm/3kHz)	Verdict
Low Channel	-11.85	8	Pass
Middle Channel	-11.49	8	Pass
High Channel	-11.89	8	Pass

Test Plots

ANT 0:

GFSK (BLE 1Mbps) LOW CHANNEL



GFSK (BLE 1Mbps) MIDDLE CHANNEL



GFSK (BLE 1Mbps) HIGH CHANNEL



GFSK (BLE 2Mbps) LOW CHANNEL

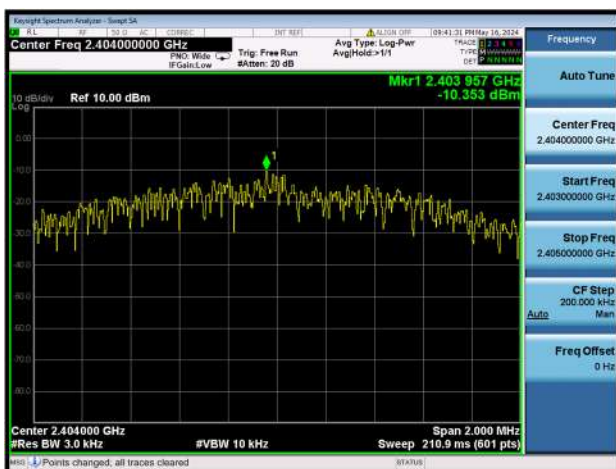

GFSK (BLE 2Mbps) MIDDLE CHANNEL

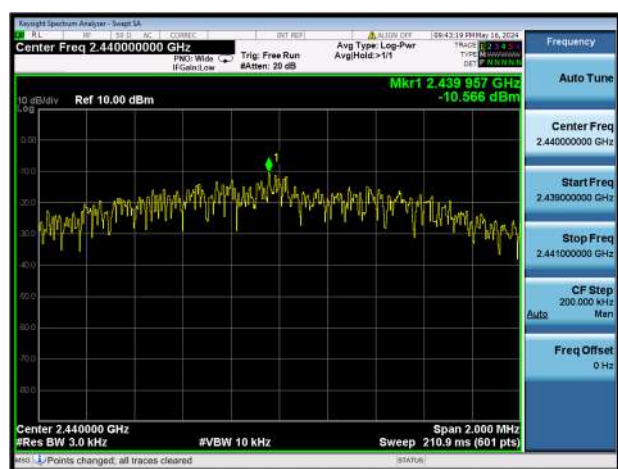

GFSK (BLE 2Mbps) HIGH CHANNEL



ANT 1:

GFSK (BLE 1Mbps) LOW CHANNEL



GFSK (BLE 1Mbps) MIDDLE CHANNEL



GFSK (BLE 1Mbps) HIGH CHANNEL



GFSK (BLE 2Mbps) LOW CHANNEL

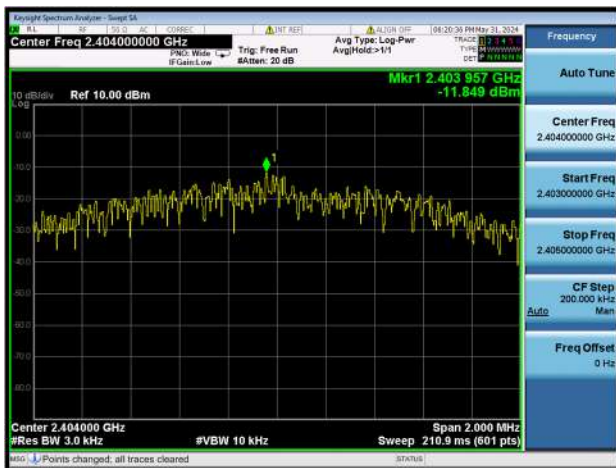

GFSK (BLE 2Mbps) MIDDLE CHANNEL

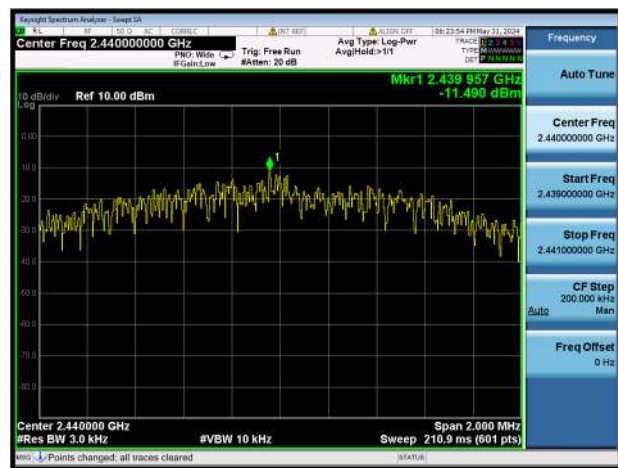

GFSK (BLE 2Mbps) HIGH CHANNEL

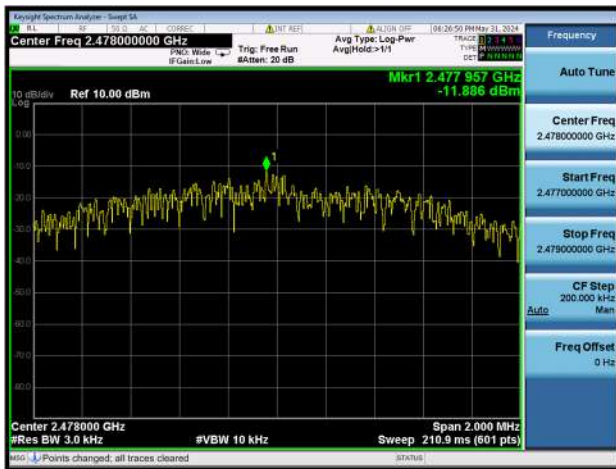

ANNEX B TEST SETUP PHOTOS

Please refer the document “BL-SZ2441449-AR.PDF”.

ANNEX C EUT EXTERNAL PHOTOS

Please refer the document “BL-SZ2441449-AW.PDF”.

ANNEX D EUT INTERNAL PHOTOS

Please refer the document “BL-SZ2441449-AI.PDF”.

Statement

1. The laboratory guarantees the scientificity, accuracy and impartiality of the test, and is responsible for all the information in the report, except the information provided by the customer. The customer is responsible for the impact of the information provided on the validity of the results.
2. The report without China inspection body and laboratory Mandatory Approval (CMA) mark has no effect of proving to the society.
3. For the report with CNAS mark or A2LA mark, the items marked with "☆" are not within the accredited scope.
4. This report is invalid if it is altered, without the signature of the testing and approval personnel, or without the "inspection and testing dedicated stamp" or test report stamp.
5. The test data and results are only valid for the tested samples provided by the customer.
6. This report shall not be partially reproduced without the written permission of the laboratory.
7. Any objection shall be raised to the laboratory within 30 days after receiving the report.

--END OF REPORT--