



# TEST REPORT

No.I22N02450-NFC

for

**Realme Chongqing Mobile Telecommunications Corp., Ltd.**

**Mobile Phone**

**Model Name: RMX3710**

with

**Hardware Version: 11**

**Software Version: ColorOS 13.0**

**FCC ID: 2AUYFRMX3710**

**Issued Date: 2022-12-19**

**Designation Number: CN1210**

**Note:**

The test results in this test report relate only to the devices specified in this report. This report shall not be reproduced except in full without the written approval of SAICT.

**Test Laboratory:**

**SAICT, Shenzhen Academy of Information and Communications Technology**

Building G, Shenzhen International Innovation Center, No.1006 Shennan Road, Futian District, Shenzhen, Guangdong, P. R. China 518000.

Tel:+86(0)755-33322000, Fax:+86(0)755-33322001

Email: yewu@caict.ac.cn. [www.saict.ac.cn](http://www.saict.ac.cn)

©Copyright. All rights reserved by SAICT.



## **REPORT HISTORY**

<b>Report Number</b>	<b>Revision</b>	<b>Description</b>	<b>Issue Date</b>
I22N02450-NFC	Rev.0	1st edition	2022-12-19

Note: the latest revision of the test report supersedes all previous versions.



## **CONTENTS**

<b>1. SUMMARY OF TEST REPORT</b> .....	<b>4</b>
1.1. TEST ITEMS .....	4
1.2. TEST STANDARDS .....	4
1.3. TEST RESULT .....	4
1.4. TESTING LOCATION .....	4
1.5. PROJECT DATA .....	4
1.6. SIGNATURE .....	4
<b>2. CLIENT INFORMATION</b> .....	<b>5</b>
2.1. APPLICANT INFORMATION .....	5
2.2. MANUFACTURER INFORMATION .....	5
<b>3. EQUIPMENT UNDER TEST (EUT) AND ANCILLARY EQUIPMENT (AE)</b> .....	<b>6</b>
3.1. ABOUT EUT .....	6
3.2. INTERNAL IDENTIFICATION OF EUT USED DURING THE TEST .....	6
3.3. INTERNAL IDENTIFICATION OF AE USED DURING THE TEST .....	6
3.4. GENERAL DESCRIPTION .....	7
3.5. EUT SET-UPS .....	7
<b>4. REFERENCE DOCUMENTS</b> .....	<b>8</b>
4.1. DOCUMENTS SUPPLIED BY APPLICANT .....	8
4.2. REFERENCE DOCUMENTS FOR TESTING .....	8
<b>5. TEST RESULTS</b> .....	<b>9</b>
5.1. TESTING ENVIRONMENT .....	9
5.2. TEST RESULTS .....	9
5.3. STATEMENTS .....	9
<b>6. TEST EQUIPMENTS UTILIZED</b> .....	<b>10</b>
<b>7. LABORATORY ENVIRONMENT</b> .....	<b>11</b>
<b>8. MEASUREMENT UNCERTAINTY</b> .....	<b>12</b>
<b>ANNEX A: MEASUREMENT RESULTS</b> .....	<b>13</b>
A.1. ELECTRIC FIELD STRENGTH OF FUNDAMENTAL AND OUTSIDE THE ALLOCATED BANDS .....	13
A.2. ELECTRIC FIELD RADIATED EMISSIONS (<30MHz) .....	15
A.3. ELECTRIC FIELD RADIATED EMISSIONS (≥30MHz) .....	17
A.4. FREQUENCY TOLERANCE .....	19
A.5. 20dB BANDWIDTH .....	21
A.6. CONDUCTED EMISSION .....	23



## 1. Summary of Test Report

### 1.1. Test Items

Description	Mobile Phone
Model Name	RMX3710
Applicant's name	Realme Chongqing Mobile Telecommunications Corp., Ltd.
Manufacturer's Name	Realme Chongqing Mobile Telecommunications Corp., Ltd.

### 1.2. Test Standards

FCC Part15-2021; ANSI C63.10-2013; ANSI C63.4-2014.

### 1.3. Test Result

#### **Pass**

Please refer to "5.2. Test Results"

### 1.4. Testing Location

Address: Building G, Shenzhen International Innovation Center, No.1006 Shennan Road, Futian District, Shenzhen, Guangdong, P. R. China 51800

### 1.5. Project data

Testing Start Date:	2022-12-09
Testing End Date:	2022-12-13

### 1.6. Signature

---

Lin Zechuang  
(Prepared this test report)

---

An Ran  
(Reviewed this test report)

---

Zhang Bojun  
(Approved this test report)



## **2. Client Information**

### **2.1. Applicant Information**

Company Name: Realme Chongqing Mobile Telecommunications Corp., Ltd.  
Address: No.178 Yulong Avenue,Yufengshan,Yubei District,Chongqing,China  
Contact Person Yang LiangPing  
E-Mail ylp@realme.net  
Telephone: (86)13798864426  
Fax: /

### **2.2. Manufacturer Information**

Company Name: Realme Chongqing Mobile Telecommunications Corp., Ltd.  
Address: No.178 Yulong Avenue,Yufengshan,Yubei District,Chongqing,China  
Contact Person Yang LiangPing  
E-Mail ylp@realme.net  
Telephone: (86)13798864426  
Fax: /



### **3. Equipment Under Test (EUT) and Ancillary Equipment (AE)**

#### **3.1. About EUT**

Description	Mobile Phone
Model Name	RMX3710
Frequency	13.56MHz
Equipment type	Near Field Communication (NFC)
Antenna type	Integrated antenna
Power Supply	3.87V DC by Battery
FCC ID	2AUYFRMX3710
Condition of EUT as received	No abnormality in appearance

Note: Components list, please refer to documents of the manufacturer; it is also included in the original test record of Shenzhen Academy of Information and Communications Technology.

#### **3.2. Internal Identification of EUT used during the test**

<b>EUT ID*</b>	<b>SN or IMEI</b>	<b>HW Version</b>	<b>SW Version</b>	<b>Date of Receipt</b>
UT08aa	863851060019892	11	ColorOS 13.0	2022-11-22
	860022060024869			
UT01aa	863851060019934	11	ColorOS 13.0	2022-11-22
	863851060019926			

\*EUT ID: is used to identify the test sample in the lab internally.

UT08aa is used for conduction test, UT01aa is used for radiation test and AC Power line Conducted Emission test.

#### **3.3. Internal Identification of AE used during the test**

<b>AE No.</b>	<b>Description</b>	<b>AE ID*</b>
AE1	Power Supply	/
AE2	NFC Card	/
AE3	Battery	/
AE4	Charger	/
AE5	USB Cable	/
AE6	Headset	/

AE1/AE2

/

AE3

Model	BLP875
Manufacturer	Sunwoda Electronic Co.Ltd.
Capacity	4880mAh
Nominal Voltage	3.87 V

AE4

Model	VCB3HDUH
-------	----------



Manufacturer	Shenzhen Huntkey Chiyuan Electric Co., LTD
Specification	American Standard Charger
AE5	
Model	DL150
Manufacturer	/
AE6	
Model	MH156
Manufacturer	/

\*AE ID and AE Label: is used to identify the test sample in the lab internally.

### **3.4. General Description**

Equipment under Test (EUT) is a model of Mobile Phone with FPC+ferrite antenna and battery. It consists of normal options: Lithium Battery, Charger, USB Cable and Headset.

Manual and specifications of the EUT were provided to fulfil the test.

Samples undergoing test were selected by the client.

### **3.5. EUT Set-ups**

<b>EUT Set-up No.</b>	<b>Combination of EUT and AE</b>	<b>Remarks</b>
Set. NFC01	EUT+AE1+AE2	NFC RF, TX test
Set. NFC02	EUT+AE1	NFC RF, RX test

CE\_test.apk is installed in the EUT which helps to control the NFC signal transmitting.

The Transmit State of NFC: the NFC function is on. The EUT will transmit the NFC data and command continuously during the test.

The Transmit State without modulation: The EUT will transmit the CW signal at the operating frequency.



## **4. Reference Documents**

### **4.1. Documents supplied by applicant**

EUT feature information is supplied by the applicant or manufacturer, which is the basis of testing.

### **4.2. Reference Documents for testing**

The following documents listed in this section are referred for testing.

<b>Reference</b>	<b>Title</b>	<b>Version</b>
FCC Part 15	FCC CFR 47, Part 15, Subpart C	2021
ANSI C63.10	American National Standard of Procedures for Compliance Testing of Unlicensed Wireless Devices	2013
ANSI C63.4	American National Standard for Methods of Measurement of Radio-Noise Emissions from Low-Voltage Electrical and Electronic Equipment in the Range of 9 kHz to 40 GHz.	2014





## 5. Test Results

### 5.1. Testing Environment

Normal Temperature: 15~35°C

Relative Humidity: 20~75%

### 5.2. Test Results

No	Test Cases	Sub-clause of Part 15C	Verdict
1	Electric Field Strength of Fundamental and Outside the Allocated bands	15.225	<b>P</b>
2	Electric Field Radiated Emissions	15.209,15.225(d)	<b>P</b>
3	Frequency Tolerance	15.225(e)	<b>P</b>
4	20dB Bandwidth	15.215(c)	<b>P</b>
5	Conducted Emissions	15.207	<b>P</b>

The measurement is carried out according to ANSI C63.10 and ANSI C63.4.

See **ANNEX A** for details.

### 5.3. Statements

The test cases listed in Section 5.2 of this report for the EUT specified in Section 3 were performed by SAICT according to the reference documents in Section 4.

The EUT meets all applicable requirements of the regulations and standards in Section 4.2.

This report only deals with the NFC function among the features described in section 3.

Disclaimer:

A. After confirmation with the customer, the sample information provided by the customer may affect the validity of the measurement results in this report, and the impact and consequences arising therefrom shall be borne by the customer.

B. The samples in this report are provided by the customer, and the test results are only applicable to the samples received.

## 6. Test Equipments Utilized

### Conducted test system

No.	Equipment	Model	Serial Number	Manufacturer	Calibration Due date	Calibration Period
1	Vector Signal Analyzer	FSV40	100903	Rohde & Schwarz	2022-12-29	1 year
2	DC Power Supply	NGSM	5425	Rohde & Schwarz	2023-11-06	1 year
3	Shielding Room	S81	CT000986-1344	ETS-Lindgren	2026-09-12	5 years

### Climate chamber

No.	Equipment	Model	Serial Number	Manufacturer	Calibration Due date	Calibration Period
1	Climate chamber	SU-242	93008165	ESPEC	2023-03-13	1 year

### Radiated emission test system

No.	Equipment	Model	Serial Number	Manufacturer	Calibration Due date	Calibration Period
1	Test Receiver	ESR7	101676	Rohde & Schwarz	2023-11-23	1 year
2	BiLog Antenna	3142E	0224831	ETS-Lindgren	2024-05-27	3 years
3	Anechoic Chamber	FACT3-2.0	1285	ETS-Lindgren	2023-05-29	2 years
4	Loop Antenna	HLA6120	35779	TESEQ	2025-05-12	3 years
5	Test Receiver	ESCI	100702	Rohde & Schwarz	2023-01-12	1 year
6	LISN	ENV216	102067	Rohde & Schwarz	2023-07-14	1 year

### Test software

No.	Equipment	Manufacturer	Version
1	JS1120-3	Tonscend	3.2
2	EMC32	Rohde & Schwarz	10.50.40

## 7. Laboratory Environment

### Shielded room

Temperature	Min. = 15 °C, Max. = 35 °C
Relative humidity	Min. = 20 %, Max. = 75 %
Shielding effectiveness	0.014MHz-1MHz> 60 dB; 1MHz-18000MHz>90 dB
Electrical insulation	> 2M $\Omega$
Ground system resistance	< 4 $\Omega$

### Anechoic chamber

Temperature	Min. = 15 °C, Max. = 35 °C
Relative humidity	Min. = 20 %, Max. = 75 %
Shielding effectiveness	0.014MHz-1MHz> 60 dB; 1MHz-18000MHz>90 dB
Electrical insulation	> 2M $\Omega$
Ground system resistance	< 4 $\Omega$
Normalised site attenuation (NSA)	< $\pm$ 4 dB, 3 m distance, from 30 to 1000 MHz
Voltage Standing Wave Ratio (VSWR)	$\leq$ 6 dB, from 1 to 18 GHz, 3m distance
Uniformity of field strength	Between 0 and 6 dB, from 80 to 6000 MHz



## 8. Measurement Uncertainty

Test Name	Uncertainty ( $k=2$ )
1.Electric Field Strength of Fundamental and Outside the Allocated bands	1.79dB
2.Electric Field Radiated Emissions (<30MHz)	1.79dB
3.Electric Field Radiated Emissions ( $\geq 30$ MHz)	4.86dB
4.Frequency Tolerance	4.56kHz
5.20dB Bandwidth	4.56kHz
6.Conducted emission	2.62dB

## **ANNEX A: MEASUREMENT RESULTS**

### **A.1. Electric Field Strength of Fundamental and Outside the Allocated bands**

#### **A.1.1. Reference**

See CFR 47 § 15.225

#### **A.1.2. Measurement Methods**

The transmitter carrier output levels (E-Field) from the EUT are measured in a semi-anechoic chamber. The EUT is placed on a non-conductive stand of 80cm high, and at a measurement distance of 3m from the receiving antenna. The center of the receiving loop antenna is 1.0 meter above the ground. The E-field is measured with a shielded loop antenna connected to a measurement receiver. Detected E-field was maximized by rotating the EUT through 360° and adjusting the receiving antenna polarizations. The maximization processes were repeated with the EUT positioned respectively in its three orthogonal axes. The measurements were performed with the peak detector and if required, the quasi-peak detector.

The measurement bandwidth is:

<b>Frequency of Emission (MHz)</b>	<b>RBW/VBW</b>
12.56-14.56	10/30 kHz

The E-field measured at 3m is calculated as:

$$\text{E-field (dB}\mu\text{V/m)} = \text{Rx (dB}\mu\text{V)} + \text{Cable Loss (dB)} + \text{AF@3m (dB/m)}$$

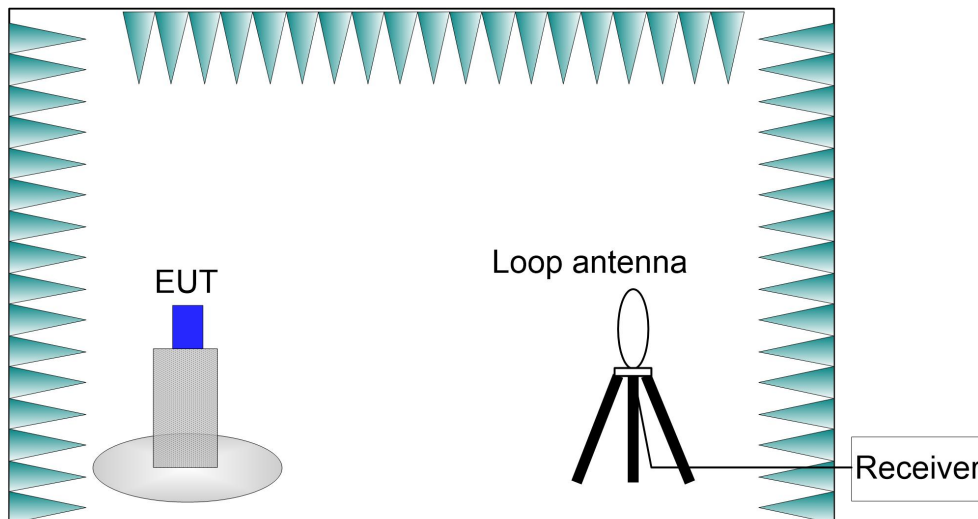

#### **A.1.3. EUT Operating Mode and Test Conditions**

The measurement of EUT is carried out under the transmit state of NFC (See 3.5).

The EUT is powered by a travel adapter.

During the measurements, the ambient temperature of the electromagnetic anechoic chamber is in the range of 15 ~ 25°C.

**A.1.4. Limits**

Frequency Range (MHz)	E-field Strength Limit @ 30 m ( $\mu\text{V}/\text{m}$ )	E-field Strength Limit @ 3 m ( $\text{dB}\mu\text{V}/\text{m}$ )
13.560 $\pm$ 0.007	+15,848	124
13.410 to 13.553 13.567 to 13.710	+334	90
13.110 to 13.410 13.710 to 14.010	+106	81

Note: Where the limits have been defined at one distance, and a signal level measured at another, the limits have been extrapolated using the following formula:

$$\text{Extrapolation (dB)} = 40 * \log_{10}(\text{Measurement Distance} / \text{Specification Distance})$$

**A.1.5. Measurement Results**

Measurement results of normal conditions see Figure A-1 for different set-ups of EUT. The result displayed take into account applicable antenna factors and cable losses.

**Conclusions: PASS.**

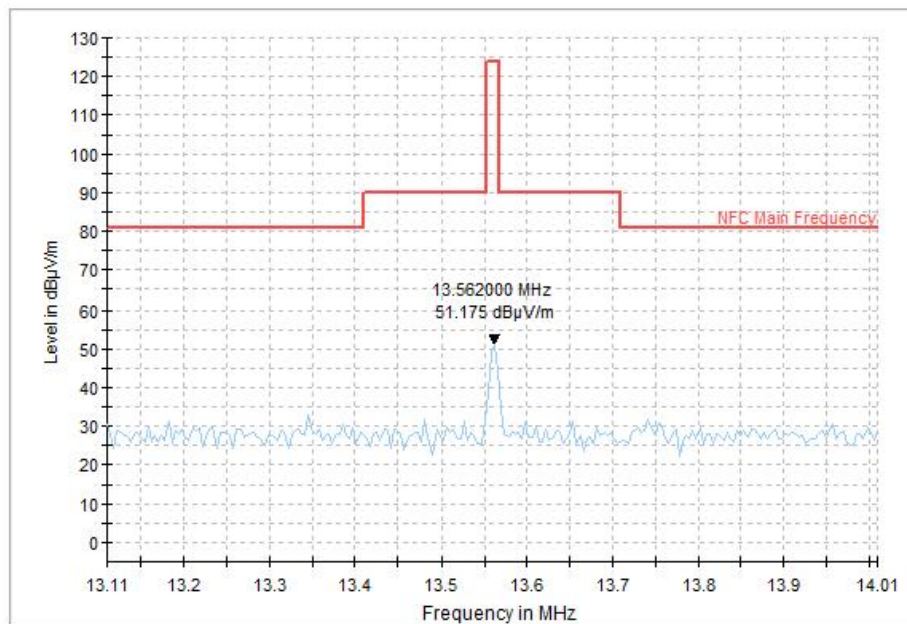

**Figure A-1 Electric Field Strength**

## A.2. Electric Field Radiated Emissions (<30MHz)

### A.2.1. Reference

See CFR 47 § 15.209

See CFR 47 § 15.225(d)

### A.2.2. Measurement Methods

The transmitter carrier output levels (E-Field) from the EUT are measured in a semi-anechoic chamber. The EUT is placed on a non-conductive stand of 80cm high, and at a measurement distance of 3m from the receiving antenna. The center of the receiving loop antenna is 1.0 meter above the ground. The E-field is measured with a shielded loop antenna connected to a measurement receiver. Detected E-field was maximized by rotating the EUT through 360° and adjusting the receiving antenna polarizations. The maximization processes were repeated with the EUT positioned respectively in its three orthogonal axes. The measurements were performed with the peak detector and if required, the quasi-peak detector.

The measurement bandwidth is:

Frequency of Emission (MHz)	RBW/VBW
0.009-0.15	100/300 Hz
0.15-30	10/30 kHz

The E-field measured at 3m is calculated as:

$$\text{E-field (dB}\mu\text{V/m)} = \text{Rx (dB}\mu\text{V)} + \text{Cable Loss (dB)} + \text{AF@3m (dB/m)}$$

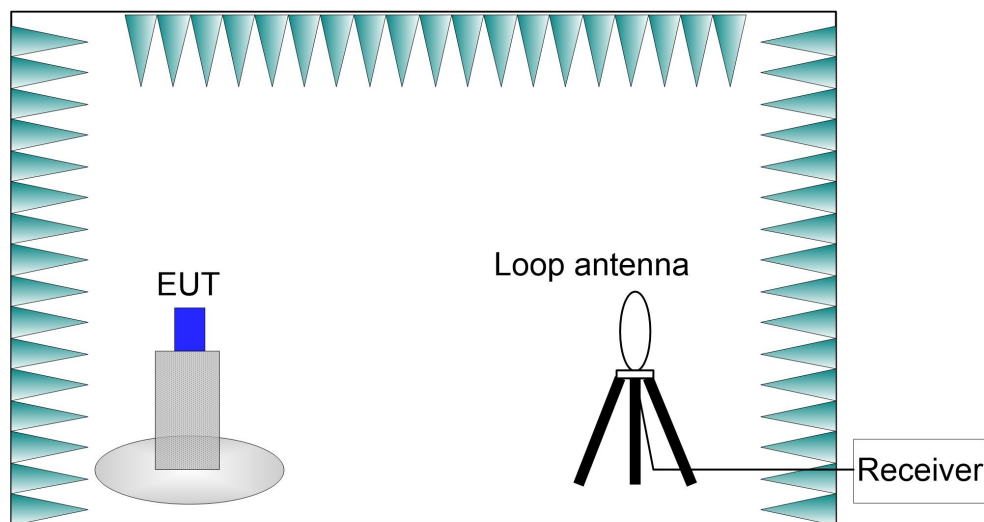

### A.2.3. EUT Operating Mode and Test Conditions

The measurement of EUT is carried out under the transmit state of NFC (See 3.5).

The EUT is powered by a travel adapter.

During the measurements, the ambient temperature of the electromagnetic anechoic chamber is in the range of 15 ~ 25°C.

**A.2.4. Limits**

Frequency Range (MHz)	E-field Strength Limit @ 30m (μV/m)	E-field Strength Limit @ 3m (dBμV/m)
0.009-0.490	2400/F(kHz)	129-94
0.490-1.705	24000/F(kHz)	74-63
1.705-30	30	70

Note: Where the limits have been defined at one distance, and a signal level measured at another, the limits have been extrapolated using the following formula:

$$\text{Extrapolation (dB)} = 40 * \log_{10}(\text{Measurement Distance} / \text{Specification Distance})$$

**A.2.5. Measurement Results**

Measurement results of normal conditions see Figure A-2 for different set-ups of EUT. The result displayed take into account applicable antenna factors and cable losses.

**Conclusions: PASS.**

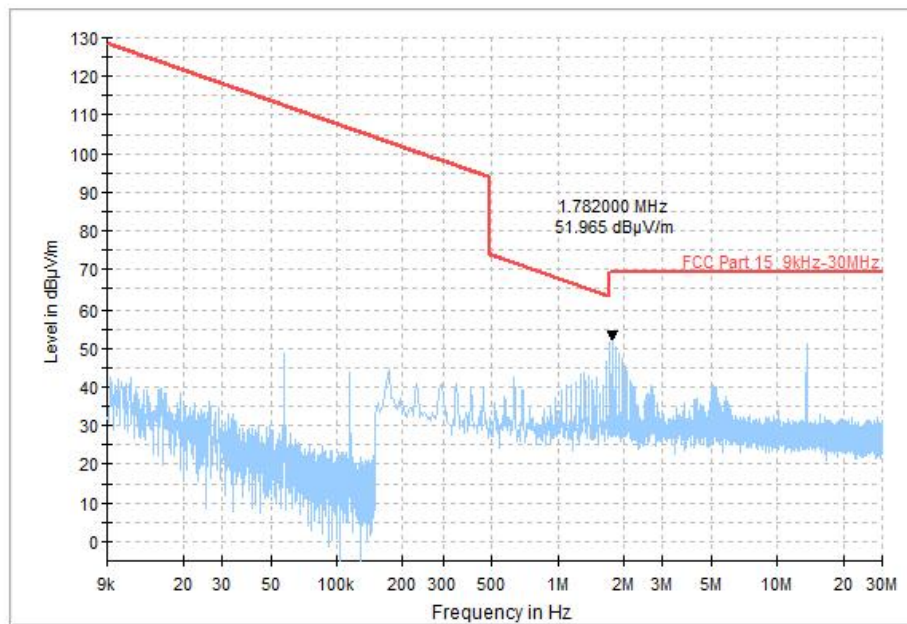

**Figure A-2 Transmit State (9kHz-30MHz)**



### A.3. Electric Field Radiated Emissions ( $\geq 30\text{MHz}$ )

#### A.3.1. Reference

See CFR 47 § 15.209

See CFR 47 § 15.225(d)

#### A.3.2. Measurement Methods

The electric field radiated emissions from the EUT are measured in a semi-anechoic chamber. The EUT is placed on a non-conductive stand of 80cm high, and at a measurement distance of 3m from the receiving antenna. The receiving antennas connected to a measurement receiver comply with the standard requirements. In order to search for maximum field strength emitted from the EUT, the receiving antenna can be moved between the height of 1.0 m to 4.0 m. Detected E-field was maximized at each frequency by rotating the EUT through 360° and adjusting the receiving antenna positions for both vertical and horizontal antenna polarizations. The maximization processes were repeated with the EUT positioned respectively in its three orthogonal axes. The measurements were performed with the peak detector and if required, the quasi-peak detector.

The measurement bandwidth is:

Frequency of Emission (MHz)	RBW/VBW
30-1000	120kHz

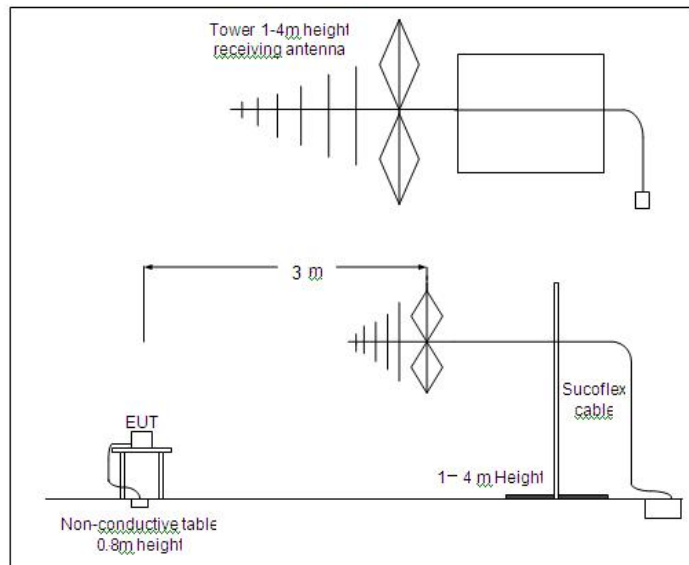

#### A.3.3. EUT Operating Mode and Test Conditions

The measurement of EUT is carried out under the transmit state of NFC (See 3.5).

EUT had been connected to a travel adapter.

During the measurements, the ambient temperature of the electromagnetic anechoic chamber is in the range of 15 ~ 25°C.

**A.3.4. Limits**

Frequency Range (MHz)	E-field Strength Limit @ 3m ( $\mu\text{V/m}$ )	E-field Strength Limit @ 3m ( $\text{dB}\mu\text{V/m}$ )	E-field Strength Limit @ 10m ( $\text{dB}\mu\text{V/m}$ )
30-88	100	40	30
88-216	150	43.5	33.5
216-960	200	46	36
960-1000	500	54	44

**A.3.5. Measurement Results**

Measurement results of normal conditions see Figure A-3 for different set-ups of EUT. The result displayed take into account applicable antenna factors and cable losses.

**Conclusions: PASS.**

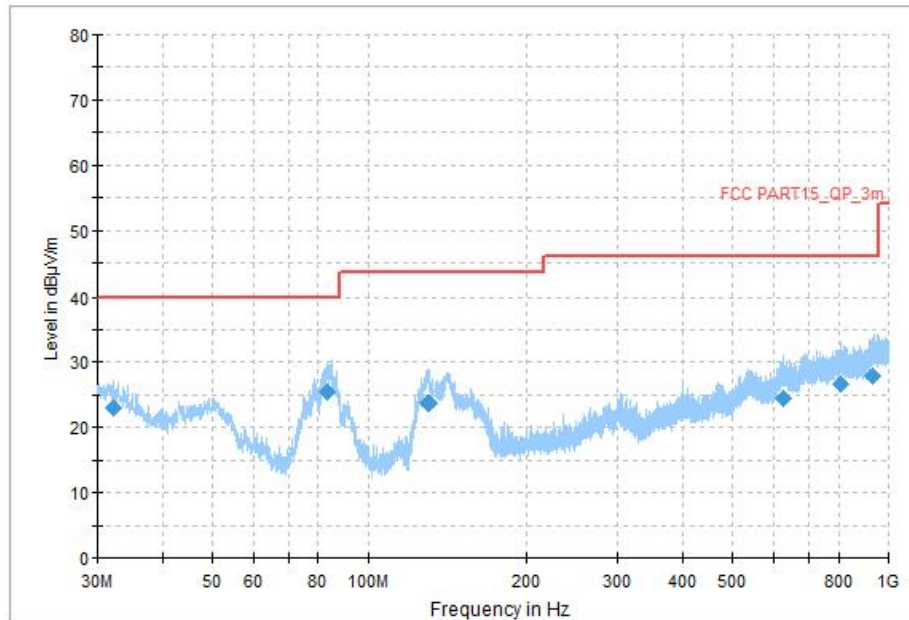

**Figure A-3 Transmit State (30MHz-1GHz)**

## A.4. Frequency Tolerance

### A.4.1. Reference

See CFR 47 § 15.225(e)

### A.4.2. Measurement Methods

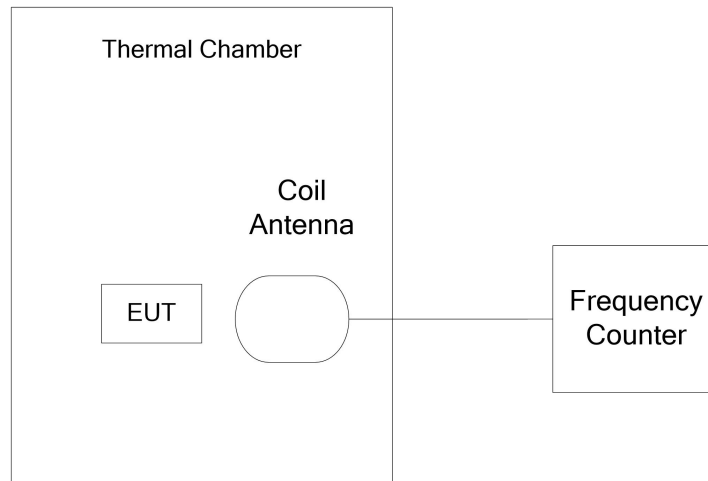

The transmitter output signal was picked up by coil antenna connected to the frequency counter. The center frequency was measured with 30Hz RBW and 1kHz span. During the test, the EUT was placed in a thermal chamber until thermal balance and lasting appropriate time.

### A.4.3. EUT Operating Mode and Test Conditions

The measurement of EUT is carried out under the transmit state of without modulation (See 3.5). EUT had been not connected to a travel adapter.  
Operation Temperature: T min, T nom, and T max with V nom.  
Operation Voltage: V min and V max with T nom.

### A.4.4. Test Layouts

See A.4.2.

### A.4.5. Limits

The frequency tolerance of the carrier signal shall be maintained within +/- 0.01% of the operating frequency.

### A.4.6. Measurement Results

Measurement results see Table A-1 for different test conditions.

**Conclusions: PASS.**

**Table A-1: Frequency Stability VS Temperature and Voltage**

Temperature	Voltage	Frequency Error (MHz)			
		Startup	2 Min Later	5 Min Later	10 Min Later
T min	V nom	13.559959	13.559960	13.559960	13.559961
T max	V nom	13.559958	13.559958	13.559959	13.559959
T nom	V nom	13.559960	13.559960	13.559961	13.559960
T nom	V min	13.559960	13.559962	13.559960	13.559960
T nom	V max	13.559959	13.559957	13.559958	13.559957

Temperature	Voltage	Frequency Error (%)			
		Startup	2 Min Later	5 Min Later	10 Min Later
T min	V nom	0.00	0.00	0.00	0.00
T max	V nom	0.00	0.00	0.00	0.00
T nom	V nom	0.00	0.00	0.00	0.00
T nom	V min	0.00	0.00	0.00	0.00
T nom	V max	0.00	0.00	0.00	0.00

Note: T min= -20°C, T max= 50°C, T nom ≈20°C, V min=3.29V, V max=4.45V, V nom=3.87V

## A.5. 20dB Bandwidth

### A.5.1. Reference

See CFR 47 § 15.215(c)

### A.5.2. Measurement Methods

The transmitter output signal was picked up by coil antenna to the spectrum analyzer.

The transmitter output signal was picked up by coil antenna connected to the spectrum analyzer.

The bandwidth of the center frequency was measured with 100Hz RBW, 300Hz VBW and 10kHz span.

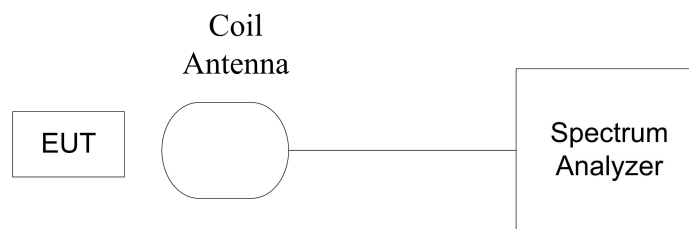

### A.5.3. EUT Operating Mode and Test Conditions

The measurement of EUT is carried out under the transmit state of NFC and without modulation (See 3.5).

EUT had been not connected to a travel adapter.

During the measurements, the ambient temperature is in the range of 15 ~ 25°C.

### A.5.4. Test Layouts

See A.5.2.

### A.5.5. Limits

The 20dB bandwidth shall be less than 80% of the permitted frequency band. For 13.56 MHz NFC, the permitted frequency band is 14 kHz, so the limit is 11.2 kHz.

### A.5.6. Measurement Results

Measurement results see Figure A-4.

**Conclusions: PASS.**

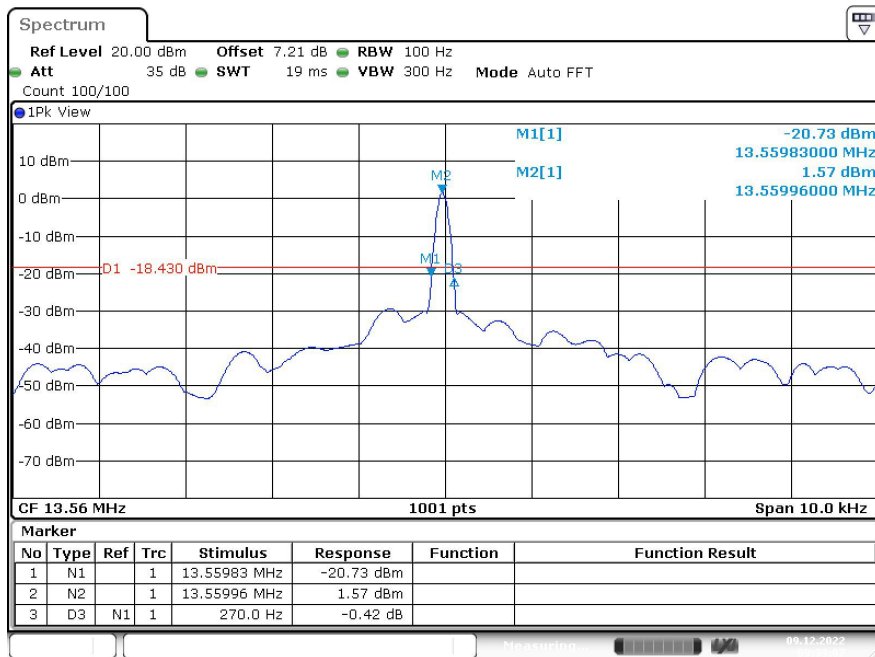

Figure A-4 20dB Bandwidth

## A.6. Conducted emission

### A.6.1. Reference

See CFR 47 § 15.207

### A.6.2. Measurement Methods

The conducted emissions from the AC port of the EUT are measured in a shielding room. The EUT is connected to a Line Impedance Stabilization Network (LISN). An overview sweep with peak detection was performed. The measurements were performed with a quasi-peak detector and if required, an average detector.

The conducted emission measurements were made with the following detector of the test receiver: Quasi-Peak / Average Detector.

The measurement bandwidth is:

Frequency of Emission (MHz)	RBW/VBW
0.15-30	9kHz

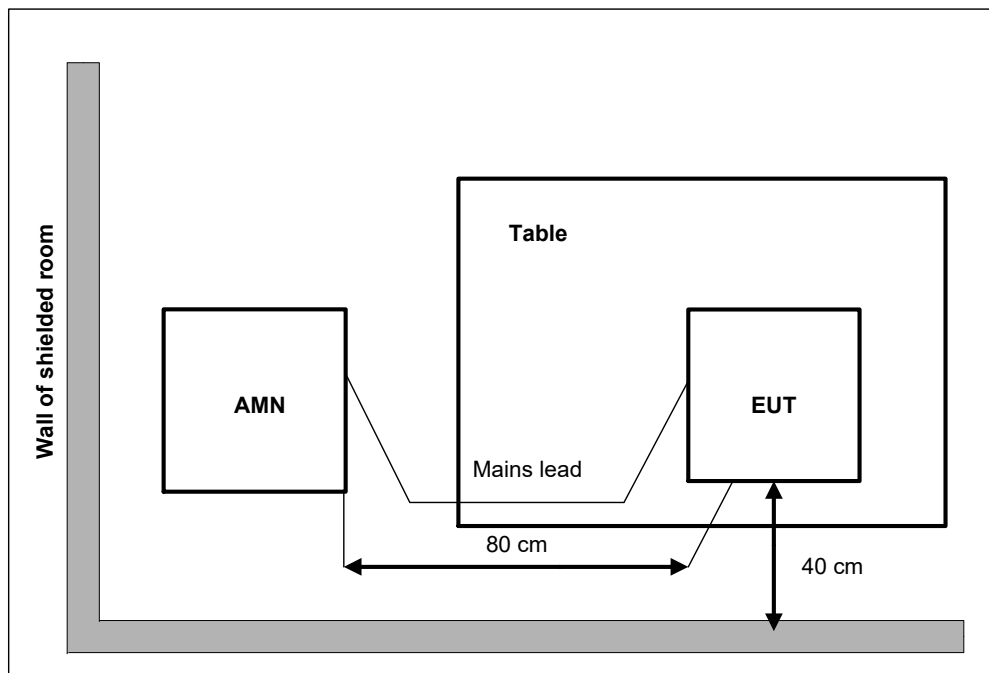

### A.6.3. EUT Operating Mode and Test Conditions

The measurement of EUT is carried out under the transmit state of NFC (See 3.5).

The EUT is powered by a travel adapter.

During the measurements, the ambient temperature is in the range of 15 ~ 25°C.

**A.6.4. Limits**

Frequency range(MHz)	Quasi-peak Limit (dB $\mu$ V)	Average Limit (dB $\mu$ V)
0.15 to 0.5	66 to 56	56 to 46
0.5 to 5	56	46
5 to 30	60	50

**A.6.5. Measurement Results**

Measurement results see Figure A-5 and Figure A-6.

**Conclusions: PASS.**

Note: The measurement result at 13.56MHz is the fundamental emission of NFC signal.



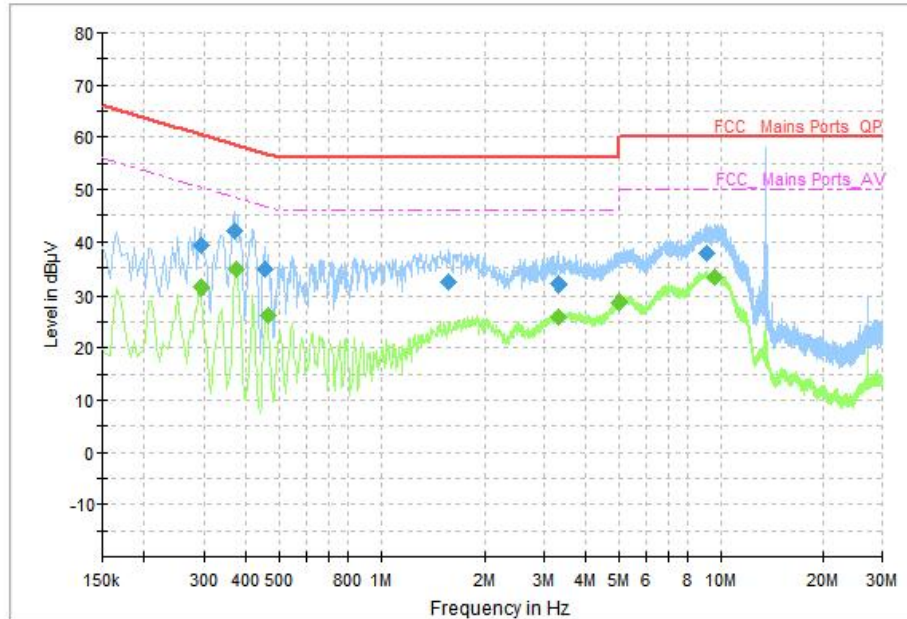

Figure A-5 Conducted Emission (Traffic)

**Measurement Results: Quasi Peak**

Frequency (MHz)	QuasiPeak (dBµV)	Limit (dBµV)	Margin (dB)	Line	Filter	Corr. (dB)
0.294000	39.22	60.41	21.19	N	ON	10
0.370000	41.97	58.50	16.53	N	ON	10
0.454000	34.86	56.80	21.94	N	ON	10
1.566000	32.40	56.00	23.60	N	ON	10
3.322000	32.05	56.00	23.95	N	ON	10
9.094000	37.75	60.00	22.25	L1	ON	10

**Measurement Results: Average**

Frequency (MHz)	Average (dBµV)	Limit (dBµV)	Margin (dB)	Line	Filter	Corr. (dB)
0.294000	31.28	50.41	19.13	N	ON	10
0.374000	34.59	48.41	13.83	N	ON	10
0.462000	26.10	46.66	20.56	N	ON	10
3.322000	25.99	46.00	20.01	N	ON	10
4.990000	28.55	46.00	17.45	L1	ON	10
9.622000	33.28	50.00	16.72	N	ON	10

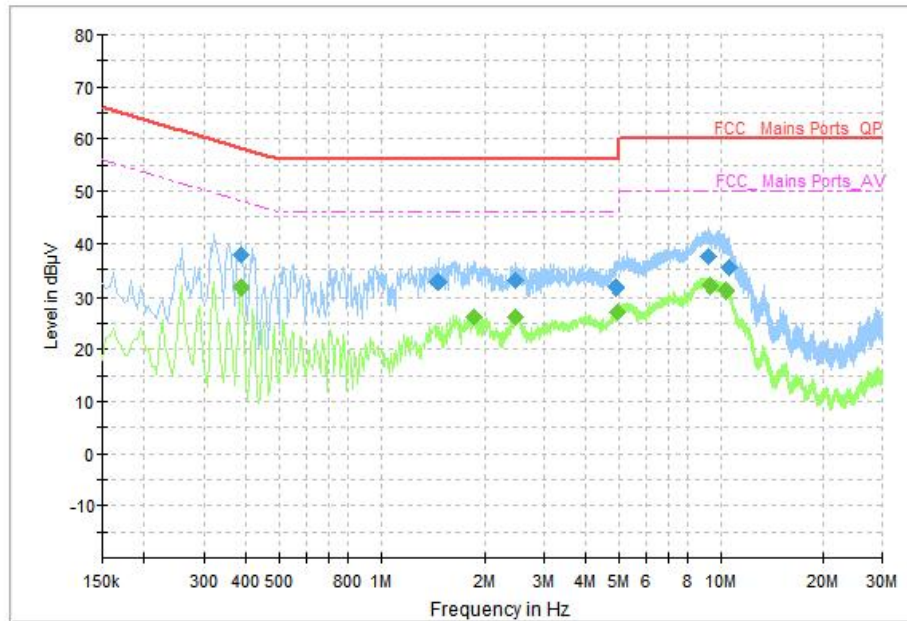

Figure A-6 Conducted Emission (Idle)

Measurement Results: Quasi Peak

Frequency (MHz)	QuasiPeak (dBµV)	Limit (dBµV)	Margin (dB)	Line	Filter	Corr. (dB)
0.386000	37.73	58.15	20.42	N	ON	10
1.466000	32.57	56.00	23.43	N	ON	10
2.470000	32.95	56.00	23.05	L1	ON	10
4.878000	31.80	56.00	24.20	L1	ON	10
9.230000	37.59	60.00	22.41	N	ON	10
10.554000	35.50	60.00	24.50	N	ON	10

Measurement Results: Average

Frequency (MHz)	Average (dBµV)	Limit (dBµV)	Margin (dB)	Line	Filter	Corr. (dB)
0.386000	31.55	48.15	16.60	N	ON	10
1.854000	26.11	46.00	19.89	N	ON	10
2.462000	26.11	46.00	19.89	L1	ON	10
4.930000	27.22	46.00	18.78	L1	ON	10
9.326000	31.93	50.00	18.07	L1	ON	10
10.402000	30.94	50.00	19.06	N	ON	10

\*\*\*END OF REPORT\*\*\*