

FCC Measurement/Technical Report on

6.5inchCluster

Connected Instrumentation Cluster for Motorcycle

(in Bluetooth[®] Headset mode)

FCC ID: 2AUXS-6P5CLUSTER
IC: 25847-6P5CLUSTER

Test Report Reference: MDE_BOSCH_2004_FCC_03

Test Laboratory:

7layers GmbH
Borsigstrasse 11
40880 Ratingen
Germany



Deutsche
Akkreditierungsstelle
D-PL-12140-01-01
D-PL-12140-01-02
D-PL-12140-01-03

Note:

The following test results relate only to the devices specified in this document. This report shall not be reproduced in parts without the written approval of the test laboratory.

7layers GmbH

Borsigstraße 11
40880 Ratingen, Germany
T +49 (0) 2102 749 0
F +49 (0) 2102 749 350

Geschäftsführer/

Managing Directors:

Frank Spiller
Bernhard Retka
Alexandre Norré-Oudard

Registergericht/registered:

Düsseldorf HRB 75554
USt-Id.-Nr./VAT-No. DE203159652
Steuer-Nr./TAX-No. 147/5869/0385

*a Bureau Veritas
Group Company*

www.7layers.com

Table of Contents

1	Applied Standards and Test Summary	3
1.1	Applied Standards	3
1.2	FCC-IC Correlation Table	4
1.3	Measurement Summary	5
2	Revision History / Signatures	9
3	Administrative Data	10
3.1	Testing Laboratory	10
3.2	Project Data	10
3.3	Applicant Data	10
3.4	Manufacturer Data	11
4	Test object Data	12
4.1	General EUT Description	12
4.2	EUT Main components	13
4.3	Ancillary Equipment	13
4.4	Auxiliary Equipment	14
4.5	EUT Setups	14
4.6	Operating Modes / Test Channels	15
4.7	Product labelling	17
5	Test Results	18
5.1	Occupied Bandwidth (20 dB)	18
5.2	Occupied Bandwidth (99%)	25
5.3	Peak Power Output	28
5.4	Spurious RF Conducted Emissions	35
5.5	Transmitter Spurious Radiated Emissions	42
5.6	Band Edge Compliance Conducted	51
5.7	Band Edge Compliance Radiated	60
5.8	Channel Separation	66
5.9	Dwell Time	68
5.10	Number of Hopping Frequencies	71
6	Test Equipment	74
7	Antenna Factors, Cable Loss and Sample Calculations	77
7.1	LISN R&S ESH3-Z5 (150 kHz – 30 MHz)	77
7.2	Antenna R&S HFH2-Z2 (9 kHz – 30 MHz)	78
7.3	Antenna R&S HL562 (30 MHz – 1 GHz)	79
7.4	Antenna R&S HF907 (1 GHz – 18 GHz)	80
7.5	Antenna EMCO 3160-09 (18 GHz – 26.5 GHz)	81
7.6	Antenna EMCO 3160-10 (26.5 GHz – 40 GHz)	82
8	Measurement Uncertainties	83
9	Photo Report	84

1 APPLIED STANDARDS AND TEST SUMMARY

1.1 APPLIED STANDARDS

Type of Authorization

Certification for an Intentional Radiator.

Applicable FCC Rules

Prepared in accordance with the requirements of FCC Rules and Regulations as listed in 47 CFR Ch.1 Parts 2 and 15 (10-1-19 Edition). The following subparts are applicable to the results in this test report.

Part 2, Subpart J - Equipment Authorization Procedures, Certification

Part 15, Subpart C – Intentional Radiators

§ 15.201 Equipment authorization requirement

§ 15.209 Radiated emission limits; general requirements

§ 15.247 Operation within the bands 902-928 MHz, 2400-2483.5 MHz

Note 1:

The tests were selected and performed with reference to the FCC Public Notice "Guidance for Compliance Measurements on Digital Transmission System, Frequency Hopping Spread Spectrum System, and Hybrid System Devices Operating under Section 15.247 of the FCC Rules, 558074 D01 15.247 Meas Guidance v05r02, 2019-04-02". ANSI C63.10–2013 is applied.

Note 2:

§ 15.207 Conducted limits are not applicable:

The device is not designed to be connected to the public utility (AC) power line.

1.2 FCC-IC CORRELATION TABLE

Correlation of measurement requirements for FHSS (e.g. Bluetooth®) equipment from FCC and IC

FHSS equipment

Measurement	FCC reference	IC reference
Conducted emissions on AC Mains	§ 15.207	RSS-Gen Issue 5: 8.8
Occupied bandwidth	§ 15.247 (a) (1)	RSS-247 Issue 2: 5.1 (b)
Peak conducted output power	§ 15.247 (b) (1), (4)	RSS-247 Issue 2: 5.4 (b)
Transmitter spurious RF conducted emissions	§ 15.247 (d)	RSS-Gen Issue 5: 6.13/8.9/8.10; RSS-247 Issue 2: 5.5
Transmitter spurious radiated emissions	§ 15.247 (d); § 15.209 (a)	RSS-Gen Issue 5: 6.13 / 8.9/8.10; RSS-247 Issue 2: 5.5
Band edge compliance	§ 15.247 (d)	RSS-247 Issue 2: 5.5
Dwell time	§ 15.247 (a) (1) (iii)	RSS-247 Issue 2: 5.1 (d)
Channel separation	§ 15.247 (a) (1)	RSS-247 Issue 2: 5.1 (b)
No. of hopping frequencies	§ 15.247 (a) (1) (iii)	RSS-247 Issue 2: 5.1 (d)
Hybrid systems (only)	§ 15.247 (f); § 15.247 (e)	RSS-247 Issue 2: 5.3
Antenna requirement	§ 15.203 / 15.204	RSS-Gen Issue 5: 8.3
Receiver spurious emissions	–	-

1.3 MEASUREMENT SUMMARY

47 CFR CHAPTER I FCC PART 15 § 15.247 (a) (1)
Subpart C §15.247

Occupied Bandwidth (20 dB)

The measurement was performed according to ANSI C63.10

OP-Mode Radio Technology, Operating Frequency	Setup	Date	Final Result	
			FCC	IC
Bluetooth BDR, high	S01_ab01_ BT_Headset	2020-08-12	Passed	Passed
Bluetooth BDR, low	S01_ab01_ BT_Headset	2020-08-12	Passed	Passed
Bluetooth BDR, mid	S01_ab01_ BT_Headset	2020-08-12	Passed	Passed
Bluetooth EDR 2, high	S01_ab01_ BT_Headset	2020-08-12	Passed	Passed
Bluetooth EDR 2, low	S01_ab01_ BT_Headset	2020-08-12	Passed	Passed
Bluetooth EDR 2, mid	S01_ab01_ BT_Headset	2020-08-12	Passed	Passed
Bluetooth EDR 3, high	S01_ab01_ BT_Headset	2020-08-12	Passed	Passed
Bluetooth EDR 3, low	S01_ab01_ BT_Headset	2020-08-12	Passed	Passed
Bluetooth EDR 3, mid	S01_ab01_ BT_Headset	2020-08-12	Passed	Passed

47 CFR CHAPTER I FCC PART 15 IC RSS-Gen & IC TRC-43; Ch. 6.7 & Ch. 8
Subpart C §15.247

Occupied Bandwidth (99%)

The measurement was performed according to ANSI C63.10

OP-Mode Radio Technology, Operating Frequency	Setup	Date	Final Result	
			FCC	IC
Bluetooth BDR, high	S01_ab01_ BT_Headset	2020-08-12	N/A	Performed
Bluetooth BDR, low	S01_ab01_ BT_Headset	2020-08-12	N/A	Performed
Bluetooth BDR, mid	S01_ab01_ BT_Headset	2020-08-12	N/A	Performed
Bluetooth EDR 2, high	S01_ab01_ BT_Headset	2020-08-12	N/A	Performed
Bluetooth EDR 2, low	S01_ab01_ BT_Headset	2020-08-12	N/A	Performed
Bluetooth EDR 2, mid	S01_ab01_ BT_Headset	2020-08-12	N/A	Performed
Bluetooth EDR 3, high	S01_ab01_ BT_Headset	2020-08-12	N/A	Performed
Bluetooth EDR 3, low	S01_ab01_ BT_Headset	2020-08-12	N/A	Performed
Bluetooth EDR 3, mid	S01_ab01_ BT_Headset	2020-08-12	N/A	Performed

47 CFR CHAPTER I FCC PART 15
Subpart C §15.247

§ 15.247 (b) (1) (2)

Peak Power Output

The measurement was performed according to ANSI C63.10

Final Result

OP-Mode	Setup	Date	FCC	IC
Radio Technology, Operating Frequency, Measurement method				
Bluetooth BDR, high, conducted	S01_ab01_ BT_Headset	2020-08-12	Passed	Passed
Bluetooth BDR, low, conducted	S01_ab01_ BT_Headset	2020-08-12	Passed	Passed
Bluetooth BDR, mid, conducted	S01_ab01_ BT_Headset	2020-08-12	Passed	Passed
Bluetooth EDR 2, high, conducted	S01_ab01_ BT_Headset	2020-08-12	Passed	Passed
Bluetooth EDR 2, low, conducted	S01_ab01_ BT_Headset	2020-08-12	Passed	Passed
Bluetooth EDR 2, mid, conducted	S01_ab01_ BT_Headset	2020-08-12	Passed	Passed
Bluetooth EDR 3, high, conducted	S01_ab01_ BT_Headset	2020-08-12	Passed	Passed
Bluetooth EDR 3, low, conducted	S01_ab01_ BT_Headset	2020-08-12	Passed	Passed
Bluetooth EDR 3, mid, conducted	S01_ab01_ BT_Headset	2020-08-12	Passed	Passed

47 CFR CHAPTER I FCC PART 15
Subpart C §15.247

§ 15.247 (d)

Spurious RF Conducted Emissions

The measurement was performed according to ANSI C63.10

Final Result

OP-Mode	Setup	Date	FCC	IC
Radio Technology, Operating Frequency				
Bluetooth BDR, high	S01_ab01_ BT_Headset	2020-08-12	Passed	Passed
Bluetooth BDR, low	S01_ab01_ BT_Headset	2020-08-12	Passed	Passed
Bluetooth BDR, mid	S01_ab01_ BT_Headset	2020-08-12	Passed	Passed
Bluetooth EDR 2, high	S01_ab01_ BT_Headset	2020-08-12	Passed	Passed
Bluetooth EDR 2, low	S01_ab01_ BT_Headset	2020-08-12	Passed	Passed
Bluetooth EDR 2, mid	S01_ab01_ BT_Headset	2020-08-12	Passed	Passed
Bluetooth EDR 3, high	S01_ab01_ BT_Headset	2020-08-12	Passed	Passed
Bluetooth EDR 3, low	S01_ab01_ BT_Headset	2020-08-12	Passed	Passed
Bluetooth EDR 3, mid	S01_ab01_ BT_Headset	2020-08-12	Passed	Passed

**47 CFR CHAPTER I FCC PART 15
Subpart C §15.247**

§ 15.247 (d)

Transmitter Spurious Radiated Emissions

The measurement was performed according to ANSI C63.10

Final Result

OP-Mode Radio Technology, Operating Frequency, Measurement range	Setup	Date	FCC	IC
Bluetooth BDR, high, 1 GHz - 26 GHz	S01_aa01_ BT_Headset	2020-08-14	Passed	Passed
Bluetooth BDR, high, 30 MHz - 1 GHz	S01_aa01_ BT_Headset	2020-08-02	Passed	Passed
Bluetooth BDR, low, 1 GHz - 26 GHz	S01_aa01_ BT_Headset	2020-08-14	Passed	Passed
Bluetooth BDR, low, 30 MHz - 1 GHz	S01_aa01_ BT_Headset	2020-08-02	Passed	Passed
Bluetooth BDR, mid, 1 GHz - 26 GHz	S01_aa01_ BT_Headset	2020-08-14	Passed	Passed
Bluetooth BDR, mid, 30 MHz - 1 GHz	S01_aa01_ BT_Headset	2020-08-02	Passed	Passed
Bluetooth BDR, mid, 9 kHz - 30 MHz	S01_aa01_ BT_Headset	2020-08-02	Passed	Passed
Bluetooth EDR 2, high, 1 GHz - 26 GHz Remark: 1-8 GHz	S01_aa01_ BT_Headset	2020-08-14	Passed	Passed
Bluetooth EDR 2, low, 1 GHz - 26 GHz Remark: 1-8 GHz	S01_aa01_ BT_Headset	2020-08-15	Passed	Passed
Bluetooth EDR 2, mid, 1 GHz - 26 GHz Remark: 1-8 GHz	S01_aa01_ BT_Headset	2020-08-15	Passed	Passed
Bluetooth EDR 3, high, 1 GHz - 26 GHz Remark: 1-8 GHz	S01_aa01_ BT_Headset	2020-08-16	Passed	Passed

**47 CFR CHAPTER I FCC PART 15
Subpart C §15.247**

§ 15.247 (d)

Band Edge Compliance Conducted

The measurement was performed according to ANSI C63.10

Final Result

OP-Mode Radio Technology, Operating Frequency, Band Edge	Setup	Date	FCC	IC
Bluetooth BDR, high, high	S01_ab01_ BT_Headset	2020-08-12	Passed	Passed
Bluetooth BDR, hopping, high	S01_ab01_ BT_Headset	2020-08-12	Passed	Passed
Bluetooth BDR, hopping, low	S01_ab01_ BT_Headset	2020-08-12	Passed	Passed
Bluetooth BDR, low, low	S01_ab01_ BT_Headset	2020-08-12	Passed	Passed
Bluetooth EDR 2, high, high	S01_ab01_ BT_Headset	2020-08-12	Passed	Passed
Bluetooth EDR 2, hopping, high	S01_ab01_ BT_Headset	2020-08-12	Passed	Passed
Bluetooth EDR 2, hopping, low	S01_ab01_ BT_Headset	2020-08-12	Passed	Passed
Bluetooth EDR 2, low, low	S01_ab01_ BT_Headset	2020-08-12	Passed	Passed
Bluetooth EDR 3, high, high	S01_ab01_ BT_Headset	2020-08-12	Passed	Passed
Bluetooth EDR 3, hopping, high	S01_ab01_ BT_Headset	2020-08-12	Passed	Passed

47 CFR CHAPTER I FCC PART 15 § 15.247 (d)
Subpart C §15.247

Band Edge Compliance Conducted
The measurement was performed according to ANSI C63.10

			Final Result	
OP-Mode	Setup	Date	FCC	IC
Radio Technology, Operating Frequency, Band Edge				
Bluetooth EDR 3, hopping, low	S01_ab01_ BT_Headset	2020-08-12	Passed	Passed
Bluetooth EDR 3, low, low	S01_ab01_ BT_Headset	2020-08-12	Passed	Passed

47 CFR CHAPTER I FCC PART 15 § 15.247 (d)
Subpart C §15.247

Band Edge Compliance Radiated
The measurement was performed according to ANSI C63.10

			Final Result	
OP-Mode	Setup	Date	FCC	IC
Radio Technology, Operating Frequency, Band Edge				
Bluetooth BDR, high, high	S01_aa01_ BT_Headset	2020-08-15	Passed	Passed
Bluetooth EDR 2, high, high	S01_aa01_ BT_Headset	2020-08-15	Passed	Passed
Bluetooth EDR 3, high, high	S01_aa01_ BT_Headset	2020-08-16	Passed	Passed

47 CFR CHAPTER I FCC PART 15 § 15.247 (a) (1)
Subpart C §15.247

Channel Separation
The measurement was performed according to ANSI C63.10

			Final Result	
OP-Mode	Setup	Date	FCC	IC
Radio Technology				
Bluetooth BDR	S01_ab01_ BT_Headset	2020-08-12	Passed	Passed

47 CFR CHAPTER I FCC PART 15 § 15.247 (a) (1) (i) (ii) (iii)
Subpart C §15.247

Dwell Time
The measurement was performed according to ANSI C63.10

			Final Result	
OP-Mode	Setup	Date	FCC	IC
Radio Technology				
Bluetooth BDR	S01_ab01_ BT_Headset	2020-08-12	Passed	Passed

47 CFR CHAPTER I FCC PART 15 § 15.247 (a) (1) (i) (ii) (iii)
Subpart C §15.247

Number of Hopping Frequencies
The measurement was performed according to ANSI C63.10

			Final Result	
OP-Mode	Setup	Date	FCC	IC
Radio Technology				
Bluetooth BDR	S01_ab01_ BT_Headset	2020-08-12	Passed	Passed

2 REVISION HISTORY / SIGNATURES

Report version control			
Version	Release date	Change Description	Version validity
initial	2020-09-21	--	valid
--	--	--	--

COMMENT: -

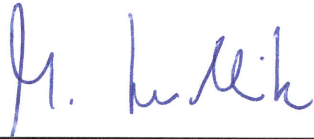

(responsible for accreditation scope)
Marco Kullik



(responsible for testing and report)
Wolfgang Richter



7 layers GmbH, Borsigstr. 11
40880 Ratingen, Germany
Phone +49 (0)2102 749 0

3 ADMINISTRATIVE DATA

3.1 TESTING LABORATORY

Company Name: 7layers GmbH
Address: Borsigstr. 11
40880 Ratingen
Germany

The test facility is accredited by the following accreditation organisation:

Laboratory accreditation no: DAKKS D-PL-12140-01-01 | -02 | -03
FCC Designation Number: DE0015
FCC Test Firm Registration: 929146
ISED CAB Identifier DE0007; ISED#: 3699A

Responsible for accreditation scope: Marco Kullik

Report Template Version: 2020-06-15

3.2 PROJECT DATA

Responsible for testing and report: Wolfgang Richter
Employees who performed the tests: documented internally at 7Layers
Date of Report: 2020-09-21
Testing Period: 2020-08-02 to 2020-09-17

3.3 APPLICANT DATA

Company Name: Robert Bosch GmbH
Address: Robert-Bosch-Straße 200
31139 Hildesheim
Germany
Contact Person: Thomas Dargel

3.4 MANUFACTURER DATA

Company Name: Robert Bosch GmbH

Address: Robert-Bosch-Straße 200
31139 Hildesheim
Germany

Contact Person: Thomas Dargel

4 TEST OBJECT DATA

4.1 GENERAL EUT DESCRIPTION

Kind of Device product description	The 6.5inchCluster is a motorcycle instrumentation cluster with integrated connectivity functions. It is only intended for usage on motorcycles. It performs speedometer and odometer functions, as well as infotainment. Key features: - 6.5" high-resolution color display - Connectivity (CAN, LIN, Bluetooth, Wi-Fi) - Smartphone integration - USB for charging functions - Housing IP6K9K
Product name	Connected Instrumentation Cluster for Motorcycle
Type	6.5inchCluster
Declared EUT data by the supplier	
General product description	-
Specific product description for the EUT	UGKZ7A2001A module for Wi-Fi & BT - Smartphone, UGXZEX304A module: BT - Headset
Special software used for testing	on Intel stick "RTA Test Profile"
Tested data rates	BDR (DHx Packets): 1 Mbps EDR (2-DHx Packets): 2 Mbps EDR (3-DHx Packets): 3 Mbps
Tested Modulation Type	BDR (DHx Packets): GFSK EDR (2-DHx Packets): π/4 DQPSK EDR (3-DHx Packets): 8-DPSK
The EUT provides the following ports:	Main Connector and Connectivity Connector
Voltage Level	13.5 V
Voltage Type	DC (from motorcycle)
Integral Antenna	WLAN: SMD chip antenna, TDK, ANT162442DT-2001AM1, +2.1 dBi BT-Smartphone: SMD chip antenna, TDK, ANT162442ST-1000AM1, +1 dBi BT-Headset: SMD chip antenna, TDK, ANT162442ST-1000AM1, +3 dBi

4.2 EUT MAIN COMPONENTS

Sample Name	Sample Code	Description
EUT A	DE1050021aa01	Sample with 3 integral antennas for WLAN, BT-Smartphone and BT-Headset
Sample Parameter	Value	
Serial No.	20040003521	
HW Version	007	
SW Version	10.02	
Comment	Variant #1 (0263763)	

Sample Name	Sample Code	Description
EUT B	DE1050021ab01	Sample with 3 temporary SMA antenna connectors for WLAN, BT-Smartphone and BT-Headset
Sample Parameter	Value	
Serial No.	20030003551	
HW Version	007	
SW Version	10.02	
Comment 1	Variant #1 (0263763)	
Comment 2	integral antennas not connected	

NOTE: The short description is used to simplify the identification of the EUT in this test report.

4.3 ANCILLARY EQUIPMENT

For the purposes of this test report, ancillary equipment is defined as equipment which is used in conjunction with the EUT to provide operational and control features to the EUT. It is necessary to configure the system in a typical fashion, as a customer would normally use it. But nevertheless, Ancillary Equipment can influence the test results.

Device	Details (Manufacturer, Type Model, OUT Code)	Description
-	-	-

4.4 AUXILIARY EQUIPMENT

For the purposes of this test report, auxiliary equipment is defined as equipment which is used temporarily to enable operational and control features especially used for the tests of the EUT which is not used during normal operation or equipment that is used during the tests in combination with the EUT but is not subject of this test report. It is necessary to configure the system in a typical fashion, as a customer would normally use it. But nevertheless, Auxiliary Equipment can influence the test results.

Device	Details (Manufacturer, Type Model, HW, SW, S/N)	Description
AC Adapter RE03 /W10	Fujitsu Ltd., SED110P2-19.0, -, -, 07813018A	AC Adapter for laptop RE03 /W10
AUX 01	Robert Bosch GmbH, iKombi Control Box, -, -, -	Control box
AUX 02	PEAK Systems, PCAN-USB, -, -, IPEH-002021	CAN adapter between control box and Intel stick
AUX 03	Intel, Intel Compute Stick, -, Yocto OS, STK1AW32SC	Intel stick
AUX 04	Asian Power Devices, AC Adapter, -, -, WA-15I05R	Power supply for Intel Stick
AUX 05	Lindy, USB 2.0 Fast Ethernet Converter, -, -, 42922	USB-Ethernet adapter between Intel stick and laptop
AUX 06	PONTIS EMC PRODUCTS, foCAN_B, V4.0, -, 4921607013	Fiber Optic Converter for CAN bus
AUX 07	PONTIS EMC PRODUCTS, foCAN_B, V4.0, -, 4921607014	Fiber Optic Converter for CAN bus
Laptop RE03 /W10	Fujitsu Ltd., Lifebook E-Series E781, -, W10, DSCK013809	Lifebook E-Series E781

4.5 EUT SETUPS

This chapter describes the combination of EUTs and equipment used for testing. The rationale for selecting the EUTs, ancillary and auxiliary equipment and interconnecting cables, is to test a representative configuration meeting the requirements of the referenced standards.

Setup	Combination of EUTs	Description and Rationale
S01_ab01_ BT_Headset	EUT B, Laptop RE03 /W10, AUX 04, AUX 01, AC Adapter RE03 /W10, AUX 03, AUX 05, AUX 02,	measurement on temporary BT-Headset antenna connector
S01_aa01_ BT_Headset	EUT A, Laptop RE03 /W10, AUX 04, AUX 01, AC Adapter RE03 /W10, AUX 03, AUX 07, AUX 05, AUX 02, AUX 06,	used for radiated measurements in BT-Headset mode, EUT, AUX 01 and AUX 06 inside chamber

4.6 OPERATING MODES / TEST CHANNELS

This chapter describes the operating modes of the EUTs used for testing.

4.6.1 TEST CHANNELS

BT Test Channels:
Channel:
Frequency [MHz]

2.4 GHz ISM 2400 - 2483.5 MHz		
low	mid	high
0	39	78
2402	2441	2480

4.6.2 POWER SETTINGS

The power settings are not selectable by the operator.

4.6.3 DUTY CYCLE

Mode	T _{on}	T _{Periode}	Duty Cycle
Bluetooth	ms	ms	%
BDR, GFSK (1-DH1)	0.3941	1.2506	31.52%
BDR, GFSK (1-DH5)	2.8499	3.6869	77.30%
EDR, $\pi/4$ DQPSK (2-DH1)	0.4061	1.2500	32.49%
EDR, 8-DPSK (3-DH1)	0.4624	1.2500	36.99%

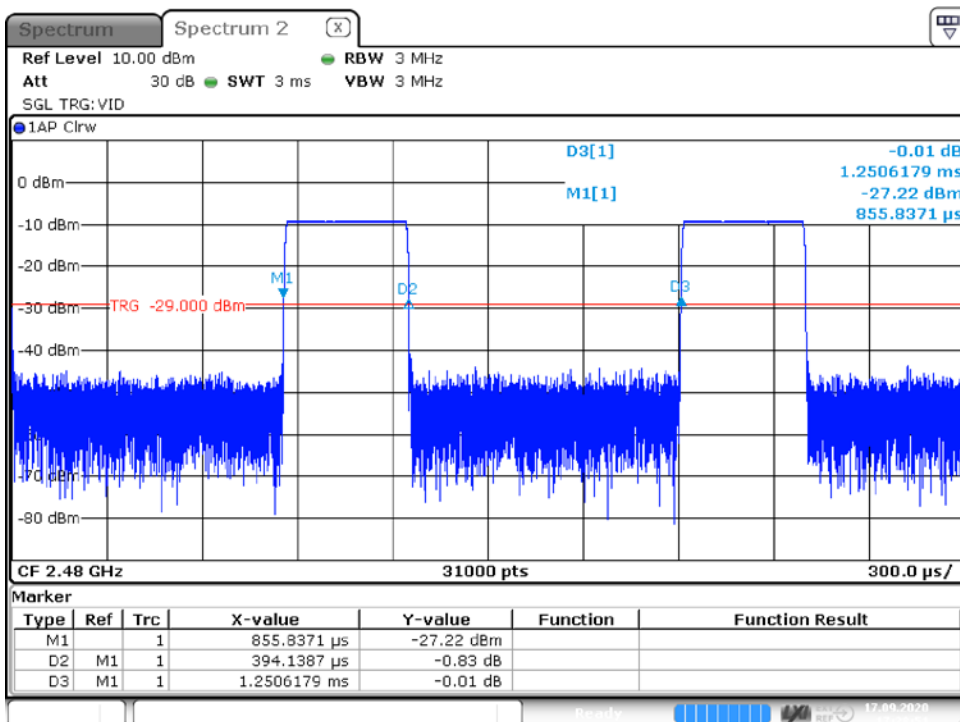

Date: 17.SEP.2020 17:28:51

(1-DH1)

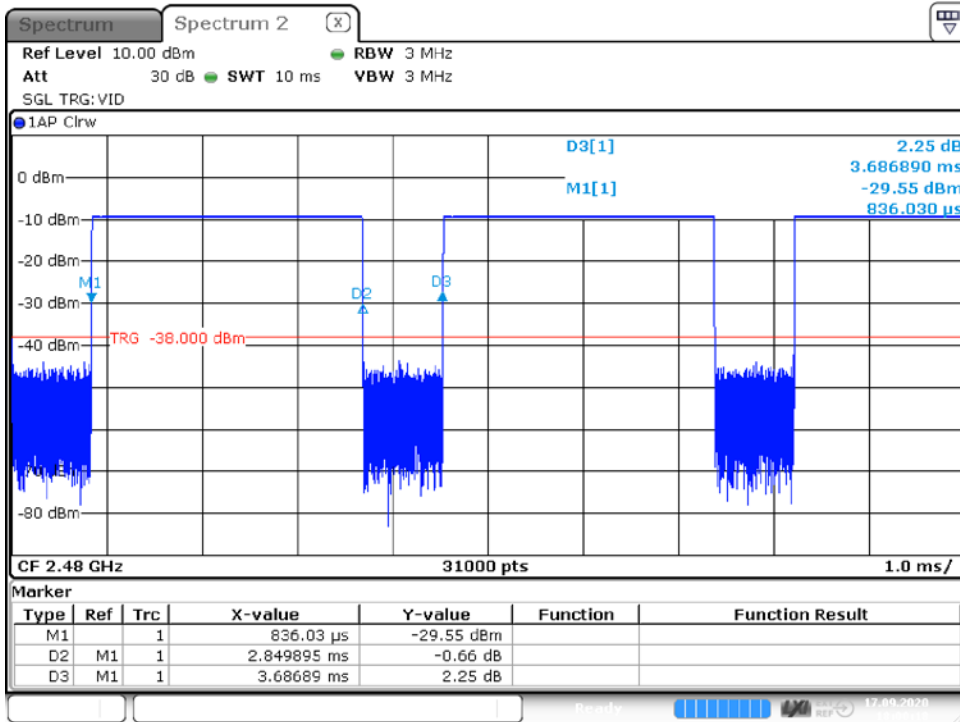

Date: 17.SEP.2020 18:00:18

(1-DH5)

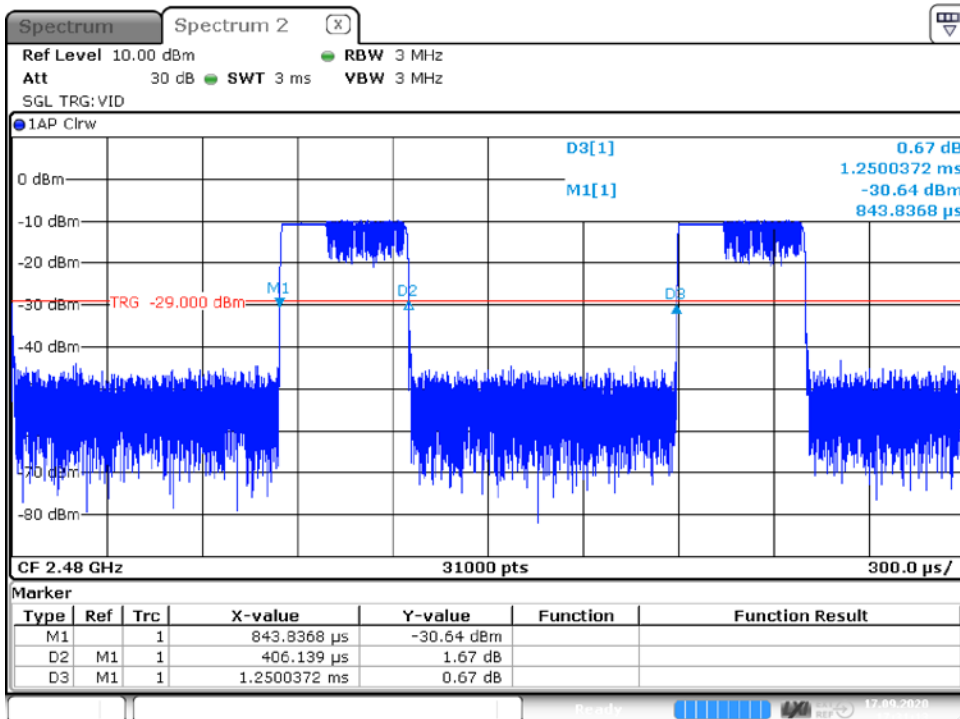

Date: 17.SEP.2020 17:31:13

(2-DH1)

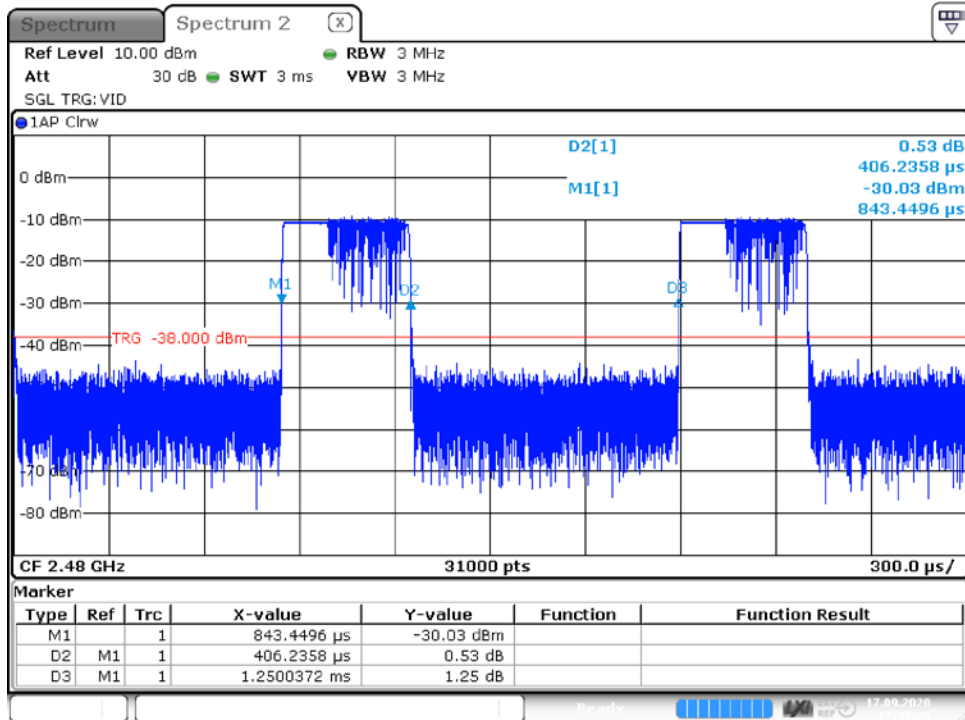

Date: 17.SEP.2020 17:33:21

(3-DH1)

4.7 PRODUCT LABELLING

4.7.1 FCC ID LABEL

Please refer to the documentation of the applicant.

4.7.2 LOCATION OF THE LABEL ON THE EUT

Please refer to the documentation of the applicant.

5 TEST RESULTS

5.1 OCCUPIED BANDWIDTH (20 DB)

Standard **FCC Part 15 Subpart C**

The test was performed according to:
ANSI C63.10

5.1.1 TEST DESCRIPTION

The Equipment Under Test (EUT) was set up to perform the occupied bandwidth measurements.

The reference level is the level of the highest amplitude signal observed from the transmitter at either the fundamental frequency or first-order modulation products in all typical modes of operation, including the unmodulated carrier, even if atypical.

The results recorded were measured with the modulation which produce the worst-case (widest) emission bandwidth.

The EUT was connected to the test system as described in the block diagram below. The complete attenuation of the measurement path is known and considered.

Analyser settings:

- Resolution Bandwidth (RBW): 1% to 5 % of the OBW
- Video Bandwidth (VBW): $\geq 3 \times$ RBW
- Span: 2 to 5 times the OBW
- Trace: Maxhold
- Sweeps: Till stable (min. 1000, max. 30000)
- Sweep Time: Auto
- Detector: Peak

The technology depending measurement parameters can be found in the measurement plot.

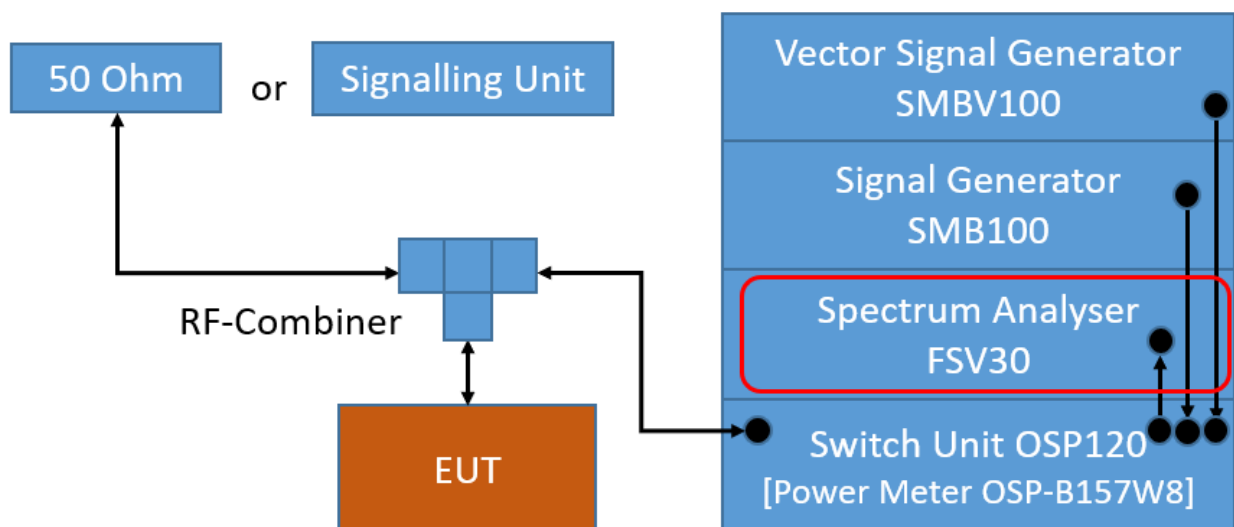

TS8997; Channel Bandwidth

5.1.2 TEST REQUIREMENTS / LIMITS

FCC Part 15, Subpart C, §15.247 (a) (2)

For the band: 902 – 928 MHz

FCC Part 15, Subpart C, §15.247 (a) (1) (i)

The maximum allowed 20 dB bandwidth of the hopping channel is 500 kHz

For the band: 5725 – 5850 MHz

FCC Part 15, Subpart C, §15.247 (a) (1) (ii)

The maximum allowed 20 dB bandwidth of the hopping channel is 1 MHz

For the frequency band 2400 – 2483.5 MHz:

FCC Part 15, Subpart C, §15.247 (a) (1) (iii)

Frequency hopping systems shall have hopping channel carrier frequencies separated by a minimum of 25 kHz or the 20 dB bandwidth of the hopping channel, whichever is greater. Alternatively, frequency hopping systems operating in the 2400–2483.5 MHz band may have hopping channel carrier frequencies that are separated by 25 kHz or two-thirds of the 20 dB bandwidth of the hopping channel, whichever is greater, provided the systems operate with an output power no greater than 125 mW. The system shall hop to channel frequencies that are selected at the system hopping rate from a pseudo randomly ordered list of hopping frequencies. Each frequency must be used equally on the average by each transmitter. The system receivers shall have input bandwidths that match the hopping channel bandwidths of their corresponding transmitters and shall shift frequencies in synchronization with the transmitted signals.

Implication by the test laboratory:

Since the Bluetooth technology defines a fixed channel separation of 1 MHz this design parameter defines the maximum allowed occupied bandwidth depending on the EUT's output power:

1. Under the provision that the system operates with an output power not greater than 125 mW (21.0 dBm):

Implicit Limit: Max. 20 dB BW = $1.0 \text{ MHz} / 2/3 = 1.5 \text{ MHz}$

2. If the system output power exceeds 125 mW (21.0 dBm):

Implicit Limit: Max. 20 dB BW = 1.0 MHz

Used conversion factor: Output power (dBm) = $10 \log (\text{Output power (W)} / 1\text{mW})$

The measured output power of the system is below 125 mW (21.0 dBm). For the results, please refer to the related chapter of this report.

Therefore, the limit is determined as 1.5 MHz.

5.1.3 TEST PROTOCOL

Ambient temperature: 25 °C
 Air Pressure: 1009 hPa
 Humidity: 50 %
 BT GFSK (1-DH1)

Band	Channel No.	Frequency [MHz]	20 dB Bandwidth [MHz]	Limit [MHz]	Margin to Limit [MHz]
2.4 GHz ISM	0	2402	0.875	1.515	0.640
	39	2441	0.875	1.515	0.640
	78	2480	0.915	1.515	0.600

BT π/4 DQPSK (2-DH1)

Band	Channel No.	Frequency [MHz]	20 dB Bandwidth [MHz]	Limit [MHz]	Margin to Limit [MHz]
2.4 GHz ISM	0	2402	1.185	1.515	0.330
	39	2441	1.185	1.515	0.330
	78	2480	1.185	1.515	0.330

BT 8-DPSK (3-DH1)

Band	Channel No.	Frequency [MHz]	20 dB Bandwidth [MHz]	Limit [MHz]	Margin to Limit [MHz]
2.4 GHz ISM	0	2402	1.215	1.515	0.300
	39	2441	1.215	1.515	0.300
	78	2480	1.215	1.515	0.300

5.1.4 MEASUREMENT PLOT (EXAMPLE PLOT, SHOWING WORST CASE, IF APPLICABLE)

Radio Technology = Bluetooth BDR, Operating Frequency = low (S01_ab01_BT_Headset)

20 dB Bandwidth

DUT Frequency (MHz)	Bandwidth (MHz)	Limit Min (MHz)	Limit Max (MHz)	Band Edge Left (MHz)	Band Edge Right (MHz)	Max Level (dBm)	Result
2402.000000	0.875000	---	---	2401.577500	2402.452500	-5.8	PASS

20 dB Bandwidth

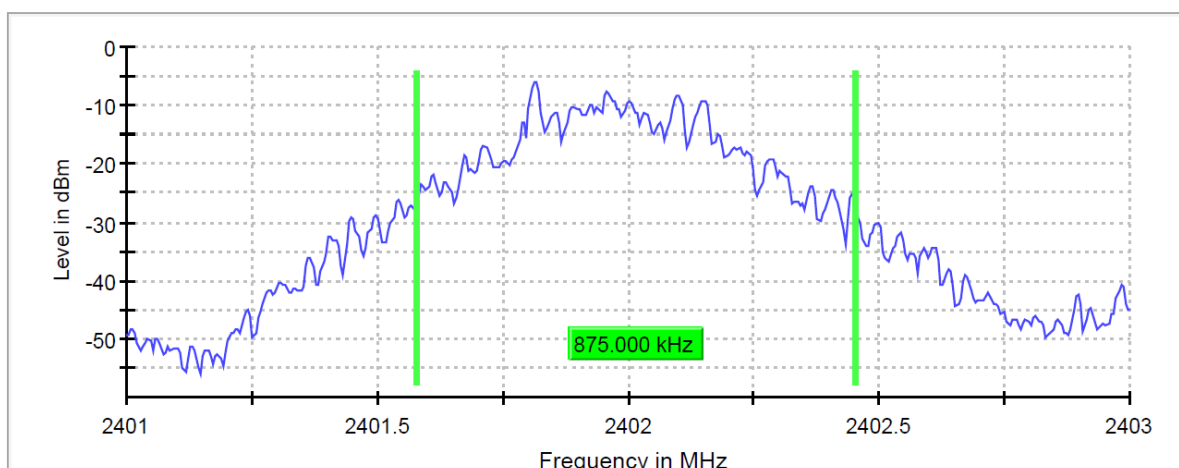

Radio Technology = Bluetooth BDR, Operating Frequency = mid
(S01_ab01_BT_ Headset)

20 dB Bandwidth

DUT Frequency (MHz)	Bandwidth (MHz)	Limit Min (MHz)	Limit Max (MHz)	Band Edge Left (MHz)	Band Edge Right (MHz)	Max Level (dBm)	Result
2441.000000	0.875000	---	---	2440.537500	2441.412500	-4.7	PASS

20 dB Bandwidth

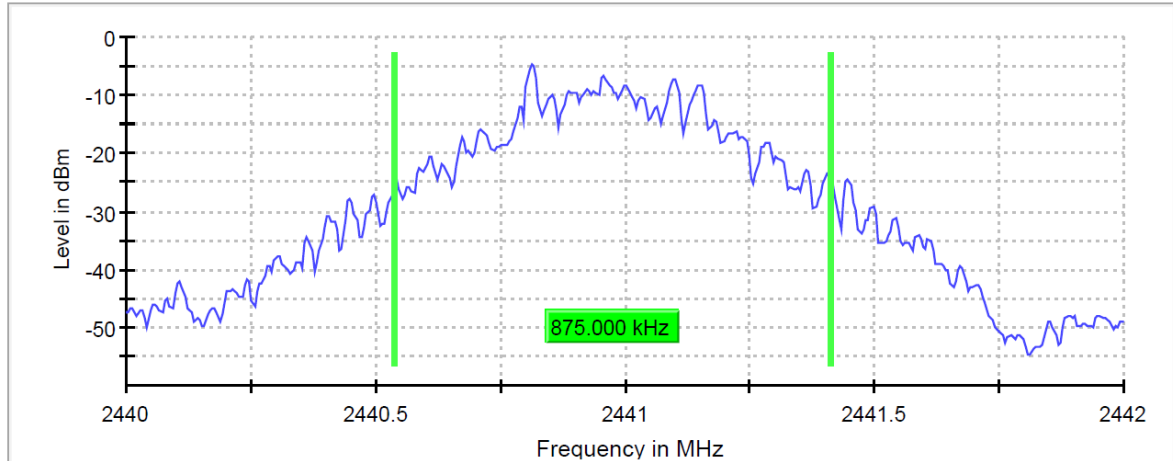

Radio Technology = Bluetooth BDR, Operating Frequency = high
(S01_ab01_BT_ Headset)

20 dB Bandwidth

DUT Frequency (MHz)	Bandwidth (MHz)	Limit Min (MHz)	Limit Max (MHz)	Band Edge Left (MHz)	Band Edge Right (MHz)	Max Level (dBm)	Result
2480.000000	0.915000	---	---	2479.537500	2480.452500	-4.5	PASS

20 dB Bandwidth

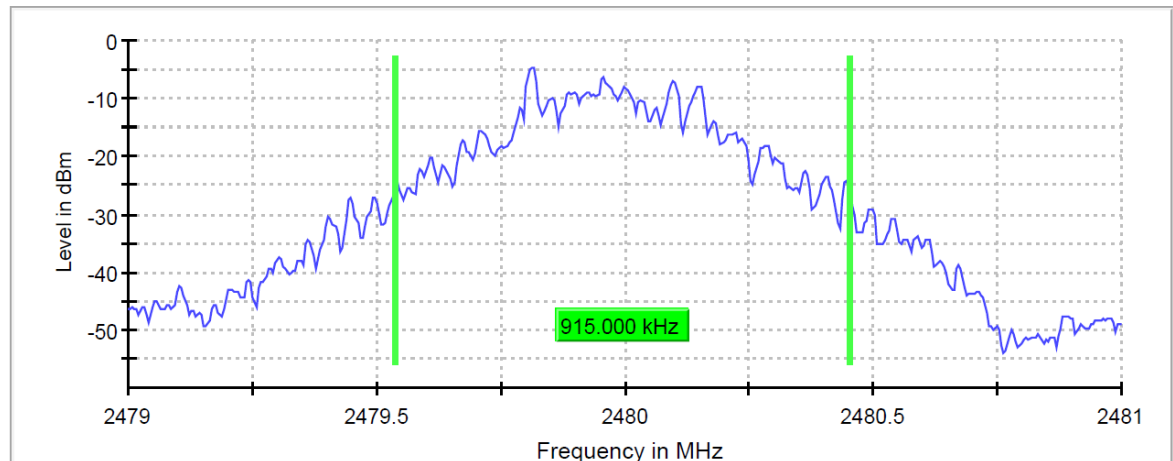

Radio Technology = Bluetooth EDR 2, Operating Frequency = low
(S01_ab01_BT_ Headset)

20 dB Bandwidth

DUT Frequency (MHz)	Bandwidth (MHz)	Limit Min (MHz)	Limit Max (MHz)	Band Edge Left (MHz)	Band Edge Right (MHz)	Max Level (dBm)	Result
2402.000000	1.185000	---	---	2401.377500	2402.562500	-7.3	PASS

20 dB Bandwidth

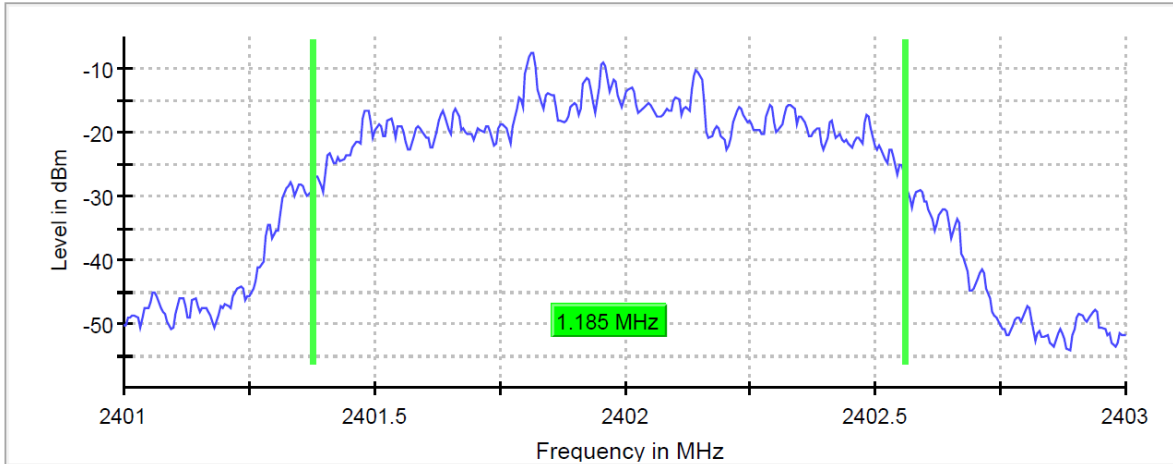

Radio Technology = Bluetooth EDR 2, Operating Frequency = mid
(S01_ab01_BT_ Headset)

20 dB Bandwidth

DUT Frequency (MHz)	Bandwidth (MHz)	Limit Min (MHz)	Limit Max (MHz)	Band Edge Left (MHz)	Band Edge Right (MHz)	Max Level (dBm)	Result
2441.000000	1.185000	---	---	2440.377500	2441.562500	-6.2	PASS

20 dB Bandwidth

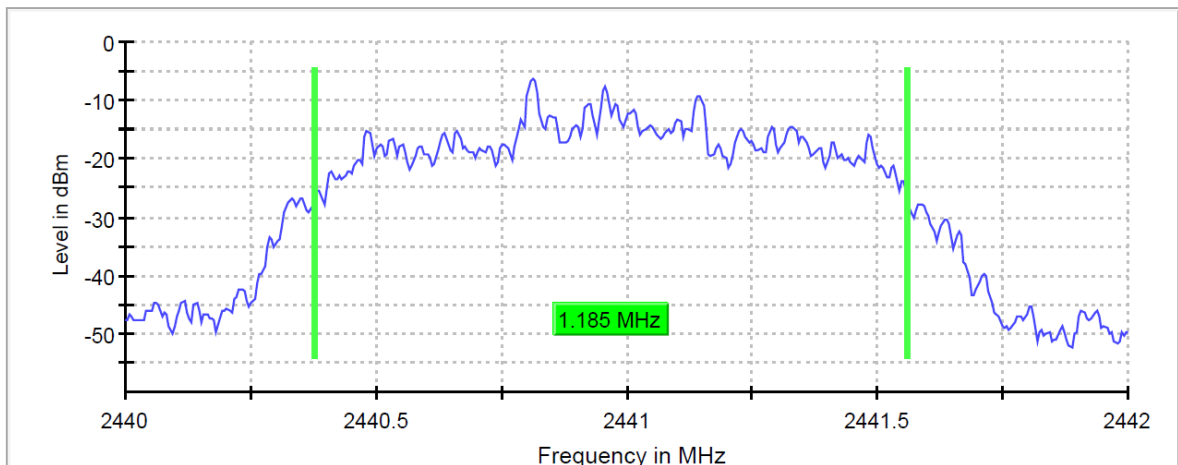

Radio Technology = Bluetooth EDR 2, Operating Frequency = high
(S01_ab01_BT_Headset)

20 dB Bandwidth

DUT Frequency (MHz)	Bandwidth (MHz)	Limit Min (MHz)	Limit Max (MHz)	Band Edge Left (MHz)	Band Edge Right (MHz)	Max Level (dBm)	Result
2480.000000	1.185000	---	---	2479.377500	2480.562500	-5.9	PASS

20 dB Bandwidth

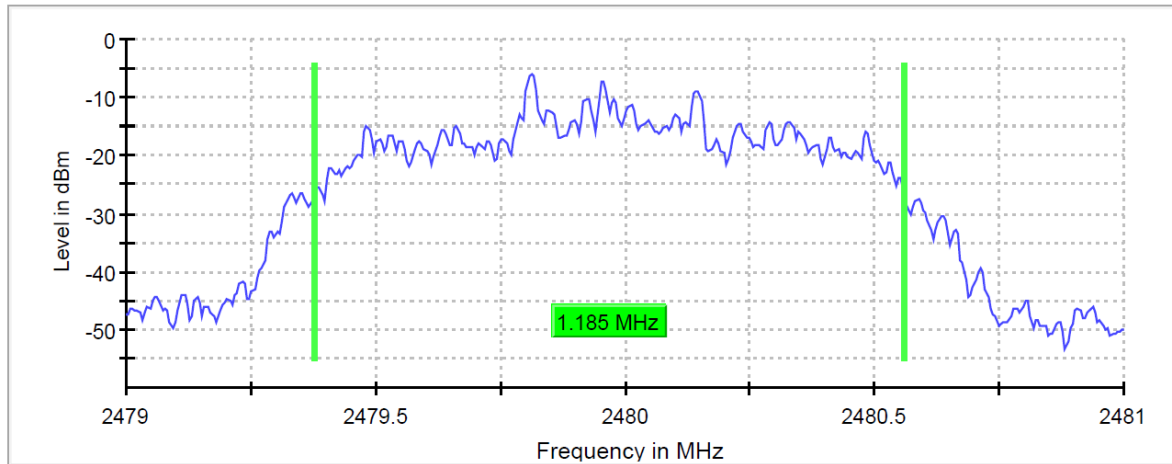

Radio Technology = Bluetooth EDR 3, Operating Frequency = low
(S01_ab01_BT_Headset)

20 dB Bandwidth

DUT Frequency (MHz)	Bandwidth (MHz)	Limit Min (MHz)	Limit Max (MHz)	Band Edge Left (MHz)	Band Edge Right (MHz)	Max Level (dBm)	Result
2402.000000	1.215000	---	---	2401.387500	2402.602500	-8.7	PASS

20 dB Bandwidth

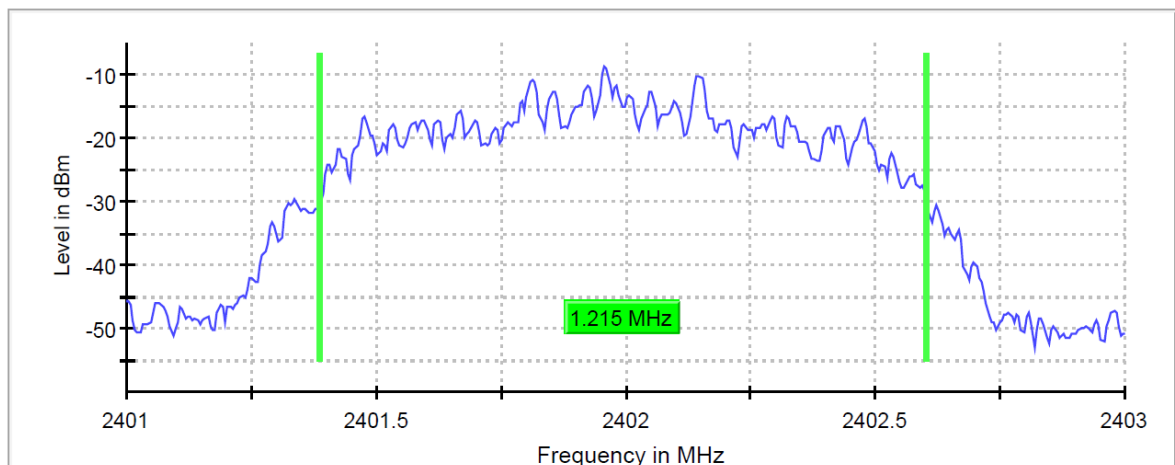

Radio Technology = Bluetooth EDR 3, Operating Frequency = mid
(S01_ab01_BT_Headset)

20 dB Bandwidth

DUT Frequency (MHz)	Bandwidth (MHz)	Limit Min (MHz)	Limit Max (MHz)	Band Edge Left (MHz)	Band Edge Right (MHz)	Max Level (dBm)	Result
2441.000000	1.215000	--	--	2440.387500	2441.602500	-7.6	PASS

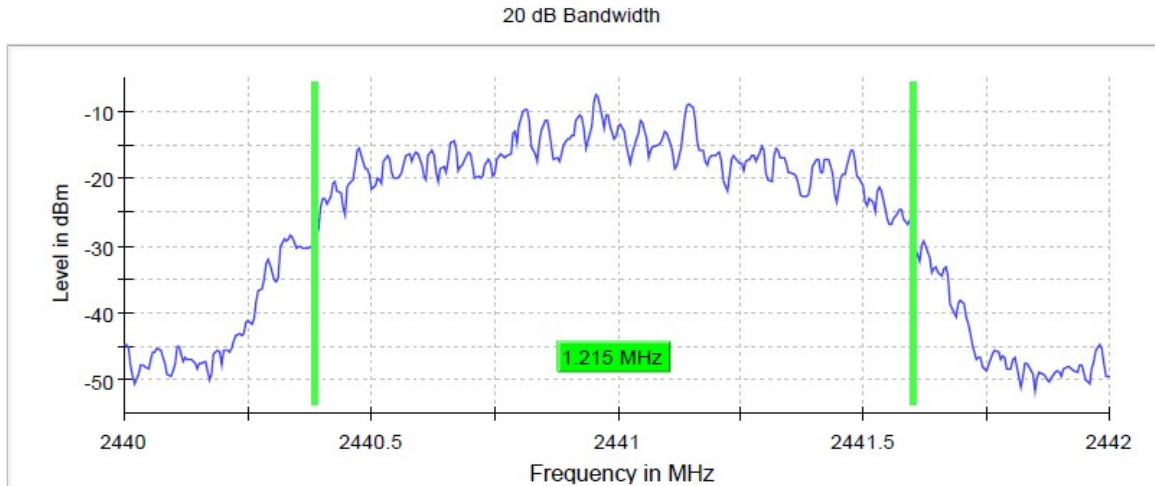

Radio Technology = Bluetooth EDR 3, Operating Frequency = high
(S01_ab01_BT_Headset)

20 dB Bandwidth

DUT Frequency (MHz)	Bandwidth (MHz)	Limit Min (MHz)	Limit Max (MHz)	Band Edge Left (MHz)	Band Edge Right (MHz)	Max Level (dBm)	Result
2480.000000	1.215000	---	---	2479.387500	2480.602500	-7.2	PASS

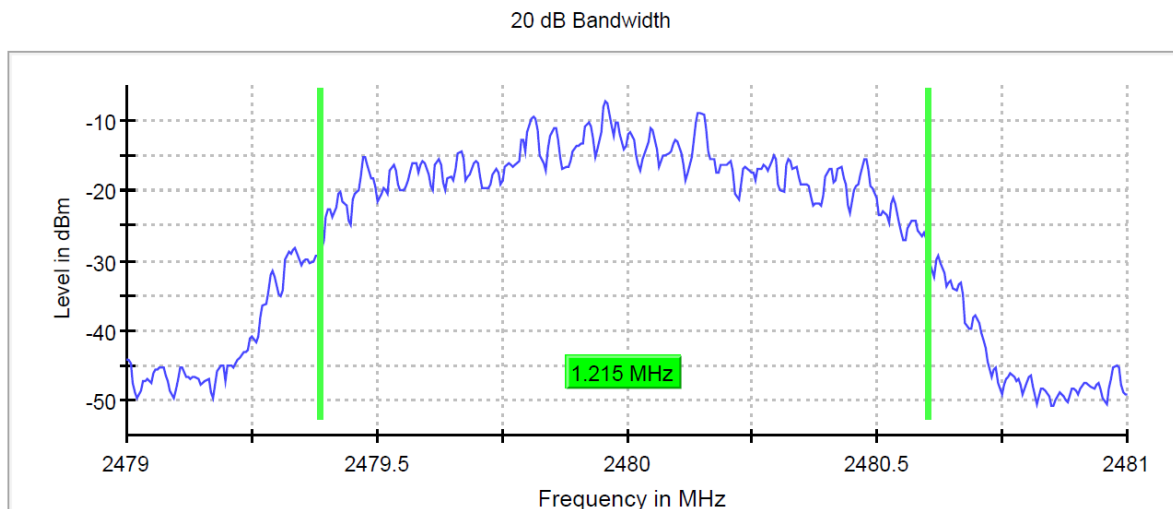

5.1.5 TEST EQUIPMENT USED

- R&S TS8997

5.2 OCCUPIED BANDWIDTH (99%)

Standard **FCC Part 15 Subpart C**

The test was performed according to:
ANSI C63.10

5.2.1 TEST DESCRIPTION

The Equipment Under Test (EUT) was set up to perform the occupied bandwidth measurements.

The reference level is the level of the highest amplitude signal observed from the transmitter at either the fundamental frequency or first-order modulation products in all typical modes of operation, including the unmodulated carrier, even if atypical.

The EUT was connected to the test system as described in the block diagram below. The complete attenuation of the measurement path is known and considered.

Analyser settings:

- Resolution Bandwidth (RBW): 1 to 5 % of the OBW
- Video Bandwidth (VBW): ≥ 3 times the RBW
- Span: 1.5 to 5 times the OBW
- Trace: Maxhold
- Sweeps: Till stable (min. 500, max. 75000)
- Sweep Time: Auto
- Detector: Peak

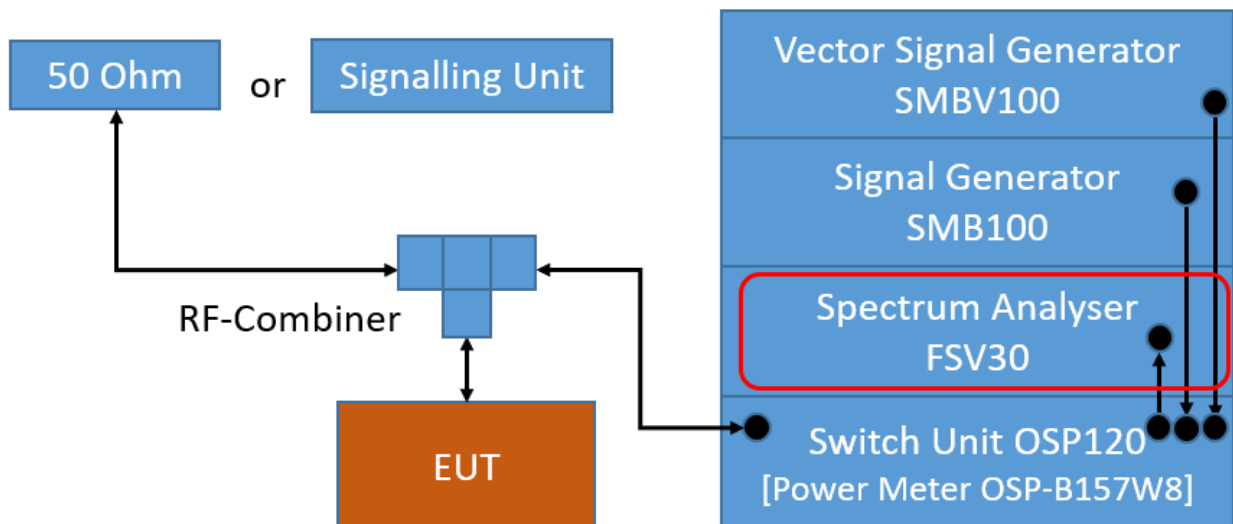

TS8997; Channel Bandwidth

5.2.2 TEST REQUIREMENTS / LIMITS

No applicable limit: the measurement is for information purpose.

5.2.3 TEST PROTOCOL

Ambient temperature: 25 °C
 Air Pressure: 1009 hPa
 Humidity: 50 %
 BT GFSK (1-DH1)

Band	Channel No.	Frequency [MHz]	99 % Bandwidth [MHz]
2.4 GHz ISM	0	2402	0.830
	39	2441	0.840
	78	2480	0.840

BT π/4 DQPSK (2-DH1)

Band	Channel No.	Frequency [MHz]	99 % Bandwidth [MHz]
2.4 GHz ISM	0	2402	1.145
	39	2441	1.150
	78	2480	1.140

BT 8-DPSK (3-DH1)

Band	Channel No.	Frequency [MHz]	99 % Bandwidth [MHz]
2.4 GHz ISM	0	2402	1.155
	39	2441	1.550
	78	2480	1.550

Remark: Please see next sub-clause for the measurement plot.

5.2.4 MEASUREMENT PLOT (EXAMPLE PLOT, SHOWING WORST CASE, IF APPLICABLE)

Radio Technology = Bluetooth BDR, Operating Frequency = mid
 (S01_ab01_BT_Headset)

99 % Bandwidth

DUT Frequency (MHz)	Bandwidth (MHz)	Limit Min (MHz)	Limit Max (MHz)	Band Edge Left (MHz)	Band Edge Right (MHz)	Result
2441.000000	0.840000	---	---	2440.562500	2441.402500	PASS

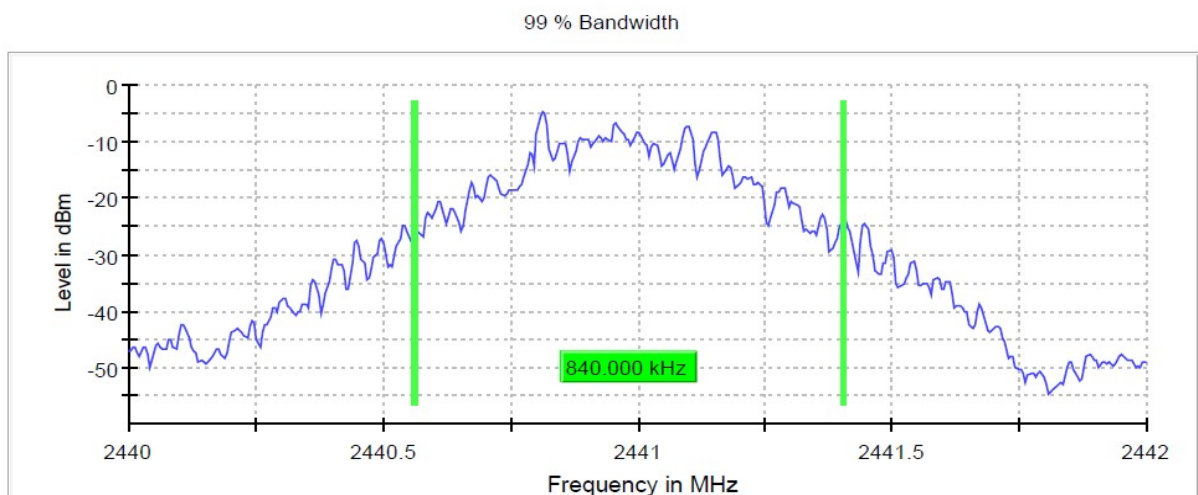

Radio Technology = Bluetooth EDR 2, Operating Frequency = mid
(S01_ab01_BT_Headset)

99 % Bandwidth

DUT Frequency (MHz)	Bandwidth (MHz)	Limit Min (MHz)	Limit Max (MHz)	Band Edge Left (MHz)	Band Edge Right (MHz)	Result
2441.000000	1.150000	---	---	2440.392500	2441.542500	PASS

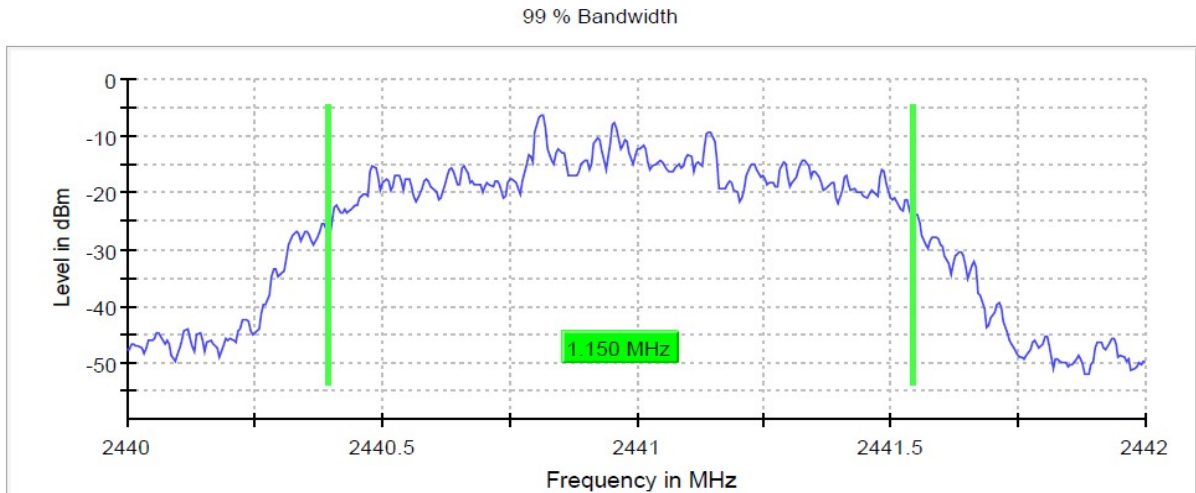

Radio Technology = Bluetooth EDR 3, Operating Frequency = low
(S01_ab01_BT_Headset)

99 % Bandwidth

DUT Frequency (MHz)	Bandwidth (MHz)	Limit Min (MHz)	Limit Max (MHz)	Band Edge Left (MHz)	Band Edge Right (MHz)	Result
2402.000000	1.155000	---	---	2401.407500	2402.562500	PASS

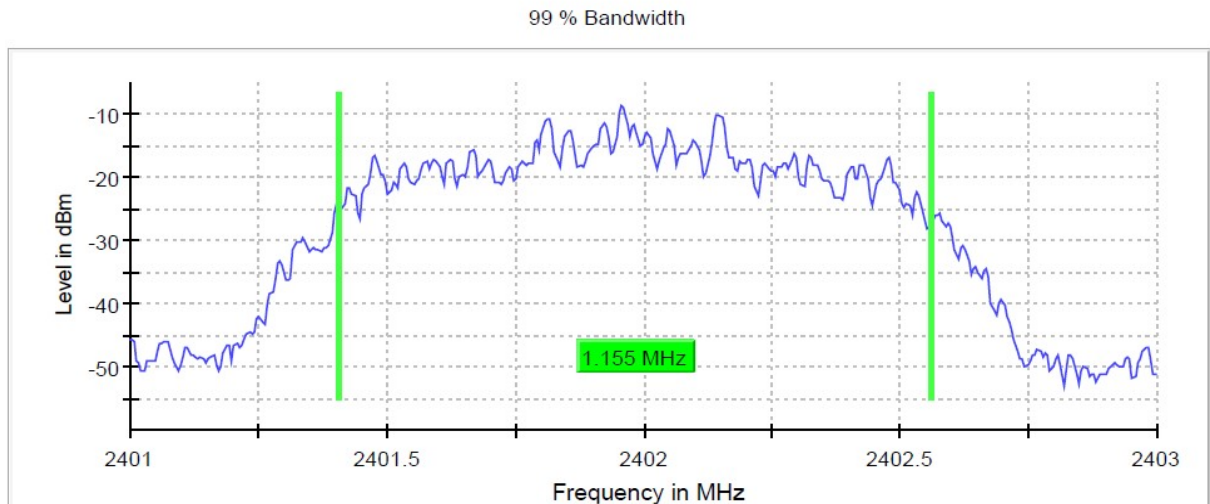

5.2.5 TEST EQUIPMENT USED

- R&S TS8997

5.3 PEAK POWER OUTPUT

Standard **FCC Part 15 Subpart C**

The test was performed according to:
ANSI C63.10

5.3.1 TEST DESCRIPTION

FHSS EQUIPMENT:

The Equipment Under Test (EUT) was set up to perform the output power measurements. The results recorded were measured with the modulation which produces the worst-case (highest) output power. The reference level of the spectrum analyser was set higher than the output power of the EUT.

The EUT was connected to the test system as described in the block diagram below. The complete attenuation of the measurement path is known and considered.

Analyser settings:

- Resolution Bandwidth (RBW): ≥ 20 dB BW
- Video Bandwidth (VBW): ≥ 3 times RBW
- Trace: Maxhold
- Sweeps: Till stable (min. 300, max. 15000)
- Sweep time: Auto
- Detector: Peak

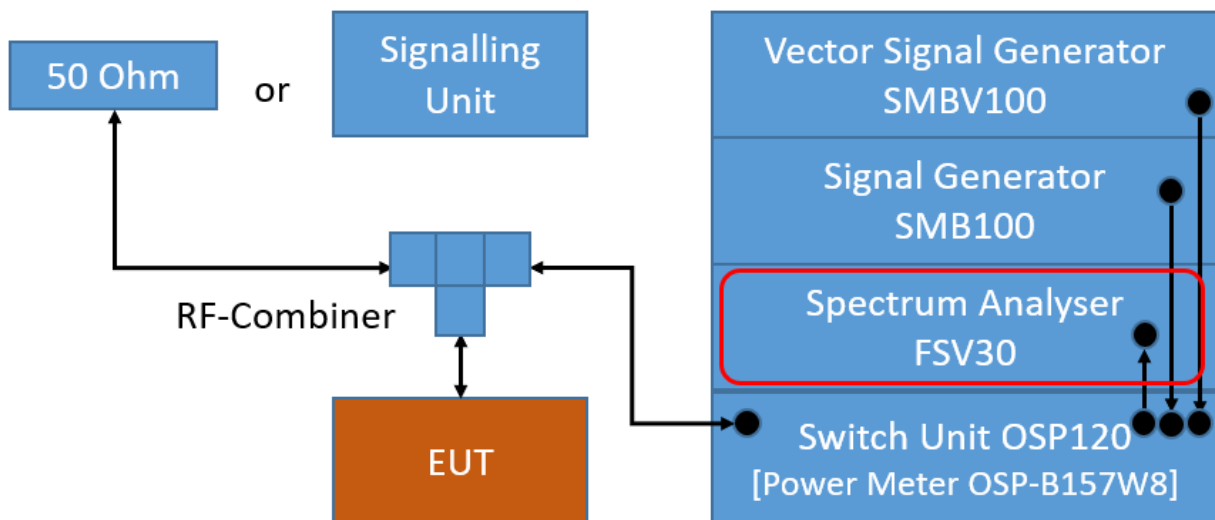

TS8997; Output Power

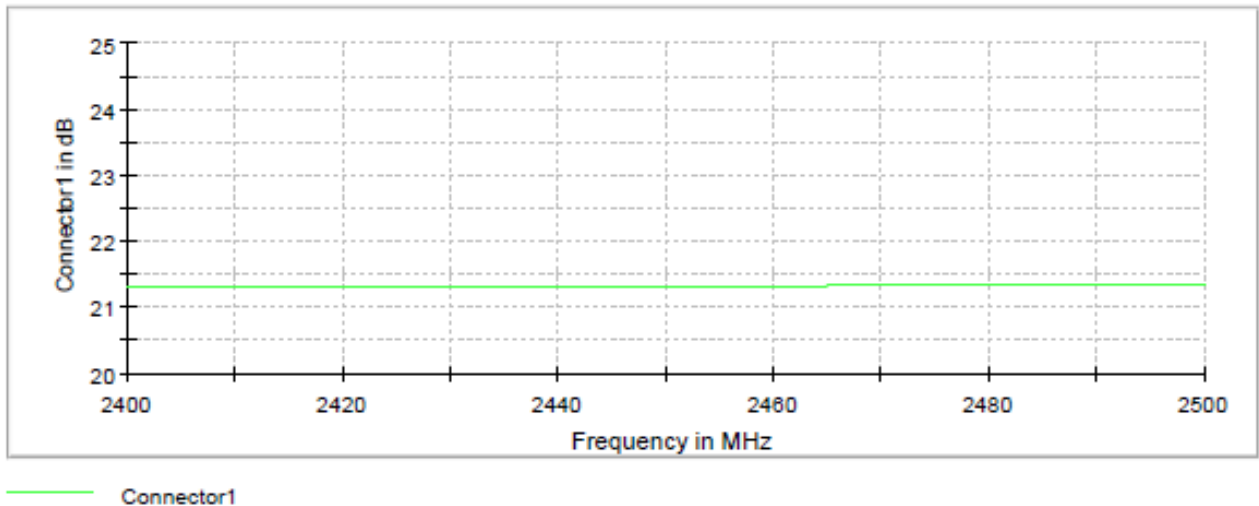

Attenuation Output power

5.3.2 TEST REQUIREMENTS / LIMITS

DTS devices:

FCC Part 15, Subpart C, §15.247 (b) (3)

For systems using digital modulation techniques in the 902-928 MHz, 2400-2483.5 MHz and 5725-5850 MHz bands: 1 watt.

==> Maximum conducted peak output power: 30 dBm (excluding antenna gain, if antennas with directional gains that do not exceed 6 dBi are used).

Frequency Hopping Systems:

FCC Part 15, Subpart C, §15.247 (b) (1)

For frequency hopping systems operating in the 2400-2483.5 MHz band employing at least 75 non-overlapping hopping channels, and all frequency hopping systems in the 5725-5850 MHz band: 1 watt. For all other frequency hopping systems in the 2400-2483.5 MHz band: 0.125 watts.

FCC Part 15, Subpart C, §15.247 (b) (2)

For frequency hopping systems operating in the 902-928 MHz band: 1 watt for systems employing at least 50 hopping channels; and, 0.25 watts for systems employing less than 50 hopping channels, but at least 25 hopping channels, as permitted under paragraph (a)(1)(i) of this section.

Used conversion factor: Limit (dBm) = 10 log (Limit (W)/1mW)

5.3.3 TEST PROTOCOL

Ambient temperature: 25 °C
 Air Pressure: 1009 hPa
 Humidity: 50 %
 BT GFSK (1-DH1)

Band	Channel No.	Frequency [MHz]	Peak Power [dBm]	Limit [dBm]	Margin to Limit [dB]	E.I.R.P [dBm]
2.4 GHz ISM	0	2402	-0.5	21.0	21.5	2.5
	39	2441	0.5	21.0	20.5	2.5
	78	2480	0.7	21.0	20.3	2.5

BT π/4 DQPSK (2-DH1)

Band	Channel No.	Frequency [MHz]	Peak Power [dBm]	Limit [dBm]	Margin to Limit [dB]	E.I.R.P [dBm]
2.4 GHz ISM	0	2402	-1.3	21.0	22.3	1.7
	39	2441	-0.3	21.0	21.3	2.7
	78	2480	-0.1	21.0	21.1	2.9

BT 8-DPSK (3-DH1)

Band	Channel No.	Frequency [MHz]	Peak Power [dBm]	Limit [dBm]	Margin to Limit [dB]	E.I.R.P [dBm]
2.4 GHz ISM	0	2402	-0.8	21.0	21.8	2.2
	39	2441	0.1	21.0	20.9	3.1
	78	2480	0.3	21.0	20.7	3.3

Remark: Please see next sub-clause for the measurement plot.

5.3.4 MEASUREMENT PLOT (EXAMPLE PLOT, SHOWING WORST CASE, IF APPLICABLE)

Radio Technology = Bluetooth BDR, Operating Frequency = low,
 Measurement method = conducted
 (S01_ab01_BT_Headset)

Result

DUT Frequency (MHz)	Peak Power (dBm)	Limit Max (dBm)	Result
2402.000000	-0.5	21.0	PASS

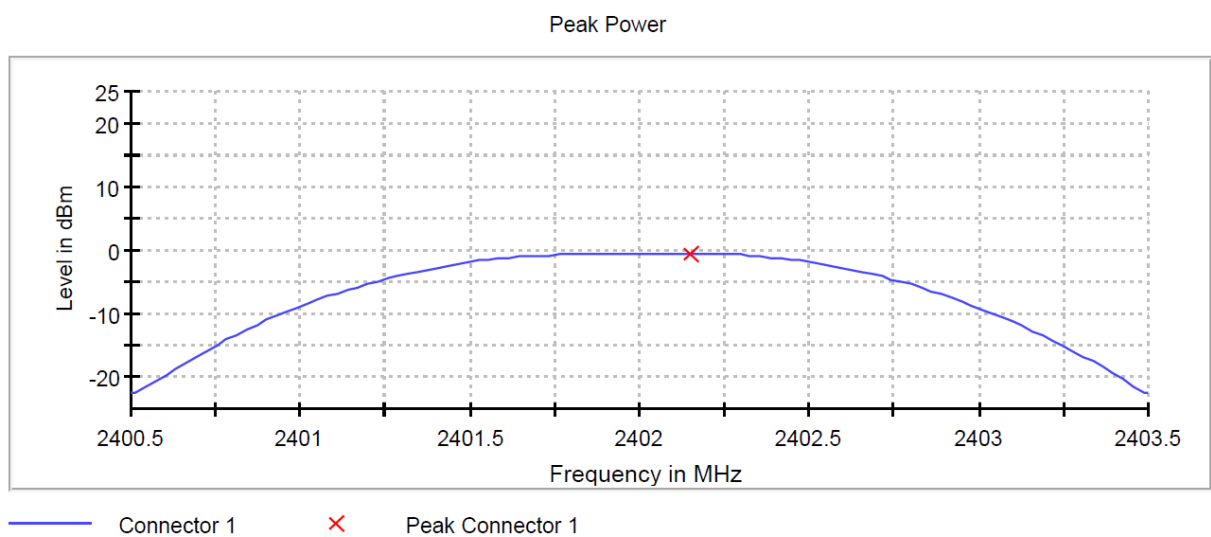

Radio Technology = Bluetooth BDR, Operating Frequency = mid,
Measurement method = conducted
(S01_ab01_BT_Headset)

Result

DUT Frequency (MHz)	Peak Power (dBm)	Limit Max (dBm)	Result
2441.000000	0.5	21.0	PASS

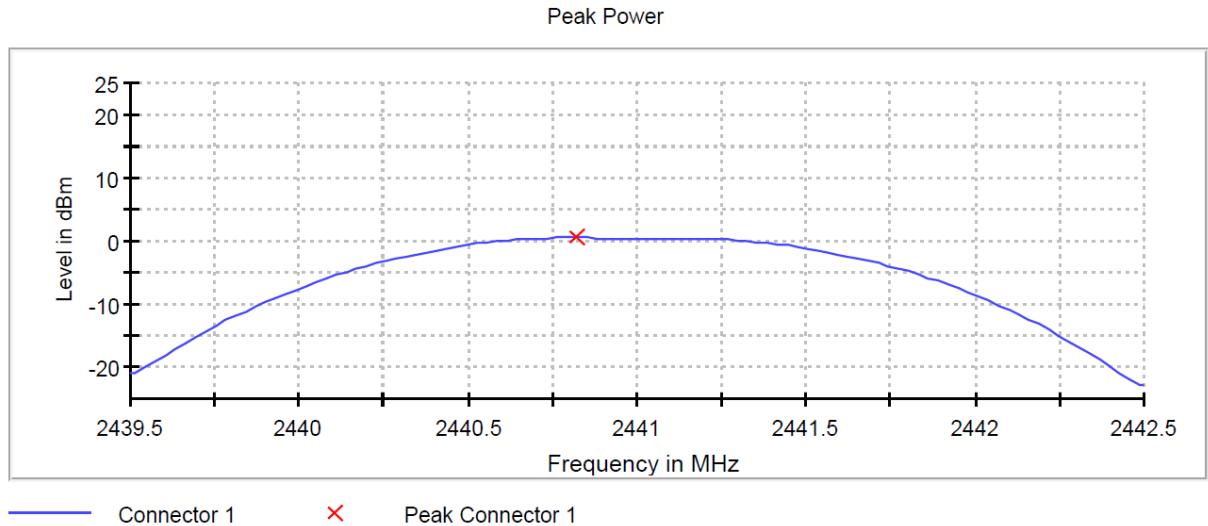

Radio Technology = Bluetooth BDR, Operating Frequency = high,
Measurement method = conducted
(S01_ab01_BT_Headset)

Result

DUT Frequency (MHz)	Peak Power (dBm)	Limit Max (dBm)	Result
2480.000000	0.7	21.0	PASS

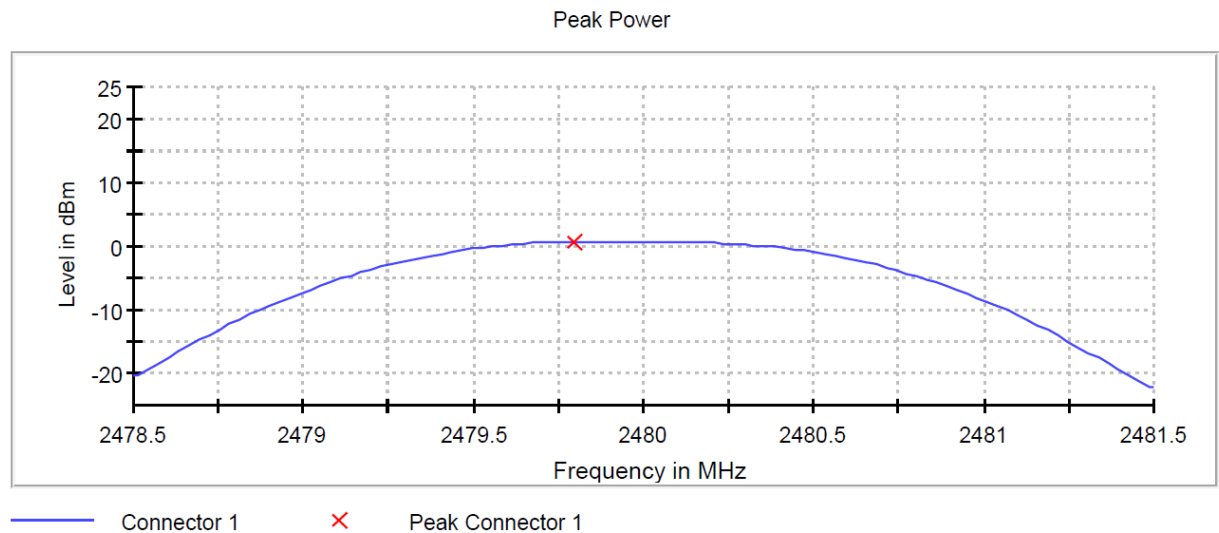

Radio Technology = Bluetooth EDR 2, Operating Frequency = low,
Measurement method = conducted
(S01_ab01_BT_Headset)

Result

DUT Frequency (MHz)	Peak Power (dBm)	Limit Max (dBm)	Result
2402.000000	-1.3	21.0	PASS

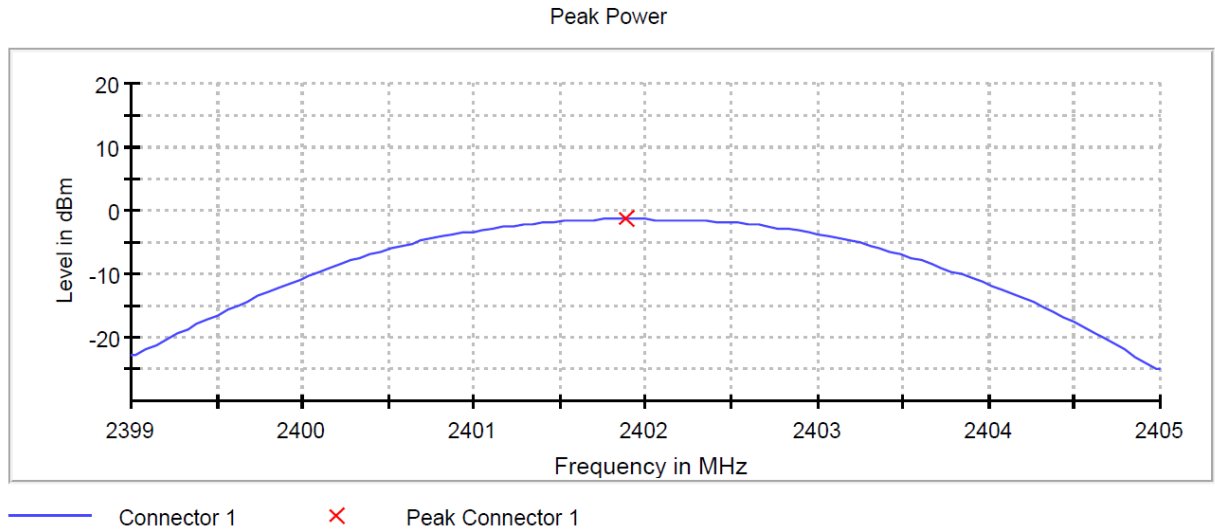

Radio Technology = Bluetooth EDR 2, Operating Frequency = mid,
Measurement method = conducted
(S01_ab01_BT_Headset)

Result

DUT Frequency (MHz)	Peak Power (dBm)	Limit Max (dBm)	Result
2441.000000	-0.3	21.0	PASS

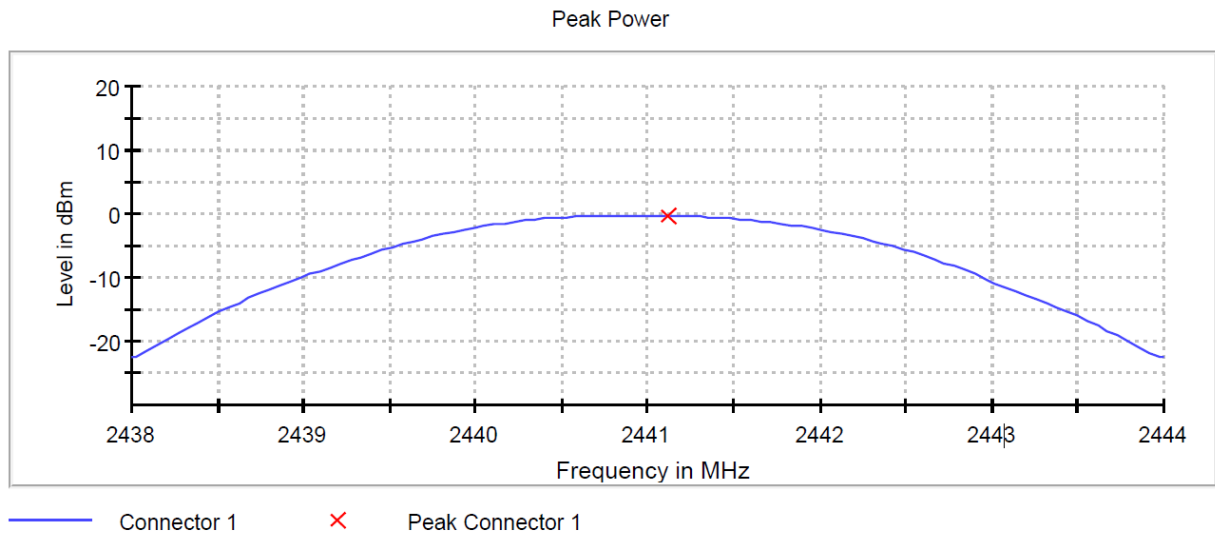

Radio Technology = Bluetooth EDR 2, Operating Frequency = high,
Measurement method = conducted
(S01_ab01_BT_Headset)

Result

DUT Frequency (MHz)	Peak Power (dBm)	Limit Max (dBm)	Result
2480.000000	-0.1	21.0	PASS

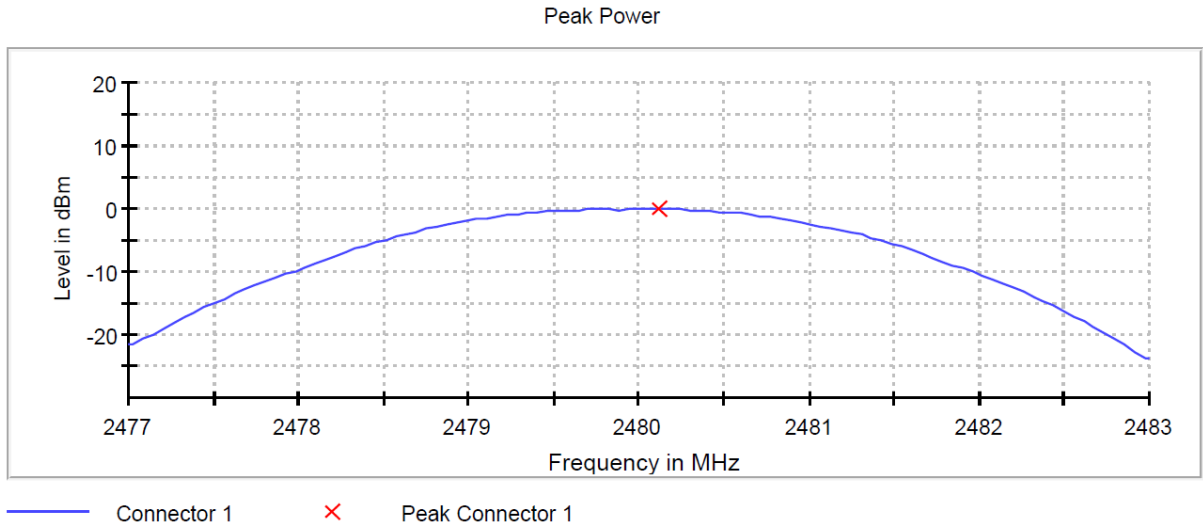

Radio Technology = Bluetooth EDR 3, Operating Frequency = low,
Measurement method = conducted
(S01_ab01_BT_Headset)

Result

DUT Frequency (MHz)	Peak Power (dBm)	Limit Max (dBm)	Result
2402.000000	-0.8	21.0	PASS

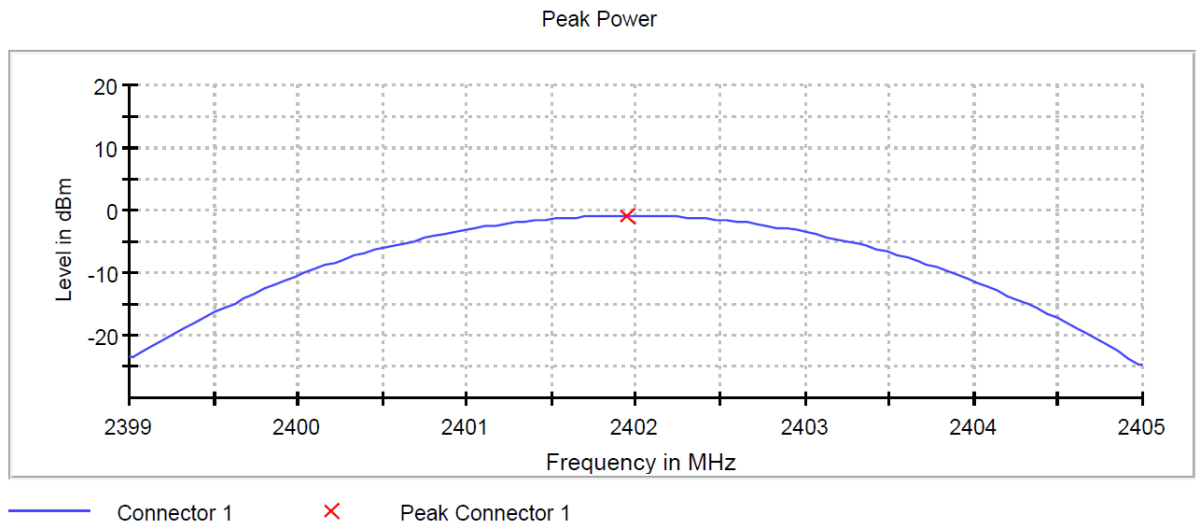

Radio Technology = Bluetooth EDR 3, Operating Frequency = mid,
Measurement method = conducted
(S01_ab01_BT_Headset)

Result

DUT Frequency (MHz)	Peak Power (dBm)	Limit Max (dBm)	Result
2441.000000	0.1	21.0	PASS

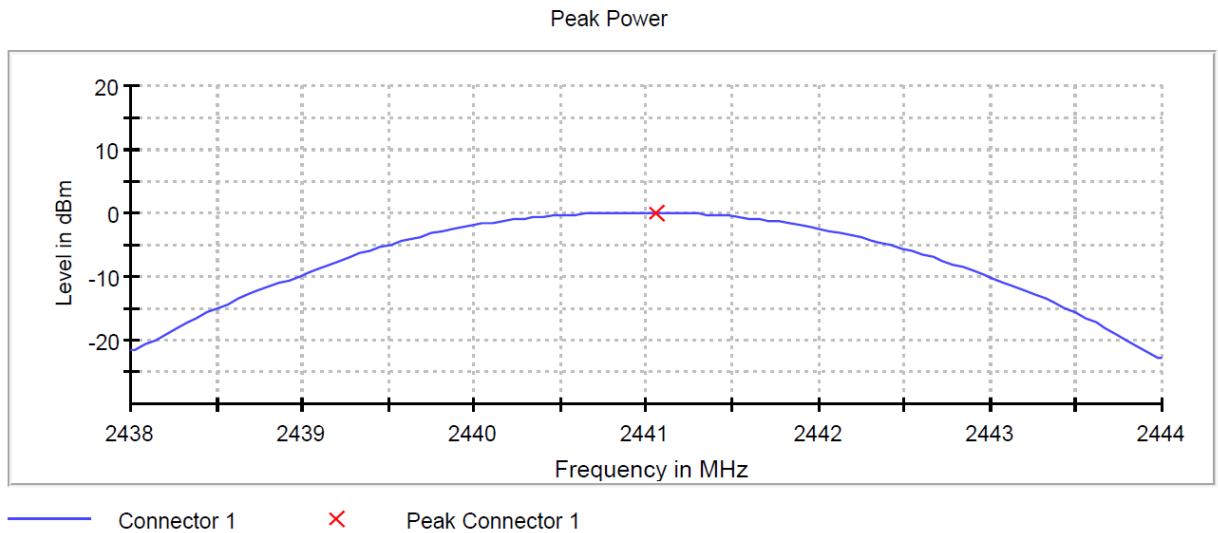

Radio Technology = Bluetooth EDR 3, Operating Frequency = high,
Measurement method = conducted
(S01_ab01_BT_Headset)

Result

DUT Frequency (MHz)	Peak Power (dBm)	Limit Max (dBm)	Result
2480.000000	0.3	21.0	PASS

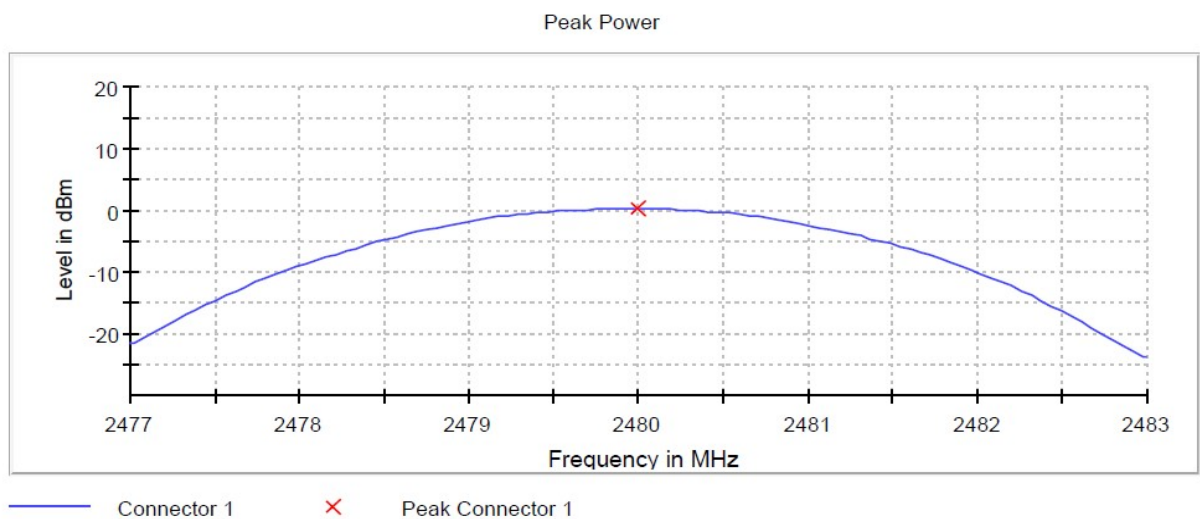

5.3.5 TEST EQUIPMENT USED

- R&S TS8997

5.4 SPURIOUS RF CONDUCTED EMISSIONS

Standard **FCC Part 15 Subpart C**

The test was performed according to:
ANSI C63.10

5.4.1 TEST DESCRIPTION

The Equipment Under Test (EUT) was set up to perform the spurious emissions measurements.

The EUT was connected to the test system as described in the block diagram below. The complete attenuation of the measurement path is known and considered.

Analyser settings:

- Frequency range: 30 – 26000 MHz
- Resolution Bandwidth (RBW): 100 kHz
- Video Bandwidth (VBW): 300 kHz
- Trace: Maxhold
- Sweeps: Till Stable (max. 120)
- Sweep Time: Auto
- Detector: Peak

The reference value for the measurement of the spurious RF conducted emissions is determined during the test "band edge compliance conducted". This value is used to calculate the 20 dBc or 30 dBc limit.

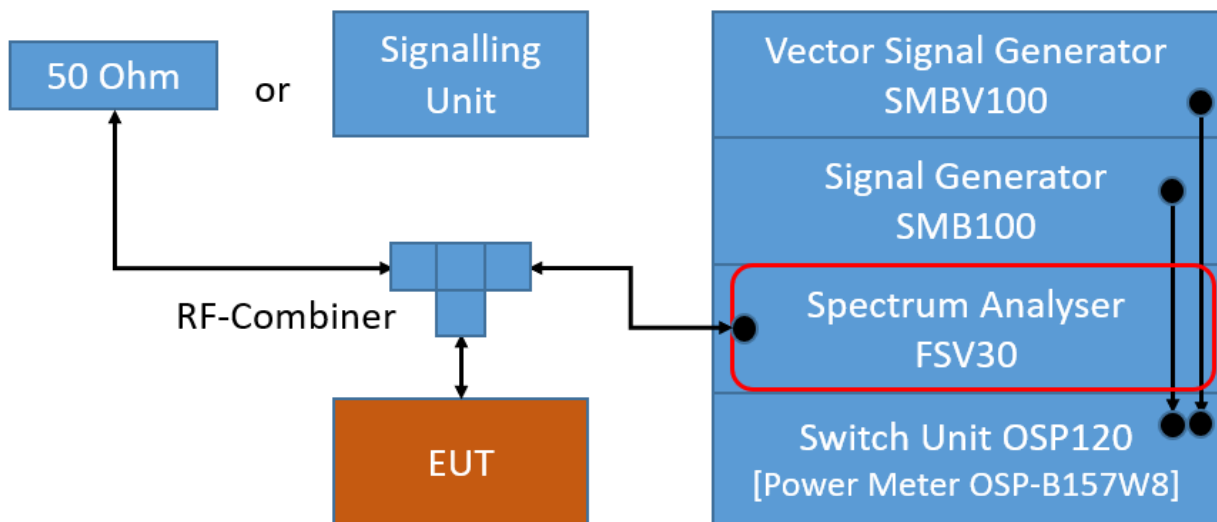

TS8997; Spurious RF Conducted Emissions

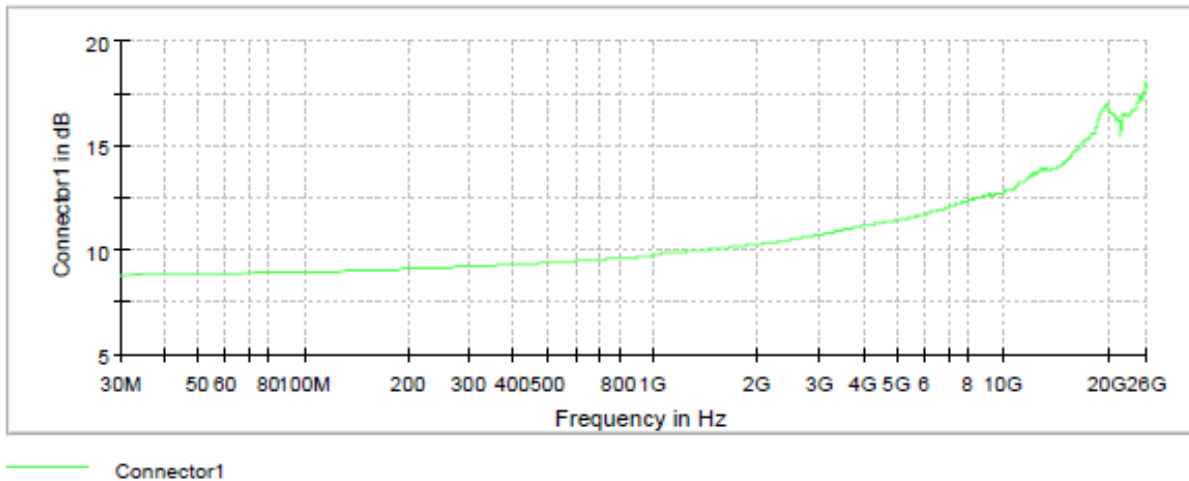

Attenuation of the measurement part

5.4.2 TEST REQUIREMENTS / LIMITS

FCC Part 15, Subpart C, §15.247 (c)

In any 100 kHz bandwidth outside the frequency band in which the spread spectrum intentional radiator is operating, the radio frequency power that is produced by the intentional radiator shall be at least 20 dB below that in the 100 kHz bandwidth within the band that contains the highest level of the desired power, based on either an RF conducted or a radiated measurement, provided the transmitter demonstrates compliance with the peak conducted power limits. If the transmitter complies with the conducted power limits based on the use of RMS averaging over a time interval, as permitted under paragraph (b)(3) of this section, the attenuation required under this paragraph shall be 30 dB instead of 20 dB.

5.4.3 TEST PROTOCOL

Ambient temperature: 25 °C
 Air Pressure: 1009 hPa
 Humidity: 50 %
 BT GFSK (1-DH1)

Channel No	Channel Center Freq. [MHz]	Spurious Freq. [MHz]	Spurious Level [dBm]	Detector	RBW [kHz]	Ref. Level [dBm]	Limit [dBm]	Margin to Limit [dB]
0	2402	2558.5	-51.7	PEAK	100	0.8	-19.2	32.5
39	2441	2589.4	-54.0	PEAK	100	-0.5	-20.5	33.5
78	2480	2638.4	-54.0	PEAK	100	1.0	-19.0	35.0

BT π/4 DQPSK (2-DH1)

Channel No	Channel Center Freq. [MHz]	Spurious Freq. [MHz]	Spurious Level [dBm]	Detector	RBW [kHz]	Ref. Level [dBm]	Limit [dBm]	Margin to Limit [dB]
0	2402	2395.0	-47.3	PEAK	100	-2.0	-22.0	25.3
39	2441	2395.0	-53.7	PEAK	100	-0.3	-20.3	33.4
78	2480	2325.3	-56.5	PEAK	100	-0.7	-20.7	35.8

BT 8-DPSK (3-DH1)

Channel No	Channel Center Freq. [MHz]	Spurious Freq. [MHz]	Spurious Level [dBm]	Detector	RBW [kHz]	Ref. Level [dBm]	Limit [dBm]	Margin to Limit [dB]
0	2402	2395.0	-46.9	PEAK	100	-1.9	-21.9	25.0
39	2441	2598.4	-54.0	PEAK	100	0.1	-19.9	34.1
78	2480	2638.4	-55.6	PEAK	100	-0.6	-20.6	35.0

Remark: Please see next sub-clause for the measurement plot.

5.4.4 MEASUREMENT PLOT (EXAMPLE PLOT, SHOWING WORST CASE, IF APPLICABLE)

Radio Technology = Bluetooth BDR, Operating Frequency = low
 (S01_ab01_BT_Headset)
 Spurious

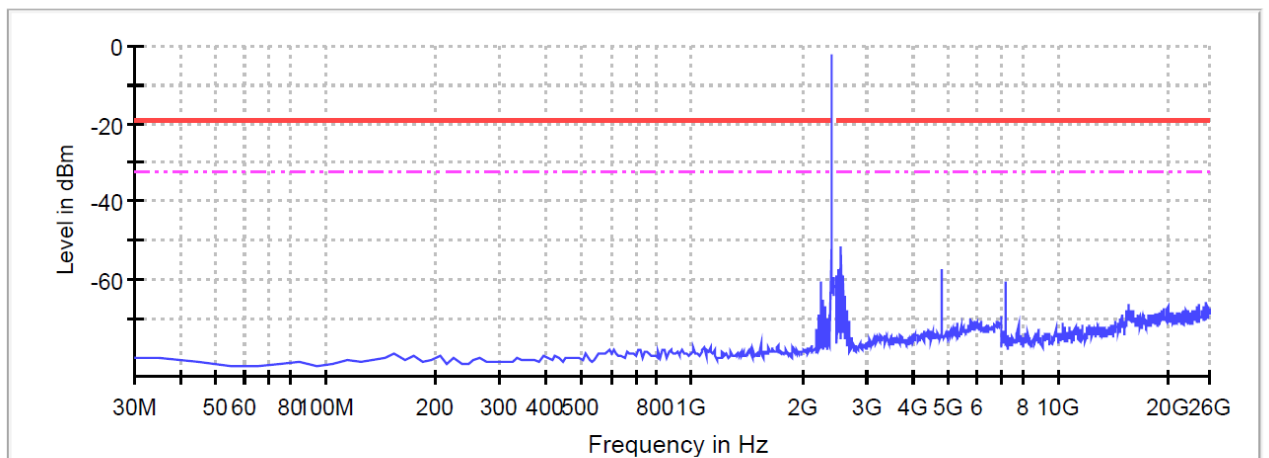

Radio Technology = Bluetooth BDR, Operating Frequency = mid
(S01_ab01_BT_Headset)

Spurious

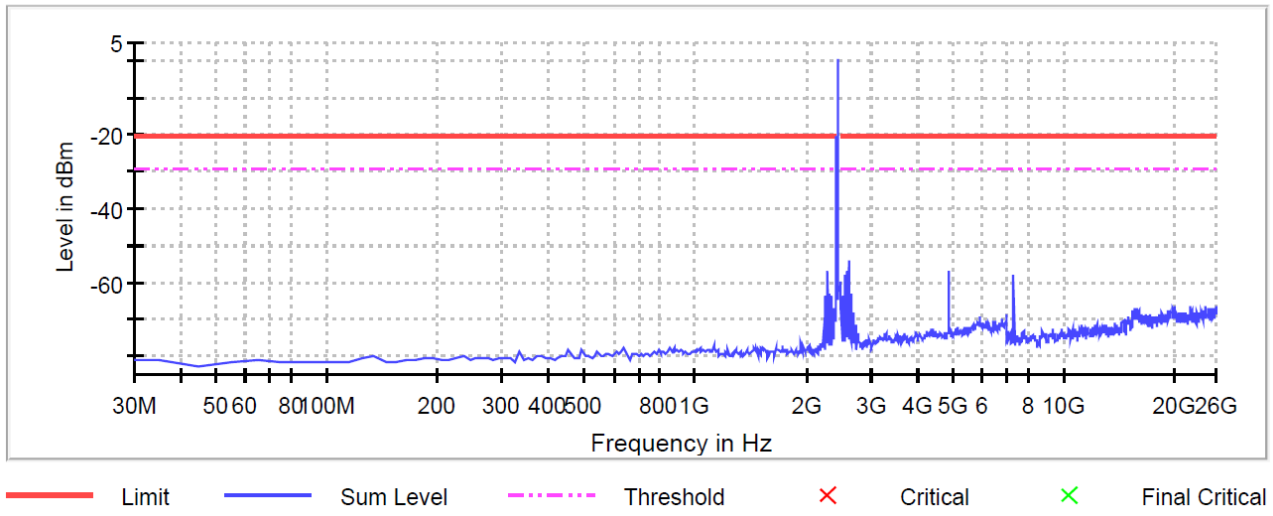

Radio Technology = Bluetooth BDR, Operating Frequency = high
(S01_ab01_BT_Headset)

Spurious

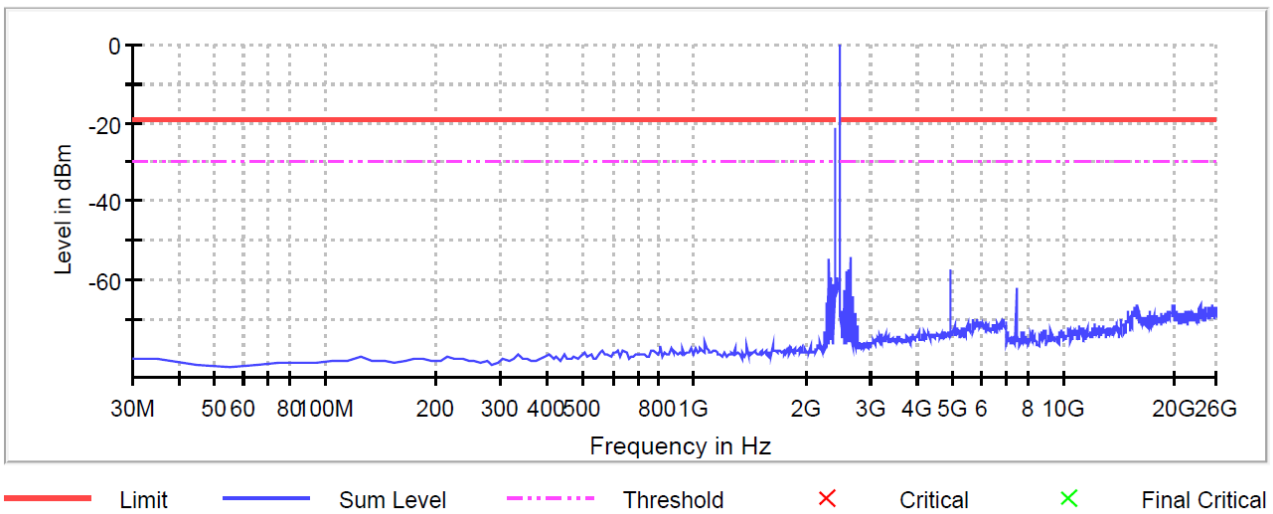

Radio Technology = Bluetooth EDR 2, Operating Frequency = low
 (S01_ab01_BT_Headset)
 Spurious

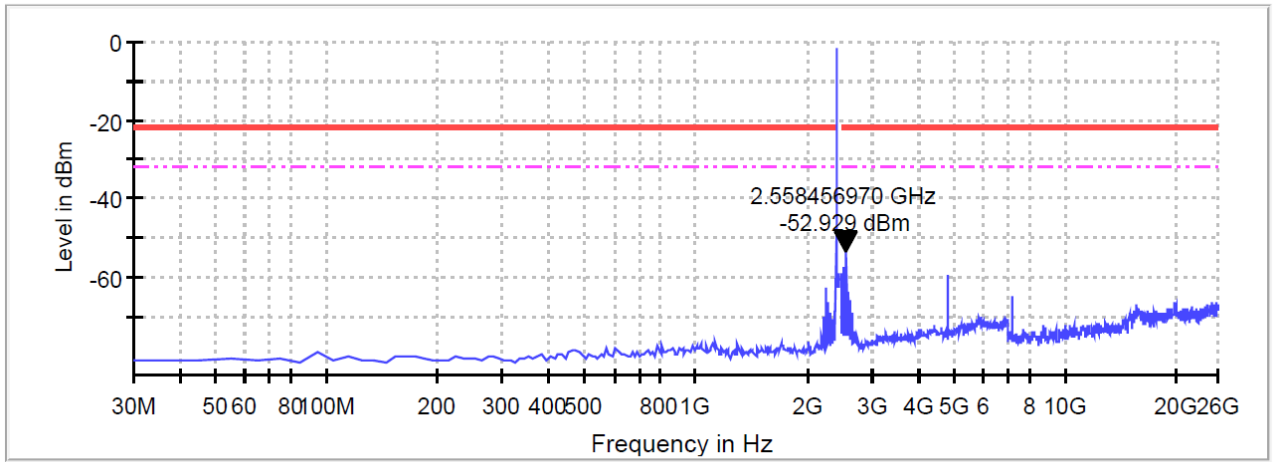

— Limit — Sum Level - - - Threshold × Critical × Final Critical

Radio Technology = Bluetooth EDR 2, Operating Frequency = mid
 (S01_ab01_BT_Headset)
 Spurious

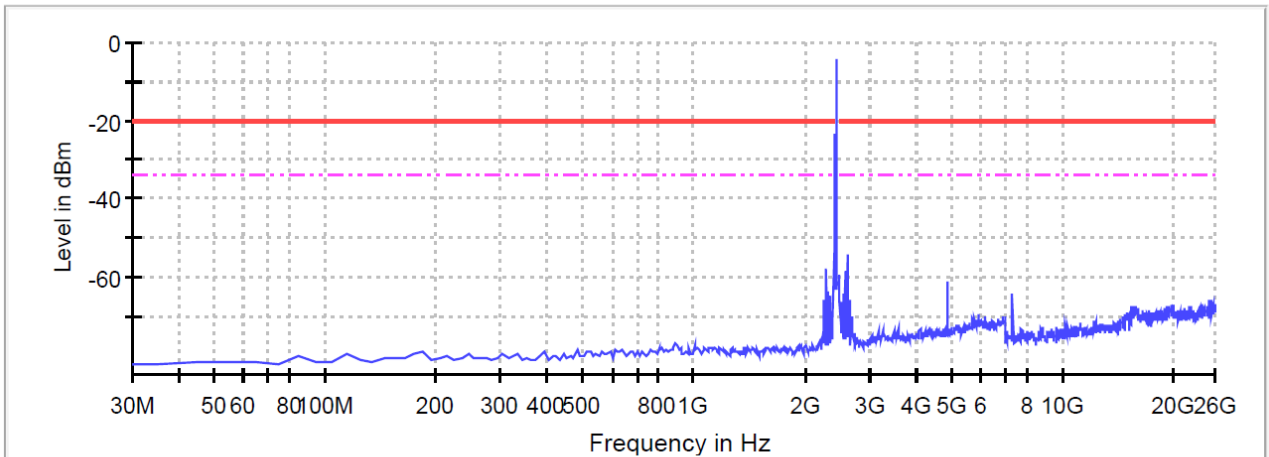

— Limit — Sum Level - - - Threshold × Critical × Final Critical

Radio Technology = Bluetooth EDR 2, Operating Frequency = high
 (S01_ab01_BT_Headset)
 Spurious

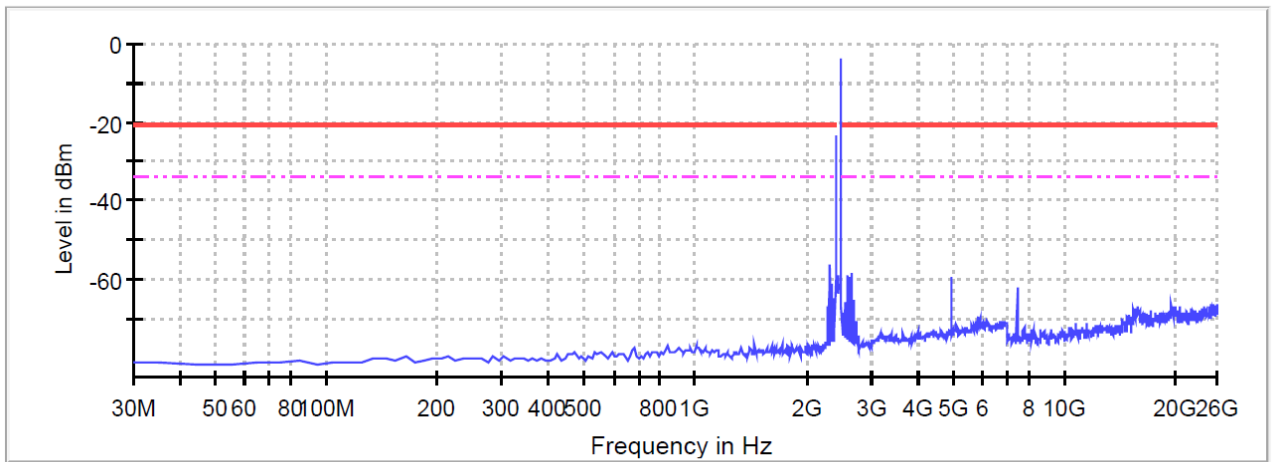

— Limit — Sum Level - - - Threshold × Critical × Final Critical

Radio Technology = Bluetooth EDR 3, Operating Frequency = low
 (S01_ab01_BT_Headset)

Spurious

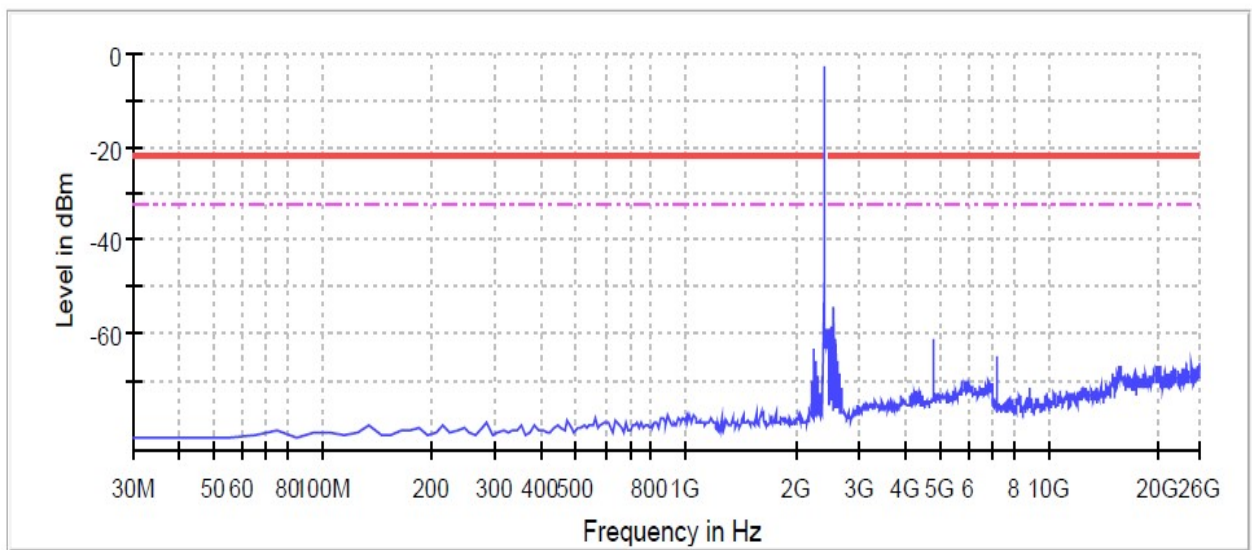

— Limit — Sum Level - - - Threshold × Critical × Final Critical

Radio Technology = Bluetooth EDR 3, Operating Frequency = mid
 (S01_ab01_BT_Headset)
 Spurious

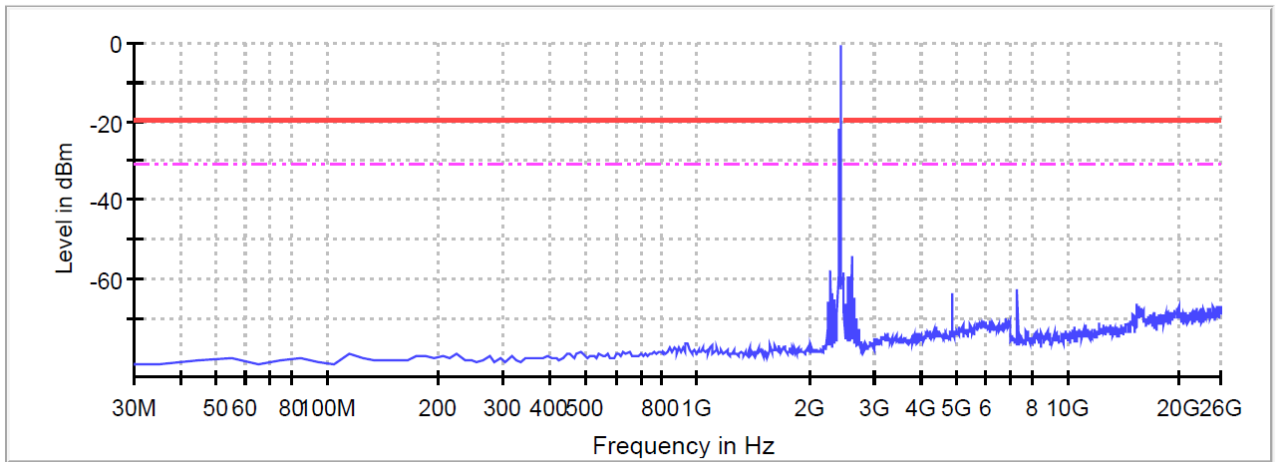

— Limit — Sum Level - - - Threshold × Critical × Final Critical

Radio Technology = Bluetooth EDR 3, Operating Frequency = high
 (S01_ab01_BT_Headset)
 Spurious

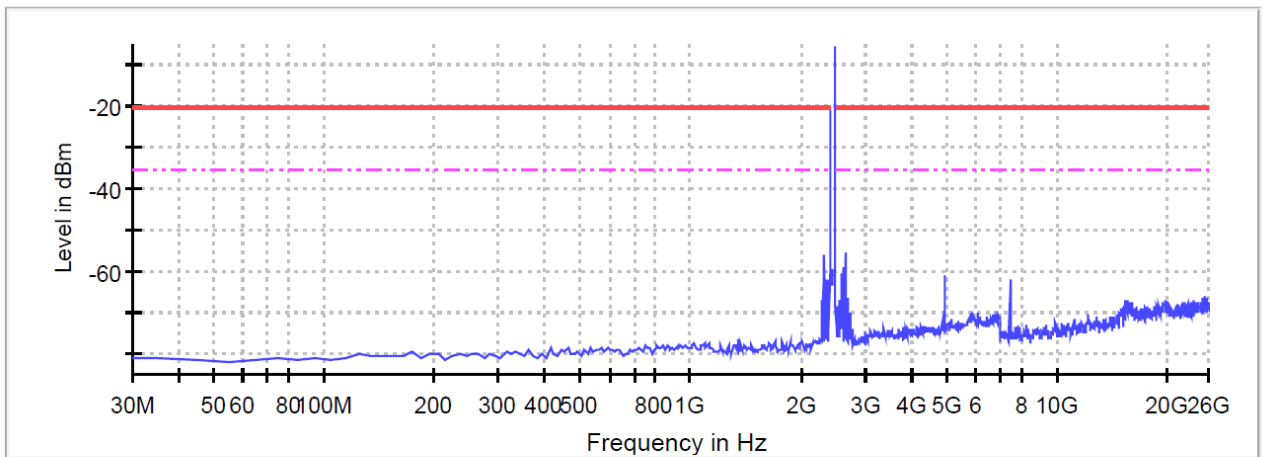

— Limit — Sum Level - - - Threshold × Critical × Final Critical

5.4.5 TEST EQUIPMENT USED

- R&S TS8997

5.5 TRANSMITTER SPURIOUS RADIATED EMISSIONS

Standard **FCC Part 15 Subpart C**

The test was performed according to:
ANSI C63.10

5.5.1 TEST DESCRIPTION

The test set-up was made in accordance to the general provisions of ANSI C63.10 in a typical installation configuration. The measurements were performed according the following sub-chapters of ANSI C63.10:

- < 30 MHz: Chapter 6.4
- 30 MHz – 1 GHz: Chapter 6.5
- > 1 GHz: Chapter 6.6 (procedure according 6.6.5 used)

The measurement procedure is implemented into the EMI test software EMC32 from R&S. Exploratory tests are performed at 3 orthogonal axes to determine the worst-case orientation of a body-worn or handheld EUT. The final test on all kind of EUTs is also performed at 3 axes. A pre-check is performed while the EUT is powered.

Below 1 GHz:

The Equipment Under Test (EUT) was set up on a non-conductive table in the semi-anechoic chamber. The influence of the EUT support table that is used between 30–1000 MHz was evaluated.

1. Measurement up to 30 MHz

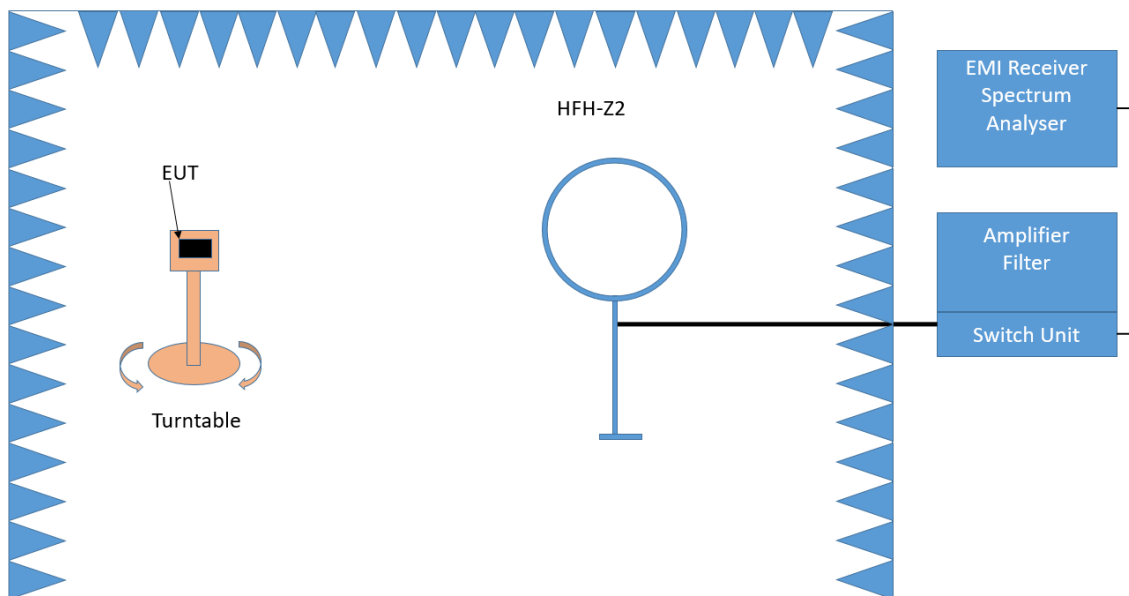

Test Setup; Spurious Emission Radiated (SAC), 9 kHz – 30 MHz

The Loop antenna HFH2-Z2 is used.

Step 1: pre-measurement

- Anechoic chamber
- Antenna distance: 3 m
- Antenna height: 1 m
- Detector: Peak-Maxhold
- Frequency range: 0.009 - 0.15 MHz and 0.15 – 30 MHz
- Frequency steps: 0.05 kHz and 2.25 kHz
- IF-Bandwidth: 0.2 kHz and 9 kHz
- Measuring time / Frequency step: 100 ms (FFT-based)

Intention of this step is, to determine the radiated EMI-profile of the EUT. Afterwards the relevant emissions for the final measurement are identified.

Step 2: final measurement

For the relevant emissions determined in step 1, an additional measurement with the following settings will be performed. Intention of this step is to find the maximum emission level.

- Detector: Quasi-Peak (9 kHz – 150 kHz, Peak / Average 150 kHz- 30 MHz)
- Frequency range: 0.009 – 30 MHz
- Frequency steps: measurement at frequencies detected in step 1
- IF-Bandwidth: 0.2 - 10 kHz
- Measuring time / Frequency step: 1 s

2. Measurement above 30 MHz and up to 1 GHz

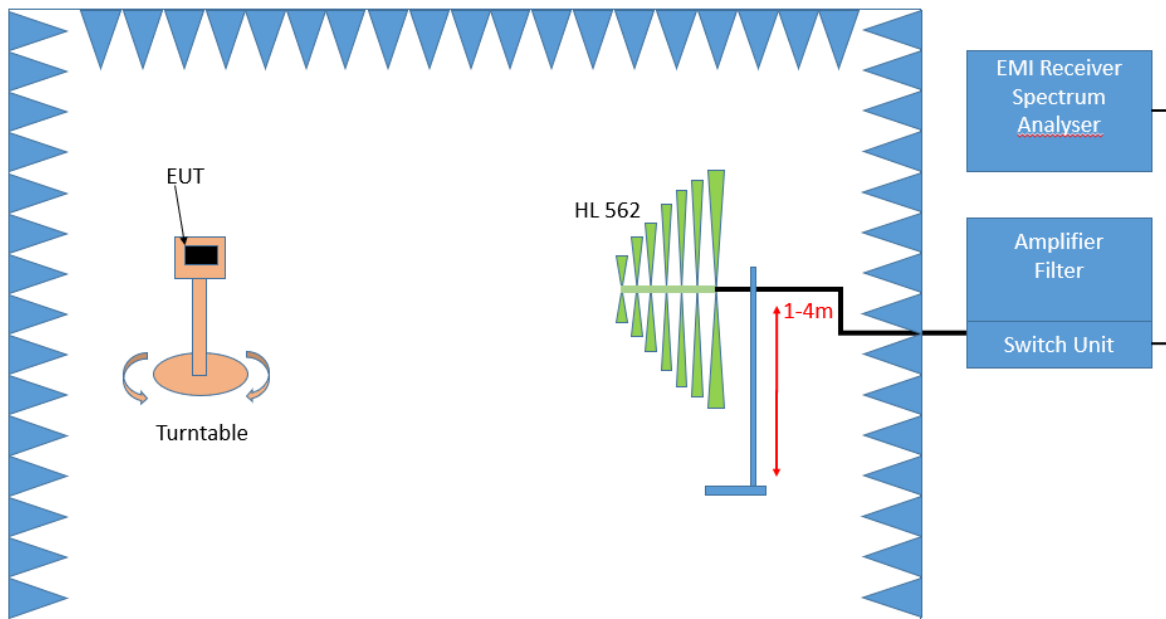

Test Setup; Spurious Emission Radiated (SAC), 30 MHz- 1GHz

Step 1: Preliminary scan

This is a preliminary test to identify the highest amplitudes relative to the limit.

Settings for step 1:

- Antenna distance: 3 m
- Detector: Peak-Maxhold / Quasipeak (FFT-based)
- Frequency range: 30 – 1000 MHz
- Frequency steps: 30 kHz
- IF-Bandwidth: 120 kHz
- Measuring time / Frequency step: 100 ms
- Turntable angle range: -180° to 90°
- Turntable step size: 90°
- Height variation range: 1 – 4 m
- Height variation step size: 1.5 m
- Polarisation: Horizontal + Vertical

Intention of this step is, to determine the radiated EMI-profile of the EUT. Afterwards the relevant emissions for the final measurement are identified.

Step 2: Adjustment measurement

In this step the accuracy of the turntable azimuth and antenna height will be improved. This is necessary to find out the maximum value of every frequency.

For each frequency, which was determined the turntable azimuth and antenna height will be adjusted. The turntable azimuth will slowly vary by $\pm 45^{\circ}$ around this value. During this action, the value of emission is continuously measured. The turntable azimuth at the highest emission will be recorded and adjusted. In this position, the antenna height will also slowly vary by ± 100 cm around the antenna height determined. During this action, the value of emission is also continuously measured. The antenna height of the highest emission will also be recorded and adjusted.

- Detector: Peak – Maxhold
- Measured frequencies: in step 1 determined frequencies
- IF – Bandwidth: 120 kHz
- Measuring time: 100 ms
- Turntable angle range: 360°
- Height variation range: 1 – 4 m
- Antenna Polarisation: max. value determined in step 1

Step 3: Final measurement with QP detector

With the settings determined in step 2, the final measurement will be performed:

EMI receiver settings for step 3:

- Detector: Quasi-Peak (< 1 GHz)
- Measured frequencies: in step 1 determined frequencies
- IF – Bandwidth: 120 kHz
- Measuring time: 1 s

After the measurement a plot will be generated which contains a diagram with the results of the preliminary scan and a chart with the frequencies and values of the results of the final measurement.

Above 1 GHz:

The Equipment Under Test (EUT) was set up on a non-conductive support (tilt device) at 1.5 m height in the fully-anechoic chamber. All steps were performed with one height (1.5 m) of the receiving antenna only.

3. Measurement above 1 GHz

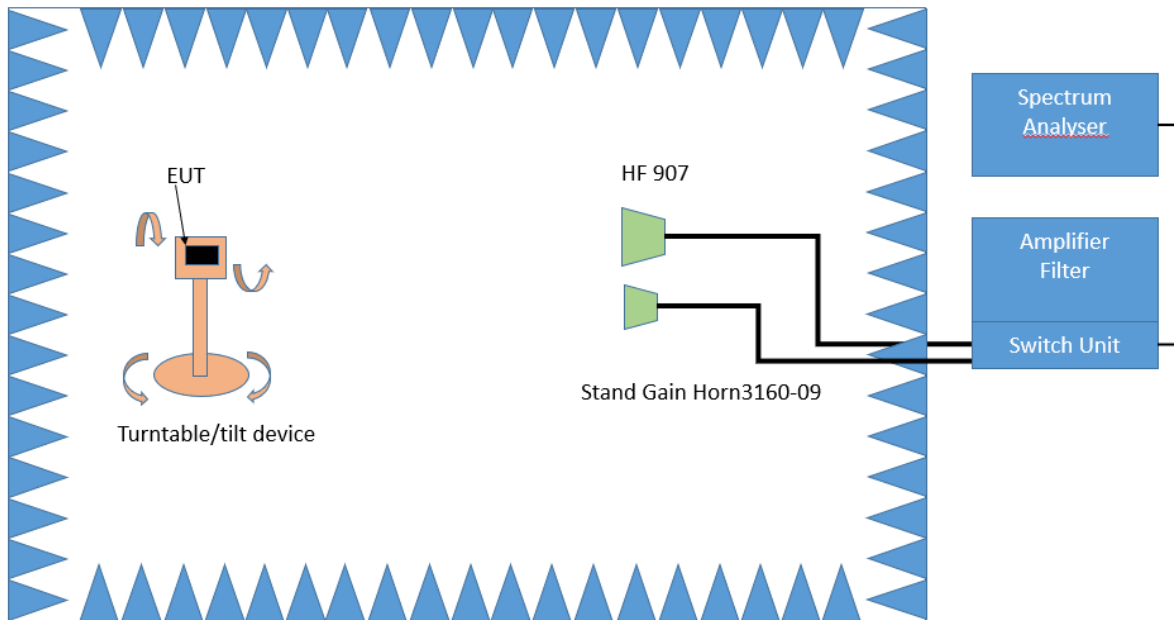

Test Setup; Spurious Emission Radiated (FAC), 1 GHz-26.5 GHz

Step 1:

The EUT is turned during the preliminary measurement across the elevation axis, with a step size of 90 °.

The turn table step size (azimuth angle) for the preliminary measurement is 45 °.

Spectrum analyser settings:

- Detector: Peak, Average
- RBW = 1 MHz
- VBW = 3 MHz

Step 2:

The turn table azimuth will slowly vary by $\pm 22.5^\circ$.

The elevation angle will slowly vary by $\pm 45^\circ$

Spectrum analyser settings:

- Detector: Peak

Step 3:

Spectrum analyser settings for step 3:

- Detector: Peak / CISPR Average
- Measured frequencies: in step 1 determined frequencies
- RBW = 1 MHz
- VBW = 3 MHz
- Measuring time: 1 s

5.5.2 TEST REQUIREMENTS / LIMITS

FCC Part 15, Subpart C, §15.247 (d)

... In addition, radiated emissions which fall in the restricted bands, as defined in Section 15.205(a), must also comply with the radiated emission limits specified in Section 15.209(a) (see Section 15.205(c)).

FCC Part 15, Subpart C, §15.209, Radiated Emission Limits

Frequency in MHz	Limit ($\mu\text{V}/\text{m}$)	Measurement distance (m)	Limits ($\text{dB}\mu\text{V}/\text{m}$)
0.009 – 0.49	2400/F(kHz)@300m	3	(48.5 – 13.8)@300m
0.49 – 1.705	24000/F(kHz)@30m	3	(33.8 – 23.0)@30m
1.705 – 30	30@30m	3	29.5@30m

The measured values are corrected with an inverse linear distance extrapolation factor (40 dB/decade) according FCC 15.31 (2).

Frequency in MHz	Limit ($\mu\text{V}/\text{m}$)	Measurement distance (m)	Limits ($\text{dB}\mu\text{V}/\text{m}$)
30 – 88	100@3m	3	40.0@3m
88 – 216	150@3m	3	43.5@3m
216 – 960	200@3m	3	46.0@3m
960 - 26000	500@3m	3	54.0@3m
26000 - 40000	500@3m	1	54.0@3m

The measured values above 26 GHz are corrected with an inverse linear distance extrapolation factor (20 dB/decade).

§15.35(b) ..., there is also a limit on the radio frequency emissions, as measured using instrumentation with a peak detector function, corresponding to 20 dB above the maximum permitted average limit....

Used conversion factor: $\text{Limit (dB}\mu\text{V}/\text{m)} = 20 \log (\text{Limit } (\mu\text{V}/\text{m})/1\mu\text{V}/\text{m})$

5.5.3 TEST PROTOCOL

Ambient temperature: 27–29 °C
 Air Pressure: 1008–1010 hPa
 Humidity: 33–39 %

BT GFSK (1-DH1)

Applied duty cycle correction (AV): 0.0 dB

Ch. No.	Ch. Center Freq. [MHz]	Spurious Freq. [MHz]	Spurious Level [dB μ V/m]	Detector	RBW [kHz]	Limit [dB μ V/m]	Margin to Limit [dB]	Limit Type
39	2441	137.8	25.0	QP	120	43.5	18.5	RB
39	2441	248.9	31.4	QP	120	46.0	14.6	RB
39	2441	993.0	32.2	QP	120	54.0	21.8	RB
78	2480	137.8	23.0	QP	120	43.5	20.5	RB
78	2480	240.4	40.2	QP	120	46.0	5.8	RB
78	2480	246.8	36.0	QP	120	46.0	10.1	RB
78	2480	2774.8	63.3	PEAK	1000	74.0	10.7	RB
78	2480	17815.4	45.2	AV	1000	54.0	8.8	RB
0	2402	137.8	30.6	QP	120	43.5	12.9	RB
0	2402	156.7	21.7	QP	120	43.5	21.8	RB
0	2402	240.5	34.0	QP	120	46.0	12.0	RB
0	2402	1701.9	62.3	PEAK	1000	74.0	11.7	RB
0	2402	17829.3	45.4	AV	1000	54.0	8.6	RB
39	2441	1720.8	60.4	PEAK	1000	74.0	13.6	RB
39	2441	17801.7	44.8	AV	1000	54.0	9.2	RB

BT $\pi/4$ DQPSK (2-DH1)

Applied duty cycle correction (AV): 0.0 dB

Ch. No.	Ch. Center Freq. [MHz]	Spurious Freq. [MHz]	Spurious Level [dB μ V/m]	Detector	RBW [kHz]	Limit [dB μ V/m]	Margin to Limit [dB]	Limit Type
0	2402	1719.8	60.7	PEAK	1000	74.0	13.3	RB
0	2402	2695.7	61.3	PEAK	1000	74.0	12.7	RB
39	2441	1708.9	62.1	PEAK	1000	74.0	11.9	RB
39	2441	1719.7	61.2	PEAK	1000	74.0	12.8	RB
39	2441	2712.9	59.2	PEAK	1000	74.0	14.8	RB
39	2441	2712.9	37.6	AV	1000	54.0	16.4	RB
78	2480	1700.3	61.7	PEAK	1000	74.0	12.3	RB
78	2480	1721.9	59.9	PEAK	1000	74.0	14.1	RB
78	2480	2488.1	36.3	AV	1000	54.0	17.7	RB

BT 8-DPSK (3-DH1)

Applied duty cycle correction (AV): 0.0 dB

Ch. No.	Ch. Center Freq. [MHz]	Spurious Freq. [MHz]	Spurious Level [dB μ V/m]	Detector	RBW [kHz]	Limit [dB μ V/m]	Margin to Limit [dB]	Limit Type
78	2480	1699.8	62.4	PEAK	1000	74.0	11.6	RB
78	2480	1703.0	34.8	AV	1000	54.0	19.2	RB
78	2480	1719.0	60.1	PEAK	1000	74.0	13.9	RB
78	2480	1720.1	37.9	AV	1000	54.0	16.1	RB
78	2480	2707.4	58.8	PEAK	1000	74.0	15.2	RB
78	2480	2707.9	37.5	AV	1000	54.0	16.5	RB
78	2480	2725.9	37.0	AV	1000	54.0	17.0	RB
78	2480	2725.9	59.3	PEAK	1000	74.0	14.7	RB
78	2480	2761.6	37.7	AV	1000	54.0	16.3	RB
78	2480	2761.6	59.6	PEAK	1000	74.0	14.4	RB

Remark: Please see next sub-clause for the measurement plot.

5.5.4 MEASUREMENT PLOT (EXAMPLE PLOT, SHOWING WORST CASE, IF APPLICABLE)

Radio Technology = Bluetooth BDR, Operating Frequency = mid,
Measurement range = 9 kHz - 30 MHz
(S01_aa01_BT_Headset)

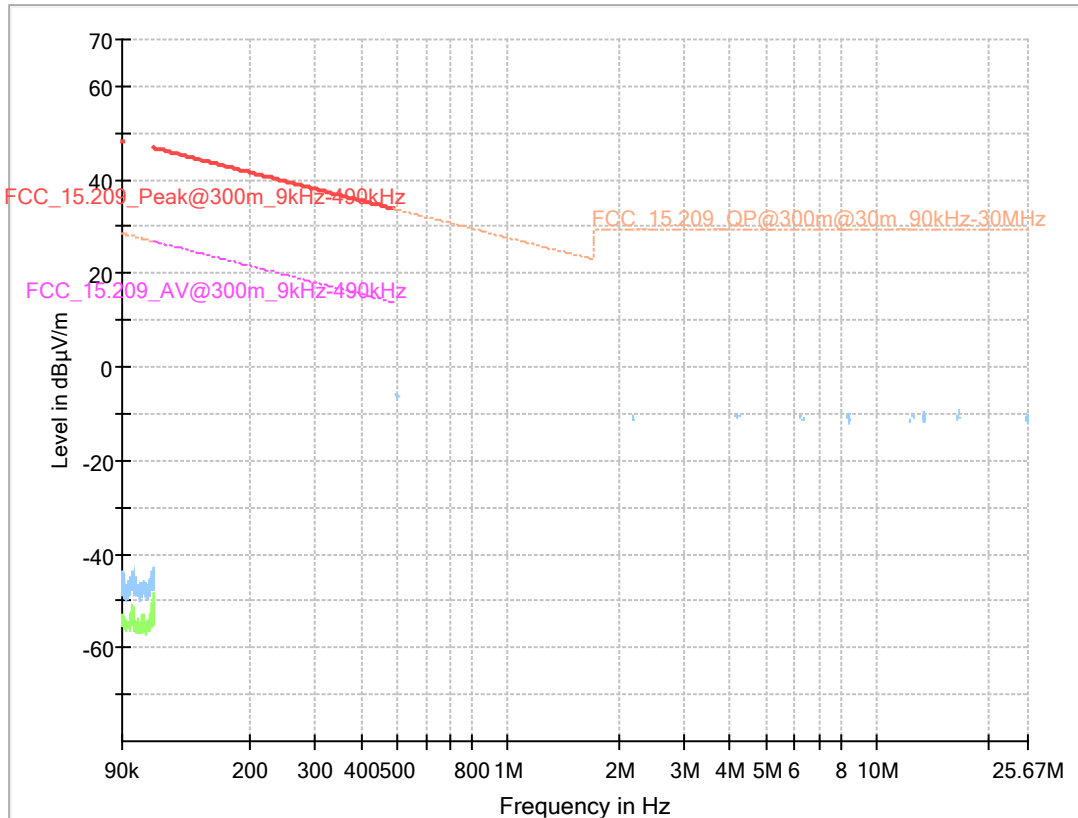

Legend: Trace: blue = Peak, green = AV, Star = critical frequency, Rhombus: blue = final QP

Radio Technology = Bluetooth BDR, Operating Frequency = high,
 Measurement range = 30 MHz - 1 GHz
 (S01_aa01_BT_Headset)

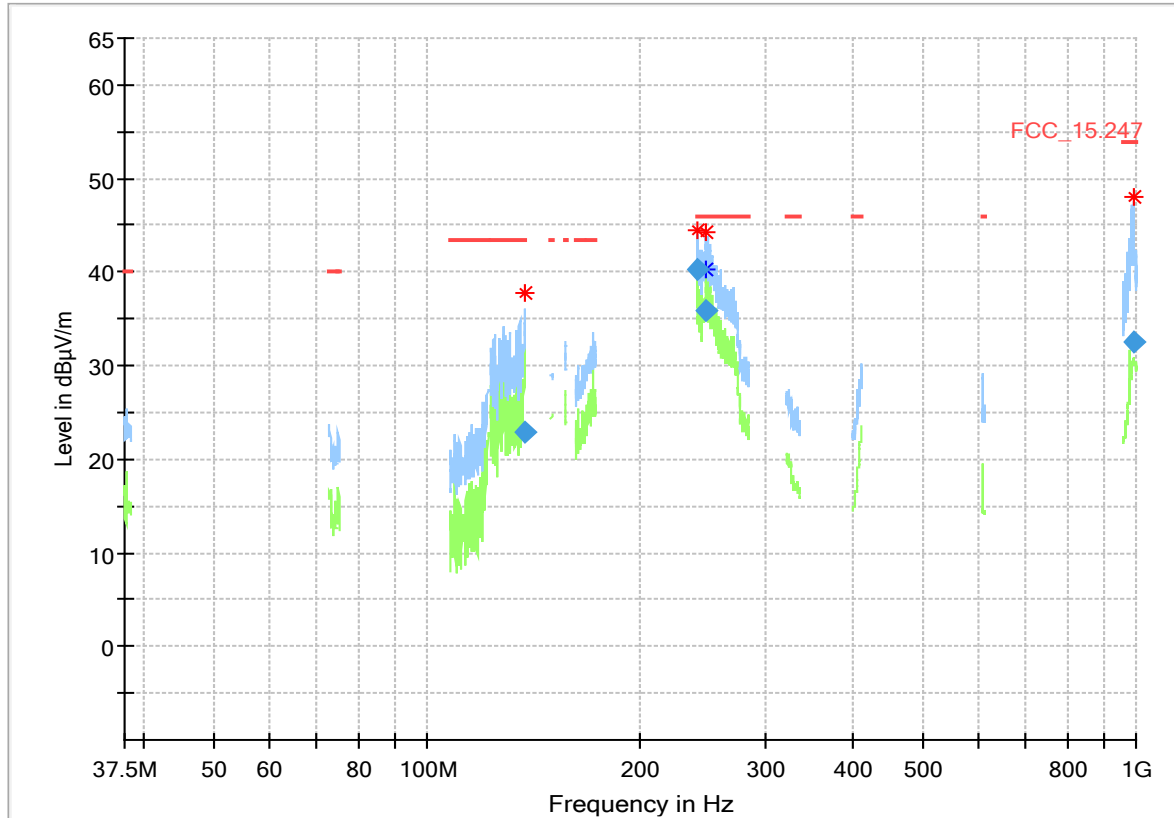

Legend: Trace: blue = peak, green = QP, Star = critical frequency, Rhombus: blue = final QP

Final Result

Frequency (MHz)	QuasiPeak (dBµV/m)	Limit (dBµV/m)	Margin (dB)	Meas. Time (ms)	Bandwidth (kHz)	Height (cm)	Pol	Azimuth (deg)	Corr. (dB/m)	Comment
137.820000	22.99	43.50	20.51	1000.0	120.000	106.0	V	-17.0	10.0	
240.420000	40.23	46.00	5.77	1000.0	120.000	107.0	V	26.0	11.0	
246.750000	35.96	46.00	10.04	1000.0	120.000	108.0	V	35.0	11.2	
992.850000	32.45	54.00	21.55	1000.0	120.000	115.0	V	-80.0	25.2	

Radio Technology = Bluetooth BDR, Operating Frequency = low,
Measurement range = 1 GHz - 26 GHz
(S01_aa01_BT_Headset)

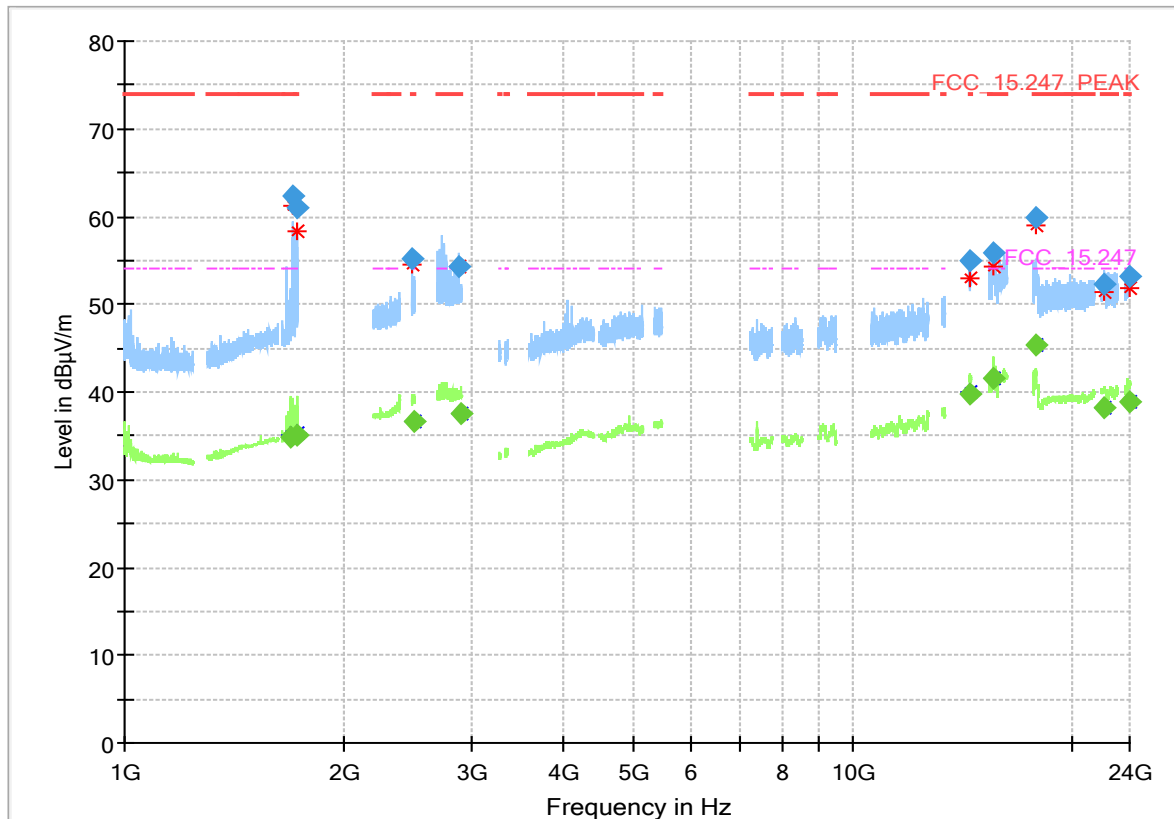

Legend: Trace: blue = Peak, green = AV, Star = critical frequency, Rhombus: blue = final Peak, green = final AV

Final Result

Frequency (MHz)	MaxPeak (dBµV/m)	CAverage (dBµV/m)	Limit (dBµV/m)	Margin (dB)	Meas. Time (ms)	Bandwidth (kHz)	Height (cm)	Pol	Azimuth (deg)	Elevation (deg)	Corr. (dB/m)
1694.625	---	35.0	54.00	19.05	1000.0	1000.000	150.0	H	-178.0	105.0	1.7
1701.875	62.3	---	74.00	11.67	1000.0	1000.000	150.0	H	-169.0	105.0	1.7
1720.058	61.1	---	74.00	12.90	1000.0	1000.000	150.0	H	-161.0	99.0	1.9
1721.248	---	35.2	54.00	18.82	1000.0	1000.000	150.0	H	-182.0	104.0	1.9
2489.605	55.2	---	74.00	18.81	1000.0	1000.000	150.0	H	-154.0	81.0	5.4
2498.350	---	36.6	54.00	17.41	1000.0	1000.000	150.0	V	-148.0	5.0	5.5
2885.090	54.4	---	74.00	19.61	1000.0	1000.000	150.0	V	-185.0	97.0	6.3
2891.180	---	37.5	54.00	16.54	1000.0	1000.000	150.0	V	156.0	87.0	6.4
14496.550	54.9	---	74.00	19.09	1000.0	1000.000	150.0	H	-157.0	78.0	-3.5
14497.600	---	39.7	54.00	14.30	1000.0	1000.000	150.0	V	-68.0	-15.0	-3.5
15595.083	56.0	---	74.00	18.03	1000.0	1000.000	150.0	H	24.0	75.0	-1.4
15605.850	---	41.5	54.00	12.50	1000.0	1000.000	150.0	V	-150.0	15.0	-1.5
17829.300	---	45.4	54.00	8.61	1000.0	1000.000	150.0	V	98.0	13.0	1.4
17838.600	59.9	---	74.00	14.11	1000.0	1000.000	150.0	H	161.0	102.0	1.0
22096.136	---	38.3	54.00	15.72	1000.0	1000.000	150.0	H	-49.0	105.0	19.0
22100.132	52.4	---	74.00	21.60	1000.0	1000.000	150.0	V	96.0	97.0	19.0
23952.667	---	38.9	54.00	15.13	1000.0	1000.000	150.0	H	152.0	95.0	20.1
23953.200	53.1	---	74.00	20.90	1000.0	1000.000	150.0	H	-51.0	81.0	20.1

5.5.5 TEST EQUIPMENT USED

- Radiated Emissions

5.6 BAND EDGE COMPLIANCE CONDUCTED

Standard **FCC Part 15 Subpart C**

The test was performed according to:
ANSI C63.10

5.6.1 TEST DESCRIPTION

For the conducted measurement, the Equipment Under Test (EUT) is placed in a shielded room. The reference power was measured in the test case "Spurious RF Conducted Emissions".

The EUT was connected to the test system as described in the block diagram below. The complete attenuation of the measurement path is known and considered.

Analyser settings:

- Lower Band Edge:
Measured range: 2310.0 MHz to 2483.5 MHz
Upper Band Edge
Measured range: 2400.0 MHz to 2500 MHz
- Detector: Peak
- Resolution Bandwidth (RBW): 100 kHz
- Video Bandwidth (VBW): 300 kHz
- Sweep time: Auto
- Sweeps: Till stable (min. 300, max. 15000)
- Trace: Maxhold

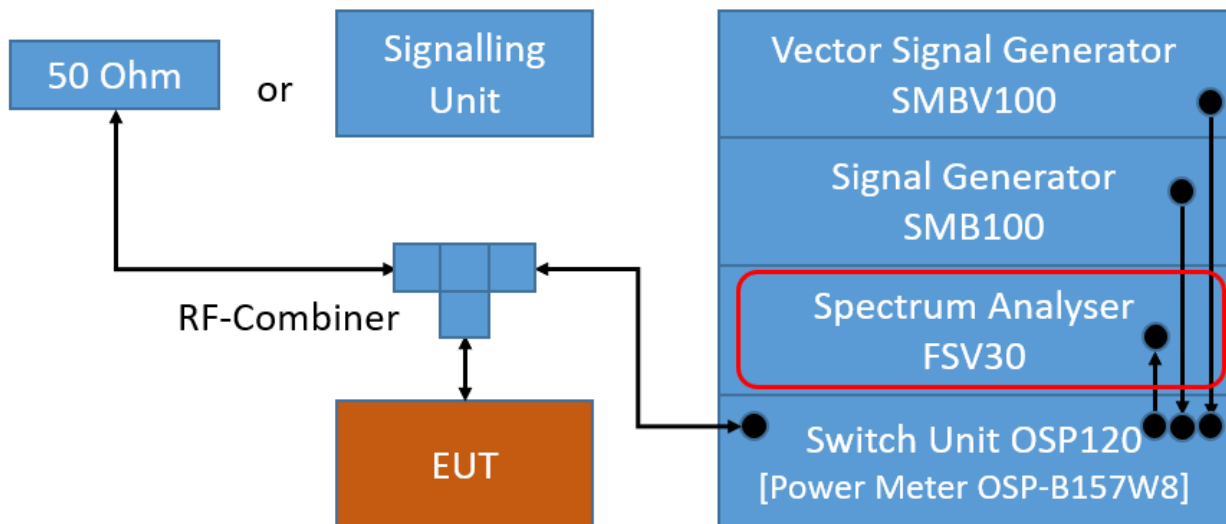

TS8997; Band Edge Conducted

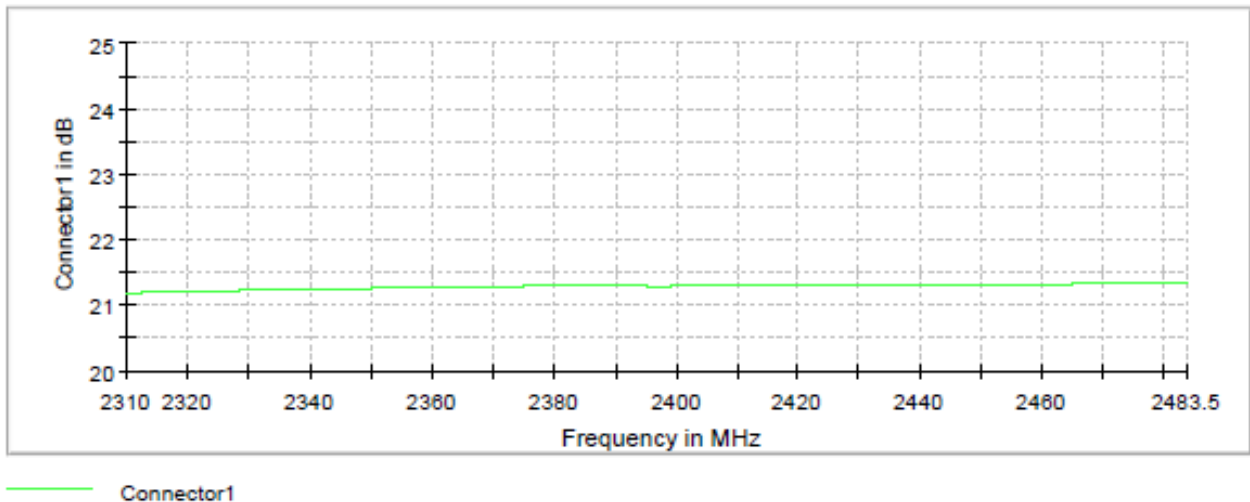

Attenuation of the measurement path

5.6.2 TEST REQUIREMENTS / LIMITS

FCC Part 15.247 (d)

"In any 100 kHz bandwidth outside the frequency band in which the spread spectrum or digitally modulated intentional radiator is operating, the radio frequency power that is produced by the intentional radiator shall be at least 20 dB below that in the 100 kHz bandwidth within the band that contains the highest level of the desired power, based on either an RF conducted or a radiated measurement, provided the transmitter demonstrates compliance with the peak conducted power limits. ...

If the transmitter complies with the conducted power limits based on the use of RMS averaging over a time interval, as permitted under paragraph (b)(3) of this section, the attenuation required under this paragraph shall be 30 dB instead of 20 dB. Attenuation below the general limits specified in Section 15.209(a) is not required. In addition, radiated emissions which fall in the restricted bands, as defined in Section 15.205(a), must also comply with the radiated emission limits specified in Section 15.209(a) (see Section 15.205(c))."

For the conducted measurement, the RF power at the band edge shall be "at least 20 dB below that in the 100 kHz bandwidth within the band that contains the highest level of the desired power..."

5.6.3 TEST PROTOCOL

Ambient temperature: 25 °C
 Air Pressure: 1009 hPa
 Humidity: 50 %
 BT GFSK (1-DH1)

Channel No.	Channel Center Frequency [MHz]	Band Edge Freq. [MHz]	Spurious Level [dBm]	Detector	RBW [kHz]	Ref. Level [dBm]	Limit [dBm]	Margin to Limit [dB]
0	2402	2400.0	-46.5	PEAK	100	0.8	-19.2	27.3
78	2480	2483.5	-55.1	PEAK	100	1.0	-19.0	36.1
hopping	hopping	2400.0	-47.5	PEAK	100	0.7	-19.3	28.2
hopping	hopping	2483.5	-55.3	PEAK	100	0.7	-19.3	36.0

BT n/4 DQPSK (2-DH1)

Channel No.	Channel Center Frequency [MHz]	Band Edge Freq. [MHz]	Spurious Level [dBm]	Detector	RBW [kHz]	Ref. Level [dBm]	Limit [dBm]	Margin to Limit [dB]
0	2402	2400.0	-45.1	PEAK	100	-2.1	-22.1	23.0
78	2480	2483.5	-55.0	PEAK	100	-0.4	-20.4	34.6
hopping	hopping	2400.0	-53.6	PEAK	100	-0.7	-20.7	32.9
hopping	hopping	2483.5	-55.6	PEAK	100	-0.7	-20.7	34.9

BT 8-DPSK (3-DH1)

Channel No.	Channel Center Frequency [MHz]	Band Edge Freq. [MHz]	Spurious Level [dBm]	Detector	RBW [kHz]	Ref. Level [dBm]	Limit [dBm]	Margin to Limit [dB]
0	2402	2400.0	-43.9	PEAK	100	-1.9	-21.9	22.0
78	2480	2483.5	-55.3	PEAK	100	-0.4	-20.4	34.9
hopping	hopping	2400.0	-44.0	PEAK	100	-0.6	-20.6	23.4
hopping	hopping	2483.5	-54.8	PEAK	100	-0.5	-20.5	34.3

Remark: Please see next sub-clause for the measurement plot.

5.6.4 MEASUREMENT PLOT (EXAMPLE PLOT, SHOWING WORST CASE, IF APPLICABLE)

Radio Technology = Bluetooth BDR, Operating Frequency = low, Band Edge = low (S01_ab01_BT_Headset)

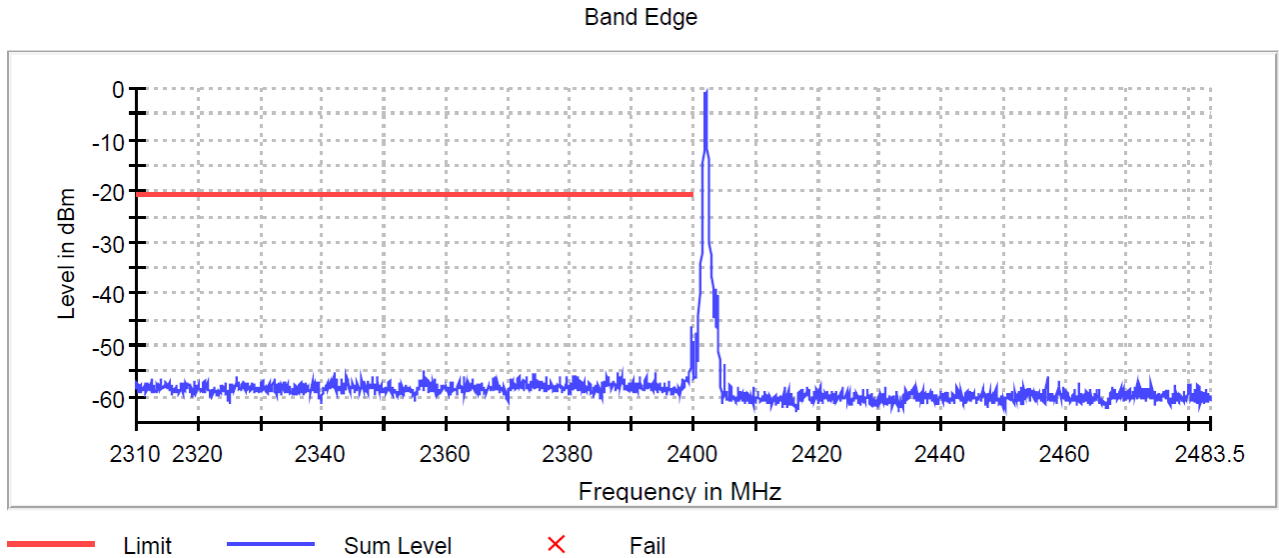

Radio Technology = Bluetooth BDR, Operating Frequency = high, Band Edge = high (S01_ab01_BT_Headset)

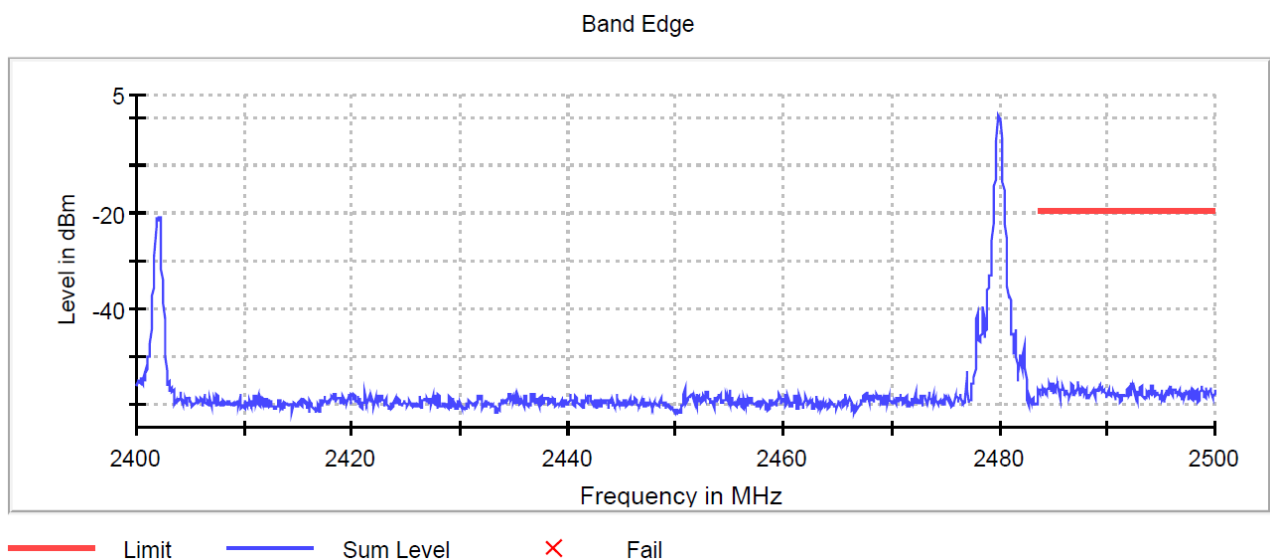

Radio Technology = Bluetooth BDR, Operating Frequency = hopping, Band Edge = low (S01_ab01_BT_Headset)

Band Edge

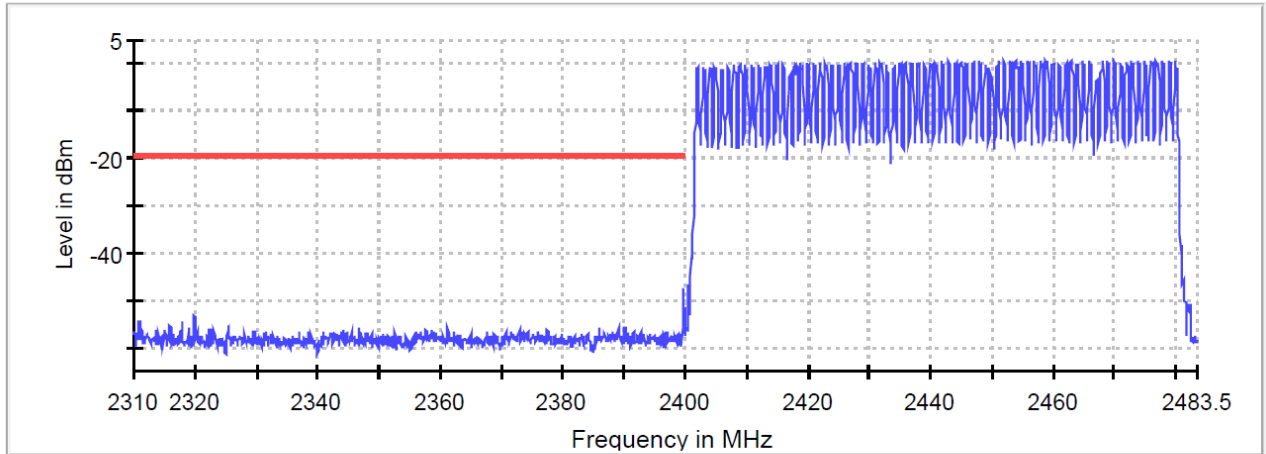

— Limit — Sum Level × Fail

Radio Technology = Bluetooth BDR, Operating Frequency = hopping, Band Edge = high (S01_ab01_BT_Headset)

Band Edge

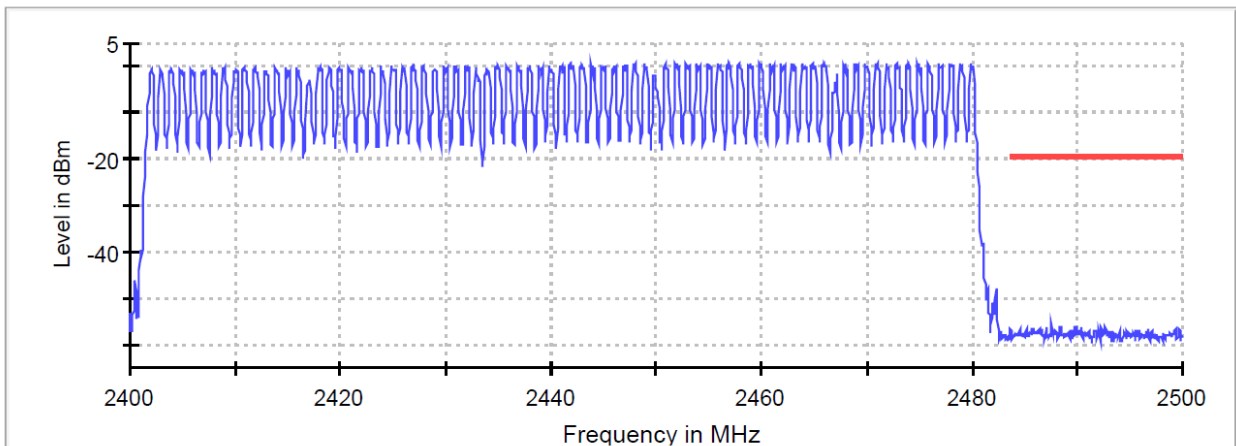

— Limit — Sum Level × Fail

Radio Technology = Bluetooth EDR 2, Operating Frequency = low, Band Edge = low
(S01_ab01_BT_Headset)

Band Edge

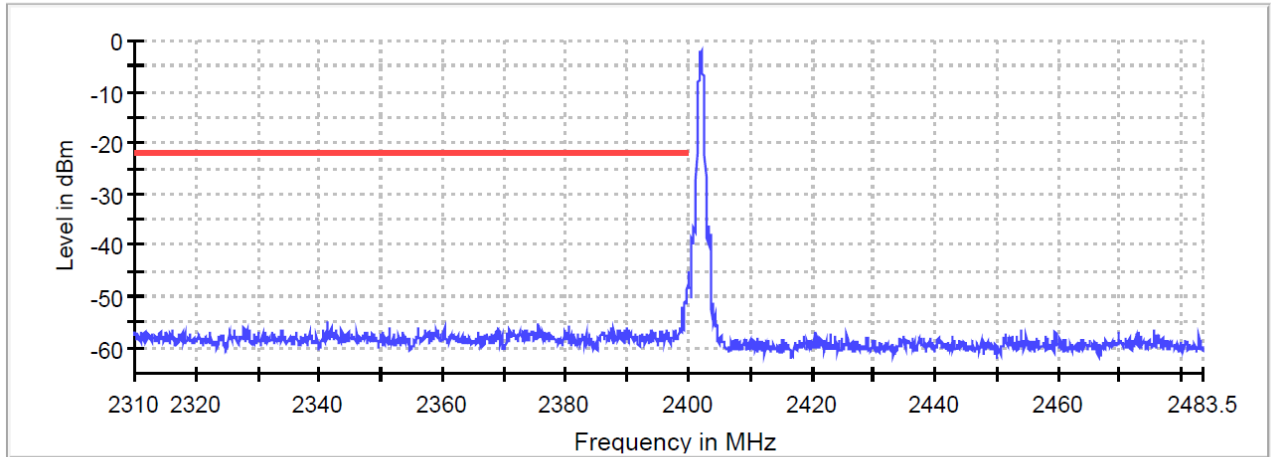

— Limit — Sum Level × Fail

Radio Technology = Bluetooth EDR 2, Operating Frequency = high, Band Edge = high
(S01_ab01_BT_Headset)

Band Edge

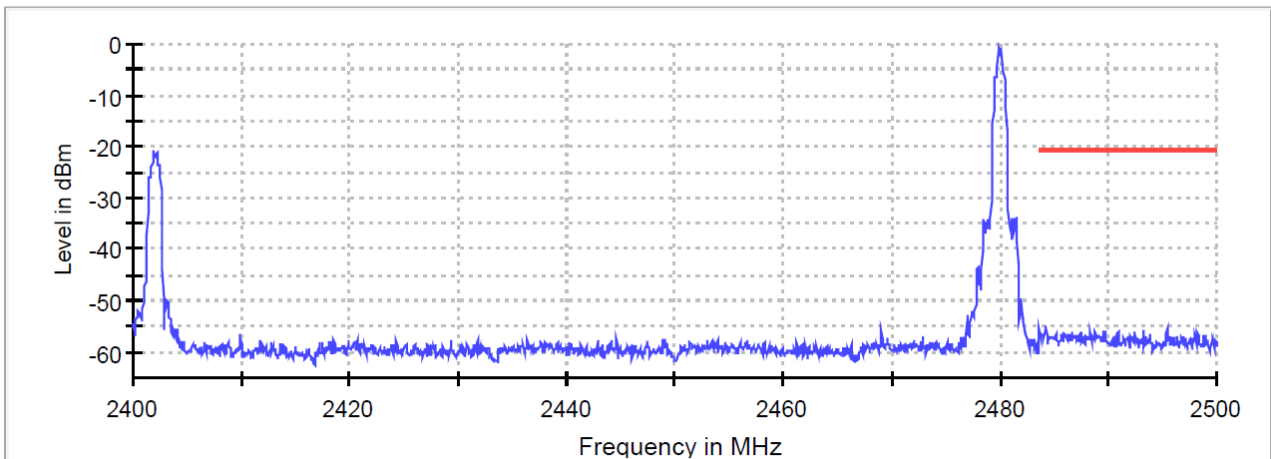

— Limit — Sum Level × Fail

Radio Technology = Bluetooth EDR 2, Operating Frequency = hopping, Band Edge = low (S01_ab01_BT_Headset)

Band Edge

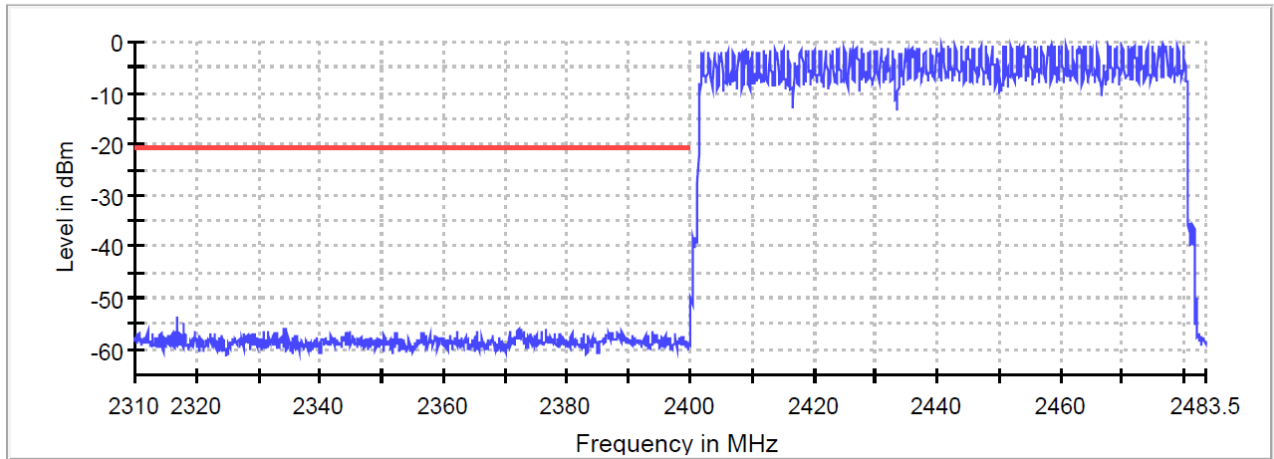

Radio Technology = Bluetooth EDR 2, Operating Frequency = hopping, Band Edge = high (S01_ab01_BT_Headset)

Band Edge

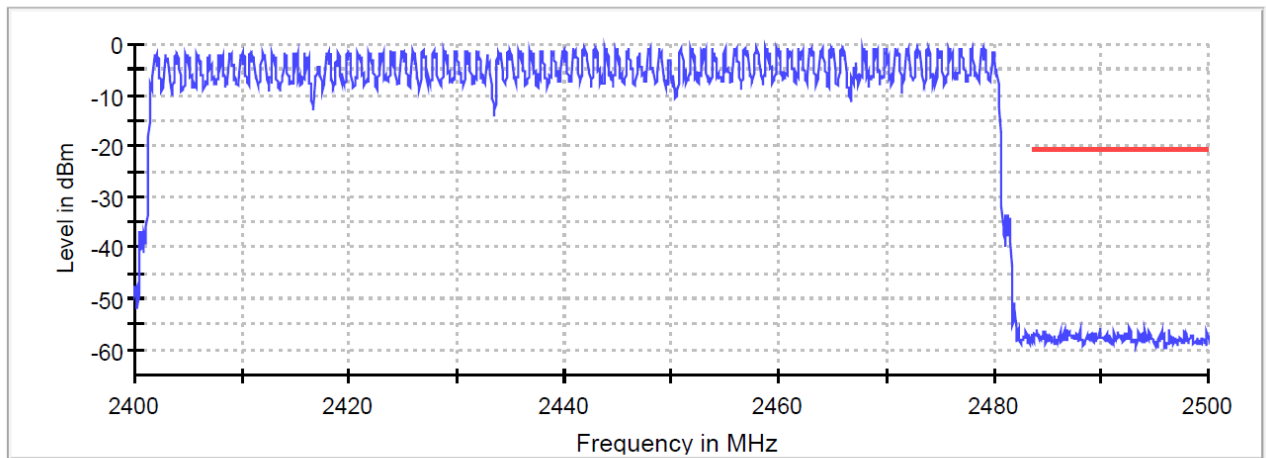

— Limit — Sum Level × Fail

Radio Technology = Bluetooth EDR 3, Operating Frequency = low, Band Edge = low
(S01_ab01_BT_Headset)
Band Edge

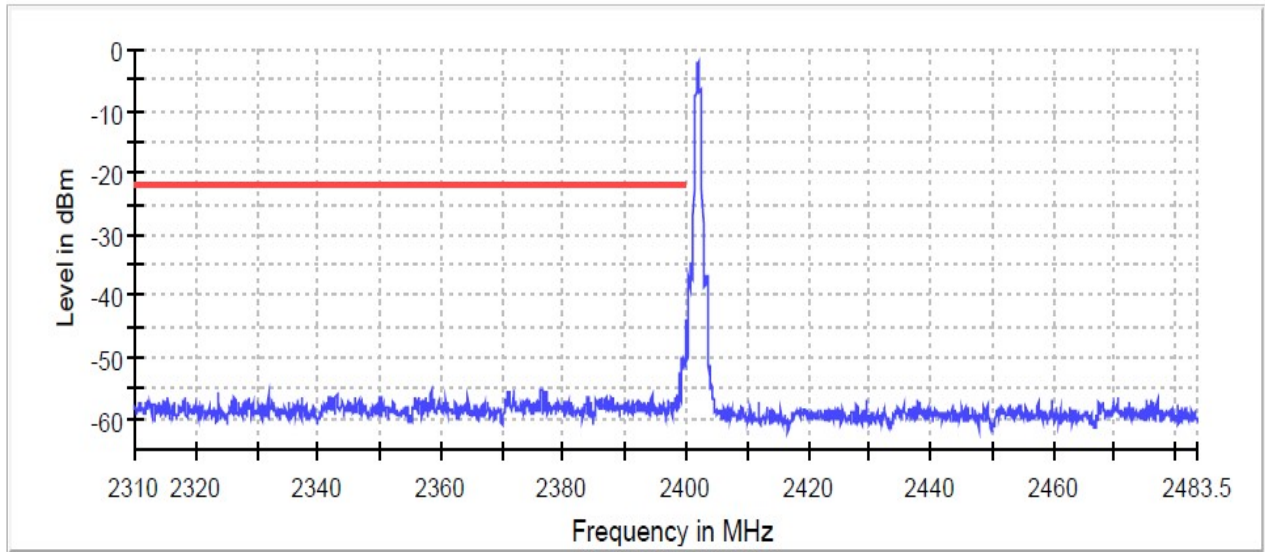

— Limit — Sum Level × Fail

Radio Technology = Bluetooth EDR 3, Operating Frequency = high, Band Edge = high
(S01_ab01_BT_Headset)

Band Edge

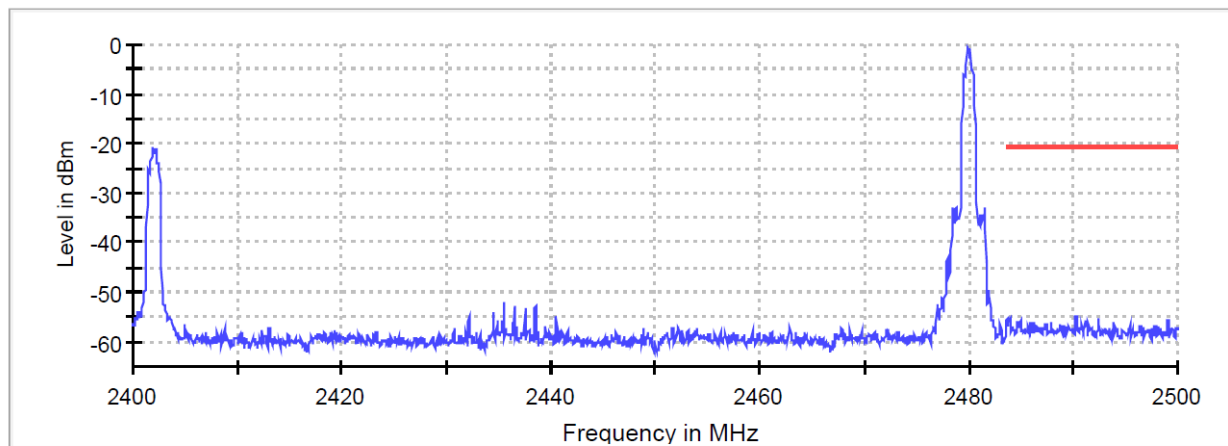

— Limit — Sum Level × Fail

Radio Technology = Bluetooth EDR 3, Operating Frequency = hopping, Band Edge = low (S01_ab01_BT_Headset)

Band Edge

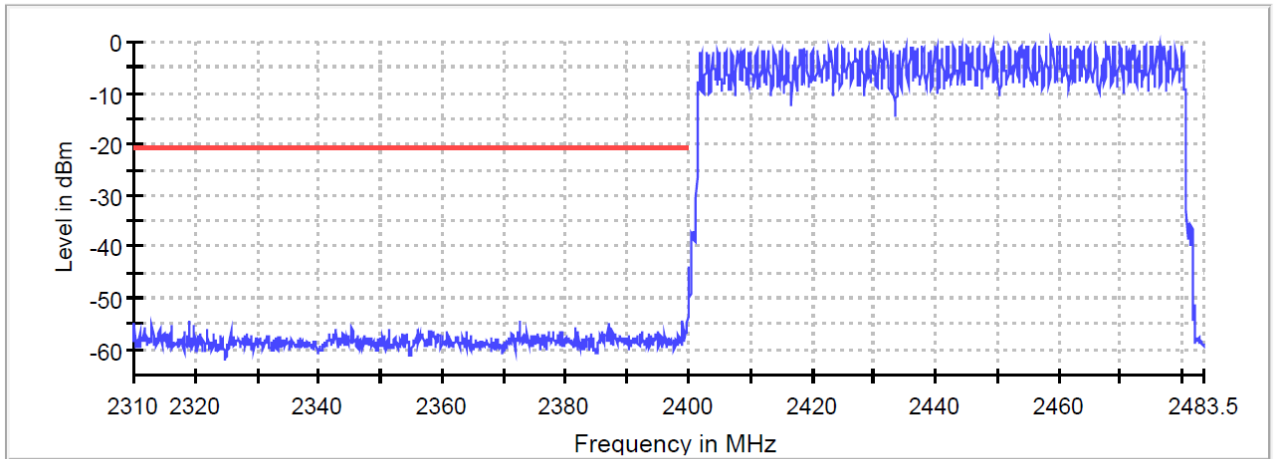

— Limit — Sum Level × Fail

Radio Technology = Bluetooth EDR 3, Operating Frequency = hopping, Band Edge = high (S01_ab01_BT_Headset)

Band Edge

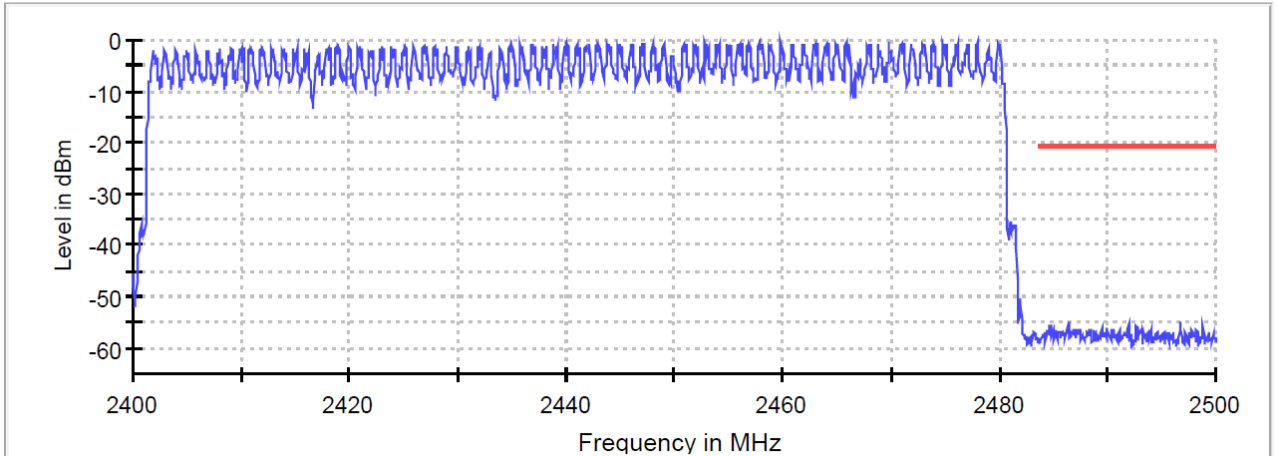

— Limit — Sum Level × Fail

5.6.5 TEST EQUIPMENT USED

- R&S TS8997

5.7 BAND EDGE COMPLIANCE RADIATED

Standard **FCC Part 15 Subpart C**

The test was performed according to:
ANSI C63.10

5.7.1 TEST DESCRIPTION

The test set-up was made in accordance to the general provisions of ANSI C63.10 in a typical installation configuration. The measurements were performed according the following sub-chapter of ANSI C63.10:

- Chapter 6.10.5

The Equipment Under Test (EUT) was set up on a non-conductive support (tilt device) at 1.5 m height in the fully anechoic chamber.

All steps were performed with one height (1.5 m) of the receiving antenna only (procedure according ANSI C63.10, chapter 6.6.5).

3. Measurement above 1 GHz

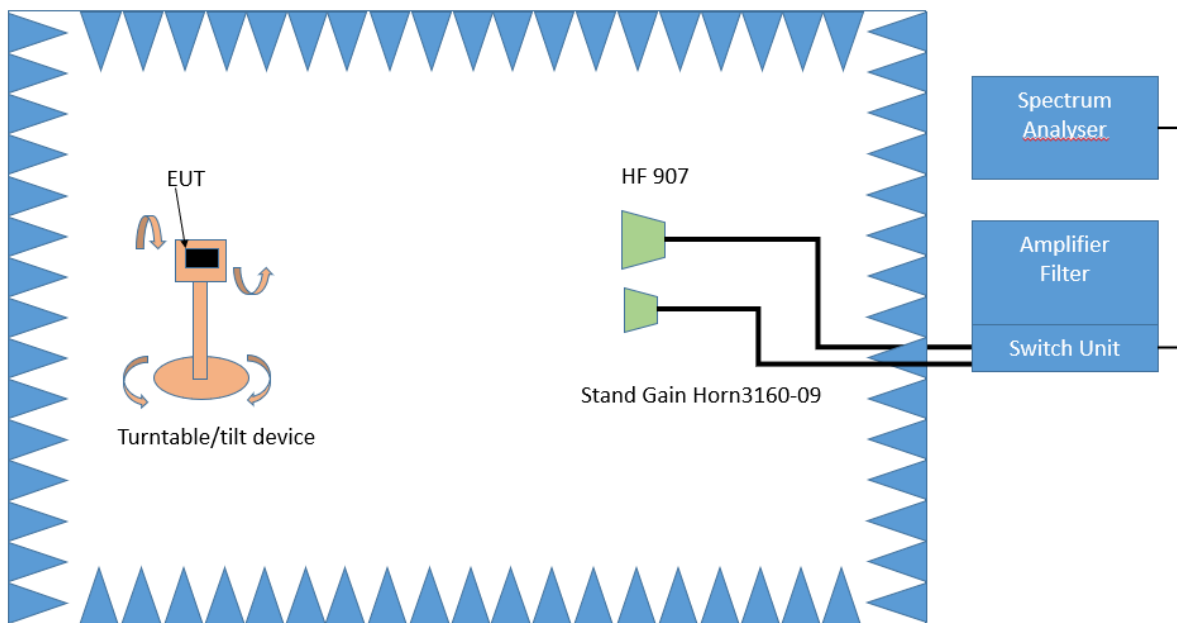

Test Setup; Spurious Emission Radiated (FAC), 1 GHz-26.5 GHz

Step 1:

The EUT is turned during the preliminary measurement across the elevation axis, with a step size of 90 °.

The turn table step size (azimuth angle) for the preliminary measurement is 45 °.

Spectrum analyser settings:

- Detector: Peak, Average
- RBW = 1 MHz
- VBW = 3 MHz

Step 2:

The turn table azimuth will slowly vary by $\pm 22.5^\circ$.

The elevation angle will slowly vary by $\pm 45^\circ$

Spectrum analyser settings:

- Detector: Peak

Step 3:

Spectrum analyser settings for step 3:

- Detector: Peak / CISPR Average
- Measured frequencies: in step 1 determined frequencies
- RBW = 1 MHz
- VBW = 3 MHz
- Measuring time: 1 s

5.7.2 TEST REQUIREMENTS / LIMITS

For band edges connected to a restricted band, the limits are specified in Section 15.209(a)

FCC Part 15, Subpart C, §15.209, Radiated Emission Limits

Frequency in MHz	Limit (µV/m)	Measurement distance (m)	Limits (dBµV/m)
0.009 – 0.49	2400/F(kHz)@300m	3	(48.5 – 13.8)@300m
0.49 – 1.705	24000/F(kHz)@30m	3	(33.8 – 23.0)@30m
1.705 – 30	30@30m	3	29.5@30m

The measured values are corrected with an inverse linear distance extrapolation factor (40 dB/decade) according FCC 15.31 (2).

Frequency in MHz	Limit (µV/m)	Measurement distance (m)	Limits (dBµV/m)
30 – 88	100@3m	3	40.0@3m
88 – 216	150@3m	3	43.5@3m
216 – 960	200@3m	3	46.0@3m
960 - 26000	500@3m	3	54.0@3m
26000 - 40000	500@3m	1	54.0@3m

The measured values above 26 GHz are corrected with an inverse linear distance extrapolation factor (20 dB/decade).

§15.35(b) ..., there is also a limit on the radio frequency emissions, as measured using instrumentation with a peak detector function, corresponding to 20 dB above the maximum permitted average limit....

Used conversion factor: $\text{Limit (dB}\mu\text{V/m)} = 20 \log (\text{Limit } (\mu\text{V/m})/1\mu\text{V/m})$

5.7.3 TEST PROTOCOL

Ambient temperature: 27 °C
 Air Pressure: 1010 hPa
 Humidity: 39 %
 BT GFSK (1-DH1)

Applied duty cycle correction (AV): 0.0 dB

Ch. No.	Ch. Center Freq. [MHz]	Band Edge Freq. [MHz]	Spurious Level [dB μ V/m]	Detector	RBW [kHz]	Limit [dB μ V/m]	Margin to Limit [dB]	Limit Type
78	2480	2483.5	51.3	PEAK	1000	74.0	22.7	BE
78	2480	2483.5	39.4	AV	1000	54.0	14.6	BE

BT $\pi/4$ DQPSK (2-DH1)

Applied duty cycle correction (AV): 0.0 dB

Ch. No.	Ch. Center Freq. [MHz]	Band Edge Freq. [MHz]	Spurious Level [dB μ V/m]	Detector	RBW [kHz]	Limit [dB μ V/m]	Margin to Limit [dB]	Limit Type
78	2480	2483.5	52.4	PEAK	1000	74.0	21.6	BE
78	2480	2483.5	39.5	AV	1000	54.0	14.5	BE

BT 8-DPSK (3-DH1)

Applied duty cycle correction (AV): 0.0 dB

Ch. No.	Ch. Center Freq. [MHz]	Band Edge Freq. [MHz]	Spurious Level [dB μ V/m]	Detector	RBW [kHz]	Limit [dB μ V/m]	Margin to Limit [dB]	Limit Type
78	2480	2483.5	54.5	PEAK	1000	74.0	19.5	BE
78	2480	2483.5	36.6	AV	1000	54.0	17.4	BE

Remark: Please see next sub-clause for the measurement plot.

5.7.4 MEASUREMENT PLOT (EXAMPLE PLOT, SHOWING WORST CASE, IF APPLICABLE)

Radio Technology = Bluetooth BDR, Operating Frequency = high, Band Edge = high (S01_aa01_BT_Headset)

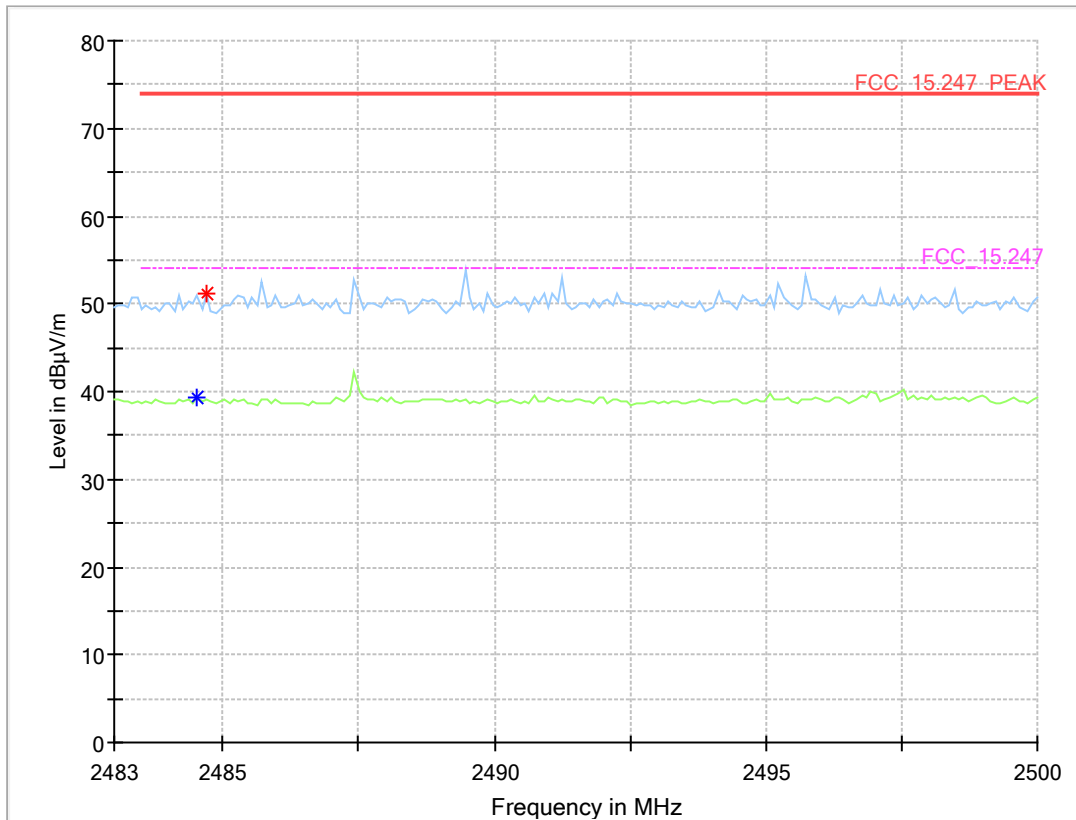

Legend: Trace: blue = Peak, green = AV, Star = critical frequency, Rhombus: blue = final Peak, green = final AV

Final_Result

Frequency (MHz)	MaxPeak (dBµV/m)	CAverage (dBµV/m)	Limit (dBµV/m)	Margin (dB)	Meas. Time (ms)	Bandwidth (kHz)	Height (cm)	Pol	Azimuth (deg)	Elevation (deg)	Corr. (dB/m)
2484.530	---	39.4	54.00	14.63	1000.0	1000.000	150.0	H	150.0	90.0	5.3
2484.700	51.3	---	74.00	22.72	1000.0	1000.000	150.0	V	30.0	0.0	5.3

Radio Technology = Bluetooth EDR 2, Operating Frequency = high, Band Edge = high (S01_aa01_BT_Headset)

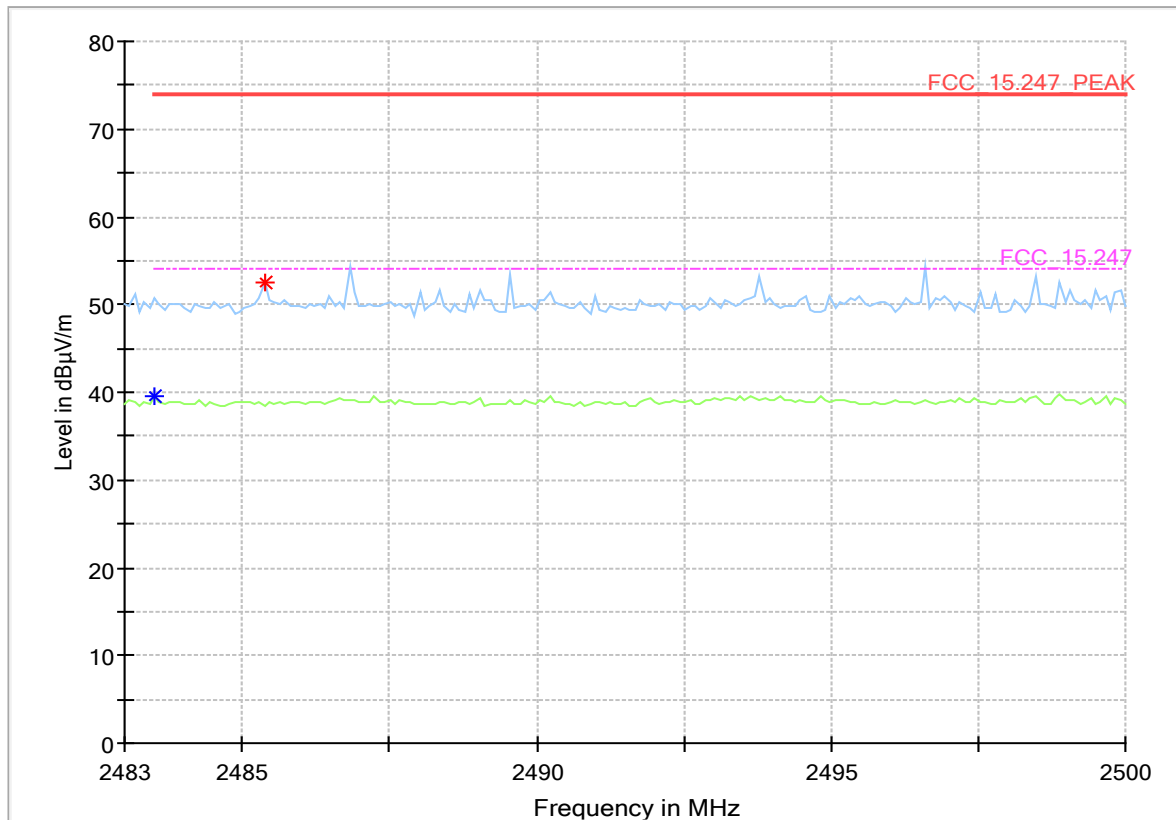

Legend: Trace: blue = Peak, green = AV, Star = critical frequency, Rhombus: blue = final Peak, green = final AV

Final_Result

Frequency (MHz)	MaxPeak (dBµV/m)	CAverage (dBµV/m)	Limit (dBµV/m)	Margin (dB)	Meas. Time (ms)	Bandwidth (kHz)	Height (cm)	Pol	Azimuth (deg)	Elevation (deg)	Corr. (dB/m)
2483.510	---	39.5	54.00	14.55	1000.0	1000.000	150.0	H	-154.0	81.0	5.3
2485.380	52.4	---	74.00	21.58	1000.0	1000.000	150.0	V	-148.0	5.0	5.3

Radio Technology = Bluetooth EDR 3, Operating Frequency = high, Band Edge = high (S01_aa01_BT_Headset)

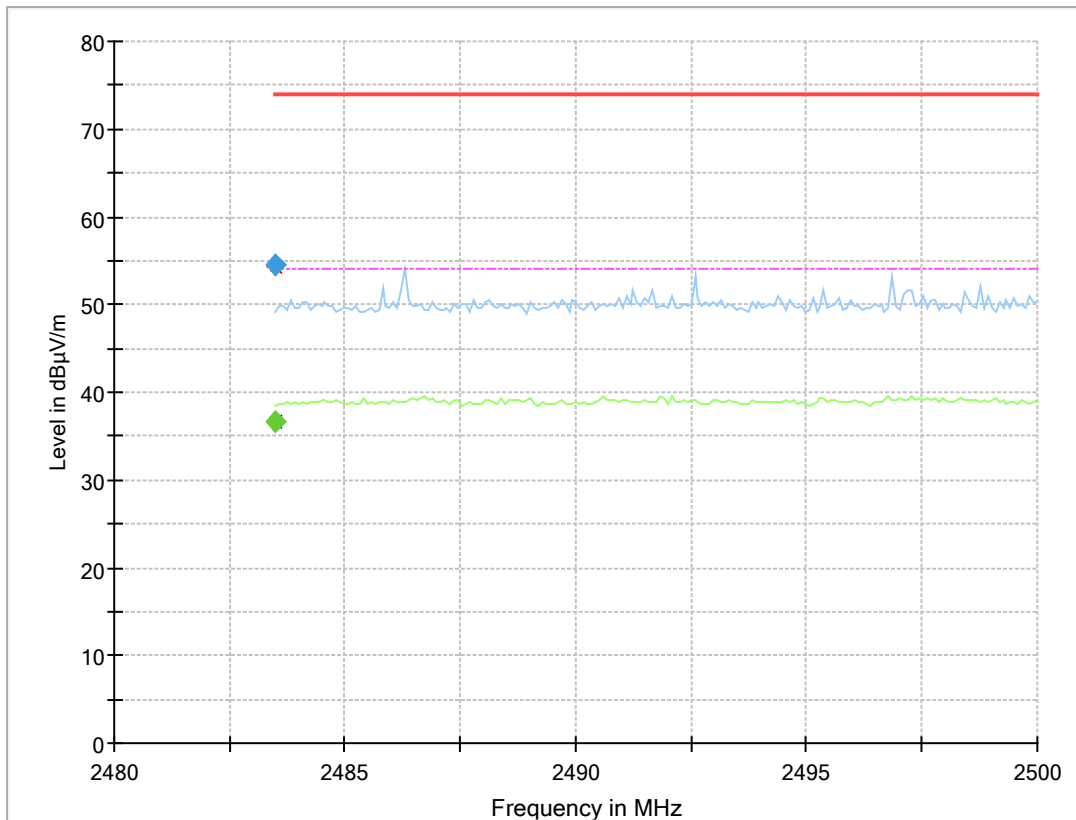

Legend: Trace: blue = Peak, green = AV, Star = critical frequency, Rhombus: blue = final Peak, green = final AV

Final_Result

Frequency (MHz)	MaxPeak (dBµV/m)	CAverage (dBµV/m)	Limit (dBµV/m)	Margin (dB)	Meas. Time (ms)	Bandwidth (kHz)	Height (cm)	Pol	Azimuth (deg)	Elevation (deg)	Corr. (dB/m)
2483.500	54.5	---	74.00	19.45	1000.0	1000.000	150.0	V	-158.0	105.0	5.3
2483.500	---	36.6	54.00	17.38	1000.0	1000.000	150.0	V	-187.0	105.0	5.3

5.7.5 TEST EQUIPMENT USED

- Radiated Emissions

5.8 CHANNEL SEPARATION

Standard **FCC Part 15 Subpart C**

The test was performed according to:
ANSI C63.10

5.8.1 TEST DESCRIPTION

The Equipment Under Test (EUT) was set up to perform the channel separation measurement. The channel separation is independent of the modulation pattern.

The EUT was connected to the test system as described in the block diagram below. The complete attenuation of the measurement path is known and considered.

Analyser settings:

- Detector: Peak
- Trace: Maxhold
- Span: appr. 3 x OBW
- Centre Frequency: approximate mid of two channels
- Resolution Bandwidth (RBW): appr. 30 % of channel spacing
- Video Bandwidth (VBW): \geq RBW
- Sweep Time: Auto
- Sweeps: Till stable (min. 2000, max. 30000)

The technology depending measurement parameters can be found in the measurement plot.

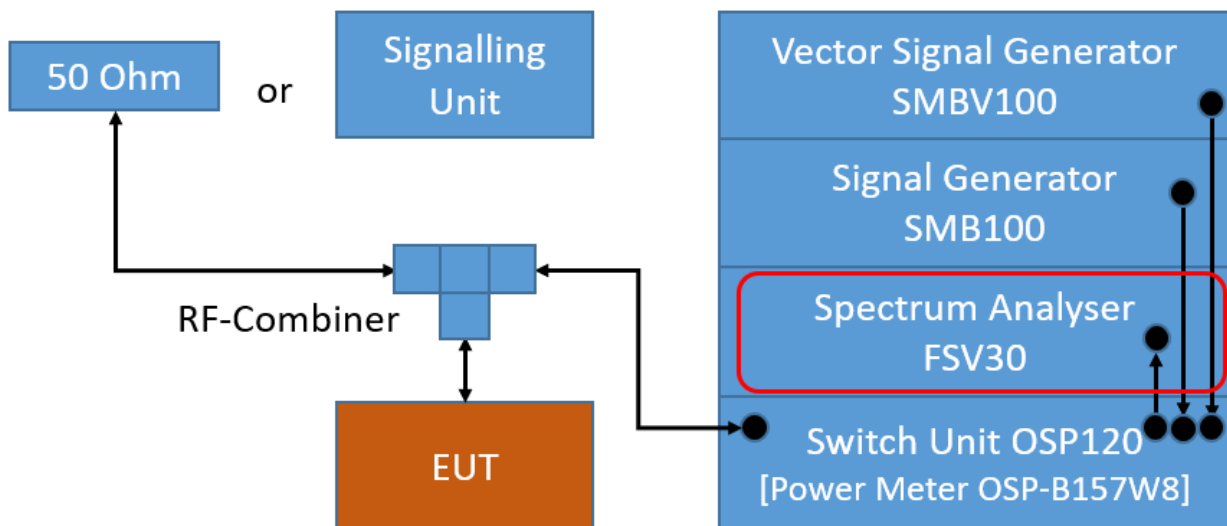

TS8997; Channel Separation

5.8.2 TEST REQUIREMENTS / LIMITS

FCC Part 15, Subpart C, §15.247 (a) (1)

Frequency hopping systems shall have hopping channel carrier frequencies separated by a minimum of 25 kHz or the 20 dB bandwidth of the hopping channel, whichever is greater. Alternatively, frequency hopping systems operating in the 2400–2483.5 MHz band may have hopping channel carrier frequencies that are separated by 25 kHz or two-thirds of the 20 dB bandwidth of the hopping channel, whichever is greater, provided the systems operate with an output power no greater than 125 mW. The system shall hop to channel frequencies that are selected at the system hopping rate from a pseudo randomly ordered list of hopping frequencies. Each frequency must be used equally on the average by each transmitter. The system receivers shall have input bandwidths that match the hopping channel bandwidths of their corresponding transmitters and shall shift frequencies in synchronization with the transmitted signals.

5.8.3 TEST PROTOCOL

Ambient temperature: 25 °C
 Air Pressure: 1009 hPa
 Humidity: 50 %

Radio Technology	Channel Separation [MHz]	Limit [MHz]	Margin to Limit [MHz]
BT GFSK (1-DH1)	1.010	0.915	0.095

Remark: Please see next sub-clause for the measurement plot.

5.8.4 MEASUREMENT PLOT (EXAMPLE PLOT, SHOWING WORST CASE, IF APPLICABLE)

Radio Technology = Bluetooth BDR
 (S01_ab01_BT_Headset)

Result

DUT Frequency (MHz)	Frequency Separation (MHz)	Limit Min (MHz)	Limit Max (MHz)	Center Frequency low Channel (MHz)	Center Frequency high Channel (MHz)	Result
2441.000000	1.009901	0.583333	---	2440.965347	2441.975248	PASS

CFS

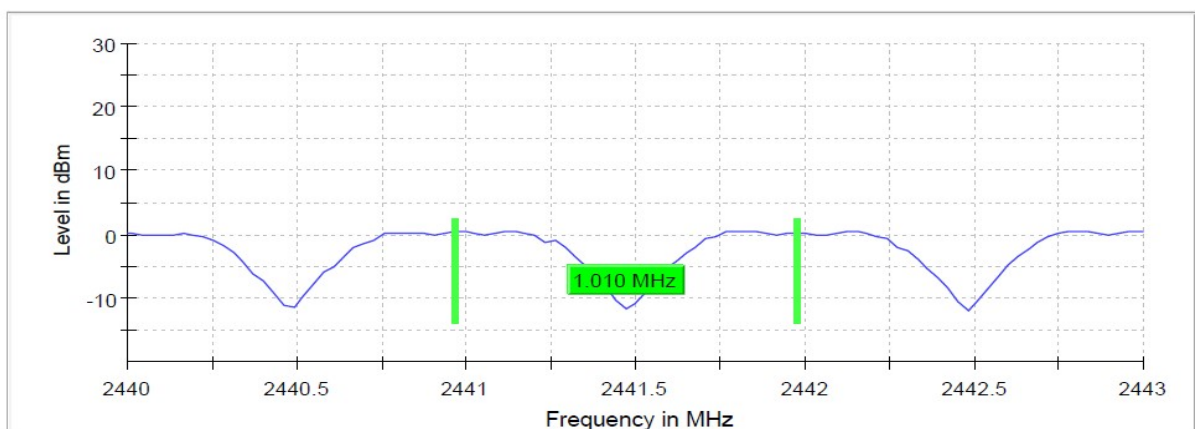

5.8.5 TEST EQUIPMENT USED

- R&S TS8997

5.9 DWELL TIME

Standard **FCC Part 15 Subpart C**

The test was performed according to:
ANSI C63.10

5.9.1 TEST DESCRIPTION

The Equipment Under Test (EUT) was set up to perform the dwell time measurement. The dwell time is independent of the modulation pattern. The EUT is set to its maximum dwell time.

The dwell time is measured by spectrum analyser and power meter in parallel. The spectrum analyser video output is connected to the power meter allowing the power meter to measure transmission time only when the EUT is actively transmitting on the measured channel. The power meter is using a time resolution of 1 μ s resulting in a more accurate measurement than possible using the spectrum analyser. In addition, measurement of burst length on more than one transmission is performed this way.

In addition to the calculated dwell time from single burst length, measured dwell time summing up all measured bursts lengths as measured by the power meter is given in the result table.

Calculation for Bluetooth Classic:

Maximum Duty Cycle is given for DH5 packets, resulting in 5 time slots transmission, 1 time slots reception. Each time slot lasts 625 μ s.

Dwell time is calculated as: measured length of a single 5 time slot transmission multiplied by the number of bursts measured by the power meter.

Analyser Settings single 5 slot burst:

- Centre Frequency: mid channel frequency
- Span: Zero span
- Detector: Peak
- Resolution Bandwidth (RBW): \leq Channel separation
- Trigger: Video
- Sweep Time: 3 ms
- Sweep Points: 30001
- Single Sweep

Analyser setting full sweep:

- Centre Frequency: mid channel frequency
- Span: Zero span
- Detector: Peak
- Resolution Bandwidth (RBW): \leq Channel separation
- Trigger: External
- Sweep Time: 31.6 s
- Sweep Points: 30001
- Single Sweep

Time resolution of power meter: 1 μ s

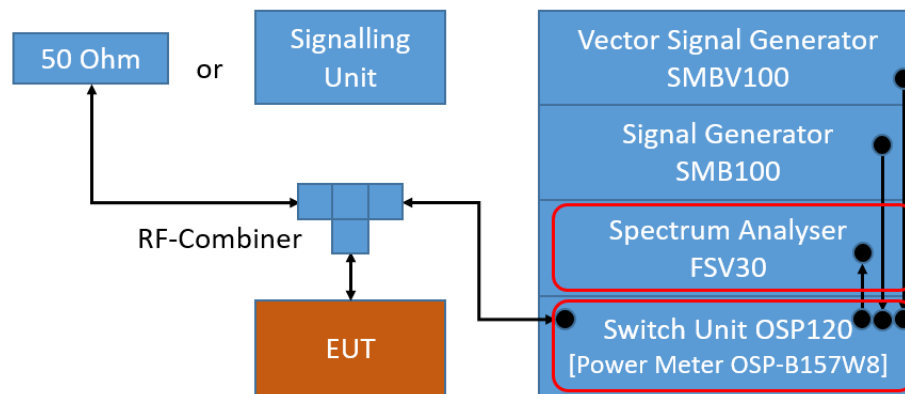

TS8997; Dwell Time

5.9.2 TEST REQUIREMENTS / LIMITS

For the band: 902 – 928 MHz
FCC Part 15, Subpart C, §15.247 (a) (1) (i)

If the 20 dB bandwidth of the hopping channel is less than 250 kHz the average time of occupancy on any frequency shall not be greater than 0.4 seconds within a 20 second period.
If the 20 dB bandwidth of the hopping channel is 250 kHz or greater, the average time of occupancy on any frequency shall not be greater than 0.4 seconds within a 10 second period.

For the band: 5725 – 5850 MHz
FCC Part 15, Subpart C, §15.247 (a) (1) (ii)

The average time of occupancy on any frequency shall not be greater than 0.4 seconds within a 30 second period.

For the frequency band 2400 – 2483.5 MHz:
FCC Part 15, Subpart C, §15.247 (a) (1) (iii)

...The average time of occupancy on any channel shall not be greater than 0.4 seconds within a period of 0.4 seconds multiplied by the number of hopping channels employed. Since the Bluetooth technology uses 79 channels this period is calculated to be 31.6 seconds.

FCC Part 15, Subpart C, §15.247 (f)

(f) For the purposes of this section, hybrid systems are those that employ a combination of both frequency hopping and digital modulation techniques. The frequency hopping operation of the hybrid system, with the direct sequence or digital modulation operation turned-off, shall have an average time of occupancy on any frequency not to exceed 0.4 seconds within a time period in seconds equal to the number of hopping frequencies employed multiplied by 0.4.

...

5.9.3 TEST PROTOCOL

Ambient temperature: 25 °C
 Air Pressure: 1009 hPa
 Humidity: 50 %

Radio Technology	Time Slot Length [ms]	Number of hops in observation period	Dwell Time [ms]	Limit [ms]	Margin to Limit [ms]
BT GFSK (1-DH5)	2.85	104	296.4	400.0	103.6

5.9.4 MEASUREMENT PLOT

Time of Channel Occupancy

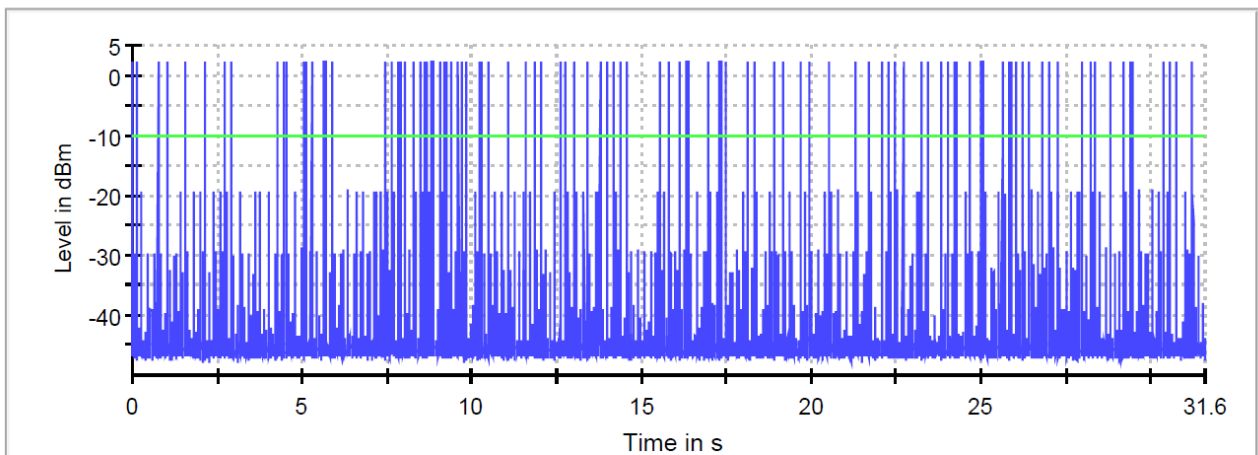

— Trace — Threshold

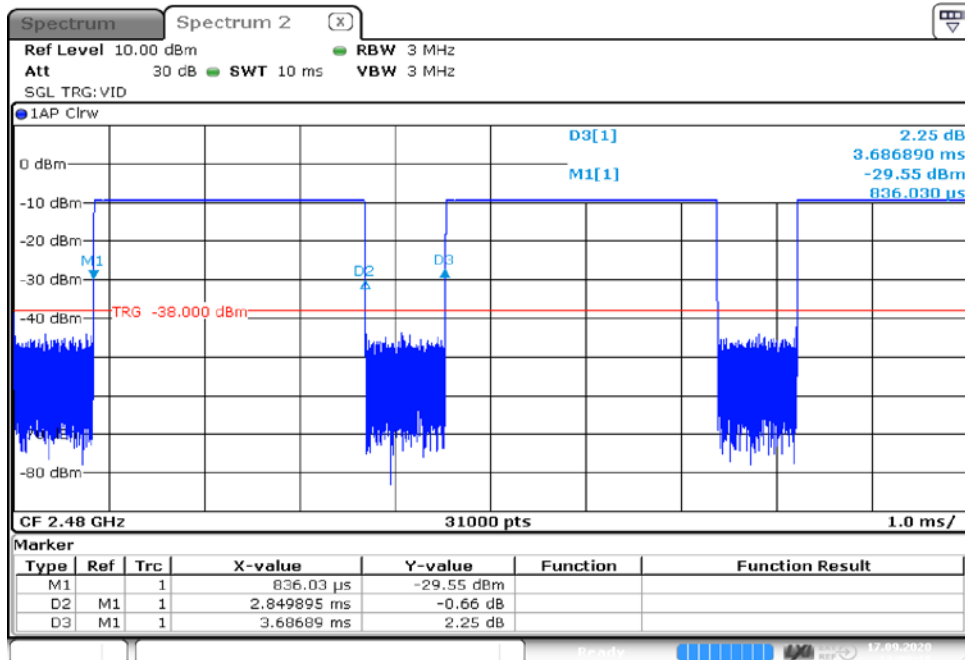

Date: 17.SEP.2020 18:00:18

5.9.5 TEST EQUIPMENT USED

- R&S TS8997

5.10 NUMBER OF HOPPING FREQUENCIES

Standard **FCC Part 15 Subpart C**

The test was performed according to:
ANSI C63.10

5.10.1 TEST DESCRIPTION

The Equipment Under Test (EUT) was set up to perform the number of hopping frequencies measurement. The number of hopping frequencies is independent of the modulation pattern.

The EUT was connected to the test system as described in the block diagram below. The complete attenuation of the measurement path is known and considered.

Analyser settings:

- Detector: Peak
- Trace: Maxhold
- Frequency span: Frequency band of operation
- Resolution Bandwidth (RBW): < 30 % of channel spacing or 20 dB bandwidth (whichever is smaller)
- Video Bandwidth (VBW): 3 x RBW
- Sweep Time: Auto
- Sweeps: Till stable (min. 300, max. 15000)

The technology depending measurement parameters can be found in the measurement plot.

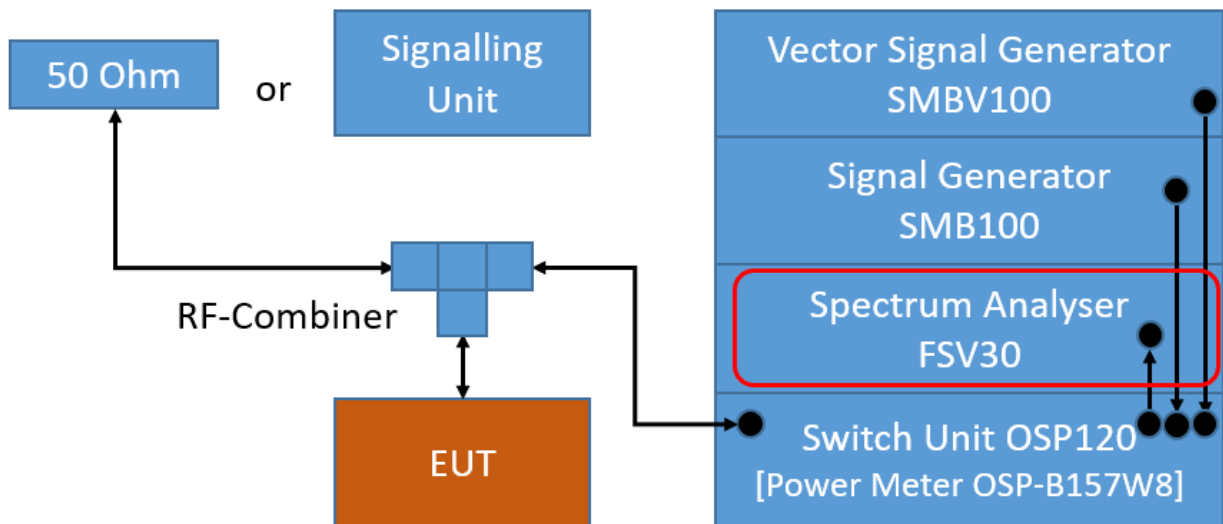

TS8997; Number of Hopping Frequencies

5.10.2 TEST REQUIREMENTS / LIMITS

For the band: 902 – 928 MHz
FCC Part 15, Subpart C, §15.247 (a) (1) (i)

If the 20 dB bandwidth of the hopping channel is less than 250 kHz, the system shall use at least 50 hopping frequencies.
If the 20 dB bandwidth of the hopping channel is 250 kHz or greater, the system shall use at least 25 hopping frequencies

For the band: 5725 – 5850 MHz
FCC Part 15, Subpart C, §15.247 (a) (1) (ii)

Frequency hopping systems operating in the 5725-5850 MHz band shall use at least 75 hopping frequencies.

For the band: 2400 – 2483.5 MHz
FCC Part 15, Subpart C, §15.247 (a) (1) (iii)

Frequency hopping systems in the 2400-2483.5 MHz band shall use at least 15 channels.

5.10.3 TEST PROTOCOL

Ambient temperature: 25 °C
Air Pressure: 1009 hPa
Humidity: 50 %

Radio Technology	Number of Hopping Frequencies	Limit	Margin to Limit
BT GFSK (1-DH1)	79	15	64

Remark: Please see next sub-clause for the measurement plot.

5.10.4 MEASUREMENT PLOT (EXAMPLE PLOT, SHOWING WORST CASE, IF APPLICABLE)

Radio Technology = Bluetooth BDR
(S01_ab01_BT_Headset)

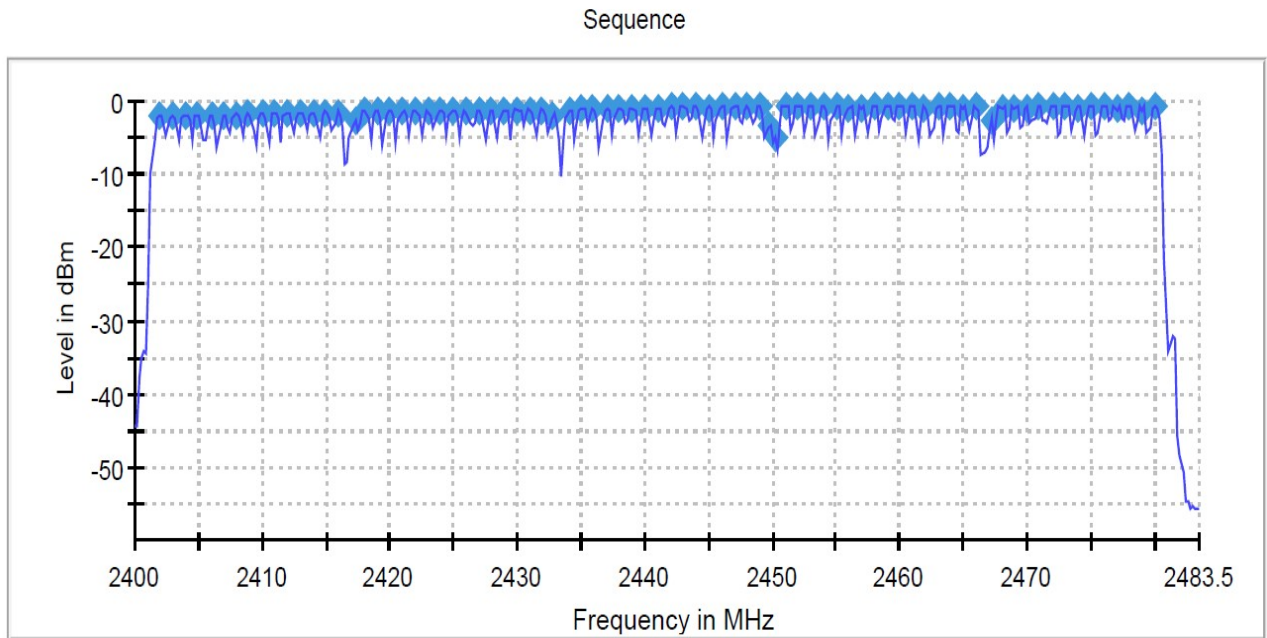

5.10.5 TEST EQUIPMENT USED

- R&S TS8997

6 TEST EQUIPMENT

1 R&S TS8997
EN300328/301893 Test Lab

Ref. No.	Device Name	Description	Manufacturer	Serial Number	Last Calibration	Calibration Due
1.1	SMB100A	Signal Generator 9 kHz - 6 GHz	Rohde & Schwarz	107695	2020-08	2023-08
1.2	FSV30	Signal Analyzer 10 Hz - 30 GHz	Rohde & Schwarz	103005	2020-05	2022-05
1.3	Fluke 177	Digital Multimeter 03 (Multimeter)	Fluke Europe B.V.	86670383	2020-04	2022-04
1.4	NGSM 32/10	Power Supply	Rohde & Schwarz GmbH & Co. KG	3456	2020-01	2022-01
1.5	SMBV100A	Enhanced GNSS	Rohde & Schwarz GmbH & Co. KG	262682-eP	2018-01	2021-01
1.6	Opus10 THI (8152.00)	T/H Logger 03	Lufft Mess- und Regeltechnik GmbH	7482	2019-06	2021-06
1.7	SMBV100A	Vector Signal Generator 9 kHz - 6 GHz	Rohde & Schwarz	259291	2019-11	2022-11
1.8	OSP120	Contains Power Meter and Switching Unit OSP-B157W8	Rohde & Schwarz	101158	2018-05	2021-05

2 Radiated Emissions
Lab to perform radiated emission tests

Ref. No.	Device Name	Description	Manufacturer	Serial Number	Last Calibration	Calibration Due
2.1	MFS	Rubidium Frequency Normal MFS	Datum GmbH	002	2019-10	2020-10
2.2	N5000/NP	Filter for EUT, 2 Lines, 250 V, 16 A	ETS-LINDGREN	241515		
2.3	Opus10 TPR (8253.00)	T/P Logger 13	Lufft Mess- und Regeltechnik GmbH	13936	2019-05	2021-05
2.4	ESW44	EMI Receiver / Spectrum Analyzer	Rohde & Schwarz GmbH & Co. KG	101603	2019-12	2021-12
2.5	Anechoic Chamber 01	SAC/FAR, 10.58 m x 6.38 m x 6.00 m	Frankonia	none		
2.6	HL 562 ULTRALOG	Biconical-log-per antenna (30 MHz - 3 GHz) with HL 562E biconicals	Rohde & Schwarz GmbH & Co. KG	830547/003	2018-07	2021-07
2.7	AMF-7D00101800-30-10P-R	Broadband Amplifier 100 MHz - 18 GHz	Miteq			
2.8	5HC2700/12750-1.5-KK	High Pass Filter	Trilithic	9942012		

Ref. No.	Device Name	Description	Manufacturer	Serial Number	Last Calibration	Calibration Due
2.9	ASP 1.2/1.8-10 kg	Antenna Mast	Maturo GmbH	-		
2.10	Anechoic Chamber 03	FAR, 8.80m x 4.60m x 4.05m (l x w x h)	Albatross Projects	P26971-647-001-PRB		
2.11	Fluke 177	Digital Multimeter 03 (Multimeter)	Fluke Europe B.V.	86670383	2020-04	2022-04
2.12	Opus10 THI (8152.00)	T/H Logger 10	Lufft Mess- und Regeltechnik GmbH	12488	2019-06	2021-06
2.13	PONTIS Con4101	PONTIS Camera Controller		6061510370		
2.14	JS4-18002600-32-5P	Broadband Amplifier 18 GHz - 26 GHz	Miteq	849785		
2.15	FSW 43	Spectrum Analyzer	Rohde & Schwarz	103779	2019-02	2021-02
2.16	3160-09	Standard Gain / Pyramidal Horn Antenna 26.5 GHz	EMCO Elektronik GmbH	00083069		
2.17	WHKX 7.0/18G-8SS	High Pass Filter	Wainwright Instruments GmbH	09		
2.18	DS 420S	Turn Table 2 m diameter	HD GmbH	420/573/99		
2.19	4HC1600/12750-1.5-KK	High Pass Filter	Trilithic	9942011		
2.20	SMB100A	Signal Generator 100 kHz - 40 GHz	Rohde & Schwarz Vertriebs-GmbH	181486	2019-11	2021-11
2.21	JS4-00102600-42-5A	Broadband Amplifier 30 MHz - 26 GHz	Miteq	619368		
2.22	TT 1.5 WI	Turn Table	Maturo GmbH	-		
2.23	HL 562 ULTRALOG	Biconical-log-per Antenna (30 MHz - 3 GHz)	Rohde & Schwarz GmbH & Co. KG	100609	2019-05	2022-05
2.24	foCAN (v 4.0)	Fibre optic link CAN	Audivo GmbH (PONTIS EMC)	492 1607 014		
2.25	3160-10	Standard Gain / Pyramidal Horn Antenna 40 GHz	EMCO Elektronik GmbH	00086675		
2.26	MA4985-XP-ET	Bore Sight Antenna Mast	innco systems GmbH	none		
2.27	JUN-AIR Mod. 6-15	Air Compressor	JUN-AIR Deutschland GmbH	612582		
2.28	5HC3500/18000-1.2-KK	High Pass Filter	Trilithic	200035008		
2.29	HFH2-Z2	Loop Antenna	Rohde & Schwarz	829324/006	2018-01	2021-01
2.30	SB4-100.OLD20-3T/10 Airwin 2 x 1.5 kW	Air compressor (oil-free)	airWin Kompressoren UG	901/00503		
2.31	UNI-T UT195E	True RMS Digital Multimeter	UNI-T UNI-TREND TECHNOLOGY (CHINA) CO., LTD.	C190729561		

Ref. No.	Device Name	Description	Manufacturer	Serial Number	Last Calibration	Calibration Due
2.32	JS4-00101800-35-5P	Broadband Amplifier 30 MHz - 18 GHz	Miteq	896037		
2.33	AS 620 P	Antenna Mast (pneumatic polarisation)	HD GmbH	620/37		
2.34	6005D (30 V / 5 A)	Laboratory Power Supply 120 V 60 Hz	PeakTech	81062045		
2.35	TD1.5-10kg	EUT Tilt Device (Rohacell)	Maturo GmbH	TD1.5-10kg/024/3790709		
2.36	Innco Systems CO3000	Controller for bore sight mast SAC	innco systems GmbH	CO3000/967/39371016/L		
2.37	NRV-Z1	Sensor Head B	Rohde & Schwarz GmbH & Co. KG	827753/006	2019-08	2020-08
2.38	HF 907-2	Double-ridged horn	Rohde & Schwarz	102817	2019-04	2022-04
2.39	foCAN (v 4.0)	Fibre optic link CAN	Audio GmbH (PONTIS EMC)	492 1607 013		
2.40	PAS 2.5 - 10 kg	Antenna Mast	Maturo GmbH	-		
2.41	AFS42-00101800-25-S-42	Broadband Amplifier 25 MHz - 18 GHz	Miteq	2035324		
2.42	AM 4.0	Antenna Mast 4 m	Maturo GmbH	AM4.0/180/11920513		
2.43	HF 907	Double-ridged horn	Rohde & Schwarz	102444	2018-07	2021-07

The calibration interval is the time interval between "Last Calibration" and "Calibration Due"

7 ANTENNA FACTORS, CABLE LOSS AND SAMPLE CALCULATIONS

This chapter contains the antenna factors with their corresponding path loss of the used measurement path for all antennas as well as the insertion loss of the LISN.

7.1 LISN R&S ESH3-Z5 (150 KHZ – 30 MHZ)

Frequency MHz	Corr. dB	LISN insertion loss ESH3- Z5 dB	cable loss (incl. 10 dB atten- uator) dB
0.15	10.1	0.1	10.0
5	10.3	0.1	10.2
7	10.5	0.2	10.3
10	10.5	0.2	10.3
12	10.7	0.3	10.4
14	10.7	0.3	10.4
16	10.8	0.4	10.4
18	10.9	0.4	10.5
20	10.9	0.4	10.5
22	11.1	0.5	10.6
24	11.1	0.5	10.6
26	11.2	0.5	10.7
28	11.2	0.5	10.7
30	11.3	0.5	10.8

Sample calculation

$$U_{\text{LISN}} (\text{dB } \mu\text{V}) = U (\text{dB } \mu\text{V}) + \text{Corr. (dB)}$$

U = Receiver reading

LISN Insertion loss = Voltage Division Factor of LISN

Corr. = sum of single correction factors of used LISN, cables, switch units (if used)

Linear interpolation will be used for frequencies in between the values in the table.

7.3 ANTENNA R&S HL562 (30 MHz – 1 GHz)

($d_{Limit} = 3\text{ m}$)

Frequency MHz	AF R&S HL562 dB (1/m)	Corr. dB
30	18.6	0.6
50	6.0	0.9
100	9.7	1.2
150	7.9	1.6
200	7.6	1.9
250	9.5	2.1
300	11.0	2.3
350	12.4	2.6
400	13.6	2.9
450	14.7	3.1
500	15.6	3.2
550	16.3	3.5
600	17.2	3.5
650	18.1	3.6
700	18.5	3.6
750	19.1	4.1
800	19.6	4.1
850	20.1	4.4
900	20.8	4.7
950	21.1	4.8
1000	21.6	4.9

cable loss 1 (inside chamber) dB	cable loss 2 (outside chamber) dB	cable loss 3 (switch unit) dB	cable loss 4 (to receiver) dB	distance corr. (-20 dB/ decade) dB	d_{Limit} (meas. distance limit) m	d_{used} (meas. distance used) m
0.29	0.04	0.23	0.02	0.0	3	3
0.39	0.09	0.32	0.08	0.0	3	3
0.56	0.14	0.47	0.08	0.0	3	3
0.73	0.20	0.59	0.12	0.0	3	3
0.84	0.21	0.70	0.11	0.0	3	3
0.98	0.24	0.80	0.13	0.0	3	3
1.04	0.26	0.89	0.15	0.0	3	3
1.18	0.31	0.96	0.13	0.0	3	3
1.28	0.35	1.03	0.19	0.0	3	3
1.39	0.38	1.11	0.22	0.0	3	3
1.44	0.39	1.20	0.19	0.0	3	3
1.55	0.46	1.24	0.23	0.0	3	3
1.59	0.43	1.29	0.23	0.0	3	3
1.67	0.34	1.35	0.22	0.0	3	3
1.67	0.42	1.41	0.15	0.0	3	3
1.87	0.54	1.46	0.25	0.0	3	3
1.90	0.46	1.51	0.25	0.0	3	3
1.99	0.60	1.56	0.27	0.0	3	3
2.14	0.60	1.63	0.29	0.0	3	3
2.22	0.60	1.66	0.33	0.0	3	3
2.23	0.61	1.71	0.30	0.0	3	3

($d_{Limit} = 10\text{ m}$)

Frequency MHz	AF R&S HL562 dB (1/m)	Corr. dB
30	18.6	-9.9
50	6.0	-9.6
100	9.7	-9.2
150	7.9	-8.8
200	7.6	-8.6
250	9.5	-8.3
300	11.0	-8.1
350	12.4	-7.9
400	13.6	-7.6
450	14.7	-7.4
500	15.6	-7.2
550	16.3	-7.0
600	17.2	-6.9
650	18.1	-6.9
700	18.5	-6.8
750	19.1	-6.3
800	19.6	-6.3
850	20.1	-6.0
900	20.8	-5.8
950	21.1	-5.6
1000	21.6	-5.6

cable loss 1 (inside chamber) dB	cable loss 2 (outside chamber) dB	cable loss 3 (switch unit) dB	cable loss 4 (to receiver) dB	distance corr. (-20 dB/ decade) dB	d_{Limit} (meas. distance limit) m	d_{used} (meas. distance used) m
0.29	0.04	0.23	0.02	-10.5	10	3
0.39	0.09	0.32	0.08	-10.5	10	3
0.56	0.14	0.47	0.08	-10.5	10	3
0.73	0.20	0.59	0.12	-10.5	10	3
0.84	0.21	0.70	0.11	-10.5	10	3
0.98	0.24	0.80	0.13	-10.5	10	3
1.04	0.26	0.89	0.15	-10.5	10	3
1.18	0.31	0.96	0.13	-10.5	10	3
1.28	0.35	1.03	0.19	-10.5	10	3
1.39	0.38	1.11	0.22	-10.5	10	3
1.44	0.39	1.20	0.19	-10.5	10	3
1.55	0.46	1.24	0.23	-10.5	10	3
1.59	0.43	1.29	0.23	-10.5	10	3
1.67	0.34	1.35	0.22	-10.5	10	3
1.67	0.42	1.41	0.15	-10.5	10	3
1.87	0.54	1.46	0.25	-10.5	10	3
1.90	0.46	1.51	0.25	-10.5	10	3
1.99	0.60	1.56	0.27	-10.5	10	3
2.14	0.60	1.63	0.29	-10.5	10	3
2.22	0.60	1.66	0.33	-10.5	10	3
2.23	0.61	1.71	0.30	-10.5	10	3

Sample calculation

$$E \text{ (dB } \mu\text{V/m)} = U \text{ (dB } \mu\text{V)} + \text{AF (dB 1/m)} + \text{Corr. (dB)}$$

U = Receiver reading

AF = Antenna factor

Corr. = sum of single correction factors of used cables, switch unit, distance correction, amplifier (if applicable)

distance correction = $-20 * \text{LOG} (d_{Limit} / d_{used})$

Linear interpolation will be used for frequencies in between the values in the table.

Tables show an extract of values.

7.4 ANTENNA R&S HF907 (1 GHZ – 18 GHZ)

Frequency	AF R&S HF907	Corr.
MHz	dB (1/m)	dB
1000	24.4	-19.4
2000	28.5	-17.4
3000	31.0	-16.1
4000	33.1	-14.7
5000	34.4	-13.7
6000	34.7	-12.7
7000	35.6	-11.0

cable loss 1 (relay + cable inside chamber)	cable loss 2 (outside chamber)	cable loss 3 (switch unit, attenuator & pre-amp)	cable loss 4 (to receiver)		
dB	dB	dB	dB		
0.99	0.31	-21.51	0.79		
1.44	0.44	-20.63	1.38		
1.87	0.53	-19.85	1.33		
2.41	0.67	-19.13	1.31		
2.78	0.86	-18.71	1.40		
2.74	0.90	-17.83	1.47		
2.82	0.86	-16.19	1.46		

Frequency	AF R&S HF907	Corr.
MHz	dB (1/m)	dB
3000	31.0	-23.4
4000	33.1	-23.3
5000	34.4	-21.7
6000	34.7	-21.2
7000	35.6	-19.8

cable loss 1 (relay inside chamber)	cable loss 2 (inside chamber)	cable loss 3 (outside chamber)	cable loss 4 (switch unit, attenuator & pre-amp)	cable loss 5 (to receiver)	used for FCC 15.247
dB	dB	dB	dB	dB	
0.47	1.87	0.53	-27.58	1.33	
0.56	2.41	0.67	-28.23	1.31	
0.61	2.78	0.86	-27.35	1.40	
0.58	2.74	0.90	-26.89	1.47	
0.66	2.82	0.86	-25.58	1.46	

Frequency	AF R&S HF907	Corr.
MHz	dB (1/m)	dB
7000	35.6	-57.3
8000	36.3	-56.3
9000	37.1	-55.3
10000	37.5	-56.2
11000	37.5	-55.3
12000	37.6	-53.7
13000	38.2	-53.5
14000	39.9	-56.3
15000	40.9	-54.1
16000	41.3	-54.1
17000	42.8	-54.4
18000	44.2	-54.7

cable loss 1 (relay inside chamber)	cable loss 2 (High Pass)	cable loss 3 (pre-amp)	cable loss 4 (inside chamber)	cable loss 5 (outside chamber)	cable loss 6 (to receiver)
dB	dB	dB	dB	dB	dB
0.56	1.28	-62.72	2.66	0.94	1.46
0.69	0.71	-61.49	2.84	1.00	1.53
0.68	0.65	-60.80	3.06	1.09	1.60
0.70	0.54	-61.91	3.28	1.20	1.67
0.80	0.61	-61.40	3.43	1.27	1.70
0.84	0.42	-59.70	3.53	1.26	1.73
0.83	0.44	-59.81	3.75	1.32	1.83
0.91	0.53	-63.03	3.91	1.40	1.77
0.98	0.54	-61.05	4.02	1.44	1.83
1.23	0.49	-61.51	4.17	1.51	1.85
1.36	0.76	-62.36	4.34	1.53	2.00
1.70	0.53	-62.88	4.41	1.55	1.91

Sample calculation

$$E \text{ (dB } \mu\text{V/m)} = U \text{ (dB } \mu\text{V)} + \text{AF (dB 1/m)} + \text{Corr. (dB)}$$

U = Receiver reading

AF = Antenna factor

Corr. = sum of single correction factors of used cables, switch unit, distance correction, amplifier (if applicable)

Linear interpolation will be used for frequencies in between the values in the table.

Tables show an extract of values.

7.5 ANTENNA EMCO 3160-09 (18 GHZ – 26.5 GHZ)

Frequency	AF EMCO 3160-09	Corr.	cable loss 1 (inside chamber)	cable loss 2 (pre- amp)	cable loss 3 (inside chamber)	cable loss 4 (switch unit)	cable loss 5 (to receiver)
MHz	dB (1/m)	dB	dB	dB	dB	dB	dB
18000	40.2	-23.5	0.72	-35.85	6.20	2.81	2.65
18500	40.2	-23.2	0.69	-35.71	6.46	2.76	2.59
19000	40.2	-22.0	0.76	-35.44	6.69	3.15	2.79
19500	40.3	-21.3	0.74	-35.07	7.04	3.11	2.91
20000	40.3	-20.3	0.72	-34.49	7.30	3.07	3.05
20500	40.3	-19.9	0.78	-34.46	7.48	3.12	3.15
21000	40.3	-19.1	0.87	-34.07	7.61	3.20	3.33
21500	40.3	-19.1	0.90	-33.96	7.47	3.28	3.19
22000	40.3	-18.7	0.89	-33.57	7.34	3.35	3.28
22500	40.4	-19.0	0.87	-33.66	7.06	3.75	2.94
23000	40.4	-19.5	0.88	-33.75	6.92	3.77	2.70
23500	40.4	-19.3	0.90	-33.35	6.99	3.52	2.66
24000	40.4	-19.8	0.88	-33.99	6.88	3.88	2.58
24500	40.4	-19.5	0.91	-33.89	7.01	3.93	2.51
25000	40.4	-19.3	0.88	-33.00	6.72	3.96	2.14
25500	40.5	-20.4	0.89	-34.07	6.90	3.66	2.22
26000	40.5	-21.3	0.86	-35.11	7.02	3.69	2.28
26500	40.5	-21.1	0.90	-35.20	7.15	3.91	2.36

Sample calculation

$E \text{ (dB } \mu\text{V/m)} = U \text{ (dB } \mu\text{V)} + AF \text{ (dB 1/m)} + Corr. \text{ (dB)}$
 U = Receiver reading
 AF = Antenna factor
 Corr. = sum of single correction factors of used cables, switch unit, distance correction, amplifier (if applicable)
 Linear interpolation will be used for frequencies in between the values in the table.
 Table shows an extract of values.

7.6 ANTENNA EMCO 3160-10 (26.5 GHZ – 40 GHZ)

Frequency GHz	AF EMCO 3160-10 dB (1/m)	Corr. dB	cable loss 1 (inside chamber) dB	cable loss 2 (outside chamber) dB	cable loss 3 (switch unit) dB	cable loss 4 (to receiver) dB	distance corr. (-20 dB/ decade) dB	d _{Limit} (meas. distance (limit) m	d _{used} (meas. distance (used) m
26.5	43.4	-11.2	4.4				-9.5	3	1.0
27.0	43.4	-11.2	4.4				-9.5	3	1.0
28.0	43.4	-11.1	4.5				-9.5	3	1.0
29.0	43.5	-11.0	4.6				-9.5	3	1.0
30.0	43.5	-10.9	4.7				-9.5	3	1.0
31.0	43.5	-10.8	4.7				-9.5	3	1.0
32.0	43.5	-10.7	4.8				-9.5	3	1.0
33.0	43.6	-10.7	4.9				-9.5	3	1.0
34.0	43.6	-10.6	5.0				-9.5	3	1.0
35.0	43.6	-10.5	5.1				-9.5	3	1.0
36.0	43.6	-10.4	5.1				-9.5	3	1.0
37.0	43.7	-10.3	5.2				-9.5	3	1.0
38.0	43.7	-10.2	5.3				-9.5	3	1.0
39.0	43.7	-10.2	5.4				-9.5	3	1.0
40.0	43.8	-10.1	5.5				-9.5	3	1.0

Sample calculation

$$E \text{ (dB } \mu\text{V/m)} = U \text{ (dB } \mu\text{V)} + AF \text{ (dB 1/m)} + Corr. \text{ (dB)}$$

U = Receiver reading

AF = Antenna factor

Corr. = sum of single correction factors of used cables, switch unit, distance correction, amplifier (if applicable)

Linear interpolation will be used for frequencies in between the values in the table.

distance correction = $-20 * \text{LOG} (d_{\text{Limit}} / d_{\text{used}})$

Linear interpolation will be used for frequencies in between the values in the table.

Table shows an extract of values.

8 MEASUREMENT UNCERTAINTIES

Test Case	Parameter	Uncertainty
AC Power Line	Power	± 3.4 dB
Field Strength of spurious radiation	Power	± 5.5 dB
6 dB / 26 dB / 99% Bandwidth	Power Frequency	± 2.9 dB ± 11.2 kHz
Conducted Output Power	Power	± 2.2 dB
Band Edge Compliance	Power Frequency	± 2.2 dB ± 11.2 kHz
Frequency Stability	Frequency	± 25 Hz
Power Spectral Density	Power	± 2.2 dB

The measurement uncertainties for all parameters are calculated with an expansion factor (coverage factor) $k = 1.96$. This means, that the true value is in the corresponding interval with a probability of 95 %.

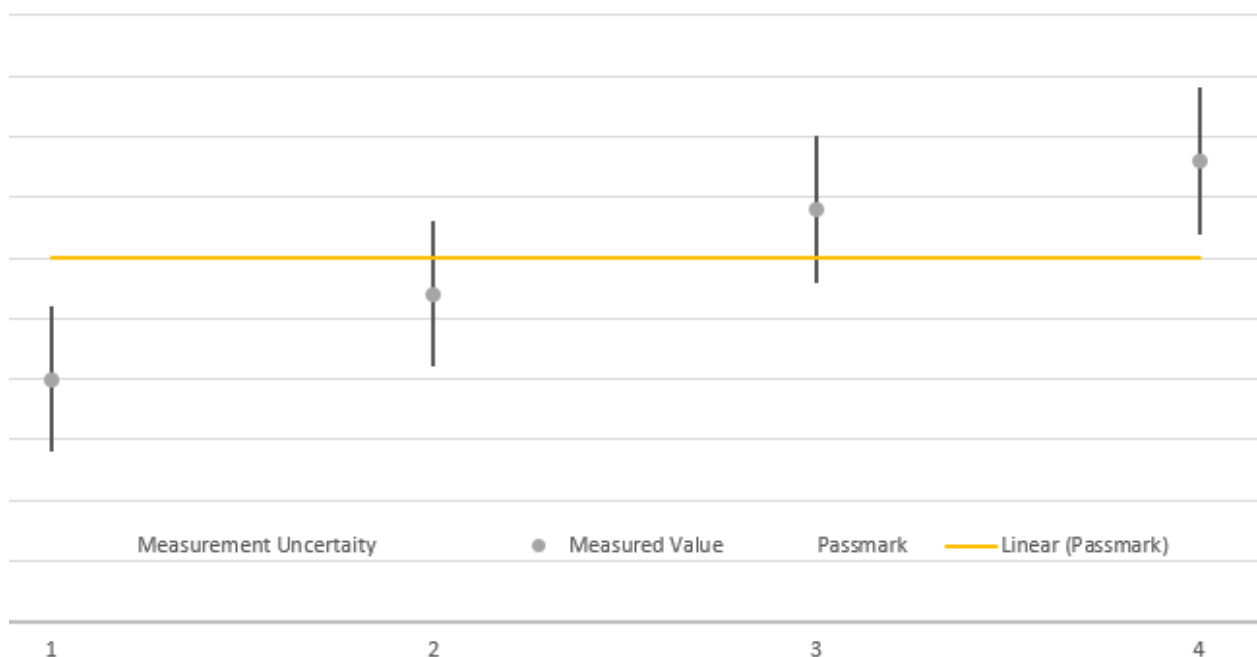

The verdicts in this test report are given according the above diagram:

Case	Measured Value	Uncertainty Range	Verdict
1	below pass mark	below pass mark	Passed
2	below pass mark	within pass mark	Passed
3	above pass mark	within pass mark	Failed
4	above pass mark	above pass mark	Failed

That means, the laboratory applies, as decision rule (see ISO/IEC 17025:2017), the so called shared risk principle.

9 PHOTO REPORT

Please see separate photo report.