

Test Report

Report Number:

F212284E1 2nd Version

Equipment under Test (EUT):

VCURM1

Applicant:

Robert Bosch Car Multimedia GmbH

Manufacturer:

Robert Bosch GmbH



Deutsche
Akkreditierungsstelle
D-PL-17186-01-01
D-PL-17186-01-02
D-PL-17186-01-03

References

- [1] **ANSI C63.4:2014** American National Standard for Methods of Measuring of Radio-Noise Emissions from Low-Voltage Electrical and Electronic Equipment in the Range of 9 kHz to 40 GHz.
- [2] **FCC 47 CFR Part 2:** General Rules and Regulations
- [3] **FCC 47 CFR Part 15:** Radio Frequency Devices (Subpart B)
- [4] **ICES-003 Issue 7: (October 2020)** Spectrum Management and Telecommunications. Interference-Causing Equipment Standard. Information Technology Equipment (Including Digital Apparatus) —Limits and Methods of Measurement

Test Result

The requirements of the tests performed as shown in the overview (clause 4) were fulfilled by the equipment under test. The complete test results are presented in the following.
“Passed” indicates that the equipment under test conforms with the relevant limits of the testing standard without taking any measurement uncertainty into account as stated in clause 1.3 of ANSI C63.10 (2013). However, the measurement uncertainty is calculated and shown in this test report.

Tested and written
by:

Signature

Reviewed and
approved by:

Signature

This test report is only valid in its original form.

Any reproduction of its contents in extracts without written permission of the accredited test laboratory PHOENIX TESTLAB GmbH is prohibited.

The test results herein refer only to the tested sample. PHOENIX TESTLAB GmbH is not responsible for any generalisations or conclusions drawn from these test results concerning further samples. Any modification of the tested samples is prohibited and leads to the invalidity of this test report. Each page necessarily contains the PHOENIX TESTLAB Logo and the TEST REPORT NUMBER.

Contents:	Page
1 Identification	4
1.1 Applicant.....	4
1.2 Manufacturer	4
1.3 Production facility	4
1.4 Test Laboratory	4
1.5 EUT (Equipment under Test)	5
1.6 Technical Data of Equipment	6
1.7 Dates	6
2 Operational States	7
2.1 Function description of connectors (EUT 101):.....	11
3 Additional Information	19
4 Overview.....	20
5 Results.....	22
5.1 Radiated emissions	22
5.1.1 Test method.....	22
5.1.2 Test results final measurement 30 MHz to 1 GHz.....	26
5.1.3 Test results final measurement above 1 GHz	28
5.2 Conducted emissions at antenna port receiver	31
5.2.1 Test method.....	31
5.2.2 Test results final measurement 30 MHz to 1 GHz.....	32
6 Test Equipment used for Tests	35
7 Measurement Uncertainties	36
8 Test site Verification.....	36
9 Report History.....	36
10 List of Annexes	36

1 Identification

1.1 Applicant

Name:	Robert Bosch GmbH
Address:	Robert-Bosch-Str. 200, 31139 Hildesheim
Country:	Germany
Name for contact purposes:	Mr. Tilman ALMSTEDT
Phone:	+49 5121 49-4226
eMail address:	Eike-Tilman.Almstedt@de.bosch.com
Applicant represented during the test by the following person:	-

1.2 Manufacturer

Name:	Robert Bosch GmbH
Address:	Robert-Bosch-Str. 200, 31139 Hildesheim
Country:	Germany
Name for contact purposes:	Mr. Dirk ZAMOW
Phone:	+49 5121 49-2608
eMail address:	Dirk.Zamow@de.bosch.com
Manufacturer represented during the test by the following person:	-

1.3 Production facility

Name:	Robert Bosch (Malaysia) Sdn Bhd
Address:	Free Industrial Zone 1, 11900 Bayan Lepas, Penang
Country:	Malaysia
Name for contact purposes:	Mr. Dr. Siegfried SKIRL
Phone:	-
eMail address:	Siegfried.Skirl@my.bosch.com
Manufacturer represented during the test by the following person:	-

1.4 Test Laboratory

The tests were carried out by: **PHOENIX TESTLAB GmbH**
Königswinkel 10
32825 Blomberg
Germany

Accredited by Deutsche Akkreditierungsstelle GmbH (DAkKS) in compliance with DIN EN ISO/IEC 17025 under Reg. No. D-PL-17186-01-06 and D-PL-17186-01-05, FCC Test Firm Designation Number DE0004, FCC Test Firm Registration Number 469623, CAB Identifier DE0003 and ISD# 3469A.

1.5 EUT (Equipment under Test)

EUT	
Test object: *	Virtual Cockpit Unit
Model name: *	VCURM1
Model number: *	7.515.400.920-22
Order number: *	NA
FCC ID: *	2AUXS-VCURM1
IC certification number: *	25847-VCURM1
PMN: *	VCURM1
HVIN: *	VCURM1
FVIN: *	NA
HMN: *	NA

EUT number	
	1
Serial number: *	1121330A10000280
PCB identifier: *	8638912015 8638912040 8638912111
Hardware version: *	C1.2
Software version: *	RQBM-542
Label	 <p>8461 1200 7310400000000X 652029760 1121330A10000280 Bosch P/N: 751 540 092 022 Made In Malaysia BOSCH</p> <p>Limited Functionality C – Sample Not For Sale For Internal Development Use Purpose Part can only be used for trial builds and must not be used for mass production</p> <p>YB291-101 MID C1.2 ROW RTA EMV</p>

* Declared by the applicant

EUT 1 was used for all tests.

Note: PHOENIX TESTLAB GmbH does not take samples. The samples used for tests are provided exclusively by the applicant.

1.6 Technical Data of Equipment

General EUT data			
Power supply EUT: *	DC		
Supply voltage EUT: *	$U_{Nom} = 13.5 \text{ V}_{DC}$	$U_{Min} = 6.0 \text{ V}_{DC}$	$U_{Max} = 16.0 \text{ V}_{DC}$
Temperature range: *	-40°C to +85°C		
Lowest / highest internal clock frequency: *	1 Hz / 6.264 GHz		

Ports / Connectors				
Identification	Connector		Length during test	Shielding (Yes / No)
	EUT	Ancillary		
J1 Quad-HFM	Harness	BIAS-T	2m	Yes
J2 56 way STAK50H SYSTEM	Harness	LOADBOX	2m	No
J3 AMEC Mixed 12 way	Harness	Optical system	2m	No
J4 HSAL-II	Harness	Optical system	2m	Yes
J6 HSAL-II	Harness	Optical system	2m	Yes
J7 Double-HFM	Harness	Video Generator	2m	Yes
J8 Single-HFM	Harness	WIFI Antenna	2m	Yes
J9 Quad-HFM	Harness	Video Generator	2m	Yes
J10 Quad-HFM	Harness	Video Generator	2m	Yes

Equipment used for testing	
Loadbox* ¹	GM VCU LOADBOX #03

*¹ Provided by the applicant

*² Provided by the laboratory

Ancillary equipment	
WIFI Antenna 84610506	TE Connectivity

*¹ Provided by the applicant

1.7 Dates

Date of receipt of test sample:	01.06.2022
Start of test:	01.06.2022
End of test:	20.06.2022

2 Operational States

Description of function of the EUT:

The EUT is a car infotainment PC running in normal operation mode.

The following states were defined as the operating conditions:

The EUT was supplied by 12 V DC during all tests.

During all tests, software BITS TML and Eclipse for TML (delivered by the applicant) was used to control the functions of the EUT.

The system was setup as follows:

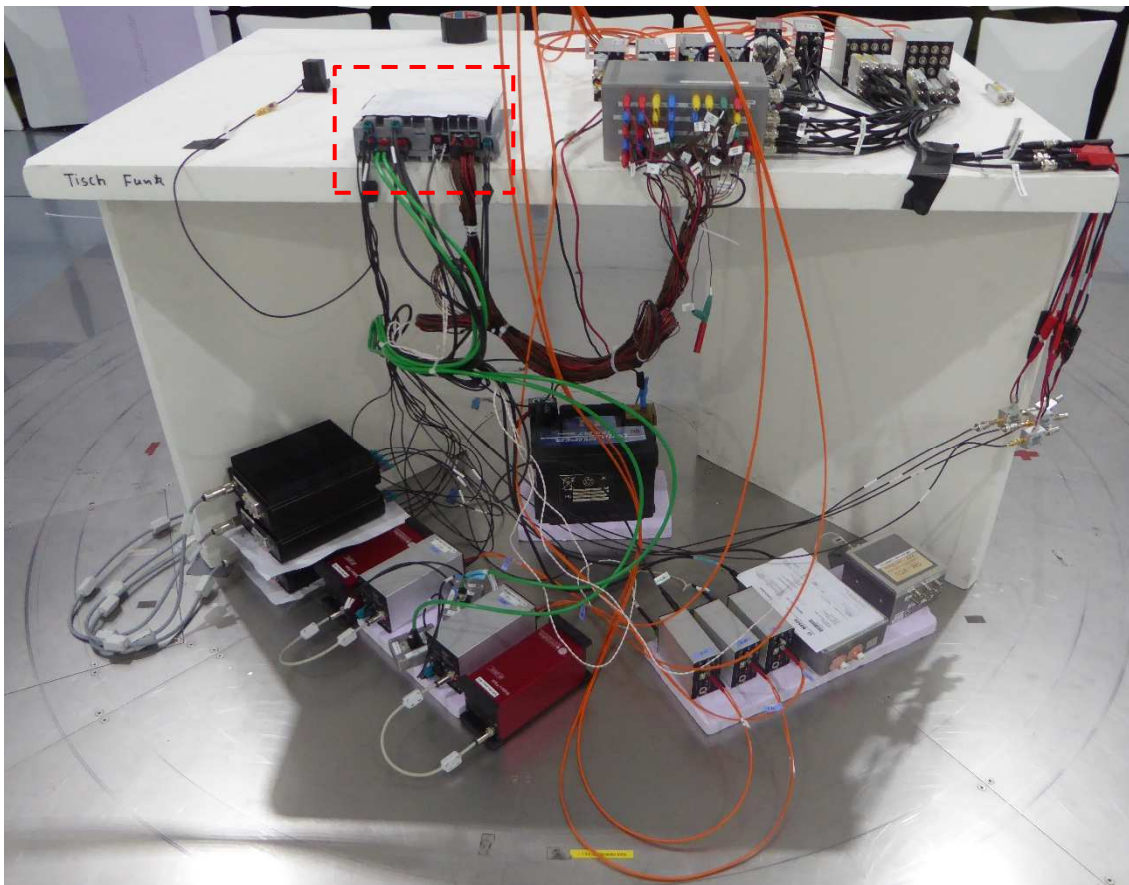

Information of the test setup provided by the applicant:

```
-----  
> Test tool: TML Framework 30.09.2020 / V 1.15.0.4 (1350) - for G3g:utf-8  
  
    For support please contact TML Support Group (TMLSupportGroup@bcn.bosch.com)  
  
    Contribute to TML: https://sourcecode.socialcoding.bosch.com/projects/TML/  
    TML Community    : https://connect.bosch.com/communities/community/TML  
  
-----  
> This is Python 2.7.9 (default, Dec 10 2014, 12:24:55) [MSC v.1500 32 bit (Intel)] on Windows  
  
-----  
> [Test tool configuration: 'default']  
  
* Test file.....: 'C:/AutoTest/Project/GM_VCU_PV1_MID_21.50.4/TestSpecific/EMC/LoopTest.tml'  
* Log file path.: 'C:/AutoTest/Project/GM_VCU_PV1_MID_21.50.4/Reports/20220131_161939_LoopTest'  
* Log file mode.: 10/7:'a'  
* Ctrl file path: 'C:/AutoTest/ctrlfiles'  
* Config file...: 2:'C:/AutoTest/Project/GM_VCU_PV1_MID_21.50.4/config/Variant.Default.atc'  
  Local config...+: 'C:/AutoTest/Project/GM_VCU_PV1_MID_21.50.4/_ConfigSpecific/___BITS.LocalConfig.atc'  
* Persist. path : 'C:/Users/bhd1hi/AppData/Local/Temp'  
* UUID.....: '6a798371-fcb8-4010-ab0c-82073b4cce8e'  
  
-----  
> [Test file header]  
  
* Author.....: 'Andreas Hoepfer CM-CI1/ESW3, Reiner Flemming BMS, Dattatrya Raghunath Bhosle Hi 460/EG'  
* Project.....: 'BOSCH Electrical-EMC Test: GM VCU'  
* Source file date...: '24.01.2022'  
* Source file version: 'GM_VCU_PV1_MID / 21.50.4 / 0'  
* Keyword.....: ''  
* Short description..: 'Examples FTS'
```

Schematical draw of setup:

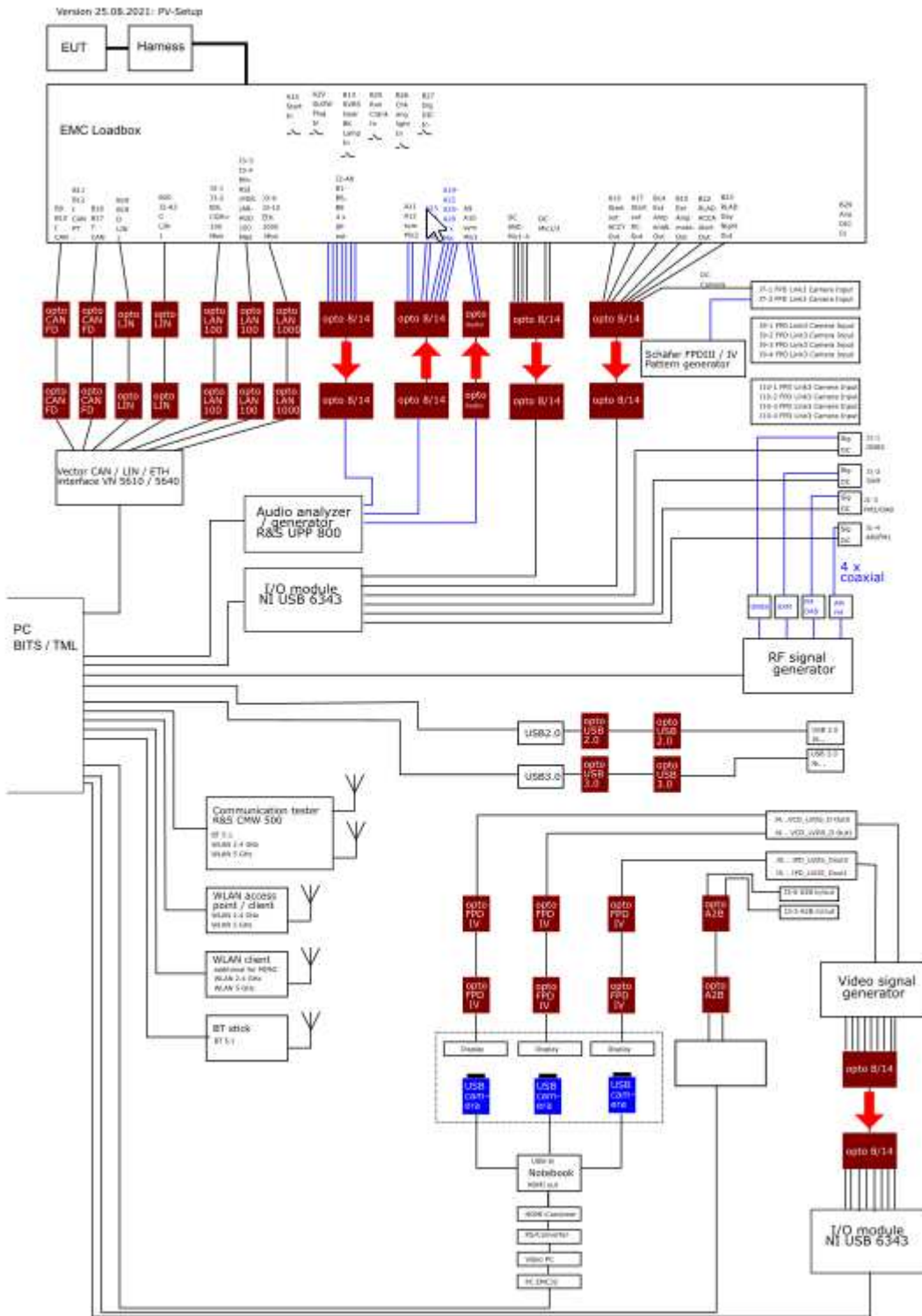



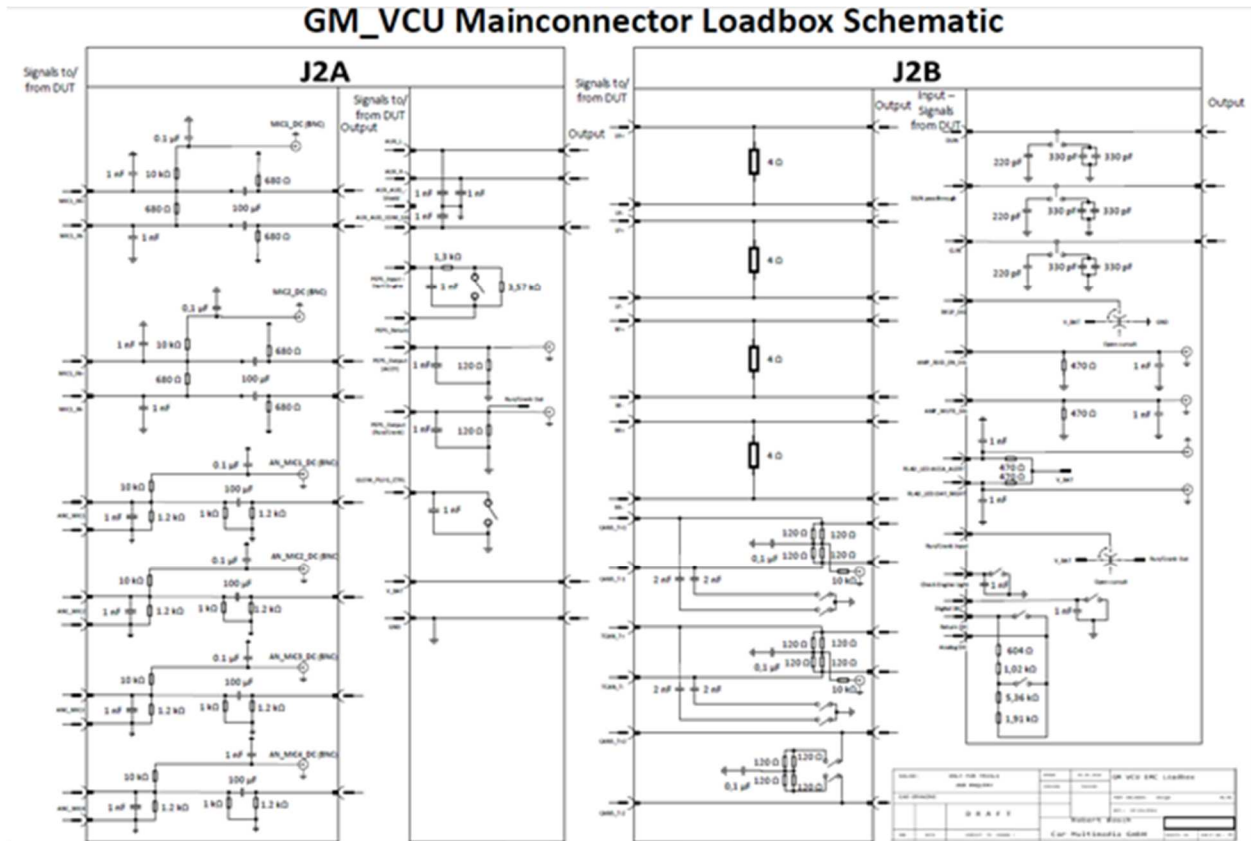

Schematical draw of Load box:



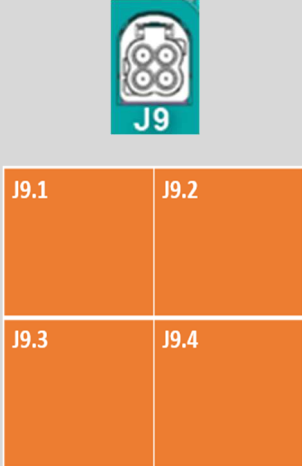

2.1 Function description of connectors (EUT 101):

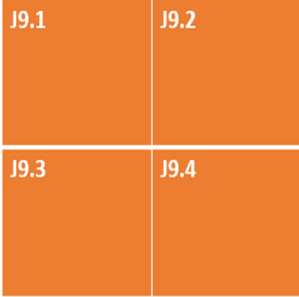
Function	Input Values /Connection e.g. audio signal 220mV sinus 900Hz via coaxial cable	Monitoring Parameter	Actual condition
Video Output 1 DSI	Display 1 See video input Parallel monitoring system: Master: Visual → human eye Slave: Automated Advise surveillance system Data rate: 10.8 Gb/s	Level 1: No influence: No blank display or OFF No Freezing No Flickering	OK
Video Output 2 DP0 Note: data rate refer to the free form display.	Display 2 See Video input Parallel monitoring system: Master: Visual → human eye Slave: Automated Advise s surveillance system Data rate: 12,528 Gb/s	Level 1: No influence: No blank display or OFF No Freezing No Flickering	OK
USB 2.0 (SW update only no Audio)	Simulation of USB 2.0 data traffic between VCU and control PC. Data Rate/ Iteration Error monitoring via Diagnostic over CAN Stick with file to make data transfer	Byte error count = 0 Average read / write speed ≥ 10 Mb/s	OK
USB 3.0	Simulation of USB 3.0 data traffic between VCU and control PC. Data Rate/ Iteration Error monitoring via Diagnostic over CAN Stick with file to make data transfer.	Byte error count = 0 Average read / write speed ≥ 10 MB/s	OK

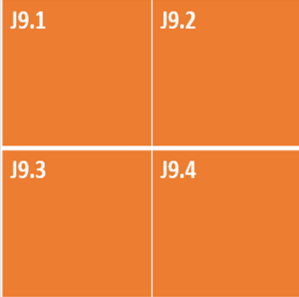
<p>Bluetooth 5.0</p>	<p>Permanent Bluetooth loopback test:</p> <p>Text file will be sent from a BT USB dongle to the VCU.</p> <p>As soon as the file is received, data Integrity check will be done. The same file will be then sent back to the control PC. Data integrity will be checked again.</p>	<p>1. data rate \geq 400 Kb/s 2. data integrity \rightarrow Pass</p>	<p>OK Not active during Emission test</p>
<p>WLAN 2.4 / 5 GHz 802.11 b, g, n (ax)</p> <p>Note:3</p>	<p>Permanent TCP/IP connection between DUT and access point (AP).</p> <p>Continuous data transfer.</p> <p>DUT shall be configured to 2.4GHz</p> <p>Antenna configuration:</p> <p>Internal & external antennas shall be used at the same time.</p>	<p>2.4 GHz - No interruption of the data transfer during the test</p> <p>\geq ~ 54 Mb/s</p> <p>5 GHz - No interruption of the data transfer during the test</p> <p>\geq ~ 360 Mb/s</p>	<p>OK Not active during Emission test</p>
<p>Video in 1</p> <p>Note:</p> <p>Required for PV: 4k resolution</p> <p>Sync-Mode</p>	<p>Connector J9 (pin 1): Fed via video shielded signal generator inside the chamber.</p>  <p>Display 1</p>		<p>OK</p>

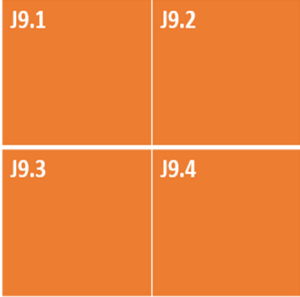
<p>Video in 2</p> <p>Note:</p> <p>Required for PV: 4k resolution</p> <p>Sync-Mode</p>	<p>Connector J9 (pin 2): Fed via video shielded signal generator inside the chamber.</p>   <p>Display 1</p>		<p>OK</p>
<p>Video in 3</p> <p>Note:</p> <p>Required for PV: 4k resolution</p> <p>Sync-Mode</p>	<p>Connector J9 (pin 3): Fed via video shielded signal generator inside the chamber.</p>   <p>Display 1</p>		<p>OK</p>

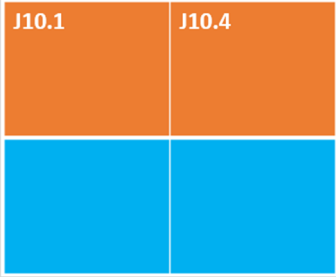
<p>Video in 4</p> <p>Note:</p> <p>Required for PV: 4k resolution</p> <p>Sync-Mode</p>	<p>Connector J9 (pin 4): Fed via video shielded signal generator inside the chamber.</p>   <p>Display 1</p>		<p>OK</p>
<p>Video in 5</p> <p>Note:</p> <p>Required for PV: 4k resolution</p> <p>Sync-Mode</p>	<p>Connector J10 (pin 1): Fed via video shielded signal generator inside the chamber.</p>   <p>Display 2</p>		<p>OK</p>

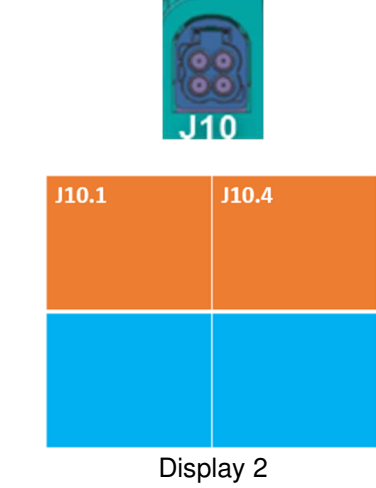
<p>Video in 6</p> <p>Note:</p> <p>Required for PV: 4k resolution</p> <p>Sync-Mode</p>	<p>Connector J10 (pin 4): Fed via video shielded signal generator inside the chamber</p> 		<p>OK</p>
<p>Hand Free Mic 1</p>	<p>Route audio signal to amplifier Test frequency: 600 Hz.</p> <p>Monitoring of the phantom DC voltage</p>	<p>Undisturbed audio signal:</p> <ol style="list-style-type: none"> 1. Audio volume 2. Audio frequency 3. Phantom voltage MIC 4. Phantom voltage ANC <ol style="list-style-type: none"> 1. [1.1V – 1.7V] 2. [f_in +/- 10Hz] 3. 6,8 ±10% 4. 3.1 ±10% 	<p>OK</p>
<p>Hand Free Mic 2</p>	<p>Route audio signal to amplifier Test frequency: 650 Hz.</p> <p>Monitoring of the phantom DC voltage</p>	<p>Undisturbed audio signal:</p> <ol style="list-style-type: none"> 1. Audio volume 2. Audio frequency 3. Phantom voltage MIC 4. Phantom voltage ANC <ol style="list-style-type: none"> 1. [1.1V – 1.7V] 2. [f_in +/- 10Hz] 3. 6,8 ±10% 4. 3.1 ±10% 	<p>OK</p>
<p>ANC Mic 1</p>	<p>Route audio signal via amplifier to loudspeakers</p> <p>Test frequencies: ANC: 800 Hz</p> <p>Monitoring of the phantom DC voltage</p>	<p>Undisturbed audio signal:</p> <ol style="list-style-type: none"> 1. Audio volume 2. Audio frequency 3. Phantom voltage MIC 4. Phantom voltage ANC <ol style="list-style-type: none"> 1. [1.1V – 1.7V] 2. [f_in +/- 10Hz] 3. 6,8 ±10% 4. 3.1 ±10% 	<p>OK</p>

ANC Mic 2	<p>Route audio signal via amplifier to loudspeakers</p> <p>Test frequencies: ANC: 850 Hz</p> <p>Monitoring of the phantom DC voltage</p>	<p>Undisturbed audio signal:</p> <ol style="list-style-type: none"> 1. Audio volume 2. Audio frequency 3. Phantom voltage MIC 4. Phantom voltage ANC <ol style="list-style-type: none"> 1. [1.1V – 1.7V] 2. [f_in +/- 10Hz] 3. 6,8 ±10% 4. 3.1 ±10% 	OK
ANC Mic 3	<p>Route audio signal via amplifier to loudspeakers</p> <p>Test frequencies: ANC: 900 Hz</p> <p>Monitoring of the phantom DC voltage</p>	<p>Undisturbed audio signal:</p> <ol style="list-style-type: none"> 1. Audio volume 2. Audio frequency 3. Phantom voltage MIC 4. Phantom voltage ANC <ol style="list-style-type: none"> 1. [1.1V – 1.7V] 2. [f_in +/- 10Hz] 3. 6,8 ±10% 4. 3.1 ±10% 	OK
ANC Mic 4	<p>Route audio signal via amplifier to loudspeakers</p> <p>Test frequencies: ANC: 950 Hz</p> <p>Monitoring of the phantom DC voltage</p>	<p>Undisturbed audio signal:</p> <ol style="list-style-type: none"> 1. Audio volume 2. Audio frequency 3. Phantom voltage MIC 4. Phantom voltage ANC <ol style="list-style-type: none"> 1. [1.1V – 1.7V] 2. [f_in +/- 10Hz] 3. 6,8 ±10% 4. 3.1 ±10% 	OK
LIN 1 (SWC/UGDO)	<p>Permanent data transfer (LIN Protocol), between VCU and Control PC via Verctor CANoe tool (RBS).</p>	<p>undisturbed LIN bus communication undisturbed</p> <p>Bus Load ≤ 44%</p>	OK
LIN 3 (Power Volume Switch Bank)	<p>Permanent data transfer (LIN Protocol), between VCU and Control PC via Vector CANoe tool (RBS).</p>	<p>undisturbed LIN bus communication undisturbed</p> <p>Bus Load ≤ 28%</p>	OK
ICAN	<p>Permanent data transfer (CAN Protocol), between VCU and Control PC via Vector CANoe tool (RBS)</p>	<p>undisturbed CAN bus communication</p> <p>Bus Load ≤ 0.2%</p>	OK

TCAN	Permanent data transfer (CAN Protocol), between VCU and Control PC via Vector CANoe tool (RBS).	undisturbed CAN bus communication Bus Load \leq 46%	OK
A2B	Route an analog audio input to the loudspeakers. signal 1KHz.	Undisturbed audio signal: 1. Audio volume 2. Audio frequency 1. [1.1V – 1.7V] 2. [f_in +/- 10Hz]	OK Background Scan
AM	Audio signal: AM signal with 60 dB μ V - AF: 1KHz, mod: 30% Analog output - 1.4 VRMS / 4 Ω A sinusoidal audio tone at 1KHz is generated from the test environment and fed as modulation: 30 % into antenna input line on VCU, which is routed to the internal amplifier then to loudspeaker output.	1. Audio volume 2. Audio frequency 3. Phantom voltage 1. [1.1V – 1.7V] 2. [f_in +/- 10Hz] 3. [9V – n/a]	OK Background Scan
FM1	A sinusoidal audio tone at 1kHz is generated from the Test Environment and fed as modulation on 96.1 MHz into antenna input line on VCU. Output to be monitored at VCU loudspeaker output. Monitoring of the phantom DC voltage	1. Audio volume 2. Audio frequency 3. Phantom voltage 1. [1.1V – 1.7V] 2. [f_in +/- 10Hz] 3. [9V – n/a]	OK
FM2	A sinusoidal audio tone at 1kHz is generated from the Test Environment and fed as modulation on 96.1 MHz into antenna input line on VCU. Output to be monitored at VCU loudspeaker output. Monitoring of the phantom DC voltage.	1. Audio volume 2. Audio frequency 3. Phantom voltage 1. [1.1V – 1.7V] 2. [f_in +/- 10Hz] 3. [9V – n/a]	OK Background Scan

DAB	Input (DAB Signal) Output (Bias voltage / Audio Signal)	1. Audio volume 2. Audio frequency 3. DAB BER 4. Phantom voltage 5. Phantom current 1. [1.1V – 1.7V] 2. [f_in +/- 10Hz] 3. [n/a – 100 ppm] 4. [9V – n/a] 5. [20mA – n/a]	OK Background Scan
AUX	Route audio signal to amplifier Test frequencies: L: 700 Hz, R: 750 Hz Audio signal is routed to amplifier then to loudspeakers.	1. Audio volume 2. Audio frequency 1. [1.1V – 1.7V] 2. [f_in +/- 10Hz]	OK
1st Ethernet T100	After TCP/IP connection has been established: Continuous data transfer between VCU and control PC via 100BASE-T MediaConverter box.	Continuous Ethernet communication No interruption of the data transfer during the test ≥ ~ 20% of max data rate	OK
2nd Ethernet T100	After TCP/IP connection has been established: Continuous data transfer between VCU and control PC via 100BASE-T MediaConverter box.	Continuous Ethernet communication No interruption of the data transfer during the test ≥ ~ 20% of max data rate	OK
Ethernet T1000	After TCP/IP connection has been established: Continuous data transfer between VCU and control PC via 1000BASE-T MediaConverter box.	Continuous Ethernet communication No interruption of the data transfer during the test ≥ ~ 20% of max data rate	OK
GYRO	N/A	Gyro offset G +/-0.75 dps	OK
Accelerometer	N/A	Static state Zero-g offset +/-5 mg	OK
System Temperature	SiP module temperature will be read continuously the results will be monitored during the tests.	1. t_SoC T° sensor 1. < 107 °C SiP module temperature Checked for limit (107°C),	OK

GNSS reception GPS / GLONASS	N/A	1. Phantom voltage 2. Phantom current 3. Position failures 4. Satellite FIX failures 1. [4V – n/a] 2. [n/a – 15 mA] 3. [0] 4. [0] Single position	OK
RLAD DAY_NIGHT	Output: Low	Voltage Output low side correct state: test cycle time low 0.5 s high	OK
RLAD FCA_ALERT	Output: Low	Voltage Output low side correct state: test cycle time low 0.5 s high	OK
GLOW PLUG	Input: Fixed key Low	Voltage correct state: Fixed key Low	OK
Backup Lampe	Input: Fixed key High	Voltage Fixed key High	OK
AMP Enable	Output: High	Voltage Output High side correct state: test cycle time high 0.5 s low	OK

3 Additional Information

The EUT was not labeled as required by FCC / IC.

4 Overview

Conducted emissions FCC 47 CFR Part 15 section 15.107 (a),(b) [3] ICES-003 Issue 7 section 3.2.1[4]					
Application	Frequency range	Limits	Reference standard	Tested EUT	Status
AC supply line Class A	0.15 to 0.5 MHz 0.5 to 30 MHz	79 dB(μ V) QP 66 dB(μ V) AV 73 dB(μ V) QP 60 dB(μ V) AV	ANSI C63.4	-	Not applicable
AC supply line Class B	0.15 to 0.5 MHz 0.5 to 5 MHz 5 to 30 MHz	66 to 56 dB(μ V) QP* 56 to 46 dB(μ V) AV* 56 dB(μ V) QP 46 dB(μ V) AV 60 dB(μ V) QP 50 dB(μ V) AV	ANSI C63.4	-	Not applicable
*: Decreases with the logarithm of the frequency					

Conducted emissions FCC 47 CFR Part 15 section 15.111 (a),(b) [3]					
Application	Frequency range	Limits	Reference standard	Tested EUT	Status
Antenna power conduction limits for receivers	30 MHz to 2 GHz	-57 dBm	ANSI C63.4	1	Passed

Radiated emissions FCC 47 CFR Part 15 section 15.109 (a),(b) [3]					
Application	Frequency range	Limits	Reference standard	Tested EUT	Status
Radiated Emission Class A	30 to 88 MHz 88 to 216 MHz 216 to 960 MHz 960 to 1000 MHz above 1000 MHz	39.0 dB(μ V/m) QP at 10 m 43.5 dB(μ V/m) QP at 10 m 46.5 dB(μ V/m) QP at 10 m 49.5 dB(μ V/m) QP at 10 m 49.5 dB(μ V/m) AV at 10 m and 69.5 dB(μ V/m) PK at 10 m	ANSI C63.4	-	Not applicable
Radiated Emission Class B	30 to 88 MHz 88 to 216 MHz 216 to 960 MHz 960 to 1000 MHz above 1000 MHz	40.0 dB(μ V/m) QP at 3 m 43.5 dB(μ V/m) QP at 3 m 46.0 dB(μ V/m) QP at 3 m 54.0 dB(μ V/m) QP at 3 m 54.0 dB(μ V/m) AV at 3 m and 74.0 dB(μ V/m) PK at 3 m	ANSI C63.4	1	Passed

Radiated emissions ICES-003 Issue 7 section 3.2.2 [4]					
Application	Frequency range	Limits	Reference standard	Tested EUT	Status
Radiated Emission Class A	30 to 88 MHz 88 to 216 MHz 216 to 230 MHz 230 to 960 MHz 960 to 1000 MHz above 1000 MHz	50.0 dB(μ V/m) QP at 3 m 54.0 dB(μ V/m) QP at 3 m 56.9 dB(μ V/m) QP at 3 m 57.0 dB(μ V/m) QP at 3 m 60.0 dB(μ V/m) QP at 3 m 60 dB(μ V/m) AV at 3 m and 80 dB(μ V/m) PK at 3 m	ANSI C63.4	-	Not applicable
Radiated Emission Class B	30 to 88 MHz 88 to 216 MHz 216 to 230 MHz 230 to 960 MHz 960 to 1000 MHz above 1000 MHz	40.0 dB(μ V/m) QP at 3 m 43.5 dB(μ V/m) QP at 3 m 46.0 dB(μ V/m) QP at 3 m 47.0 dB(μ V/m) QP at 3 m 54.0 dB(μ V/m) QP at 3 m 54 dB(μ V/m) AV at 3 m and 74 dB(μ V/m) PK at 3 m	ANSI C63.4	1	Passed

Remark: As declared by the applicant the highest internal clock frequency is 6.264 GHz.
Therefore the radiated emission measurement must be carried out up to 5th of the highest internal clock frequency in this case 40 GHz.

The EUT was classified by the applicant as CLASS B equipment.

5 Results

5.1 Radiated emissions

5.1.1 Test method

Preliminary and final measurement 30 MHz to 1 GHz

The preliminary and final measurements are performed in a semi-anechoic chamber with a metal ground plane in a 3 m distance.

During the tests the EUT is rotated in the range of 0 ° to 360 °, the measuring antenna is set to horizontal and vertical polarization and raised and lowered in the range from 1 m to 4 m to find the maximum level of emissions.

The resolution bandwidth of the EMI Receiver is set to the following values:

Test	Frequency range	Resolution bandwidth
Preliminary measurement	30 MHz to 1 GHz	100 kHz
Frequency peak search	± 1 MHz	10 kHz
Final measurement	30 MHz to 1 GHz	120 kHz

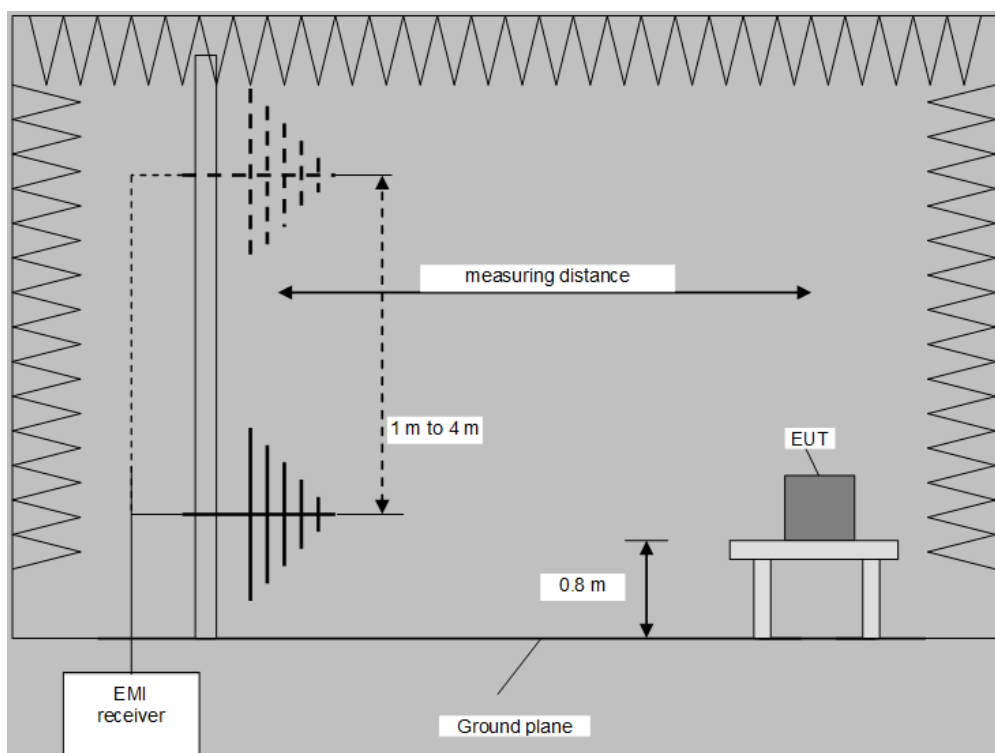

Procedure preliminary measurement:

The following procedure is used:

- 1) Set the measuring antenna to 1 m height.
- 2) Monitor the frequency range at horizontal polarisation of the measuring antenna and an EUT / turntable azimuth of 0 °.
- 3) Rotate the EUT by 360° to maximize the detected signals.
- 4) Repeat steps 2 to 3 with the vertical polarisation of the measuring antenna.
- 5) Increase the height of the measuring antenna for 0.5 m and repeat steps 2 to 4 until the final height of 4 m is reached.
- 6) The highest values for each frequency are saved by the software, including the measuring antenna height and polarization and the turntable azimuth for that value.

Procedure final measurement:

The following procedure is used:

- 1) Select the highest frequency peaks (lowest margin to the limit) for the final measurement.
- 2) The software determines the exact peak frequencies by doing a partial scan with reduced RBW with ± 10 times the RBW of the pre-scan of the selected peaks.
- 3) If the EUT is portable or ceiling mounted, find the worst-case EUT orientation (x, y, z) for the final test.
- 4) The worst-case measuring antenna height is found via varying the height by ± 0.5 m from the value obtained in the preliminary measurement while monitoring the emission level.
- 5) The worst-case turntable position is found via varying the turntable azimuth by $\pm 30^\circ$ from the value obtained in the preliminary measurement while monitoring the emission level.
- 6) The final measurement is performed at the worst-case measuring antenna height and the worst-case turntable azimuth.
- 7) Steps 2 to 6 are repeated for each frequency peak selected in step 1.

Preliminary and final measurement > 1 GHz

The preliminary and final measurements are performed in a semi-anechoic chamber with floor absorbers between EUT and measuring antenna. The measuring distance is 3 m.

During the tests the EUT is rotated in the range of 0 ° to 360 °, the measuring antenna is set to horizontal and vertical polarization and raised and lowered in the range from 1 m to 4 m to find the maximum level of emissions. While changing the height, the measuring antenna gets tilted so that it is always aiming at the EUT.

The resolution bandwidth of the EMI Receiver is set to the following values:

Test	Frequency range	Resolution bandwidth
Preliminary measurement	1 - 40 GHz	1 MHz
Frequency peak search	± 10 MHz	100 kHz
Final measurement	1 - 40 GHz	1 MHz

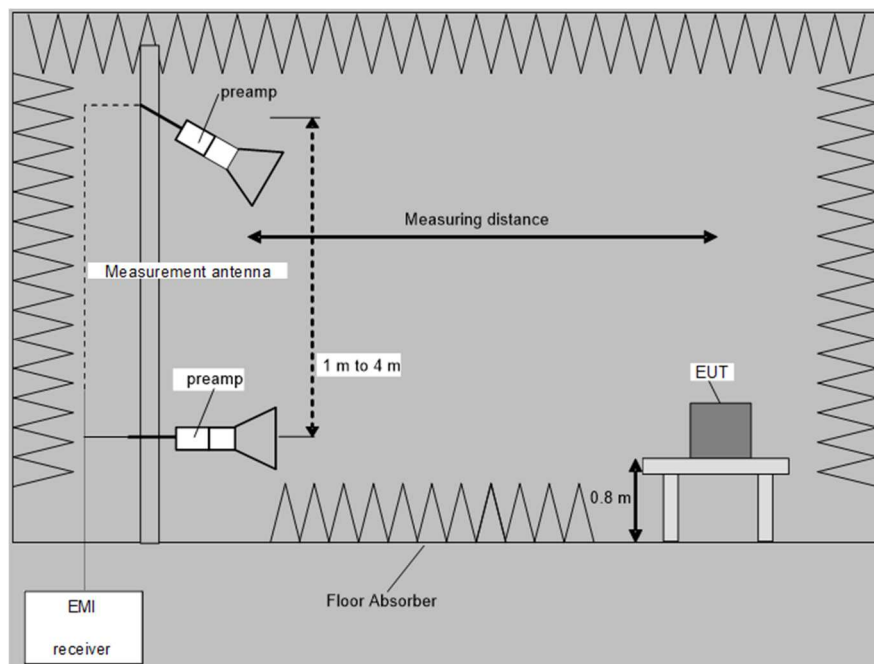

Procedure preliminary measurement:

The following procedure is used:

- 1) Set the measuring antenna to 1 m height.
- 2) Monitor the frequency range at horizontal polarisation of the measuring antenna and an EUT / turntable azimuth of 0 °.
- 3) Rotate the EUT by 360° to maximize the detected signals.
- 4) Repeat steps 2 to 3 with the vertical polarisation of the measuring antenna.
- 5) Increase the height of the measuring antenna for 0.5 m and repeat steps 2 to 4 until the final height of 4 m is reached.
- 6) The highest values for each frequency are saved by the software, including the measuring antenna height and polarization and the turntable azimuth for that value.

Procedure final measurement:

The following procedure is used:

- 1) Select the highest frequency peaks (lowest margin to the limit) for the final measurement.
- 2) The software determines the exact peak frequencies by doing a partial scan with reduced RBW with ± 10 times the RBW of the pre-scan of the selected peaks.
- 3) If the EUT is portable or ceiling mounted, find the worst-case EUT orientation (x,y,z) for the final test.
- 4) The worst-case measuring antenna height is found via varying the height by ± 0.5 m from the value obtained in the preliminary measurement while monitoring the emission level.
- 5) The worst-case turntable position is found via varying the turntable azimuth by $\pm 30^\circ$ from the value obtained in the preliminary measurement while monitoring the emission level.
- 6) The final measurement is performed at the worst-case measuring antenna height and the worst-case turntable azimuth.
- 7) Steps 2 to 6 are repeated for each frequency peak selected in step 1.

5.1.2 Test results final measurement 30 MHz to 1 GHz

Ambient temperature:	23 °C
Relative humidity:	32 %

Date:	01.06.2022
Tested by:	B. ROHDE

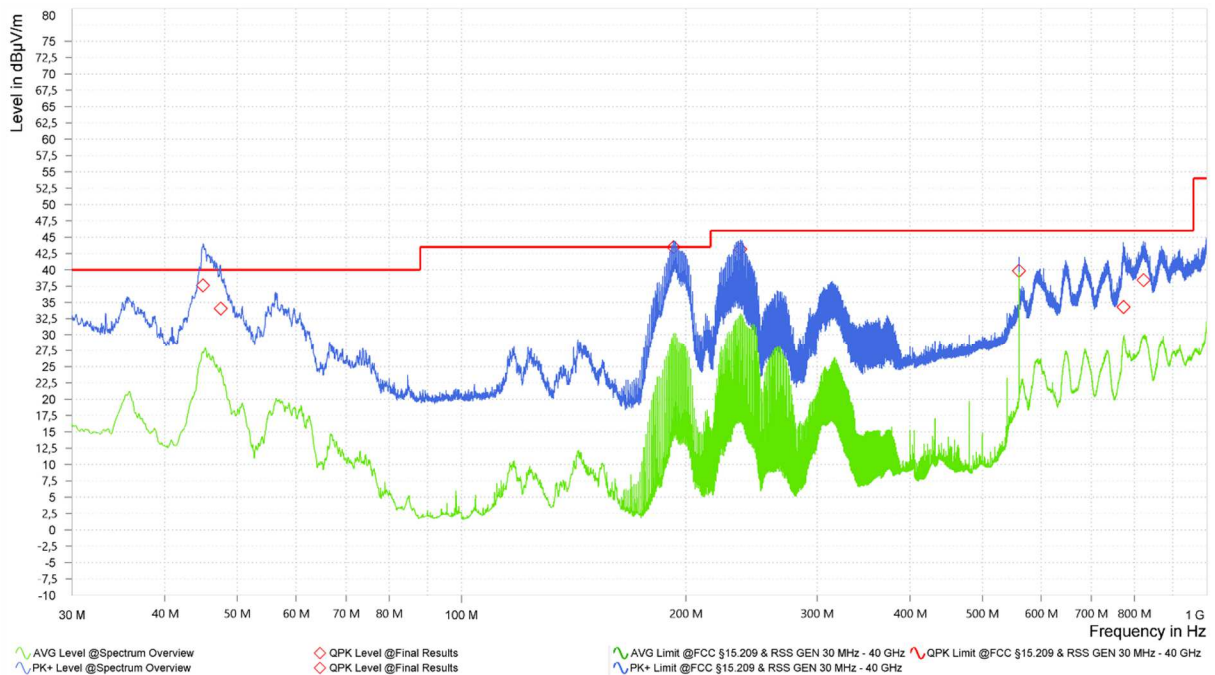

The results of the standard subsequent measurement in a semi-anechoic chamber are indicated in the table below. The limits as well as the measured results (levels) refer to the above-mentioned standard while taking account of the specified requirements for a 3 m measuring distance.

Final result limit according to FCC 15.109 Class B

Frequency in MHz	QuasiPeak in dB(µV/m)	Limit in dB(µV/m)	Margin in dB	Meas. Time in ms	Bandwidth in kHz	Height in cm	Pol	Azimuth in deg	Corr. in dB
44.970	37.58	40.00	2.42	1000	120	100	V	74	16.93
47.520	34.04	40.00	5.96	1000	120	100	V	69	15.32
192.600	43.43	43.50	0.07	1000	120	125	H	142	15.17
236.820	43.14	46.00	2.86	1000	120	125	H	105	17.16
559.980	39.85	46.00	6.15	1000	120	100	V	89	25.30
773.310	34.28	46.00	11.72	1000	120	100	H	9	28.42
822.750	38.39	46.00	7.61	1000	120	100	H	-15	29.17

Final result limit according to ICES-003 Issue 7 Class B

Frequency in MHz	QuasiPeak in dB(μ V/m)	Limit in dB(μ V/m)	Margin in dB	Meas. Time in ms	Bandwidth in kHz	Height in cm	Pol	Azimuth in deg	Corr. in dB
44.970	37.58	40.00	2.42	1000	120	100	V	74	16.93
47.520	34.04	40.00	5.96	1000	120	100	V	69	15.32
192.600	43.43	43.50	0.07	1000	120	125	H	142	15.17
236.820	43.14	47.00	3.86	1000	120	125	H	105	17.16
559.980	39.85	47.00	7.15	1000	120	100	V	89	25.30
773.310	34.28	47.00	12.72	1000	120	100	H	9	28.42
822.750	38.39	47.00	8.61	1000	120	100	H	-15	29.17

Test result: Passed

The correction factor was calculated as follows:

Corr. (dB) = cable attenuation (dB) + 6 dB attenuator (dB) + antenna factor (dB)

Therefore. the reading can be calculated as follows:

Reading (dB μ V/m) = result QuasiPeak (dB μ V/m) - Corr. (dB)

Test equipment (please refer to chapter 6 for details)

1 - 9

5.1.3 Test results final measurement above 1 GHz

Ambient temperature:	22 °C
Relative humidity:	36 %

Date:	07-08.06.2022
Tested by:	B. ROHDE

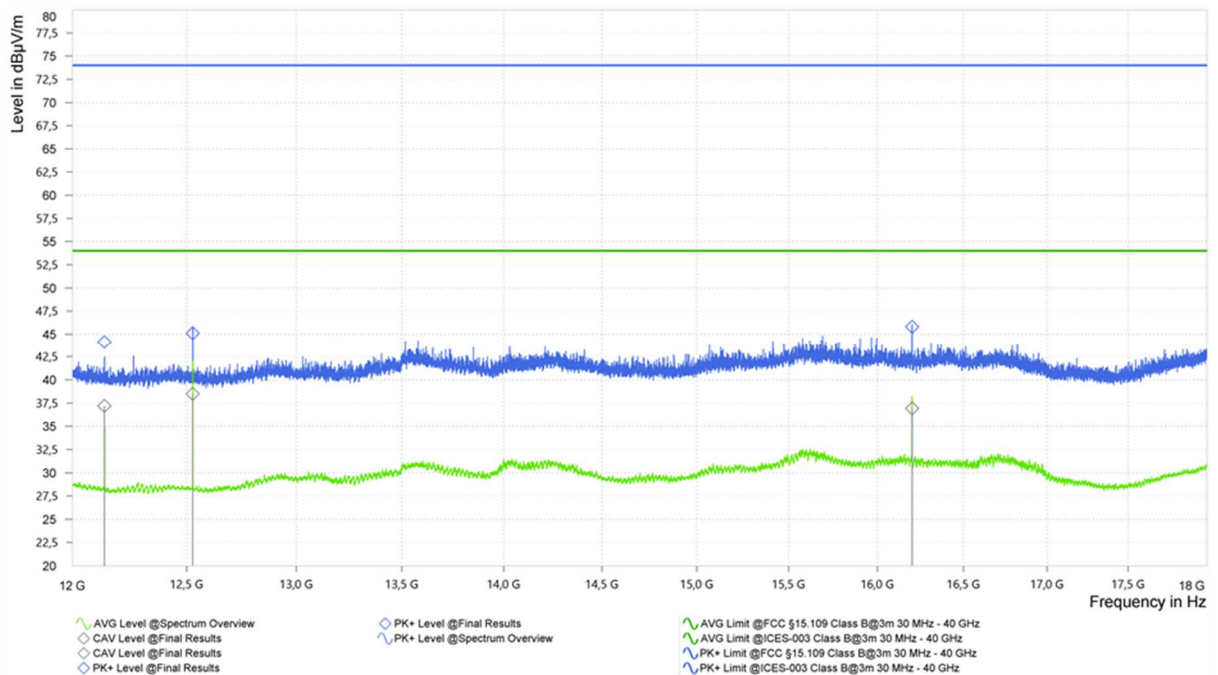
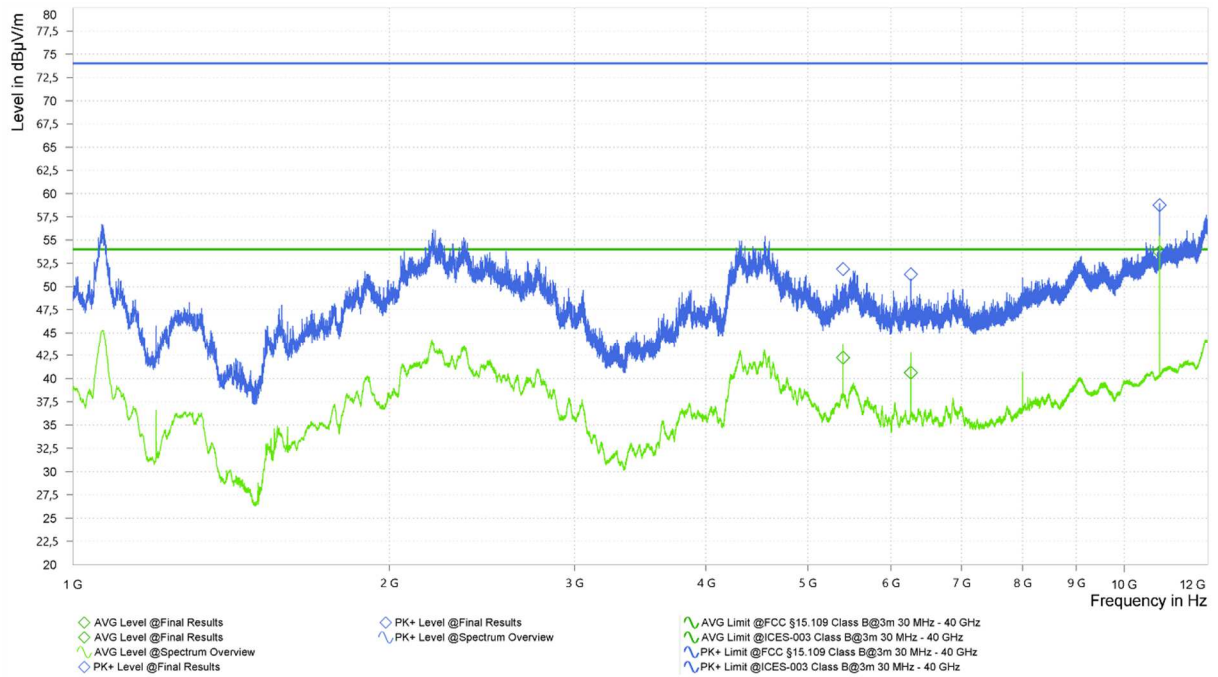

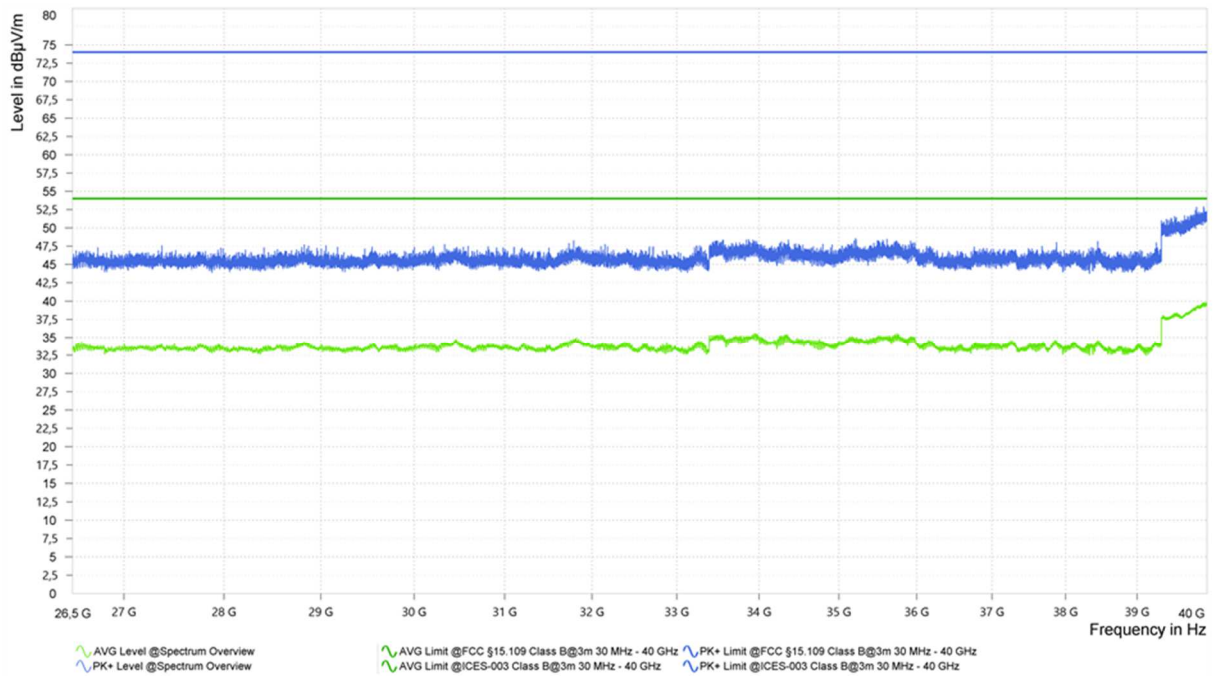
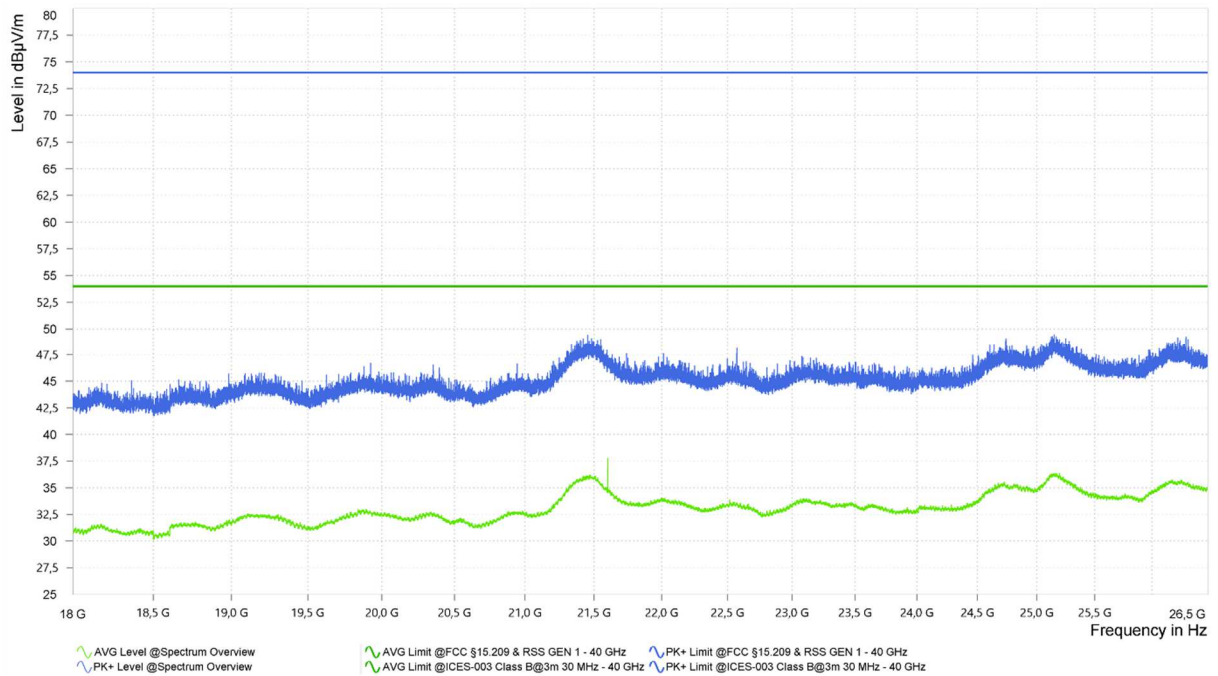

The results of the standard subsequent measurement above 1 GHz in a semi-anechoic chamber are indicated in the table below. The limits as well as the measured results (levels) refer to the above-mentioned standard while taking account of the specified requirements for a 3 m measuring distance.

Frequency [MHz]	PK+ Level [dB μ V/m]	PK+ Limit [dB μ V/m]	PK+ Margin [dB]	AVG Level [dB μ V/m]	AVG Limit [dB μ V/m]	AVG Margin [dB]	Correction [dB/m]	Polarization	Azimuth [deg]	Antenna Height [m]	Meas. BW [kHz]	Meas. Time [ms]
5400.000	51.89	74.0	22.11	42.24	54.0	11.76	11.14	H	360	1.33	1000	100
6264.000	51.30	74.0	22.70	40.61	54.0	13.39	12.43	H	355	1.18	1000	100
10800.000	58.75	74.0	15.25	53.71	54.0	0.29	20.97	H	33	1.18	1000	100
12138.500	44.13	74.0	29.87	37.19	54.0	16.81	6.76	V	195	3.25	1000	100
12527.500	45.11	74.0	28.89	38.50	54.0	15.50	6.82	V	-3	2.22	1000	100
16200.000	45.82	74.0	28.18	36.92	54.0	17.08	8.59	H	322	1.15	1000	100

Test result: Passed

The correction factor was calculated as follows:

Corr. (dB/m) = cable attenuation (dB) + preamplifier (dB) + antenna factor (dB/m)

Therefore, the reading can be calculated as follows:

Reading (dB μ V) = result Peak or Average (dB μ V/m) - Corr. (dB/m)

Test equipment (please refer to chapter 6 for details)

3 - 17

5.2 Conducted emissions at antenna port receiver

5.2.1 Test method

Preliminary and final measurement 30 MHz to 5 GHz

The preliminary and final measurements are performed at the antenna port of receivers that operate (tune) in the frequency range 30 to 960 MHz and CB receivers that provide terminals for the connection of an external receiving antenna.

The resolution bandwidth of the EMI Receiver is set to the following values:

Test	Frequency range	Resolution bandwidth
Preliminary measurement	30 MHz to 1 GHz	100 kHz
Final measurement	30 MHz to 1 GHz	120 kHz
Preliminary measurement	1 - 5 GHz	1 MHz
Final measurement	1 - 5 GHz	1 MHz

Spurious emission limits

Frequency range	Maximum power	Bandwidth
30 MHz to 1 GHz	-57 dBm	120 kHz
1 GHz to 5 GHz	-57 dBm	1 MHz

5.2.2 Test results final measurement 30 MHz to 1 GHz

Ambient temperature:	22 °C
Relative humidity:	35 %

Date:	20.06.2021
Tested by:	M.DINTER

Measurement at FM1/AM antenna port

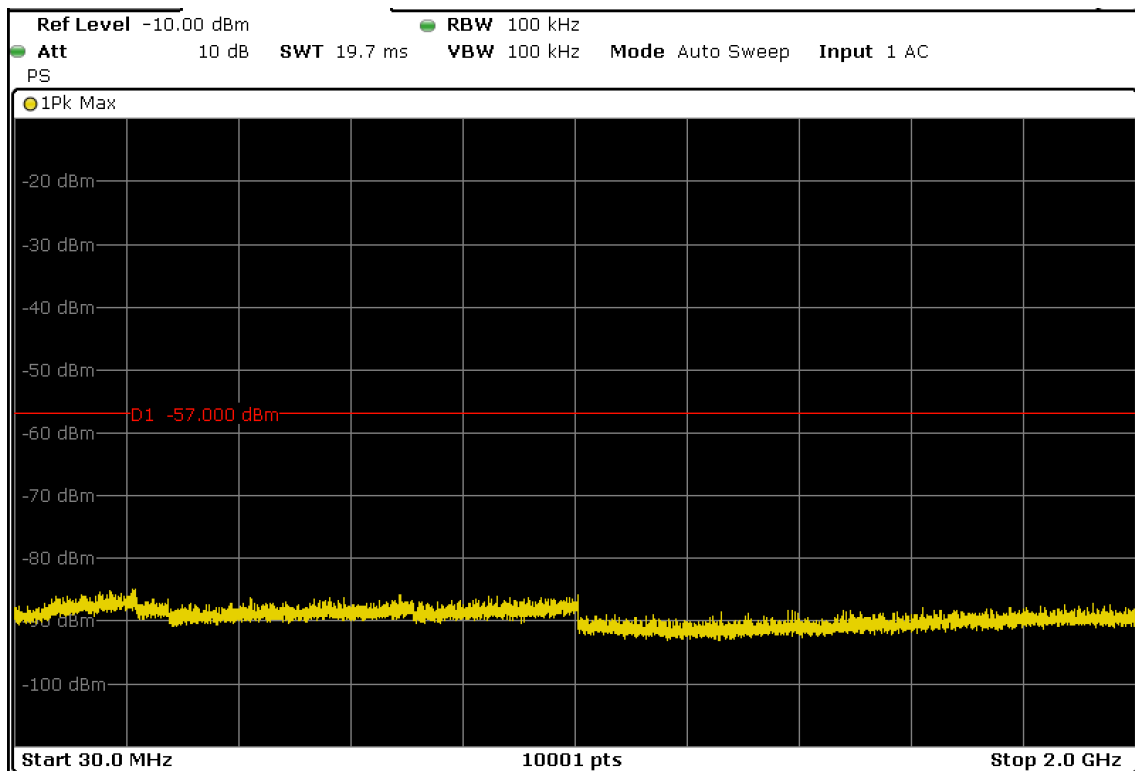

Spurious emissions level				
Frequency [MHz]	Level [dBm]	Limit [dBm]	Margin [dB]	Result
No significant emissions found, all emissions are more than 20 dB below the limit.				

Measurement at DAB/FM2 antenna port

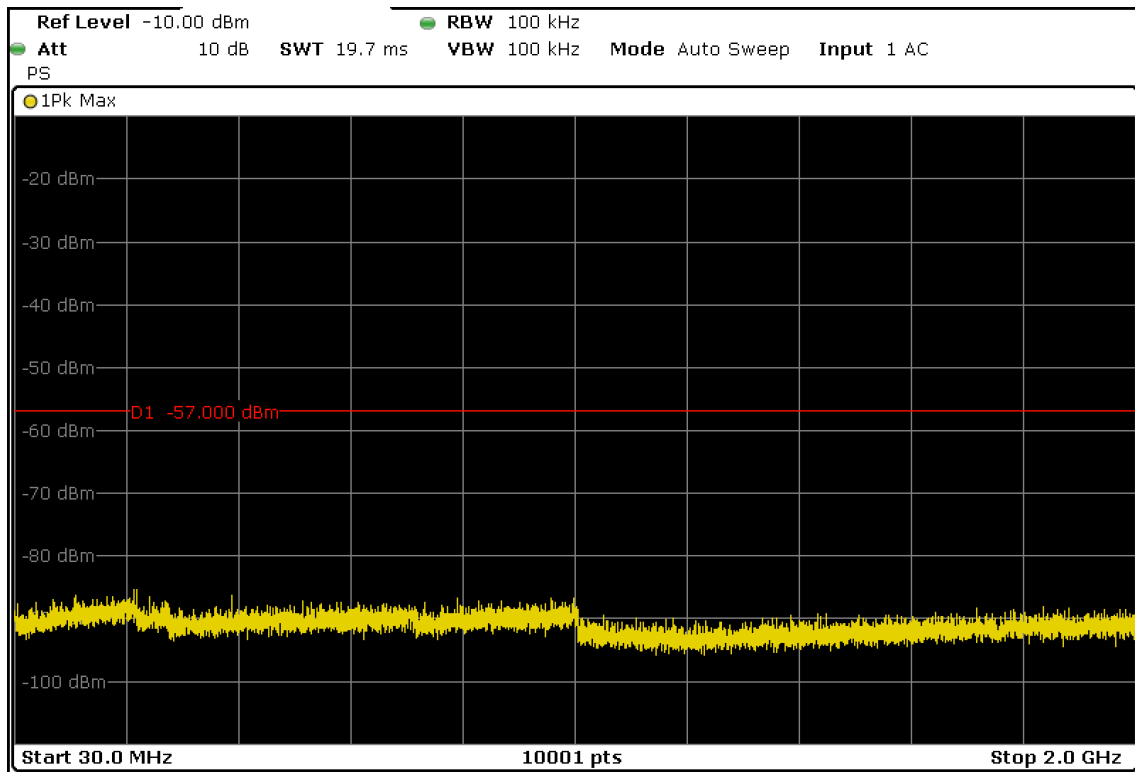

Spurious emissions level				
Frequency [MHz]	Level [dBm]	Limit [dBm]	Margin [dB]	Result
No significant emissions found, all emissions are more than 20 dB below the limit.				

Measurement at SXM antenna port

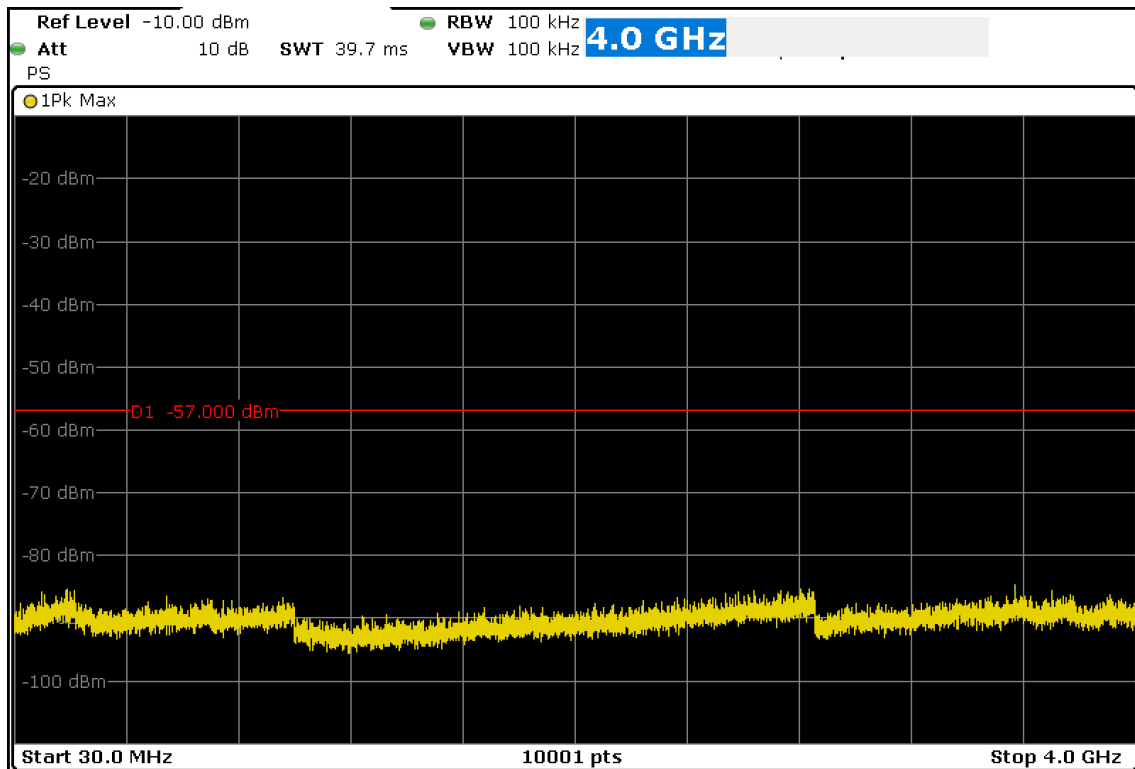

Spurious emissions level				
Frequency [MHz]	Level [dBm]	Limit [dBm]	Margin [dB]	Result
No significant emissions found, all emissions are more than 20 dB below the limit.				

Test result: Passed

Test equipment (please refer to chapter 6 for details)
18 – 19

6 Test Equipment used for Tests

No.	Test equipment	Type	Manufacturer	Serial No.	PM. No.	Cal. Date	Cal Due
1	Attenuator 6 dB	WA2-6	Weinschel	8254	410119	Calibration not necessary	
2	Ultralog Antenna	HL562E	Rohde & Schwarz	101079	482978	18.03.2021	03.2024
3	Software	EMC32	Rohde & Schwarz	100970	482972	Calibration not necessary	
4	RF Switch Matrix	OSP220	Rohde & Schwarz		482976	Calibration not necessary	
5	Turntable	TT3.0-3t	Maturo	825/2612/.01	483224	Calibration not necessary	
6	Antennasupport	BAM 4.5-P-10kg	Maturo	222/2612.01	483225	Calibration not necessary	
7	Controller	NCD	Maturo	474/2612.01	483226	Calibration not necessary	
8	Semi Anechoic Chamber M276	SAC5-2	Albatross Projects	C62128-A540-A138-10-0006	483227	Calibration not necessary	
9	EMI Testreceiver	ESW44	Rohde & Schwarz	101828	482979	08.12.2021	12.2023
10	Low Noise Amplifier 100 MHz - 18 GHz	LNA-30-00101800-25-10P	Narda-Miteq	2110917	482967	18.02.2022	02.2024
11	Low Noise Amplifier 12 GHz - 18 GHz	LNA-30-12001800-13-10P	Narda-Miteq	2089798	482968	Calibration not necessary	
12	Low Noise Amplifier 18 GHz - 26.5 GHz	LNA-30-18002650-20-10P	Narda-Miteq	2110911	482969	18.02.2022	02.2024
13	Low Noise Amplifier 26 MHz - 40 GHz	LNA-30-26004000-27-10P	Narda-Miteq	2110293	482970	18.02.2022	02.2024
14	Log.-Per. antenna	HL050	Rohde & Schwarz	100908	482977	13.08.2019	08.2022
15	Standard Gain Horn 20 dB. 18 GHz -26 GHz	20240-20	Flann	266399	483026	Calibration not necessary	
16	Standard Gain Horn 20 dB. 26 GHz - 40 GHz	22240-20	Flann	266405	483027	Calibration not necessary	
17	Standard Gain Horn 12 GHz - 18 GHz dBi	18240-20	Pro Nova	269813	483215	Calibration not necessary	
18	EMI Testreceiver	ESR7	Rohde & Schwarz	102129	483172	16.02.2022	02.2024
19	DC Block	7003	Weinschel	F6517	480712	Calibration not necessary	

7 Measurement Uncertainties

Conducted measurements		
Measurement method	Standard used for calculating measurement uncertainty	Expanded measurement uncertainty (95 %) U_{lab}
Conducted emissions from 150 kHz to 30 MHz with LISN	CISPR 16-4-2	2.8 dB
Conducted emissions using a spectrum analyzer		
< 3.6 GHz	ETSI TR 100 028	2.3 dB
3.6 – 8 GHz	ETSI TR 100 028	2.8 dB

Radiated measurements		
Radiated field strength M276		
R&S HL562E @ 3 m 30 MHz – 1 GHz	CISPR 16-4-2	4.8 dB
R&S HL050 @ 3 m	-	
1 – 6 GHz	CISPR 16-4-2	5.1 dB
6 – 18 GHz	CISPR 16-4-2	5.4 dB
Flann Standard Gain Horns 18 – 40 GHz	-	5.9 dB

8 Test site Verification

Test equipment	PM. No.	Frequency range	Type of validation	According to	Val. Date	Val Due
Semi anechoic chamber M276	483227	30 – 1000 MHz	NSA/RSM	CISPR 16-1-4 + Cor1:2010 + A1:2012 +A2:2017	03.03.2021	02.03.2023
Semi anechoic chamber M276	483227	1 -18 GHz	SVSWR	CISPR 16-1-4 + Cor1:2010 + A1:2012 +A2:2017	25.02.2021	24.02.2023

9 Report History

Report Number	Date	Comment
F212284E1	20.06.2022	Initial Test Report
F212284E1 2 nd Version	16.08.2022	Updated Software version on page 5 Updated table on page 11 ff.
-	-	-

10 List of Annexes

Annex A Test Setup Photos

7 pages