

FCC Test Report (Part 90 – LTE B26)

Report No.: RFBHKI-WTW-P22030722-3

FCC ID: NKRUMC-STD31BPN

Test Model: UMC-STD31BPN

Received Date: May 05, 2022

Test Date: May 09 ~ May 17, 2022

Issued Date: Jul. 19. 2022

Applicant: Wistron NeWeb Corporation

Address: 20 Park Ave. II, Hsinchu Science Park, Hsinchu 308, Taiwan

Issued By: Bureau Veritas Consumer Products Services (H.K.) Ltd., Taoyuan Branch
Lin Kou Laboratories

Lab Address: No. 47-2, 14th Ling, Chia Pau Vil., Lin Kou Dist., New Taipei City, Taiwan

Test Location (1): No. 19, Hwa Ya 2nd Rd., Wen Hwa Vil., Kwei Shan Dist., Taoyuan City
33383, TAIWAN

**FCC Registration /
Designation Number:** 788550 / TW0003

Test Location (2): No. 70, Wenming Rd., Guishan Dist., Taoyuan City 333, Taiwan (R.O.C.)

**FCC Registration /
Designation Number:** 281270 / TW0032



This report is governed by, and incorporates by reference, the Conditions of Testing as posted at the date of issuance of this report at <http://www.bureauveritas.com/home/about-us/our-business/cps/about-us/terms-conditions/> and is intended for your exclusive use. Any copying or replication of this report to or for any other person or entity, or use of our name or trademark, is permitted only with our prior written permission. This report sets forth our findings solely with respect to the test samples identified herein. The results set forth in this report are not indicative or representative of the quality or characteristics of the lot from which a test sample was taken or any similar or identical product unless specifically and expressly noted. Our report includes all of the tests requested by you and the results thereof based upon the information that you provided to us. Measurement uncertainty is only provided upon request for accredited tests. Statements of conformity are based on simple acceptance criteria without taking measurement uncertainty into account, unless otherwise requested in writing. You have 60 days from date of issuance of this report to notify us of any material error or omission caused by our negligence or if you require measurement uncertainty; provided, however, that such notice shall be in writing and shall specifically address the issue you wish to raise. A failure to raise such issue within the prescribed time shall constitute your unqualified acceptance of the completeness of this report, the tests conducted and the correctness of the report contents.

Table of Contents

Release Control Record	3
1 Certificate of Conformity	4
2 Summary of Test Results	5
2.1 Measurement Uncertainty.....	5
2.2 Test Site and Instruments.....	6
3 General Information	7
3.1 General Description of EUT.....	7
3.2 Configuration of System under Test.....	8
3.2.1 Description of Support Units.....	8
3.3 Test Mode Applicability and Tested Channel Detail.....	9
3.4 EUT Operating Conditions.....	11
3.5 General Description of Applied Standards and References.....	11
4 Test Types and Results	12
4.1 Output Power Measurement.....	12
4.1.1 Limits of Output Power Measurement.....	12
4.1.2 Test Procedures.....	12
4.1.3 Test Setup.....	12
4.1.4 Test Results.....	13
4.2 Modulation Characteristics Measurement.....	21
4.2.1 Limits of Modulation Characteristics.....	21
4.2.2 Test Procedure.....	21
4.2.3 Test Setup.....	21
4.2.4 Test Results.....	22
4.3 Frequency Stability Measurement.....	23
4.3.1 Limits of Frequency Stability Measurement.....	23
4.3.2 Test Procedure.....	23
4.3.3 Test Setup.....	23
4.3.4 Test Results.....	24
4.4 Occupied Bandwidth Measurement.....	28
4.4.1 Limits of Occupied Bandwidth Measurement.....	28
4.4.2 Test Procedure.....	28
4.4.3 Test Setup.....	28
4.4.4 Test Result.....	29
4.5 Emission Mask Measurement.....	33
4.5.1 Limits of Emission Mask Measurement.....	33
4.5.2 Test Setup.....	33
4.5.3 Test Procedures.....	33
4.5.4 Test Results.....	34
4.6 Conducted Spurious Emissions.....	44
4.6.1 Limits of Conducted Spurious Emissions Measurement.....	44
4.6.2 Test Setup.....	44
4.6.3 Test Procedure.....	44
4.6.4 Test Results.....	45
4.7 Radiated Emission Measurement.....	49
4.7.1 Limits of Radiated Emission Measurement.....	49
4.7.2 Test Procedure.....	49
4.7.3 Deviation from Test Standard.....	49
4.7.4 Test Setup.....	50
4.7.5 Test Results.....	51
5 Pictures of Test Arrangements	58
Appendix – Information of the Testing Laboratories	59

Release Control Record

Issue No.	Description	Date Issued
RFBHKI-WTW-P22030722-3	Original release	Jul. 19. 2022

1 Certificate of Conformity

Product: Cellular module

Brand: WNC

Test Model: UMC-STD31BPN

Sample Status: Engineering sample

Applicant: Wistron NeWeb Corporation

Test Date: May 09 ~ May 17, 2022

Standards: FCC Part 90, Subpart I, S

The above equipment has been tested by **Bureau Veritas Consumer Products Services (H.K.) Ltd., Taoyuan Branch**, and found compliance with the requirement of the above standards. The test record, data evaluation & Equipment Under Test (EUT) configurations represented herein are true and accurate accounts of the measurements of the sample's RF characteristics under the conditions specified in this report.

Prepared by : Celine Chou , **Date:** Jul. 19. 2022
Celine Chou / Senior Specialist

Approved by : Jeremy Lin , **Date:** Jul. 19. 2022
Jeremy Lin / Project Engineer

2 Summary of Test Results

Applied Standard: FCC Part 90 & Part 2			
FCC Clause	Test Item	Result	Remarks
2.1046 90.635 (b)	Effective Radiated Power	Pass	Meet the requirement of limit.
2.1047	Modulation Characteristics	Pass	Meet the requirement of limit.
2.1055 90.213	Frequency Stability	Pass	Meet the requirement of limit.
2.1049 90.209	Occupied Bandwidth	Pass	Meet the requirement of limit.
90.691	Emission Mask	Pass	Meet the requirement of limit.
2.1051 90.691	Conducted Spurious Emissions	Pass	Meet the requirement of limit.
2.1053 90.691	Radiated Spurious Emissions	Pass	Meet the requirement of limit. Minimum passing margin is -32.70dB at 33.88MHz.

Note: Determining compliance based on the results of the compliance measurement, not taking into account measurement instrumentation uncertainty.

2.1 Measurement Uncertainty

Where relevant, the following measurement uncertainty levels have been estimated for tests performed on the EUT as specified in CISPR 16-4-2:

Measurement	Frequency	Expanded Uncertainty (k=2) (\pm)
Radiated Emissions up to 1 GHz	9kHz ~ 30MHz	3.00 dB
	30MHz ~ 200MHz	2.91 dB
	200MHz ~ 1000MHz	2.92 dB
Radiated Emissions above 1 GHz	1GHz ~ 18GHz	1.76 dB
	18GHz ~ 40GHz	1.77 dB

2.2 Test Site and Instruments

Description & Manufacturer	Model No.	Serial No.	Cal. Date	Cal. Due
Test Receiver KEYSIGHT	N9038B	MY60180018	Feb. 18, 2022	Feb. 17, 2023
Spectrum Analyzer KEYSIGHT	N9020B	MY60110462	Dec. 21, 2021	Dec. 20, 2022
BILOG Antenna SCHWARZBECK	VULB9168	9168-995	Oct. 28, 2021	Oct. 27, 2022
HORN Antenna RF SPIN	DRH18-E	210104A18E	Nov. 14, 2021	Nov. 13, 2022
HORN Antenna SCHWARZBECK	BBHA 9170	9170-995	Nov. 14, 2021	Nov. 13, 2022
Loop Antenna TESEQ	HLA 6121	45745	Jul. 21, 2021	Jul. 20, 2022
Preamplifier EMCI	EMC330N	980783	Jan. 17, 2022	Jan. 16, 2023
Preamplifier EMCI	EMC118A45SE	980810	Dec. 30, 2021	Dec. 29, 2022
Preamplifier EMCI	EMC184045SE	980787	Jan. 17, 2022	Jan. 16, 2023
RF signal cable EMCI	EMC104-SM-SM-(9000+2000+1000)	201230+ 201242+ 210101	Jan. 17, 2022	Jan. 16, 2023
RF signal cable EMCI	EMCCFD400-NM-NM-(9000+300+500)	201252+ 201250+ 201245	Jan. 17, 2022	Jan. 16, 2023
RF signal cable EMCI	EMC101G-KM-KM-(5000+3000+2000)	201259+201256+201253	Jan. 17, 2022	Jan. 16, 2023
Software BV CPS	ADT_Radiated_V7.6.15.9.5	NA	NA	NA
Turn Table Max-Full	MFT-151SS-0.5T	NA	NA	NA
Turn Table Controller Max-Full	MF-7802BS	MF780208675	NA	NA
Antenna Tower KaiTuo	NA	NA	NA	NA
Antenna Tower Controller KaiTuo	KT-2000	NA	NA	NA
Temperature & Humidity Chamber TERCHY	HRM-120RF	931022	Jan. 03, 2022	Jan. 02, 2023
True RMS Clamp Meter Fluke	325	31130711WS	Jun. 02, 2021	Jun. 01, 2022
DC power supply Keysight	U8002A	MY56330015	NA	NA
Radio Communication Analyzer Anritsu	MT8821C	6272278310	Jun. 23, 2021	Jun. 22, 2022
Universal Radio Communication Tester R&S	CMU200	101095	Nov. 18, 2021	Nov. 17, 2022

Note: 1. The calibration interval of the above test instruments is 12 months and the calibrations are traceable to NML/ROC and NIST/USA.
2. The test was performed in WM Chamber 7.

3 General Information

3.1 General Description of EUT

Product	Cellular module			
Brand	WNC			
Test Model	UMC-STD31BPN			
Sample Status	Engineering sample			
Power Supply Rating	4.0Vdc			
Modulation Type	QPSK, 16QAM, 64QAM			
Operating Frequency	LTE Band 26 (Channel Bandwidth 1.4MHz)	814.7MHz ~ 823.3MHz		
	LTE Band 26 (Channel Bandwidth 3MHz)	815.5MHz ~ 822.5MHz		
	LTE Band 26 (Channel Bandwidth 5MHz)	816.5MHz ~ 821.5MHz		
	LTE Band 26 (Channel Bandwidth 10MHz)	819.0MHz		
Max. ERP Power		QPSK	16QAM	64QAM
	LTE Band 26 (Channel Bandwidth 1.4MHz)	181.552mW (22.59dBm)	145.546mW (21.63dBm)	106.414mW (20.27dBm)
	LTE Band 26 (Channel Bandwidth 3MHz)	181.134mW (22.58dBm)	143.880mW (21.58dBm)	108.893mW (20.37dBm)
	LTE Band 26 (Channel Bandwidth 5MHz)	181.970mW (22.60dBm)	144.877mW (21.61dBm)	108.143mW (20.34dBm)
	LTE Band 26 (Channel Bandwidth 10MHz)	178.649mW (22.52dBm)	140.605mW (21.48dBm)	106.414mW (20.27dBm)
Emission Designator		QPSK	16QAM	64QAM
	LTE Band 26 (Channel Bandwidth 1.4MHz)	1M09G7D	1M09D7W	1M09D7W
	LTE Band 26 (Channel Bandwidth 3MHz)	2M69G7D	2M69D7W	2M69D7W
	LTE Band 26 (Channel Bandwidth 5MHz)	4M50G7D	4M49D7W	4M50D7W
	LTE Band 26 (Channel Bandwidth 10MHz)	8M98G7D	8M98D7W	8M99D7W
Antenna Type	Refer to note			
Antenna Connector	Refer to note			
Accessory Device	NA			
Cable Supplied	NA			

Note: The antenna information is listed as below. (For support unit only)

Type	Connector	Gain (dBi)											
		GSM 850	GSM 1900	LTE B2	LTE B4	LTE B5	LTE B7	LTE B12	LTE B17	LTE B25	LTE B26	LTE B66	LTE B71
Dipole	SMA	1.82	1.80	1.80	1.57	1.82	2.15	2.02	2.02	1.80	1.82	1.57	2.02

* The above Antenna information is declared by manufacturer and for more detailed features description, please refer to the manufacturer's specifications, the laboratory shall not be held responsible.

3.2 Configuration of System under Test

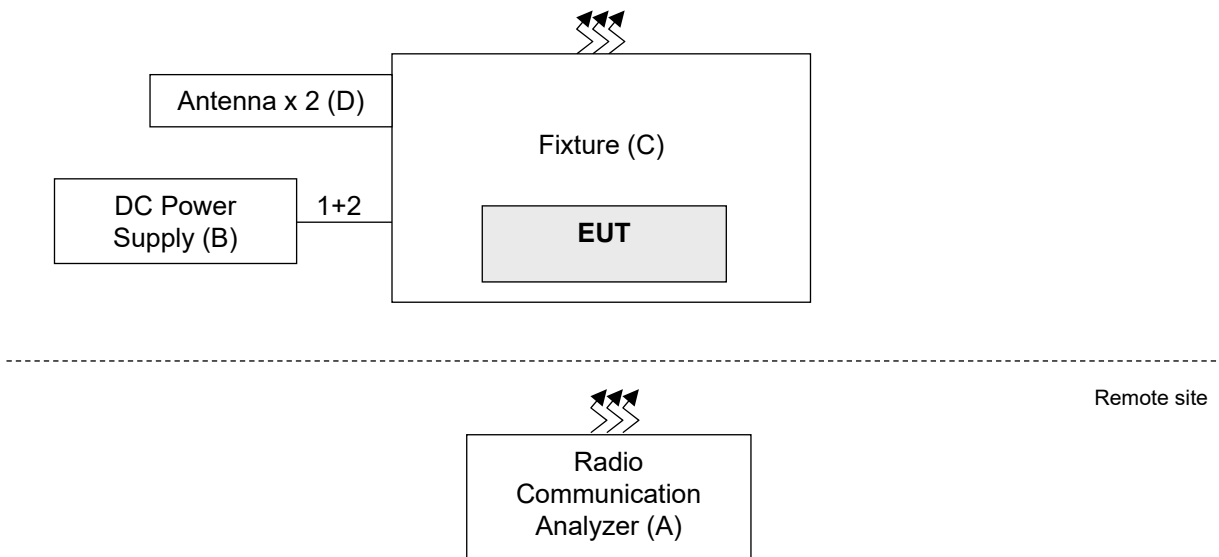

3.2.1 Description of Support Units

The EUT has been tested as an independent unit together with other necessary accessories or support units. The following support units or accessories were used to form a representative test configuration during the tests.

ID	Product	Brand	Model No.	Serial No.	FCC ID	Remarks
A.	Radio Communication Analyzer	Anritsu	MT8821C	6272278310	NA	-
B.	DC Power Supply	JIN YIH Technology	SP3051	SP30512113422	NA	-
C.	Fixture	NA	NA	NA	NA	Provided by manufacturer
D.	Antenna x 2	WNC	RF21S00802A	NA	NA	Provided by manufacturer

Note:

1. All power cords of the above support units are non-shielded (1.8m).
2. Item A acted as a communication partner to transfer data.

ID	Descriptions	Qty.	Length (m)	Shielding (Yes/No)	Cores (Qty.)	Remarks
1.	DC Power Cable	1	1.8	N	0	-
2.	DC Cable	1	0.12	N	0	-

3.3 Test Mode Applicability and Tested Channel Detail

Pre-Scan has been conducted to determine the worst-case mode from all possible combinations between available modulations, data rates, XYZ axis and antenna ports. The worst case was found when positioned as the table below. Following channel(s) was (were) selected for the final test as listed below:

Band	Radiated Emission
LTE Band 26	X-plane

LTE Band 26

EUT Configure Mode	Test item	Available channel	Tested channel	Channel Bandwidth	Modulation	RB #
-	ERP	26697 to 26783	26697 (814.7MHz), 26740 (819.0MHz), 26783 (823.3MHz)	1.4MHz	QPSK / 16QAM / 64QAM	1 Half Full
		26705 to 26775	26705 (815.5MHz), 26740 (819.0MHz), 26775 (822.5MHz)	3MHz	QPSK / 16QAM / 64QAM	1 Half Full
		26715 to 26765	26715 (816.5MHz), 26740 (819.0MHz), 26765 (821.5MHz)	5MHz	QPSK / 16QAM / 64QAM	1 Half Full
		26740	26740 (819.0MHz)	10MHz	QPSK / 16QAM / 64QAM	1 Half Full
-	Modulation Characteristics	26740	26740 (819.0MHz)	10MHz	QPSK / 16QAM / 64QAM	Full
-	Frequency Stability	26697 to 26783	26697 (814.7MHz), 26783 (823.3MHz)	1.4MHz	QPSK	Full
		26705 to 26775	26705 (815.5MHz), 26775 (822.5MHz)	3MHz	QPSK	Full
		26715 to 26765	26715 (816.5MHz), 26765 (821.5MHz)	5MHz	QPSK	Full
		26740	26740 (819.0MHz)	10MHz	QPSK	Full
-	Occupied Bandwidth	26697 to 26783	26697 (814.7MHz), 26740 (819.0MHz), 26783 (823.3MHz)	1.4MHz	QPSK / 16QAM / 64QAM	Full
		26705 to 26775	26705 (815.5MHz), 26740 (819.0MHz), 26775 (822.5MHz)	3MHz	QPSK / 16QAM / 64QAM	Full
		26715 to 26765	26715 (816.5MHz), 26740 (819.0MHz), 26765 (821.5MHz)	5MHz	QPSK / 16QAM / 64QAM	Full
		26740	26740 (819.0MHz)	10MHz	QPSK / 16QAM / 64QAM	Full

EUT Configure Mode	Test item	Available channel	Tested channel	Channel Bandwidth	Modulation	RB #
-	Emission Masks	26697 to 26783	26697 (814.7MHz), 26783 (823.3MHz)	1.4MHz	QPSK	1 Half Full
		26705 to 26775	26705 (815.5MHz), 26775 (822.5MHz)	3MHz	QPSK	1 Half Full
		26715 to 26765	26715 (816.5MHz), 26765 (821.5MHz)	5MHz	QPSK	1 Half Full
		26740	26740 (819.0MHz)	10MHz	QPSK	1 Half Full
-	Conducted Emission	26697 to 26783	26697 (814.7MHz), 26740 (819.0MHz), 26783 (823.3MHz)	1.4MHz	QPSK	1
		26705 to 26775	26705 (815.5MHz), 26740 (819.0MHz), 26775 (822.5MHz)	3MHz	QPSK	1
		26715 to 26765	26715 (816.5MHz), 26740 (819.0MHz), 26765 (821.5MHz)	5MHz	QPSK	1
		26740	26740 (819.0MHz)	10MHz	QPSK	1
-	Radiated Emission	26697 to 26783	26697 (814.7MHz), 26740 (819.0MHz), 26783 (823.3MHz)	1.4MHz	QPSK	1
		26715 to 26765	26715 (816.5MHz), 26740 (819.0MHz), 26765 (821.5MHz)	5MHz	QPSK	1
		26740	26740 (819.0MHz)	10MHz	QPSK	1

Note:

1. For radiated emission below 1GHz, select the worst radiated emission channel (above 1GHz) for final testing.
2. For radiated emission above 1GHz, according to 3GPP 36.521-1 Section 6.6.3.1.4.1, choose the lowest, 5MHz & highest channel bandwidth for final test.
3. The output power for QPSK, 16QAM and 64QAM, measured value of QPSK is higher than 16QAM, and 64QAM mode. Therefore, only Modulation characteristics, occupied bandwidth and Peak to average ratio items had been tested under QPSK, 16QAM and 64QAM modes, the other test items were performed under worse mode according to the maximum output power.

Test Condition:

Test Item	Environmental Conditions	Input Power	Tested By
ERP	25deg. C, 60%RH	4.0Vdc	Noah Chang
Modulation characteristics	25deg. C, 60%RH	4.0Vdc	Noah Chang
Frequency Stability	25deg. C, 60%RH	4.0Vdc	Noah Chang
Occupied Bandwidth	25deg. C, 60%RH	4.0Vdc	Noah Chang
Emission Mask	25deg. C, 60%RH	4.0Vdc	Noah Chang
Conducted Emission	25deg. C, 60%RH	4.0Vdc	Noah Chang
Radiated Emission	23deg. C, 72%RH	4.0Vdc	Edison Lee

3.4 EUT Operating Conditions

The EUT makes a call to the communication simulator. The communication simulator station system controlled a EUT to export maximum output power under transmission mode and specific channel frequency

3.5 General Description of Applied Standards and References

The EUT is a RF Product. According to the specifications of the manufacturer, it must comply with the requirements of the following standards:

Test Standard:

FCC 47 CFR Part 2

FCC 47 CFR Part 90

ANSI/TIA/EIA-603-E 2016

ANSI 63.26-2015

All test items have been performed and recorded as per the above standards.

References Test Guidance:

KDB 971168 D01 Power Meas License Digital Systems v03r01

KDB 971168 D02 Misc Rev Approv License Devices v02r01

All test items have been performed as a reference to the above KDB test guidance.

4 Test Types and Results

4.1 Output Power Measurement

4.1.1 Limits of Output Power Measurement

The output power shall be according to the specific rule Part 90.635 that “Mobile station are limited to 100 watts e.r.p”.

4.1.2 Test Procedures

Conducted Power Measurement:

The EUT was set up for the maximum power with LTE link data modulation and link up with simulator. Set the EUT to transmit under low, middle and high channel and record the power level shown on simulator.

Maximum EIRP / ERP

The relevant equation for determining the maximum ERP or EIRP from the measured RF output power is given in Equation as follows:

$$\text{EIRP} = P_{\text{Meas}} + G_{\text{T}}$$

$$\text{ERP} = P_{\text{Meas}} + G_{\text{T}} - 2.15$$

where

ERP or EIRP effective radiated power or equivalent isotropically radiated power, respectively
(expressed in the same units as P_{Meas} , e.g., dBm or dBW)

P_{Meas} measured transmitter output power or PSD, in dBm or dBW

G_{T} gain of the transmitting antenna, in dBd (ERP) or dBi (EIRP)

4.1.3 Test Setup

Conducted Power Measurement:



4.1.4 Test Results

Conducted Output Power (dBm)

LTE Band 26				
BW	MCS Index	RB Size	RB Offset	Mid
		Channel		26740
		Frequency (MHz)		819
10M	QPSK	1	0	22.85
		1	24	22.78
		1	49	22.40
		25	0	21.72
		25	12	21.66
		25	25	21.79
		50	0	21.77
10M	16QAM	1	0	21.81
		1	24	21.74
		1	49	21.43
		25	0	20.80
		25	12	20.61
		25	25	20.83
		50	0	20.85
10M	64QAM	1	0	20.60
		1	24	20.50
		1	49	20.08
		25	0	19.50
		25	12	19.29
		25	25	19.44
		50	0	19.62

LTE Band 26						
BW	MCS Index	RB Size	RB Offset	Low	Mid	High
		Channel		26715	26740	26765
		Frequency (MHz)		816.5	819	821.5
5M	QPSK	1	0	22.72	22.79	22.85
		1	12	22.74	22.93	22.89
		1	24	22.37	22.39	22.38
		12	0	21.72	21.79	21.73
		12	6	21.76	21.68	21.78
		12	13	21.77	21.63	21.67
		25	0	21.85	21.71	21.73
5M	16QAM	1	0	21.68	21.78	21.90
		1	12	21.83	21.94	21.82
		1	24	21.27	21.46	21.40
		12	0	20.74	20.88	20.70
		12	6	20.78	20.76	20.87
		12	13	20.76	20.64	20.69
		25	0	20.78	20.63	20.83
5M	64QAM	1	0	20.44	20.57	20.63
		1	12	20.56	20.67	20.58
		1	24	20.05	20.20	20.02
		12	0	19.38	19.65	19.37
		12	6	19.43	19.44	19.50
		12	13	19.47	19.27	19.36
		25	0	19.53	19.38	19.46

LTE Band 26						
BW	MCS Index	RB Size	RB Offset	Low	Mid	High
		Channel		26705	26740	26775
		Frequency (MHz)		815.5	819	822.5
3M	QPSK	1	0	22.83	22.72	22.78
		1	7	22.91	22.77	22.87
		1	14	22.40	22.30	22.35
		8	0	21.86	21.81	21.69
		8	3	21.58	21.72	21.70
		8	7	21.67	21.65	21.70
		15	0	21.74	21.91	21.92
3M	16QAM	1	0	21.91	21.69	21.82
		1	7	21.84	21.79	21.81
		1	14	21.36	21.34	21.34
		8	0	20.86	20.80	20.76
		8	3	20.67	20.65	20.74
		8	7	20.63	20.60	20.69
		15	0	20.74	20.87	20.97
3M	64QAM	1	0	20.70	20.41	20.49
		1	7	20.58	20.51	20.56
		1	14	20.10	20.06	20.09
		8	0	19.56	19.54	19.45
		8	3	19.35	19.27	19.35
		8	7	19.35	19.34	19.36
		15	0	19.47	19.65	19.67

LTE Band 26						
BW	MCS Index	RB Size	RB Offset	Low	Mid	High
		Channel		26697	26740	26783
		Frequency (MHz)		814.7	819	823.3
1.4M	QPSK	1	0	22.79	22.81	22.73
		1	2	22.92	22.73	22.75
		1	5	22.48	22.38	22.42
		3	0	22.58	22.76	22.79
		3	1	22.51	22.53	22.58
		3	3	22.47	22.61	22.59
		6	0	21.87	21.85	21.79
1.4M	16QAM	1	0	21.73	21.74	21.70
		1	2	21.96	21.69	21.73
		1	5	21.39	21.30	21.47
		3	0	21.58	21.74	21.82
		3	1	21.58	21.44	21.54
		3	3	21.54	21.68	21.58
		6	0	20.80	20.82	20.80
1.4M	64QAM	1	0	20.48	20.45	20.34
		1	2	20.60	20.40	20.50
		1	5	20.05	20.03	20.15
		3	0	20.23	20.41	20.44
		3	1	20.37	20.09	20.18
		3	3	20.15	20.29	20.31
		6	0	19.50	19.60	19.59

ERP Power (dBm)

LTE Band 26				
BW	MCS Index	RB Size	RB Offset	Mid
		Channel		26740
		Frequency (MHz)		819
10M	QPSK	1	0	22.52
		1	24	22.45
		1	49	22.07
		25	0	21.39
		25	12	21.33
		25	25	21.46
		50	0	21.44
10M	16QAM	1	0	21.48
		1	24	21.41
		1	49	21.10
		25	0	20.47
		25	12	20.28
		25	25	20.50
		50	0	20.52
10M	64QAM	1	0	20.27
		1	24	20.17
		1	49	19.75
		25	0	19.17
		25	12	18.96
		25	25	19.11
		50	0	19.29

*ERP = Conducted + antenna gain (1.82dBi) - 2.15

LTE Band 26						
BW	MCS Index	RB Size	RB Offset	Low	Mid	High
		Channel		26715	26740	26765
		Frequency (MHz)		816.5	819	821.5
5M	QPSK	1	0	22.39	22.46	22.52
		1	12	22.41	22.60	22.56
		1	24	22.04	22.06	22.05
		12	0	21.39	21.46	21.40
		12	6	21.43	21.35	21.45
		12	13	21.44	21.30	21.34
		25	0	21.52	21.38	21.40
5M	16QAM	1	0	21.35	21.45	21.57
		1	12	21.50	21.61	21.49
		1	24	20.94	21.13	21.07
		12	0	20.41	20.55	20.37
		12	6	20.45	20.43	20.54
		12	13	20.43	20.31	20.36
		25	0	20.45	20.30	20.50
5M	64QAM	1	0	20.11	20.24	20.30
		1	12	20.23	20.34	20.25
		1	24	19.72	19.87	19.69
		12	0	19.05	19.32	19.04
		12	6	19.10	19.11	19.17
		12	13	19.14	18.94	19.03
		25	0	19.20	19.05	19.13

*ERP = Conducted + antenna gain (1.82dBi) - 2.15

LTE Band 26						
BW	MCS Index	RB Size	RB Offset	Low	Mid	High
		Channel		26705	26740	26775
		Frequency (MHz)		815.5	819	822.5
3M	QPSK	1	0	22.50	22.39	22.45
		1	7	22.58	22.44	22.54
		1	14	22.07	21.97	22.02
		8	0	21.53	21.48	21.36
		8	3	21.25	21.39	21.37
		8	7	21.34	21.32	21.37
		15	0	21.41	21.58	21.59
3M	16QAM	1	0	21.58	21.36	21.49
		1	7	21.51	21.46	21.48
		1	14	21.03	21.01	21.01
		8	0	20.53	20.47	20.43
		8	3	20.34	20.32	20.41
		8	7	20.30	20.27	20.36
		15	0	20.41	20.54	20.64
3M	64QAM	1	0	20.37	20.08	20.16
		1	7	20.25	20.18	20.23
		1	14	19.77	19.73	19.76
		8	0	19.23	19.21	19.12
		8	3	19.02	18.94	19.02
		8	7	19.02	19.01	19.03
		15	0	19.14	19.32	19.34

*ERP = Conducted + antenna gain (1.82dBi) - 2.15

LTE Band 26						
BW	MCS Index	RB Size	RB Offset	Low	Mid	High
		Channel		26697	26740	26783
		Frequency (MHz)		814.7	819	823.3
1.4M	QPSK	1	0	22.46	22.48	22.40
		1	2	22.59	22.40	22.42
		1	5	22.15	22.05	22.09
		3	0	22.25	22.43	22.46
		3	1	22.18	22.20	22.25
		3	3	22.14	22.28	22.26
		6	0	21.54	21.52	21.46
1.4M	16QAM	1	0	21.40	21.41	21.37
		1	2	21.63	21.36	21.40
		1	5	21.06	20.97	21.14
		3	0	21.25	21.41	21.49
		3	1	21.25	21.11	21.21
		3	3	21.21	21.35	21.25
		6	0	20.47	20.49	20.47
1.4M	64QAM	1	0	20.15	20.12	20.01
		1	2	20.27	20.07	20.17
		1	5	19.72	19.70	19.82
		3	0	19.90	20.08	20.11
		3	1	20.04	19.76	19.85
		3	3	19.82	19.96	19.98
		6	0	19.17	19.27	19.26

*ERP = Conducted + antenna gain (1.82dBi) - 2.15

4.2 Modulation Characteristics Measurement

4.2.1 Limits of Modulation Characteristics

N/A

4.2.2 Test Procedure

Connect the EUT to Communication Simulator via the antenna connector, The frequency band is set as EUT supported Modulation and Channels, the EUT output is matched with 50 ohm load, the waveform quality and constellation of the EUT was tested.

4.2.3 Test Setup



4.2.4 Test Results

LTE Band 26

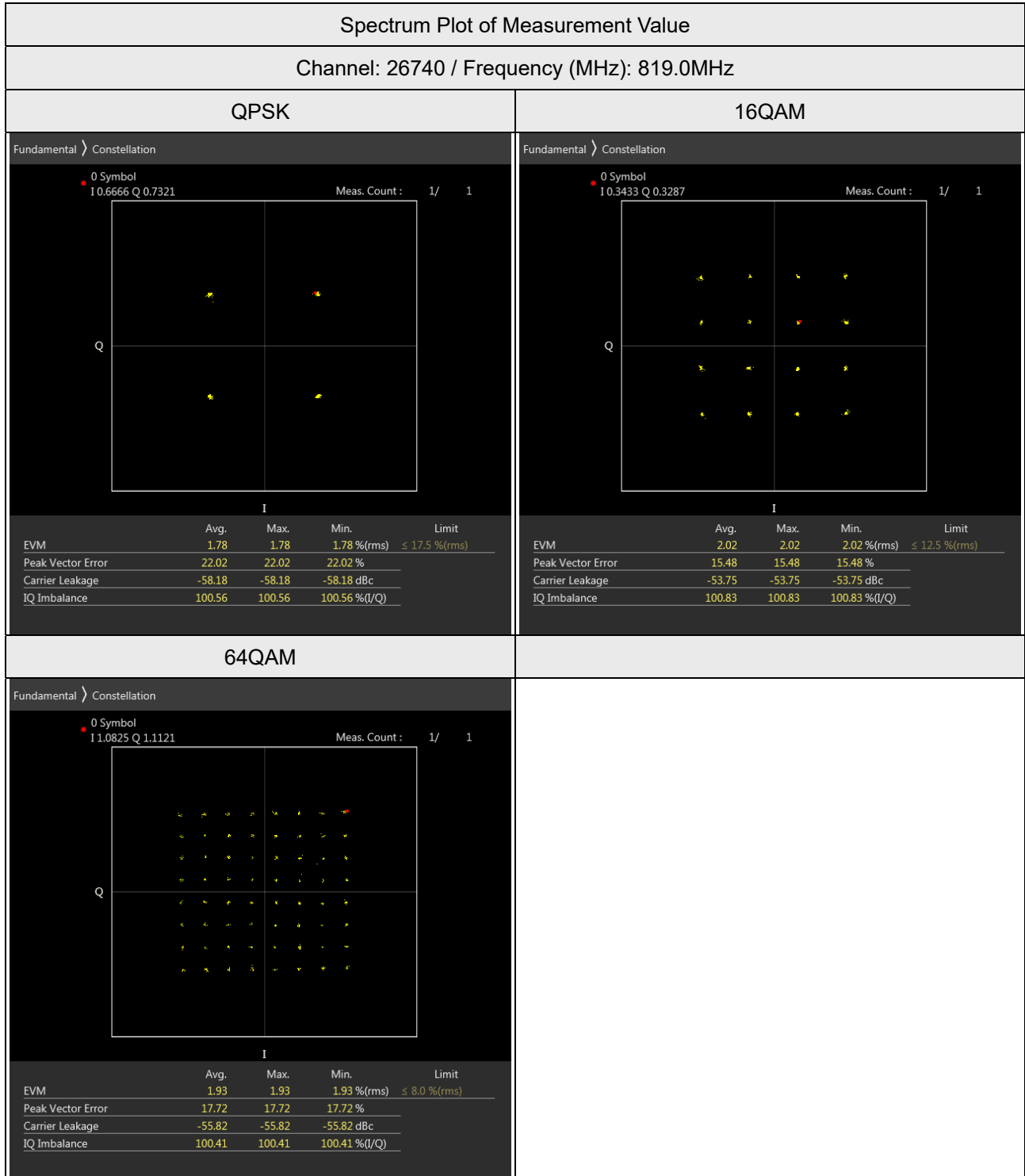

4.3 Frequency Stability Measurement

4.3.1 Limits of Frequency Stability Measurement

1.5 ppm is for base and fixed station. 2.5 ppm is for mobile station.

4.3.2 Test Procedure

- Device is placed at the oven room. The oven room could control the temperatures and humidity. Power warm up is at least 15 min and power applied should perform before recording frequency error.
- EUT is connected the external power supply to control the DC input power. The test voltage range is from minimum to maximum working voltage. Each step shall be record the frequency error rate.
- The temperature range step is 10 degrees in this test items. All temperature levels shall be hold the ± 0.5 °C during the measurement testing. The each temperature step shall be at least 0.5 hours, consider the EUT could be test under the stability condition.

Note: The frequency error was recorded frequency error from the communication simulator.

4.3.3 Test Setup

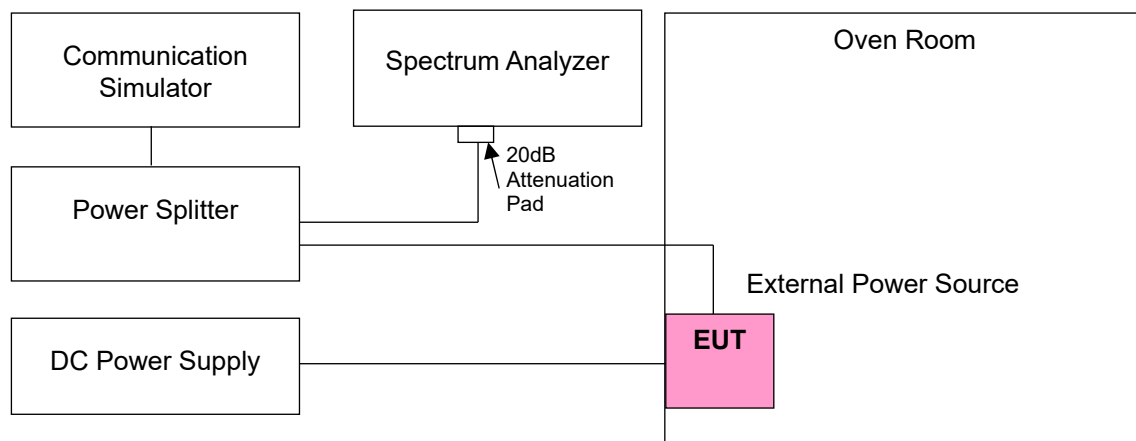

4.3.4 Test Results

Frequency Error vs. Voltage

Voltage (Vdc)	LTE Band 26			
	Channel Bandwidth: 1.4 MHz			
	Low Channel		High Channel	
	Frequency (MHz)	Frequency Error (ppm)	Frequency (MHz)	Frequency Error (ppm)
4.0	814.700004	0.005	823.299996	-0.005
3.4	814.700002	0.002	823.300002	0.002
4.6	814.699999	-0.001	823.300001	0.001

Note: The applicant defined the normal working voltage is from 3.4Vdc to 4.6Vdc.

Frequency Error vs. Temperature

Temp. (°C)	LTE Band 26			
	Channel Bandwidth: 1.4 MHz			
	Low Channel		High Channel	
	Frequency (MHz)	Frequency Error (ppm)	Frequency (MHz)	Frequency Error (ppm)
-40	814.700001	0.001	823.299998	-0.002
-30	814.700001	0.001	823.299997	-0.004
-20	814.699998	-0.002	823.299997	-0.004
-10	814.699998	-0.002	823.300002	0.002
0	814.699995	-0.006	823.300005	0.006
10	814.700004	0.005	823.299998	-0.002
20	814.700002	0.002	823.300002	0.002
30	814.700005	0.006	823.300003	0.004
40	814.699997	-0.004	823.299996	-0.005
50	814.700002	0.002	823.299997	-0.004
60	814.700002	0.002	823.300003	0.004
70	814.699999	-0.001	823.299996	-0.005
80	814.700004	0.005	823.300002	0.002
85	814.699998	-0.002	823.300001	0.001

Frequency Error vs. Voltage

Voltage (Vdc)	LTE Band 26			
	Channel Bandwidth: 3MHz			
	Low Channel		High Channel	
	Frequency (MHz)	Frequency Error (ppm)	Frequency (MHz)	Frequency Error (ppm)
4.0	815.499999	-0.001	822.500002	0.002
3.4	815.499999	-0.001	822.499995	-0.006
4.6	815.499995	-0.006	822.500004	0.005

Note: The applicant defined the normal working voltage is from 3.4Vdc to 4.6Vdc.

Frequency Error vs. Temperature

Temp. (°C)	LTE Band 26			
	Channel Bandwidth: 3MHz			
	Low Channel		High Channel	
	Frequency (MHz)	Frequency Error (ppm)	Frequency (MHz)	Frequency Error (ppm)
-40	815.499997	-0.004	822.499998	-0.002
-30	815.500005	0.006	822.499996	-0.005
-20	815.499999	-0.001	822.499997	-0.004
-10	815.500003	0.004	822.499996	-0.005
0	815.500004	0.005	822.499996	-0.005
10	815.500004	0.005	822.499996	-0.005
20	815.500005	0.006	822.499995	-0.006
30	815.499995	-0.006	822.499996	-0.005
40	815.499999	-0.001	822.499997	-0.004
50	815.500005	0.006	822.500002	0.002
60	815.499997	-0.004	822.500002	0.002
70	815.500004	0.005	822.499997	-0.004
80	815.499995	-0.006	822.500002	0.002
85	815.500001	0.001	822.499999	-0.001

Frequency Error vs. Voltage

Voltage (Vdc)	LTE Band 26			
	Channel Bandwidth: 5MHz			
	Low Channel		High Channel	
	Frequency (MHz)	Frequency Error (ppm)	Frequency (MHz)	Frequency Error (ppm)
4.0	816.500005	0.006	821.499997	-0.004
3.4	816.500005	0.006	821.499995	-0.006
4.6	816.500003	0.004	821.499996	-0.005

Note: The applicant defined the normal working voltage is from 3.4Vdc to 4.6Vdc.

Frequency Error vs. Temperature

Temp. (°C)	LTE Band 26			
	Channel Bandwidth: 5MHz			
	Low Channel		High Channel	
	Frequency (MHz)	Frequency Error (ppm)	Frequency (MHz)	Frequency Error (ppm)
-40	816.500002	0.002	821.500001	0.001
-30	816.500002	0.002	821.499996	-0.005
-20	816.499996	-0.005	821.499999	-0.001
-10	816.500001	0.001	821.500001	0.001
0	816.499998	-0.002	821.500005	0.006
10	816.499997	-0.004	821.500002	0.002
20	816.500005	0.006	821.499997	-0.004
30	816.500003	0.004	821.500003	0.004
40	816.500002	0.002	821.499998	-0.002
50	816.500001	0.001	821.500004	0.005
60	816.499999	-0.001	821.499998	-0.002
70	816.500004	0.005	821.499998	-0.002
80	816.499998	-0.002	821.499999	-0.001
85	816.500005	0.006	821.499999	-0.001

Frequency Error vs. Voltage

Voltage (Vdc)	LTE Band 26	
	Channel Bandwidth: 10 MHz	
	Frequency (MHz)	Frequency Error (ppm)
4.0	818.999996	-0.005
3.4	818.999998	-0.002
4.6	818.999996	-0.005

Note: The applicant defined the normal working voltage is from 3.4Vdc to 4.6Vdc.

Frequency Error vs. Temperature

Temp. (°C)	LTE Band 26	
	Channel Bandwidth: 10 MHz	
	Frequency (MHz)	Frequency Error (ppm)
-40	819.000001	0.001
-30	819.000003	0.004
-20	819.000003	0.004
-10	819.000004	0.005
0	818.999999	-0.001
10	818.999996	-0.005
20	819.000002	0.002
30	819.000003	0.004
40	818.999995	-0.006
50	818.999999	-0.001
60	818.999996	-0.005
70	819.000005	0.006
80	819.000005	0.006
85	819.000003	0.004

4.4 Occupied Bandwidth Measurement

4.4.1 Limits of Occupied Bandwidth Measurement

The width of a frequency band such that, below the lower and above the upper frequency limits, the mean powers emitted are each equal to a specified percentage 0.5 % of the total mean power of a given emission.

4.4.2 Test Procedure

For the 26dBc bandwidth measurement method, please refer to section 5.4.3 of ANSI C63.26.

- The spectrum analyzer center frequency is set to the nominal EUT channel center frequency. The span range for the spectrum analyzer shall be wide enough to see sufficient roll off of the signal to make the measurement.
- The nominal RBW shall be in the range of 1% to 5% of the anticipated OBW, and the VBW shall be set $\geq 3 \times$ RBW.
- Set the reference level of the instrument as required to prevent the signal amplitude from exceeding the maximum spectrum analyzer input mixer level for linear operation. See guidance provided in 4.2.3.
- The dynamic range of the spectrum analyzer at the selected RBW shall be more than 10 dB below the target “-X dB” requirement, i.e., if the requirement calls for measuring the -26 dB OBW, the spectrum analyzer noise floor at the selected RBW shall be at least 36 dB below the reference level.
- Set spectrum analyzer detection mode to peak, and the trace mode to max hold.
- Determine the following reference values: Set the EUT to transmit a modulated signal. Allow the trace to stabilize. Set the spectrum analyzer marker to the highest level of the displayed trace (this is the reference value).
- Determine the “-X dB amplitude” as equal to (Reference Value - X). Alternatively, this calculation can be performed on the spectrum analyzer using the delta-marker measurement function.
- Place two markers, one at the lowest and the other at the highest frequency of the envelope of the spectral display such that each marker is at or slightly below the “-X dB amplitude” determined in step f). If a marker is below this “-X dB amplitude” value it should be as close as possible to this value. The OBW is the positive frequency difference between the two markers.
- The OBW shall be reported by providing plot(s) of the measuring instrument display, to include markers depicting the relevant frequency and amplitude information (e.g., marker table). The frequency and amplitude axis and scale shall be clearly labeled. Tabular data may be reported in addition to the plot(s).

For the occupied bandwidth measurement method, please refer to section 5.4.4 of ANSI C63.26.

4.4.3 Test Setup

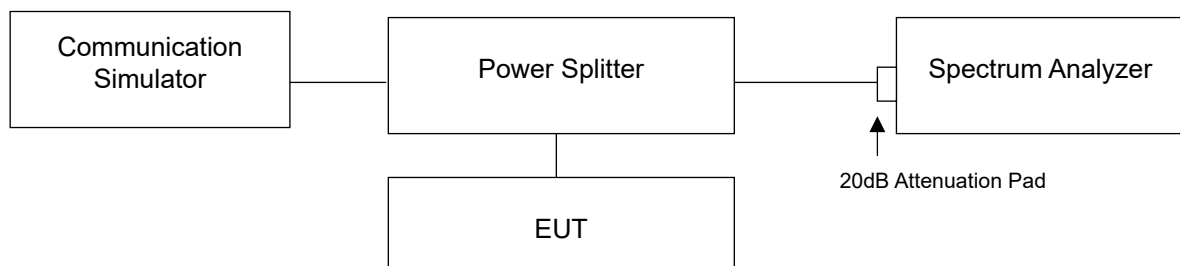

4.4.4 Test Result

LTE Band 26 (Channel Bandwidth 1.4MHz)

Test Condition	Channel	Frequency (MHz)	Occupied bandwidth (MHz)	26dB Bandwidth (MHz)
QPSK	26697	814.7	1.0847	1.252
QPSK	26740	819	1.0899	1.265
QPSK	26783	823.3	1.0905	1.269
16QAM	26697	814.7	1.0874	1.248
16QAM	26740	819	1.0870	1.252
16QAM	26783	823.3	1.0879	1.252
64QAM	26697	814.7	1.0883	1.247
64QAM	26740	819	1.0883	1.249
64QAM	26783	823.3	1.0894	1.255

Spectrum Plot of Worst Value

Occupied bandwidth

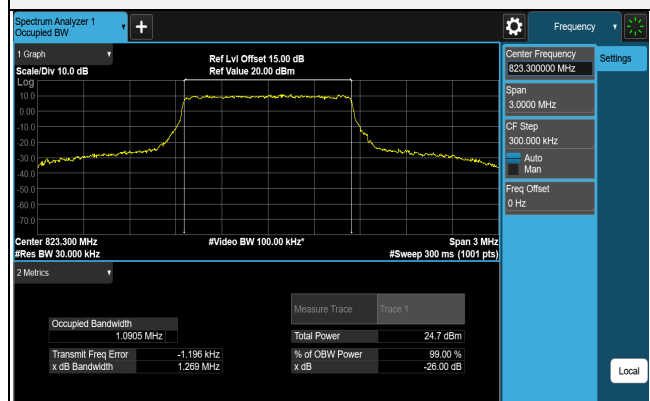

QPSK CH 26783 (823.3MHz)

26dB Bandwidth

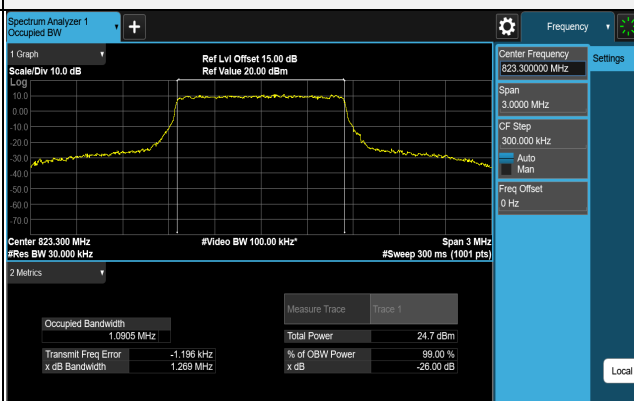

QPSK CH 26783 (823.3MHz)

LTE Band 26 (Channel Bandwidth 3MHz)

Test Condition	Channel	Frequency (MHz)	Occupied bandwidth (MHz)	26dB Bandwidth (MHz)
QPSK	26705	815.5	2.6878	2.869
QPSK	26740	819	2.6921	2.865
QPSK	26775	822.5	2.6916	2.863
16QAM	26705	815.5	2.6903	2.856
16QAM	26740	819	2.6901	2.874
16QAM	26775	822.5	2.6904	2.871
64QAM	26705	815.5	2.6871	2.849
64QAM	26740	819	2.6869	2.862
64QAM	26775	822.5	2.6935	2.863

Spectrum Plot of Worst Value

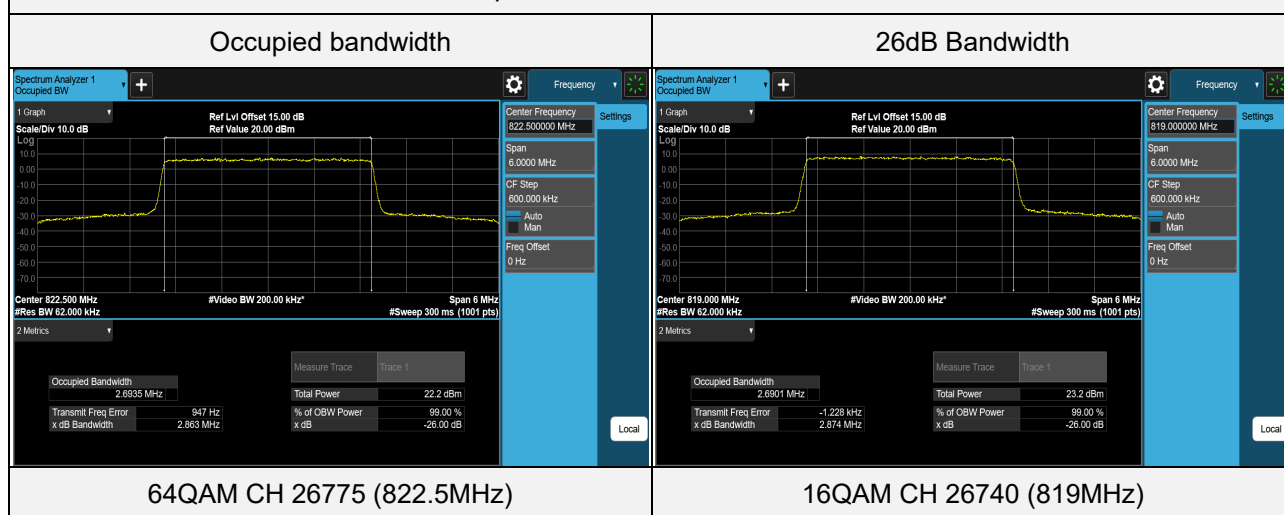

LTE Band 26 (Channel Bandwidth 5MHz)

Test Condition	Channel	Frequency (MHz)	Occupied bandwidth (MHz)	26dB Bandwidth (MHz)
QPSK	26715	816.5	4.4896	4.765
QPSK	26740	819	4.4990	4.791
QPSK	26765	821.5	4.4984	4.791
16QAM	26715	816.5	4.4871	4.768
16QAM	26740	819	4.4939	4.765
16QAM	26765	821.5	4.4938	4.775
64QAM	26715	816.5	4.4894	4.761
64QAM	26740	819	4.4955	4.765
64QAM	26765	821.5	4.4960	4.773

Spectrum Plot of Worst Value

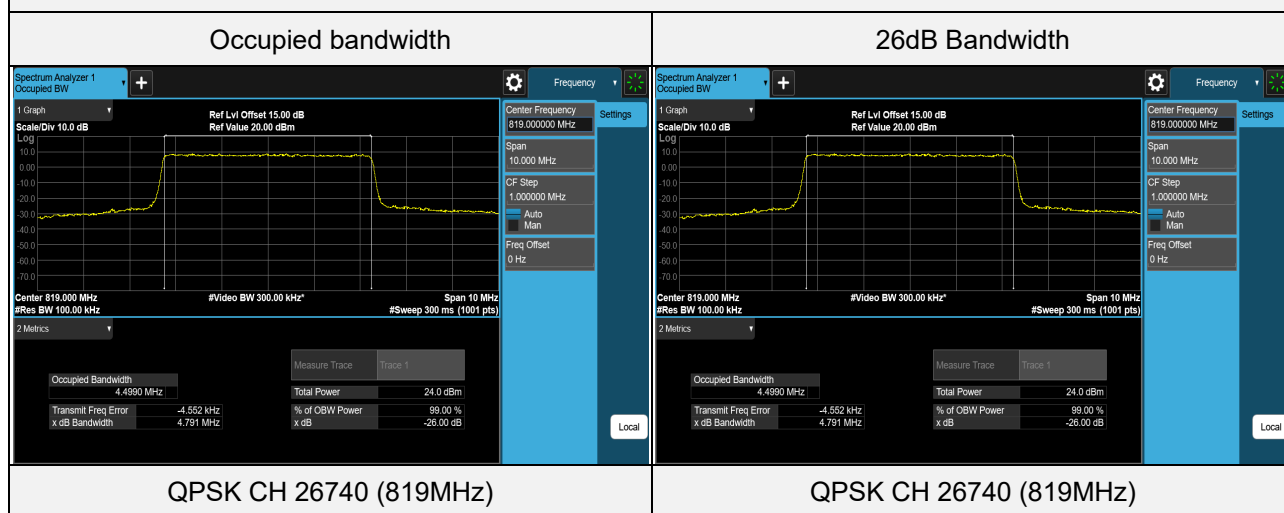

LTE Band 26 (Channel Bandwidth 10MHz)

Test Condition	Channel	Frequency (MHz)	Occupied bandwidth (MHz)	26dB Bandwidth (MHz)
QPSK	26740	819	8.9844	9.498
16QAM	26740	819	8.9849	9.493
64QAM	26740	819	8.9867	9.502

Spectrum Plot of Worst Value

Occupied bandwidth

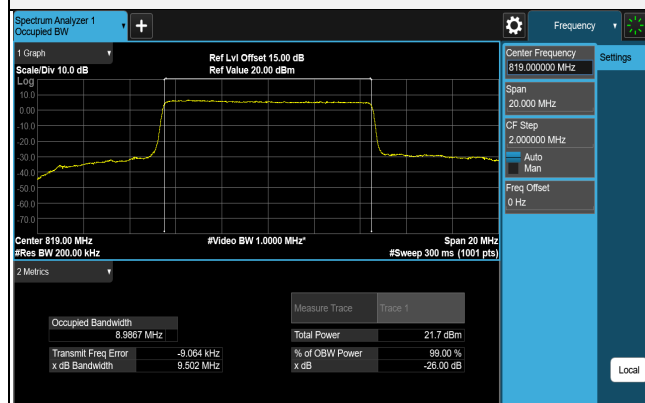

64QAM CH 26740 (819MHz)

26dB Bandwidth

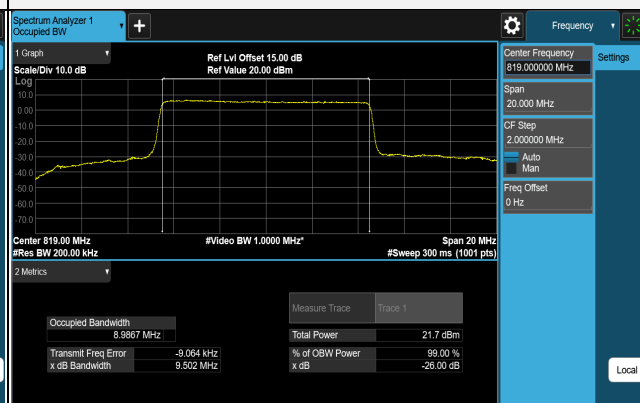

64QAM CH 26740 (819MHz)

4.5 Emission Mask Measurement

4.5.1 Limits of Emission Mask Measurement

According to FCC part 90.691 shall be tested the emission mask. For any frequency removed from the EA licensee's frequency block by up to and including 37.5 kHz, the power of any emission shall be attenuated below the transmitter power (P) in watts by at least $116 \text{ Log}_{10}(f/6.1)$ decibels or $50 + 10\text{Log}_{10}(P)$ decibels or 80 decibels, whichever is the lesser attenuation, where f is the frequency removed from the center of the outer channel in the block in kilohertz and where f is greater than 12.5 kHz.

For any frequency removed from the EA licensee's frequency block greater than 37.5 kHz, the power of any emission shall be attenuated below the transmitter power (P) in watts by at least $43 + 10\text{Log}_{10}(P)$ decibels or 80 decibels, whichever is the lesser attenuation, where f is the frequency removed from the center of the outer channel in the block in kilohertz and where f is greater than 37.5 kHz.

For § 90.691(a), RBW=300 Hz for offset less than 37.5 kHz from channel edge and RBW=100 kHz for offsets greater than 37.5 kHz is allowed, tested in accordance with FCC KDB 971168 D02 section VIII.

4.5.2 Test Setup

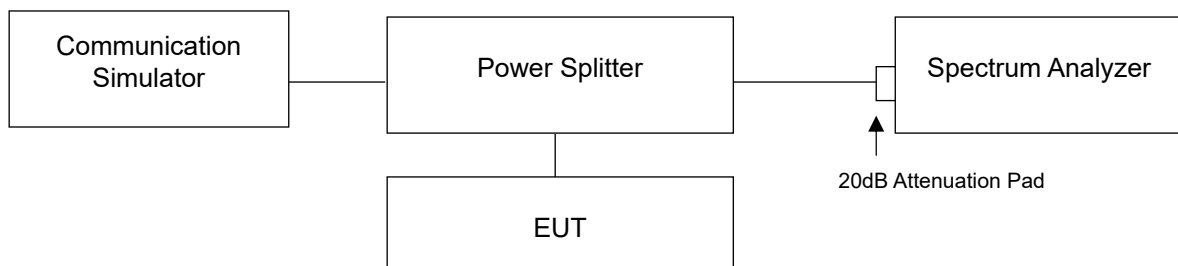

4.5.3 Test Procedures

- The measurement used the power splitter via EUT RF power connector between simulation base station and spectrum analyzer.
- Record the test plot.

4.5.4 Test Results

LTE Band 26 (Channel Bandwidth 1.4MHz)

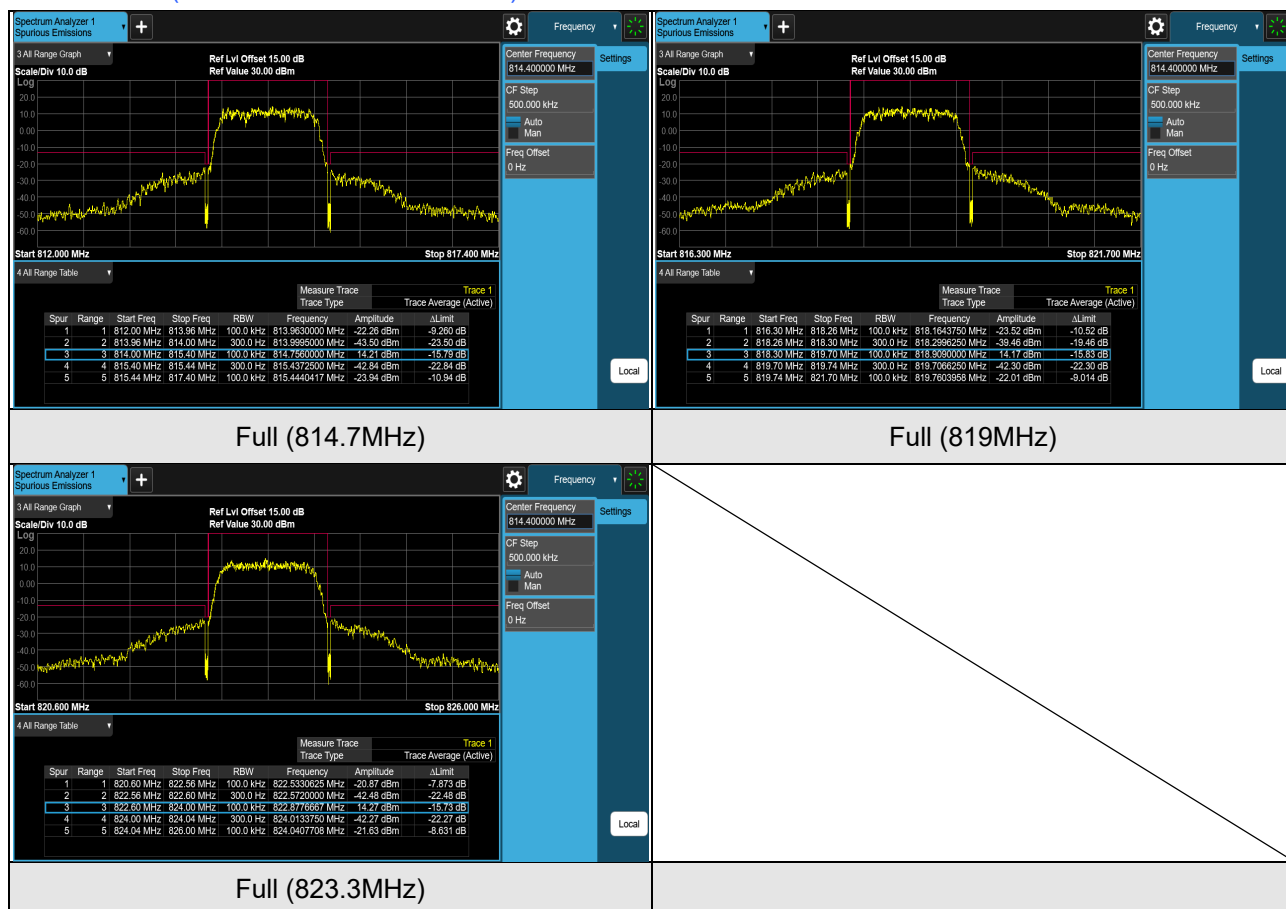

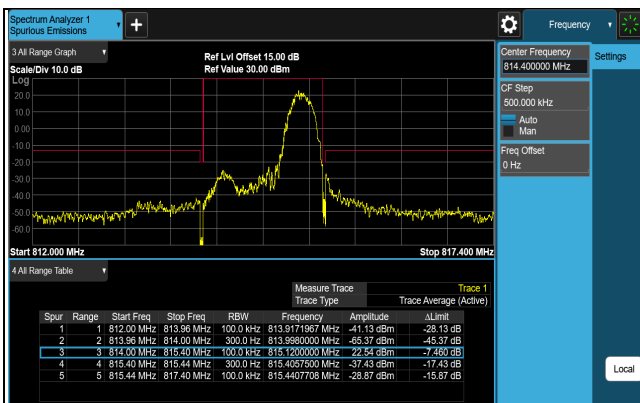

1RB#MAX (814.7MHz)

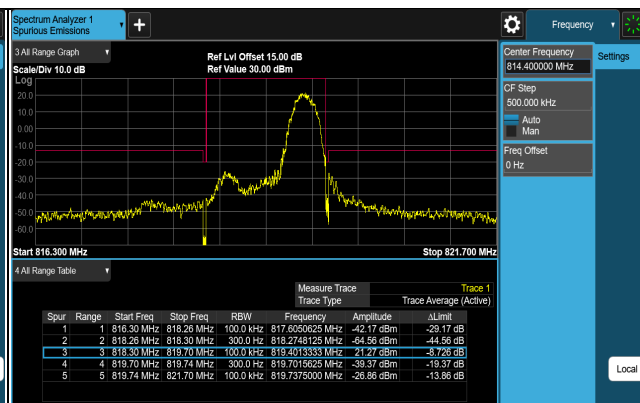

1RB#MAX (819MHz)

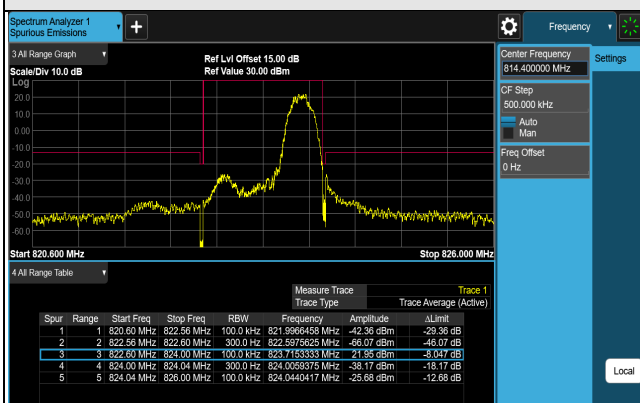

1RB#MAX (823.3MHz)

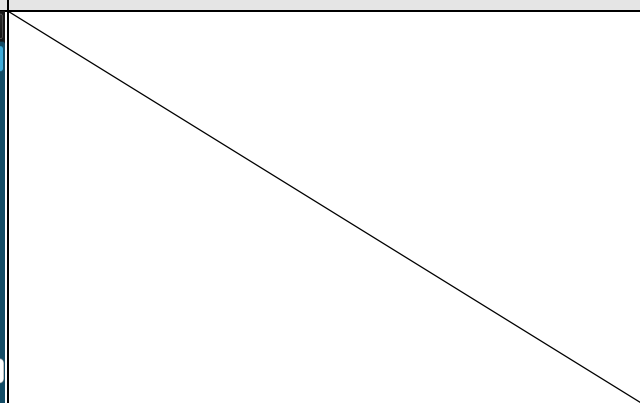

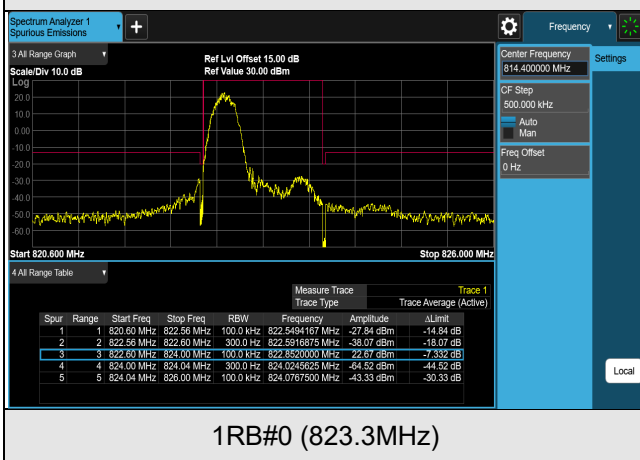
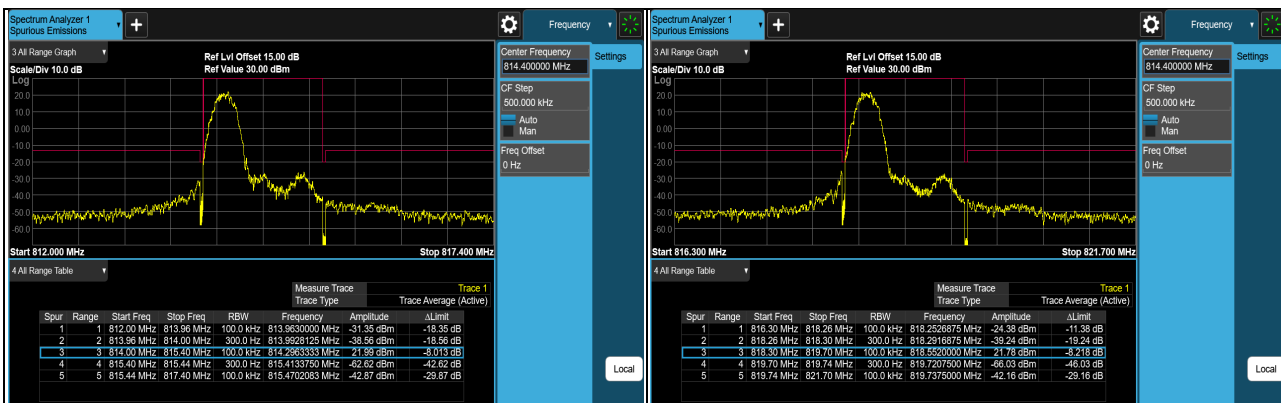

LTE Band 26 (Channel Bandwidth 3MHz)

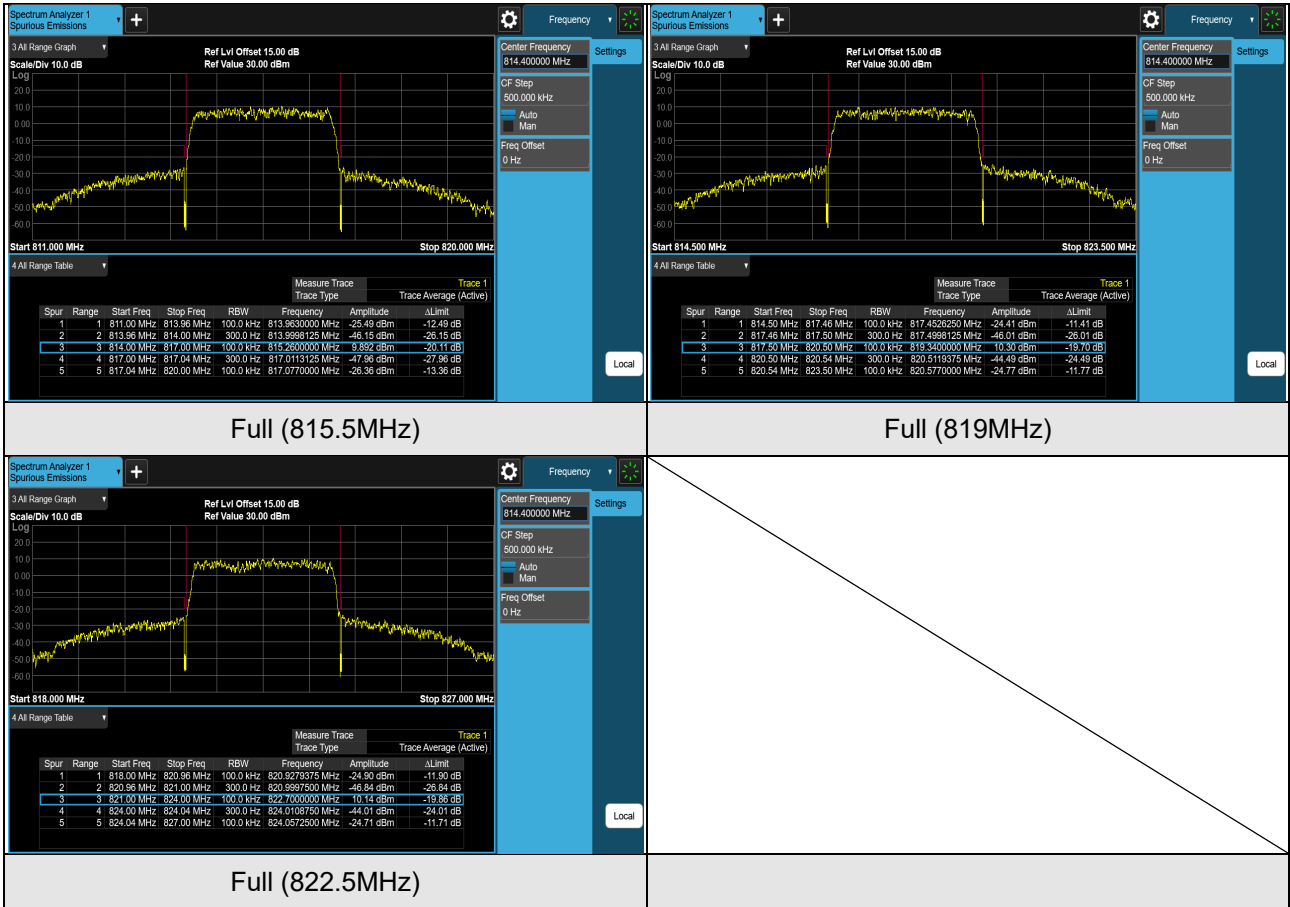

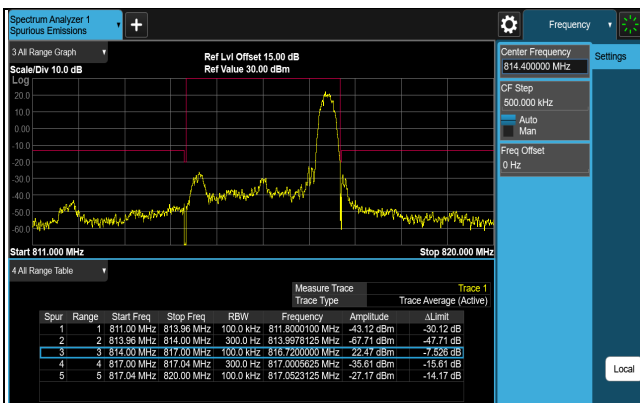

1RB#MAX (815.5MHz)

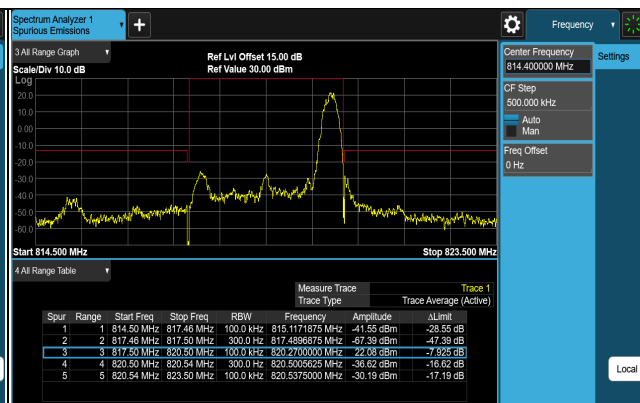

1RB#MAX (819MHz)

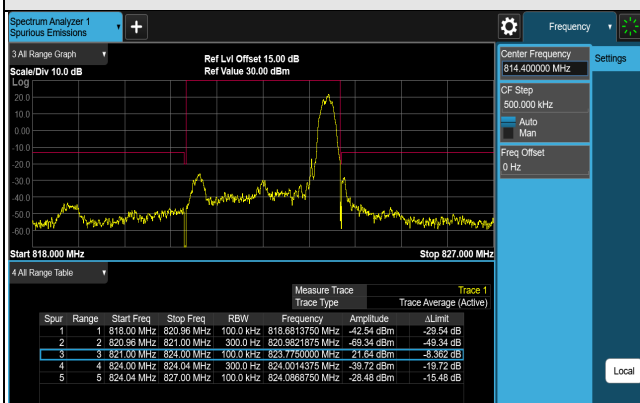

1RB#MAX (822.5MHz)

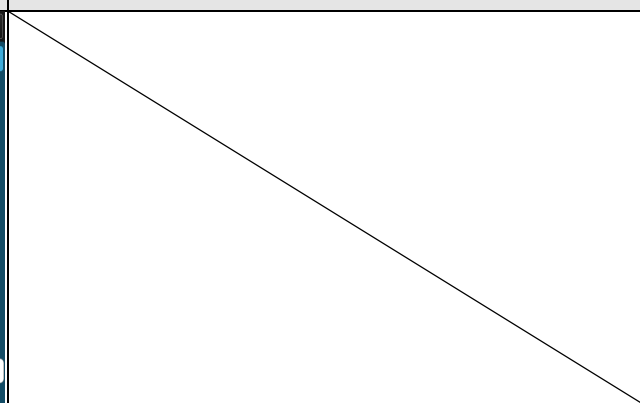

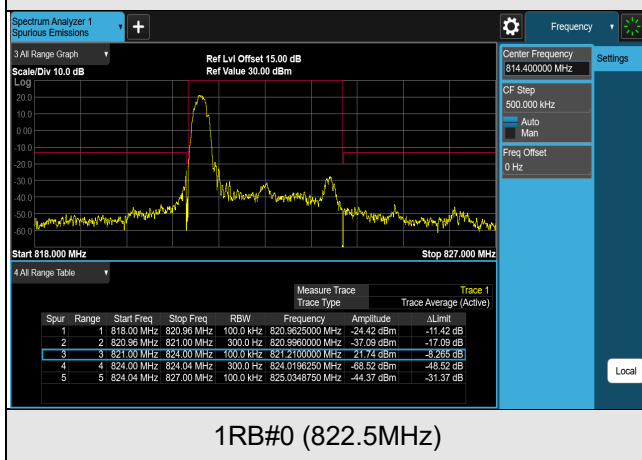
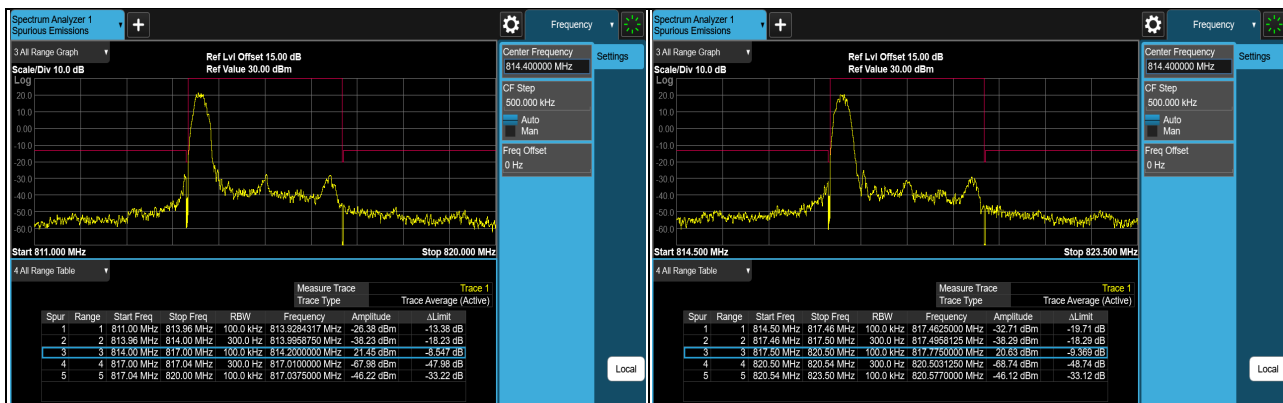

LTE Band 26 (Channel Bandwidth 5MHz)

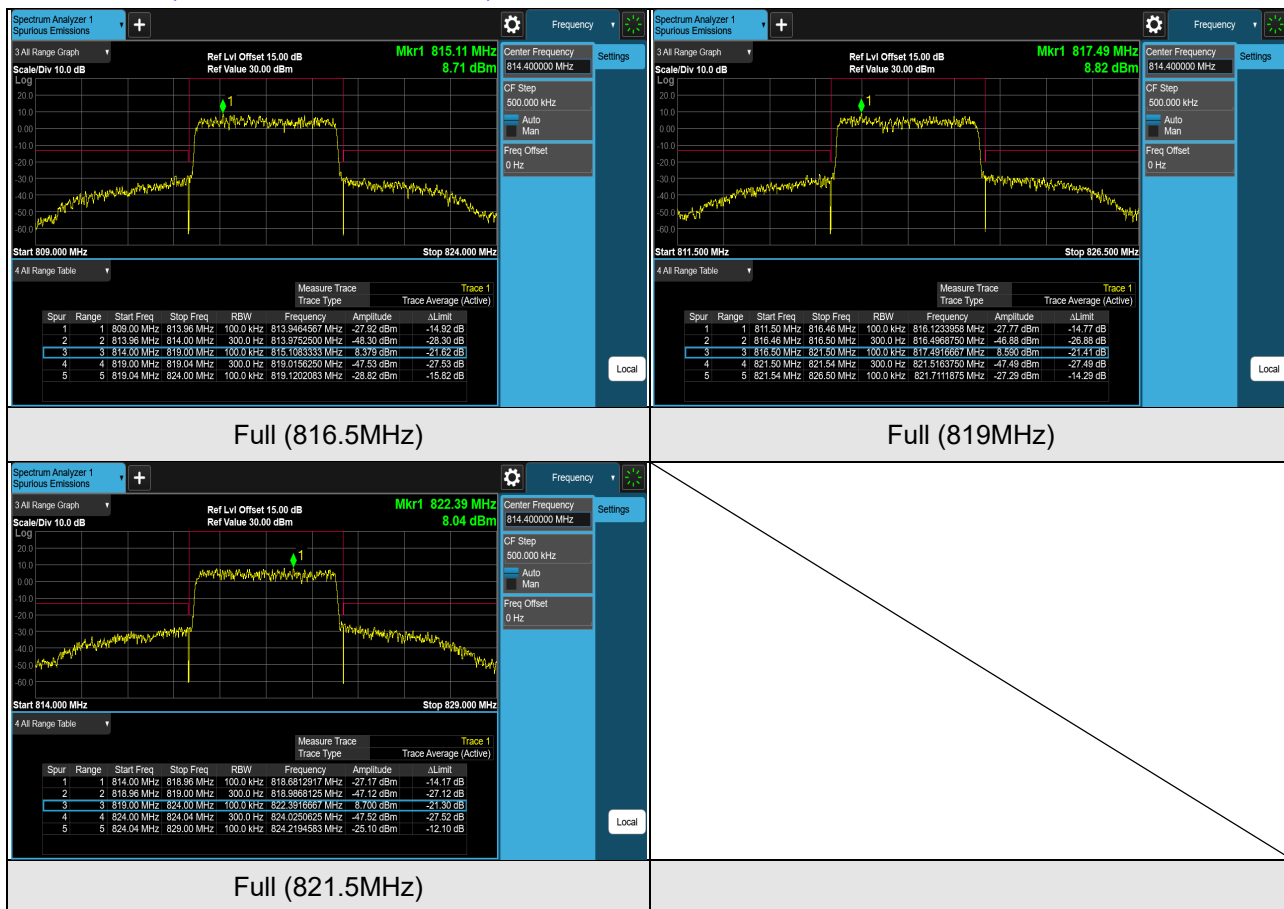

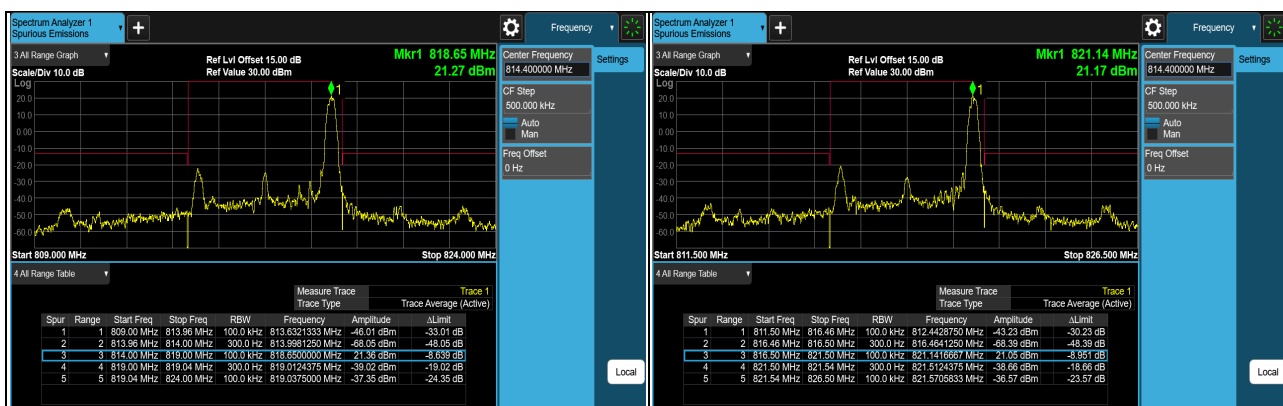

1RB#MAX (816.5MHz)

1RB#MAX (819MHz)

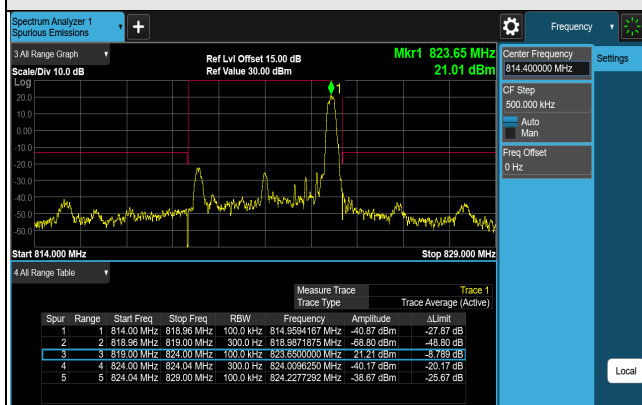

1RB#MAX (821.5MHz)

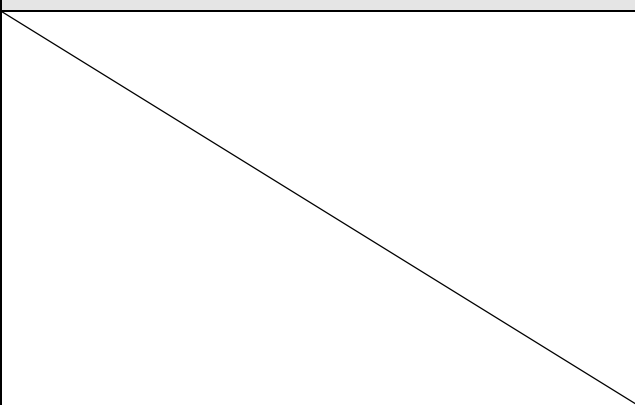

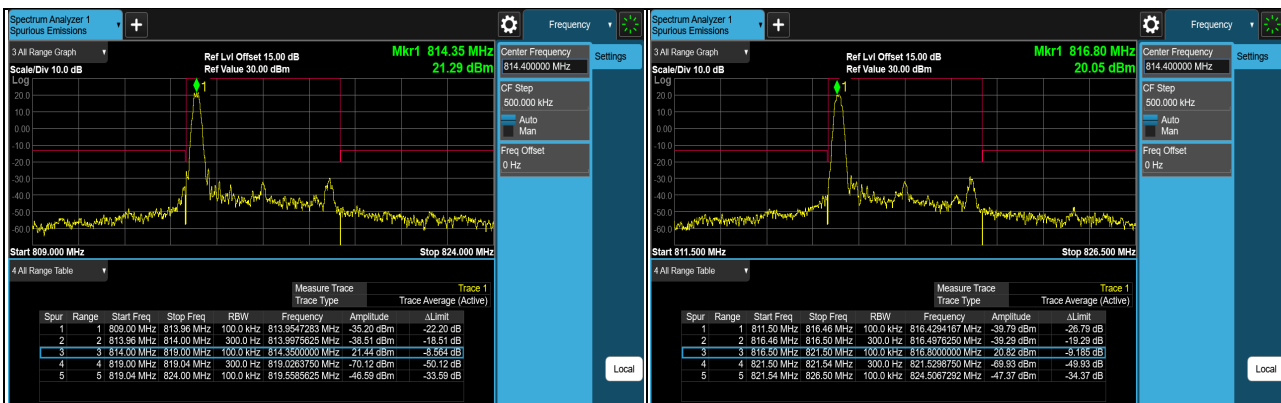

1RB#0 (816.5MHz)

1RB#0 (819MHz)

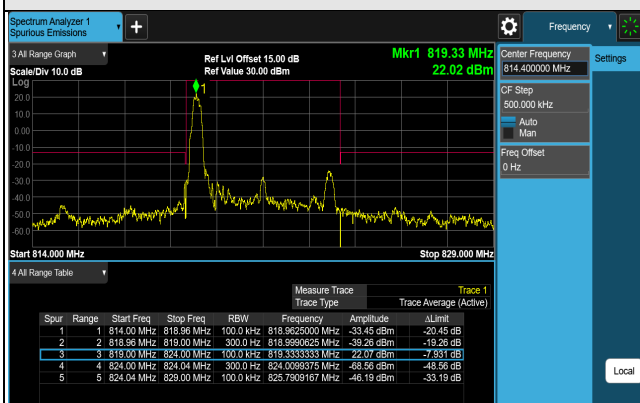

1RB#0 (821.5MHz)

LTE Band 26 (Channel Bandwidth 10MHz)

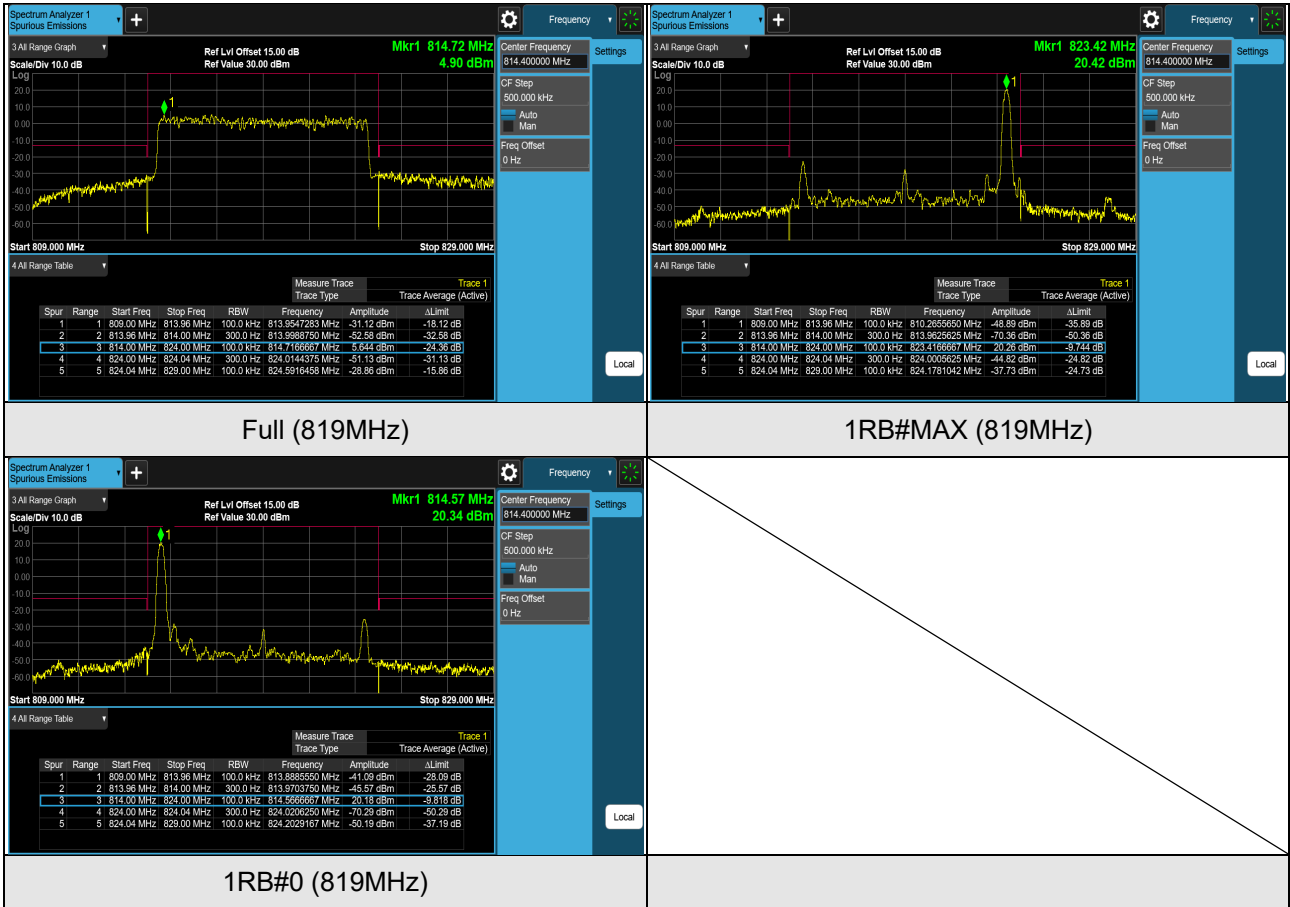

4.6 Conducted Spurious Emissions

4.6.1 Limits of Conducted Spurious Emissions Measurement

The power of any emission outside a licensee's frequency block shall be attenuated below the transmitter power (P) by at least $43 + 10 \log_{10}(P)$ dB. The limit of emission equal to -13 dBm.

For operations in the 758-775 MHz and 788-805 MHz bands, all emissions including harmonics in the band 1559-1610 MHz shall be limited to -70 dBW/MHz. The limit of emissions is equal to -40 dBm.

4.6.2 Test Setup

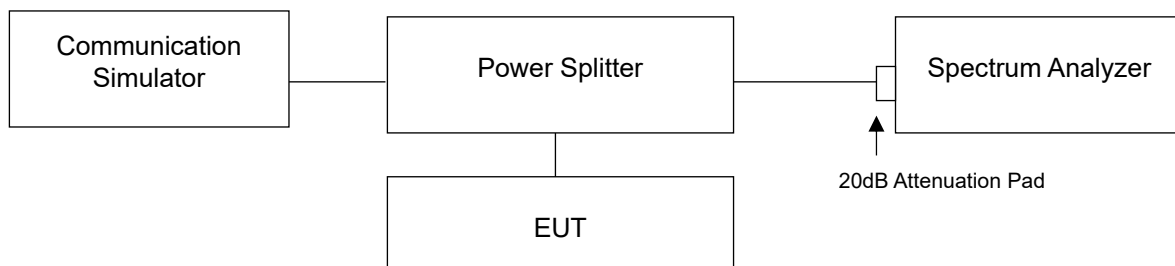

4.6.3 Test Procedure

- a. All measurements were done at low, middle and high channels operational frequency range.
- a. Measuring frequency range is from 9kHz to 9GHz. 20dB attenuation pad is connected with spectrum. RBW=1MHz and VBW=3MHz are used for conducted emission measurement.

4.6.4 Test Results

LTE Band 26 (Channel Bandwidth 1.4MHz)

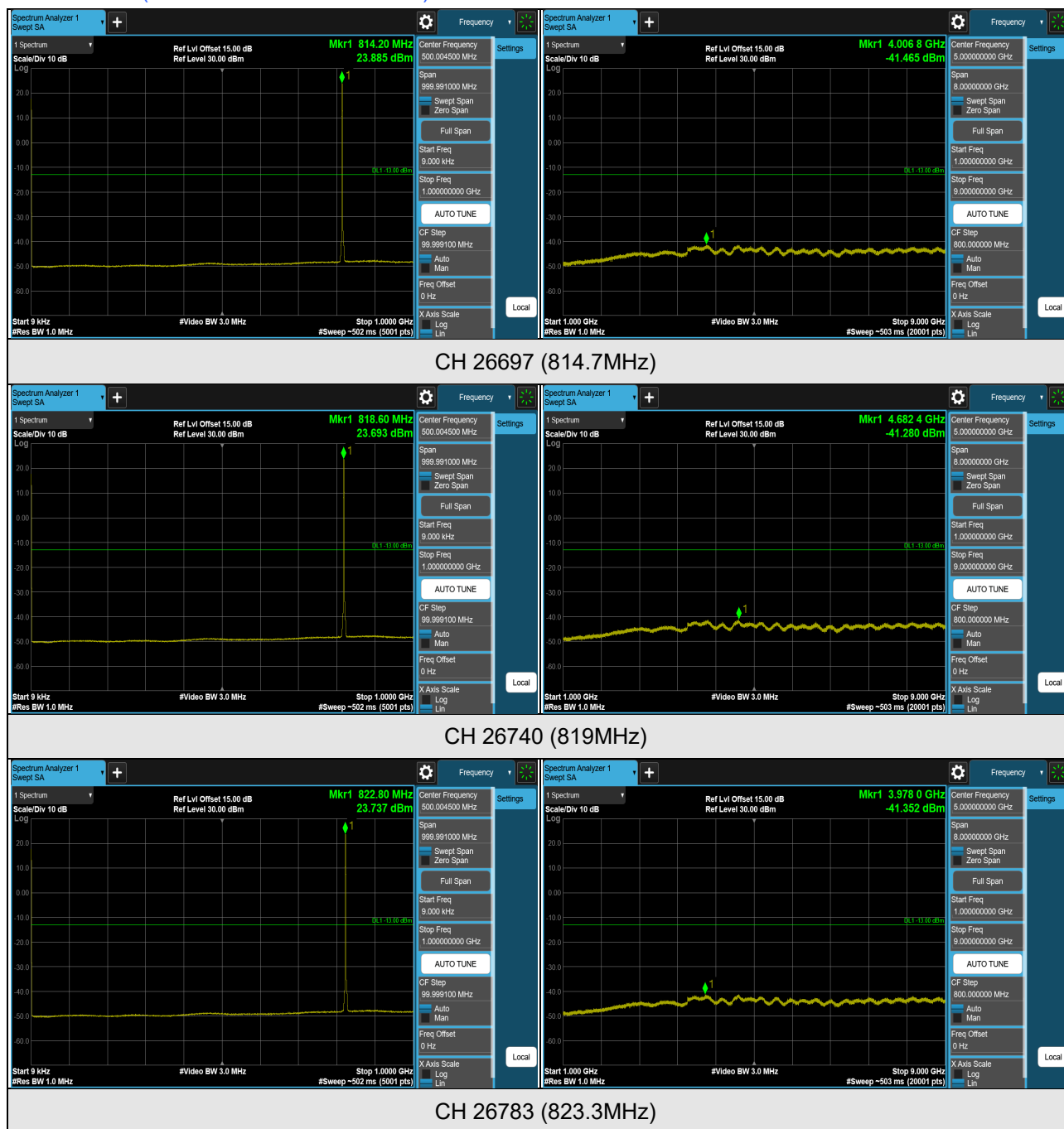

*The 9kHz signal over the limit is from Spectrum.

LTE Band 26 (Channel Bandwidth 3MHz)

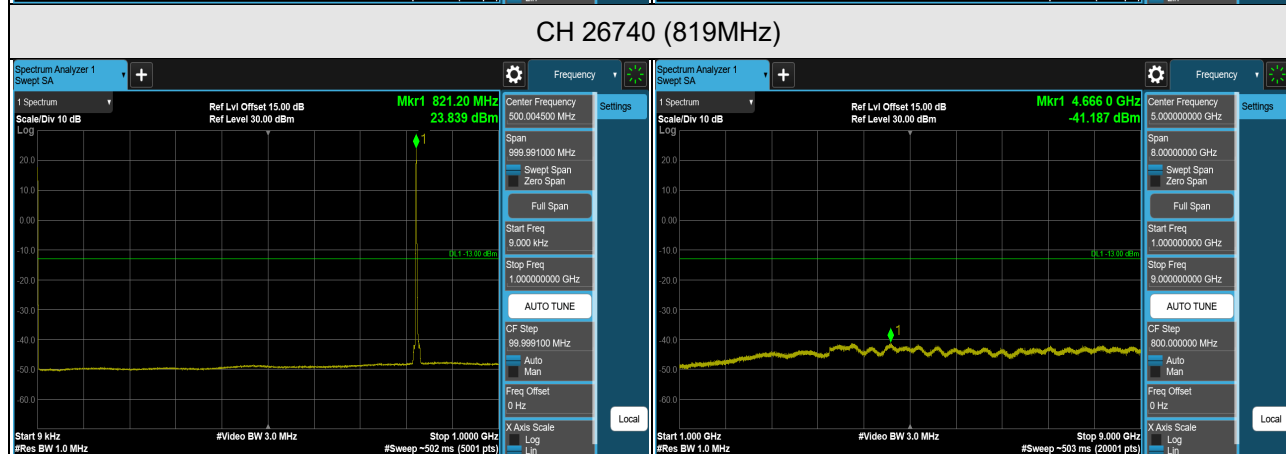
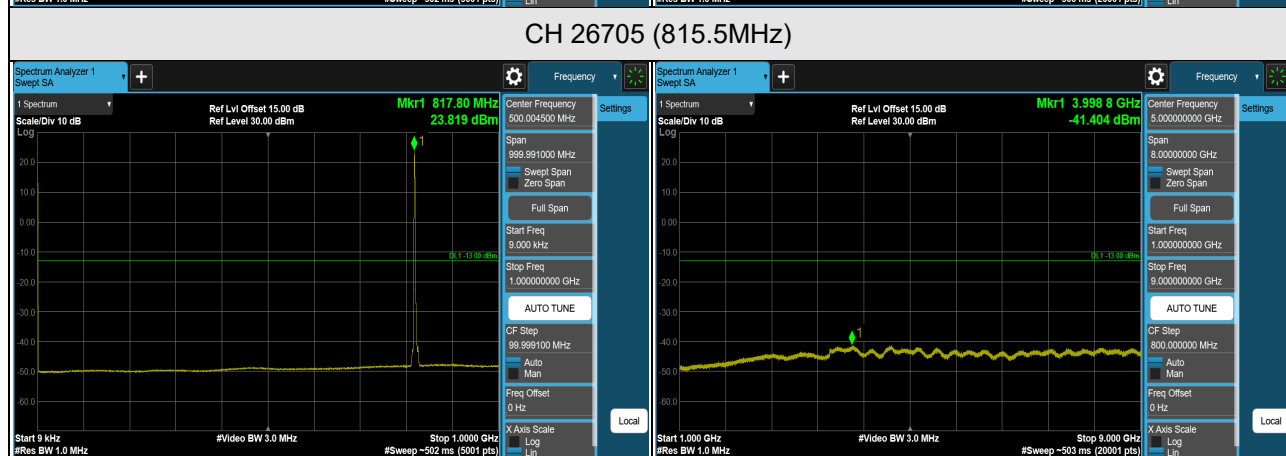
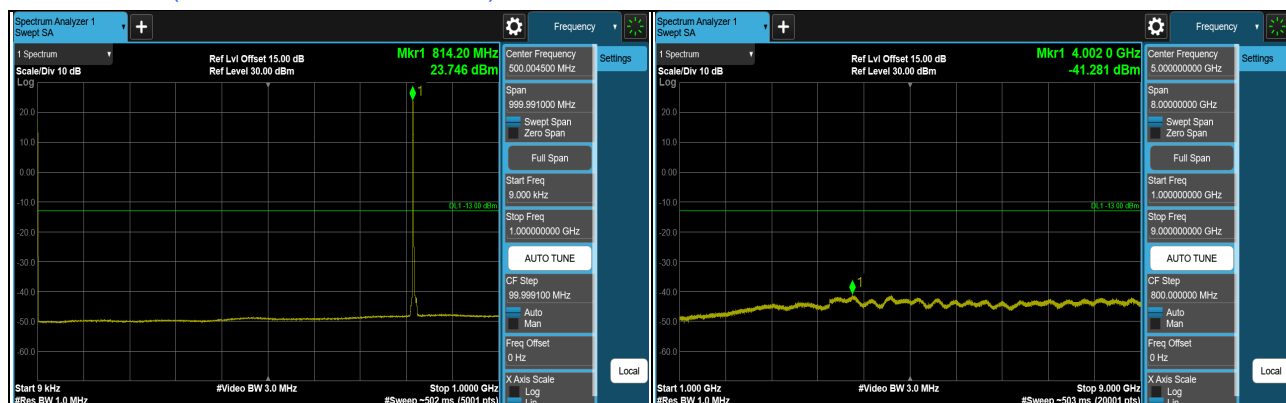

*The 9kHz signal over the limit is from Spectrum.

LTE Band 26 (Channel Bandwidth 5MHz)

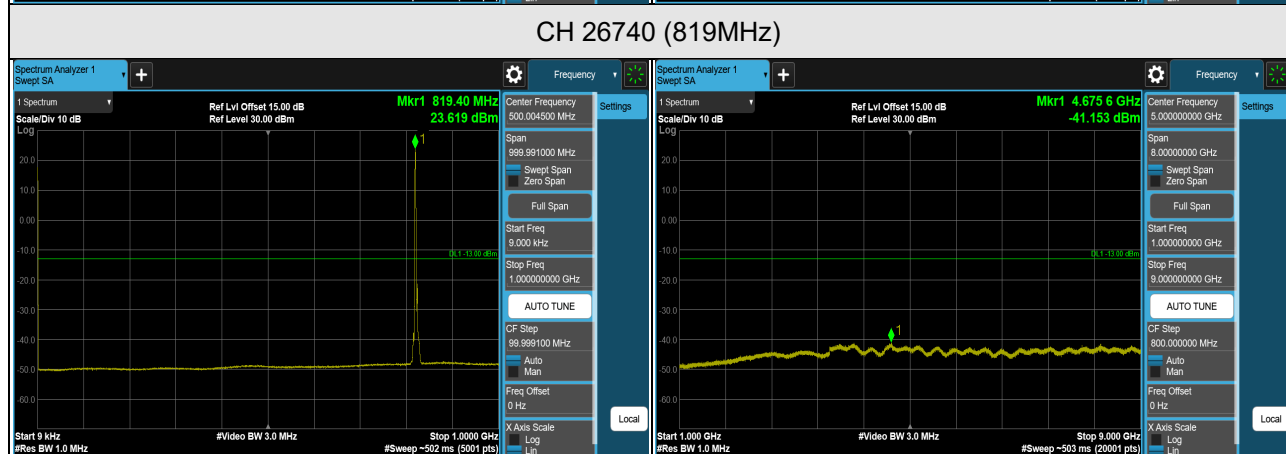
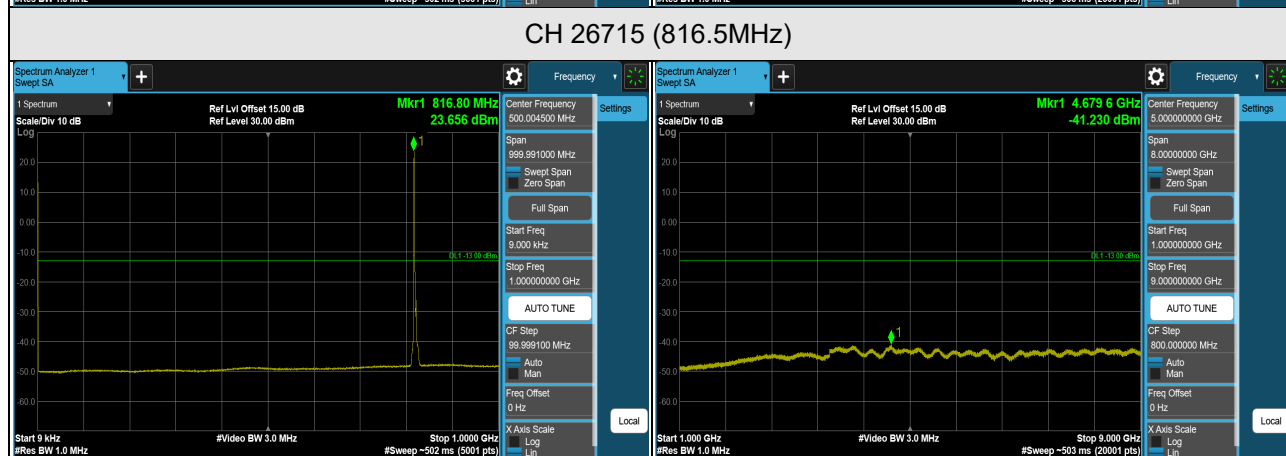
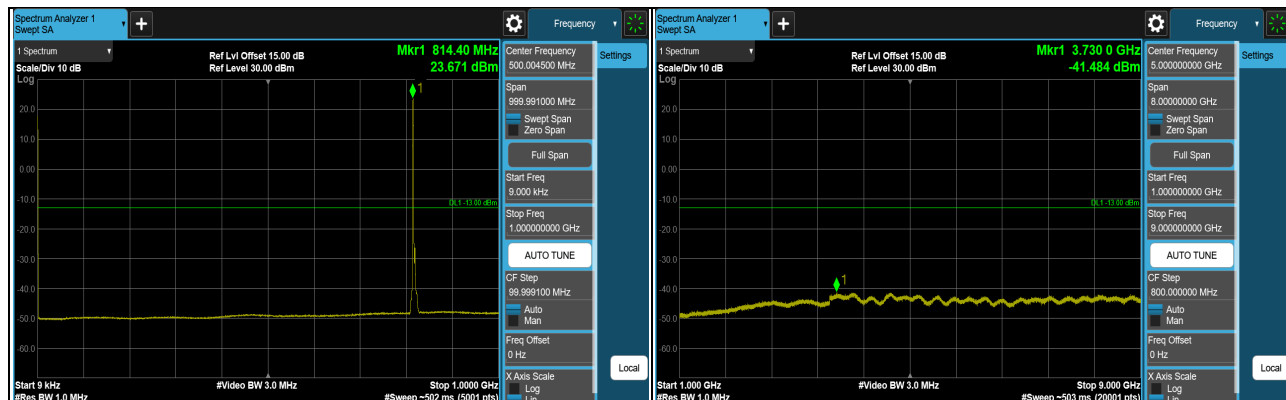

*The 9kHz signal over the limit is from Spectrum.

LTE Band 26 (Channel Bandwidth 10MHz)

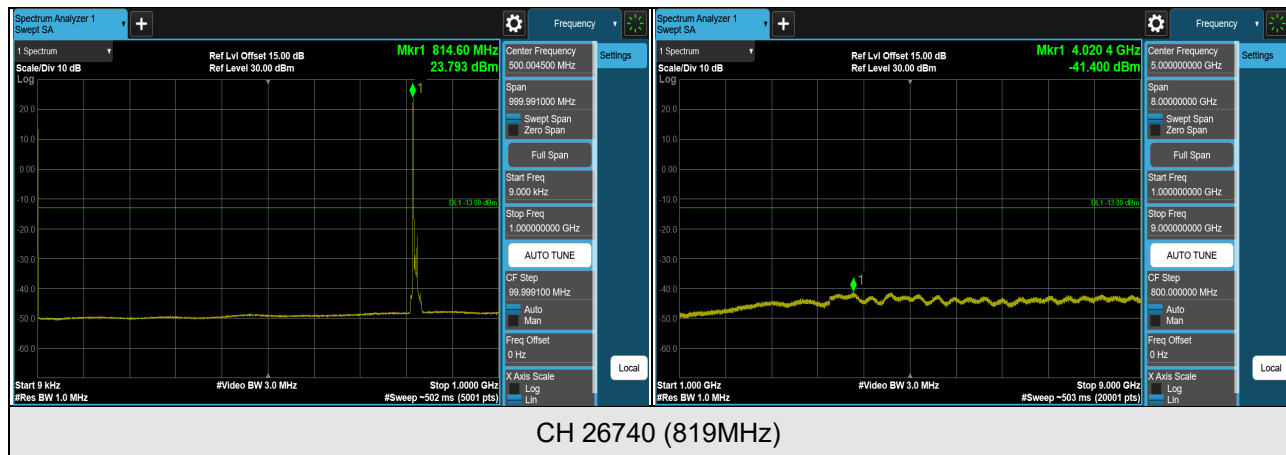

*The 9kHz signal over the limit is from Spectrum.

4.7 Radiated Emission Measurement

4.7.1 Limits of Radiated Emission Measurement

The power of any emission outside a licensee's frequency block shall be attenuated below the transmitter power (P) by at least $43 + 10 \log_{10}(P)$ dB. The limit of emission equal to -13 dBm.

For operations in the 758-775 MHz and 788-805 MHz bands, all emissions including harmonics in the band 1559-1610 MHz shall be limited to -70 dBW/MHz. The limit of emissions is equal to -40 dBm.

4.7.2 Test Procedure

- a. In the semi-anechoic chamber, EUT placed on the 0.8m (below or equal 1GHz) and/or 1.5m (above 1GHz) height of Turn Table, rotated the table around 360 degrees to search the maximum radiation power and receiver antenna shall be rotated vertical and horizontal polarization and moved height from 1m to 4m to find the maximum polar radiated power. The "Read Value" is the spectrum reading the maximum power value.
- b. The height of antenna is varied from one meter to four meters above the ground to determine the maximum value of the field strength. Both horizontal and vertical polarizations of the antenna are set to make the measurement.
- c. Perform a field strength measurement and record the worse read value, is the field strength value via a spectrum reading obtained corrected for antenna factor, cable loss and pre-amplifier factor and then mathematically convert the measured field strength level to EIRP/ERP level.
- d. Following C63.26 section 5.5 and 5.2.7
 - $EIRP \text{ (dBm)} = E \text{ (dB}\mu\text{V/m)} + 20\log(D) - 104.8$; where D is the measurement distance (in the far field region) in m.
 - $ERP \text{ (dBm)} = E \text{ (dB}\mu\text{V/m)} + 20\log(D) - 104.8 - 2.15$; where D is the measurement distance (in the far field region) in m.

Note:

1. The resolution bandwidth and video bandwidth of test receiver/spectrum analyzer is 1MHz/3MHz.
2. The emission levels were against the limit of frequency range 9 kHz ~ 30 MHz:
The amplitude of spurious emissions attenuated more than 20 dB below the permissible value is not required to be report.

4.7.3 Deviation from Test Standard

No deviation.

4.7.4 Test Setup

For radiated emission 30MHz to 1GHz

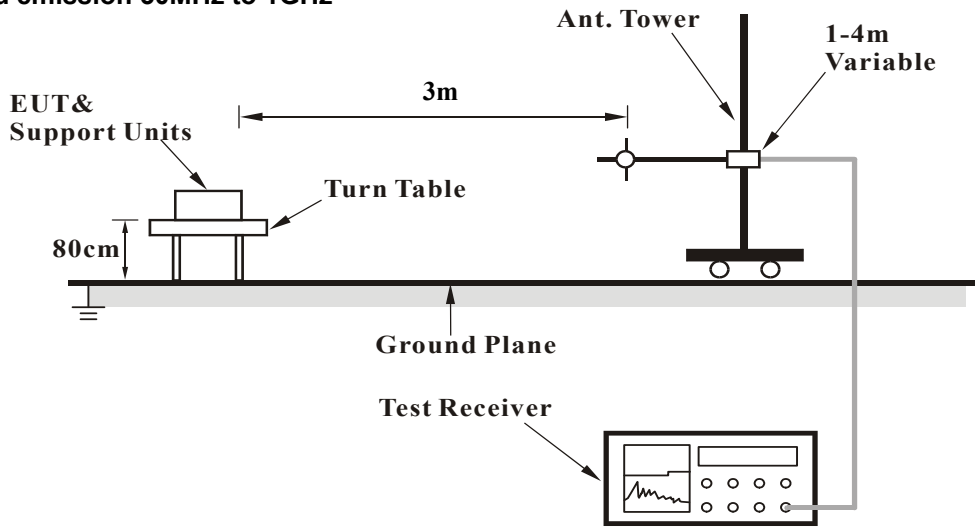

For radiated emission above 1GHz

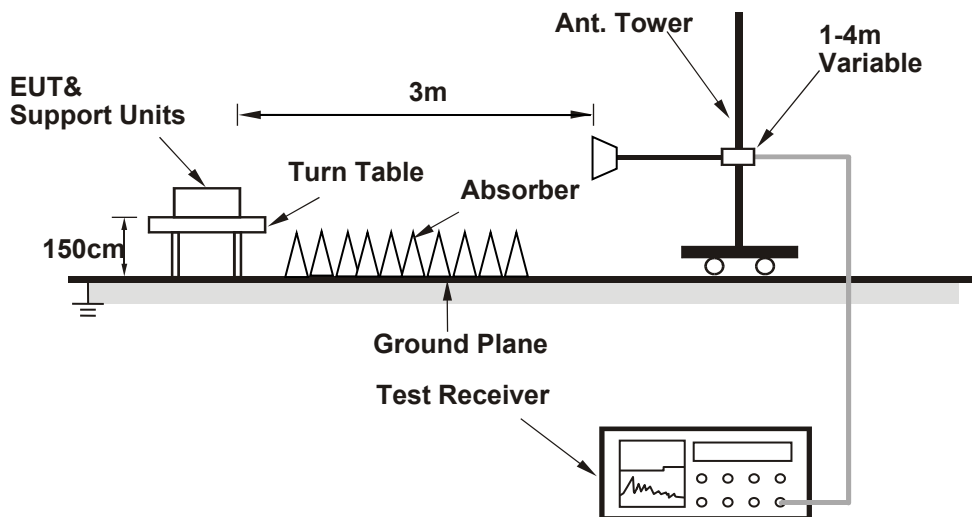

For the actual test configuration, please refer to the attached file (Test Setup Photo).

4.7.5 Test Results

Below 1GHz

LTE Band 26 (Channel Bandwidth 5MHz)

Mode	TX channel 26740 (819.0MHz)	Frequency Range	Below 1000 MHz
Environmental Conditions	23deg. C, 72%RH	Input Power	4.0Vdc
Tested By	Edison Lee		

Antenna Polarity & Test Distance : Horizontal at 3 m								
No	Frequency (MHz)	ERP (dBm)	Limit (dBm)	Margin (dB)	Antenna Height (m)	Table Angle (Degree)	Raw Value (dBUV)	Correction Factor (dB/m)
1	33.88	-45.70	-13.00	-32.70	2.00 H	213	66.11	-111.81
2	74.62	-53.49	-13.00	-40.49	1.49 H	152	60.70	-114.19
3	187.14	-62.06	-13.00	-49.06	1.01 H	266	50.92	-112.98
4	259.89	-64.16	-13.00	-51.16	1.01 H	256	47.70	-111.86
5	511.12	-62.99	-13.00	-49.99	1.49 H	38	42.32	-105.31
6	649.83	-63.14	-13.00	-50.14	1.49 H	16	39.45	-102.59

Remarks:

1. $ERP(dBm) = Raw\ Value(dBuV) + Correction\ Factor(dB/m)$
2. $Correction\ Factor(dB/m) = Antenna\ Factor(dB/m) + Cable\ Factor(dB) - Pre-Amplifier\ Factor(dB) + 20\log(D) - 104.8 - 2.15$
3. $Margin\ value = ERP - Limit\ value$
4. The other ERP levels were very low against the limit.

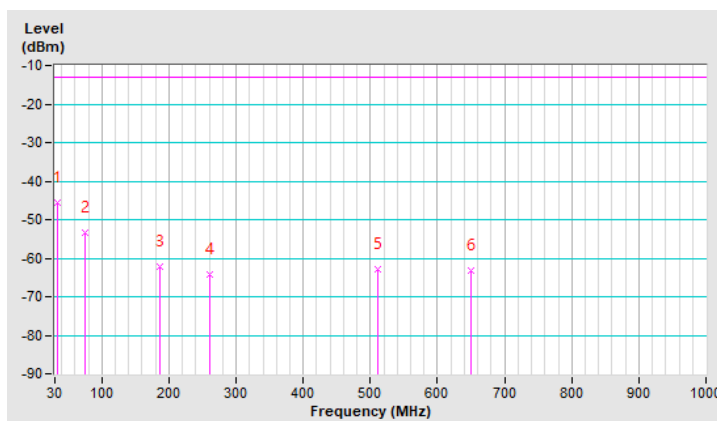

Mode	TX channel 26740 (819.0MHz)	Frequency Range	Below 1000 MHz
Environmental Conditions	23deg. C, 72%RH	Input Power	4.0Vdc
Tested By	Edison Lee		

Antenna Polarity & Test Distance : Vertical at 3m								
No	Frequency (MHz)	ERP (dBm)	Limit (dBm)	Margin (dB)	Antenna Height (m)	Table Angle (Degree)	Raw Value (dBuV)	Correction Factor (dB/m)
1	76.56	-54.03	-13.00	-41.03	2.00 V	210	60.83	-114.86
2	238.55	-71.87	-13.00	-58.87	1.01 V	169	40.72	-112.59
3	342.34	-68.48	-13.00	-55.48	1.49 V	122	40.83	-109.31
4	387.93	-65.27	-13.00	-52.27	1.49 V	54	42.80	-108.07
5	582.90	-63.77	-13.00	-50.77	1.49 V	161	40.00	-103.77
6	644.01	-62.97	-13.00	-49.97	1.01 V	154	39.57	-102.54

Remarks:

1. $ERP(dBm) = Raw\ Value(dBuV) + Correction\ Factor(dB/m)$
2. $Correction\ Factor(dB/m) = Antenna\ Factor(dB/m) + Cable\ Factor(dB) - Pre-Amplifier\ Factor(dB) + 20\log(D) - 104.8 - 2.15$
3. Margin value = ERP – Limit value
4. The other ERP levels were very low against the limit.

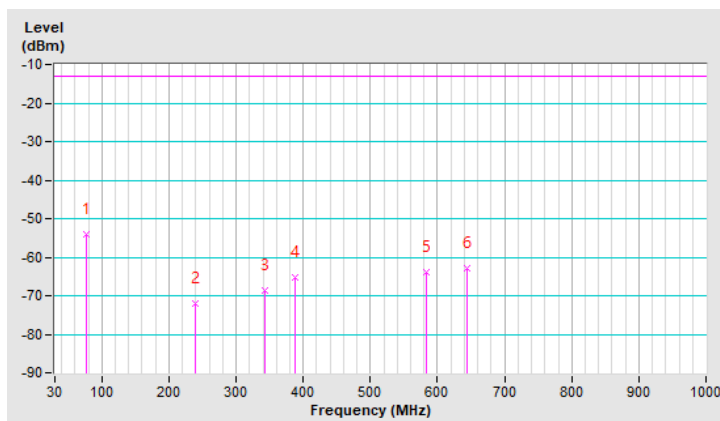

Above 1GHz

LTE Band 26 (Channel Bandwidth 1.4MHz)

Mode	TX channel 26697 (814.7MHz)	Frequency Range	1GHz ~ 9GHz
Environmental Conditions	23deg. C, 72%RH	Input Power	4.0Vdc
Tested By	Edison Lee		

Antenna Polarity & Test Distance : Horizontal at 3 m								
No	Frequency (MHz)	ERP (dBm)	Limit (dBm)	Margin (dB)	Antenna Height (m)	Table Angle (Degree)	Raw Value (dBuV)	Correction Factor (dB/m)
1	1629.40	-57.56	-13.00	-44.56	2.04 H	223	47.91	-105.47
Antenna Polarity & Test Distance : Vertical at 3 m								
No	Frequency (MHz)	ERP (dBm)	Limit (dBm)	Margin (dB)	Antenna Height (m)	Table Angle (Degree)	Raw Value (dBuV)	Correction Factor (dB/m)
1	1629.40	-55.87	-13.00	-42.87	1.58 V	83	49.60	-105.47

Remarks:

1. ERP(dBm) = Raw Value(dBuV) + Correction Factor(dB/m).
2. Correction Factor(dB/m) = Antenna Factor(dB/m) + Cable Factor(dB) – Pre-Amplifier Factor(dB) + 20log(D) – 104.8 - 2.15
3. Margin value = ERP – Limit value.
4. The other ERP levels were very low against the limit.

Mode	TX channel 26740 (819.0MHz)	Frequency Range	1GHz ~ 9GHz
Environmental Conditions	23deg. C, 72%RH	Input Power	4.0Vdc
Tested By	Edison Lee		

Antenna Polarity & Test Distance : Horizontal at 3 m								
No	Frequency (MHz)	ERP (dBm)	Limit (dBm)	Margin (dB)	Antenna Height (m)	Table Angle (Degree)	Raw Value (dBuV)	Correction Factor (dB/m)
1	1638.00	-57.60	-13.00	-44.60	2.05 H	223	47.86	-105.46
Antenna Polarity & Test Distance : Vertical at 3 m								
No	Frequency (MHz)	ERP (dBm)	Limit (dBm)	Margin (dB)	Antenna Height (m)	Table Angle (Degree)	Raw Value (dBuV)	Correction Factor (dB/m)
1	1638.00	-56.03	-13.00	-43.03	1.55 V	85	49.43	-105.46

Remarks:

1. ERP(dBm) = Raw Value(dBuV) + Correction Factor(dB/m).
2. Correction Factor(dB/m) = Antenna Factor(dB/m) + Cable Factor(dB) – Pre-Amplifier Factor(dB) + 20log(D) – 104.8 - 2.15
3. Margin value = ERP – Limit value.
4. The other ERP levels were very low against the limit.

Mode	TX channel 26783 (823.3MHz)	Frequency Range	1GHz ~ 9GHz
Environmental Conditions	23deg. C, 72%RH	Input Power	4.0Vdc
Tested By	Edison Lee		

Antenna Polarity & Test Distance : Horizontal at 3 m								
No	Frequency (MHz)	ERP (dBm)	Limit (dBm)	Margin (dB)	Antenna Height (m)	Table Angle (Degree)	Raw Value (dBuV)	Correction Factor (dB/m)
1	1646.60	-57.68	-13.00	-44.68	2.00 H	220	47.76	-105.44
Antenna Polarity & Test Distance : Vertical at 3 m								
No	Frequency (MHz)	ERP (dBm)	Limit (dBm)	Margin (dB)	Antenna Height (m)	Table Angle (Degree)	Raw Value (dBuV)	Correction Factor (dB/m)
1	1646.60	-55.95	-13.00	-42.95	1.53 V	81	49.49	-105.44

Remarks:

1. $ERP(dBm) = Raw\ Value(dBuV) + Correction\ Factor(dB/m)$.
2. $Correction\ Factor(dB/m) = Antenna\ Factor(dB/m) + Cable\ Factor(dB) - Pre-Amplifier\ Factor(dB) + 20\log(D) - 104.8 - 2.15$
3. Margin value = ERP – Limit value.
4. The other ERP levels were very low against the limit.

LTE Band 26 (Channel Bandwidth 5MHz)

Mode	TX channel 26715 (816.5MHz)	Frequency Range	1GHz ~ 9GHz
Environmental Conditions	23deg. C, 72%RH	Input Power	4.0Vdc
Tested By	Edison Lee		

Antenna Polarity & Test Distance : Horizontal at 3 m								
No	Frequency (MHz)	ERP (dBm)	Limit (dBm)	Margin (dB)	Antenna Height (m)	Table Angle (Degree)	Raw Value (dBuV)	Correction Factor (dB/m)
1	1633.00	-57.57	-13.00	-44.57	2.04 H	223	47.89	-105.46
Antenna Polarity & Test Distance : Vertical at 3 m								
No	Frequency (MHz)	ERP (dBm)	Limit (dBm)	Margin (dB)	Antenna Height (m)	Table Angle (Degree)	Raw Value (dBuV)	Correction Factor (dB/m)
1	1633.00	-55.98	-13.00	-42.98	1.59 V	86	49.48	-105.46

Remarks:

1. ERP(dBm) = Raw Value(dBuV) + Correction Factor(dB/m).
2. Correction Factor(dB/m) = Antenna Factor(dB/m) + Cable Factor(dB) – Pre-Amplifier Factor(dB) + 20log(D) – 104.8 - 2.15
3. Margin value = ERP – Limit value.
4. The other ERP levels were very low against the limit.

Mode	TX channel 26740 (819.0MHz)	Frequency Range	1GHz ~ 9GHz
Environmental Conditions	23deg. C, 72%RH	Input Power	4.0Vdc
Tested By	Edison Lee		

Antenna Polarity & Test Distance : Horizontal at 3 m								
No	Frequency (MHz)	ERP (dBm)	Limit (dBm)	Margin (dB)	Antenna Height (m)	Table Angle (Degree)	Raw Value (dBuV)	Correction Factor (dB/m)
1	1638.00	-57.66	-13.00	-44.66	2.06 H	225	47.80	-105.46
Antenna Polarity & Test Distance : Vertical at 3 m								
No	Frequency (MHz)	ERP (dBm)	Limit (dBm)	Margin (dB)	Antenna Height (m)	Table Angle (Degree)	Raw Value (dBuV)	Correction Factor (dB/m)
1	1638.00	-55.92	-13.00	-42.92	1.52 V	82	49.54	-105.46

Remarks:

1. ERP(dBm) = Raw Value(dBuV) + Correction Factor(dB/m).
2. Correction Factor(dB/m) = Antenna Factor(dB/m) + Cable Factor(dB) – Pre-Amplifier Factor(dB) + 20log(D) – 104.8 - 2.15
3. Margin value = ERP – Limit value.
4. The other ERP levels were very low against the limit.

Mode	TX channel 26765 (821.5MHz)	Frequency Range	1GHz ~ 9GHz
Environmental Conditions	23deg. C, 72%RH	Input Power	4.0Vdc
Tested By	Edison Lee		

Antenna Polarity & Test Distance : Horizontal at 3 m								
No	Frequency (MHz)	ERP (dBm)	Limit (dBm)	Margin (dB)	Antenna Height (m)	Table Angle (Degree)	Raw Value (dBuV)	Correction Factor (dB/m)
1	1643.00	-57.54	-13.00	-44.54	2.02 H	217	47.92	-105.46
Antenna Polarity & Test Distance : Vertical at 3 m								
No	Frequency (MHz)	ERP (dBm)	Limit (dBm)	Margin (dB)	Antenna Height (m)	Table Angle (Degree)	Raw Value (dBuV)	Correction Factor (dB/m)
1	1643.00	-55.84	-13.00	-42.84	1.50 V	83	49.62	-105.46

Remarks:

1. $ERP(dBm) = Raw\ Value(dBuV) + Correction\ Factor(dB/m)$.
2. $Correction\ Factor(dB/m) = Antenna\ Factor(dB/m) + Cable\ Factor(dB) - Pre-Amplifier\ Factor(dB) + 20\log(D) - 104.8 - 2.15$
3. Margin value = ERP – Limit value.
4. The other ERP levels were very low against the limit.

LTE Band 26 (Channel Bandwidth 10MHz)

Mode	TX channel 26740 (819.0MHz)	Frequency Range	1GHz ~ 9GHz
Environmental Conditions	23deg. C, 72%RH	Input Power	4.0Vdc
Tested By	Edison Lee		

Antenna Polarity & Test Distance : Horizontal at 3 m								
No	Frequency (MHz)	ERP (dBm)	Limit (dBm)	Margin (dB)	Antenna Height (m)	Table Angle (Degree)	Raw Value (dBuV)	Correction Factor (dB/m)
1	1638.00	-57.31	-13.00	-44.31	2.01 H	222	48.15	-105.46
Antenna Polarity & Test Distance : Vertical at 3 m								
No	Frequency (MHz)	ERP (dBm)	Limit (dBm)	Margin (dB)	Antenna Height (m)	Table Angle (Degree)	Raw Value (dBuV)	Correction Factor (dB/m)
1	1638.00	-55.66	-13.00	-42.66	1.55 V	84	49.80	-105.46

Remarks:

1. $ERP(dBm) = Raw\ Value(dBuV) + Correction\ Factor(dB/m)$.
2. $Correction\ Factor(dB/m) = Antenna\ Factor(dB/m) + Cable\ Factor(dB) - Pre-Amplifier\ Factor(dB) + 20\log(D) - 104.8 - 2.15$
3. Margin value = ERP – Limit value.
4. The other ERP levels were very low against the limit.

5 Pictures of Test Arrangements

Please refer to the attached file (Test Setup Photo).

Appendix – Information of the Testing Laboratories

We, Bureau Veritas Consumer Products Services (H.K.) Ltd., Taoyuan Branch, were founded in 1988 to provide our best service in EMC, Radio, Telecom and Safety consultation. Our laboratories are FCC recognized accredited test firms and accredited and approved according to ISO/IEC 17025.

If you have any comments, please feel free to contact us at the following:

Linko EMC/RF Lab

Tel: 886-2-26052180

Fax: 886-2-26051924

Hsin Chu EMC/RF/Telecom Lab

Tel: 886-3-6668565

Fax: 886-3-6668323

Hwa Ya EMC/RF/Safety Lab

Tel: 886-3-3183232

Fax: 886-3-3270892

Email: service.adt@tw.bureauveritas.com

Web Site: www.bureauveritas-adt.com

The address and road map of all our labs can be found in our web site also.

--- END ---