



## TEST REPORT



Test report no.: 1-6579\_23-01-15\_TR1-R1

### Testing laboratory

**cetecom advanced GmbH**  
Untertuerkheimer Strasse 6 – 10  
66117 Saarbruecken / Germany  
Phone: + 49 681 5 98 - 0  
Fax: + 49 681 5 98 - 9075  
Internet: <https://cetecomadvanced.com>  
e-mail: [mail@cetecomadvanced.com](mailto:mail@cetecomadvanced.com)

**Accredited Testing Laboratory:**

The testing laboratory (area of testing) is accredited according to DIN EN ISO/IEC 17025 (2018-03) by the Deutsche Akkreditierungsstelle GmbH (DAkkS).

The accreditation is valid for the scope of testing procedures as stated in the accreditation certificate with the registration number: D-PL-12047-01-00.

ISED Testing Laboratory Recognized Listing Number: DE0001  
FCC designation number: DE0002

### Applicant

**Robert Bosch GmbH**  
Robert-Bosch-Straße 200  
31139 Hildesheim / GERMANY  
Phone: -/-  
Contact: Thomas Dargel  
e-mail: [Thomas.Dargel@de.bosch.com](mailto:Thomas.Dargel@de.bosch.com)

### Manufacturer

**Robert Bosch GmbH**  
Robert-Bosch-Straße 200  
31139 Hildesheim / GERMANY

### Test standard/s

FCC - Title 47 CFR Part 15      FCC - Title 47 of the Code of Federal Regulations; Chapter I; Part 15 - Radio frequency devices

RSS - 247 Issue 3                Digital Transmission Systems (DTSS), Frequency Hopping Systems (FHSs) and Licence-Exempt Local Area Network (LE-LAN) Devices

For further applied test standards please refer to section 3 of this test report.

### Test Item

**Kind of test item:**                **Telematics Control Unit Generation 2**

**Model name:**                    **TCU2 NA IP67**

**FCC ID:**                            **2AUXS-TCU2NAIP67**

**ISED certification number:**   **25847-TCU2NAIP67**

Frequency:                         2400 MHz to 2483.5 MHz

Technology tested:                WLAN

Antenna:                            Two Integrated antennas with MIMO capability

Power supply:                     12.0 V DC by vehicle battery

Temperature range:               -40°C to +65°C

This test report is electronically signed and valid without handwritten signature. For verification of the electronic signatures, the public keys can be requested at the testing laboratory.

### Test report authorized:

Marco Bertolino  
Supervisor Radio Services  
Radio Labs

### Test performed:

Michael Dorongovski  
Lab Manager  
Radio Labs

## 1 Table of contents

1	Table of contents.....	2
2	General information.....	4
2.1	Notes and disclaimer .....	4
2.2	Application details .....	4
2.3	Test laboratories sub-contracted .....	4
3	Test standard/s, references and accreditations .....	5
4	Reporting statements of conformity – decision rule .....	6
5	Test environment.....	7
6	Test item .....	7
6.1	General description .....	7
6.2	Additional information .....	7
7	Description of the test setup.....	8
7.1	Shielded semi anechoic chamber .....	9
7.2	Shielded fully anechoic chamber.....	10
7.3	Radiated measurements > 18 GHz .....	11
7.4	Conducted measurements Bluetooth system .....	12
8	Sequence of testing.....	13
8.1	Sequence of testing radiated spurious 9 kHz to 30 MHz .....	13
8.2	Sequence of testing radiated spurious 30 MHz to 1 GHz.....	14
8.3	Sequence of testing radiated spurious 1 GHz to 18 GHz.....	15
8.4	Sequence of testing radiated spurious above 18 GHz.....	16
9	Measurement uncertainty.....	17
10	Summary of measurement results .....	18
11	Additional information and comments .....	19
12	Additional EUT parameter .....	20
13	Measurement results .....	21
13.1	Antenna gain .....	21
13.2	Identify worst case data rate.....	22
13.3	Maximum output power.....	23
13.4	Duty cycle.....	25
13.5	Average power spectral density .....	26
13.6	6 dB DTS bandwidth .....	28
13.7	Occupied bandwidth – 99% emission bandwidth .....	29
13.8	Occupied bandwidth – 20 dB bandwidth.....	30
13.9	Band edge compliance radiated .....	31
13.10	Spurious emissions conducted .....	35
13.11	Spurious emissions radiated below 30 MHz .....	36
13.12	Spurious emissions radiated 30 MHz to 1 GHz .....	41
13.13	Spurious emissions radiated above 1 GHz .....	44
14	Glossary .....	50

15 Document history ..... 51

## 2 General information

### 2.1 Notes and disclaimer

The test results of this test report relate exclusively to the test item specified in this test report. cetecom advanced GmbH does not assume responsibility for any conclusions and generalizations drawn from the test results with regard to other specimens or samples of the type of the equipment represented by the test item.

The test report may only be reproduced or published in full. Reproduction or publication of extracts from the report requires the prior written approval of cetecom advanced GmbH.

The testing service provided by cetecom advanced GmbH has been rendered under the current "General Terms and Conditions for cetecom advanced GmbH".

cetecom advanced GmbH will not be liable for any loss or damage resulting from false, inaccurate, inappropriate or incomplete product information provided by the customer.

Under no circumstances does the cetecom advanced GmbH test report include any endorsement or warranty regarding the functionality, quality or performance of any other product or service provided.

Under no circumstances does the cetecom advanced GmbH test report include or imply any product or service warranties from cetecom advanced GmbH, including, without limitation, any implied warranties of merchantability, fitness for purpose, or non-infringement, all of which are expressly disclaimed by cetecom advanced GmbH.

All rights and remedies regarding vendor's products and services for which cetecom advanced GmbH has prepared this test report shall be provided by the party offering such products or services and not by cetecom advanced GmbH.

In no case this test report can be considered as a Letter of Approval.

This test report is electronically signed and valid without handwritten signature. For verification of the electronic signatures, the public keys can be requested at the testing laboratory.

### 2.2 Application details

Date of receipt of order: 2023-07-30

Date of receipt of test item: 2023-08-07

Start of test:\* 2024-01-15

End of test:\* 2024-02-22

Person(s) present during the test: -/-

\*Date of each measurement, if not shown in the plot, can be requested. Dates are stored in the measurement software.

### 2.3 Test laboratories sub-contracted

None

### 3 Test standard/s, references and accreditations

Test standard	Date	Description
FCC - Title 47 CFR Part 15	-/-	FCC - Title 47 of the Code of Federal Regulations; Chapter I; Part 15 - Radio frequency devices
RSS - 247 Issue 3	August 2023	Digital Transmission Systems (DTSS), Frequency Hopping Systems (FHSs) and Licence-Exempt Local Area Network (LE-LAN) Devices
RSS - Gen Issue 5 incl. Amendment 1 & 2	February 2021	Spectrum Management and Telecommunications Radio Standards Specification - General Requirements for Compliance of Radio Apparatus
Guidance	Version	Description
KDB 558074 D01	v05r02	GUIDANCE FOR COMPLIANCE MEASUREMENTS ON DIGITAL TRANSMISSION SYSTEM, FREQUENCY HOPPING SPREAD SPECTRUM SYSTEM, AND HYBRID SYSTEM DEVICES OPERATING UNDER SECTION 15.247 OF THE FCC RULES
ANSI C63.4-2014	-/-	American National Standard for Methods of Measurement of Radio-Noise Emissions from Low-Voltage Electrical and Electronic Equipment in the Range of 9 kHz to 40 GHz
ANSI C63.10-2013	-/-	American National Standard of Procedures for Compliance Testing of Unlicensed Wireless Devices

#### 4 Reporting statements of conformity – decision rule

Only the measured values related to their corresponding limits will be used to decide whether the equipment under test meets the requirements of the test standards listed in chapter 3. The measurement uncertainty is mentioned in this test report, see chapter 9, but is not taken into account - neither to the limits nor to the measurement results. Measurement results with a smaller margin to the corresponding limits than the measurement uncertainty have a potential risk of more than 5% that the decision might be wrong."

measured value, measurement uncertainty, verdict

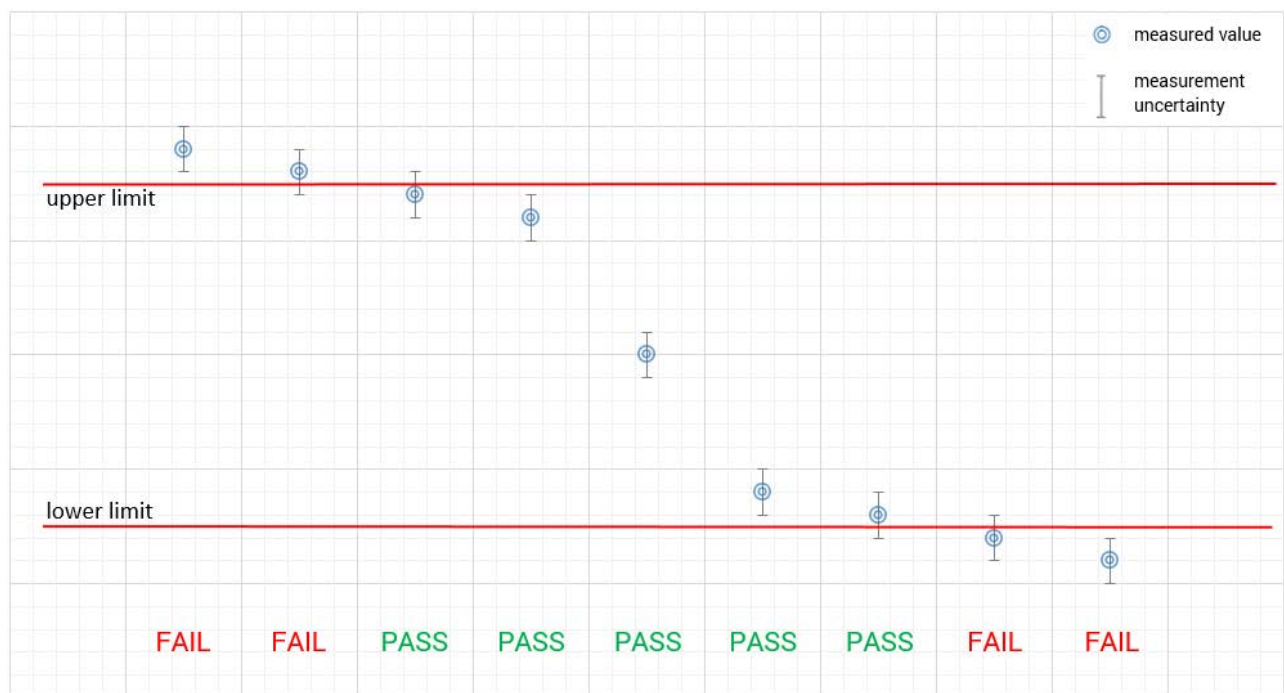

## 5 Test environment

Temperature	:	T <sub>nom</sub> T <sub>max</sub> T <sub>min</sub>	+22 °C during room temperature tests No tests under extreme environmental conditions required. No tests under extreme environmental conditions required.
Relative humidity content	:		50 %
Barometric pressure	:		1022 hpa
Power supply	:	V <sub>nom</sub> V <sub>max</sub> V <sub>min</sub>	12.0 V DC by external power supply No tests under extreme environmental conditions required. No tests under extreme environmental conditions required.

## 6 Test item

### 6.1 General description

Kind of test item	:	Telematics Control Unit Generation 2
Model name	:	TCU2 NA IP67
HMN	:	N/A
PMN	:	TCU2 NA IP67
HVIN	:	TCU2 NA IP67
FVIN	:	N/A
S/N serial number	:	3050003060
Hardware status	:	5968H04
Software status	:	23.04.S.010.4
Firmware status	:	N/A
Frequency band	:	2400 MHz to 2483.5 MHz
Type of radio transmission	:	DSSS, OFDM
Use of frequency spectrum	:	
Type of modulation	:	(D)BPSK, (D)QPSK, 16 – QAM, 64 – QAM
Number of channels	:	11
Antenna	:	Two Integrated antennas with MIMO capability
Power supply	:	12.0 V DC by vehicle battery
Temperature range	:	-40°C to +65°C

### 6.2 Additional information

The content of the following annexes is defined in the QA. It may be that not all of the listed annexes are necessary for this report, thus some values in between may be missing.

Test setup and EUT photos are included in test report: 1-6579\_23-01-13\_AnnexA  
1-6579\_23-01-13\_AnnexD

## 7 Description of the test setup

Typically, the calibrations of the test apparatus are commissioned to and performed by an accredited calibration laboratory. The calibration intervals are determined in accordance with the DIN EN ISO/IEC 17025. In addition to the external calibrations, the laboratory executes comparison measurements with other calibrated test systems or effective verifications. Weekly chamber inspections and range calibrations are performed. Where possible, RF generating and signaling equipment as well as measuring receivers and analyzers are connected to an external high-precision 10 MHz reference (GPS-based or rubidium frequency standard).

In order to simplify the identification of the equipment used at some special tests, some items of test equipment and ancillaries can be provided with an identifier or number in the equipment list below (Lab/Item).

Each block diagram listed can contain several test setup configurations. All devices belonging to a test setup are identified with the same letter syntax. For example: Column Setup and all devices with an A.

### **Agenda:** Kind of Calibration

k	calibration / calibrated	EK	limited calibration
ne	not required (k, ev, izw, zw not required)	zw	cyclical maintenance (external cyclical maintenance)
ev	periodic self verification	izw	internal cyclical maintenance
Ve	long-term stability recognized	g	blocked for accredited testing
vlk!	Attention: extended calibration interval		
NK!	Attention: not calibrated	*)	next calibration ordered / currently in progress



## 7.1 Shielded semi anechoic chamber

The radiated measurements are performed in vertical and horizontal plane in the frequency range from 30 MHz to 1 GHz in semi-anechoic chambers. The EUT is positioned on a non-conductive support with a height of 0.80 m above a conductive ground plane that covers the whole chamber. The receiving antennas are conform to specifications ANSI C63. These antennas can be moved over the height range between 1.0 m and 4.0 m in order to search for maximum field strength emitted from EUT. The measurement distances between EUT and receiving antennas are indicated in the test setups for the various frequency ranges. For each measurement, the EUT is rotated in all three axes until the maximum field strength is received. The wanted and unwanted emissions are received by spectrum analyzers where the detector modes and resolution bandwidths over various frequency ranges are set according to requirement ANSI C63.

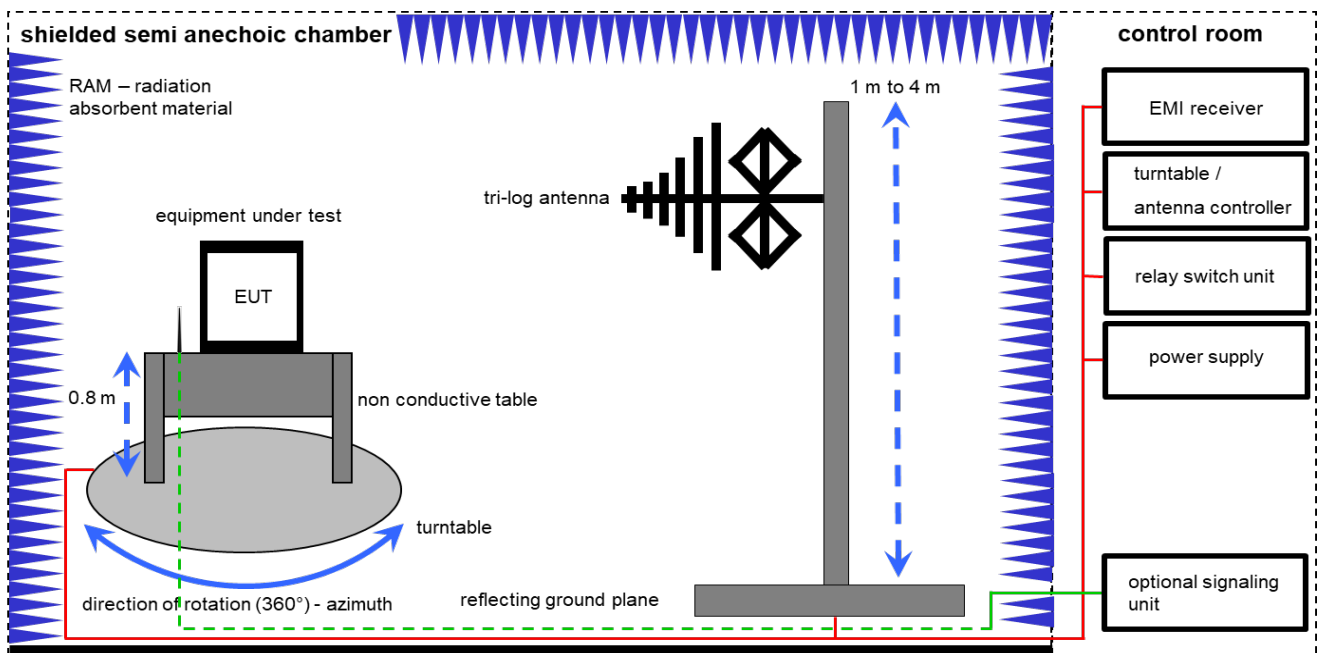

Measurement distance: tri-log antenna 10 meter; EMC32 software version: 10.59.00

FS = UR + CL + AF

(FS-field strength; UR-voltage at the receiver; CL-loss of the cable; AF-antenna factor)

Example calculation:

FS [dB $\mu$ V/m] = 12.35 [dB $\mu$ V/m] + 1.90 [dB] + 16.80 [dB/m] = 31.05 [dB $\mu$ V/m] (35.69  $\mu$ V/m)

### Equipment table:

No.	Setup	Equipment	Type	Manufacturer	Serial No.	INV. No.	Kind of Calibration	Last Calibration	Next Calibration
1	A	Switch-Unit	3488A	HP	2719A14505	300000368	ev	-/-	-/-
2	A	Semi anechoic chamber	3000023	MWB AG	-/-	300000551	ne	-/-	-/-
3	A	Antenna Tower	Model 2175	ETS-Lindgren	64762	300003745	izw	-/-	-/-
4	A	Positioning Controller	Model 2090	ETS-Lindgren	64672	300003746	izw	-/-	-/-
5	A	Turntable Interface-Box	Model 105637	ETS-Lindgren	44583	300003747	izw	-/-	-/-
6	A	TRILOG Broadband Test-Antenna 30 MHz - 3 GHz	VULB9163	Schwarzbeck Mess-Elektronik	216	300003288	vKI!	31.08.2023	31.08.2025
7	A	Turntable	2089-4.0	EMCO	-/-	300004394	ne	-/-	-/-
8	A	PC	Tecline	F+W	-/-	300004388	ne	-/-	-/-
9	A	EMI Test Receiver	ESR3	Rohde & Schwarz	102587	300005771	k	06.12.2023	31.12.2024

## 7.2 Shielded fully anechoic chamber

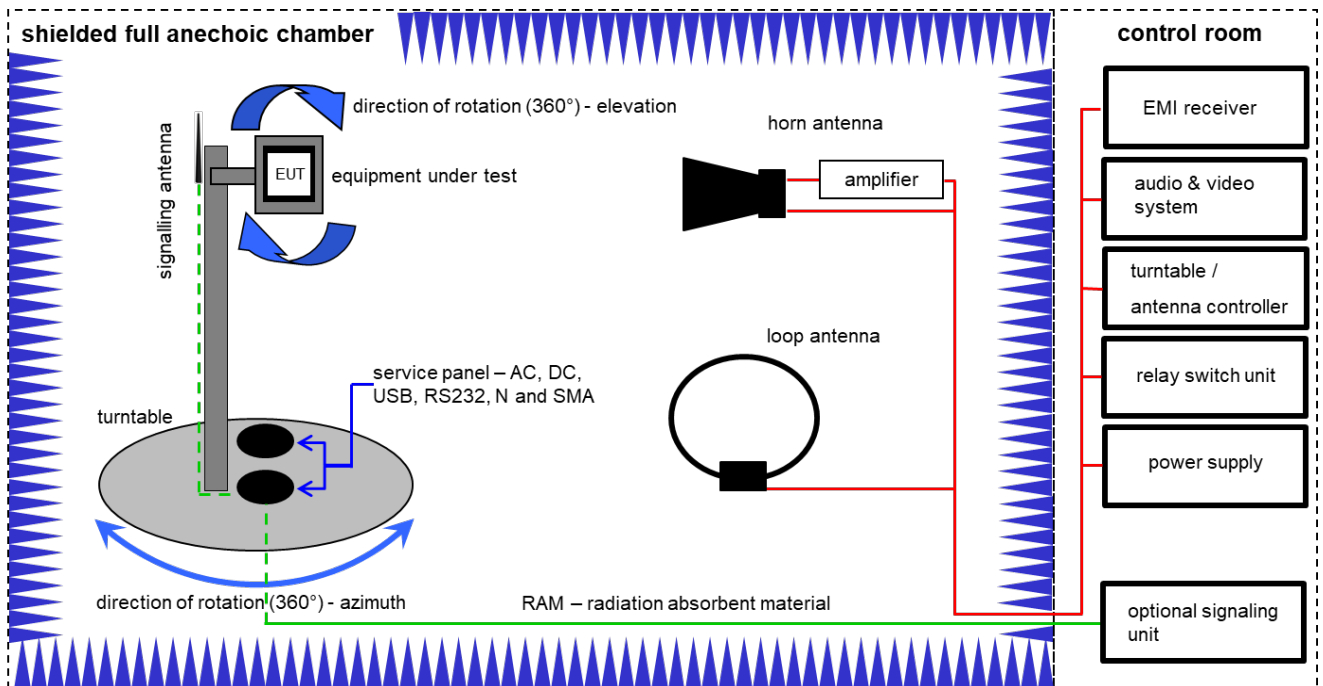

Measurement distance: horn antenna 3 meter; loop antenna 3 meter / 1 meter

$$FS = UR + CA + AF$$

(FS-field strength; UR-voltage at the receiver; CA-loss of the signal path; AF-antenna factor)

### Example calculation:

$$FS \text{ [dB}\mu\text{V/m]} = 40.0 \text{ [dB}\mu\text{V/m]} + (-35.8) \text{ [dB]} + 32.9 \text{ [dB/m]} = 37.1 \text{ [dB}\mu\text{V/m]} \text{ (71.61 } \mu\text{V/m)}$$

### Equipment table:

No.	Setup	Equipment	Type	Manufacturer	Serial No.	INV. No.	Kind of Calibration	Last Calibration	Next Calibration
1	A, B, C	Double-Ridged Waveguide Horn Antenna 1-18.0GHz	3115	EMCO	8812-3089	300000307	vK!	11.02.2022	29.02.2024
2	C	Active Loop Antenna 9 kHz to 30 MHz	6502	EMCO	2210	300001015	vK!	02.08.2023	31.08.2025
3	B	Highpass Filter	WHK1.1/15G-10SS	Wainwright	37	400000148	ne	-/-	-/-
4	B	Highpass Filter	WHKX7.0/18G-8SS	Wainwright	18	300003789	ne	-/-	-/-
5	B	Band Reject Filter	WRCG2400/2483-2375/2505-50/10SS	Wainwright	26	300003792	ne	-/-	-/-
6	A, B, C	Broadband Amplifier 0.5-18 GHz	CBLU5184540	CERNEX	22051	300004483	ev	-/-	-/-
7	A, B, C	4U RF Switch Platform	L4491A	Agilent Technologies	MY50000032	300004510	ne	-/-	-/-
8	A, B, C	Computer	Intel Core i3 3220/3,3 GHz, Prozessor	-/-	2V2403033A54 21	300004591	ne	-/-	-/-
9	A, B, C	NEXIO EMV-Software	BAT EMC V2022.0.22.0	Nexio	-/-	300004682	ne	-/-	-/-
10	A, B, C	Anechoic chamber	-/-	TDK	-/-	300003726	ne	-/-	-/-
11	A, B, C	EMI Test Receiver 20Hz – 26,5GHz	ESU26	R&S	100037	300003555	k	11.12.2023	31.12.2024
12	B	RF-Amplifier	AMF-6F06001800-30-10P-R	NARDA-MITEQ Inc	2011571	300005240	ev	-/-	-/-

### 7.3 Radiated measurements > 18 GHz

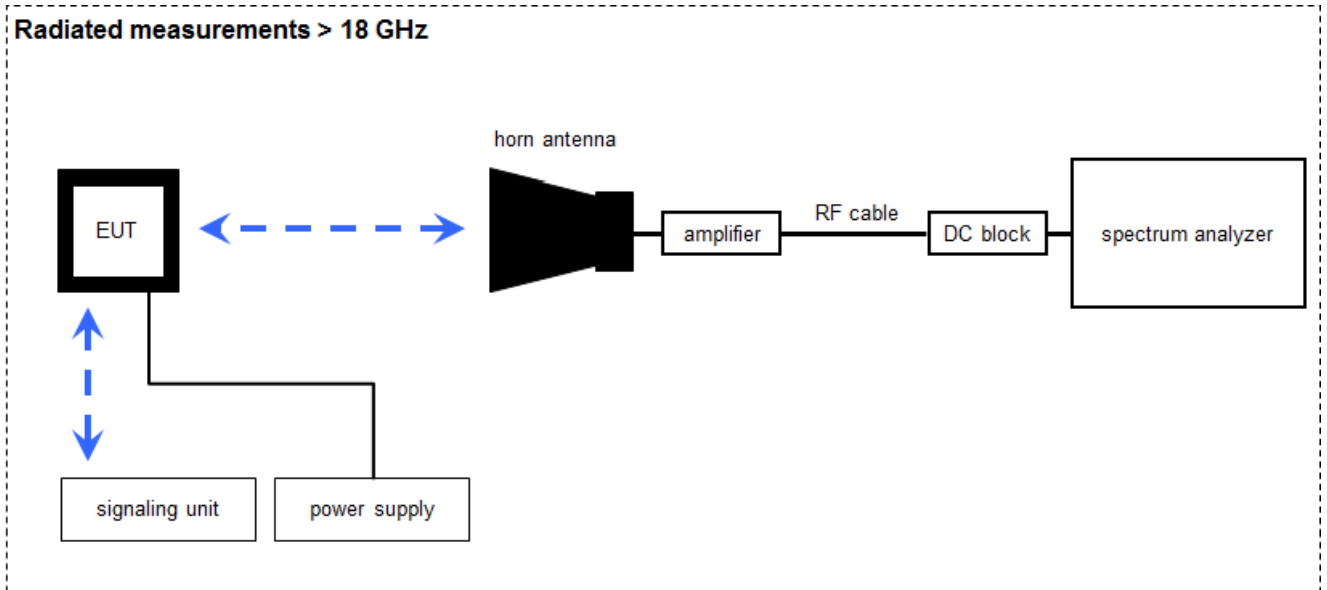

Measurement distance: horn antenna 50 cm

$$FS = UR + CA + AF$$

(FS-field strength; UR-voltage at the receiver; CA-loss signal path & distance correction; AF-antenna factor)

*Example calculation:*

$$FS \text{ [dB}\mu\text{V/m]} = 40.0 \text{ [dB}\mu\text{V/m]} + (-60.1) \text{ [dB]} + 36.74 \text{ [dB/m]} = 16.64 \text{ [dB}\mu\text{V/m]} \text{ (6.79 } \mu\text{V/m)}$$

**Equipment table:**

No.	Setup	Equipment	Type	Manufacturer	Serial No.	INV. No.	Kind of Calibration	Last Calibration	Next Calibration
1	A	Microwave System Amplifier, 0.5-26.5 GHz	83017A	HP	00419	300002268	ev	-/-	-/-
2	A	Std. Gain Horn Antenna 18.0-26.5 GHz	638	Narda	8205	300002442	k	17.01.2022 24.01.2024	31.01.2024 23.01.2026
3	A	Signal analyzer	FSV40	Rohde&Schwarz	101042	300004517	k	06.12.2023	31.12.2024
4	A	RF-Cable	ST18/SMAm/SMAm /48	Huber & Suhner	Batch no. 600918	400001182	ev	-/-	-/-
5	A	DC-Blocker 0.1-40 GHz	8141A	Inmet	-/-	400001185	ev	-/-	-/-

## 7.4 Conducted measurements Bluetooth system

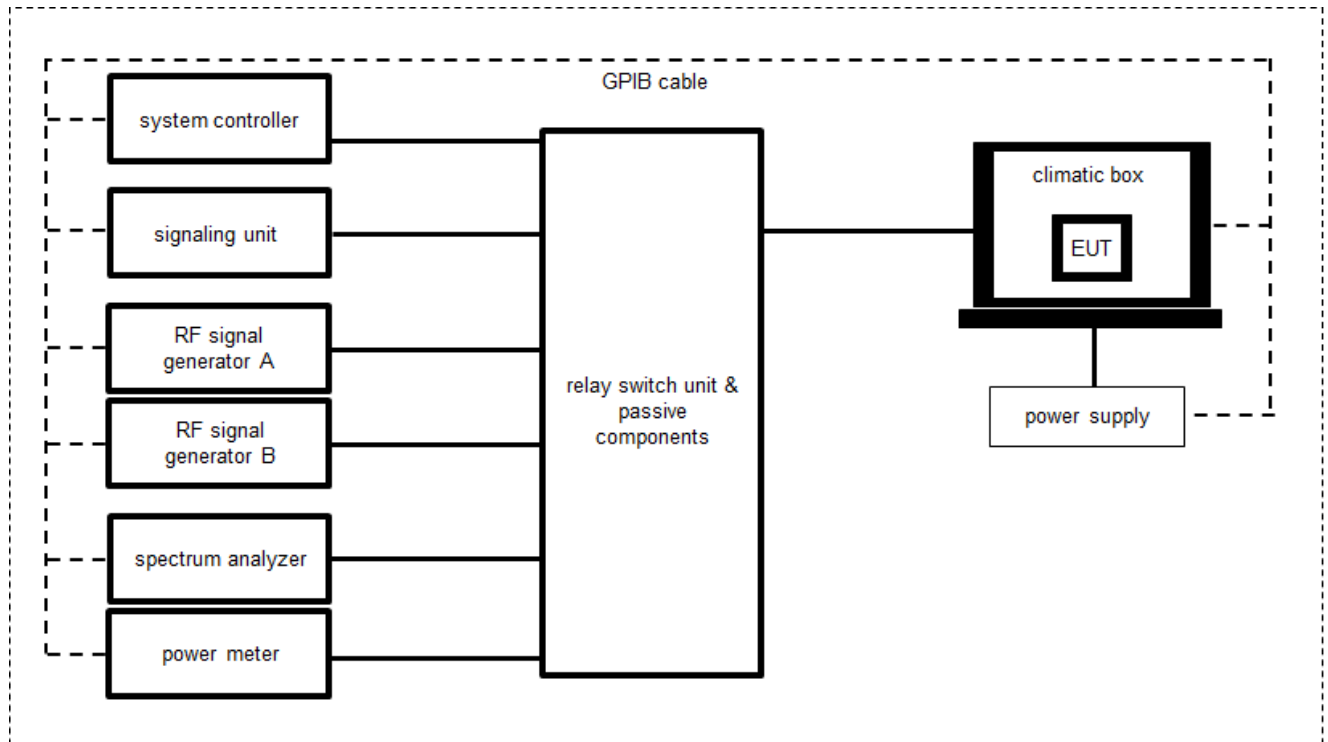

OP = AV + CA  
 (OP-output power; AV-analyzer value; CA-loss signal path)

Example calculation:

OP [dBm] = 6.0 [dBm] + 11.7 [dB] = 17.7 [dBm] (58.88 mW)

**Equipment table:**

No.	Setup	Equipment	Type	Manufacturer	Serial No.	INV. No.	Kind of Calibration	Last Calibration	Next Calibration
1	A	Switch / Control Unit (including DC-Block, Splitter)	3488A	HP	-/-	300000929	ne	-/-	-/-
2	A	Hygro-Thermometer	-/, 5-45C, 20-100rF	Thies Clima	-/-	400000080	ev	15.09.2022	14.09.2024
3	A	Signal analyzer	FSV30	Rohde&Schwarz	1321.3008K30/103170	300004855	vKI!	09.12.2022	31.12.2024
4	A	USB-GPIB-Interface	82357B	Agilent Technologies	MY54323070	300004852	ne	-/-	-/-
5	A	Tester Software C.BER	Version 5.0	cetecom advanced GmbH	0001	400001379	ne	-/-	-/-
6	A	Switch matrix	RSM 1.1	cetecom advanced GmbH	31534892	400001456	ev	20.09.2023	19.09.2024

## 8 Sequence of testing

### 8.1 Sequence of testing radiated spurious 9 kHz to 30 MHz

#### Setup

- The equipment is set up to simulate normal operation mode as described in the user manual or defined by the manufacturer.
- If the EUT is a tabletop system, it is placed on a table with 0.8 m height.
- If the EUT is a floor standing device, it is placed directly on the turn table.
- Auxiliary equipment and cables are positioned to simulate normal operation conditions as described in ANSI C 63.4.
- The AC power port of the EUT (if available) is connected to a power outlet below the turntable.
- Measurement distance is 3 m (see ANSI C 63.4) – see test details.
- EUT is set into operation.

#### Premeasurement\*

- The turntable rotates from 0° to 315° using 45° steps.
- The antenna height is 1 m.
- At each turntable position the analyzer sweeps with positive-peak detector to find the maximum of all emissions.

#### Final measurement

- Identified emissions during the pre-measurement are maximized by the software by rotating the turntable from 0° to 360°.
- Loop antenna is rotated about its vertical axis for maximum response at each azimuth about the EUT. (For certain applications, the loop antenna plane may also need to be positioned horizontally at the specified distance from the EUT)
- The final measurement is done in the position (turntable and elevation) causing the highest emissions with quasi-peak (as described in ANSI C 63.4).
- Final levels, frequency, measuring time, bandwidth, turntable position, correction factor, margin to the limit and limit will be recorded. A plot with the graph of the premeasurement and the limit is stored.

\*Note: The sequence will be repeated three times with different EUT orientations.

## 8.2 Sequence of testing radiated spurious 30 MHz to 1 GHz

### Setup

- The equipment is set up to simulate normal operation mode as described in the user manual or defined by the manufacturer.
- If the EUT is a tabletop system, a table with 0.8 m height is used, which is placed on the ground plane.
- If the EUT is a floor standing device, it is placed on the ground plane with insulation between both.
- Auxiliary equipment and cables are positioned to simulate normal operation conditions as described in ANSI C 63.4.
- The AC power port of the EUT (if available) is connected to a power outlet below the turntable.
- Measurement distance is 10 m or 3 m (see ANSI C 63.4) – see test details.
- EUT is set into operation.

### Premeasurement

- The turntable rotates from 0° to 315° using 45° steps.
- The antenna is polarized vertical and horizontal.
- The antenna height changes from 1 m to 3 m.
- At each turntable position, antenna polarization and height the analyzer sweeps three times in peak to find the maximum of all emissions.

### Final measurement

- The final measurement is performed for at least six highest peaks according to the requirements of the ANSI C63.4.
- Based on antenna and turntable positions at which the peak values are measured the software maximize the peaks by changing turntable position  $\pm 45^\circ$  and antenna height between 1 and 4 m.
- The final measurement is done with quasi-peak detector (as described in ANSI C 63.4).
- Final levels, frequency, measuring time, bandwidth, antenna height, antenna polarization, turntable angle, correction factor, margin to the limit and limit are recorded. A plot with the graph of the premeasurement with marked maximum final results and the limit is stored.

### 8.3 Sequence of testing radiated spurious 1 GHz to 18 GHz

#### Setup

- The equipment is set up to simulate normal operation mode as described in the user manual or defined by the manufacturer.
- If the EUT is a tabletop system, a 2-axis positioner with 1.5 m height is used.
- If the EUT is a floor standing device, it is placed directly on the turn table.
- Auxiliary equipment and cables are positioned to simulate normal operation conditions as described in ANSI C 63.4.
- The AC power port of the EUT (if available) is connected to a power outlet below the turntable.
- Measurement distance is 3 m (see ANSI C 63.4) – see test details.
- EUT is set into operation.

#### Premeasurement

- The turntable rotates from 0° to 315° using 45° steps.
- The antenna is polarized vertical and horizontal.
- The antenna height is 1.5 m.
- At each turntable position and antenna polarization the analyzer sweeps with positive peak detector to find the maximum of all emissions.

#### Final measurement

- The final measurement is performed for at least six highest peaks according to the requirements of the ANSI C63.4.
- Based on antenna and turntable positions at which the peak values are measured the software maximizes the peaks by rotating the turntable from 0° to 360°. This measurement is repeated for different EUT-table positions (0° to 150° in 30°-steps) and for both antenna polarizations.
- The final measurement is done in the position (turntable, EUT-table and antenna polarization) causing the highest emissions with Peak and RMS detector (as described in ANSI C 63.4).
- Final levels, frequency, measuring time, bandwidth, turntable position, EUT-table position, antenna polarization, correction factor, margin to the limit and limit are recorded. A plot with the graph of the premeasurement with marked maximum final results and the limit is stored.

## 8.4 Sequence of testing radiated spurious above 18 GHz

### Setup

- The equipment is set up to simulate normal operation mode as described in the user manual or defined by the manufacturer.
- Auxiliary equipment and cables are positioned to simulate normal operation conditions as described in ANSI C 63.4.
- The AC power port of the EUT (if available) is connected to a power outlet.
- The measurement distance is as appropriate (e.g. 0.5 m).
- The EUT is set into operation.

### Premeasurement

- The test antenna is handheld and moved carefully over the EUT to cover the EUT's whole sphere and different polarizations of the antenna.

### Final measurement

- The final measurement is performed at the position and antenna orientation causing the highest emissions with Peak and RMS detector (as described in ANSI C 63.4).
- Final levels, frequency, measuring time, bandwidth, correction factor, margin to the limit and limit are recorded. A plot with the graph of the premeasurement and the limit is stored.



## 9 Measurement uncertainty

Measurement uncertainty		
Test case	Uncertainty	
Antenna gain	± 3 dB	
Power spectral density	± 1.56 dB	
DTS bandwidth	± 100 kHz (depends on the used RBW)	
Occupied bandwidth	± 100 kHz (depends on the used RBW)	
Maximum output power conducted	± 1.56 dB	
Detailed spurious emissions @ the band edge - conducted	± 1.56 dB	
Band edge compliance radiated	± 3 dB	
Spurious emissions conducted	> 3.6 GHz	± 1.56 dB
	> 7 GHz	± 1.56 dB
	> 18 GHz	± 2.31 dB
	≥ 40 GHz	± 2.97 dB
Spurious emissions radiated below 30 MHz	± 3 dB	
Spurious emissions radiated 30 MHz to 1 GHz	± 3 dB	
Spurious emissions radiated 1 GHz to 12.75 GHz	± 3.7 dB	
Spurious emissions radiated above 12.75 GHz	± 4.5 dB	
Spurious emissions conducted below 30 MHz (AC conducted)	± 2.6 dB	

## 10 Summary of measurement results

<input checked="" type="checkbox"/>	No deviations from the technical specifications were ascertained
<input type="checkbox"/>	There were deviations from the technical specifications ascertained
<input type="checkbox"/>	This test report is only a partial test report. The content and verdict of the performed test cases are listed below.

TC Identifier	Description	Verdict	Date	Remark
RF-Testing	CFR Part 15 RSS - 247, Issue 3	See table!	2024-03-01	-/-

Test specification clause	Test case	Guideline	Temperature & voltage conditions	C	NC	NA	NP	Remark
§15.247(b)(4) RSS - 247 / 5.4 (f)(ii)	Antenna gain	-/-	Nominal	-/-				-/-
§15.35	Duty cycle	-/-	Nominal	-/-				-/-
§15.247(e) RSS - 247 / 5.2 (b)	Power spectral density	KDB 558074 DTS clause: 8.4	Nominal	<input checked="" type="checkbox"/>	<input type="checkbox"/>	<input type="checkbox"/>	<input type="checkbox"/>	-/-
§15.247(a)(2) RSS - 247 / 5.2 (a)	DTS bandwidth	KDB 558074 DTS clause: 8.2	Nominal	<input checked="" type="checkbox"/>	<input type="checkbox"/>	<input type="checkbox"/>	<input type="checkbox"/>	-/-
RSS Gen clause 4.6.1	Occupied bandwidth	-/-	Nominal	<input checked="" type="checkbox"/>	<input type="checkbox"/>	<input type="checkbox"/>	<input type="checkbox"/>	-/-
§15.247(b)(3) RSS - 247 / 5.4 (d)	Maximum output power	ANSI C63.10- 2013 Chapter 11.9.2.2.2	Nominal	<input checked="" type="checkbox"/>	<input type="checkbox"/>	<input type="checkbox"/>	<input type="checkbox"/>	-/-
§15.247(d) RSS - 247 / 5.5	Detailed spurious emissions @ the band edge – cond.	-/-	Nominal	<input checked="" type="checkbox"/>	<input type="checkbox"/>	<input type="checkbox"/>	<input type="checkbox"/>	-/-
§15.205 RSS - 247 / 5.5 RSS - Gen	Band edge compliance cond. or rad.	KDB 558074 DTS clause: 8.7.3	Nominal	<input checked="" type="checkbox"/>	<input type="checkbox"/>	<input type="checkbox"/>	<input type="checkbox"/>	-/-
§15.247(d) RSS - 247 / 5.5	TX spurious emissions cond.	KDB 558074 DTS clause: 8.5	Nominal	<input checked="" type="checkbox"/>	<input type="checkbox"/>	<input type="checkbox"/>	<input type="checkbox"/>	-/-
§15.209(a) RSS-Gen	TX spurious emissions rad. below 30 MHz	-/-	Nominal	<input checked="" type="checkbox"/>	<input type="checkbox"/>	<input type="checkbox"/>	<input type="checkbox"/>	-/-
§15.247(d) RSS - 247 / 5.5 RSS-Gen	TX spurious emissions rad. 30 MHz to 1 GHz	-/-	Nominal	<input checked="" type="checkbox"/>	<input type="checkbox"/>	<input type="checkbox"/>	<input type="checkbox"/>	-/-
§15.247(d) RSS - 247 / 5.5 RSS-Gen	TX spurious emissions rad. above 1 GHz	-/-	Nominal	<input checked="" type="checkbox"/>	<input type="checkbox"/>	<input type="checkbox"/>	<input type="checkbox"/>	-/-
§15.107(a) §15.207	Conducted emissions < 30 MHz	-/-	Nominal	<input type="checkbox"/>	<input type="checkbox"/>	<input checked="" type="checkbox"/>	<input type="checkbox"/>	-/-

**Notes:**

<b>C</b>	Compliant	<b>NC</b>	Not compliant	<b>NA</b>	Not applicable	<b>NP</b>	Not performed
----------	-----------	-----------	---------------	-----------	----------------	-----------	---------------

## 11 Additional information and comments

Reference documents: None

Co-applicable documents: 1-6579\_23-01-15\_TR1\_A201.pdf

Special test descriptions: All tests were performed with both ports/antennas transmitting simultaneously. All modes only support MIMO, not SISO.

Configuration descriptions: Used power setting:  
 b-mode: 16  
 g-mode: 13  
 nHT20-mode: 13

EUT selection:

- Only one device available
- Devices selected by the customer
- Devices selected by the laboratory (Randomly)

Provided channels:

Channels with 20 MHz channel bandwidth:

channel number & center frequency													
channel	1	2	3	4	5	6	7	8	9	10	11	12	13
f <sub>c</sub> / MHz	<b>2412</b>	2417	2422	2427	2432	<b>2437</b>	2442	2447	2452	2457	<b>2462</b>	2467	2472

Note: The channels used for the tests are marked in bold in the list.

## 12 Additional EUT parameter

- Test mode:
- No test mode available  
lperf was used to ping another device with the largest support packet size
  - Test mode available  
Special software is used.  
EUT is transmitting pseudo random data by itself
- Modulation types:
- Wide Band Modulation (None Hopping – e.g. DSSS, OFDM)
  - Frequency Hopping Spread Spectrum (FHSS)
- Antennas and transmit operating modes:
- Operating mode 1 (single antenna)
    - Equipment with 1 antenna,
    - Equipment with 2 diversity antennas operating in switched diversity mode by which at any moment in time only 1 antenna is used,
    - Smart antenna system with 2 or more transmit/receive chains, but operating in a mode where only 1 transmit/receive chain is used)
  - Operating mode 2 (multiple antennas, no beamforming)
    - Equipment operating in this mode contains a smart antenna system using two or more transmit/receive chains simultaneously but without beamforming.
  - Operating mode 3 (multiple antennas, with beamforming)
    - Equipment operating in this mode contains a smart antenna system using two or more transmit/receive chains simultaneously with beamforming.  
In addition to the antenna assembly gain (G), the beamforming gain (Y) may have to be taken into account when performing the measurements.

### 13 Measurement results

#### 13.1 Antenna gain

**Limits:**

FCC	ISED
6 dBi / > 6 dBi output power and power density reduction required	

**Results:**

antenna port 1	lowest channel	middle channel	highest channel
Gain [dBi] / Declared	5.1		

antenna port 2	lowest channel	middle channel	highest channel
Gain [dBi] / Declared	5.1		

## 13.2 Identify worst case data rate

### Description:

All modes of the module will be measured with an average power meter or spectrum analyzer to identify the maximum transmission power.

In further tests only the identified worst case modulation scheme or bandwidth will be measured and this mode is used as representative mode for all other modulation schemes.

### Measurement:

Measurement parameter	
Detector	Peak
Sweep time	Auto
Resolution bandwidth	3 MHz
Video bandwidth	3 MHz
Trace mode	Max hold
Test setup	See chapter 7.4 setup A
Measurement uncertainty	See chapter 9

### Results:

Modulation scheme / bandwidth	
DSSS / b – mode	1 Mbit/s
OFDM / g – mode	6 Mbit/s
OFDM / n HT20 – mode	MCS0

### 13.3 Maximum output power

**Description:**

Measurement of the maximum conducted average output power. The measurements are performed using the data rate identified in the previous chapter.

**Measurement:**

Measurement parameter	
According to ANSI C63.10-2013 Chapter 11.9.2.2.2	
External result file(s)	1-6579_23-01-15_TR1_A201.pdf
Test setup	See chapter 7.4 setup B
Measurement uncertainty	See chapter 9

**Limits:**

FCC	ISED
Conducted 1.0 W / 30 dBm with an antenna gain of max. 6 dBi	

**Results:**

antenna port 1	maximum output power / dBm		
	lowest channel	middle channel	highest channel
Output power conducted DSSS / b – mode	14.1	14.7	14.7
Output power conducted OFDM / g – mode	11.1	11.4	11.4
Output power conducted OFDM / n HT20 – mode	13.5	9.3	9.3

antenna port 2	maximum output power / dBm		
	lowest channel	middle channel	highest channel
Output power conducted DSSS / b – mode	14.9	15.7	15.5
Output power conducted OFDM / g – mode	11.1	11.6	11.3
Output power conducted OFDM / n HT20 – mode	12.3	9.5	9.2

antenna port 1 + 2 calculated	maximum output power / dBm		
	lowest channel	middle channel	highest channel
Output power conducted DSSS / b – mode	17.5	18.2	18.1
Output power conducted OFDM / g – mode	14.1	14.5	14.4
Output power conducted OFDM / n HT20 – mode	16.0	12.4	12.3



### 13.4 Duty cycle

**Description:**

Measurement of the timing behavior.

**Measurement:**

Measurement parameter	
Detector	Peak
Sweep time	Depends on the signal see plot
Resolution bandwidth	10 MHz
Video bandwidth	10 MHz
Trace mode	Max hold
Test setup	See chapter 7.4 setup A
Measurement uncertainty	See chapter 9

**Limits:**

FCC	ISED
No limitation!	

**Results:**

T <sub>nom</sub>	V <sub>nom</sub>	lowest channel	middle channel	highest channel
DSSS / b – mode		100 % / 0.0 dB	100 % / 0.0 dB	100 % / 0.0 dB
OFDM / g – mode		100 % / 0.0 dB	100 % / 0.0 dB	100 % / 0.0 dB
OFDM / n HT20 – mode		100 % / 0.0 dB	100 % / 0.0 dB	100 % / 0.0 dB

### 13.5 Average power spectral density

**Measurement:**

Measurement parameter	
According to DTS clause: 8.4	
External result file(s)	1-6579_23-01-15_TR1_A201.pdf
Test setup	See chapter 7.4 setup A
Measurement uncertainty	See chapter 9

**Limits:**

FCC	ISED
8 dBm / 3 kHz (conducted)	

**Results:** antenna port 1

measured	average power spectral density / dBm @ 3 kHz		
	Lowest channel	Middle channel	Highest channel
DSSS / b – mode	-17.2	-17.0	-17.0
OFDM / g – mode	-23.3	-23.1	-22.9
OFDM / n HT20 – mode	-21.2	-24.2	-24.4

**Results:** antenna port 2

measured	average power spectral density / dBm @ 3 kHz		
	Lowest channel	Middle channel	Highest channel
DSSS / b – mode	-16.9	-16.2	-16.4
OFDM / g – mode	-23.3	-22.6	-23.1
OFDM / n HT20 – mode	-21.5	-24.2	-24.6

**Results:** antenna port 1 + 2

measured	average power spectral density / dBm @ 3 kHz		
	Lowest channel	Middle channel	Highest channel
DSSS / b – mode	-14.0	-13.6	-13.7
OFDM / g – mode	-20.3	-19.8	-20.0
OFDM / n HT20 – mode	-18.3	-21.2	-21.5

## 13.6 6 dB DTS bandwidth

### Description:

Measurement of the 6 dB bandwidth of the modulated signal.

### Measurement:

Measurement parameter	
According to DTS clause: 8.2	
Detector	Peak
Sweep time	Auto
Resolution bandwidth	100 kHz
Video bandwidth	500 kHz
Span	30 MHz / 50 MHz
Trace mode	Single count with 200 counts
External result file(s)	1-6579_23-01-15_TR1_A201.pdf
Test setup	See chapter 7.4 setup A
Measurement uncertainty	See chapter 9

### Limits:

FCC	ISED
Systems using digital modulation techniques may operate in the 2400–2483.5 MHz band. The minimum 6 dB bandwidth shall be at least 500 kHz.	

### Results:

antenna port 1	6 dB DTS bandwidth / kHz		
	lowest channel	middle channel	highest channel
DSSS / b – mode	8060	8064	8060
OFDM / g – mode	15296	15112	15104
OFDM / n HT20 – mode	16420	16440	16432

antenna port 2	6 dB DTS bandwidth / kHz		
	lowest channel	middle channel	highest channel
DSSS / b – mode	8068	8068	8068
OFDM / g – mode	15120	15120	15116
OFDM / n HT20 – mode	16456	16464	16464

### 13.7 Occupied bandwidth – 99% emission bandwidth

#### Description:

Measurement of the 99% bandwidth of the modulated signal acc. RSS-GEN.

#### Measurement:

Measurement parameter	
Detector	Peak
Sweep time	Auto
Resolution bandwidth	300 kHz
Video bandwidth	1 MHz
Span	30 MHz / 50 MHz
Measurement procedure	Measurement of the 99% bandwidth using the integration function of the analyzer
Trace mode	Single count with 200 counts
External result file(s)	1-6579_23-01-15_TR1_A201.pdf
Test setup	See chapter 7.4 setup A
Measurement uncertainty	See chapter 9

#### Usage:

-/-	ISED
OBW is necessary for Emission Designator	

#### Results:

antenna port 1	99% emission bandwidth / kHz		
	lowest channel	middle channel	highest channel
DSSS / b – mode	13287	13323	13387
OFDM / g – mode	16474	16438	16446
OFDM / n HT20 – mode	17198	17158	17150

antenna port 2	99% emission bandwidth / kHz		
	lowest channel	middle channel	highest channel
DSSS / b – mode	13543	13615	13859
OFDM / g – mode	16438	16482	16494
OFDM / n HT20 – mode	17166	17162	17174

### 13.8 Occupied bandwidth – 20 dB bandwidth

#### Description:

Measurement of the 20 dB bandwidth of the modulated carrier.

#### Measurement:

Measurement parameter	
Detector	Peak
Sweep time	Auto
Resolution bandwidth	100 kHz
Video bandwidth	500 kHz
Span	30 MHz / 50 MHz
Trace mode	Single count with min. 200 counts
External result file(s)	1-6579_23-01-15_TR1_A201.pdf
Test setup	See chapter 7.4 setup A
Measurement uncertainty	See chapter 9

#### Usage:

-/-	ISED
The complete bandwidth has to be within the frequency range of the band.	

#### Results:

antenna port 1	20 dB bandwidth / MHz		
	lowest channel	middle channel	highest channel
DSSS / b – mode	15376	15388	15404
OFDM / g – mode	18488	17996	18004
OFDM / n HT20 – mode	20284	20092	20464

antenna port 2	20 dB bandwidth / MHz		
	lowest channel	middle channel	highest channel
DSSS / b – mode	15736	15780	16200
OFDM / g – mode	18060	18360	18352
OFDM / n HT20 – mode	20220	19912	19928

### 13.9 Band edge compliance radiated

**Description:**

Measurement of the radiated band edge compliance. The EUT is turned in the position that results in the maximum level at the band edge. Then a sweep over the corresponding restricted band is performed. The EUT is set to the lowest channel for the lower restricted band and to the highest channel for the upper restricted band. Measurement distance is 3 meter.

**Measurement:**

	Measurement parameter for peak measurements	Measurement parameter for average measurements
		According to DTS clause: 8.7.3
Detector	Peak	RMS
Sweep time	Auto	Auto
Resolution bandwidth	1 MHz	100 kHz
Video bandwidth	3 MHz	300 kHz
Span	See plot	2 MHz
Trace mode	Max. hold	RMS Average over 101 sweeps
Analyzer function	-/-	Band power function (Compute the power by integrating the spectrum over 1 MHz)
Test setup	See chapter 7.2 setup A	
Measurement uncertainty	See chapter 9	

**Limits:**

FCC	ISED
74 dBµV/m @ 3 m (Peak) 54 dBµV/m @ 3 m (AVG)	

**Results:**

band edge compliance radiated / (dBµV / m) @ 3 m			
	b-mode	g-mode	nHT20-mode
Lower band edge	46.4 dBµV/m AVG 56.8 dBµV/m Peak	49.3 dBµV/m AVG 62.8 dBµV/m Peak	51.8 dBµV/m AVG 66.9 dBµV/m Peak
Upper band edge	46.8 dBµV/m AVG 58.4 dBµV/m Peak	52.9 dBµV/m AVG 68.1 dBµV/m Peak	53.8 dBµV/m AVG 71.1 dBµV/m Peak

**Plots:** b-mode - peak / average

**Plot 1:** TX mode, lower band edge, vertical & horizontal polarization

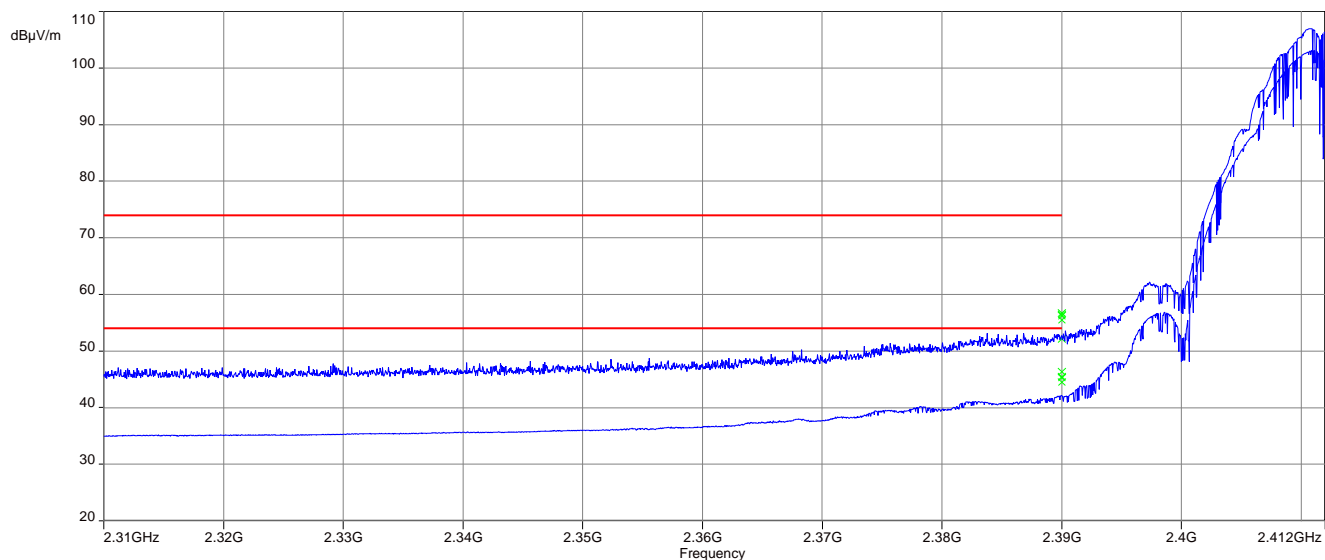

**Plot 2:** TX mode, upper band edge, vertical & horizontal polarization

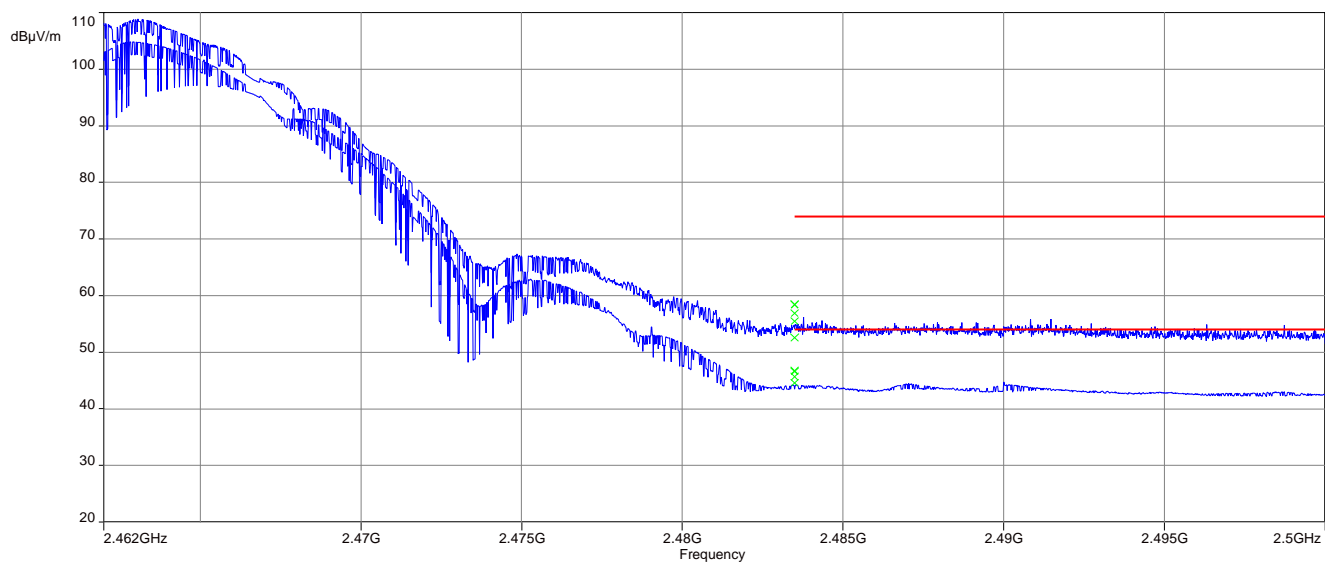



**Plots:** g-mode - peak / average

**Plot 1:** TX mode, lower band edge, vertical & horizontal polarization

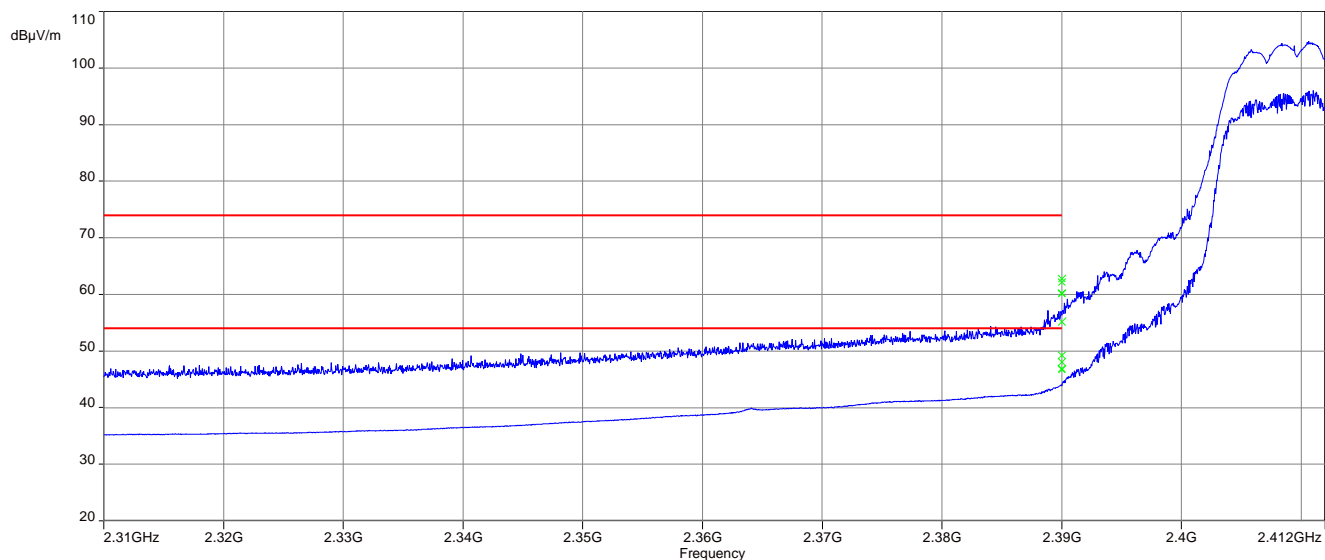

**Plot 2:** TX mode, upper band edge, vertical & horizontal polarization

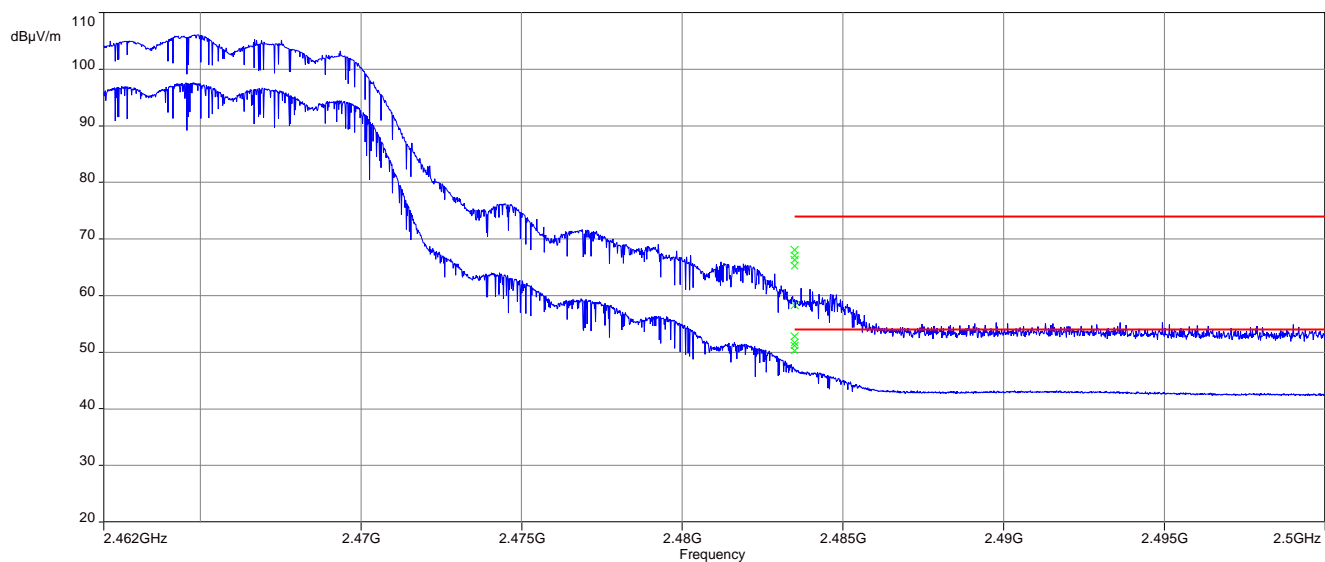

**Plots:** nHT20 - mode peak / average

**Plot 1:** TX mode, lower band edge, vertical & horizontal polarization

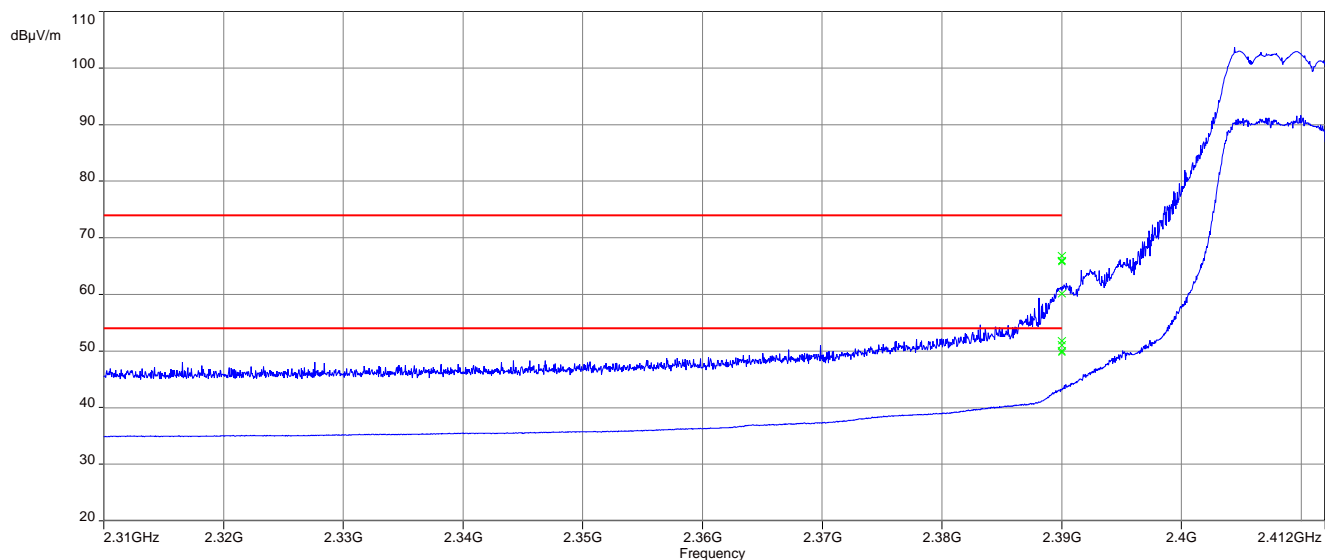

**Plot 2:** TX mode, upper band edge, vertical & horizontal polarization

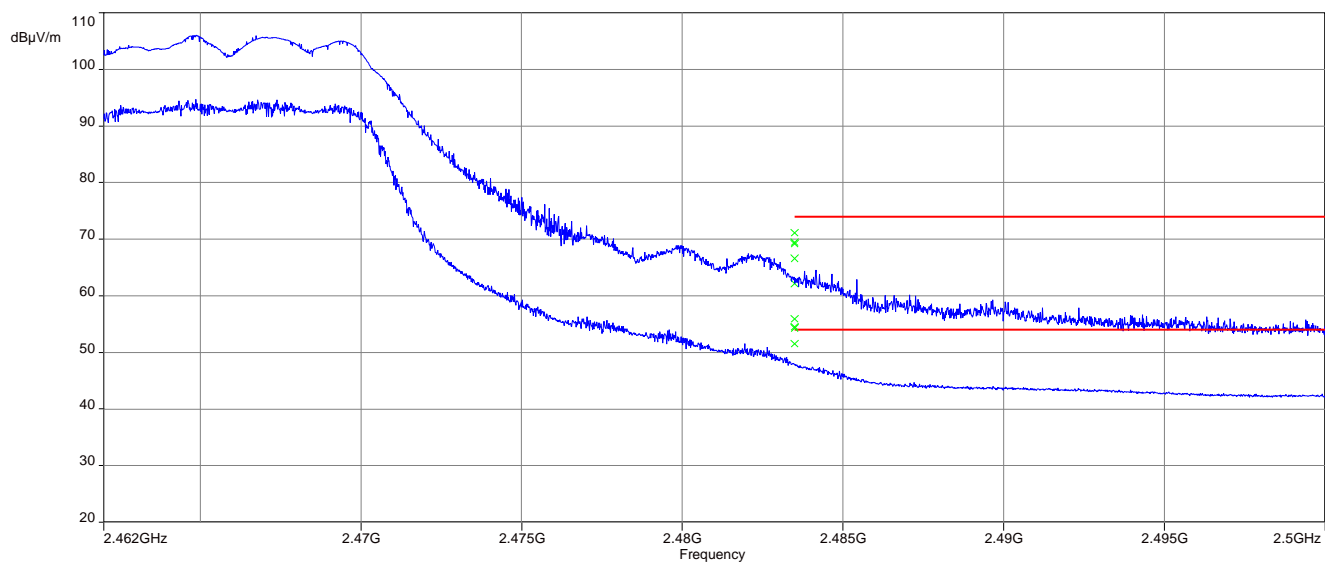

NOTE: The average values in the plot are an automated measurement and result in an overestimation of the average values. The value was re-measured manually and the exact value is stated in the result tables in this chapter.

## 13.10 Spurious emissions conducted

### Description:

Measurement of the conducted spurious emissions in transmit mode. The measurement is performed at the lowest; the middle and the highest channel.

### Measurement:

Measurement parameter	
Detector	Peak
Sweep time	Auto
Resolution bandwidth	100 kHz
Video bandwidth	500 kHz
Span	9 kHz to 25 GHz
Trace mode	Max Hold
External result file(s)	1-6579_23-01-15_TR1_A201.pdf
Test setup	See chapter 7.4 setup A
Measurement uncertainty	See chapter 9

### Limits:

FCC	ISED
In any 100 kHz bandwidth outside the frequency band in which the spread spectrum or digitally modulated intentional radiator is operating, the radio frequency power that is produced by the intentional radiator shall be at least 30 dB below that in the 100 kHz bandwidth within the band that contains the highest level of the desired power, based on either an RF conducted or a radiated measurement. Attenuation below the general limits specified in Section 15.209(a) is not required	

**Results:** Compliant (see log file)

### 13.11 Spurious emissions radiated below 30 MHz

**Description:**

Measurement of the radiated spurious emissions in transmit mode below 30 MHz. The limits are recalculated to a measurement distance of 3 m with 40 dB/decade according CFR Part 2.

**Measurement:**

Measurement parameter	
Detector	Peak / Quasi Peak
Sweep time	Auto
Resolution bandwidth	F < 150 kHz: 200 Hz F > 150 kHz: 9 kHz
Video bandwidth	F < 150 kHz: 1 kHz F > 150 kHz: 100 kHz
Span	9 kHz to 30 MHz
Trace mode	Max Hold
Measured modulation	<input checked="" type="checkbox"/> DSSS b – mode <input checked="" type="checkbox"/> OFDM g – mode <input type="checkbox"/> OFDM n HT20 – mode
Test setup	See chapter 7.2 setup C
Measurement uncertainty	See chapter 9

**Limits:**

FCC		ISED	
Frequency / MHz	Field Strength / (dBµV / m)	Measurement distance / m	
0.009 – 0.490	2400/F(kHz)	300	
0.490 – 1.705	24000/F(kHz)	30	
1.705 – 30.0	30	30	

**Results:**

TX spurious emissions radiated < 30 MHz / (dBµV / m) @ 3 m		
Frequency / MHz	Detector	Level / (dBµV / m)
All detected peaks are more than 20 dB below the limit.		

**Plots:** DSSS

**Plot 1:** 9 kHz to 30 MHz, lowest channel

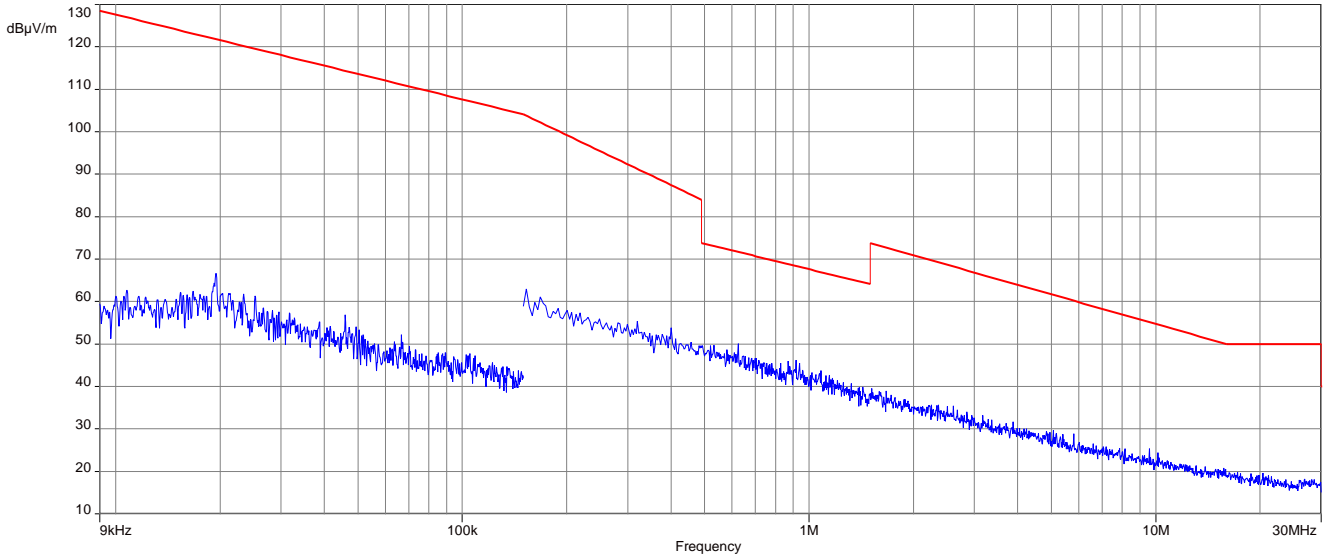

**Plot 2:** 9 kHz to 30 MHz, middle channel

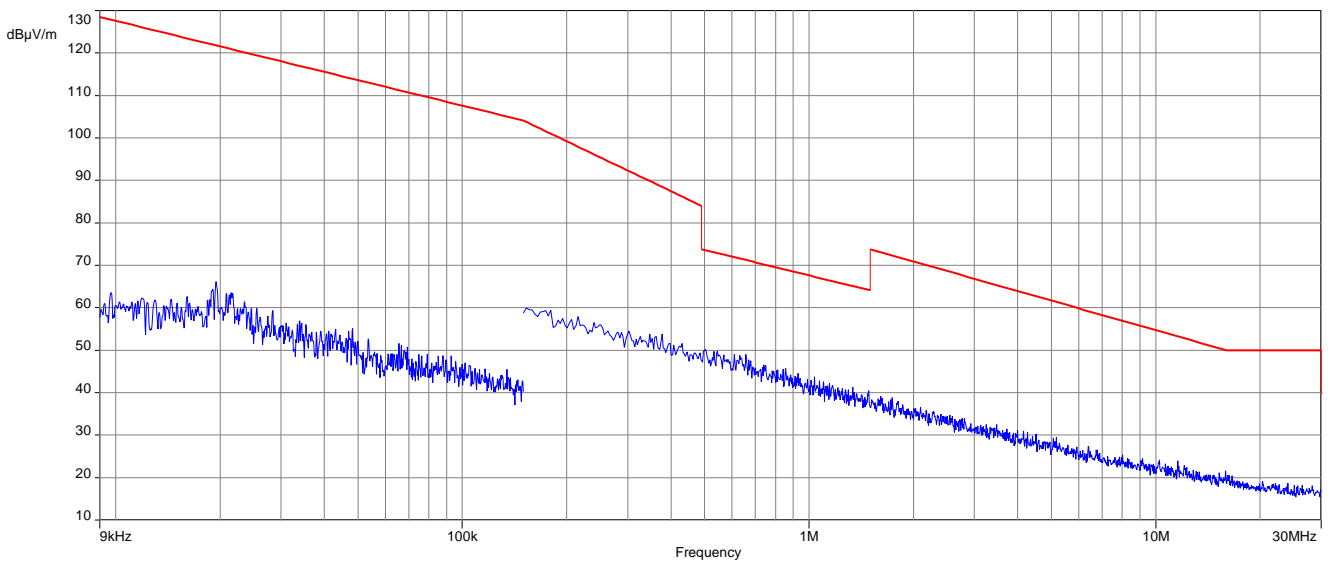

**Plot 3: 9 kHz to 30 MHz, highest channel**

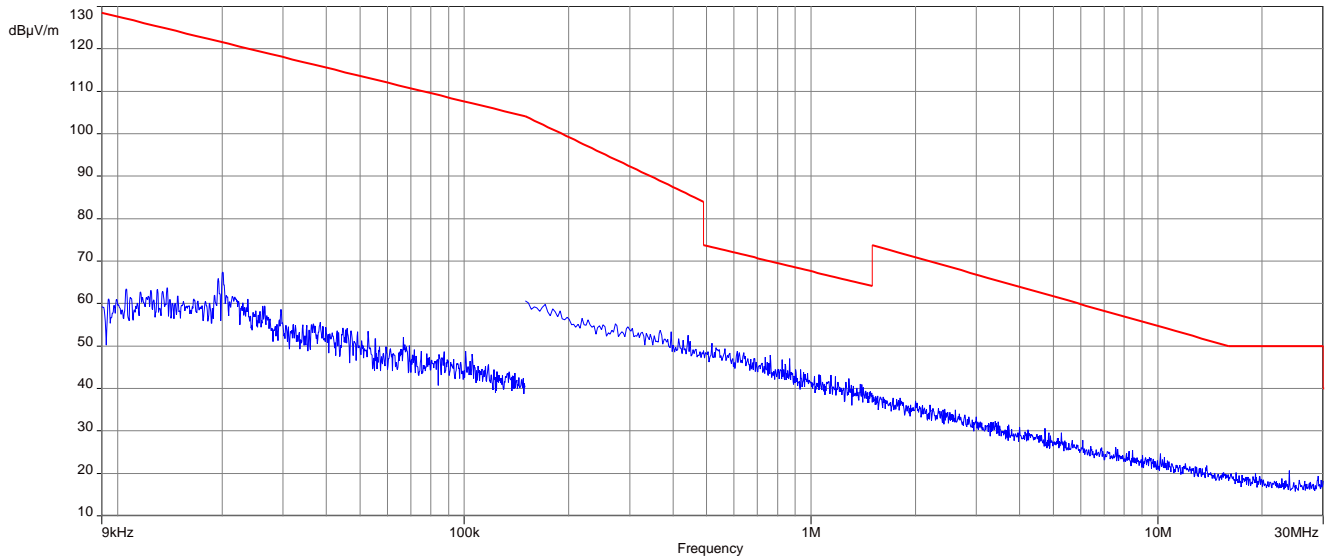

**Plots:** OFDM (20 MHz nominal channel bandwidth)

**Plot 1:** 9 kHz to 30 MHz, lowest channel

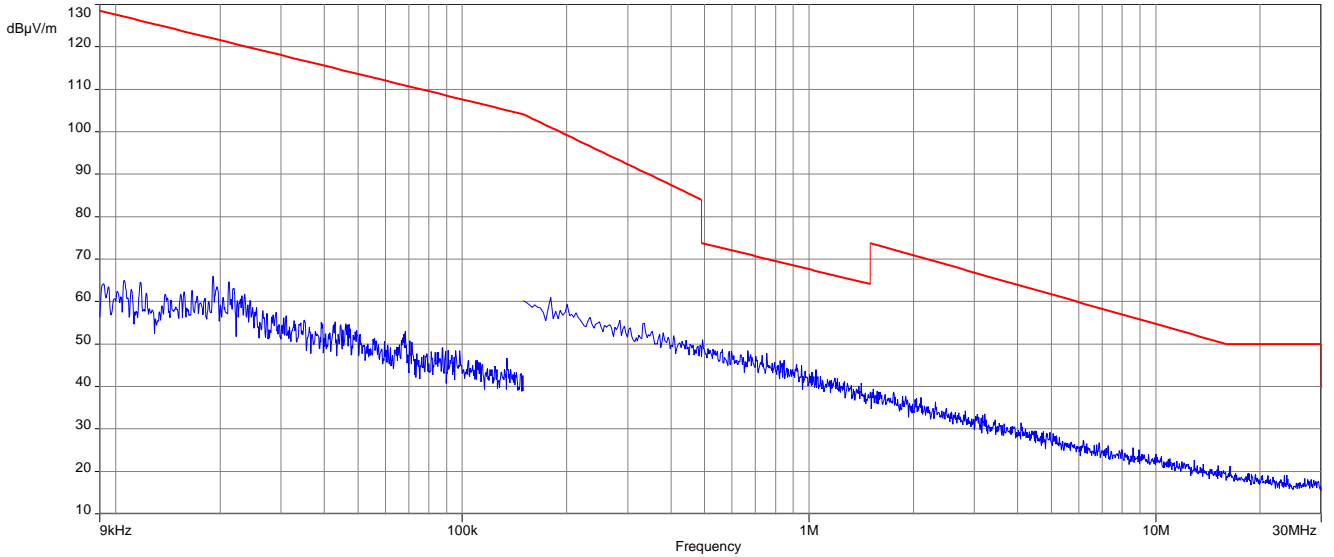

**Plot 2:** 9 kHz to 30 MHz, middle channel

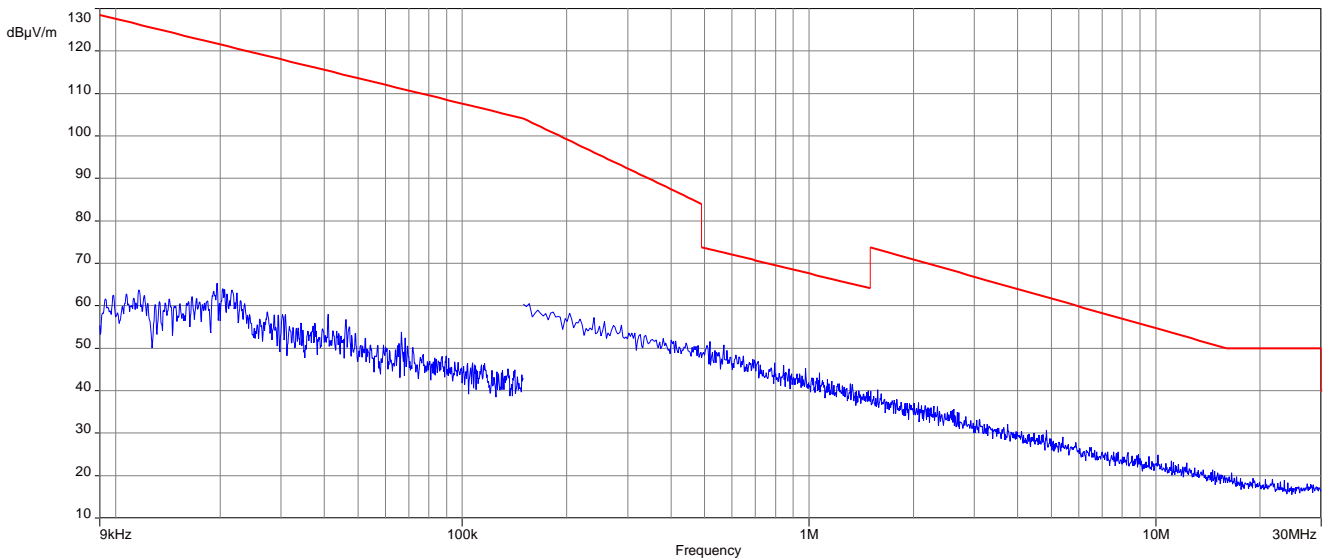

**Plot 3:** 9 kHz to 30 MHz, highest channel

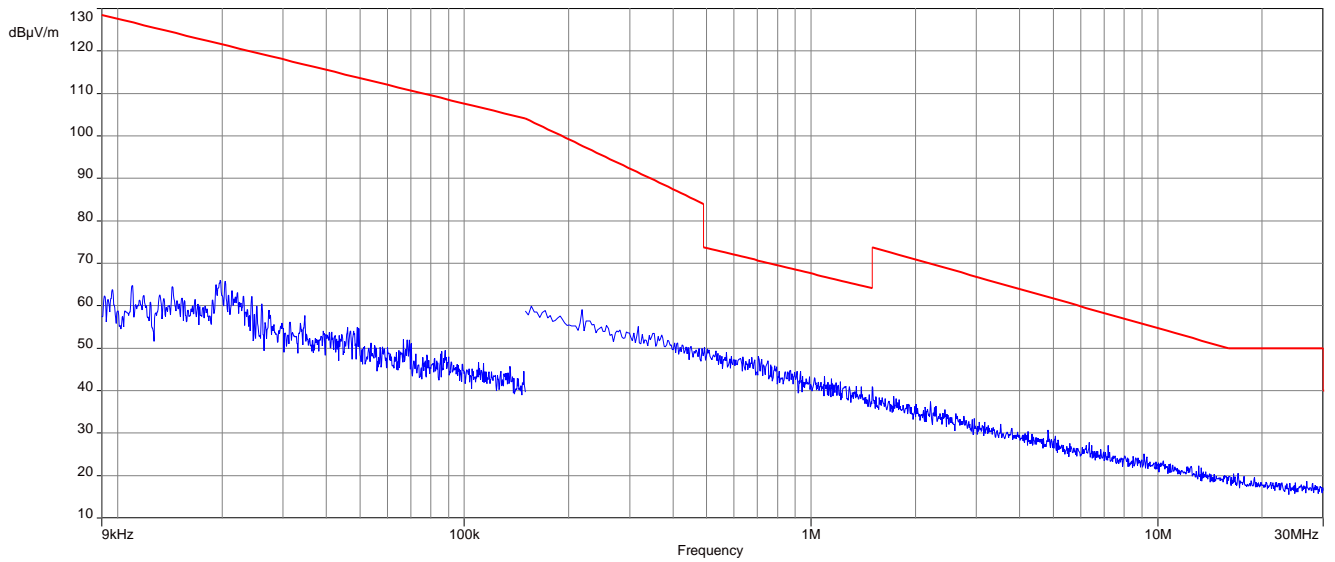



### 13.12 Spurious emissions radiated 30 MHz to 1 GHz

**Description:**

Measurement of the radiated spurious emissions and cabinet radiations below 1 GHz.

**Measurement:**

Measurement parameter	
Detector	Peak / Quasi Peak
Sweep time	Auto
Resolution bandwidth	120 kHz
Video bandwidth	3 x RBW
Span	30 MHz to 1 GHz
Trace mode	Max Hold
Measured modulation	<input checked="" type="checkbox"/> DSSS b – mode <input type="checkbox"/> OFDM g – mode <input checked="" type="checkbox"/> OFDM n HT20 – mode <input type="checkbox"/> OFDM n HT40 – mode
Test setup	See chapter 7.1 setup A
Measurement uncertainty	See chapter 9

**Limits:**

FCC	ISED	
In any 100 kHz bandwidth outside the frequency band in which the spread spectrum or digitally modulated intentional radiator is operating, the radio frequency power that is produced by the intentional radiator shall be at least 20 dB below that in the 100 kHz bandwidth within the band that contains the highest level of the desired power, based on either an RF conducted or a radiated measurement. Attenuation below the general limits specified in Section 15.209(a) is not required. In addition, radiated emissions which fall in the restricted bands, as defined in §15.205(a), must also comply with the radiated emission limits specified in §15.209(a) (see §15.205(c)).		
Frequency / MHz	Field Strength / (dBµV / m)	Measurement distance / m
30 – 88	30.0	10
88 – 216	33.5	10
216 – 960	36.0	10

**Plot:** DSSS

**Plot 1:** 30 MHz to 1 GHz, vertical & horizontal polarization, valid for all channels

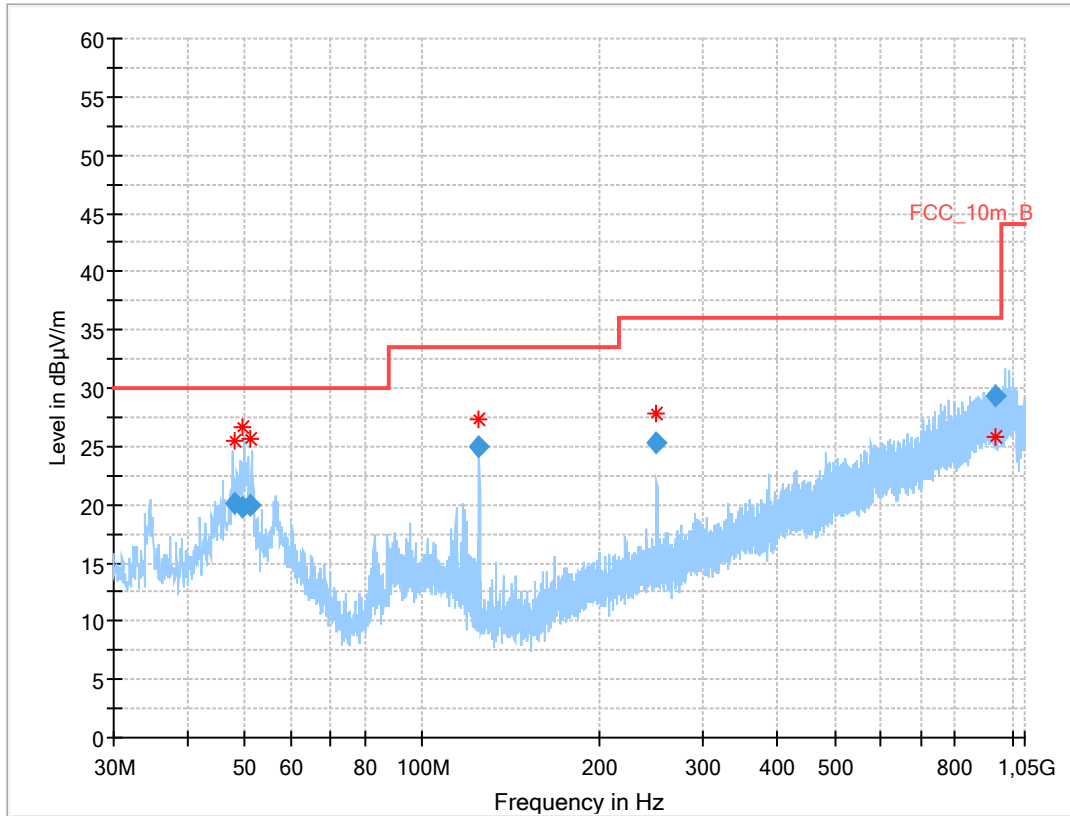

**Final results:**

Frequency (MHz)	QuasiPeak (dBµV/m)	Limit (dBµV/m)	Margin (dB)	Meas. Time (ms)	Bandwidth (kHz)	Height (cm)	Pol	Azimuth (deg)	Corr. (dB)
48.224	20.03	30.0	10.0	1000	120.0	195.0	V	197	15
49.548	19.74	30.0	10.3	1000	120.0	195.0	V	37	15
51.297	19.90	30.0	10.1	1000	120.0	157.0	V	52	15
124.998	24.97	33.5	8.5	1000	120.0	195.0	V	37	10
249.986	25.23	36.0	10.8	1000	120.0	104.0	V	4	14
939.892	29.38	36.0	6.6	1000	120.0	195.0	V	232	25

**Plot:** OFDM (20 MHz nominal channel bandwidth)

**Plot 1:** 30 MHz to 1 GHz, vertical & horizontal polarization, valid for all channels

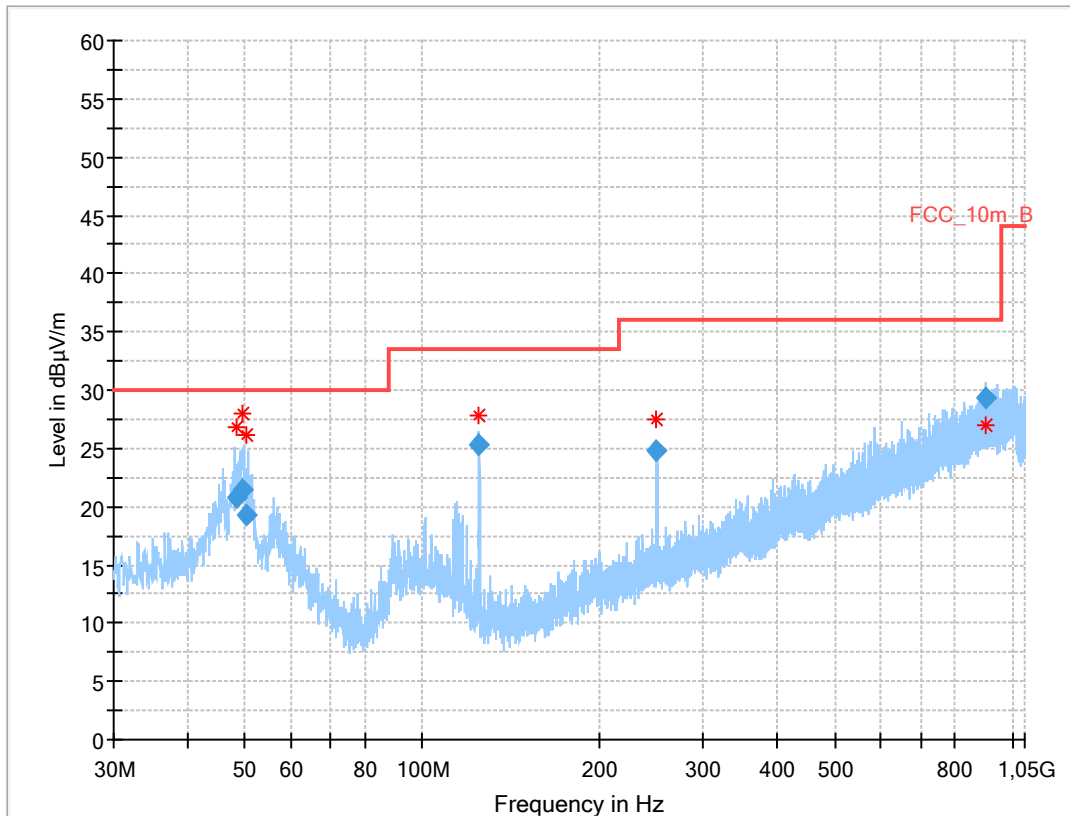

**Final results:**

Frequency (MHz)	QuasiPeak (dBµV/m)	Limit (dBµV/m)	Margin (dB)	Meas. Time (ms)	Bandwidth (kHz)	Height (cm)	Pol	Azimuth (deg)	Corr. (dB)
48.308	20.81	30.0	9.2	1000	120.0	195.0	V	-23	15
49.574	21.50	30.0	8.5	1000	120.0	177.0	V	-32	15
50.481	19.21	30.0	10.8	1000	120.0	195.0	V	-32	15
124.992	25.23	33.5	8.3	1000	120.0	152.0	V	79	10
250.000	24.74	36.0	11.3	1000	120.0	106.0	V	6	14
904.796	29.31	36.0	6.7	1000	120.0	195.0	H	142	25

### 13.13 Spurious emissions radiated above 1 GHz

**Description:**

Measurement of the radiated spurious emissions above 1 GHz in transmit mode and receiver / idle mode.

**Measurement:**

Measurement parameter	
Detector	Peak / RMS
Sweep time	Auto
Resolution bandwidth	1 MHz
Video bandwidth	3 x RBW
Span	1 GHz to 26 GHz
Trace mode	Max Hold
Measured modulation	<input checked="" type="checkbox"/> DSSS b – mode <input checked="" type="checkbox"/> OFDM g – mode <input type="checkbox"/> OFDM n HT20 – mode
Test setup	See chapter 7.2 setup B & 7.3 setup A
Measurement uncertainty	See chapter 9

**Limits:**

FCC	ISED	
In any 100 kHz bandwidth outside the frequency band in which the spread spectrum or digitally modulated intentional radiator is operating, the radio frequency power that is produced by the intentional radiator shall be at least 30 dB below that in the 100 kHz bandwidth within the band that contains the highest level of the desired power, based on either an RF conducted or a radiated measurement. Attenuation below the general limits specified in Section 15.209(a) is not required. In addition, radiated emissions which fall in the restricted bands, as defined in §15.205(a), must also comply with the radiated emission limits specified in §15.209(a) (see §15.205(c)).		
Frequency / MHz	Field Strength / (dBµV / m)	Measurement distance / m
Above 960	54.0 (AVG)	3
	74.0 (peak)	

**Results:** DSSS

TX spurious emissions radiated / dBµV/m @ 3 m								
lowest channel			middle channel			highest channel		
f / MHz	Detector	Level / dBµV/m	f / MHz	Detector	Level / dBµV/m	f / MHz	Detector	Level / dBµV/m
-/-	Peak	-/-	4874	Peak	48.6	4924	Peak	51.1
	AVG	-/-		AVG	42.3		AVG	46.5
-/-	Peak	-/-	-/-	Peak	-/-	-/-	Peak	-/-
	AVG	-/-		AVG	-/-		AVG	-/-

**Results:** OFDM (20 MHz nominal channel bandwidth)

TX spurious emissions radiated / dBµV/m @ 3 m								
lowest channel			middle channel			highest channel		
f / MHz	Detector	Level / dBµV/m	f / MHz	Detector	Level / dBµV/m	f / MHz	Detector	Level / dBµV/m
All detected emissions are more than 20 dB below the limit.			All detected emissions are more than 20 dB below the limit.			All detected emissions are more than 20 dB below the limit.		
-/-	Peak	-/-	-/-	Peak	-/-	-/-	Peak	-/-
	AVG	-/-		AVG	-/-		AVG	-/-
-/-	Peak	-/-	-/-	Peak	-/-	-/-	Peak	-/-
	AVG	-/-		AVG	-/-		AVG	-/-

**Plots:** DSSS

**Plot 1:** Lowest channel, 1 GHz to 18 GHz, vertical & horizontal polarization

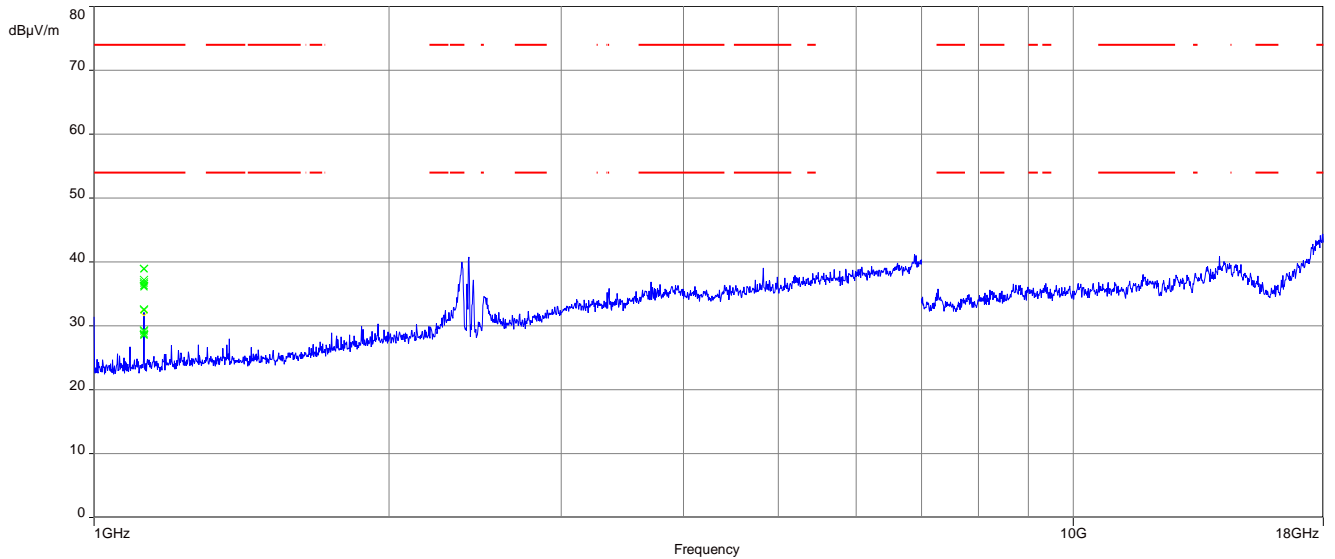

The carrier signal is notched with a 2.4 GHz band rejection filter.

**Plot 2:** Middle channel, 1 GHz to 18 GHz, vertical & horizontal polarization

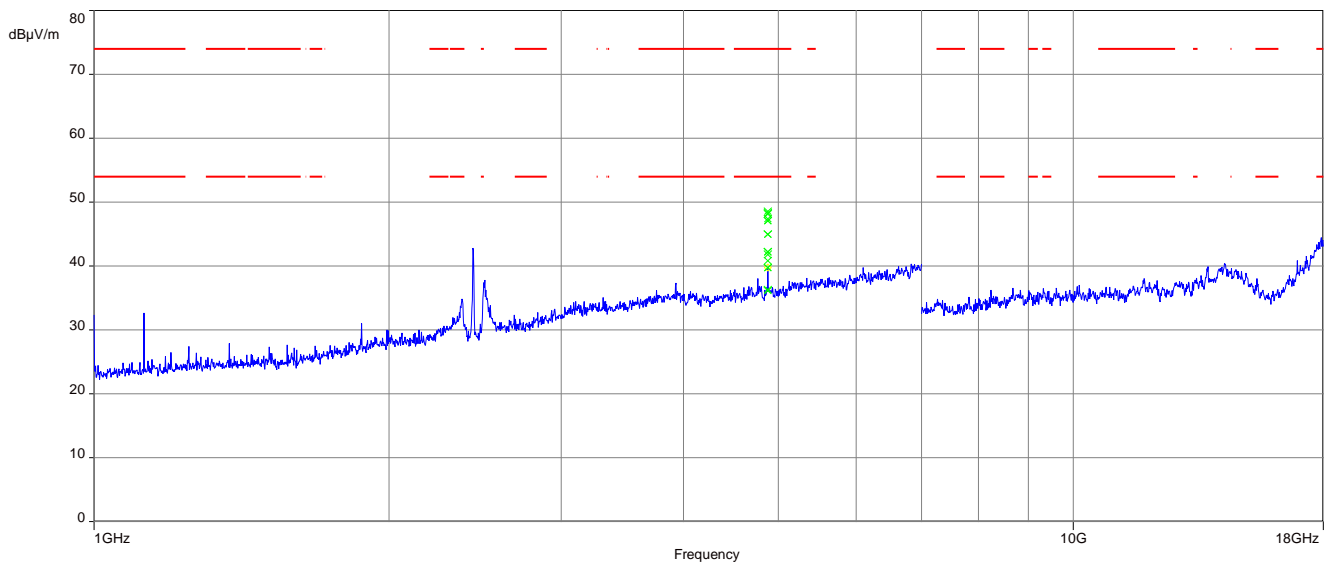

The carrier signal is notched with a 2.4 GHz band rejection filter.

**Plot 3:** Highest channel, 1 GHz to 18 GHz, vertical & horizontal polarization

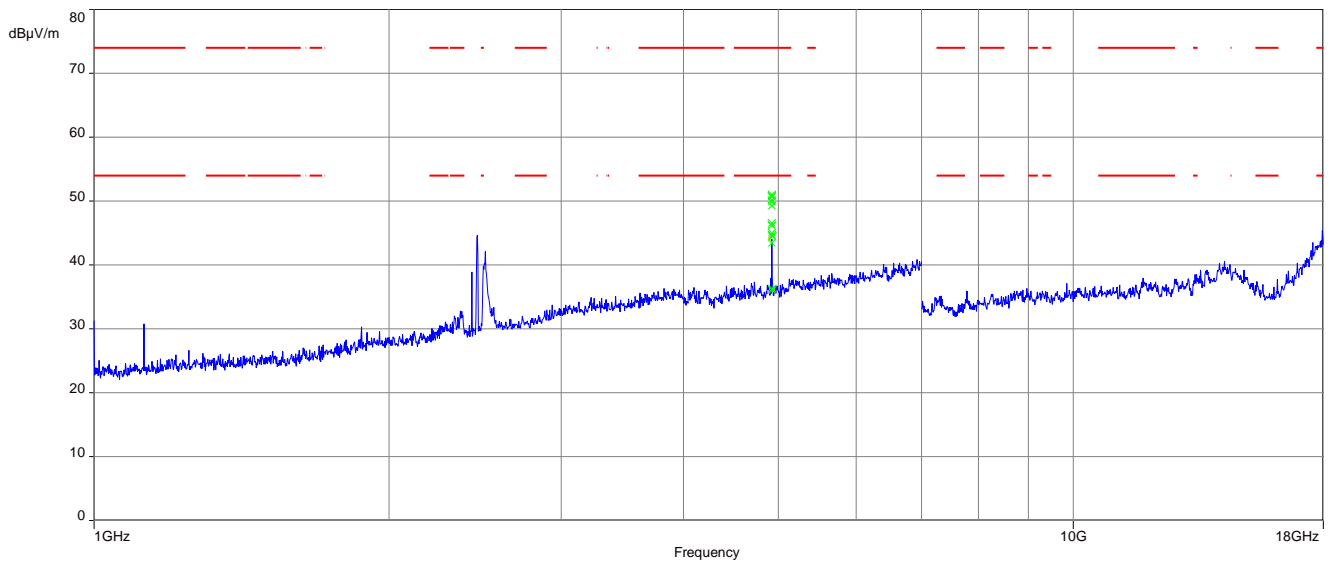

The carrier signal is notched with a 2.4 GHz band rejection filter.

**Plots:** OFDM (20 MHz bandwidth)

**Plot 1:** Lowest channel, 1 GHz to 18 GHz, vertical & horizontal polarization

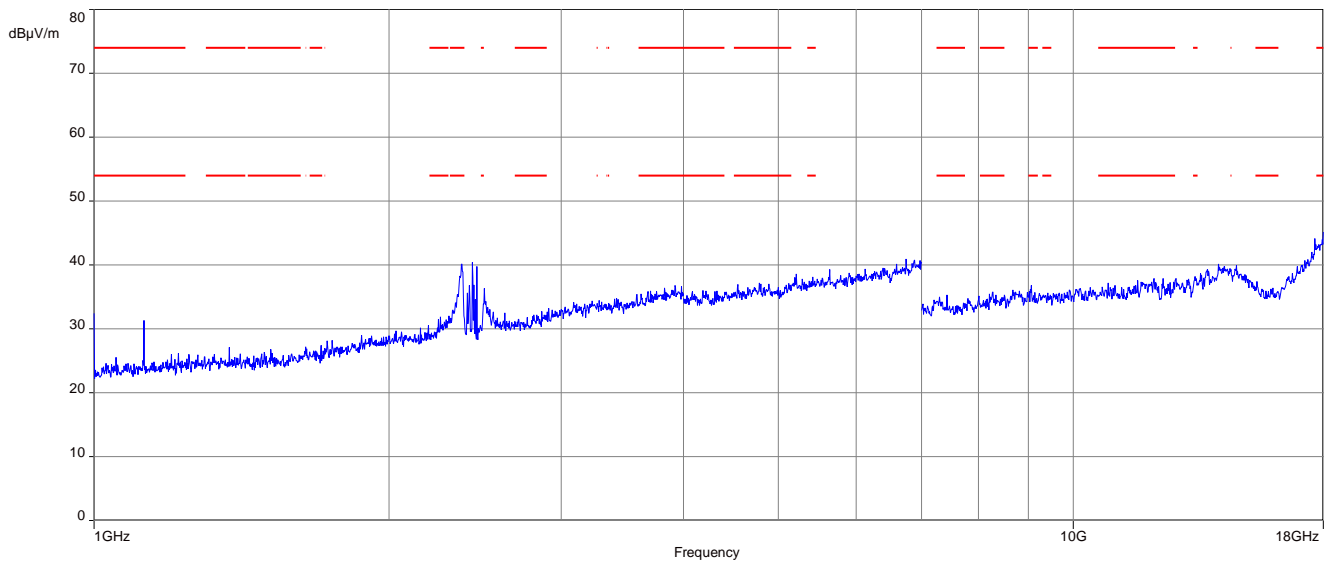

The carrier signal is notched with a 2.4 GHz band rejection filter.

**Plot 2:** Middle channel, 1 GHz to 18 GHz, vertical & horizontal polarization

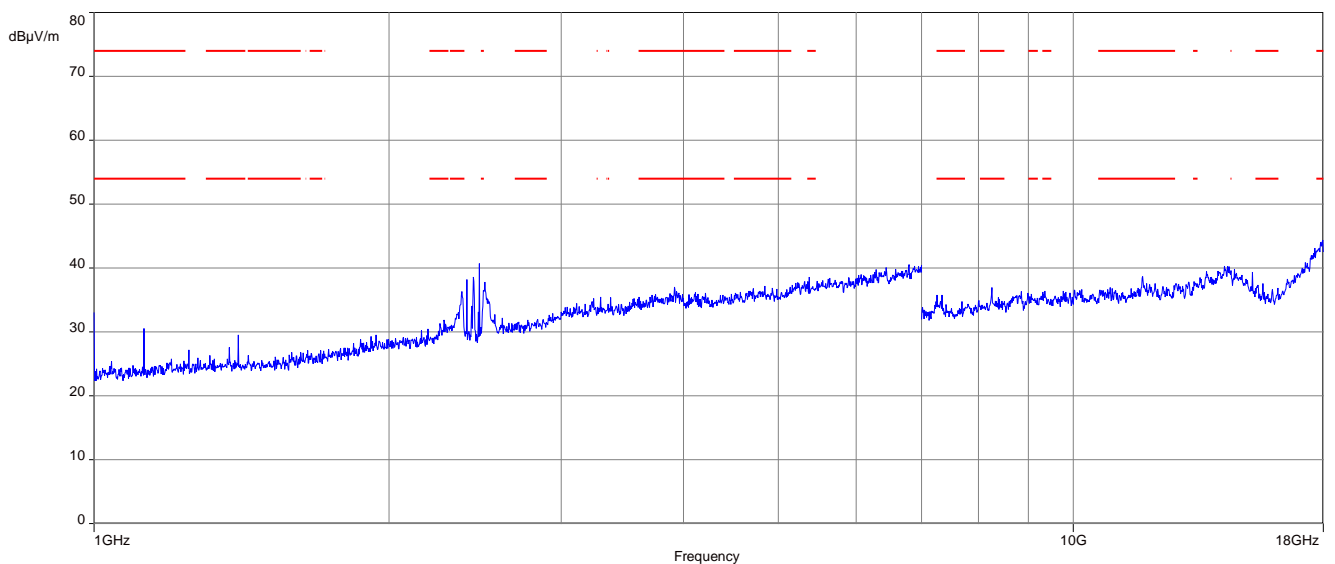

The carrier signal is notched with a 2.4 GHz band rejection filter.



**Plot 3:** Highest channel, 1 GHz to 18 GHz, vertical & horizontal polarization

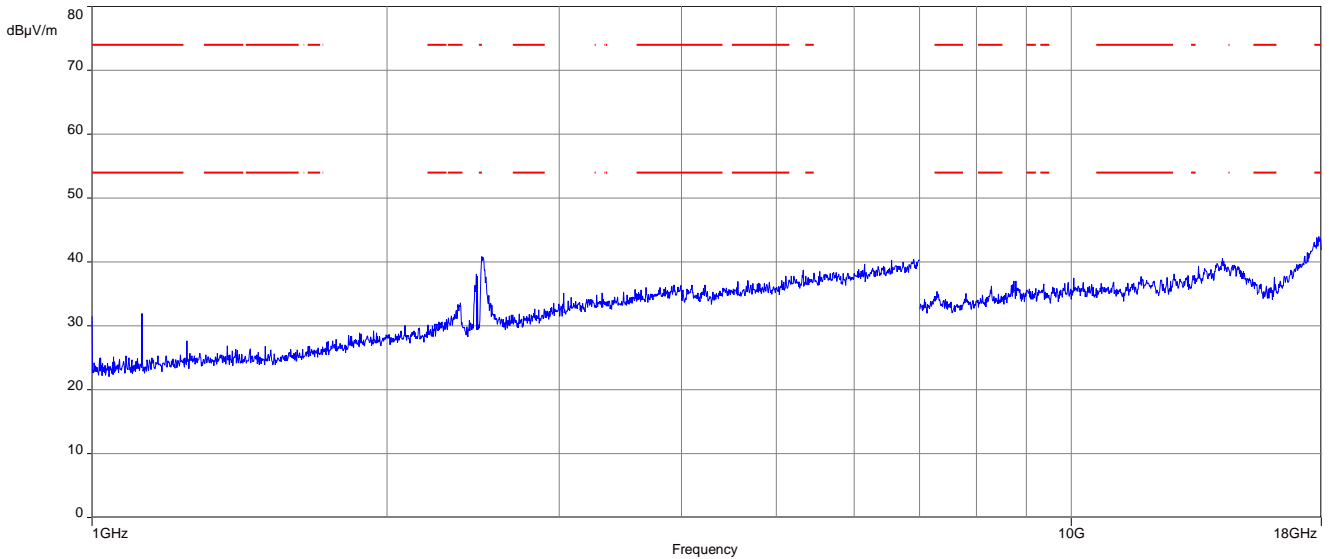

The carrier signal is notched with a 2.4 GHz band rejection filter.

**Plot 4:** 18 GHz to 26 GHz, vertical & horizontal polarization, valid for all channels and modes

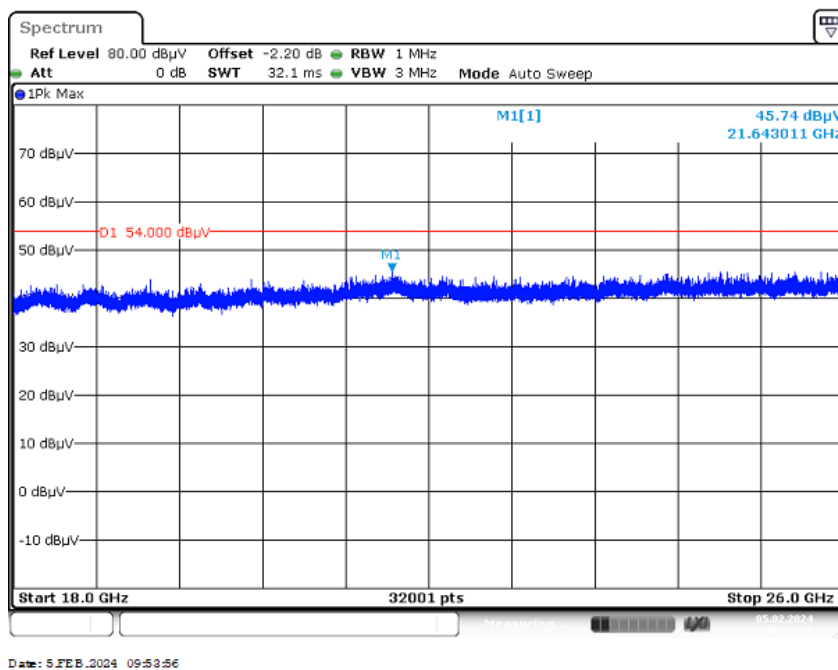

## 14 Glossary

<b>AVG</b>	Average
<b>C</b>	Compliant
<b>C/N<sub>0</sub></b>	Carrier to noise-density ratio, expressed in dB-Hz
<b>CAC</b>	Channel availability check
<b>CW</b>	Clean wave
<b>DC</b>	Duty cycle
<b>DFS</b>	Dynamic frequency selection
<b>DSSS</b>	Dynamic sequence spread spectrum
<b>DUT</b>	Device under test
<b>EN</b>	European Standard
<b>ETSI</b>	European Telecommunications Standards Institute
<b>EMC</b>	Electromagnetic Compatibility
<b>EUT</b>	Equipment under test
<b>FCC</b>	Federal Communications Commission
<b>FCC ID</b>	Company Identifier at FCC
<b>FHSS</b>	Frequency hopping spread spectrum
<b>FVIN</b>	Firmware version identification number
<b>GNSS</b>	Global Navigation Satellite System
<b>GUE</b>	GNSS User Equipment
<b>HMN</b>	Host marketing name
<b>HVIN</b>	Hardware version identification number
<b>HW</b>	Hardware
<b>IC</b>	Industry Canada
<b>Inv. No.</b>	Inventory number
<b>MC</b>	Modulated carrier
<b>NA</b>	Not applicable
<b>NC</b>	Not compliant
<b>NOP</b>	Non occupancy period
<b>NP</b>	Not performed
<b>OBW</b>	Occupied bandwidth
<b>OC</b>	Operating channel
<b>OCW</b>	Operating channel bandwidth
<b>OFDM</b>	Orthogonal frequency division multiplexing
<b>OOB</b>	Out of band
<b>OP</b>	Occupancy period
<b>PER</b>	Packet error rate
<b>PMN</b>	Product marketing name
<b>PP</b>	Positive peak
<b>QP</b>	Quasi peak
<b>RLAN</b>	Radio local area network
<b>S/N or SN</b>	Serial number
<b>SW</b>	Software
<b>UUT</b>	Unit under test
<b>WLAN</b>	Wireless local area network

## 15 Document history

Version	Applied changes	Date of release
-/-	Initial release	2024-03-01

##### END OF TEST REPORT #####