



TEST REPORT

BNetzA-CAB-02/21-102

Test report no.: 1-6579-23-01-45_TR1-R01

Testing laboratory

cetecom advanced GmbH
Untertuerkheimer Strasse 6 – 10
66117 Saarbruecken / Germany
Phone: + 49 681 5 98 - 0
Fax: + 49 681 5 98 - 9075
Internet: <https://cetecomadvanced.com>
e-mail: mail@cetecomadvanced.com

Accredited Testing Laboratory:

The testing laboratory (area of testing) is accredited according to DIN EN ISO/IEC 17025 (2018-03) by the Deutsche Akkreditierungsstelle GmbH (DAkkS).

The accreditation is valid for the scope of testing procedures as stated in the accreditation certificate with the registration number: D-PL-12047-01-00.

ISED Testing Laboratory Recognized Listing Number: DE0001
FCC designation number: DE0002

Applicant

Robert Bosch GmbH
Robert-Bosch-Straße 200
31139 Hildesheim / GERMANY
Phone: -/-
Contact: Thomas Dargel
e-mail: Thomas.Dargel@de.bosch.com

Manufacturer

Robert Bosch GmbH
Robert-Bosch-Straße 200
31139 Hildesheim / GERMANY

Test standard/s

FCC - Title 47 CFR Part 15 FCC - Title 47 of the Code of Federal Regulations; Chapter I; Part 15 - Radio frequency devices
Digital Transmission Systems (DTSS), Frequency Hopping Systems (FHSs) and
Licence - Exempt Local Area Network (LE-LAN) Devices
RSS - 247 Issue 3
For further applied test standards please refer to section 3 of this test report.

Test Item

Kind of test item: **Telematics Control Unit Generation 2**
Model name: **TCU2 NA IP30**
FCC ID: **2AUXS-TCU2NAIP30A**
Frequency: 2400 MHz to 2483.5 MHz
Technology tested: WLAN
Antenna: Two Integrated antennas with MIMO capability
Power supply: 12.0 V DC by vehicle battery
Temperature range: -40°C to +65°C

This test report is electronically signed and valid without handwritten signature. For verification of the electronic signatures, the public keys can be requested at the testing laboratory.

Test report authorized:

Marco Bertolino
Supervisor Radio Services
Radio Labs

Test performed:

p.o.
Michael Dorongovski
Lab Manager
Radio Labs

1 Table of contents

1	Table of contents.....	2
2	General information.....	3
2.1	Notes and disclaimer	3
2.2	Application details	3
2.3	Test laboratories sub-contracted	3
3	Test standard/s, references and accreditations	4
4	Reporting statements of conformity – decision rule	5
5	Test environment.....	6
6	Test item	6
6.1	General description	6
6.2	Additional information	6
7	Description of the test setup.....	7
7.1	Shielded semi anechoic chamber	8
7.2	Shielded fully anechoic chamber.....	9
7.3	Radiated measurements > 18 GHz	10
7.4	Conducted measurements system	11
8	Sequence of testing.....	12
8.1	Sequence of testing radiated spurious 9 kHz to 30 MHz	12
8.2	Sequence of testing radiated spurious 30 MHz to 1 GHz.....	13
8.3	Sequence of testing radiated spurious 1 GHz to 18 GHz.....	14
8.4	Sequence of testing radiated spurious above 18 GHz.....	15
9	Measurement uncertainty.....	16
10	Summary of measurement results	17
11	Additional information and comments	18
12	Additional EUT parameter	19
13	Measurement results	20
13.1	Antenna gain	20
13.2	Identify worst case data rate.....	21
13.3	Maximum output power.....	22
13.4	Duty cycle.....	24
13.5	Average power spectral density	25
13.6	6 dB DTS bandwidth	27
13.7	Occupied bandwidth – 99% emission bandwidth	28
13.8	Occupied bandwidth – 20 dB bandwidth.....	29
13.9	Band edge compliance radiated	30
13.10	Spurious emissions conducted	34
13.11	Spurious emissions radiated below 30 MHz	35
13.12	Spurious emissions radiated 30 MHz to 1 GHz	40
13.13	Spurious emissions radiated above 1 GHz.....	43
14	Glossary	49

15	Document history	50
----	------------------------	----

2 General information

2.1 Notes and disclaimer

The test results of this test report relate exclusively to the test item specified in this test report. cetecom advanced GmbH does not assume responsibility for any conclusions and generalizations drawn from the test results with regard to other specimens or samples of the type of the equipment represented by the test item.

The test report may only be reproduced or published in full. Reproduction or publication of extracts from the report requires the prior written approval of cetecom advanced GmbH.

The testing service provided by cetecom advanced GmbH has been rendered under the current "General Terms and Conditions for cetecom advanced GmbH".

cetecom advanced GmbH will not be liable for any loss or damage resulting from false, inaccurate, inappropriate or incomplete product information provided by the customer.

Under no circumstances does the cetecom advanced GmbH test report include any endorsement or warranty regarding the functionality, quality or performance of any other product or service provided.

Under no circumstances does the cetecom advanced GmbH test report include or imply any product or service warranties from cetecom advanced GmbH, including, without limitation, any implied warranties of merchantability, fitness for purpose, or non-infringement, all of which are expressly disclaimed by cetecom advanced GmbH.

All rights and remedies regarding vendor's products and services for which cetecom advanced GmbH has prepared this test report shall be provided by the party offering such products or services and not by cetecom advanced GmbH.

In no case this test report can be considered as a Letter of Approval.

This test report is electronically signed and valid without handwritten signature. For verification of the electronic signatures, the public keys can be requested at the testing laboratory.

2.2 Application details

Date of receipt of order:	2023-07-30
Date of receipt of test item:	2023-08-07
Start of test:*	2023-08-07
End of test:*	2023-10-25
Person(s) present during the test:	-/-

*Date of each measurement, if not shown in the plot, can be requested. Dates are stored in the measurement software.

2.3 Test laboratories sub-contracted

None

3 Test standard/s, references and accreditations

Test standard	Date	Description
FCC - Title 47 CFR Part 15		FCC - Title 47 of the Code of Federal Regulations; Chapter I; Part 15 - Radio frequency devices
RSS - 247 Issue 3	August 2023	Digital Transmission Systems (DTSS), Frequency Hopping Systems (FHSs) and Licence - Exempt Local Area Network (LE-LAN) Devices
RSS - Gen Issue 5 incl. Amendment 1 & 2	February 2021	Spectrum Management and Telecommunications Radio Standards Specification - General Requirements for Compliance of Radio Apparatus

Guidance	Version	Description
KDB 558074 D01	v05r02	GUIDANCE FOR COMPLIANCE MEASUREMENTS ON DIGITAL TRANSMISSION SYSTEM, FREQUENCY HOPPING SPREAD SPECTRUM SYSTEM, AND HYBRID SYSTEM DEVICES OPERATING UNDER SECTION 15.247 OF THE FCC RULES
ANSI C63.4-2014	-/-	American National Standard for Methods of Measurement of Radio-Noise Emissions from Low-Voltage Electrical and Electronic Equipment in the Range of 9 kHz to 40 GHz
ANSI C63.10-2013	-/-	American National Standard of Procedures for Compliance Testing of Unlicensed Wireless Devices

4 Reporting statements of conformity – decision rule

Only the measured values related to their corresponding limits will be used to decide whether the equipment under test meets the requirements of the test standards listed in chapter 3. The measurement uncertainty is mentioned in this test report, see chapter 9, but is not taken into account - neither to the limits nor to the measurement results. Measurement results with a smaller margin to the corresponding limits than the measurement uncertainty have a potential risk of more than 5% that the decision might be wrong."

measured value, measurement uncertainty, verdict



5 Test environment

Temperature	: T _{nom} T _{max} T _{min}	+22 °C during room temperature tests No tests under extreme environmental conditions required. No tests under extreme environmental conditions required.
Relative humidity content	:	55 %
Barometric pressure	:	1021 hpa
Power supply	: V _{nom} V _{max} V _{min}	12.0 V DC by external power supply No tests under extreme environmental conditions required. No tests under extreme environmental conditions required.

6 Test item

6.1 General description

Kind of test item	:	Telematics Control Unit Generation 2
Model name	:	TCU2 NA IP30
S/N serial number	:	Rad. 2750003443 Cond. 2750003443
Hardware status	:	4186H06
Software status	:	23.04.S.010.4
Firmware status	:	N/A
Frequency band	:	2400 MHz to 2483.5 MHz
Type of radio transmission	:	DSSS, OFDM
Use of frequency spectrum	:	
Type of modulation	:	(D)BPSK, (D)QPSK, 16 – QAM, 64 – QAM
Number of channels	:	11
Antenna	:	Two Integrated antennas with MIMO capability
Power supply	:	12.0 V DC by vehicle battery
Temperature range	:	-40°C to +65°C

6.2 Additional information

The content of the following annexes is defined in the QA. It may be that not all of the listed annexes are necessary for this report, thus some values in between may be missing.

Test setup and EUT photos are included in test report: 1-6579_23-01-08_AnnexA
1-6579_23-01-08_AnnexD

7 Description of the test setup

Typically, the calibrations of the test apparatus are commissioned to and performed by an accredited calibration laboratory. The calibration intervals are determined in accordance with the DIN EN ISO/IEC 17025. In addition to the external calibrations, the laboratory executes comparison measurements with other calibrated test systems or effective verifications. Weekly chamber inspections and range calibrations are performed. Where possible, RF generating and signaling equipment as well as measuring receivers and analyzers are connected to an external high-precision 10 MHz reference (GPS-based or rubidium frequency standard).

In order to simplify the identification of the equipment used at some special tests, some items of test equipment and ancillaries can be provided with an identifier or number in the equipment list below (Lab/Item).

Each block diagram listed can contain several test setup configurations. All devices belonging to a test setup are identified with the same letter syntax. For example: Column Setup and all devices with an A.

Agenda: Kind of Calibration

k	calibration / calibrated	EK	limited calibration
ne	not required (k, ev, izw, zw not required)	zw	cyclical maintenance (external cyclical maintenance)
ev	periodic self verification	izw	internal cyclical maintenance
Ve	long-term stability recognized	g	blocked for accredited testing
vlk!	Attention: extended calibration interval		
NK!	Attention: not calibrated	*)	next calibration ordered / currently in progress

7.1 Shielded semi anechoic chamber

The radiated measurements are performed in vertical and horizontal plane in the frequency range from 30 MHz to 1 GHz in semi-anechoic chambers. The EUT is positioned on a non-conductive support with a height of 0.80 m above a conductive ground plane that covers the whole chamber. The receiving antennas are conform to specifications ANSI C63. These antennas can be moved over the height range between 1.0 m and 4.0 m in order to search for maximum field strength emitted from EUT. The measurement distances between EUT and receiving antennas are indicated in the test setups for the various frequency ranges. For each measurement, the EUT is rotated in all three axes until the maximum field strength is received. The wanted and unwanted emissions are received by spectrum analyzers where the detector modes and resolution bandwidths over various frequency ranges are set according to requirement ANSI C63.

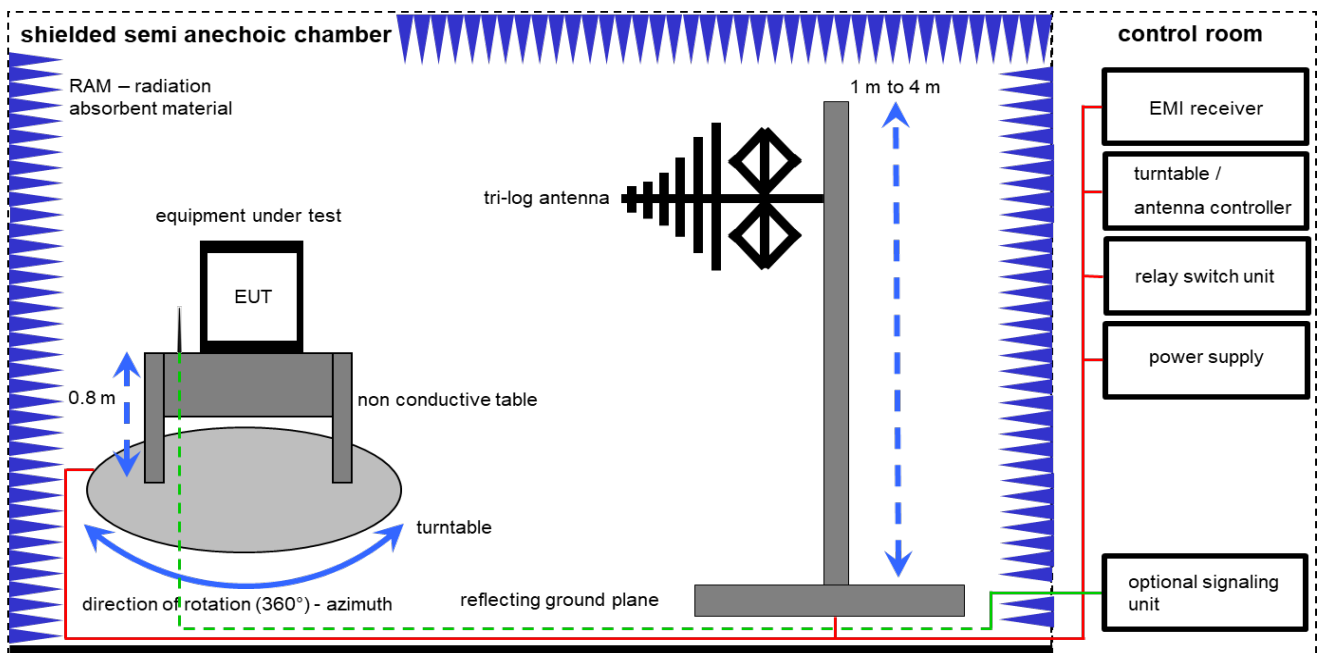

Measurement distance: tri-log antenna 10 meter; EMC32 software version: 10.59.00

$$FS = UR + CL + AF$$

(FS-field strength; UR-voltage at the receiver; CL-loss of the cable; AF-antenna factor)

Example calculation:

$$FS [dB\mu V/m] = 12.35 [dB\mu V/m] + 1.90 [dB] + 16.80 [dB/m] = 31.05 [dB\mu V/m] (35.69 \mu V/m)$$

Equipment table:

No.	Setup	Equipment	Type	Manufacturer	Serial No.	INV. No.	Kind of Calibration	Last Calibration	Next Calibration
1	A	Switch-Unit	3488A	HP	2719A14505	300000368	ev	-/-	-/-
2	A	Semi anechoic chamber	3000023	MWB AG	-/-	300000551	ne	-/-	-/-
3	A	Antenna Tower	Model 2175	ETS-Lindgren	64762	300003745	izw	-/-	-/-
4	A	Positioning Controller	Model 2090	ETS-Lindgren	64672	300003746	izw	-/-	-/-
5	A	Turntable Interface-Box	Model 105637	ETS-Lindgren	44583	300003747	izw	-/-	-/-
6	A	TRILOG Broadband Test-Antenna 30 MHz - 3 GHz	VULB9163	Schwarzbeck Mess-Elektronik	216	300003288	vKI!	31.08.2023	31.08.2025
7	A	Turntable	2089-4.0	EMCO	-/-	300004394	ne	-/-	-/-
8	A	PC	Tecline	F+W	-/-	300004388	ne	-/-	-/-
9	A	EMI Test Receiver	ESR3	Rohde & Schwarz	102587	300005771	k	09.12.2022	31.12.2023

7.2 Shielded fully anechoic chamber

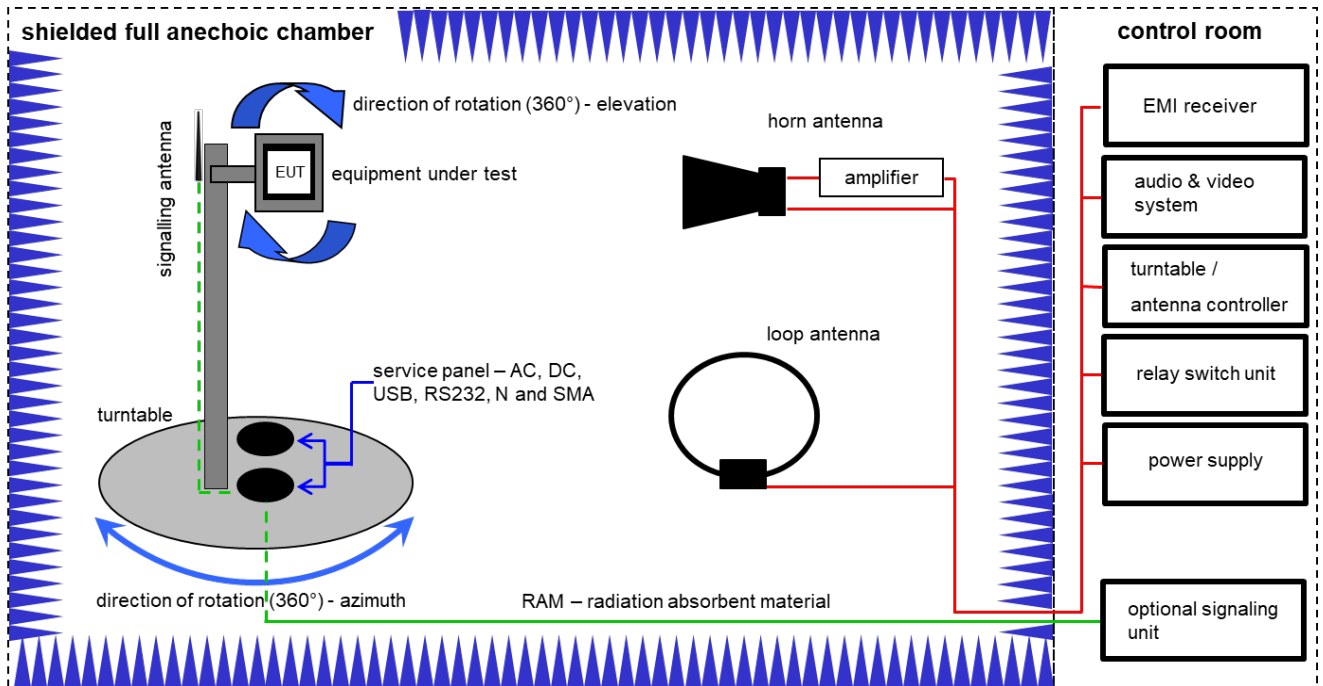

Measurement distance: horn antenna 3 meter; loop antenna 3 meter / 1 meter

$$FS = UR + CA + AF$$

(FS-field strength; UR-voltage at the receiver; CA-loss of the signal path; AF-antenna factor)

Example calculation:

$$FS [dB\mu V/m] = 40.0 [dB\mu V/m] + (-35.8) [dB] + 32.9 [dB/m] = 37.1 [dB\mu V/m] (71.61 \mu V/m)$$

Equipment table:

No.	Setup	Equipment	Type	Manufacturer	Serial No.	INV. No.	Kind of Calibration	Last Calibration	Next Calibration
1	A, B, C	Double-Ridged Waveguide Horn Antenna 1-18.0GHz	3115	EMCO	8812-3089	300000307	vK!	11.02.2022	29.02.2024
2	C	Active Loop Antenna 9 kHz to 30 MHz	6502	EMCO	2210	300001015	vK!	02.08.2023	31.08.2025
3	B	Highpass Filter	WHK1.1/15G-10SS	Wainwright	37	400000148	ne	-/-	-/-
4	B	Highpass Filter	WHKX7.0/18G-8SS	Wainwright	18	300003789	ne	-/-	-/-
5	B	Band Reject Filter	WRCG2400/2483-2375/2505-50/10SS	Wainwright	26	300003792	ne	-/-	-/-
6	A, B, C	Broadband Amplifier 0.5-18 GHz	CBLU5184540	CERNEX	22051	300004483	ev	-/-	-/-
7	A, B, C	4U RF Switch Platform	L4491A	Agilent Technologies	MY50000032	300004510	ne	-/-	-/-
8	A, B, C	Computer	Intel Core i3 3220/3,3 GHz, Prozessor	-/-	2V2403033A54 21	300004591	ne	-/-	-/-
9	A, B, C	NEXIO EMV-Software	BAT EMC V2022.0.22.0	Nexio	-/-	300004682	ne	-/-	-/-
10	A, B, C	Anechoic chamber	-/-	TDK	-/-	300003726	ne	-/-	-/-
11	A, B, C	EMI Test Receiver 9kHz-26,5GHz	ESR26	Rohde & Schwarz	101376	300005063	k	13.12.2022	31.12.2023
12	B	RF-Amplifier	AMF-6F06001800-30-10P-R	NARDA-MITEQ Inc	2011571	300005240	ev	-/-	-/-

7.3 Radiated measurements > 18 GHz

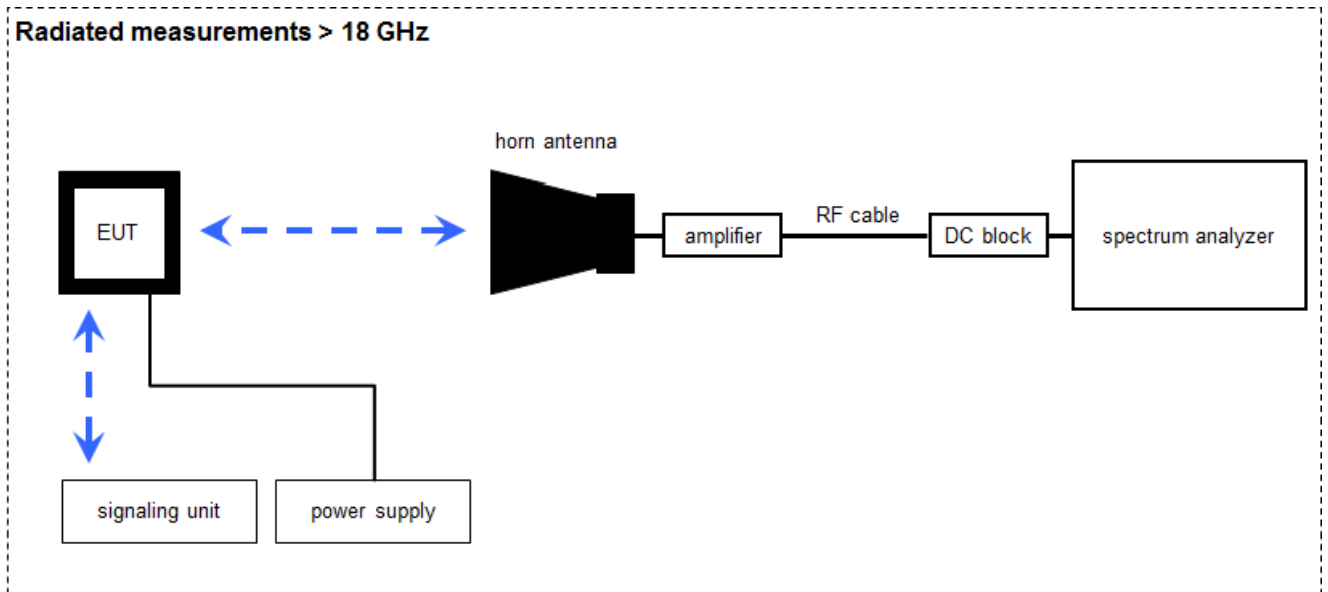

Measurement distance: horn antenna 50 cm

$$FS = UR + CA + AF$$

(FS-field strength; UR-voltage at the receiver; CA-loss signal path & distance correction; AF-antenna factor)

Example calculation:

$$FS [dB\mu V/m] = 40.0 [dB\mu V/m] + (-60.1) [dB] + 36.74 [dB/m] = 16.64 [dB\mu V/m] (6.79 \mu V/m)$$

Equipment table:

No.	Setup	Equipment	Type	Manufacturer	Serial No.	INV. No.	Kind of Calibration	Last Calibration	Next Calibration
1	A	Microwave System Amplifier, 0.5-26.5 GHz	83017A	HP	00419	300002268	ev	-/-	-/-
2	A	Std. Gain Horn Antenna 18.0-26.5 GHz	638	Narda	8205	300002442	k	17.01.2022	31.01.2024
3	A	Signal analyzer	FSV40	Rohde&Schwarz	101042	300004517	k	12.12.2022	31.12.2023
4	A	RF-Cable	ST18/SMAm/SMAm /48	Huber & Suhner	Batch no. 600918	400001182	ev	-/-	-/-
5	A	DC-Blocker 0.1-40 GHz	8141A	Inmet	-/-	400001185	ev	-/-	-/-

7.4 Conducted measurements system

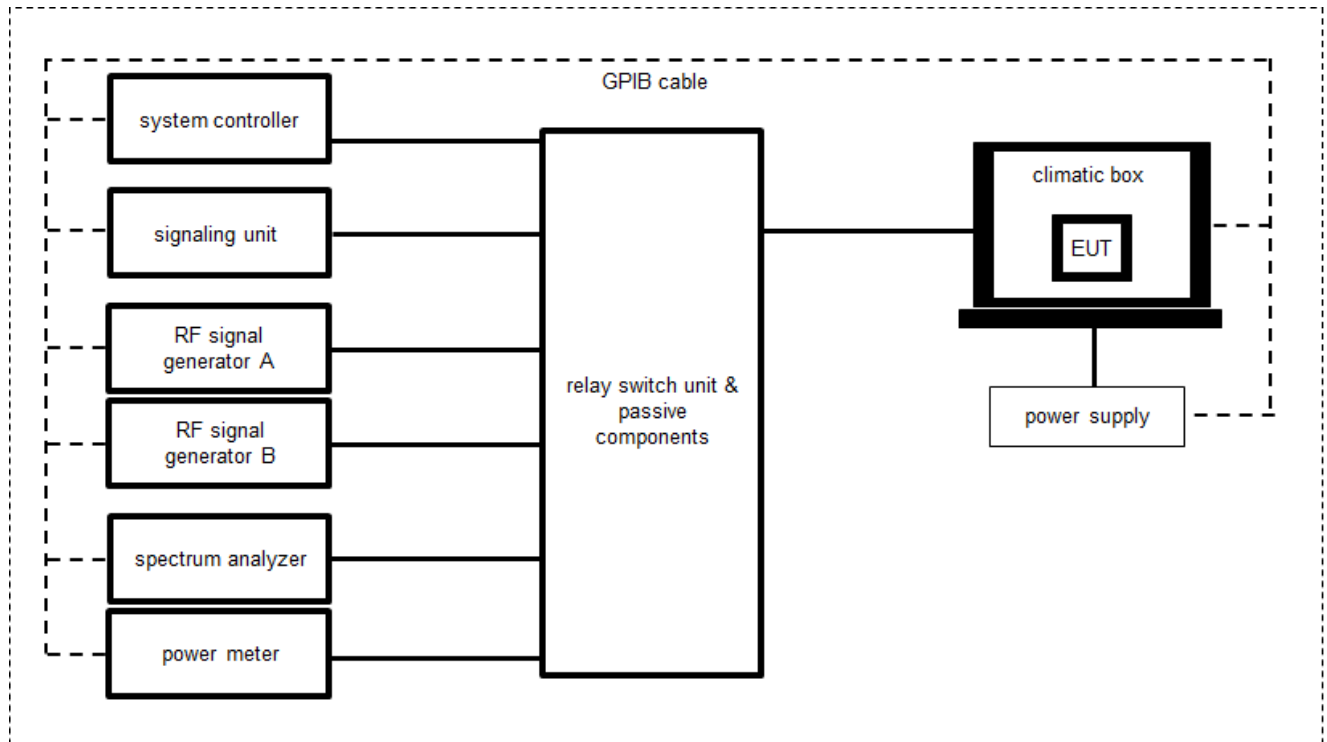

OP = AV + CA
 (OP-output power; AV-analyzer value; CA-loss signal path)

Example calculation:

OP [dBm] = 6.0 [dBm] + 11.7 [dB] = 17.7 [dBm] (58.88 mW)

Equipment table:

No.	Setup	Equipment	Type	Manufacturer	Serial No.	INV. No.	Kind of Calibration	Last Calibration	Next Calibration
1	A	Switch / Control Unit (including DC-Block, Splitter)	3488A	HP	-/-	300000929	ne	-/-	-/-
2	A	Hygro-Thermometer	-/, 5-45C, 20-100rF	Thies Clima	-/-	400000080	ev	15.09.2022	14.09.2024
3	A	Signal analyzer	FSV30	Rohde&Schwarz	1321.3008K30/103170	300004855	vKI!	09.12.2022	31.12.2024
4	A	USB-GPIB-Interface	82357B	Agilent Technologies	MY54323070	300004852	ne	-/-	-/-
5	A	Tester Software C.BER	Version 5.0	cetecom advanced GmbH	0001	400001379	ne	-/-	-/-
6	A	Switch matrix	RSM 1.1	cetecom advanced GmbH	31534892	400001456	ev	20.09.2023	19.09.2024

8 Sequence of testing

8.1 Sequence of testing radiated spurious 9 kHz to 30 MHz

Setup

- The equipment is set up to simulate normal operation mode as described in the user manual or defined by the manufacturer.
- If the EUT is a tabletop system, it is placed on a table with 0.8 m height.
- If the EUT is a floor standing device, it is placed directly on the turn table.
- Auxiliary equipment and cables are positioned to simulate normal operation conditions as described in ANSI C 63.4.
- The AC power port of the EUT (if available) is connected to a power outlet below the turntable.
- Measurement distance is 3 m (see ANSI C 63.4) – see test details.
- EUT is set into operation.

Premeasurement*

- The turntable rotates from 0° to 315° using 45° steps.
- The antenna height is 1 m.
- At each turntable position the analyzer sweeps with positive-peak detector to find the maximum of all emissions.

Final measurement

- Identified emissions during the pre-measurement are maximized by the software by rotating the turntable from 0° to 360°.
- Loop antenna is rotated about its vertical axis for maximum response at each azimuth about the EUT. (For certain applications, the loop antenna plane may also need to be positioned horizontally at the specified distance from the EUT)
- The final measurement is done in the position (turntable and elevation) causing the highest emissions with quasi-peak (as described in ANSI C 63.4).
- Final levels, frequency, measuring time, bandwidth, turntable position, correction factor, margin to the limit and limit will be recorded. A plot with the graph of the premeasurement and the limit is stored.

*Note: The sequence will be repeated three times with different EUT orientations.

8.2 Sequence of testing radiated spurious 30 MHz to 1 GHz

Setup

- The equipment is set up to simulate normal operation mode as described in the user manual or defined by the manufacturer.
- If the EUT is a tabletop system, a table with 0.8 m height is used, which is placed on the ground plane.
- If the EUT is a floor standing device, it is placed on the ground plane with insulation between both.
- Auxiliary equipment and cables are positioned to simulate normal operation conditions as described in ANSI C 63.4.
- The AC power port of the EUT (if available) is connected to a power outlet below the turntable.
- Measurement distance is 10 m or 3 m (see ANSI C 63.4) – see test details.
- EUT is set into operation.

Premeasurement

- The turntable rotates from 0° to 315° using 45° steps.
- The antenna is polarized vertical and horizontal.
- The antenna height changes from 1 m to 3 m.
- At each turntable position, antenna polarization and height the analyzer sweeps three times in peak to find the maximum of all emissions.

Final measurement

- The final measurement is performed for at least six highest peaks according to the requirements of the ANSI C63.4.
- Based on antenna and turntable positions at which the peak values are measured the software maximize the peaks by changing turntable position $\pm 45^\circ$ and antenna height between 1 and 4 m.
- The final measurement is done with quasi-peak detector (as described in ANSI C 63.4).
- Final levels, frequency, measuring time, bandwidth, antenna height, antenna polarization, turntable angle, correction factor, margin to the limit and limit are recorded. A plot with the graph of the premeasurement with marked maximum final results and the limit is stored.

8.3 Sequence of testing radiated spurious 1 GHz to 18 GHz

Setup

- The equipment is set up to simulate normal operation mode as described in the user manual or defined by the manufacturer.
- If the EUT is a tabletop system, a 2-axis positioner with 1.5 m height is used.
- If the EUT is a floor standing device, it is placed directly on the turn table.
- Auxiliary equipment and cables are positioned to simulate normal operation conditions as described in ANSI C 63.4.
- The AC power port of the EUT (if available) is connected to a power outlet below the turntable.
- Measurement distance is 3 m (see ANSI C 63.4) – see test details.
- EUT is set into operation.

Premeasurement

- The turntable rotates from 0° to 315° using 45° steps.
- The antenna is polarized vertical and horizontal.
- The antenna height is 1.5 m.
- At each turntable position and antenna polarization the analyzer sweeps with positive peak detector to find the maximum of all emissions.

Final measurement

- The final measurement is performed for at least six highest peaks according to the requirements of the ANSI C63.4.
- Based on antenna and turntable positions at which the peak values are measured the software maximizes the peaks by rotating the turntable from 0° to 360°. This measurement is repeated for different EUT-table positions (0° to 150° in 30°-steps) and for both antenna polarizations.
- The final measurement is done in the position (turntable, EUT-table and antenna polarization) causing the highest emissions with Peak and RMS detector (as described in ANSI C 63.4).
- Final levels, frequency, measuring time, bandwidth, turntable position, EUT-table position, antenna polarization, correction factor, margin to the limit and limit are recorded. A plot with the graph of the premeasurement with marked maximum final results and the limit is stored.

8.4 Sequence of testing radiated spurious above 18 GHz

Setup

- The equipment is set up to simulate normal operation mode as described in the user manual or defined by the manufacturer.
- Auxiliary equipment and cables are positioned to simulate normal operation conditions as described in ANSI C 63.4.
- The AC power port of the EUT (if available) is connected to a power outlet.
- The measurement distance is as appropriate (e.g. 0.5 m).
- The EUT is set into operation.

Premeasurement

- The test antenna is handheld and moved carefully over the EUT to cover the EUT's whole sphere and different polarizations of the antenna.

Final measurement

- The final measurement is performed at the position and antenna orientation causing the highest emissions with Peak and RMS detector (as described in ANSI C 63.4).
- Final levels, frequency, measuring time, bandwidth, correction factor, margin to the limit and limit are recorded. A plot with the graph of the premeasurement and the limit is stored.

9 Measurement uncertainty

Measurement uncertainty		
Test case	Uncertainty	
Antenna gain	± 3 dB	
Power spectral density	± 1.56 dB	
DTS bandwidth	± 100 kHz (depends on the used RBW)	
Occupied bandwidth	± 100 kHz (depends on the used RBW)	
Maximum output power conducted	± 1.56 dB	
Detailed spurious emissions @ the band edge - conducted	± 1.56 dB	
Band edge compliance radiated	± 3 dB	
Spurious emissions conducted	> 3.6 GHz	± 1.56 dB
	> 7 GHz	± 1.56 dB
	> 18 GHz	± 2.31 dB
	≥ 40 GHz	± 2.97 dB
Spurious emissions radiated below 30 MHz	± 3 dB	
Spurious emissions radiated 30 MHz to 1 GHz	± 3 dB	
Spurious emissions radiated 1 GHz to 12.75 GHz	± 3.7 dB	
Spurious emissions radiated above 12.75 GHz	± 4.5 dB	
Spurious emissions conducted below 30 MHz (AC conducted)	± 2.6 dB	

10 Summary of measurement results

<input checked="" type="checkbox"/>	No deviations from the technical specifications were ascertained
<input type="checkbox"/>	There were deviations from the technical specifications ascertained
<input type="checkbox"/>	This test report is only a partial test report. The content and verdict of the performed test cases are listed below.

TC Identifier	Description	Verdict	Date	Remark
RF-Testing	CFR Part 15 RSS - 247, Issue 3	See table!	2024-05-03	-/-

Test specification clause	Test case	Guideline	Temperature & voltage conditions	C	NC	NA	NP	Remark
§15.247(b)(4) RSS - 247 / 5.4 (f)(ii)	Antenna gain	-/-	Nominal	-/-				-/-
§15.35	Duty cycle	-/-	Nominal	-/-				-/-
§15.247(e) RSS - 247 / 5.2 (b)	Power spectral density	KDB 558074 DTS clause: 8.4	Nominal	<input checked="" type="checkbox"/>	<input type="checkbox"/>	<input type="checkbox"/>	<input type="checkbox"/>	-/-
§15.247(a)(2) RSS - 247 / 5.2 (a)	DTS bandwidth	KDB 558074 DTS clause: 8.2	Nominal	<input checked="" type="checkbox"/>	<input type="checkbox"/>	<input type="checkbox"/>	<input type="checkbox"/>	-/-
RSS Gen clause 4.6.1	Occupied bandwidth	-/-	Nominal	<input checked="" type="checkbox"/>	<input type="checkbox"/>	<input type="checkbox"/>	<input type="checkbox"/>	-/-
§15.247(b)(3) RSS - 247 / 5.4 (d)	Maximum output power	ANSI C63.10- 2013 Chapter 11.9.2.2.2	Nominal	<input checked="" type="checkbox"/>	<input type="checkbox"/>	<input type="checkbox"/>	<input type="checkbox"/>	-/-
§15.247(d) RSS - 247 / 5.5	Detailed spurious emissions @ the band edge – cond.	-/-	Nominal	<input checked="" type="checkbox"/>	<input type="checkbox"/>	<input type="checkbox"/>	<input type="checkbox"/>	-/-
§15.205 RSS - 247 / 5.5 RSS - Gen	Band edge compliance cond. or rad.	KDB 558074 DTS clause: 8.7.3	Nominal	<input checked="" type="checkbox"/>	<input type="checkbox"/>	<input type="checkbox"/>	<input type="checkbox"/>	-/-
§15.247(d) RSS - 247 / 5.5	TX spurious emissions cond.	KDB 558074 DTS clause: 8.5	Nominal	<input checked="" type="checkbox"/>	<input type="checkbox"/>	<input type="checkbox"/>	<input type="checkbox"/>	-/-
§15.209(a) RSS-Gen	TX spurious emissions rad. below 30 MHz	-/-	Nominal	<input checked="" type="checkbox"/>	<input type="checkbox"/>	<input type="checkbox"/>	<input type="checkbox"/>	-/-
§15.247(d) RSS - 247 / 5.5 RSS-Gen	TX spurious emissions rad. 30 MHz to 1 GHz	-/-	Nominal	<input checked="" type="checkbox"/>	<input type="checkbox"/>	<input type="checkbox"/>	<input type="checkbox"/>	-/-
§15.247(d) RSS - 247 / 5.5 RSS-Gen	TX spurious emissions rad. above 1 GHz	-/-	Nominal	<input checked="" type="checkbox"/>	<input type="checkbox"/>	<input type="checkbox"/>	<input type="checkbox"/>	-/-
§15.107(a) §15.207	Conducted emissions < 30 MHz	-/-	Nominal	<input type="checkbox"/>	<input type="checkbox"/>	<input checked="" type="checkbox"/>	<input type="checkbox"/>	-/-

Notes:

C	Compliant	NC	Not compliant	NA	Not applicable	NP	Not performed
----------	-----------	-----------	---------------	-----------	----------------	-----------	---------------

11 Additional information and comments

Reference documents: None

Co-applicable documents: 1-6579-23-01-45_TR1-A201-R01.pdf
TCU2 US IP30 - Technical Passport-v1.00-20230707_120232.pdf

Special test descriptions: All tests were performed with both ports/antennas transmitting simultaneously. All modes only support MIMO, not SISO.

Configuration descriptions: Used power setting:
b-mode: 16
g-mode: 13
nHT20-mode: 13

- EUT selection:
- Only one device available
 - Devices selected by the customer
 - Devices selected by the laboratory (Randomly)

Provided channels:

Channels with 20 MHz channel bandwidth:

channel number & center frequency													
channel	1	2	3	4	5	6	7	8	9	10	11	12	13
f _c / MHz	2412	2417	2422	2427	2432	2437	2442	2447	2452	2457	2462	2467	2472

Note: The channels used for the tests are marked in bold in the list.

12 Additional EUT parameter

- Test mode:
- No test mode available
Iperf was used to ping another device with the largest support packet size
 - Test mode available
Special software is used.
EUT is transmitting pseudo random data by itself
- Modulation types:
- Wide Band Modulation (None Hopping – e.g. DSSS, OFDM)
 - Frequency Hopping Spread Spectrum (FHSS)
- Antennas and transmit operating modes:
- Operating mode 1 (single antenna)
 - Equipment with 1 antenna,
 - Equipment with 2 diversity antennas operating in switched diversity mode by which at any moment in time only 1 antenna is used,
 - Smart antenna system with 2 or more transmit/receive chains, but operating in a mode where only 1 transmit/receive chain is used)
 - Operating mode 2 (multiple antennas, no beamforming)
 - Equipment operating in this mode contains a smart antenna system using two or more transmit/receive chains simultaneously but without beamforming.
 - Operating mode 3 (multiple antennas, with beamforming)
 - Equipment operating in this mode contains a smart antenna system using two or more transmit/receive chains simultaneously with beamforming.
In addition to the antenna assembly gain (G), the beamforming gain (Y) may have to be taken into account when performing the measurements.

13 Measurement results

13.1 Antenna gain

Limits:

FCC	ISED
6 dBi / > 6 dBi output power and power density reduction required	

Results:

antenna port 1	lowest channel	middle channel	highest channel
Gain [dBi] / Declared	5.1		

antenna port 2	lowest channel	middle channel	highest channel
Gain [dBi] / Declared	5.1		

13.2 Identify worst case data rate

Description:

All modes of the module will be measured with an average power meter or spectrum analyzer to identify the maximum transmission power.

In further tests only the identified worst case modulation scheme or bandwidth will be measured and this mode is used as representative mode for all other modulation schemes.

Measurement:

Measurement parameter	
Detector	Peak
Sweep time	Auto
Resolution bandwidth	3 MHz
Video bandwidth	3 MHz
Trace mode	Max hold
Test setup	See chapter 7.4 setup A
Measurement uncertainty	See chapter 9

Results:

Modulation scheme / bandwidth	
DSSS / b – mode	1 Mbit/s
OFDM / g – mode	6 Mbit/s
OFDM / n HT20 – mode	MCS0

13.3 Maximum output power

Description:

Measurement of the maximum conducted average output power. The measurements are performed using the data rate identified in the previous chapter.

Measurement:

Measurement parameter	
According to ANSI C63.10-2013 Chapter 11.9.2.2.2	
External result file(s)	1-6579_23-01-10_TR1_A201.pdf
Test setup	See chapter 7.4 setup B
Measurement uncertainty	See chapter 9

Limits:

FCC	ISED
Conducted 1.0 W / 30 dBm with an antenna gain of max. 6 dBi	

Results:

antenna port 1	maximum output power / dBm		
	lowest channel	middle channel	highest channel
Output power conducted DSSS / b – mode	15.3	15.7	16.6
Output power conducted OFDM / g – mode	11.8	12.0	13.0
Output power conducted OFDM / n HT20 – mode	10.1	10.3	11.2

antenna port 2	maximum output power / dBm		
	lowest channel	middle channel	highest channel
Output power conducted DSSS / b – mode	16.0	16.6	16.8
Output power conducted OFDM / g – mode	11.8	12.2	12.4
Output power conducted OFDM / n HT20 – mode	10.1	10.5	10.6

antenna port 1 + 2 calculated	maximum output power / dBm		
	lowest channel	middle channel	highest channel
Output power conducted DSSS / b – mode	18.7	19.2	19.7
Output power conducted OFDM / g – mode	14.8	15.1	15.7
Output power conducted OFDM / n HT20 – mode	13.1	13.4	13.9

13.4 Duty cycle

Description:

Measurement of the timing behavior.

Measurement:

Measurement parameter	
Detector	Peak
Sweep time	Depends on the signal see plot
Resolution bandwidth	10 MHz
Video bandwidth	10 MHz
Trace mode	Max hold
Test setup	See chapter 7.4 setup A
Measurement uncertainty	See chapter 9

Limits:

FCC	ISED
No limitation!	

Results:

T _{nom}	V _{nom}	lowest channel	middle channel	highest channel
DSSS / b – mode		100 % / 0.0 dB	100 % / 0.0 dB	100 % / 0.0 dB
OFDM / g – mode		100 % / 0.0 dB	100 % / 0.0 dB	100 % / 0.0 dB
OFDM / n HT20 – mode		100 % / 0.0 dB	100 % / 0.0 dB	100 % / 0.0 dB

13.5 Average power spectral density

Measurement:

Measurement parameter	
According to DTS clause: 8.4	
External result file(s)	1-6579_23-01-10_TR1_A201.pdf
Test setup	See chapter 7.4 setup A
Measurement uncertainty	See chapter 9

Limits:

FCC	ISED
8 dBm / 3 kHz (conducted)	

Results: antenna port 1

measured	average power spectral density / dBm @ 3 kHz		
	Lowest channel	Middle channel	Highest channel
DSSS / b – mode	-16.5	-15.2	-15.2
OFDM / g – mode	-22.4	-22.1	-21.4
OFDM / n HT20 – mode	-23.4	-23.3	-22.4

Results: antenna port 2

measured	average power spectral density / dBm @ 3 kHz		
	Lowest channel	Middle channel	Highest channel
DSSS / b – mode	-15.9	-15.3	-15.0
OFDM / g – mode	-22.5	-21.9	-22.0
OFDM / n HT20 – mode	-23.4	-22.9	-23.0

Results: antenna port 1 + 2

measured	average power spectral density / dBm @ 3 kHz		
	Lowest channel	Middle channel	Highest channel
DSSS / b – mode	-13.2	-12.1	-12.1
OFDM / g – mode	-19.4	-19.0	-18.7
OFDM / n HT20 – mode	-19.9	-20.1	-19.7

13.6 6 dB DTS bandwidth

Description:

Measurement of the 6 dB bandwidth of the modulated signal.

Measurement:

Measurement parameter	
According to DTS clause: 8.2	
Detector	Peak
Sweep time	Auto
Resolution bandwidth	100 kHz
Video bandwidth	500 kHz
Span	30 MHz / 50 MHz
Trace mode	Single count with 200 counts
External result file(s)	1-6579_23-01-10_TR1_A201.pdf
Test setup	See chapter 7.4 setup A
Measurement uncertainty	See chapter 9

Limits:

FCC	ISED
Systems using digital modulation techniques may operate in the 2400–2483.5 MHz band. The minimum 6 dB bandwidth shall be at least 500 kHz.	

Results:

antenna port 1	6 dB DTS bandwidth / kHz		
	lowest channel	middle channel	highest channel
DSSS / b – mode	8060	8060	8064
OFDM / g – mode	15076	15116	15128
OFDM / n HT20 – mode	16468	16472	16468

antenna port 2	6 dB DTS bandwidth / kHz		
	lowest channel	middle channel	highest channel
DSSS / b – mode	7572	7572	8064
OFDM / g – mode	15100	15128	15116
OFDM / n HT20 – mode	16428	16452	16440

13.7 Occupied bandwidth – 99% emission bandwidth

Description:

Measurement of the 99% bandwidth of the modulated signal acc. RSS-GEN.

Measurement:

Measurement parameter	
Detector	Peak
Sweep time	Auto
Resolution bandwidth	300 kHz
Video bandwidth	1 MHz
Span	30 MHz / 50 MHz
Measurement procedure	Measurement of the 99% bandwidth using the integration function of the analyzer
Trace mode	Single count with 200 counts
External result file(s)	1-6579_23-01-10_TR1_A201.pdf
Test setup	See chapter 7.4 setup A
Measurement uncertainty	See chapter 9

Usage:

-/-	ISED
OBW is necessary for Emission Designator	

Results:

antenna port 1	99% emission bandwidth / kHz		
	lowest channel	middle channel	highest channel
DSSS / b – mode	13283	13299	13367
OFDM / g – mode	16494	16490	16514
OFDM / n HT20 – mode	17170	17174	17182

antenna port 2	99% emission bandwidth / kHz		
	lowest channel	middle channel	highest channel
DSSS / b – mode	13479	13563	13711
OFDM / g – mode	16438	16442	16442
OFDM / n HT20 – mode	17162	17158	17158

13.8 Occupied bandwidth – 20 dB bandwidth

Description:

Measurement of the 20 dB bandwidth of the modulated carrier.

Measurement:

Measurement parameter	
Detector	Peak
Sweep time	Auto
Resolution bandwidth	100 kHz
Video bandwidth	500 kHz
Span	30 MHz / 50 MHz
Trace mode	Single count with min. 200 counts
External result file(s)	1-6579_23-01-10_TR1_A201.pdf
Test setup	See chapter 7.4 setup A
Measurement uncertainty	See chapter 9

Usage:

-/-	ISED
The complete bandwidth has to be within the frequency range of the band.	

Results:

antenna port 1	20 dB bandwidth / MHz		
	lowest channel	middle channel	highest channel
DSSS / b – mode	15384	15384	15408
OFDM / g – mode	18472	18520	18408
OFDM / n HT20 – mode	19912	20180	20132

antenna port 2	20 dB bandwidth / MHz		
	lowest channel	middle channel	highest channel
DSSS / b – mode	15436	15452	16072
OFDM / g – mode	17996	17980	18008
OFDM / n HT20 – mode	20180	20412	20196

13.9 Band edge compliance radiated

Description:

Measurement of the radiated band edge compliance. The EUT is turned in the position that results in the maximum level at the band edge. Then a sweep over the corresponding restricted band is performed. The EUT is set to the lowest channel for the lower restricted band and to the highest channel for the upper restricted band. Measurement distance is 3 meter.

Measurement:

	Measurement parameter for peak measurements	Measurement parameter for average measurements
		According to DTS clause: 8.7.3
Detector	Peak	RMS
Sweep time	Auto	Auto
Resolution bandwidth	1 MHz	100 kHz
Video bandwidth	3 MHz	300 kHz
Span	See plot	2 MHz
Trace mode	Max. hold	RMS Average over 101 sweeps
Analyzer function	-/-	Band power function (Compute the power by integrating the spectrum over 1 MHz)
Test setup	See chapter 7.2 setup A	
Measurement uncertainty	See chapter 9	

Limits:

FCC	ISED
74 dBµV/m @ 3 m (Peak) 54 dBµV/m @ 3 m (AVG)	

Results:

band edge compliance radiated / (dBµV / m) @ 3 m			
	b-mode	g-mode	nHT20-mode
Lower band edge	48.8 dBµV/m AVG 58.0 dBµV/m Peak	48.9 dBµV/m AVG 63.0 dBµV/m Peak	52.3 dBµV/m AVG 67.8 dBµV/m Peak
Upper band edge	46.1 dBµV/m AVG 57.1 dBµV/m Peak	53.4 dBµV/m AVG 68.8 dBµV/m Peak	53.7 dBµV/m AVG 70.8 dBµV/m Peak

Plots: b-mode - peak / average

Plot 1: TX mode, lower band edge, vertical & horizontal polarization

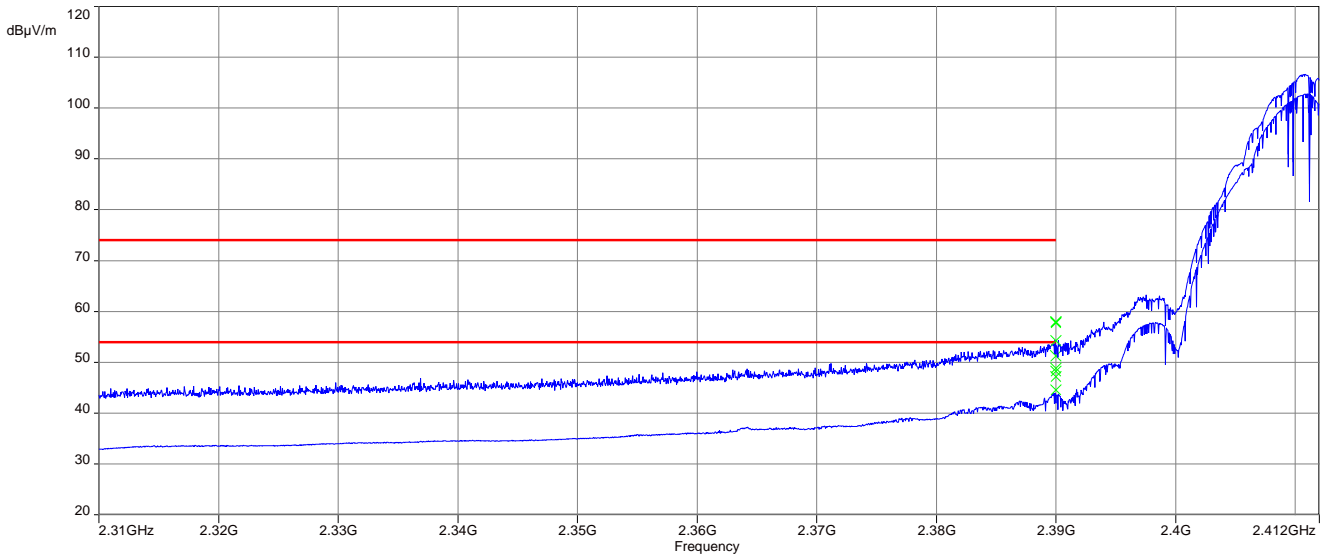

Plot 2: TX mode, upper band edge, vertical & horizontal polarization

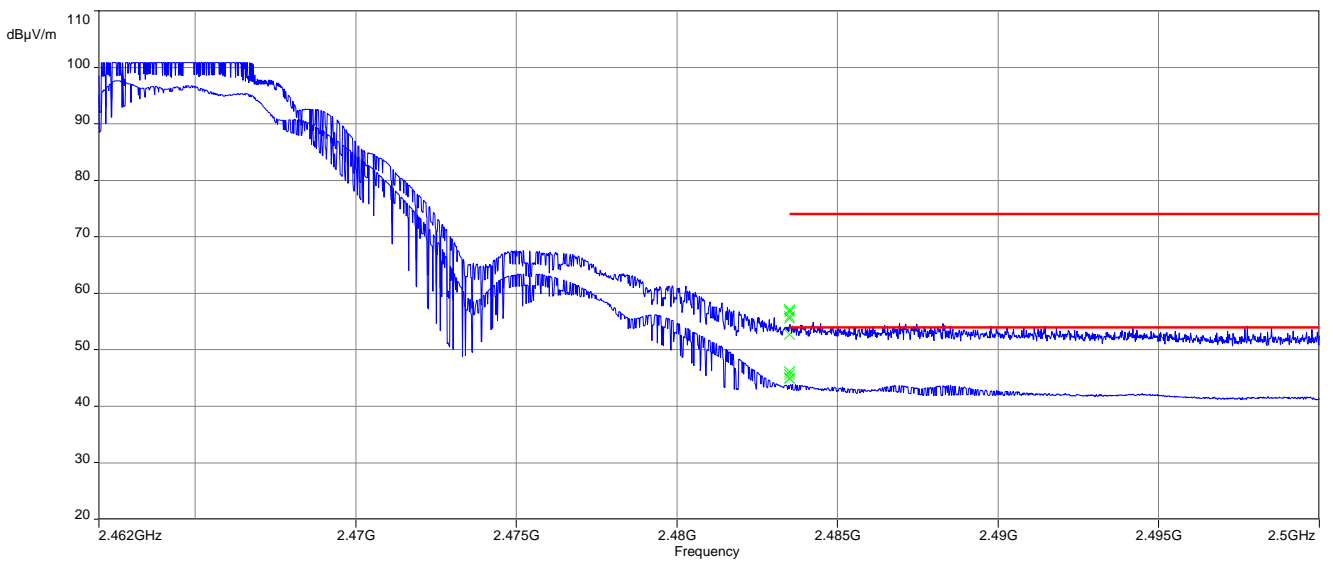

Plots: g-mode - peak / average

Plot 1: TX mode, lower band edge, vertical & horizontal polarization

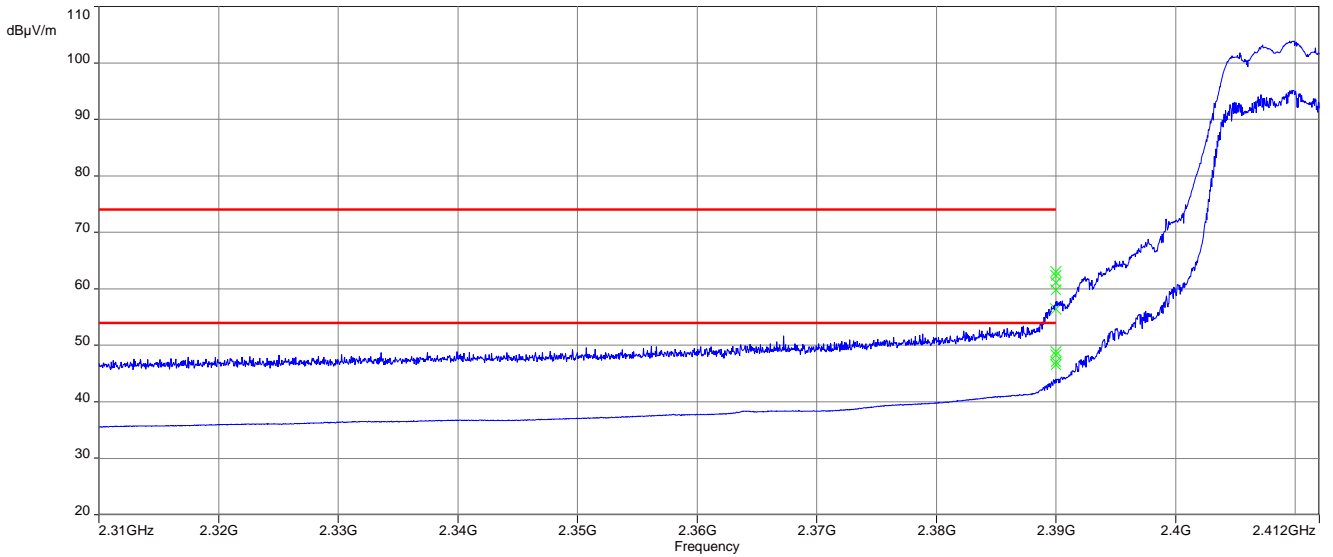

Plot 2: TX mode, upper band edge, vertical & horizontal polarization

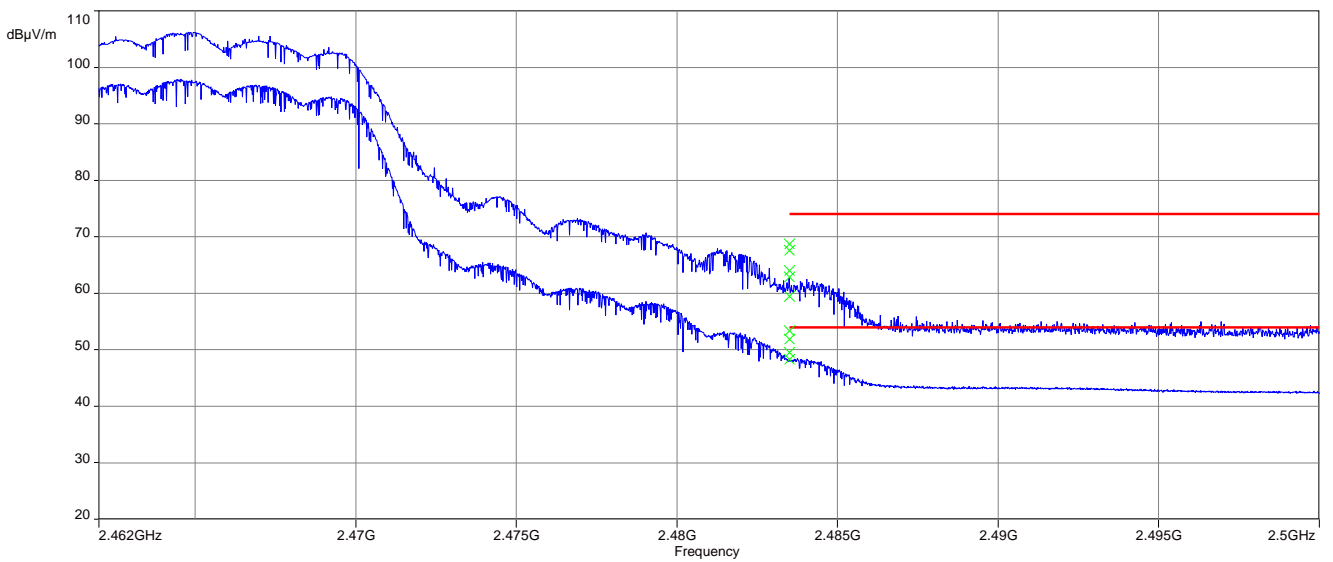

Plots: nHT20 - mode peak / average

Plot 1: TX mode, lower band edge, vertical & horizontal polarization

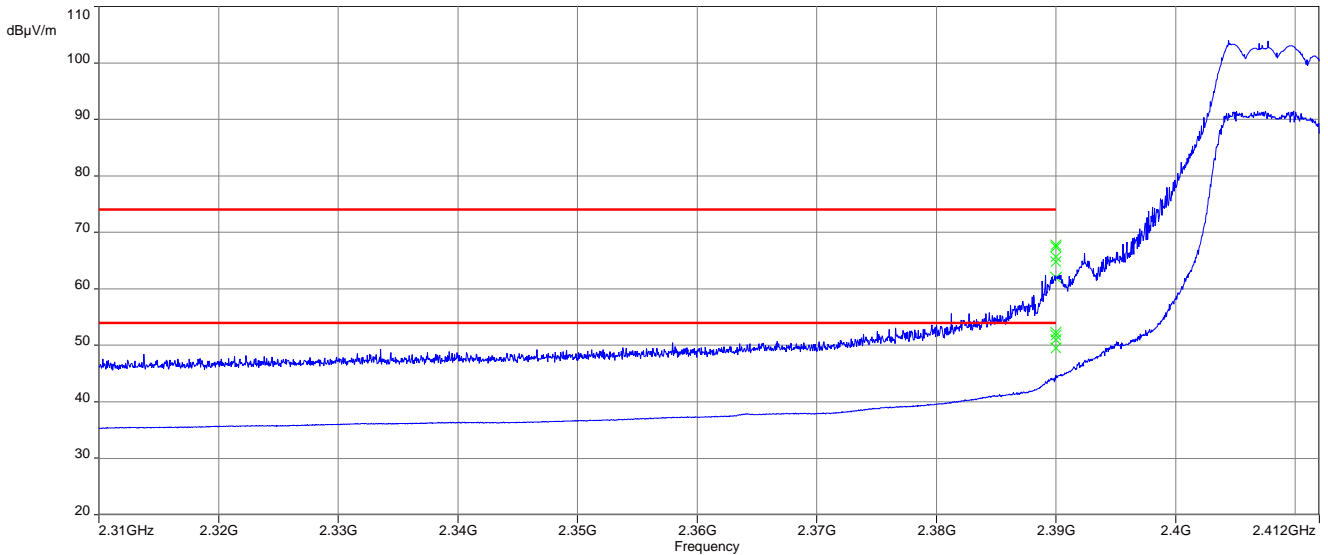

Plot 2: TX mode, upper band edge, vertical & horizontal polarization

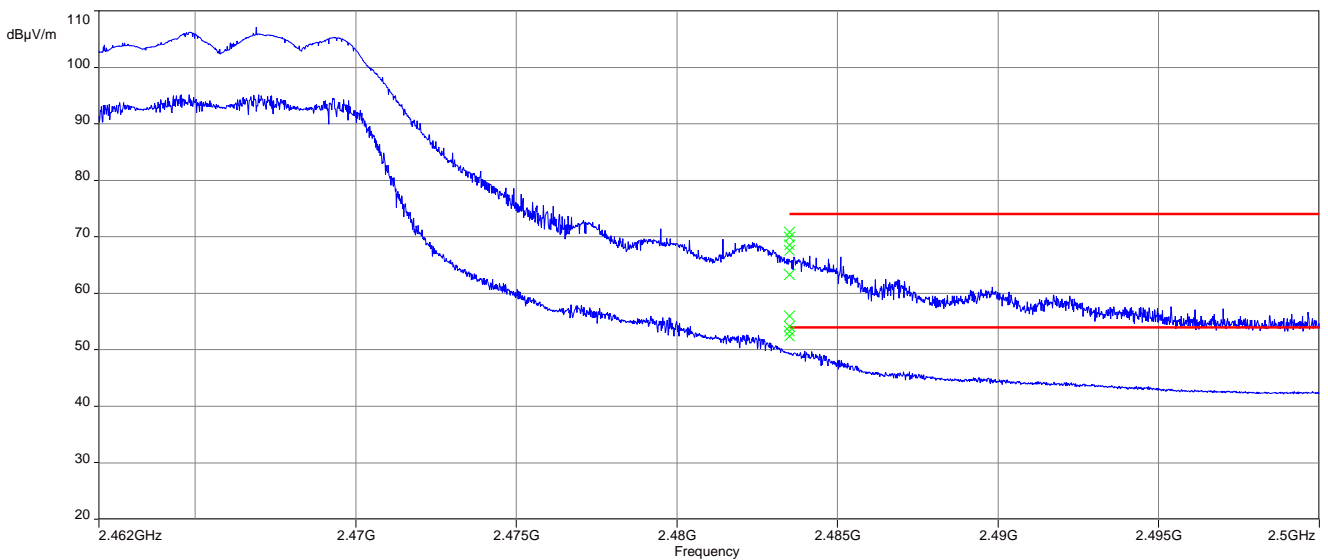

NOTE: The average values in the plot are an automated measurement and result in an overestimation of the average values. The value was re-measured manually and the exact value is stated in the result tables in this chapter.

13.10 Spurious emissions conducted

Description:

Measurement of the conducted spurious emissions in transmit mode. The measurement is performed at the lowest; the middle and the highest channel.

Measurement:

Measurement parameter	
Detector	Peak
Sweep time	Auto
Resolution bandwidth	100 kHz
Video bandwidth	500 kHz
Span	9 kHz to 25 GHz
Trace mode	Max Hold
External result file(s)	1-6579_23-01-10_TR1_A201.pdf
Test setup	See chapter 7.4 setup A
Measurement uncertainty	See chapter 9

Limits:

FCC	ISED
In any 100 kHz bandwidth outside the frequency band in which the spread spectrum or digitally modulated intentional radiator is operating, the radio frequency power that is produced by the intentional radiator shall be at least 30 dB below that in the 100 kHz bandwidth within the band that contains the highest level of the desired power, based on either an RF conducted or a radiated measurement. Attenuation below the general limits specified in Section 15.209(a) is not required	

Results: Compliant (see log file)

13.11 Spurious emissions radiated below 30 MHz

Description:

Measurement of the radiated spurious emissions in transmit mode below 30 MHz. The limits are recalculated to a measurement distance of 3 m with 40 dB/decade according CFR Part 2.

Measurement:

Measurement parameter	
Detector	Peak / Quasi Peak
Sweep time	Auto
Resolution bandwidth	F < 150 kHz: 200 Hz F > 150 kHz: 9 kHz
Video bandwidth	F < 150 kHz: 1 kHz F > 150 kHz: 100 kHz
Span	9 kHz to 30 MHz
Trace mode	Max Hold
Measured modulation	<input checked="" type="checkbox"/> DSSS b – mode <input checked="" type="checkbox"/> OFDM g – mode <input type="checkbox"/> OFDM n HT20 – mode
Test setup	See chapter 7.2 setup C
Measurement uncertainty	See chapter 9

Limits:

FCC		ISED	
Frequency / MHz	Field Strength / (dBµV / m)	Measurement distance / m	
0.009 – 0.490	2400/F(kHz)	300	
0.490 – 1.705	24000/F(kHz)	30	
1.705 – 30.0	30	30	

Results:

TX spurious emissions radiated < 30 MHz / (dBµV / m) @ 3 m		
Frequency / MHz	Detector	Level / (dBµV / m)
All detected peaks are more than 20 dB below the limit.		

Plots: DSSS

Plot 1: 9 kHz to 30 MHz, lowest channel

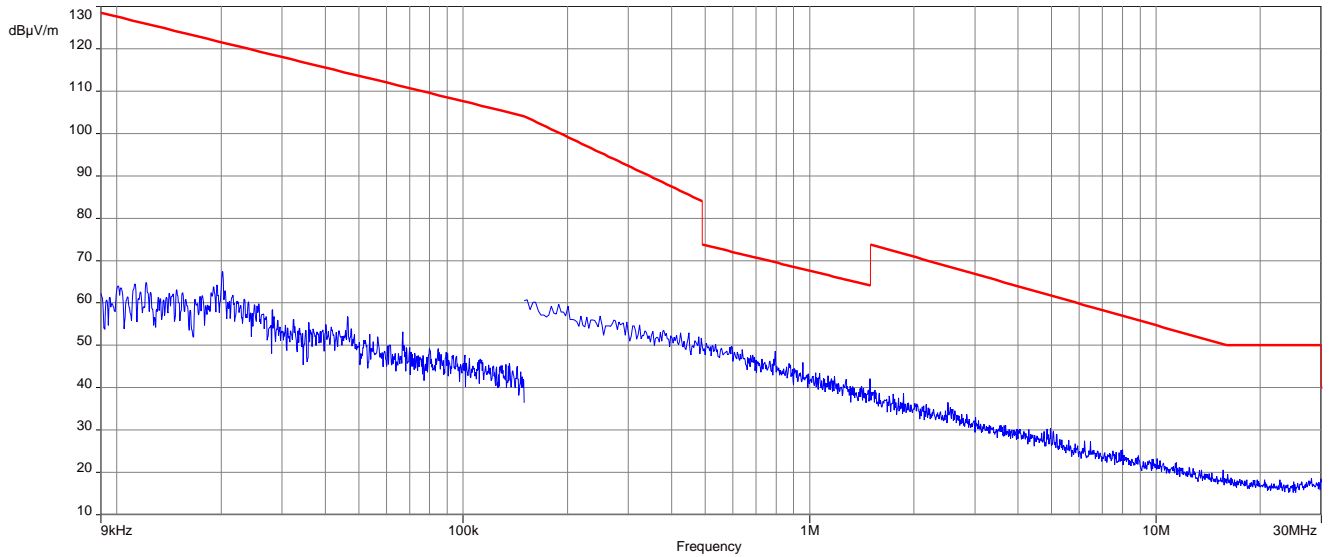

Plot 2: 9 kHz to 30 MHz, middle channel

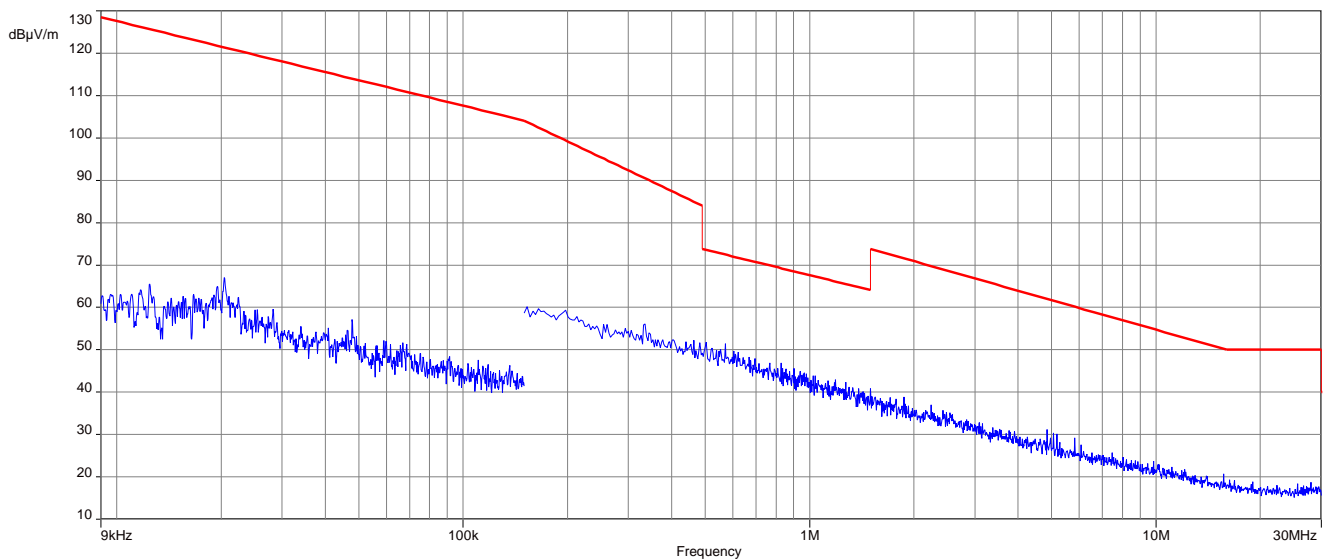

Plot 3: 9 kHz to 30 MHz, highest channel

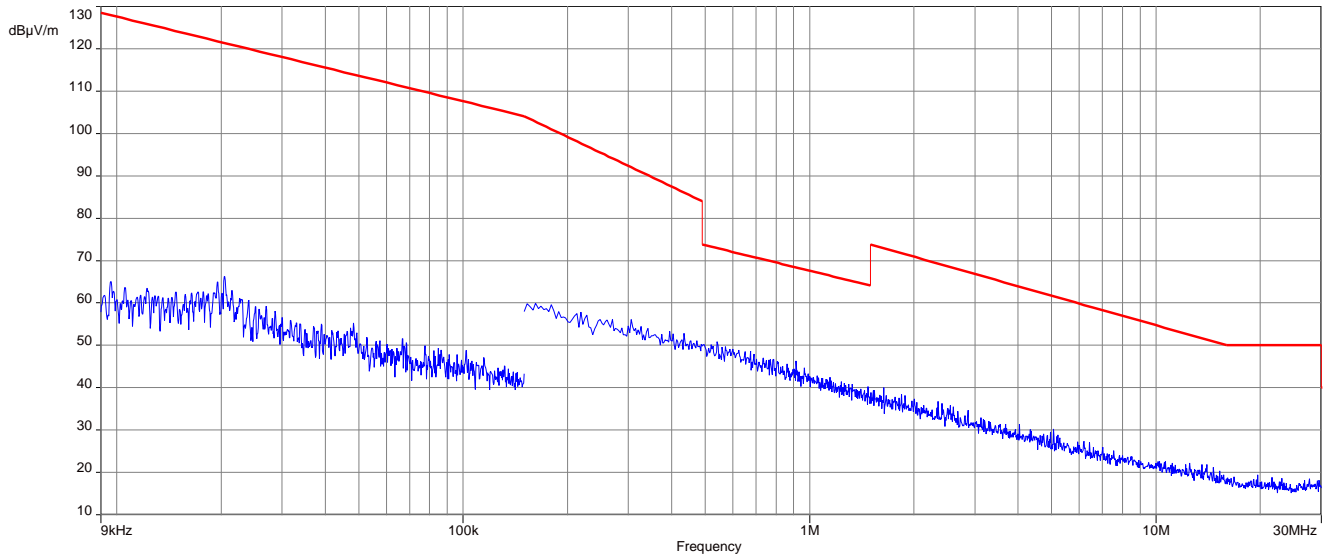

Plots: OFDM (20 MHz nominal channel bandwidth)

Plot 1: 9 kHz to 30 MHz, lowest channel

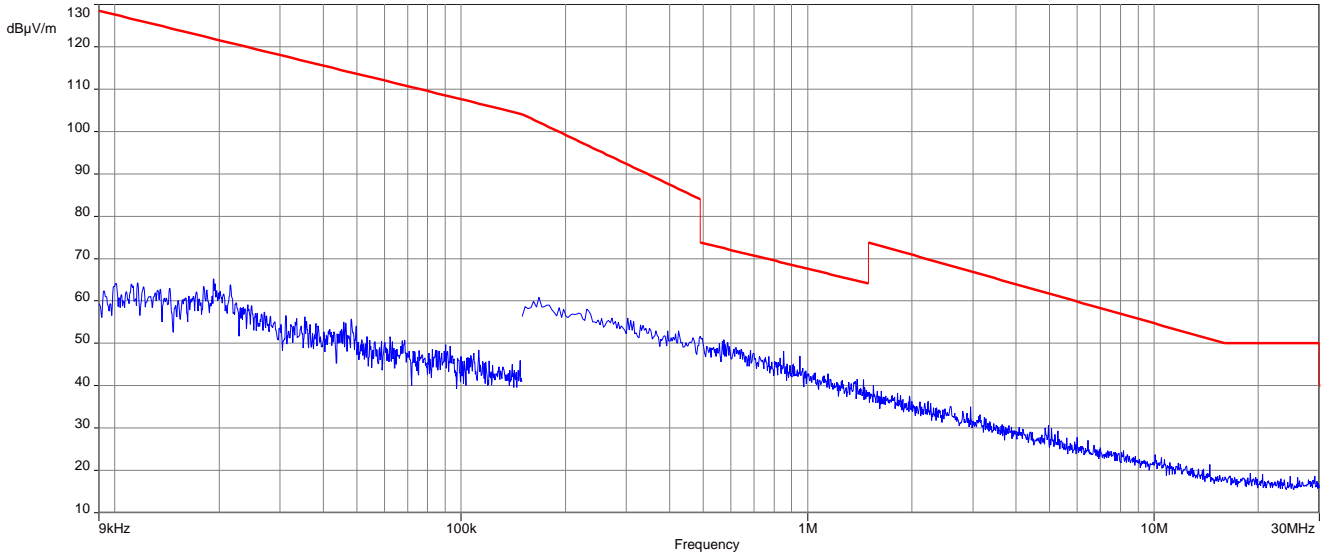

Plot 2: 9 kHz to 30 MHz, middle channel

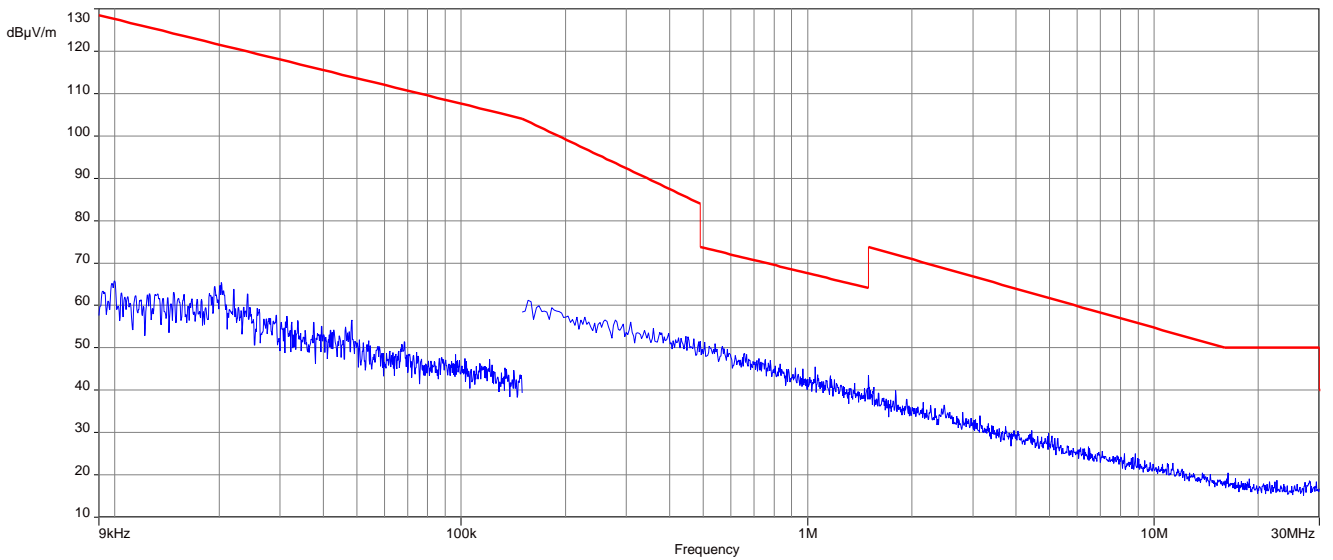

Plot 3: 9 kHz to 30 MHz, highest channel

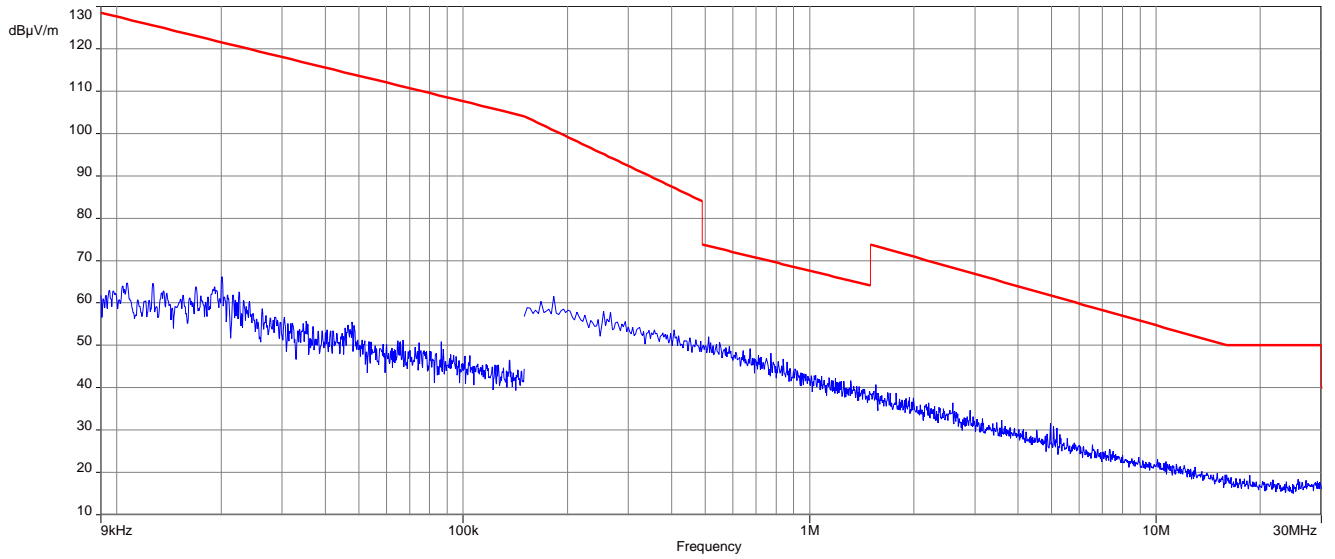

13.12 Spurious emissions radiated 30 MHz to 1 GHz

Description:

Measurement of the radiated spurious emissions and cabinet radiations below 1 GHz.

Measurement:

Measurement parameter	
Detector	Peak / Quasi Peak
Sweep time	Auto
Resolution bandwidth	120 kHz
Video bandwidth	3 x RBW
Span	30 MHz to 1 GHz
Trace mode	Max Hold
Measured modulation	<input type="checkbox"/> DSSS b – mode <input type="checkbox"/> OFDM g – mode <input type="checkbox"/> OFDM n HT20 – mode <input type="checkbox"/> OFDM n HT40 – mode
Test setup	See chapter 7.1 setup A
Measurement uncertainty	See chapter 9

Limits:

FCC	ISED	
In any 100 kHz bandwidth outside the frequency band in which the spread spectrum or digitally modulated intentional radiator is operating, the radio frequency power that is produced by the intentional radiator shall be at least 20 dB below that in the 100 kHz bandwidth within the band that contains the highest level of the desired power, based on either an RF conducted or a radiated measurement. Attenuation below the general limits specified in Section 15.209(a) is not required. In addition, radiated emissions which fall in the restricted bands, as defined in §15.205(a), must also comply with the radiated emission limits specified in §15.209(a) (see §15.205(c)).		
Frequency / MHz	Field Strength / (dBµV / m)	Measurement distance / m
30 – 88	30.0	10
88 – 216	33.5	10
216 – 960	36.0	10

Plot: DSSS

Plot 1: 30 MHz to 1 GHz, vertical & horizontal polarization, valid for all channels

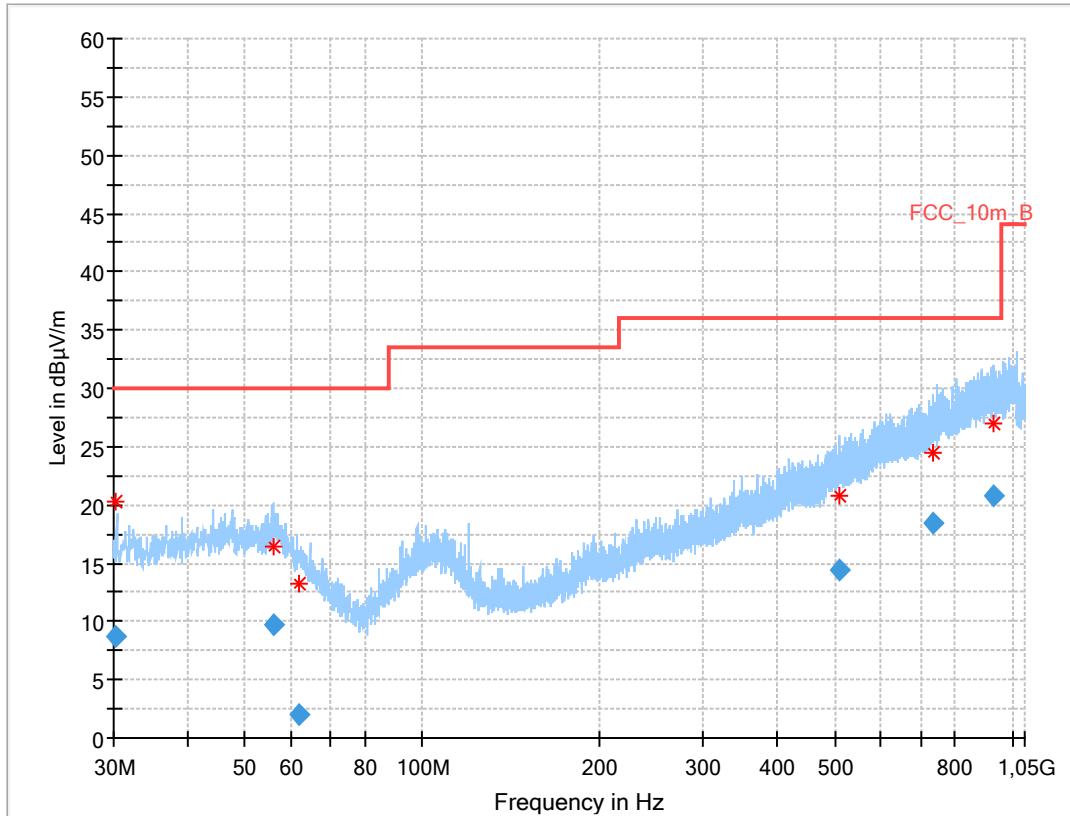

Final results:

Frequency (MHz)	QuasiPeak (dBµV/m)	Limit (dBµV/m)	Margin (dB)	Meas. Time (ms)	Bandwidth (kHz)	Height (cm)	Pol	Azimuth (deg)	Corr. (dB)
30.188	8.70	30.0	21.3	1000	120.0	153.0	V	137	13
55.950	9.75	30.0	20.3	1000	120.0	260.0	V	59	16
61.655	2.04	30.0	28.0	1000	120.0	400.0	V	-45	13
508.004	14.42	36.0	21.6	1000	120.0	112.0	V	135	20
734.227	18.37	36.0	17.6	1000	120.0	224.0	H	45	23
931.511	20.77	36.0	15.2	1000	120.0	106.0	H	-39	26

Plot: OFDM (20 MHz nominal channel bandwidth)

Plot 1: 30 MHz to 1 GHz, vertical & horizontal polarization, valid for all channels

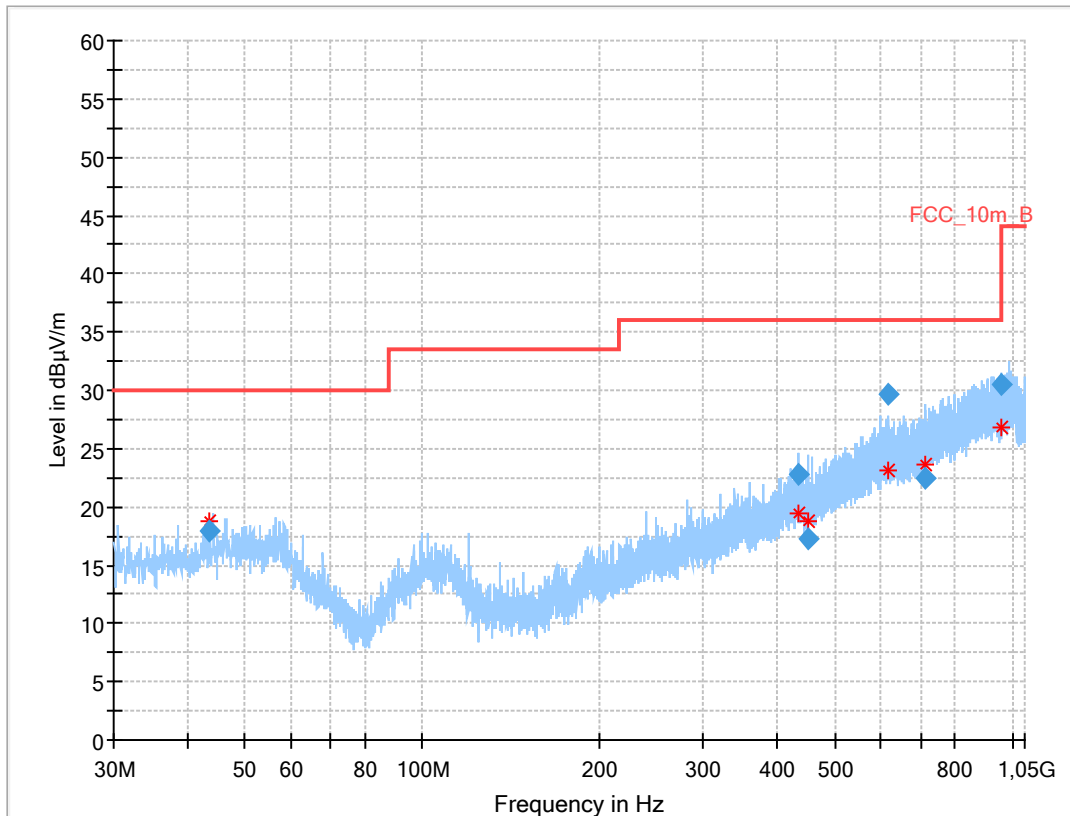

Final results:

Frequency (MHz)	QuasiPeak (dBµV/m)	Limit (dBµV/m)	Margin (dB)	Meas. Time (ms)	Bandwidth (kHz)	Height (cm)	Pol	Azimuth (deg)	Corr. (dB)
43.658	18.00	30.0	12.0	1000	120.0	102.0	V	242	15
434.647	22.75	36.0	13.3	1000	120.0	195.0	H	232	19
451.115	17.34	36.0	18.7	1000	120.0	195.0	V	232	18
615.467	29.67	36.0	6.3	1000	120.0	195.0	V	65	22
710.255	22.45	36.0	13.6	1000	120.0	195.0	H	142	22
955.693	30.57	36.0	5.4	1000	120.0	195.0	V	232	25

13.13 Spurious emissions radiated above 1 GHz

Description:

Measurement of the radiated spurious emissions above 1 GHz in transmit mode and receiver / idle mode.

Measurement:

Measurement parameter	
Detector	Peak / RMS
Sweep time	Auto
Resolution bandwidth	1 MHz
Video bandwidth	3 x RBW
Span	1 GHz to 26 GHz
Trace mode	Max Hold
Measured modulation	<input checked="" type="checkbox"/> DSSS b – mode <input checked="" type="checkbox"/> OFDM g – mode <input type="checkbox"/> OFDM n HT20 – mode
Test setup	See chapter 7.2 setup B & 7.3 setup A
Measurement uncertainty	See chapter 9

Limits:

FCC	ISED	
In any 100 kHz bandwidth outside the frequency band in which the spread spectrum or digitally modulated intentional radiator is operating, the radio frequency power that is produced by the intentional radiator shall be at least 30 dB below that in the 100 kHz bandwidth within the band that contains the highest level of the desired power, based on either an RF conducted or a radiated measurement. Attenuation below the general limits specified in Section 15.209(a) is not required. In addition, radiated emissions which fall in the restricted bands, as defined in §15.205(a), must also comply with the radiated emission limits specified in §15.209(a) (see §15.205(c)).		
Frequency / MHz	Field Strength / (dBµV / m)	Measurement distance / m
Above 960	54.0 (AVG)	3
	74.0 (peak)	

Results: DSSS

TX spurious emissions radiated / dBµV/m @ 3 m								
lowest channel			middle channel			highest channel		
f / MHz	Detector	Level / dBµV/m	f / MHz	Detector	Level / dBµV/m	f / MHz	Detector	Level / dBµV/m
-/-	Peak	-/-	-/-	Peak	-/-	1200	Peak	40.9
	AVG	-/-		AVG	-/-		AVG	34.1
-/-	Peak	-/-	-/-	Peak	-/-	4924	Peak	48.0
	AVG	-/-		AVG	-/-		AVG	41.7

Results: OFDM (20 MHz nominal channel bandwidth)

TX spurious emissions radiated / dBµV/m @ 3 m								
lowest channel			middle channel			highest channel		
f / MHz	Detector	Level / dBµV/m	f / MHz	Detector	Level / dBµV/m	f / MHz	Detector	Level / dBµV/m
All detected emissions are more than 20 dB below the limit.			All detected emissions are more than 20 dB below the limit.			All detected emissions are more than 20 dB below the limit.		
	Peak			Peak			Peak	
	AVG			AVG			AVG	
	Peak			Peak			Peak	
	AVG			AVG			AVG	

Plots: DSSS

Plot 1: Lowest channel, 1 GHz to 18 GHz, vertical & horizontal polarization

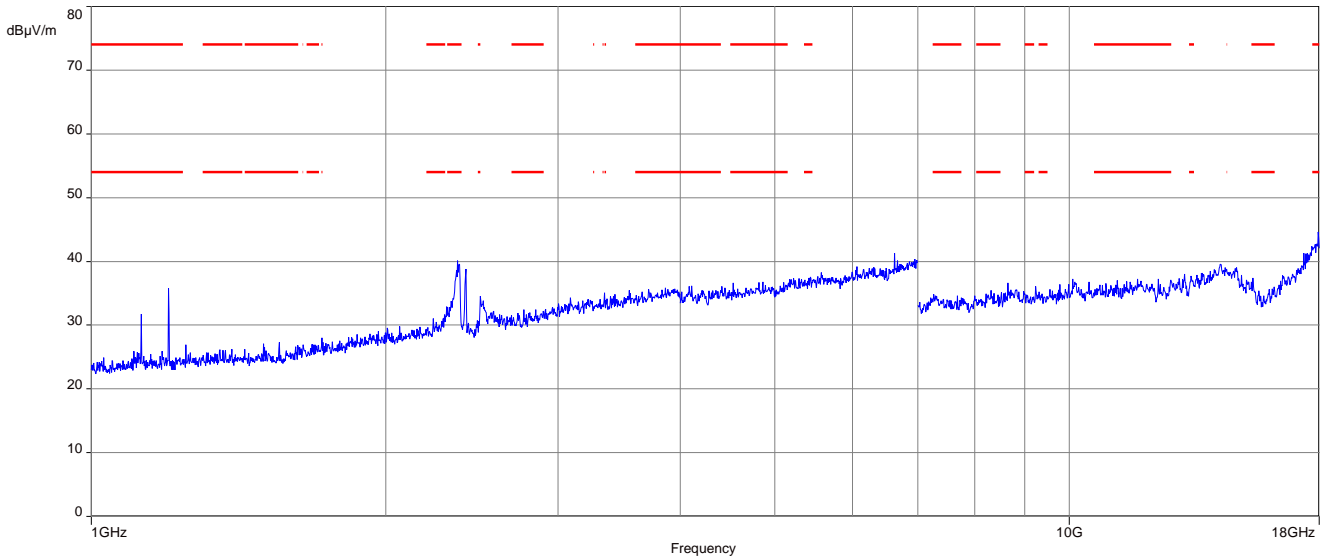

The carrier signal is notched with a 2.4 GHz band rejection filter.

Plot 2: Middle channel, 1 GHz to 18 GHz, vertical & horizontal polarization

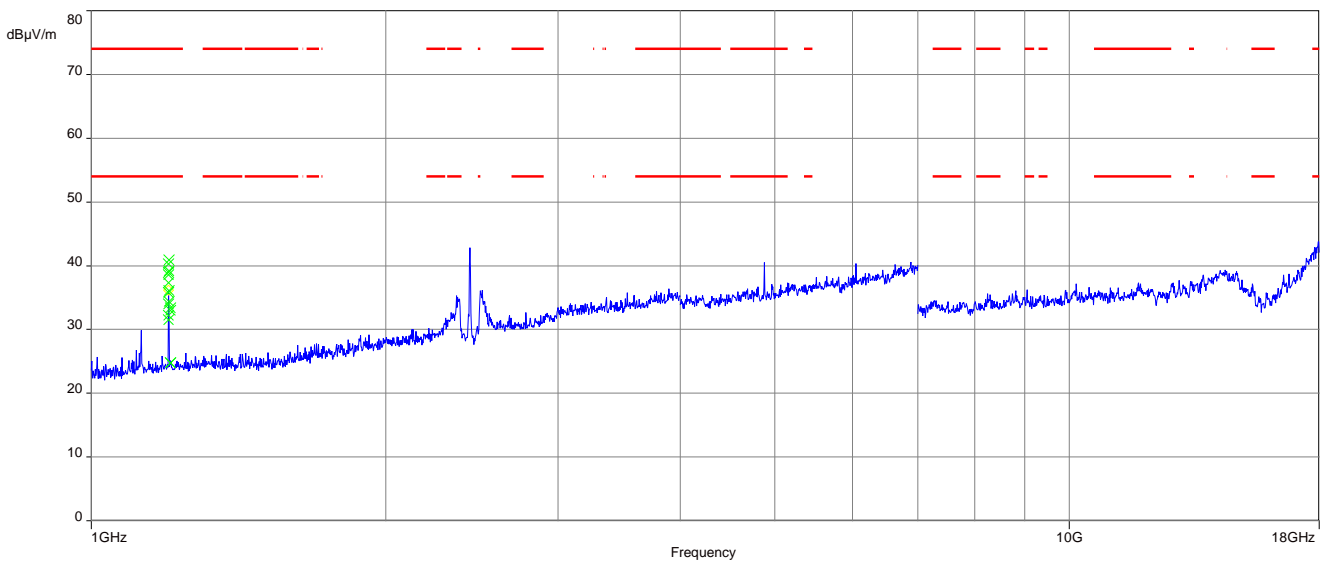

The carrier signal is notched with a 2.4 GHz band rejection filter.

Plot 3: Highest channel, 1 GHz to 18 GHz, vertical & horizontal polarization

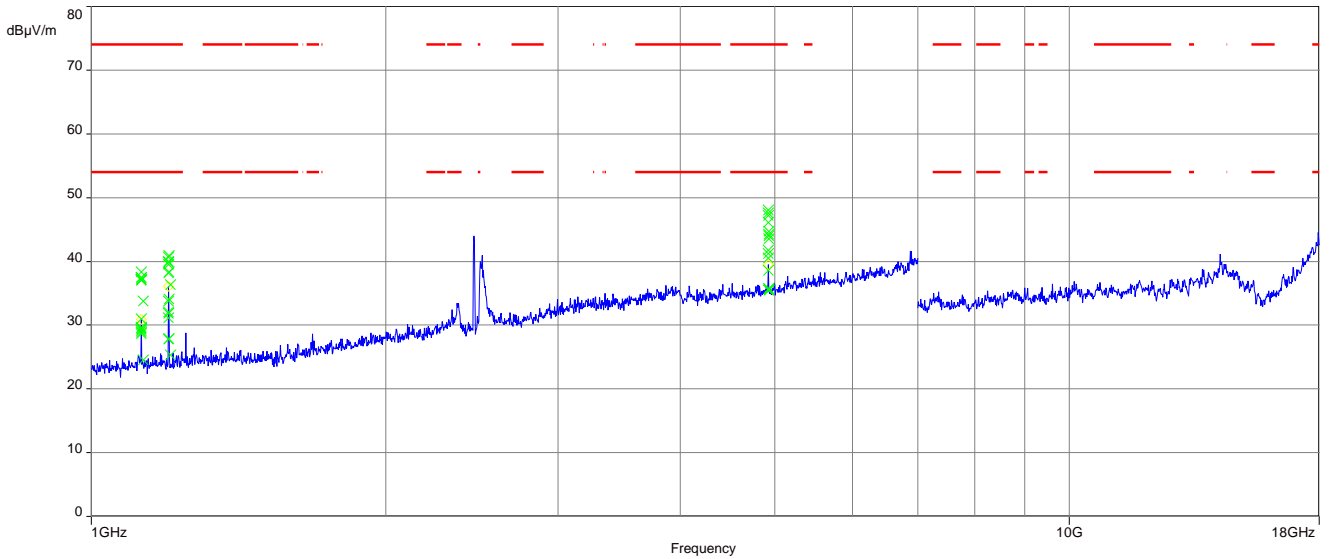

The carrier signal is notched with a 2.4 GHz band rejection filter.

Plots: OFDM (20 MHz bandwidth)

Plot 1: Lowest channel, 1 GHz to 18 GHz, vertical & horizontal polarization

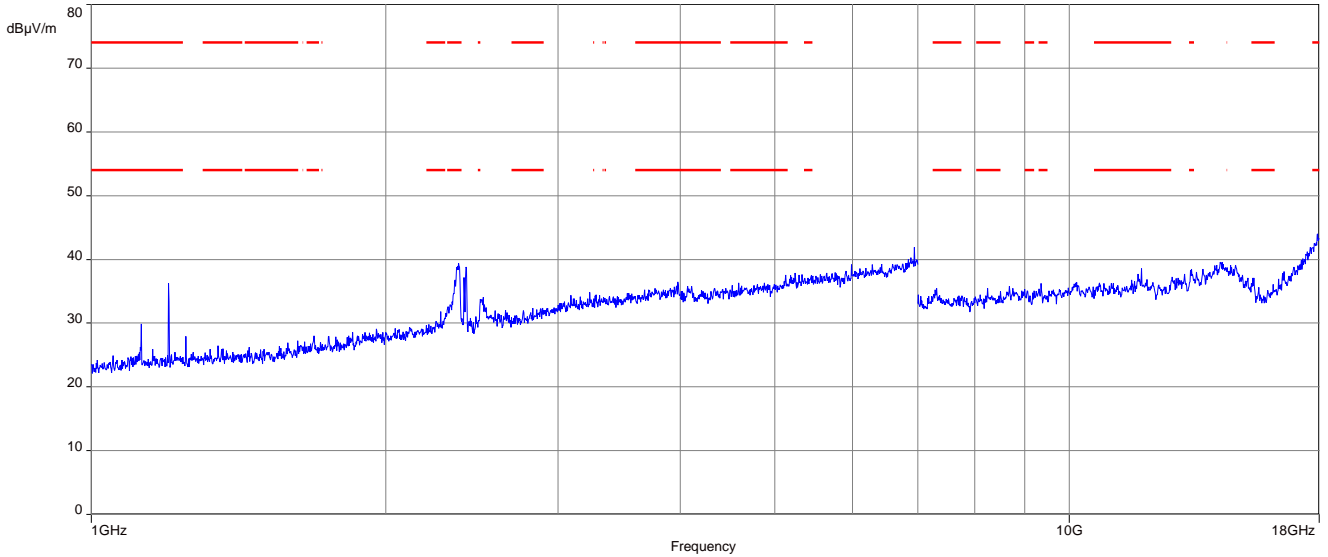

The carrier signal is notched with a 2.4 GHz band rejection filter.

Plot 2: Middle channel, 1 GHz to 18 GHz, vertical & horizontal polarization

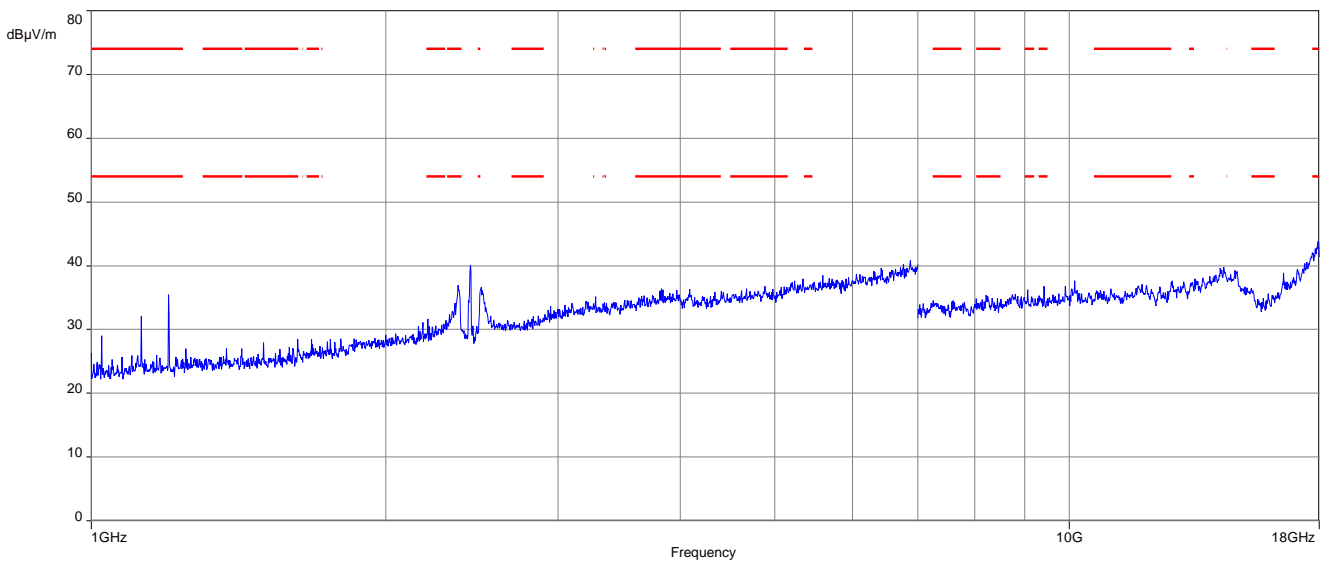

The carrier signal is notched with a 2.4 GHz band rejection filter.

Plot 3: Highest channel, 1 GHz to 18 GHz, vertical & horizontal polarization

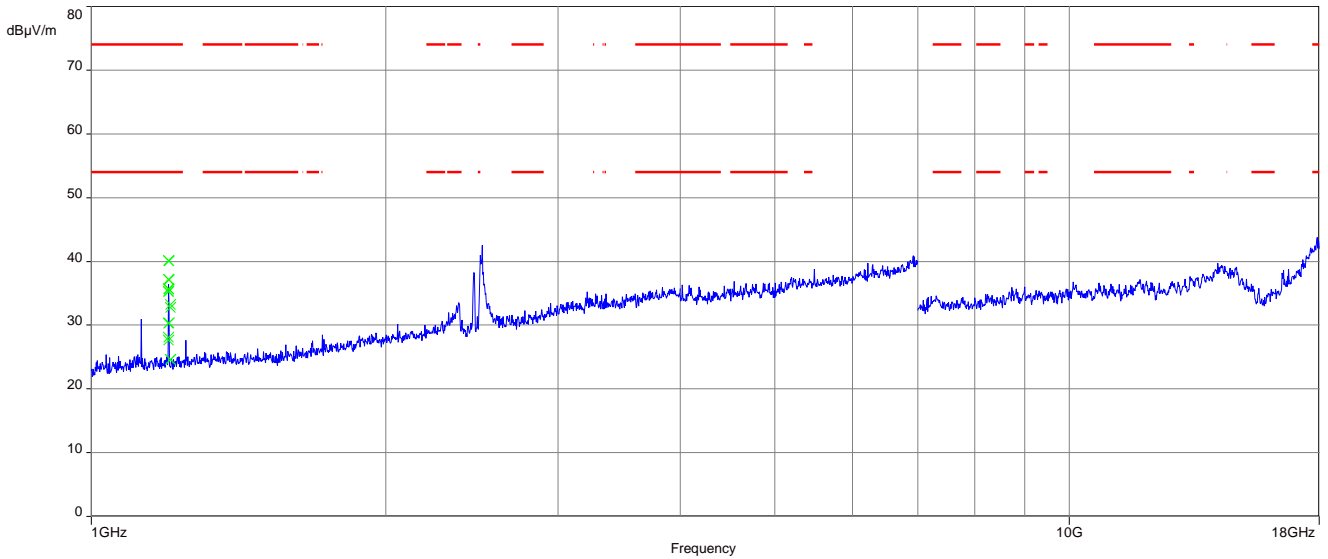

The carrier signal is notched with a 2.4 GHz band rejection filter.

Plot 4: 18 GHz to 26 GHz, vertical & horizontal polarization, valid for all channels and modes

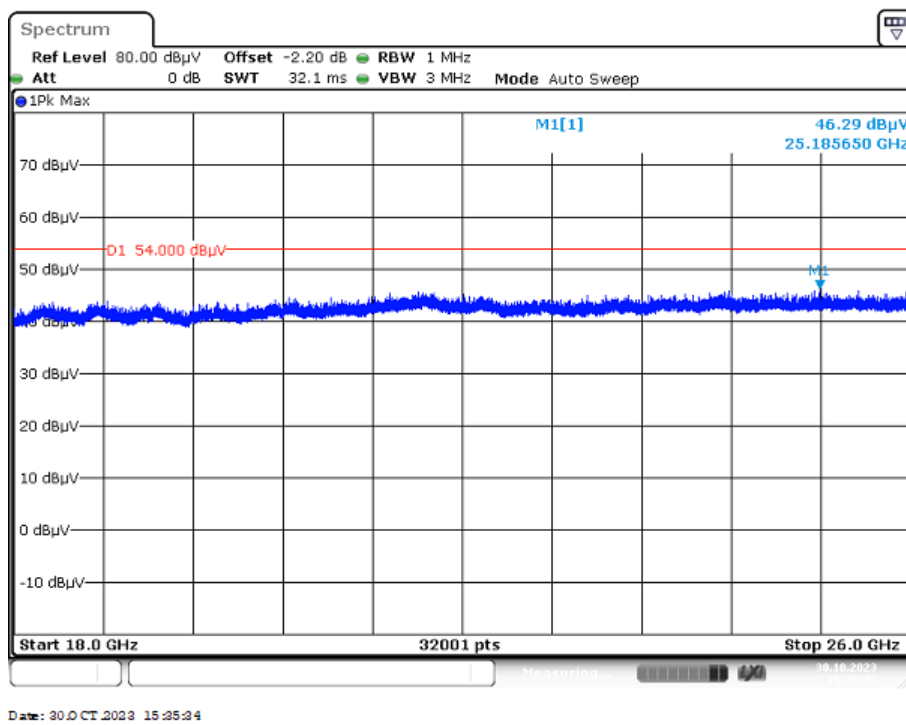

14 Glossary

AVG	Average
C	Compliant
C/N₀	Carrier to noise-density ratio, expressed in dB-Hz
CAC	Channel availability check
CW	Clean wave
DC	Duty cycle
DFS	Dynamic frequency selection
DSSS	Dynamic sequence spread spectrum
DUT	Device under test
EN	European Standard
ETSI	European Telecommunications Standards Institute
EMC	Electromagnetic Compatibility
EUT	Equipment under test
FCC	Federal Communications Commission
FCC ID	Company Identifier at FCC
FHSS	Frequency hopping spread spectrum
FVIN	Firmware version identification number
GNSS	Global Navigation Satellite System
GUE	GNSS User Equipment
HMN	Host marketing name
HVIN	Hardware version identification number
HW	Hardware
IC	Industry Canada
Inv. No.	Inventory number
MC	Modulated carrier
NA	Not applicable
NC	Not compliant
NOP	Non occupancy period
NP	Not performed
OBW	Occupied bandwidth
OC	Operating channel
OCW	Operating channel bandwidth
OFDM	Orthogonal frequency division multiplexing
OOB	Out of band
OP	Occupancy period
PER	Packet error rate
PMN	Product marketing name
PP	Positive peak
QP	Quasi peak
RLAN	Radio local area network
S/N or SN	Serial number
SW	Software
UUT	Unit under test
WLAN	Wireless local area network

15 Document history

Version	Applied changes	Date of release
-/-	Initial release	2024-05-03

END OF TEST REPORT