

TEST REPORT



Test report no.: 1-6579_23-01-41_TR1_R01

Testing laboratory

cetecom advanced GmbH
Untertuerkheimer Strasse 6 – 10
66117 Saarbruecken / Germany
Phone: + 49 681 5 98 - 0
Fax: + 49 681 5 98 - 9075
Internet: <https://cetecomadvanced.com>
e-mail: mail@cetecomadvanced.com

Accredited Testing Laboratory:

The testing laboratory (area of testing) is accredited according to DIN EN ISO/IEC 17025 (2018-03) by the Deutsche Akkreditierungsstelle GmbH (DAkKS).

The accreditation is valid for the scope of testing procedures as stated in the accreditation certificate with the registration number: D-PL-12047-01-00.
ISED Testing Laboratory Recognized Listing Number: DE0001
FCC designation number: DE0002

Applicant

Robert Bosch GmbH
Robert-Bosch-Straße 200
31139 Hildesheim / GERMANY
Phone: -/-
Contact: Thomas Dargel
e-mail: Thomas.Dargel@de.bosch.com

Manufacturer

Robert Bosch GmbH
Robert-Bosch-Straße 200
31139 Hildesheim / GERMANY

Test standard/s

FCC - Title 47 CFR Part 15 FCC - Title 47 of the Code of Federal Regulations; Chapter I; Part 15 - Radio frequency devices

For further applied test standards please refer to section 3 of this test report.

Test Item

Kind of test item: Telematics Control Unit Generation 2
Model name: TCU2 NA IP30
FCC ID: 2AUXS-TCU2NAIP30
ISED certification number: 25847-TCU2NAIP30
Frequency: 5150 MHz to 5350 MHz & 5470 MHz to 5825 MHz
Technology tested: WLAN
Antenna: Two Integrated antennas with MIMO capability
Power supply: 12 V DC by external power supply
Temperature range: -40°C to +65°C

This test report is electronically signed and valid without handwritten signature. For verification of the electronic signatures, the public keys can be requested at the testing laboratory.

Test report authorized:

p.o.

Michael Dorongovski
Lab Manager
Radio Labs

Test performed:

David Lang
Lab Manager
Radio Labs

1 Table of contents

1	Table of contents.....	2
2	General information.....	3
2.1	Notes and disclaimer.....	3
2.2	Application details.....	3
2.3	Test laboratories sub-contracted.....	3
3	Test standard/s, references and accreditations.....	4
4	Reporting statements of conformity – decision rule.....	4
5	Test environment.....	5
6	Test item.....	5
6.1	General description.....	5
6.2	Additional information.....	5
7	Measurement uncertainty.....	6
8	Summary of measurement results.....	7
9	Additional comments.....	8
10	RF measurements.....	9
10.1	Description of test setup.....	9
10.1.1	Conducted measurements.....	9
10.2	Parameters of DFS test signals.....	11
10.2.1	DFS Detection Thresholds for Master Devices as well as Client Devices With Radar Detection.....	11
10.2.2	DFS Response Requirement Values.....	11
10.2.3	Radar Test Waveforms.....	12
10.3	Test preparation.....	15
10.3.1	Channel loading.....	15
10.3.2	99% Bandwidth to determine the U-NII-bandwidth.....	16
10.3.3	Radar burst timing signal.....	17
10.4	Test results (prior to use of a channel).....	18
10.5	Test results (during normal operation).....	18
10.5.1	Channel move time / channel closing transmission time.....	18
10.5.2	Non-Occupancy Period.....	20
11	Observations.....	21
12	Glossary.....	21
13	Document history.....	22

2 General information

2.1 Notes and disclaimer

The test results of this test report relate exclusively to the test item specified in this test report. cetecom advanced GmbH does not assume responsibility for any conclusions and generalizations drawn from the test results with regard to other specimens or samples of the type of the equipment represented by the test item.

The test report may only be reproduced or published in full. Reproduction or publication of extracts from the report requires the prior written approval of cetecom advanced GmbH.

The testing service provided by cetecom advanced GmbH has been rendered under the current "General Terms and Conditions for cetecom advanced GmbH".

cetecom advanced GmbH will not be liable for any loss or damage resulting from false, inaccurate, inappropriate or incomplete product information provided by the customer.

Under no circumstances does the cetecom advanced GmbH test report include any endorsement or warranty regarding the functionality, quality or performance of any other product or service provided.

Under no circumstances does the cetecom advanced GmbH test report include or imply any product or service warranties from cetecom advanced GmbH, including, without limitation, any implied warranties of merchantability, fitness for purpose, or non-infringement, all of which are expressly disclaimed by cetecom advanced GmbH.

All rights and remedies regarding vendor's products and services for which cetecom advanced GmbH has prepared this test report shall be provided by the party offering such products or services and not by cetecom advanced GmbH.

In no case this test report can be considered as a Letter of Approval.

This test report is electronically signed and valid without handwritten signature. For verification of the electronic signatures, the public keys can be requested at the testing laboratory.

2.2 Application details

Date of receipt of order:	2023-08-30
Date of receipt of test item:	2024-04-02
Start of test:*	2024-04-24
End of test:*	2024-04-24
Person(s) present during the test:	-/-

*Date of each measurement, if not shown in the plot, can be requested. Dates are stored in the measurement software.

2.3 Test laboratories sub-contracted

None

3 Test standard/s, references and accreditations

Test standard	Date	Description
FCC - Title 47 CFR Part 15		FCC - Title 47 of the Code of Federal Regulations; Chapter I; Part 15 - Radio frequency devices
RSS - 247 Issue 3	August 2023	Digital Transmission Systems (DTSS), Frequency Hopping Systems (FHSs) and Licence - Exempt Local Area Network (LE-LAN) Devices

Guidance	Version	Description
KDB 558074 D01	v05r02	GUIDANCE FOR COMPLIANCE MEASUREMENTS ON DIGITAL TRANSMISSION SYSTEM, FREQUENCY HOPPING SPREAD SPECTRUM SYSTEM, AND HYBRID SYSTEM DEVICES OPERATING UNDER SECTION 15.247 OF THE FCC RULES
ANSI C63.10-2013	-/-	American National Standard of Procedures for Compliance Testing of Unlicensed Wireless Devices
UNII: KDB 905462 D02	v02	Compliance measurement procedures for unlicensed - national information infrastructure devices operating in the 5250 - 5350 MHz and 5470 - 5725 MHz bands incorporating dynamic frequency selection
UNII: KDB 905462 D03	v01r02	Client Without DFS New Rules

4 Reporting statements of conformity – decision rule

Only the measured values related to their corresponding limits will be used to decide whether the equipment under test meets the requirements of the test standards listed in chapter 3. The measurement uncertainty is mentioned in this test report, see chapter 8, but is not taken into account - neither to the limits nor to the measurement results. Measurement results with a smaller margin to the corresponding limits than the measurement uncertainty have a potential risk of more than 5% that the decision might be wrong."

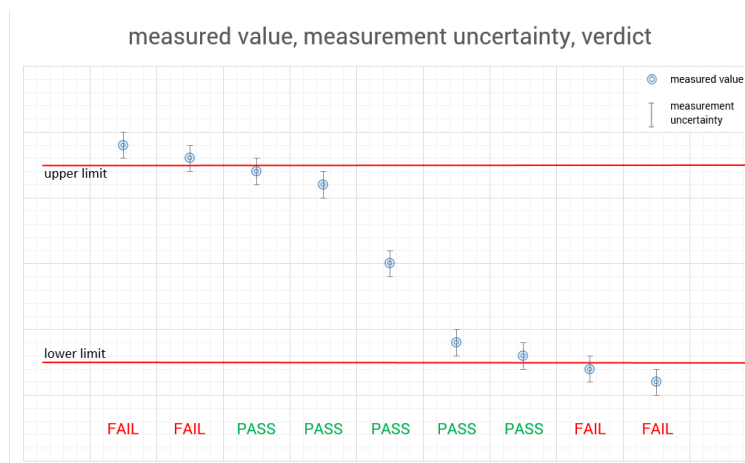

5 Test environment

Temperature	:	T_{nom} T_{max} T_{min}	+22 °C during room temperature tests No testing under extreme temperature conditions required. No testing under extreme temperature conditions required.
Relative humidity content	:		55 %
Barometric pressure	:		1021 hpa
Power supply	:	V_{nom} V_{max} V_{min}	12.0 V DC by external power supply No testing under extreme voltage conditions required. No testing under extreme voltage conditions required.

6 Test item

6.1 General description

Kind of test item	:	Telematics Control Unit Generation 2
Model name	:	TCU2 NA IP30
HMN	:	N/A
PMN	:	TCU2 NA IP30
HVIN	:	TCU2 NA IP30
FVIN	:	N/A
S/N serial number	:	2750003683
Hardware status	:	4186H06
Software status	:	23.04.S.010.4
Frequency band	:	5150 MHz to 5350 MHz & 5470 MHz to 5825 MHz
Type of radio transmission	:	OFDM
Use of frequency spectrum	:	
Type of modulation	:	(D)BPSK, (D)QPSK, 16 – QAM, 64 – QAM
Number of channels	:	24 (20 MHz), 11 (40 MHz), 5 (80 MHz)
Antenna	:	Two Integrated antennas with MIMO capability
Power supply	:	12 V DC by external power supply
Temperature range	:	-40°C to +65°C

6.2 Additional information

The content of the following annexes is defined in the QA. It may be that not all of the listed annexes are necessary for this report, thus some values in between may be missing.

Test setup and EUT photos are included in test report: 1-6579_23-01-08_AnnexA

7 Measurement uncertainty

Measurement uncertainty	
Test case	Uncertainty
Frequency accuracy (radar burst)	0.2 Hz
Level accuracy (radar burst)	± 1.83 dB

8 Summary of measurement results

<input checked="" type="checkbox"/>	No deviations from the technical specifications were ascertained
<input type="checkbox"/>	There were deviations from the technical specifications ascertained
<input checked="" type="checkbox"/>	This test report is only a partial test report. The content and verdict of the performed test cases are listed below.

TC Identifier	Description	Verdict	Date	Remark
DFS-Testing	CFR Part 15, FCC 06-96 RSS-247, Issue 3	Pass	2024-04-30	DFS only

Test Standard Clause	Test Case	Bandwidth	C	NC	NA	NP	Remark
7.8.1* ³	U-NII Detection Bandwidth	-/-	<input type="checkbox"/>	<input type="checkbox"/>	<input checked="" type="checkbox"/>	<input type="checkbox"/>	*1*2*3
§15.407 (h)(2)	DFS Detection Threshold	-/-	<input type="checkbox"/>	<input type="checkbox"/>	<input checked="" type="checkbox"/>	<input type="checkbox"/>	*1*2*3
§15.407 (h)(2) (ii) & 7.8.2* ³	Channel Availability Check Time	-/-	<input type="checkbox"/>	<input type="checkbox"/>	<input checked="" type="checkbox"/>	<input type="checkbox"/>	*1*3
§15.407 (h)(2) (iv) & 7.8.3* ³	Non-Occupancy Period	80 MHz	<input checked="" type="checkbox"/>	<input type="checkbox"/>	<input type="checkbox"/>	<input type="checkbox"/>	*2
§15.407 (h)(2) (iii) & 7.8.2* ³	Channel Move Time / Channel Closing Transmission Time	80 MHz	<input checked="" type="checkbox"/>	<input type="checkbox"/>	<input type="checkbox"/>	<input type="checkbox"/>	*2
7.8.3 & 7.8.4* ³	In-Service Monitoring / Statistical Performance Check	-/-	<input type="checkbox"/>	<input type="checkbox"/>	<input checked="" type="checkbox"/>	<input type="checkbox"/>	*2*3

Abbreviations/References:

- C Compliant
- NC Not compliant
- NA Not applicable
- NP Not performed
- *1 Prior to use of a channel
- *2 During normal operation
- *3 Not applicable for Client Devices without radar detection.

9 Additional comments

Reference documents: None

Special test descriptions: All tests except the In-Service Monitoring are conducted with Pulse Type 0.
A sample with temporary antenna connector was provided to perform the measurements in a conducted way.

Configuration descriptions: Iperf was used to generate the required channel load (duty cycle greater 17 percent).

DFS functionality: Master device
 Client with radar detection
 Client without radar detection

EUT selection: Only one device available
 Devices selected by the customer
 Devices selected by the laboratory (Randomly)

10 RF measurements

10.1 Description of test setup

10.1.1 Conducted measurements

Setup

Figure 1 shows a setup whereby the UUT is a RLAN device operating in slave mode, without Radar Interference Detection function. This setup also contains a RLAN device operating in master mode. The radar test signals are injected into the master device. The UUT (slave device) is associated with the master device.

Figure 1 shows an example

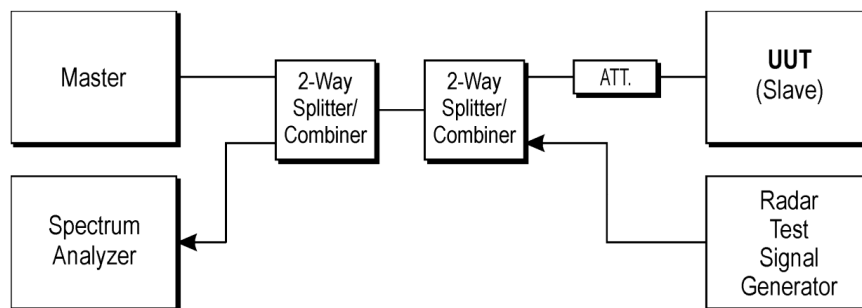

Figure 1: Setup

RPP = SG - CA

(RPP-radar pulse power; SG-signal generator power; CA-loss signal path)

Example calculation:

$$RPP [dBm] = -30.0 [dBm] - 33.0 [dB] = -63.0 [dBm]$$

Equipment table:

No.	Lab / Item	Equipment	Type	Manufacturer	Serial No.	INV. No Cetecom	Kind of Calibration	Last Calibration	Next Calibration
1	A	Vector Signal Generator	SMU200A	R&S	101633	300003496	vIKI!	04.01.2022	31.01.2025
2	A	Spectrum Analyzer 9kHz to 30GHz - 140..+30dBm	FSP30	R&S	100886	300003575	vIKI!	07.12.2022	31.12.2024
3	A	DFS-test site	div. Splitter, Cables, Attenuators	Mini-Circuits	na	300004557	ev	-/-	-/-
4	A	Notebook	Latitude 15 6000 Series	Dell		300004737	ne	-/-	-/-
5	A	Dual Band Gigabit Router	RT-AC68U	Asus	F11MOH056666	400001244	ne	-/-	-/-
6	A	PC	ExOne	F+W	2890296v001	300005102	ne	-/-	-/-
7	A	RF-Cable DFS-Tester Receiver	ST18/SMAM/SMAM /24	Huber & Suhner	Batch no. 1308650	400001252	ev	-/-	-/-
8	A	RF-Cable DFS-Tester SMU	1520.9927.00			400001253	ev	-/-	-/-
9	A	RF-Cable DFS-Tester No. 1	Enviroflex 316 D	Huber & Suhner	Batch no. 1560522	400001257	ev	-/-	-/-

10	A	RF-Cable DFS-Tester No. 2	Enviroflex 316 D	Huber & Suhner	Batch no. 1560522	400001258	ev	-/-	-/-
11	A	RF-Cable DFS-Tester No. 3	Enviroflex 316 D	Huber & Suhner	Batch no. 1560522	400001259	ev	-/-	-/-
12	A	RF-Cable DFS-Tester No. 5	Enviroflex 316 D	Huber & Suhner	Batch no. 1560522	400001261	ev	-/-	-/-
13	A	RF-Cable DFS-Tester No. 6	Enviroflex 316 D	Huber & Suhner	Batch no. 1560522	400001262	ev	-/-	-/-
14	A	DC Power Supply	HMP2020	Rohde & Schwarz	101073	300005264	k	05.12.2022	31.12.2024

* FCC ID: MSQ-RTAC68U

10.2 Parameters of DFS test signals

10.2.1 DFS Detection Thresholds for Master Devices as well as Client Devices With Radar Detection

Maximum Transmit Power EIRP	Value (see note)
≥ 200 mW	-64 dBm
< 200 mW and power spectral density < 10 dBm/MHz	-62 dBm
< 200 mW and That do not meet the power spectral density < 10 dBm/MHz	-64 dBm

Note 1: This is the level at the input of the receiver assuming a 0 dBi receive antenna.
 Note 2: Throughout these test procedures an additional 1 dB has been added to the amplitude of the test transmission waveforms to account for variations in measurement equipment. This will ensure that the test signal is at or above the detection threshold level to trigger a DFS response.
 Note3: EIRP is based on the highest antenna gain. For MIMO devices refer to KDB Publication 662911 D01.

10.2.2 DFS Response Requirement Values

Parameter	Value
Non-occupancy period	minimum 30 minutes
Channel Availability Check Time	60 seconds
Channel Move Time	10 seconds See Note 1.
Channel Closing Transmission Time	200 milliseconds + an aggregate of 60 milliseconds over remaining 10 second period. See Notes 1 and 2.
U-NII Detection Bandwidth	Minimum 100% of the U-NII 99% transmission power bandwidth. See Note 3.

Note 1: Channel Move Time and the Channel Closing Transmission Time should be performed with Radar Type 0. The measurement timing begins at the end of the Radar Type 0 burst.
 Note 2: The Channel Closing Transmission Time is comprised of 200 milliseconds starting at the beginning of the Channel Move Time plus any additional intermittent control signals required to facilitate a Channel move (an aggregate of 60 milliseconds) during the remainder of the 10 second period. The aggregate duration of control signals will not count quiet periods in between transmissions.
 Note 3: During the U-NII Detection Bandwidth detection test, radar type 0 should be used. For each frequency step the minimum percentage of detection is 90 percent. Measurements are performed with no data traffic.

10.2.3 Radar Test Waveforms

This section provides the parameters for required test waveforms, minimum percentage of successful detections, and the minimum number of trials that must be used for determining DFS conformance.

Short Pulse Radar Test Waveforms

Radar Type	Pulse Width (µsec)	PRI (µsec)	Number of Pulses	Minimum Percentage of Successful Detection	Minimum Number of Trials
0	1	1428	18	See Note 1	See Note 1
1	1	Test A: 15 unique PRI values randomly selected from the list of 23 PRI values in Table 5a	Roundup $\left\{ \left(\frac{1}{360} \right) \cdot \left(\frac{19 \cdot 10^6}{PRI_{\mu sec}} \right) \right\}$	60%	30
		Test B: 15 unique PRI values randomly selected within the range of 518-3066 µsec, with a minimum increment of 1 µsec, excluding PRI values selected in Test A			
2	1-5	150-230	23-29	60%	30
3	6-10	200-500	16-18	60%	30
4	11-20	200-500	12-16	60%	30
Aggregate (Radar Types 1-4)				80%	120
Note 1: Short Pulse Radar Type 0 should be used for the detection bandwidth test, channel move time, and channel closing time tests.					

A minimum of 30 unique waveforms are required for each of the Short Pulse Radar Types 2 through 4.

Pulse Repetition Intervals Values for Test A

Pulse Repetition Frequency Number	Pulse Repetition Frequency (Pulses Per Second)	Pulse Repetition Interval (Microseconds)
1	1930.5	518
2	1858.7	538
3	1792.1	558
4	1730.1	578
5	1672.2	598
6	1618.1	618
7	1567.4	638
8	1519.8	658
9	1474.9	678
10	1432.7	698
11	1392.8	718
12	1355	738
13	1319.3	758
14	1285.3	778
15	1253.1	798
16	1222.5	818
17	1193.3	838
18	1165.6	858
19	1139	878
20	1113.6	898
21	1089.3	918
22	1066.1	938
23	326.2	3066

Long Pulse Radar Test Waveform

Radar Type	Pulse Width (µsec)	Chirp Width (MHz)	PRI (µsec)	Number of Pulses per Burst	Number of Bursts	Minimum Percentage of Successful Detection	Minimum Number of Trials
5	50-100	5-20	1000-2000	1-3	8-20	80%	30

The parameters for this waveform are randomly chosen. Thirty unique waveforms are required for the Long Pulse Radar Type waveforms.

Frequency Hopping Radar Test Waveform

Radar Type	Pulse Width (µsec)	Chirp Width (MHz)	Pulses per Hop	Hopping Rate (kHz)	Hopping Sequence Length (msec)	Minimum Percentage of Successful Detection	Minimum Number of Trials
6	1	333	9	0.333	300	70%	30

For the Frequency Hopping Radar Type, the same Burst parameters are used for each waveform. The hopping sequence is different for each waveform and a 100-length segment is selected from the hopping sequence defined.

The first frequency in a hopping sequence is selected randomly from the group of 475 integer frequencies from 5250 – 5724 MHz. Next, the frequency that was just chosen is removed from the group and a frequency is randomly selected from the remaining 474 frequencies in the group. This process continues until all 475 frequencies are chosen for the set.

10.3 Test preparation

10.3.1 Channel loading

Timing plots are required with calculations demonstrating a minimum channel loading of approximately 17% or greater. For example, channel loading can be estimated by setting the spectrum analyzer for zero span and approximate the Time On/ (Time On + Off Time). This can be done with any appropriate channel BW and modulation type.

HT80-Mode: Calculated duty cycle = 18%

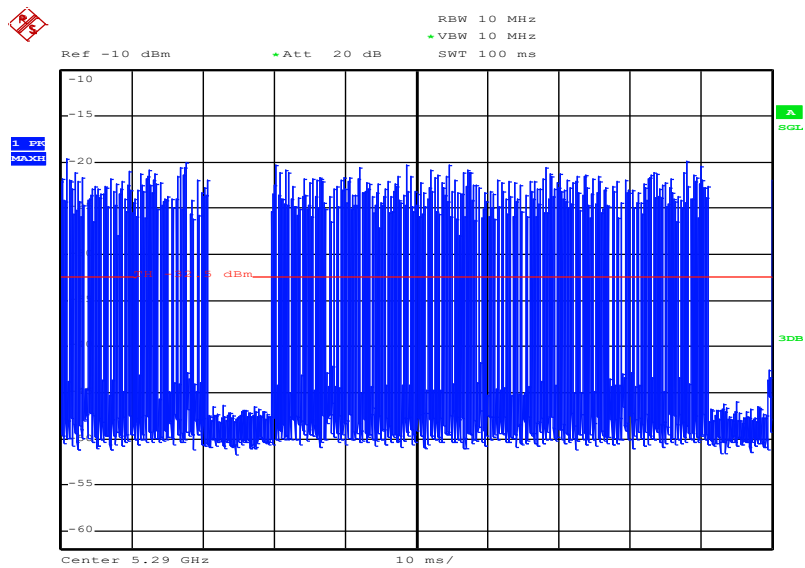

Date: 24.APR.2024 14:22:03

Plot 1

10.3.299% Bandwidth to determine the U-NII-bandwidth

VHT80-Mode: 76,48 MHz

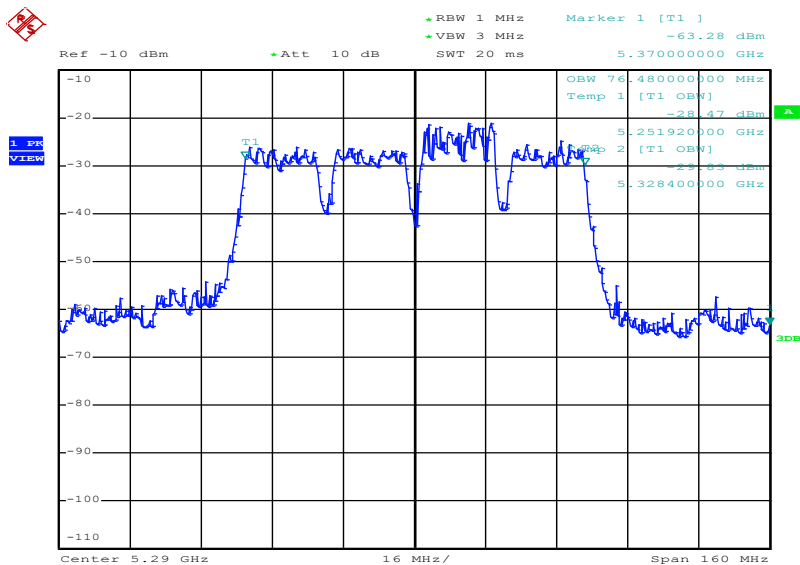

Date: 24.APR.2024 14:22:39

Plot 2

10.3.3 Radar burst timing signal

To accurately determine the channel closing time and channel closing transmission time the spectrum analyser is triggered at the end of the radar burst (see marker at $t = 0$ ms).

Example plot

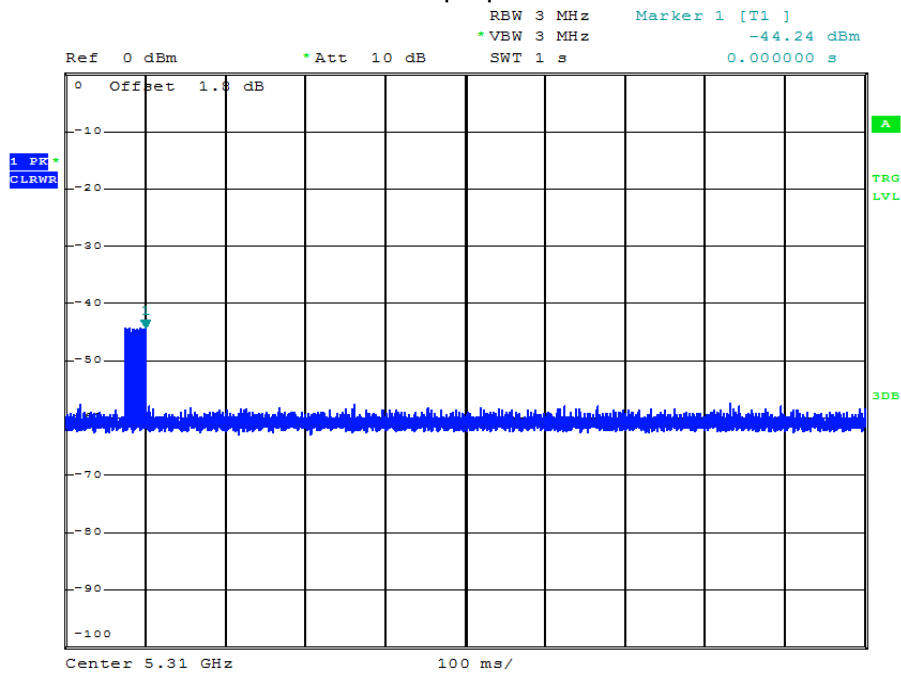

Plot 3

10.4 Test results (prior to use of a channel)

Not applicable.

10.5 Test results (during normal operation)

10.5.1 Channel move time / channel closing transmission time

After a radar's presence is detected, all transmissions shall cease on the operating channel within 10 seconds. Transmissions during this period shall consist of normal traffic for a maximum of 200 ms after detection of the radar signal. In addition, intermittent management and control signals can be sent during the remaining time to facilitate vacating the operating channel not exceeding 60ms.

The test is performed during normal operation with the highest bandwidth supported by the DUT.

Channel Closing Time

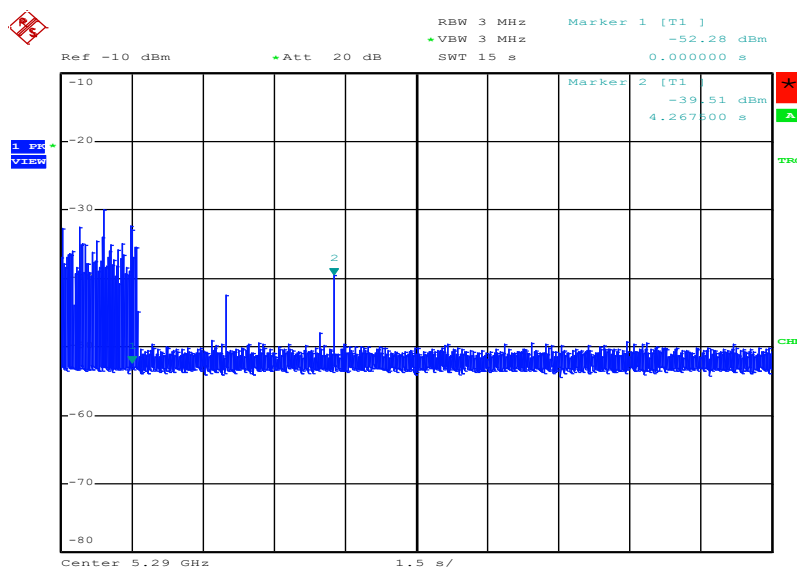

Date: 24.APR.2024 15:48:52

Plot 4

Note: With Marker 1 at the end of the radar pulse ($t = 0\text{ms}$) the Channel Closing Time is determined by Setting a Delta-Marker to the point where the last transmission occurred.
The Channel Closing Time is 4.26s.

Channel Closing Transmission Time

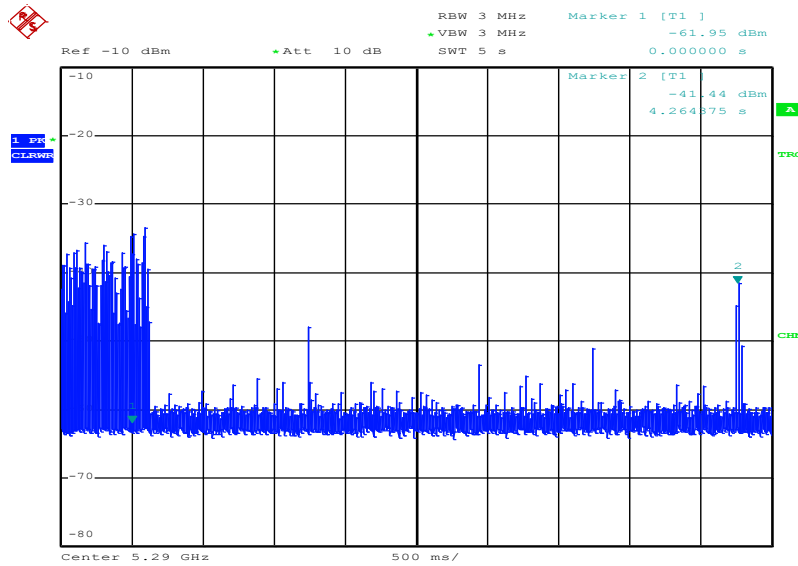

Date: 24.APR.2024 16:08:46

Note: The accumulated transmission time is calculated by the number of bins occurring after t = 0ms multiplied with the Time-per-sweep point-factor resulting from the Sweep Time and number of Sweep Points of the Spectrum Analyser.
 The Channel Closing Transmission Time is 1.9ms.

10.5.2 Non-Occupancy Period

A channel that has been flagged as containing a radar system, either by a channel availability check or in-service monitoring, is subject to a non-occupancy period of at least 30 minutes. The non occupancy period starts at the time when the radar system is detected.

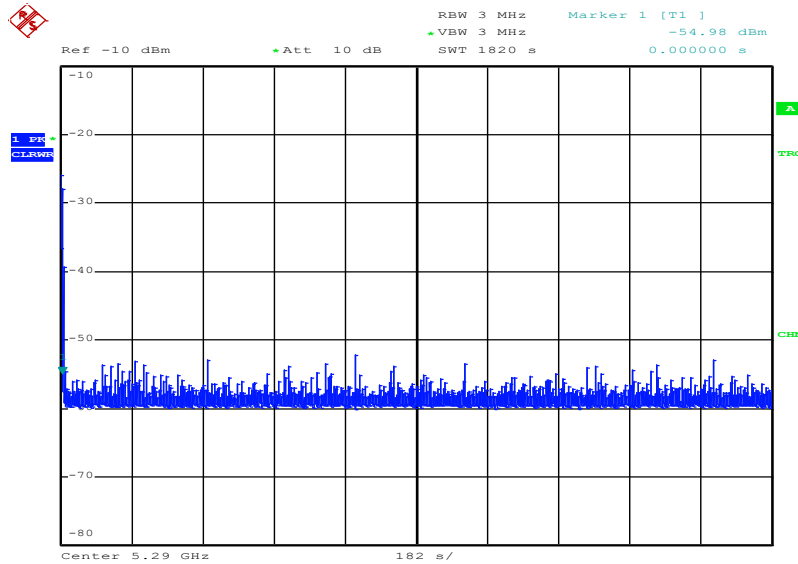

Date: 24.APR.2024 14:54:37

Plot 5

11 Observations

No observations except those reported with the single test cases have been made.

12 Glossary

AVG	Average
C	Compliant
CAC	Channel availability check
CW	Clean wave
DC	Duty cycle
DFS	Dynamic frequency selection
DSSS	Dynamic sequence spread spectrum
DUT	Device under test
EN	European Standard
EMC	Electromagnetic Compatibility
EUT	Equipment under test
FCC	Federal Communications Commission
FCC ID	Company Identifier at FCC
FHSS	Frequency hopping spread spectrum
FVIN	Firmware version identification number
HMN	Host marketing name
HVIN	Hardware version identification number
HW	Hardware
IC	Industry Canada
Inv. No.	Inventory number
MC	Modulated carrier
NA	Not applicable
NC	Not compliant
NOP	Non occupancy period
NP	Not performed
OBW	Occupied bandwidth
OC	Operating channel
OCW	Operating channel bandwidth
OFDM	Orthogonal frequency division multiplexing
OOB	Out of band
OP	Occupancy period
PER	Packet error rate
PMN	Product marketing name
PP	Positive peak
QP	Quasi peak
S/N or SN	Serial number
SW	Software
UUT	Unit under test
WLAN	Wireless local area network

13 Document history

Version	Applied changes	Date of release
-/-	Initial release	2024-04-30

END OF TEST REPORT