



TEST REPORT

BNetzA-CAB-02/21-102

Test report no.: 1-6579_23-01-08

Testing laboratory

cetecom advanced GmbH
Untertuerkheimer Strasse 6 – 10
66117 Saarbruecken / Germany
Phone: + 49 681 5 98 - 0
Fax: + 49 681 5 98 - 9075
Internet: <https://cetecomadvanced.com>
e-mail: mail@cetecomadvanced.com

Accredited Testing Laboratory:

The testing laboratory (area of testing) is accredited according to DIN EN ISO/IEC 17025 (2018-03) by the Deutsche Akkreditierungsstelle GmbH (DAkkS).

The accreditation is valid for the scope of testing procedures as stated in the accreditation certificate with the registration number: D-PL-12047-01-00.

ISED Testing Laboratory Recognized Listing Number: DE0001
FCC designation number: DE0002

Applicant

Robert Bosch GmbH
Robert-Bosch-Straße 200
31139 Hildesheim / GERMANY
Phone: -/-
Contact: Thomas Dargel
e-mail: Thomas.Dargel@de.bosch.com

Manufacturer

Robert Bosch GmbH
Robert-Bosch-Straße 200
31139 Hildesheim / GERMANY

Test standard/s

FCC - Title 47 CFR Part 15 FCC - Title 47 of the Code of Federal Regulations; Chapter I; Part 15 - Radio frequency devices

RSS - 247 Issue 3 Digital Transmission Systems (DTSS), Frequency Hopping Systems (FHSs) and Licence - Exempt Local Area Network (LE-LAN) Devices

For further applied test standards please refer to section 3 of this test report.

Test Item

Kind of test item: **Telematics Control Unit Generation 2**

Model name: **TCU2 NA IP30**

FCC ID: **2AUXS-TCU2NAIP30**

ISED certification number: **25847-TCU2NAIP30**

Frequency: 5150 – 5250 MHz, 5725 – 5825 MHz

Technology tested: WLAN

Antenna: Two Integrated antennas with MIMO capability

Power supply: 12.0 V DC by vehicle battery

Temperature range: -40°C to +65°C

This test report is electronically signed and valid without handwritten signature. For verification of the electronic signatures, the public keys can be requested at the testing laboratory.

Test report authorized:

Marco Bertolino
Supervisor Radio Services
Radio Labs

Test performed:

Michael Dorongovski
Lab Manager
Radio Labs

1 Table of contents

1	Table of contents.....	2
2	General information.....	4
2.1	Notes and disclaimer	4
2.2	Application details	4
2.3	Test laboratories sub-contracted	4
3	Test standard/s, references and accreditations	5
4	Reporting statements of conformity – decision rule	6
5	Test environment.....	7
6	Test item	7
6.1	General description	7
6.2	Additional information	7
7	Description of the test setup.....	8
7.1	Shielded semi anechoic chamber	9
7.2	Shielded fully anechoic chamber.....	10
7.3	Radiated measurements > 18 GHz	12
7.4	Conducted measurements system	13
8	Sequence of testing.....	14
8.1	Sequence of testing radiated spurious 9 kHz to 30 MHz	14
8.2	Sequence of testing radiated spurious 30 MHz to 1 GHz.....	15
8.3	Sequence of testing radiated spurious 1 GHz to 18 GHz.....	16
8.4	Sequence of testing radiated spurious above 18 GHz.....	17
9	Measurement uncertainty.....	18
10	Summary of measurement results	19
11	Additional comments.....	20
12	Measurement results.....	23
12.1	Identify worst case data rate.....	23
12.2	Antenna gain	24
12.3	Duty cycle.....	25
12.4	Maximum output power.....	26
12.4.1	Maximum output power according to FCC requirements.....	26
12.4.2	Maximum output power according to ISED requirements.....	31
12.5	Power spectral density	38
12.5.1	Power spectral density according to FCC requirements.....	38
12.5.2	Power spectral density according to ISED requirements	42
12.6	Minimum emission bandwidth for the band 5.725-5.85 GHz.....	48
12.7	Spectrum bandwidth / 26 dB / 20 dB bandwidth	50
12.8	Occupied bandwidth / 99% emission bandwidth	53
12.9	Undesirable emissions for transmitters operating in the 5725 MHz to 5850 MHz band (conducted)	56
12.10	Band edge compliance radiated	57
12.11	Spurious emissions radiated below 30 MHz	60

12.12	Spurious emissions radiated 30 MHz to 1 GHz	67
12.13	Spurious emissions radiated 1 GHz to 40 GHz	70
13	Glossary	80
14	Document history	81

2 General information

2.1 Notes and disclaimer

The test results of this test report relate exclusively to the test item specified in this test report. cetecom advanced GmbH does not assume responsibility for any conclusions and generalizations drawn from the test results with regard to other specimens or samples of the type of the equipment represented by the test item.

The test report may only be reproduced or published in full. Reproduction or publication of extracts from the report requires the prior written approval of cetecom advanced GmbH.

The testing service provided by cetecom advanced GmbH has been rendered under the current "General Terms and Conditions for cetecom advanced GmbH".

cetecom advanced GmbH will not be liable for any loss or damage resulting from false, inaccurate, inappropriate or incomplete product information provided by the customer.

Under no circumstances does the cetecom advanced GmbH test report include any endorsement or warranty regarding the functionality, quality or performance of any other product or service provided.

Under no circumstances does the cetecom advanced GmbH test report include or imply any product or service warranties from cetecom advanced GmbH, including, without limitation, any implied warranties of merchantability, fitness for purpose, or non-infringement, all of which are expressly disclaimed by cetecom advanced GmbH.

All rights and remedies regarding vendor's products and services for which cetecom advanced GmbH has prepared this test report shall be provided by the party offering such products or services and not by cetecom advanced GmbH.

In no case this test report can be considered as a Letter of Approval.

This test report is electronically signed and valid without handwritten signature. For verification of the electronic signatures, the public keys can be requested at the testing laboratory.

2.2 Application details

Date of receipt of order:	2023-07-30
Date of receipt of test item:	2023-08-07
Start of test:*	2023-08-07
End of test:*	2023-11-08
Person(s) present during the test:	-/-

*Date of each measurement, if not shown in the plot, can be requested. Dates are stored in the measurement software.

2.3 Test laboratories sub-contracted

None

3 Test standard/s, references and accreditations

Test standard	Date	Description
FCC - Title 47 CFR Part 15	-/-	FCC - Title 47 of the Code of Federal Regulations; Chapter I; Part 15 - Radio frequency devices
RSS - 247 Issue 3	August 2023	Digital Transmission Systems (DTSS), Frequency Hopping Systems (FHSs) and Licence - Exempt Local Area Network (LE-LAN) Devices
RSS - Gen Issue 5 incl. Amendment 1 & 2	February 2021	Spectrum Management and Telecommunications Radio Standards Specification - General Requirements for Compliance of Radio Apparatus
Guidance	Version	Description
KDB 789033 D02	v02r01	Guidelines for Compliance Testing of Unlicensed National Information Infrastructure (U-NII) Devices - Part 15, Subpart E
ANSI C63.4-2014	-/-	American National Standard for Methods of Measurement of Radio-Noise Emissions from Low-Voltage Electrical and Electronic Equipment in the Range of 9 kHz to 40 GHz
ANSI C63.10-2013	-/-	American National Standard of Procedures for Compliance Testing of Unlicensed Wireless Devices

4 Reporting statements of conformity – decision rule

Only the measured values related to their corresponding limits will be used to decide whether the equipment under test meets the requirements of the test standards listed in chapter 3. The measurement uncertainty is mentioned in this test report, see chapter 9, but is not taken into account - neither to the limits nor to the measurement results. Measurement results with a smaller margin to the corresponding limits than the measurement uncertainty have a potential risk of more than 5% that the decision might be wrong."

measured value, measurement uncertainty, verdict

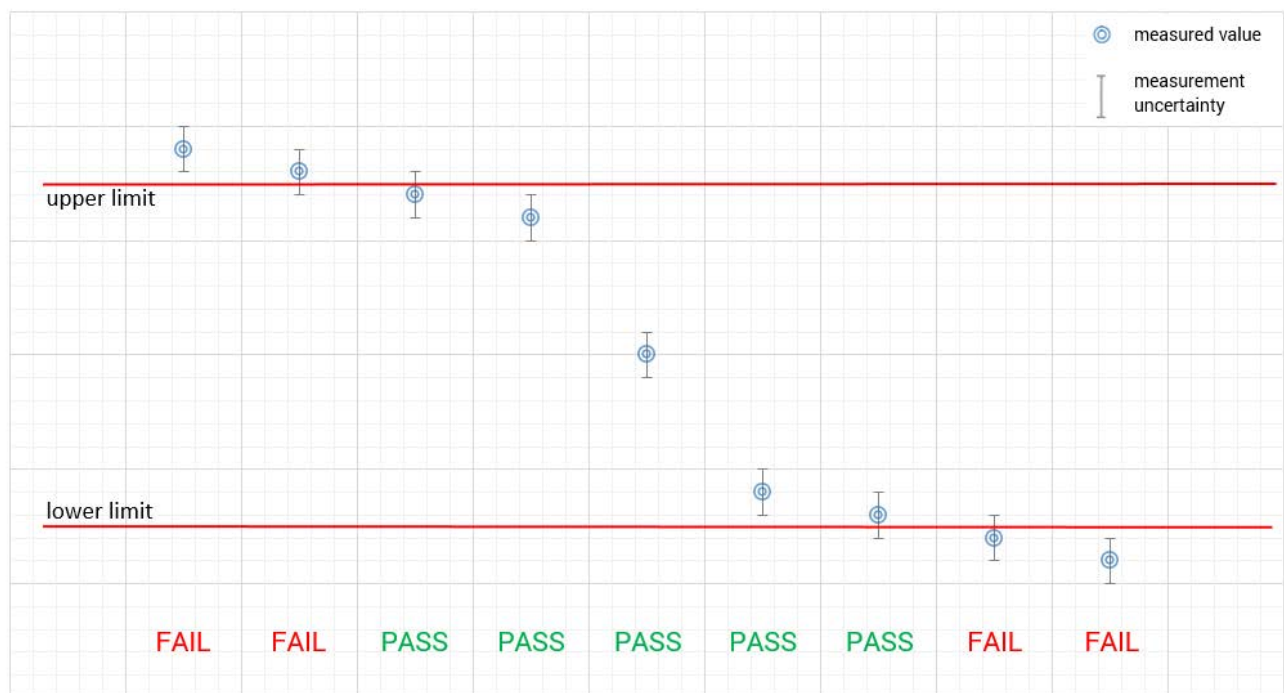

5 Test environment

Temperature	:	T _{nom}	+22 °C during room temperature tests
		T _{max}	No tests under extreme environmental conditions required.
		T _{min}	No tests under extreme environmental conditions required.
Relative humidity content	:		45 %
Barometric pressure	:		1021 hpa
Power supply	:	V _{nom}	12.0 V DC by external power supply
		V _{max}	No tests under extreme environmental conditions required.
		V _{min}	No tests under extreme environmental conditions required.

6 Test item

6.1 General description

Kind of test item	:	Telematics Control Unit Generation 2	
Model name	:	TCU2 NA IP30	
HMN	:	N/A	
PMN	:	TCU2 NA IP30	
HVIN	:	TCU2 NA IP30	
FVIN	:	N/A	
S/N serial number	:	Rad.	2750003443
		Cond.	2750003443
Hardware status	:	4186H06	
Software status	:	23.04.S.010.4	
Firmware status	:	N/A	
Frequency band	:	5150 – 5250 MHz, 5725 – 5825 MHz	
Type of radio transmission	:	OFDM	
Use of frequency spectrum	:		
Type of modulation	:	(D)BPSK, (D)QPSK, 16 – QAM, 64 – QAM	
Number of channels	:	9 (20 MHz); 4 (40 MHz); 2 (80 MHz)	
Antenna	:	Two Integrated antennas with MIMO capability	
Power supply	:	12.0 V DC by vehicle battery	
Temperature range	:	-40°C to +65°C	

6.2 Additional information

The content of the following annexes is defined in the QA. It may be that not all of the listed annexes are necessary for this report, thus some values in between may be missing.

Test setup and EUT photos are included in test report: 1-6579_23-01-08_AnnexA
1-6579_23-01-08_AnnexD

7 Description of the test setup

Typically, the calibrations of the test apparatus are commissioned to and performed by an accredited calibration laboratory. The calibration intervals are determined in accordance with the DIN EN ISO/IEC 17025. In addition to the external calibrations, the laboratory executes comparison measurements with other calibrated test systems or effective verifications. Weekly chamber inspections and range calibrations are performed. Where possible, RF generating and signaling equipment as well as measuring receivers and analyzers are connected to an external high-precision 10 MHz reference (GPS-based or rubidium frequency standard).

In order to simplify the identification of the equipment used at some special tests, some items of test equipment and ancillaries can be provided with an identifier or number in the equipment list below (Lab/Item).

Each block diagram listed can contain several test setup configurations. All devices belonging to a test setup are identified with the same letter syntax. For example: Column Setup and all devices with an A.

Agenda: Kind of Calibration

k	calibration / calibrated	EK	limited calibration
ne	not required (k, ev, izw, zw not required)	zw	cyclical maintenance (external cyclical maintenance)
ev	periodic self verification	izw	internal cyclical maintenance
Ve	long-term stability recognized	g	blocked for accredited testing
vlk!	Attention: extended calibration interval		
NK!	Attention: not calibrated	*)	next calibration ordered / currently in progress

7.1 Shielded semi anechoic chamber

The radiated measurements are performed in vertical and horizontal plane in the frequency range from 30 MHz to 1 GHz in semi-anechoic chambers. The EUT is positioned on a non-conductive support with a height of 0.80 m above a conductive ground plane that covers the whole chamber. The receiving antennas are conform to specifications ANSI C63. These antennas can be moved over the height range between 1.0 m and 4.0 m in order to search for maximum field strength emitted from EUT. The measurement distances between EUT and receiving antennas are indicated in the test setups for the various frequency ranges. For each measurement, the EUT is rotated in all three axes until the maximum field strength is received. The wanted and unwanted emissions are received by spectrum analyzers where the detector modes and resolution bandwidths over various frequency ranges are set according to requirement ANSI C63.

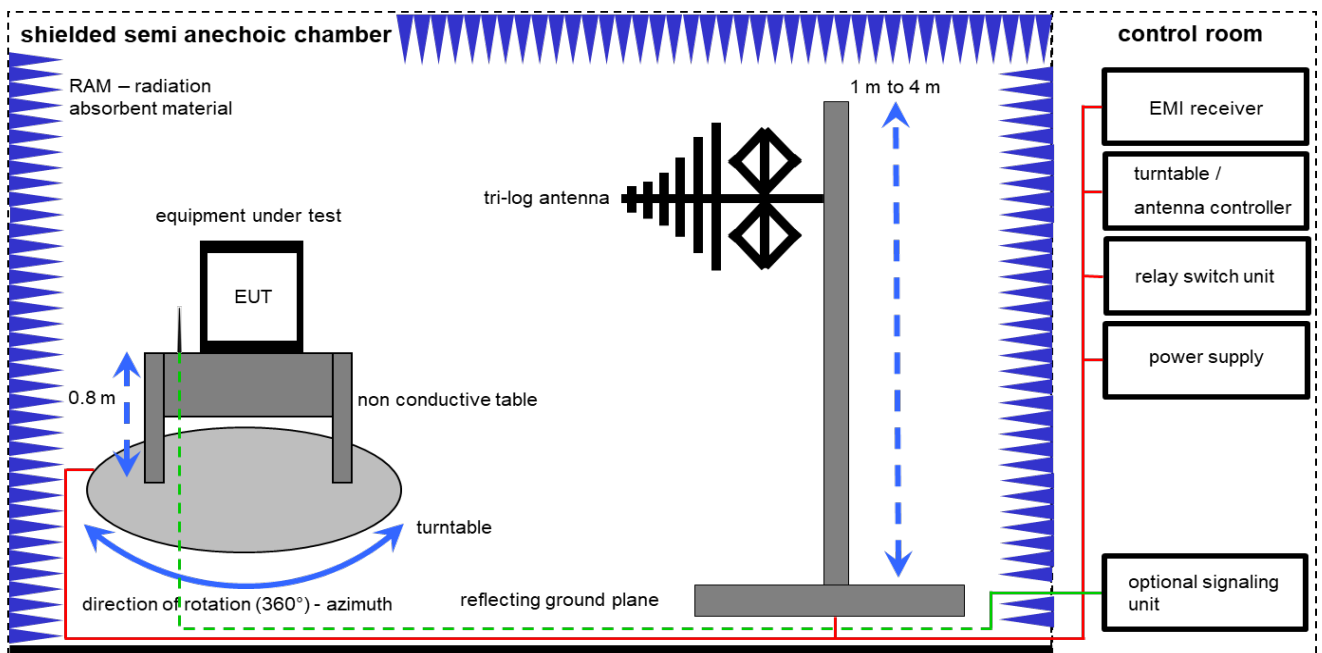

Measurement distance: tri-log antenna 10 meter; EMC32 software version: 10.59.00

$$FS = UR + CL + AF$$

(FS-field strength; UR-voltage at the receiver; CL-loss of the cable; AF-antenna factor)

Example calculation:

$$FS \text{ [dB}\mu\text{V/m]} = 12.35 \text{ [dB}\mu\text{V/m]} + 1.90 \text{ [dB]} + 16.80 \text{ [dB/m]} = 31.05 \text{ [dB}\mu\text{V/m]} \text{ (35.69 } \mu\text{V/m)}$$

Equipment table:

No.	Setup	Equipment	Type	Manufacturer	Serial No.	INV. No.	Kind of Calibration	Last Calibration	Next Calibration
1	A	Switch-Unit	3488A	HP	2719A14505	300000368	ev	-/-	-/-
2	A	Semi anechoic chamber	3000023	MWB AG	-/-	300000551	ne	-/-	-/-
3	A	Antenna Tower	Model 2175	ETS-Lindgren	64762	300003745	izw	-/-	-/-
4	A	Positioning Controller	Model 2090	ETS-Lindgren	64672	300003746	izw	-/-	-/-
5	A	Turntable Interface-Box	Model 105637	ETS-Lindgren	44583	300003747	izw	-/-	-/-
6	A	TRILOG Broadband Test-Antenna 30 MHz - 3 GHz	VULB9163	Schwarzbeck Mess-Elektronik	216	300003288	vKI!	31.08.2023	31.08.2025
7	A	Turntable	2089-4.0	EMCO	-/-	300004394	ne	-/-	-/-
8	A	PC	Tecline	F+W	-/-	300004388	ne	-/-	-/-
9	A	EMI Test Receiver	ESR3	Rohde & Schwarz	102587	300005771	k	09.12.2022	31.12.2023

7.2 Shielded fully anechoic chamber

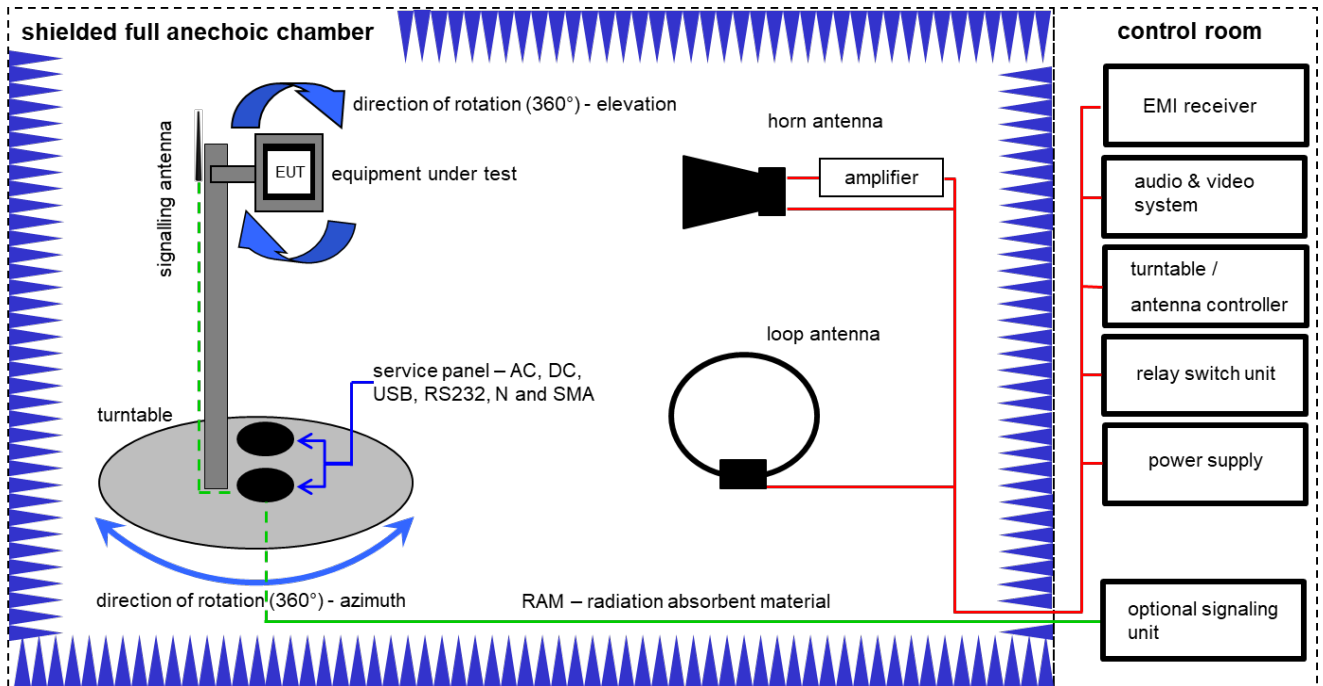

Measurement distance: horn antenna 3 meter; loop antenna 3 meter / 1 meter

$$FS = UR + CA + AF$$

(FS-field strength; UR-voltage at the receiver; CA-loss of the signal path; AF-antenna factor)

Example calculation:

$$FS \text{ [dB}\mu\text{V/m]} = 40.0 \text{ [dB}\mu\text{V/m]} + (-35.8) \text{ [dB]} + 32.9 \text{ [dB/m]} = 37.1 \text{ [dB}\mu\text{V/m]} \text{ (71.61 } \mu\text{V/m)}$$

Equipment table:

No.	Setup	Equipment	Type	Manufacturer	Serial No.	INV. No.	Kind of Calibration	Last Calibration	Next Calibration
1	A, B	Double-Ridged Waveguide Horn Antenna 1-18.0GHz	3115	EMCO	8812-3089	300000307	vK!	11.02.2022	29.02.2024
2	C	Active Loop Antenna 9 kHz to 30 MHz	6502	EMCO	2210	300001015	vK!	02.08.2023	31.08.2025
3	B	Highpass Filter	WHKX7.0/18G-8SS	Wainwright	18	300003789	ne	-/-	-/-
4	A, B, C	Broadband Amplifier 0.5-18 GHz	CBLU5184540	CERNEX	22051	300004483	ev	-/-	-/-
5	A, B, C	4U RF Switch Platform	L4491A	Agilent Technologies	MY50000032	300004510	ne	-/-	-/-
6	A, B, C	Computer	Intel Core i3 3220/3,3 GHz, Prozessor	-/-	2V2403033A54 21	300004591	ne	-/-	-/-
7	A, B, C	NEXIO EMV-Software	BAT EMC V2022.0.22.0	Nexio	-/-	300004682	ne	-/-	-/-
8	A, B, C	Anechoic chamber	-/-	TDK	-/-	300003726	ne	-/-	-/-
9	A, B, C	EMI Test Receiver 9kHz-26,5GHz	ESR26	Rohde & Schwarz	101376	300005063	k	13.12.2022	31.12.2023
10	B	RF-Amplifier	AMF-6F06001800-30-10P-R	NARDA-MITEQ Inc	2011571	300005240	ev	-/-	-/-
11	B	Band Reject Filter	WRCJV12-5120-5150-5350-5380-40SS	Wainwright Instruments GmbH	8	300005331	ev	-/-	-/-

12	B	Band Reject Filter	WRCJV12-5695-5725-5850-5880-40SS	Wainwright Instruments GmbH	10	300005332	ev	-/-	-/-
13	B	Band Reject Filter	WRCJV12-5440-5470-5725-5755-40SS	Wainwright Instruments GmbH	13	300005333	ev	-/-	-/-

7.3 Radiated measurements > 18 GHz

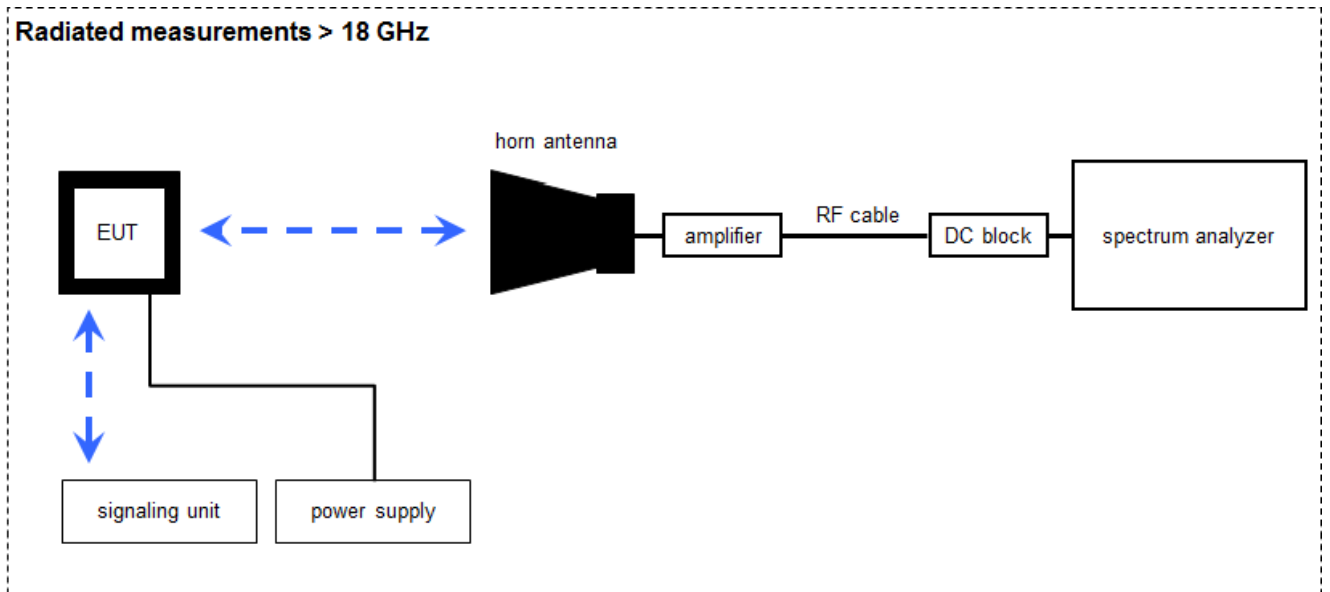

Measurement distance: horn antenna 50 cm

$$FS = UR + CA + AF$$

(FS-field strength; UR-voltage at the receiver; CA-loss signal path & distance correction; AF-antenna factor)

Example calculation:

$$FS [dB\mu V/m] = 40.0 [dB\mu V/m] + (-60.1) [dB] + 36.74 [dB/m] = 16.64 [dB\mu V/m] (6.79 \mu V/m)$$

Equipment table:

No.	Setup	Equipment	Type	Manufacturer	Serial No.	INV. No.	Kind of Calibration	Last Calibration	Next Calibration
1	A	Std. Gain Horn Antenna 18.0-26.5 GHz	638	Narda	8205	300002442	k	17.01.2022	31.01.2024
2	A	Signal analyzer	FSV40	Rohde&Schwarz	101042	300004517	k	12.12.2022	31.12.2023
3	A	RF-Cable	ST18/SMAm/SMAm /48	Huber & Suhner	Batch no. 600918	400001182	ev	-/-	-/-
4	A	DC-Blocker 0.1-40 GHz	8141A	Inmet	-/-	400001185	ev	-/-	-/-
5	A	Std. Gain Horn Antenna 26.5-40.0 GHz	V637	Narda	82-16	300000510	vIK!	17.01.2022	31.01.2024
6	A	Broadband Low Noise Amplifier 18-50 GHz	CBL18503070-XX	CERNEX	19338	300004273	ev	-/-	-/-

7.4 Conducted measurements system

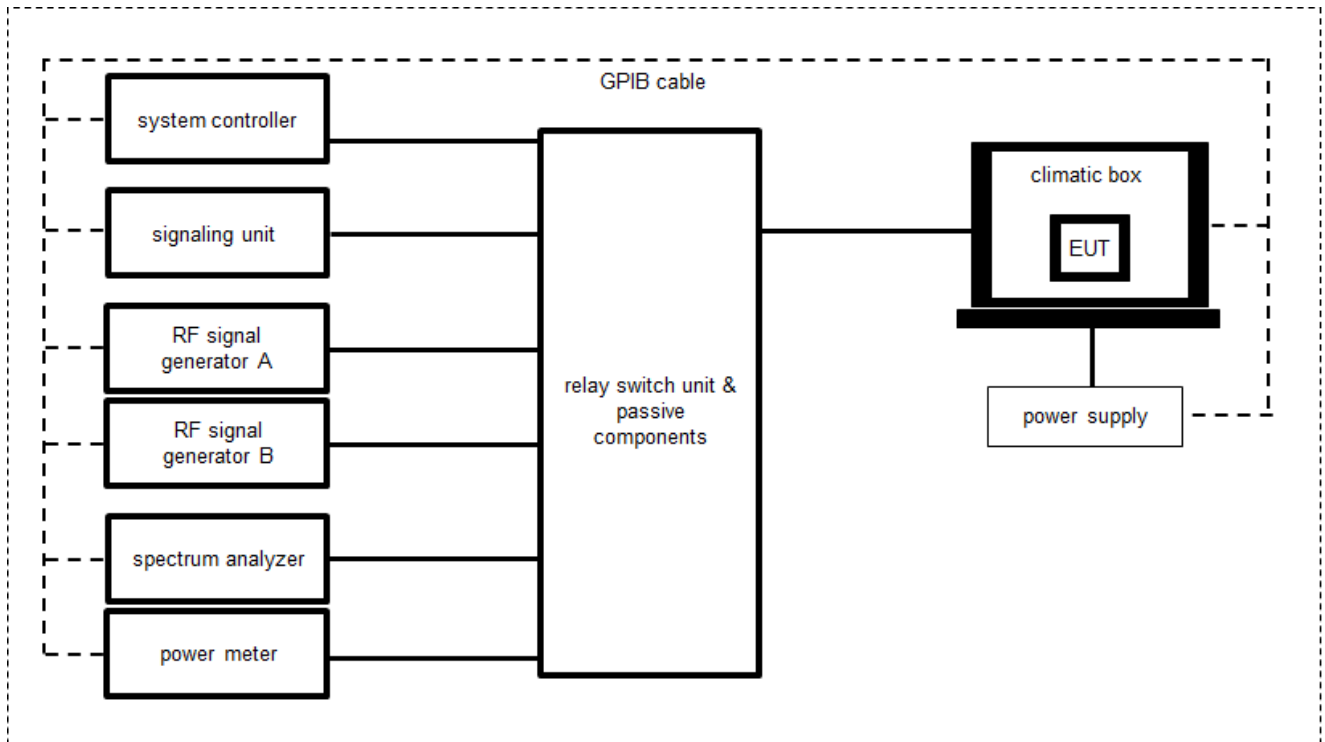

OP = AV + CA
 (OP-output power; AV-analyzer value; CA-loss signal path)

Example calculation:

OP [dBm] = 6.0 [dBm] + 11.7 [dB] = 17.7 [dBm] (58.88 mW)

Equipment table:

No.	Setup	Equipment	Type	Manufacturer	Serial No.	INV. No.	Kind of Calibration	Last Calibration	Next Calibration
1	A	Switch / Control Unit (including DC-Block, Splitter)	3488A	HP	-/-	300000929	ne	-/-	-/-
2	A	Hygro-Thermometer	-/, 5-45C, 20-100rF	Thies Clima	-/-	400000080	ev	15.09.2022	14.09.2024
3	A	Signal analyzer	FSV30	Rohde&Schwarz	1321.3008K30/103170	300004855	vKI!	09.12.2022	31.12.2024
4	A	USB-GPIB-Interface	82357B	Agilent Technologies	MY54323070	300004852	ne	-/-	-/-
5	A	Tester Software C.BER	Version 5.0	cetecom advanced GmbH	0001	400001379	ne	-/-	-/-
6	A	Switch matrix	RSM 1.1	cetecom advanced GmbH	31534892	400001456	ev	20.09.2023	19.09.2024

8 Sequence of testing

8.1 Sequence of testing radiated spurious 9 kHz to 30 MHz

Setup

- The equipment is set up to simulate normal operation mode as described in the user manual or defined by the manufacturer.
- If the EUT is a tabletop system, it is placed on a table with 0.8 m height.
- If the EUT is a floor standing device, it is placed directly on the turn table.
- Auxiliary equipment and cables are positioned to simulate normal operation conditions as described in ANSI C 63.4.
- The AC power port of the EUT (if available) is connected to a power outlet below the turntable.
- Measurement distance is 3 m (see ANSI C 63.4) – see test details.
- EUT is set into operation.

Premeasurement*

- The turntable rotates from 0° to 315° using 45° steps.
- The antenna height is 1 m.
- At each turntable position the analyzer sweeps with positive-peak detector to find the maximum of all emissions.

Final measurement

- Identified emissions during the pre-measurement are maximized by the software by rotating the turntable from 0° to 360°.
- Loop antenna is rotated about its vertical axis for maximum response at each azimuth about the EUT. (For certain applications, the loop antenna plane may also need to be positioned horizontally at the specified distance from the EUT)
- The final measurement is done in the position (turntable and elevation) causing the highest emissions with quasi-peak (as described in ANSI C 63.4).
- Final levels, frequency, measuring time, bandwidth, turntable position, correction factor, margin to the limit and limit will be recorded. A plot with the graph of the premeasurement and the limit is stored.

*Note: The sequence will be repeated three times with different EUT orientations.

8.2 Sequence of testing radiated spurious 30 MHz to 1 GHz

Setup

- The equipment is set up to simulate normal operation mode as described in the user manual or defined by the manufacturer.
- If the EUT is a tabletop system, a table with 0.8 m height is used, which is placed on the ground plane.
- If the EUT is a floor standing device, it is placed on the ground plane with insulation between both.
- Auxiliary equipment and cables are positioned to simulate normal operation conditions as described in ANSI C 63.4.
- The AC power port of the EUT (if available) is connected to a power outlet below the turntable.
- Measurement distance is 10 m or 3 m (see ANSI C 63.4) – see test details.
- EUT is set into operation.

Premeasurement

- The turntable rotates from 0° to 315° using 45° steps.
- The antenna is polarized vertical and horizontal.
- The antenna height changes from 1 m to 3 m.
- At each turntable position, antenna polarization and height the analyzer sweeps three times in peak to find the maximum of all emissions.

Final measurement

- The final measurement is performed for at least six highest peaks according to the requirements of the ANSI C63.4.
- Based on antenna and turntable positions at which the peak values are measured the software maximize the peaks by changing turntable position $\pm 45^\circ$ and antenna height between 1 and 4 m.
- The final measurement is done with quasi-peak detector (as described in ANSI C 63.4).
- Final levels, frequency, measuring time, bandwidth, antenna height, antenna polarization, turntable angle, correction factor, margin to the limit and limit are recorded. A plot with the graph of the premeasurement with marked maximum final results and the limit is stored.

8.3 Sequence of testing radiated spurious 1 GHz to 18 GHz

Setup

- The equipment is set up to simulate normal operation mode as described in the user manual or defined by the manufacturer.
- If the EUT is a tabletop system, a 2-axis positioner with 1.5 m height is used.
- If the EUT is a floor standing device, it is placed directly on the turn table.
- Auxiliary equipment and cables are positioned to simulate normal operation conditions as described in ANSI C 63.4.
- The AC power port of the EUT (if available) is connected to a power outlet below the turntable.
- Measurement distance is 3 m (see ANSI C 63.4) – see test details.
- EUT is set into operation.

Premeasurement

- The turntable rotates from 0° to 315° using 45° steps.
- The antenna is polarized vertical and horizontal.
- The antenna height is 1.5 m.
- At each turntable position and antenna polarization the analyzer sweeps with positive peak detector to find the maximum of all emissions.

Final measurement

- The final measurement is performed for at least six highest peaks according to the requirements of the ANSI C63.4.
- Based on antenna and turntable positions at which the peak values are measured the software maximizes the peaks by rotating the turntable from 0° to 360°. This measurement is repeated for different EUT-table positions (0° to 150° in 30°-steps) and for both antenna polarizations.
- The final measurement is done in the position (turntable, EUT-table and antenna polarization) causing the highest emissions with Peak and RMS detector (as described in ANSI C 63.4).
- Final levels, frequency, measuring time, bandwidth, turntable position, EUT-table position, antenna polarization, correction factor, margin to the limit and limit are recorded. A plot with the graph of the premeasurement with marked maximum final results and the limit is stored.

8.4 Sequence of testing radiated spurious above 18 GHz

Setup

- The equipment is set up to simulate normal operation mode as described in the user manual or defined by the manufacturer.
- Auxiliary equipment and cables are positioned to simulate normal operation conditions as described in ANSI C 63.4.
- The AC power port of the EUT (if available) is connected to a power outlet.
- The measurement distance is as appropriate (e.g. 0.5 m).
- The EUT is set into operation.

Premeasurement

- The test antenna is handheld and moved carefully over the EUT to cover the EUT's whole sphere and different polarizations of the antenna.

Final measurement

- The final measurement is performed at the position and antenna orientation causing the highest emissions with Peak and RMS detector (as described in ANSI C 63.4).
- Final levels, frequency, measuring time, bandwidth, correction factor, margin to the limit and limit are recorded. A plot with the graph of the premeasurement and the limit is stored.

9 Measurement uncertainty

Measurement uncertainty		
Test case	Uncertainty	
Antenna gain	± 3 dB	
Power spectral density	± 1.56 dB	
DTS bandwidth	± 100 kHz (depends on the used RBW)	
Occupied bandwidth	± 100 kHz (depends on the used RBW)	
Maximum output power conducted	± 1.56 dB	
Detailed spurious emissions @ the band edge - conducted	± 1.56 dB	
Band edge compliance radiated	± 3 dB	
Spurious emissions conducted	> 3.6 GHz	± 1.56 dB
	> 7 GHz	± 1.56 dB
	> 18 GHz	± 2.31 dB
	≥ 40 GHz	± 2.97 dB
Spurious emissions radiated below 30 MHz	± 3 dB	
Spurious emissions radiated 30 MHz to 1 GHz	± 3 dB	
Spurious emissions radiated 1 GHz to 12.75 GHz	± 3.7 dB	
Spurious emissions radiated above 12.75 GHz	± 4.5 dB	
Spurious emissions conducted below 30 MHz (AC conducted)	± 2.6 dB	

10 Summary of measurement results

<input checked="" type="checkbox"/>	No deviations from the technical specifications were ascertained
<input type="checkbox"/>	There were deviations from the technical specifications ascertained
<input type="checkbox"/>	This test report is only a partial test report. The content and verdict of the performed test cases are listed below.

TC Identifier	Description	Verdict	Date	Remark
RF-Testing	CFR Title 47 Part 15 RSS 247, Issue 3	See table	2024-03-01	-/-

Test specification clause	Test case	C	NC	NA	NP	Remark
-/-	Output power verification (cond.)	-/-				Declared
-/-	Antenna gain	-/-				Declared
U-NII Part 15	Duty cycle	-/-				-/-
§15.407(a) RSS - 247 (6.2.x.1)	Maximum output power (conducted & radiated)	<input checked="" type="checkbox"/>	<input type="checkbox"/>	<input type="checkbox"/>	<input type="checkbox"/>	-/-
§15.407(a) RSS - 247 (6.2.x.1)	Power spectral density	<input checked="" type="checkbox"/>	<input type="checkbox"/>	<input type="checkbox"/>	<input type="checkbox"/>	-/-
RSS - 247 (6.2.4.1)	Spectrum bandwidth 6dB bandwidth	<input checked="" type="checkbox"/>	<input type="checkbox"/>	<input type="checkbox"/>	<input type="checkbox"/>	-/-
§15.407(a) RSS - 247 (6.2.x.2)	Spectrum bandwidth 26dB bandwidth	<input checked="" type="checkbox"/>	<input type="checkbox"/>	<input type="checkbox"/>	<input type="checkbox"/>	-/-
RSS Gen clause 6.6	Spectrum bandwidth 99% bandwidth	-/-				-/-
§15.205 RSS - 247 (6.2.x.2)	Band edge compliance radiated	<input checked="" type="checkbox"/>	<input type="checkbox"/>	<input type="checkbox"/>	<input type="checkbox"/>	-/-
§15.407(b) RSS - 247 (6.2.x.2)	TX spurious emissions radiated	<input checked="" type="checkbox"/>	<input type="checkbox"/>	<input type="checkbox"/>	<input type="checkbox"/>	-/-
§15.209(a) RSS-Gen	Spurious emissions radiated < 30 MHz	<input checked="" type="checkbox"/>	<input type="checkbox"/>	<input type="checkbox"/>	<input type="checkbox"/>	-/-
§15.107(a) §15.207	Spurious emissions conducted emissions < 30 MHz	<input checked="" type="checkbox"/>	<input type="checkbox"/>	<input type="checkbox"/>	<input type="checkbox"/>	-/-
§15.407 RSS - 247 (6.3)	DFS	<input type="checkbox"/>	<input type="checkbox"/>	<input checked="" type="checkbox"/>	<input type="checkbox"/>	-/-

Notes:

C: Compliant	NC: Not compliant	NA: Not applicable	NP: Not performed
---------------------	--------------------------	---------------------------	--------------------------

11 Additional comments

Reference documents: None

Co-applicable documents: 1-6579_23-01-08_TR1_A201.pdf
TCU2 US IP30 - Technical Passport-v1.00-20230707_120232.pdf

Special test descriptions: All tests were performed with both ports/antennas transmitting simultaneously. All modes only support MIMO, not SISO.
The results of nHT20-mode and nHT40-mode are also applicable for acVHT20-mode and acVHT40-mode, as the power settings are the same for both modes.
The device is a client device without radar detection.

Configuration descriptions: Used power setting:
a-mode: 9.5
nHT20-mode: 8.5
nHT40-mode: 7.5
acVHT80-mode: 6.5

EUT selection: Only one device available
 Devices selected by the customer
 Devices selected by the laboratory (Randomly)

Provided channels:

Channels with 20 MHz channel bandwidth:

U-NII-1 & U-NII-2A (5150 MHz to 5250 MHz & 5250 MHz to 5350 MHz) channel number & center frequency								
channel	36	40	44	48	52	56	60	64
f _c / MHz	5180	5200	5220	5240	5260	5280	5300	5320

U-NII-2C (5470 MHz to 5725 MHz) channel number & center frequency											
channel	100	104	108	112	116	120	124	128	132	136	140
f _c / MHz	5500	5520	5540	5560	5580	5600	5620	5640	5660	5680	5700

U-NII-3 (5725 MHz to 5850 MHz) channel number & center frequency					
channel	149	153	157	161	165
f _c / MHz	5745	5765	5785	5805	5825

Channels with 40 MHz channel bandwidth:

U-NII-1 & U-NII-2A (5150 MHz to 5250 MHz & 5250 MHz to 5350 MHz) channel number & center frequency				
channel	38	46	54	62
f _c / MHz	5190	5230	5270	5310

U-NII-2C (5470 MHz to 5725 MHz) channel number & center frequency				
channel	102	110	118	126
f _c / MHz	5510	5550	5590	5630

U-NII-3 (5725 MHz to 5850 MHz) channel number & center frequency	
channel	151
f _c / MHz	5755

Channels with 80 MHz channel bandwidth:

U-NII-1 & U-NII-2A (5150 MHz to 5250 MHz & 5250 MHz to 5350 MHz) channel number & center frequency	
channel	42
f _c / MHz	5210

U-NII-2C (5470 MHz to 5725 MHz) channel number & center frequency	
channel	106
f _c / MHz	5530

U-NII-3 (5725 MHz to 5850 MHz) channel number & center frequency	
channel	155
f _c / MHz	5775

Note: The channels used for the tests were marked in bold in the list.

Test mode:

- No test mode available.
Iperf is used to transmit data to a companion device
- Special software is used.
EUT is transmitting pseudo random data by itself

Antennas and transmit operating modes:

- Operating mode 1 (single antenna)
 - Equipment with 1 antenna,
 - Equipment with 2 diversity antennas operating in switched diversity mode by which at any moment in time only 1 antenna is used,
 - Smart antenna system with 2 or more transmit/receive chains, but operating in a mode where only 1 transmit/receive chain is used)
- Operating mode 2 (multiple antennas, no beamforming)
 - Equipment operating in this mode contains a smart antenna system using two or more transmit/receive chains simultaneously but without beamforming.
- Operating mode 3 (multiple antennas, with beamforming)
 - Equipment operating in this mode contains a smart antenna system using two or more transmit/receive chains simultaneously with beamforming.
In addition to the antenna assembly gain (G), the beamforming gain (Y) may have to be taken into account when performing the measurements.

12 Measurement results

12.1 Identify worst case data rate

Measurement:

All modes of the module will be measured with an average power meter to identify the maximum transmission power on mid channel. In the case that only one or two channels are available, only these will be measured.

In further tests only the identified worst case modulation scheme or bandwidth will be measured.

Measurement parameters:

Measurement parameter	
Detector:	Peak
Sweep time:	Auto
Resolution bandwidth:	3 MHz
Video bandwidth:	3 MHz
Trace mode:	Max hold
Used test setup:	See chapter 7.4 – A
Measurement uncertainty:	See chapter 9

Results:

OFDM – mode	Modulation scheme / bandwidth					
	U-NII-1 & U-NII-2A		U-NII-2C		U-NII-3	
	lowest channel	highest channel	lowest channel	highest channel	lowest channel	highest channel
a – mode	6 Mbit/s	6 Mbit/s	6 Mbit/s	6 Mbit/s	6 Mbit/s	6 Mbit/s
n/ac HT20 – mode	MCS0	MCS0	MCS0	MCS0	MCS0	MCS0
n/ac HT40 – mode	MCS0	MCS0	MCS0	MCS0	MCS0	MCS0
ac VHT80 – mode	MCS0	MCS0	MCS0	MCS0	MCS0	MCS0

12.2 Antenna gain

Limits:

Antenna Gain
6 dBi / > 6 dBi output power and power density reduction required

Results: valid for both antennas

U-NII-1 (5150 MHz to 5250 MHz)	Antenna gain		
	Lowest channel	Middle channel	Highest channel
Gain / dBi (calculated or declared)	3.7	3.7	3.7

U-NII-3 (5725 MHz to 5850 MHz)	Antenna gain		
	Lowest channel	Middle channel	Highest channel
Gain / dBi (calculated or declared)	3.7	3.7	3.7

12.3 Duty cycle

Measurement:

Measurement parameter	
According to: KDB789033 D02, B.	
Used test setup:	See chapter 7.4 – A
Measurement uncertainty:	See chapter 9

Results:

Duty cycle and correction factor:

OFDM – mode	Calculation method
a – mode	100 % duty cycle for all modes
n/ac HT20 – mode	
n/ac HT40 – mode	
ac VHT80 – mode	

12.4 Maximum output power

12.4.1 Maximum output power according to FCC requirements

Description:

Measurement of the maximum output power conducted

Measurement:

Measurement parameter	
According to: KDB789033 D02, E.2.e.	
External result file(s)	1-6579_23-01-08_TR1-A201.pdf FCC Part 15.407 Max Output Power and PSD
Used test setup:	See chapter 7.4 – A
Measurement uncertainty:	See chapter 9

Limits:

Limits	
Radiated output power	Conducted output power
Band 5150 MHz – 5250 MHz	
<p>For an outdoor access point: Conducted power + 6 dBi antenna gain</p> <p>For an indoor access point: Conducted power + 6 dBi antenna gain</p> <p>For fixed point-to-point access points Conducted power + 23 dBi antenna gain</p> <p>For client devices Conducted power + 6 dBi antenna gain (If the Antenna gain is greater than the Limit: 1dB reduction in the max. conducted output power for each 1 dB of antenna gain in excess of the Limit)</p>	<p>For an outdoor access point: output power $\leq 1\text{W}/30\text{dBm}$</p> <p>The maximum e.i.r.p. at any elevation angle above 30 degrees as measured from the horizon must not exceed 125 mW (21 dBm)</p> <p>For an indoor access point output power $\leq 1\text{W}/30\text{dBm}$</p> <p>For fixed point-to-point access points output power $\leq 1\text{W}/30\text{dBm}$</p> <p>For client devices output power $\leq 250\text{ mW}/24\text{dBm}$</p>
Band 5250MHz – 5350 MHz	
<p>Conducted power + 6 dBi antenna gain (Antenna gain higher than the Limit: 1dB reduction in the max. conducted output power for each 1 dB of antenna gain in excess of the Limit)</p>	<p>Output power \leq lesser of 250mW or 11dBm +10logB (B is the 26 dB emission bandwidth in megahertz)</p>
Band 5470MHz – 5725 MHz	
<p>Conducted power + 6 dBi antenna gain (Antenna gain higher than the Limit: 1dB reduction in the max. conducted output power for each 1 dB of antenna gain in excess of the Limit)</p>	<p>Output power \leq lesser of 250mW or 11dBm +10logB (B is the 26 dB emission bandwidth in megahertz)</p>
Band 5725MHz – 5850 MHz	
<p>Conducted power + 6 dBi antenna gain (Antenna gain higher than the Limit: 1dB reduction in the max. conducted output power for each 1 dB of antenna gain in excess of the Limit Exception: fixed point-to-point U-NII devices, no corresponding reduction in transmitter conducted power)</p>	<p>output power $\leq 1\text{W}/30\text{dBm}$</p>

Results: antenna port 1

a	Maximum output power conducted [dBm]		
	U-NII-1 (5150 MHz to 5250 MHz)		
	Lowest channel	Middle channel	Highest channel
	6.5	6.9	7.8
	U-NII-3 (5725 MHz to 5850 MHz)		
	Lowest channel	Middle channel	Highest channel
2.7	4.7	4.3	

Results: antenna port 1

n/ac HT20	Maximum output power conducted [dBm]		
	U-NII-1 (5150 MHz to 5250 MHz)		
	Lowest channel	Middle channel	Highest channel
	3.2	3.4	4.5
	U-NII-3 (5725 MHz to 5850 MHz)		
	Lowest channel	Middle channel	Highest channel
-2.1	0.0	1.1	

Results: antenna port 1

n/ac HT40	Maximum output power conducted [dBm]	
	U-NII-1 (5150 MHz to 5250 MHz)	
	Lowest channel	Highest channel
	1.4	1.8
	U-NII-3 (5725 MHz to 5850 MHz)	
	Lowest channel	Highest channel
-3.7	-1.5	

Results: antenna port 1

ac VHT80	Maximum output power conducted [dBm]
	U-NII-1 (5150 MHz to 5250 MHz)
	Middle channel
	1.6
	U-NII-3 (5725 MHz to 5850 MHz)
	Middle channel
-4.3	

Results: antenna port 2

a	Maximum output power conducted [dBm]		
	U-NII-1 (5150 MHz to 5250 MHz)		
	Lowest channel	Middle channel	Highest channel
	6.0	6.1	6.1
	U-NII-3 (5725 MHz to 5850 MHz)		
	Lowest channel	Middle channel	Highest channel
0.1	1.8	2.3	

Results: antenna port 2

n/ac HT20	Maximum output power conducted [dBm]		
	U-NII-1 (5150 MHz to 5250 MHz)		
	Lowest channel	Middle channel	Highest channel
	3.5	3.7	3.6
	U-NII-3 (5725 MHz to 5850 MHz)		
	Lowest channel	Middle channel	Highest channel
-0.6	0.9	1.0	

Results: antenna port 2

n/ac HT40	Maximum output power conducted [dBm]	
	U-NII-1 (5150 MHz to 5250 MHz)	
	Lowest channel	Highest channel
	2.0	2.1
	U-NII-3 (5725 MHz to 5850 MHz)	
	Lowest channel	Highest channel
-1.4	-0.2	

Results: antenna port 2

ac VHT80	Maximum output power conducted [dBm]
	U-NII-1 (5150 MHz to 5250 MHz)
	Middle channel
	1.2
	U-NII-3 (5725 MHz to 5850 MHz)
Middle channel	
-1.8	

Results: antenna port 1+2

a	Maximum output power conducted [dBm]		
	U-NII-1 (5150 MHz to 5250 MHz)		
	Lowest channel	Middle channel	Highest channel
	9.3	9.5	10.0
	U-NII-3 (5725 MHz to 5850 MHz)		
	Lowest channel	Middle channel	Highest channel
4.6	6.5	6.4	

Results: antenna port 1+2

n/ac HT20	Maximum output power conducted [dBm]		
	U-NII-1 (5150 MHz to 5250 MHz)		
	Lowest channel	Middle channel	Highest channel
	6.4	6.6	7.1
	U-NII-3 (5725 MHz to 5850 MHz)		
	Lowest channel	Middle channel	Highest channel
1.7	3.5	4.1	

Results: antenna port 1+2

n/ac HT40	Maximum output power conducted [dBm]	
	U-NII-1 (5150 MHz to 5250 MHz)	
	Lowest channel	Highest channel
	4.7	5.0
	U-NII-3 (5725 MHz to 5850 MHz)	
	Lowest channel	Highest channel
0.6	2.2	

Results: antenna port 1+2

ac VHT80	Maximum output power conducted [dBm]
	U-NII-1 (5150 MHz to 5250 MHz)
	Middle channel
	4.4
	U-NII-3 (5725 MHz to 5850 MHz)
	Middle channel
0.1	

12.4.2 Maximum output power according to ISED requirements

Description:

Measurement of the maximum output power conducted + radiated

Measurement:

Measurement parameter	
External result file(s)	1-6579_23-01-08_TR1-A201.pdf ISED Max Output Power and PSD
Used test setup:	See chapter 7.4 – A
Measurement uncertainty:	See chapter 9

Limits:

Radiated output power	Conducted output power for mobile equipment
The lesser one of 30 mW (14.8 dBm) or $1.76 + 10 \log_{10} B$ dBm 5.150-5.250 GHz 1 W or 17 dBm + 10 log Bandwidth 5.250-5.350 GHz 1 W or 17 dBm + 10 log Bandwidth 5.470-5.725 GHz (where Bandwidth is the 99% Bandwidth [MHz]) Conducted power + 6dBi antenna gain 5.725-5.825 GHz	The lesser one of 250mW or 11 dBm + 10 log Bandwidth 5.250-5.350 GHz 250mW or 11 dBm + 10 log Bandwidth 5.470-5.725 GHz (where Bandwidth is the 99% Bandwidth [MHz]) 1W 5.725-5.825 GHz

NOTE: Because of vehicular use, the e.i.r.p. limit for the 5150-5250 MHz band is: 30 mW (14.8 dBm) or $1.76 + 10 \log_{10} B$ dBm. The lowest 99% bandwidth from Chapter 12.8 is 16.284 MHz. This results in an e.i.r.p. limit of 13.9 dBm.

Results: antenna port 1

a	Maximum output power [dBm]		
	U-NII-1 (5150 MHz to 5250 MHz)		
	Lowest channel	Middle channel	Highest channel
	Conducted		
	6.5	6.8	7.7
	Radiated (calculated – see chapter antenna gain)		
	10.2	10.5	11.4
	U-NII-3 (5725 MHz to 5850 MHz)		
	Lowest channel	Middle channel	Highest channel
	Conducted		
	2.6	4.6	4.2
	Radiated (calculated – see chapter antenna gain)		
	6.3	8.3	7.9

Results: antenna port 1

n/ac HT20	Maximum output power [dBm]		
	U-NII-1 (5150 MHz to 5250 MHz)		
	Lowest channel	Middle channel	Highest channel
	Conducted		
	3.1	3.3	4.5
	Radiated (calculated – see chapter antenna gain)		
	6.8	7.0	8.2
	U-NII-3 (5725 MHz to 5850 MHz)		
	Lowest channel	Middle channel	Highest channel
	Conducted		
	-2.2	-0.2	1.0
	Radiated (calculated – see chapter antenna gain)		
	1.5	3.5	4.7

Results: antenna port 1

n/ac HT40	Maximum output power [dBm]	
	U-NII-1 (5150 MHz to 5250 MHz)	
	Lowest channel	Highest channel
	Conducted	
	1.4	-1.7
	Radiated (calculated – see chapter antenna gain)	
	5.1	2.0
	U-NII-3 (5725 MHz to 5850 MHz)	
	Lowest channel	Highest channel
	Conducted	
	-3.7	-1.5
	Radiated (calculated – see chapter antenna gain)	
	0.0	2.2

Results: antenna port 1

ac VHT80	Maximum output power [dBm]	
	U-NII-1 (5150 MHz to 5250 MHz)	
	Middle channel	
	Conducted	
	1.5	
	Radiated (calculated – see chapter antenna gain)	
	5.2	
	U-NII-3 (5725 MHz to 5850 MHz)	
	Middle channel	
	Conducted	
	-4.3	
	Radiated (calculated – see chapter antenna gain)	
	-0.6	

Results: antenna port 2

a	Maximum output power [dBm]		
	U-NII-1 (5150 MHz to 5250 MHz)		
	Lowest channel	Middle channel	Highest channel
	Conducted		
	6.0	6.0	6.0
	Radiated (calculated – see chapter antenna gain)		
	9.7	9.7	9.7
	U-NII-3 (5725 MHz to 5850 MHz)		
	Lowest channel	Middle channel	Highest channel
	Conducted		
	0.1	1.7	2.2
	Radiated (calculated – see chapter antenna gain)		
	3.8	5.4	5.9

Results: antenna port 2

n/ac HT20	Maximum output power [dBm]		
	U-NII-1 (5150 MHz to 5250 MHz)		
	Lowest channel	Middle channel	Highest channel
	Conducted		
	3.5	3.6	3.5
	Radiated (calculated – see chapter antenna gain)		
	7.2	7.3	7.2
	U-NII-3 (5725 MHz to 5850 MHz)		
	Lowest channel	Middle channel	Highest channel
	Conducted		
	-0.7	0.8	0.9
	Radiated (calculated – see chapter antenna gain)		
	3.0	4.5	4.6

Results: antenna port 2

n/ac HT40	Maximum output power [dBm]	
	U-NII-1 (5150 MHz to 5250 MHz)	
	Lowest channel	Highest channel
	Conducted	
	2.0	2.1
	Radiated (calculated – see chapter antenna gain)	
	5.7	5.8
	U-NII-3 (5725 MHz to 5850 MHz)	
	Lowest channel	Highest channel
	Conducted	
	-1.5	-0.3
	Radiated (calculated – see chapter antenna gain)	
	2.2	3.4

Results: antenna port 2

ac VHT80	Maximum output power [dBm]	
	U-NII-1 (5150 MHz to 5250 MHz)	
	Middle channel	
	Conducted	
	1.2	
	Radiated (calculated – see chapter antenna gain)	
	4.9	
	U-NII-3 (5725 MHz to 5850 MHz)	
	Middle channel	
	Conducted	
	-1.8	
	Radiated (calculated – see chapter antenna gain)	
	1.9	

Results: antenna port 1+2

a	Maximum output power [dBm]		
	U-NII-1 (5150 MHz to 5250 MHz)		
	Lowest channel	Middle channel	Highest channel
	Conducted		
	9.3	9.4	9.9
	Radiated (calculated – see chapter antenna gain)		
	13.0	13.1	13.6
	U-NII-3 (5725 MHz to 5850 MHz)		
	Lowest channel	Middle channel	Highest channel
	Conducted		
	4.5	6.4	6.3
	Radiated (calculated – see chapter antenna gain)		
	8.2	10.1	10.0

Results: antenna port 1+2

n/ac HT20	Maximum output power [dBm]		
	U-NII-1 (5150 MHz to 5250 MHz)		
	Lowest channel	Middle channel	Highest channel
	Conducted		
	6.3	6.5	7.0
	Radiated (calculated – see chapter antenna gain)		
	10.0	10.2	10.7
	U-NII-3 (5725 MHz to 5850 MHz)		
	Lowest channel	Middle channel	Highest channel
	Conducted		
	1.6	3.3	4.0
	Radiated (calculated – see chapter antenna gain)		
	5.3	7.0	7.7

Results: antenna port 1+2

n/ac HT40	Maximum output power [dBm]	
	U-NII-1 (5150 MHz to 5250 MHz)	
	Lowest channel	Highest channel
	Conducted	
	4.7	4.9
	Radiated (calculated – see chapter antenna gain)	
	8.4	8.6
	U-NII-3 (5725 MHz to 5850 MHz)	
	Lowest channel	Highest channel
	Conducted	
	0.2	2.2
	Radiated (calculated – see chapter antenna gain)	
	3.9	5.9

Results: antenna port 1+2

ac VHT80	Maximum output power [dBm]	
	U-NII-1 (5150 MHz to 5250 MHz)	
	Middle channel	
	Conducted	
	4.4	
	Radiated (calculated – see chapter antenna gain)	
	8.1	
	U-NII-3 (5725 MHz to 5850 MHz)	
	Middle channel	
	Conducted	
	0.1	
	Radiated (calculated – see chapter antenna gain)	
	3.8	

12.5 Power spectral density

12.5.1 Power spectral density according to FCC requirements

Measurement:

Measurement parameter	
According to: KDB789033 D02, F.	
External result file(s)	1-6579_23-01-08_TR1-A201.pdf FCC Part 15.407 Max Output Power and PSD
Used test setup:	See chapter 7.4 – A
Measurement uncertainty:	See chapter 9

Limits:

Power Spectral Density
Band 5150 MHz – 5250 MHz
<p>For an outdoor access point power spectral density conducted ≤ 17 dBm in any 1 MHz band*</p> <p>For an indoor access point power spectral density conducted ≤ 17 dBm in any 1 MHz band*</p> <p>For fixed point-to-point access points power spectral density conducted ≤ 17 dBm in any 1 MHz band**</p> <p>For client devices point power spectral density conducted ≤ 11 dBm in any 1 MHz band*</p> <p>*If transmitting antennas of directional gain greater than 6 dBi are used the maximum power spectral density shall be reduced by the amount in dB that the directional gain of the antenna exceeds 6 dBi</p> <p>**Fixed point-to-point U-NII devices may employ antennas with directional gain up to 23 dBi without any corresponding reduction in the maximum power spectral density. For fixed point-to-point transmitters that employ a directional antenna gain greater than 23 dBi, a 1 dB reduction in maximum power spectral density is required for each 1 dB of antenna gain in excess of 23 dBi.</p>
Band 5250MHz – 5350 MHz
<p>power spectral density conducted ≤ 11 dBm in any 1 MHz band*</p> <p>*If transmitting antennas of directional gain greater than 6 dBi are used the maximum power spectral density shall be reduced by the amount in dB that the directional gain of the antenna exceeds 6 dBi</p>
Band 5470MHz – 5725 MHz
<p>power spectral density conducted ≤ 11 dBm in any 1 MHz band*</p> <p>*If transmitting antennas of directional gain greater than 6 dBi are used the maximum power spectral density shall be reduced by the amount in dB that the directional gain of the antenna exceeds 6 dBi</p>
Band 5725MHz – 5850 MHz
<p>power spectral density conducted ≤ 30 dBm in any 500 kHz band</p> <p>If transmitting antennas of directional gain greater than 6 dBi are used the maximum power spectral density shall be reduced by the amount in dB that the directional gain of the antenna exceeds 6 dBi</p>

Results: antenna port 1

a	Power spectral density (dBm/1MHz or dBm/500kHz)		
	U-NII-1 (5150 MHz to 5250 MHz)		
	Lowest channel	Middle channel	Highest channel
	-4.6	-4.2	-3.3
	U-NII-3 (5725 MHz to 5850 MHz)		
	Lowest channel	Middle channel	Highest channel
-11.4	-9.3	-9.7	

Results: antenna port 1

n/ac HT20	Power spectral density (dBm/1MHz or dBm/500kHz)		
	U-NII-1 (5150 MHz to 5250 MHz)		
	Lowest channel	Middle channel	Highest channel
	-8.3	-8.0	-7.0
	U-NII-3 (5725 MHz to 5850 MHz)		
	Lowest channel	Middle channel	Highest channel
-16.4	-14.3	-13.3	

Results: antenna port 1

n/ac HT40	Power spectral density (dBm/1MHz or dBm/500kHz)		
	U-NII-1 (5150 MHz to 5250 MHz)		
	Lowest channel	Highest channel	
	-13.0	-12.6	
	U-NII-3 (5725 MHz to 5850 MHz)		
	Lowest channel	Highest channel	
-20.4	-18.6		

Results: antenna port 1

ac VHT80	Power spectral density (dBm/1MHz or dBm/500kHz)		
	U-NII-1 (5150 MHz to 5250 MHz)		
	Middle channel		
	-15.7		
	U-NII-3 (5725 MHz to 5850 MHz)		
	Middle channel		
-23.6			

Results: antenna port 2

a	Power spectral density (dBm/1MHz or dBm/500kHz)		
	U-NII-1 (5150 MHz to 5250 MHz)		
	Lowest channel	Middle channel	Highest channel
	-5.1	-5.0	-5.0
	U-NII-3 (5725 MHz to 5850 MHz)		
	Lowest channel	Middle channel	Highest channel
-13.9	-12.2	-11.8	

Results: antenna port 2

n/ac HT20	Power spectral density (dBm/1MHz or dBm/500kHz)		
	U-NII-1 (5150 MHz to 5250 MHz)		
	Lowest channel	Middle channel	Highest channel
	-7.8	-7.6	-7.8
	U-NII-3 (5725 MHz to 5850 MHz)		
	Lowest channel	Middle channel	Highest channel
-14.8	-13.2	-13.2	

Results: antenna port 2

n/ac HT40	Power spectral density (dBm/1MHz or dBm/500kHz)		
	U-NII-1 (5150 MHz to 5250 MHz)		
	Lowest channel	Highest channel	
	-12.2	-12.2	
	U-NII-3 (5725 MHz to 5850 MHz)		
	Lowest channel	Highest channel	
-18.2	-17.4		

Results: antenna port 2

ac VHT80	Power spectral density (dBm/1MHz or dBm/500kHz)		
	U-NII-1 (5150 MHz to 5250 MHz)		
	Middle channel		
	-16.0		
	U-NII-3 (5725 MHz to 5850 MHz)		
	Middle channel		
-21.5			

Results: antenna port 1+2

a	Power spectral density (dBm/1MHz or dBm/500kHz)		
	U-NII-1 (5150 MHz to 5250 MHz)		
	Lowest channel	Middle channel	Highest channel
	-1.8	-1.6	-1.1
	U-NII-3 (5725 MHz to 5850 MHz)		
	Lowest channel	Middle channel	Highest channel
-9.5	-7.5	-7.6	

Results: antenna port 1+2

n/ac HT20	Power spectral density (dBm/1MHz or dBm/500kHz)		
	U-NII-1 (5150 MHz to 5250 MHz)		
	Lowest channel	Middle channel	Highest channel
	-5.0	-4.8	-4.4
	U-NII-3 (5725 MHz to 5850 MHz)		
	Lowest channel	Middle channel	Highest channel
-12.5	-10.7	-10.2	

Results: antenna port 1+2

n/ac HT40	Power spectral density (dBm/1MHz or dBm/500kHz)		
	U-NII-1 (5150 MHz to 5250 MHz)		
	Lowest channel	Highest channel	
	-9.6	-9.4	
	U-NII-3 (5725 MHz to 5850 MHz)		
	Lowest channel	Highest channel	
-16.2	-14.9		

Results: antenna port 1+2

ac VHT80	Power spectral density (dBm/1MHz or dBm/500kHz)		
	U-NII-1 (5150 MHz to 5250 MHz)		
	Middle channel		
	-12.8		
	U-NII-3 (5725 MHz to 5850 MHz)		
	Middle channel		
-19.4			

12.5.2 Power spectral density according to ISED requirements

Measurement:

Measurement parameter	
External result file(s)	1-6579_23-01-08_TR1-A201.pdf ISED Max Output Power and PSD
Used test setup:	See chapter 7.4 – A
Measurement uncertainty:	See chapter 9

Limits:

Power Spectral Density
power spectral density e.i.r.p. ≤ 10 dBm in any 1 MHz band (band 5150 – 5250 MHz) power spectral density conducted ≤ 11 dBm in any 1 MHz band (band 5250 – 5350 MHz) power spectral density conducted ≤ 11 dBm in any 1 MHz band (band 5470 – 5725 MHz) power spectral density conducted ≤ 30 dBm in any 500 kHz band (band 5725 – 5850 MHz)

Results: antenna port 1

a	Power spectral density (dBm/1MHz or dBm/500kHz)		
	U-NII-1 (5150 MHz to 5250 MHz)		
	Lowest channel	Middle channel	Highest channel
	Conducted		
	-4.6	-4.2	-3.3
	Radiated (calculated – see chapter antenna gain)		
	-0.9	-0.5	0.4
	U-NII-3 (5725 MHz to 5850 MHz)		
	Lowest channel	Middle channel	Highest channel
	-11.4	-9.3	-9.7

Results: antenna port 1

n/ac HT20	Power spectral density (dBm/1MHz or dBm/500kHz)		
	U-NII-1 (5150 MHz to 5250 MHz)		
	Lowest channel	Middle channel	Highest channel
	Conducted		
	-8.3	-7.9	-7.0
	Radiated (calculated – see chapter antenna gain)		
	-4.6	-4.2	-3.3
	U-NII-3 (5725 MHz to 5850 MHz)		
	Lowest channel	Middle channel	Highest channel
	-16.4	-14.3	-13.3

Results: antenna port 1

n/ac HT40	Power spectral density (dBm/1MHz or dBm/500kHz)	
	U-NII-1 (5150 MHz to 5250 MHz)	
	Lowest channel	Highest channel
	Conducted	
	-13.0	-12.6
	Radiated (calculated – see chapter antenna gain)	
	-9.3	-8.9
	U-NII-3 (5725 MHz to 5850 MHz)	
	Lowest channel	Highest channel
	-20.4	-18.5

Results: antenna port 1

ac VHT80	Power spectral density (dBm/1MHz or dBm/500kHz)		
	U-NII-1 (5150 MHz to 5250 MHz)		
	Middle channel		
	Conducted		
	-15.8		
	Radiated (calculated – see chapter antenna gain)		
	-12.1		
	U-NII-3 (5725 MHz to 5850 MHz)		
	Middle channel		
	-23.6		

Results: antenna port 2

a	Power spectral density (dBm/1MHz or dBm/500kHz)		
	U-NII-1 (5150 MHz to 5250 MHz)		
	Lowest channel	Middle channel	Highest channel
	Conducted		
	-5.1	-5.0	-5.0
	Radiated (calculated – see chapter antenna gain)		
	-1.4	-1.3	-1.3
	U-NII-3 (5725 MHz to 5850 MHz)		
	Lowest channel	Middle channel	Highest channel
	-13.9	-12.3	-11.8

Results: antenna port 2

n/ac HT20	Power spectral density (dBm/1MHz or dBm/500kHz)		
	U-NII-1 (5150 MHz to 5250 MHz)		
	Lowest channel	Middle channel	Highest channel
	Conducted		
	-7.8	-7.6	-7.8
	Radiated (calculated – see chapter antenna gain)		
	-4.1	-3.9	-4.1
	U-NII-3 (5725 MHz to 5850 MHz)		
	Lowest channel	Middle channel	Highest channel
	-14.8	-13.2	-13.2

Results: antenna port 2

n/ac HT40	Power spectral density (dBm/1MHz or dBm/500kHz)	
	U-NII-1 (5150 MHz to 5250 MHz)	
	Lowest channel	Highest channel
	Conducted	
	-12.2	-12.3
	Radiated (calculated – see chapter antenna gain)	
	-8.5	-8.6
	U-NII-3 (5725 MHz to 5850 MHz)	
	Lowest channel	Highest channel
	-18.2	-17.4

Results: antenna port 2

ac VHT80	Power spectral density (dBm/1MHz or dBm/500kHz)	
	U-NII-1 (5150 MHz to 5250 MHz)	
	Middle channel	
	Conducted	
	-16.0	
	Radiated (calculated – see chapter antenna gain)	
	-13.3	
	U-NII-3 (5725 MHz to 5850 MHz)	
Middle channel		
-21.5		

Results: antenna port 1+2

a	Power spectral density (dBm/1MHz or dBm/500kHz)		
	U-NII-1 (5150 MHz to 5250 MHz)		
	Lowest channel	Middle channel	Highest channel
	Conducted		
	-1.8	-1.6	-1.1
	Radiated (calculated – see chapter antenna gain)		
	1.9	2.1	2.6
	U-NII-3 (5725 MHz to 5850 MHz)		
	Lowest channel	Middle channel	Highest channel
	-9.5	-7.5	-7.6

Results: antenna port 1+2

n/ac HT20	Power spectral density (dBm/1MHz or dBm/500kHz)		
	U-NII-1 (5150 MHz to 5250 MHz)		
	Lowest channel	Middle channel	Highest channel
	Conducted		
	-5.0	-4.7	-4.4
	Radiated (calculated – see chapter antenna gain)		
	-1.3	-1.0	-0.7
	U-NII-3 (5725 MHz to 5850 MHz)		
	Lowest channel	Middle channel	Highest channel
	-12.5	-10.7	-10.2

Results: antenna port 1+2

n/ac HT40	Power spectral density (dBm/1MHz or dBm/500kHz)	
	U-NII-1 (5150 MHz to 5250 MHz)	
	Lowest channel	Highest channel
	Conducted	
	-9.6	-9.4
	Radiated (calculated – see chapter antenna gain)	
	-5.9	-5.7
	U-NII-3 (5725 MHz to 5850 MHz)	
	Lowest channel	Highest channel
	-16.2	-14.9

Results: antenna port 1+2

ac VHT80	Power spectral density (dBm/1MHz or dBm/500kHz)
	U-NII-1 (5150 MHz to 5250 MHz)
	Middle channel
	Conducted
	-12.9
	Radiated (calculated – see chapter antenna gain)
	-9.2
	U-NII-3 (5725 MHz to 5850 MHz)
	Middle channel
	-19.4

12.6 Minimum emission bandwidth for the band 5.725-5.85 GHz

Description:

Measurement of the 6 dB bandwidth of the modulated signal.

Measurement:

Measurement parameter	
According to: KDB789033 D02, C.2.	
External result file(s)	1-6579_23-01-08_TR1-A201.pdf FCC Part 15.407 & ISED Minimum Emission BW
Used test setup:	See chapter 7.4 – A
Measurement uncertainty:	See chapter 9

Limits:

FCC	ISED
The minimum 6 dB bandwidth shall be at least 500 kHz.	

Results: antenna port 1

a	6 dB emission bandwidth (MHz)		
	U-NII-3 (5725 MHz to 5850 MHz)		
	Lowest channel	Middle channel	Highest channel
	15.1	15.1	15.1
n/ac HT20	6 dB emission bandwidth (MHz)		
	U-NII-3 (5725 MHz to 5850 MHz)		
	Lowest channel	Middle channel	Highest channel
	16.5	16.5	16.5
n/ac HT40	6 dB emission bandwidth (MHz)		
	U-NII-3 (5725 MHz to 5850 MHz)		
	Lowest channel	Highest channel	
	36.4	36.4	
ac VHT80	6 dB emission bandwidth (MHz)		
	U-NII-3 (5725 MHz to 5850 MHz)		
	Middle channel		
	76.4		

Results: antenna port 2

a	6 dB emission bandwidth (MHz)		
	U-NII-3 (5725 MHz to 5850 MHz)		
	Lowest channel	Middle channel	Highest channel
	15.1	15.2	15.2
n/ac HT20	6 dB emission bandwidth (MHz)		
	U-NII-3 (5725 MHz to 5850 MHz)		
	Lowest channel	Middle channel	Highest channel
	16.5	16.5	16.5
n/ac HT40	6 dB emission bandwidth (MHz)		
	U-NII-3 (5725 MHz to 5850 MHz)		
	Lowest channel	Highest channel	
	36.4	36.4	
ac VHT80	6 dB emission bandwidth (MHz)		
	U-NII-3 (5725 MHz to 5850 MHz)		
	Middle channel		
	76.4		

12.7 Spectrum bandwidth / 26 dB / 20 dB bandwidth

Description:

Measurement of the 26 dB/20 dB bandwidth of the modulated signal.

Measurement:

Measurement parameter	
According to: KDB789033 D02, C.1.	
External result file(s)	1-6579_23-01-08_TR1-A201.pdf FCC Part 15.407 & ISED Bandwidths
Used test setup:	see chapter 7.4 – A
Measurement uncertainty:	See chapter 9

Limits:

Spectrum Bandwidth – 26 dB Bandwidth
<p>IC: Any unwanted emissions that fall into the band 5250-5350 MHz shall be attenuated below the channel power by at least 26 dB, when measured using a resolution bandwidth between 1 and 5% of the occupied bandwidth (i.e. 99% bandwidth), above 5250 MHz. The 26 dB bandwidth may fall into the 5250-5350 MHz band; however, if the occupied bandwidth also falls within the 5250-5350 MHz band, the transmission is considered as intentional and the devices shall comply with all requirements in the band 5250-5350 MHz including implementing dynamic frequency selection (DFS) and TPC, on the portion of the emission that resides in the 5250-5350 MHz band.</p> <p>FCC: Radar Detection Function of Dynamic Frequency Selection (DFS). U-NII devices operating with any part of its 26 dB emission bandwidth in the 5.25-5.35 GHz and 5.47-5.725 GHz bands shall employ a DFS radar detection mechanism to detect the presence of radar systems and to avoid co-channel operation with radar systems.</p>

Results: antenna port 1

a	26 dB bandwidth / 20 dB bandwidth (U-NII-3 only) [MHz]		
	U-NII-1 (5150 MHz to 5250 MHz)		
	Lowest channel	Middle channel	Highest channel
	19.3	19.5	19.3
	U-NII-3 (5725 MHz to 5850 MHz)		
	Lowest channel	Middle channel	Highest channel
	17.8	17.7	17.7

Results: antenna port 1

n/ac HT20	26 dB bandwidth / 20 dB bandwidth (U-NII-3 only) [MHz]		
	U-NII-1 (5150 MHz to 5250 MHz)		
	Lowest channel	Middle channel	Highest channel
	21.4	21.5	21.7
	U-NII-3 (5725 MHz to 5850 MHz)		
	Lowest channel	Middle channel	Highest channel
	19.0	18.9	19.0

Results: antenna port 1

n/ac HT40	26 dB bandwidth / 20 dB bandwidth (U-NII-3 only) [MHz]		
	U-NII-1 (5150 MHz to 5250 MHz)		
	Lowest channel	Highest channel	
	42.6	42.6	
	U-NII-3 (5725 MHz to 5850 MHz)		
	Lowest channel	Highest channel	
	39.9	40.1	

Results: antenna port 1

ac VHT80	26 dB bandwidth / 20 dB bandwidth (U-NII-3 only) [MHz]		
	U-NII-1 (5150 MHz to 5250 MHz)		
	Middle channel		
	84.4		
	U-NII-3 (5725 MHz to 5850 MHz)		
	Middle channel		
	80.8		

Results: antenna port 2

a	26 dB bandwidth / 20 dB bandwidth (U-NII-3 only) [MHz]		
	U-NII-1 (5150 MHz to 5250 MHz)		
	Lowest channel	Middle channel	Highest channel
	19.0	19.0	18.9
	U-NII-3 (5725 MHz to 5850 MHz)		
	Lowest channel	Middle channel	Highest channel
	17.6	17.7	17.6

Results: antenna port 2

n/ac HT20	26 dB bandwidth / 20 dB bandwidth (U-NII-3 only) [MHz]		
	U-NII-1 (5150 MHz to 5250 MHz)		
	Lowest channel	Middle channel	Highest channel
	22.6	23.2	22.0
	U-NII-3 (5725 MHz to 5850 MHz)		
	Lowest channel	Middle channel	Highest channel
	19.2	19.1	19.0

Results: antenna port 2

n/ac HT40	26 dB bandwidth / 20 dB bandwidth (U-NII-3 only) [MHz]	
	U-NII-1 (5150 MHz to 5250 MHz)	
	Lowest channel	Highest channel
	42.6	41.9
	U-NII-3 (5725 MHz to 5850 MHz)	
	Lowest channel	Highest channel
	39.2	39.3

Results: antenna port 2

ac VHT80	26 dB bandwidth / 20 dB bandwidth (U-NII-3 only) [MHz]	
	U-NII-1 (5150 MHz to 5250 MHz)	
	Middle channel	
	84.6	
	U-NII-3 (5725 MHz to 5850 MHz)	
	Middle channel	
	80.6	

12.8 Occupied bandwidth / 99% emission bandwidth

Description:

Measurement of the 99% bandwidth of the modulated signal acc. RSS-GEN.

Measurement:

Measurement parameter	
External result file(s)	1-6579_23-01-08_TR1-A201.pdf FCC Part 15.407 & ISED Bandwidths
Test setup:	See sub clause 7.4 – A
Measurement uncertainty:	See chapter 9

Usage:

-/-	ISED
OBW is necessary for Emission Designator	

Results: antenna port 1

a	99% bandwidth (kHz)		
	U-NII-1 (5150 MHz to 5250 MHz)		
	Lowest channel	Middle channel	Highest channel
	16334	16284	16334
	U-NII-3 (5725 MHz to 5850 MHz)		
	Lowest channel	Middle channel	Highest channel
16334	16284	16284	

Results: antenna port 1

n/ac HT20	99% bandwidth (kHz)		
	U-NII-1 (5150 MHz to 5250 MHz)		
	Lowest channel	Middle channel	Highest channel
	16833	16783	16733
	U-NII-3 (5725 MHz to 5850 MHz)		
	Lowest channel	Middle channel	Highest channel
16783	16783	16733	

Results: antenna port 1

n/ac HT40	99% bandwidth (kHz)	
	U-NII-1 (5150 MHz to 5250 MHz)	
	Lowest channel	Highest channel
	36663	36663
	U-NII-3 (5725 MHz to 5850 MHz)	
	Lowest channel	Highest channel
36663	36663	

Results: antenna port 1

ac VHT80	99% bandwidth (kHz)	
	U-NII-1 (5150 MHz to 5250 MHz)	
	Middle channel	
	76324	
	U-NII-3 (5725 MHz to 5850 MHz)	
	Middle channel	
76324		

Results: antenna port 2

a	99% bandwidth (kHz)		
	U-NII-1 (5150 MHz to 5250 MHz)		
	Lowest channel	Middle channel	Highest channel
	16334	16284	16334
	U-NII-3 (5725 MHz to 5850 MHz)		
	Lowest channel	Middle channel	Highest channel
16334	16284	16334	

Results: antenna port 2

n/ac HT20	99% bandwidth (kHz)		
	U-NII-1 (5150 MHz to 5250 MHz)		
	Lowest channel	Middle channel	Highest channel
	16783	16783	16783
	U-NII-3 (5725 MHz to 5850 MHz)		
	Lowest channel	Middle channel	Highest channel
16833	16783	16783	

Results: antenna port 2

n/ac HT40	99% bandwidth (kHz)	
	U-NII-1 (5150 MHz to 5250 MHz)	
	Lowest channel	Highest channel
	36663	36663
	U-NII-3 (5725 MHz to 5850 MHz)	
	Lowest channel	Highest channel
36663	36663	

Results: antenna port 2

ac VHT80	99% bandwidth (kHz)	
	U-NII-1 (5150 MHz to 5250 MHz)	
	Middle channel	
	76523	
	U-NII-3 (5725 MHz to 5850 MHz)	
	Middle channel	
76324		

12.9 Undesirable emissions for transmitters operating in the 5725 MHz to 5850 MHz band (conducted)

Description:

Measurement of the spectrum mask as per FCC Part 15.407 (b)(4) and KDB 789033 II.G.2 (c) (ii). The measurement is repeated at the lowest, middle and highest channel and performed in a conducted way as defined in KDB 789033 II.G.3 (b).

The highest antenna gain is considered and was added to the Reference Level Offset. Emission levels are further adjusted to consider the number of antenna outputs (2).

Measurement:

Measurement parameter	
Detector:	Peak
Sweep time:	Auto
Resolution bandwidth:	1 MHz
Video bandwidth:	$\geq 3 \times \text{RBW}$
Span:	See plots!
Trace mode:	Max Hold
Test setup:	See sub clause 7.4 – A
Measurement uncertainty:	See chapter 9

Limits:

FCC Part 15.407 (b)(4)
All emissions shall be limited to a level of -27 dBm/MHz at 75 MHz or more above or below the band edge increasing linearly to 10 dBm/MHz at 25 MHz above or below the band edge, and from 25 MHz above or below the band edge increasing linearly to a level of 15.6 dBm/MHz at 5 MHz above or below the band edge, and from 5 MHz above or below the band edge increasing linearly to a level of 27 dBm/MHz at the band edge.

Result: Compliant (See log file)

12.10 Band edge compliance radiated

Description:

Measurement of the radiated band edge compliance. The EUT is turned in the position that results in the maximum level at the band edge. Then a sweep over the corresponding restricted band is performed. The EUT is set to the lowest channel for the lower restricted band and to the highest channel for the upper restricted band. Measurement distance is 3m.

Measurement:

Measurement parameter	
Detector:	Peak / RMS
Sweep time:	Auto
Resolution bandwidth:	1 MHz
Video bandwidth:	$\geq 3 \times \text{RBW}$
Span:	See plots!
Trace mode:	Max Hold
Test setup:	See sub clause 7.2 – A
Measurement uncertainty:	See chapter 9

Limits:

Band Edge Compliance Radiated
In any 100 kHz bandwidth outside the frequency band in which the spread spectrum or digitally modulated intentional radiator is operating, the radio frequency power that is produced by the intentional radiator shall be at least 20 dB below that in the 100 kHz bandwidth within the band that contains the highest level of the desired power, based on either an RF conducted or a radiated measurement. Attenuation below the general limits specified in Section 15.209(a) is not required. In addition, radiated emissions which fall in the restricted bands, as defined in Section 15.205(a), must also comply with the radiated emission limits specified in Section 15.209(a) (see Section 5.205(c)).
74 dB μ V/m (peak) 54 dB μ V/m (average)

Result:

Scenario	Band Edge Compliance Radiated [dB μ V/m]
band edge	< 74 dB μ V/m (peak) < 54 dB μ V/m (average)

Plots:

Plot 1: lower band edge; U-NII-1; lowest channel; 20 MHz channel bandwidth

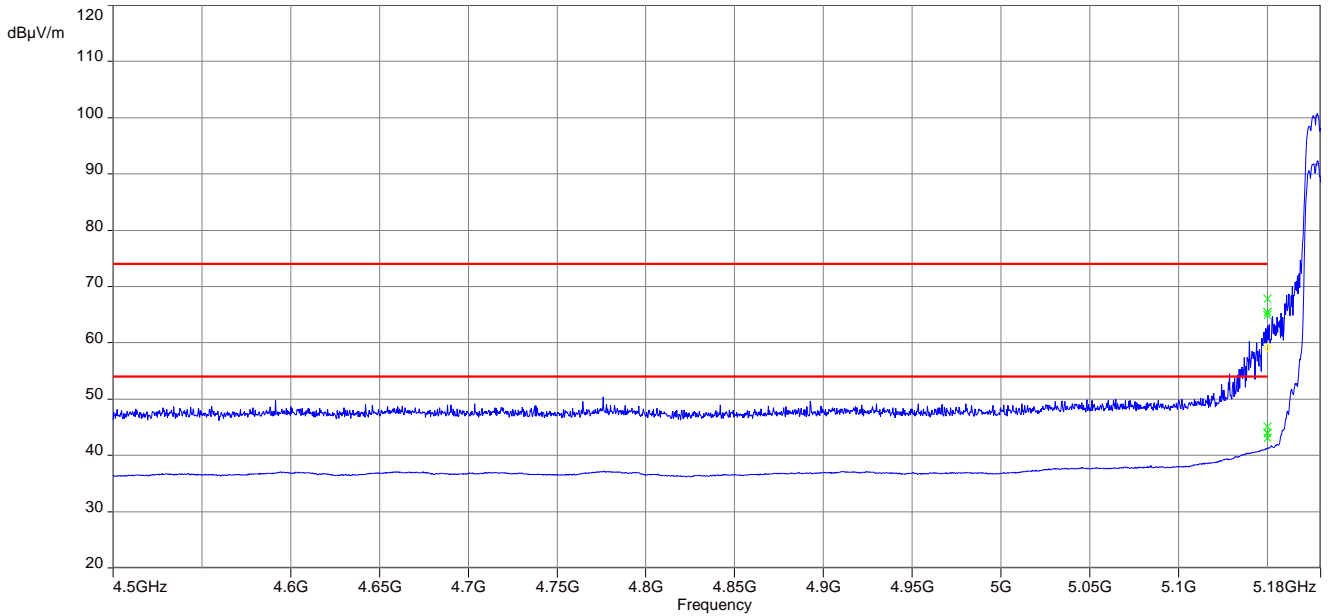

Plot 2: lower band edge; U-NII-1; lowest channel; 40 MHz channel bandwidth

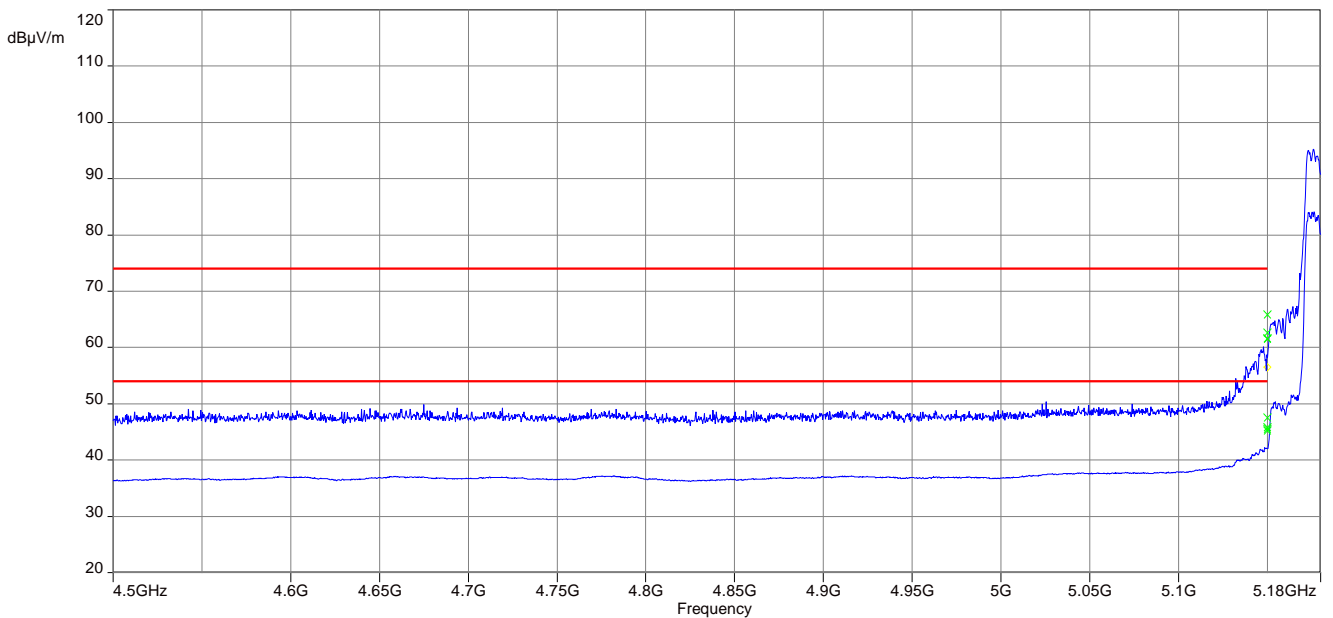

Plot 3: lower band edge; U-NII-1; middle channel; 80 MHz channel bandwidth

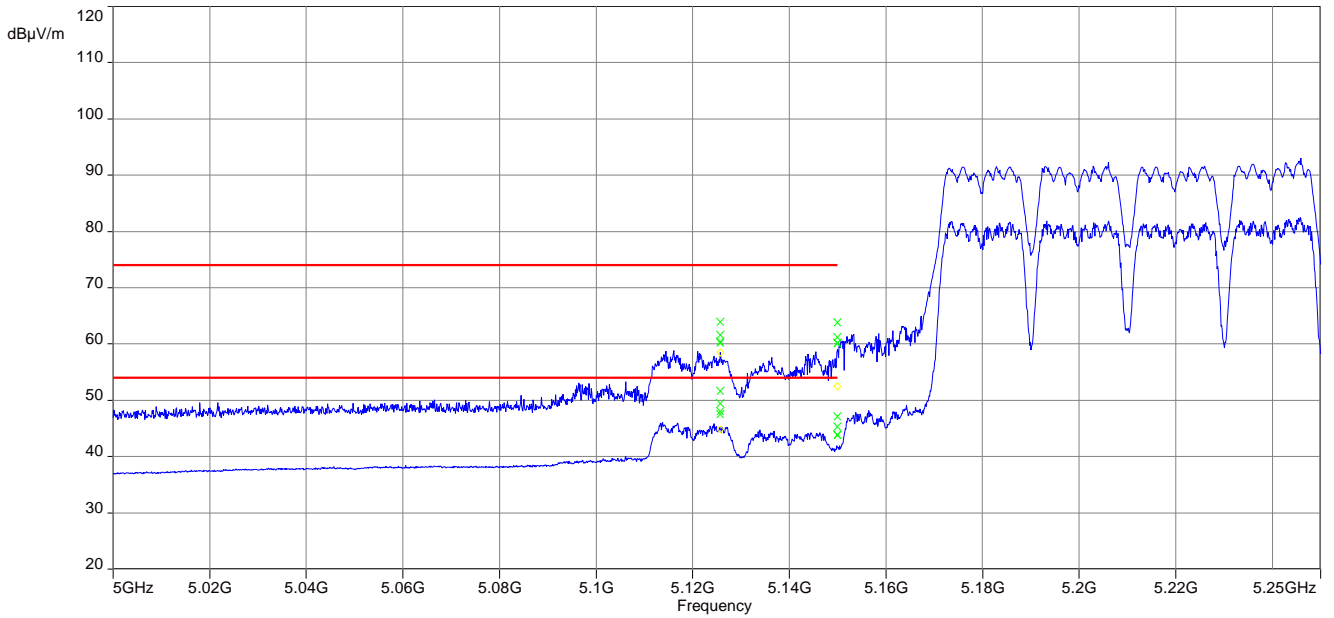

12.11 Spurious emissions radiated below 30 MHz

Description:

Measurement of the radiated spurious emissions in transmit mode below 30 MHz. The limits are re-calculated to a measurement distance of 3 m with 40 dB/decade according CFR Part 2.

Measurement:

Measurement parameter	
Detector:	Peak / Quasi Peak
Sweep time:	Auto
Video bandwidth:	F < 150 kHz: 200 Hz F > 150 kHz: 9 kHz
Resolution bandwidth:	F < 150 kHz: 1 kHz F > 150 kHz: 100 kHz
Span:	9 kHz to 30 MHz
Trace mode:	Max Hold
Test setup:	See sub clause 7.2 – C
Measurement uncertainty:	See chapter 9

Limits:

Spurious Emissions Radiated < 30 MHz		
Frequency (MHz)	Field Strength (dBµV/m)	Measurement distance
0.009 – 0.490	2400/F(kHz)	300
0.490 – 1.705	24000/F(kHz)	30
1.705 – 30.0	30	30

Results:

Spurious Emissions Radiated < 30 MHz [dBµV/m]		
F [MHz]	Detector	Level [dBµV/m]
All detected emissions are more than 20 dB below the limit.		

Plots: 20 MHz channel bandwidth

Plot 1: 9 kHz to 30 MHz, U-NII-1; lowest channel

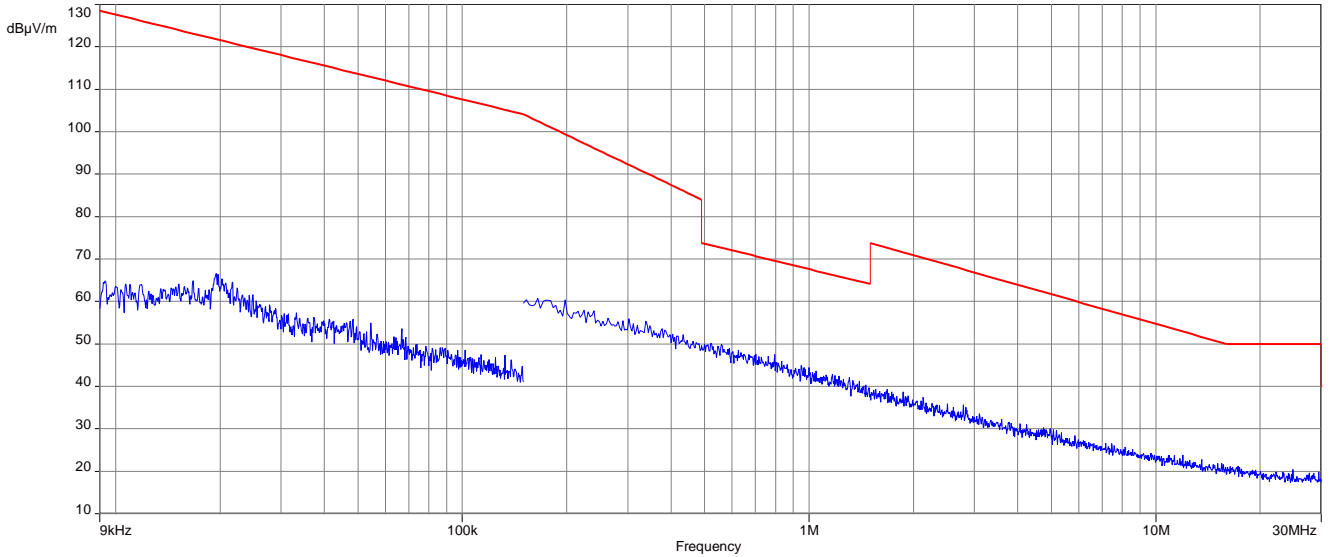

Plot 2: 9 kHz to 30 MHz, U-NII-1; middle channel

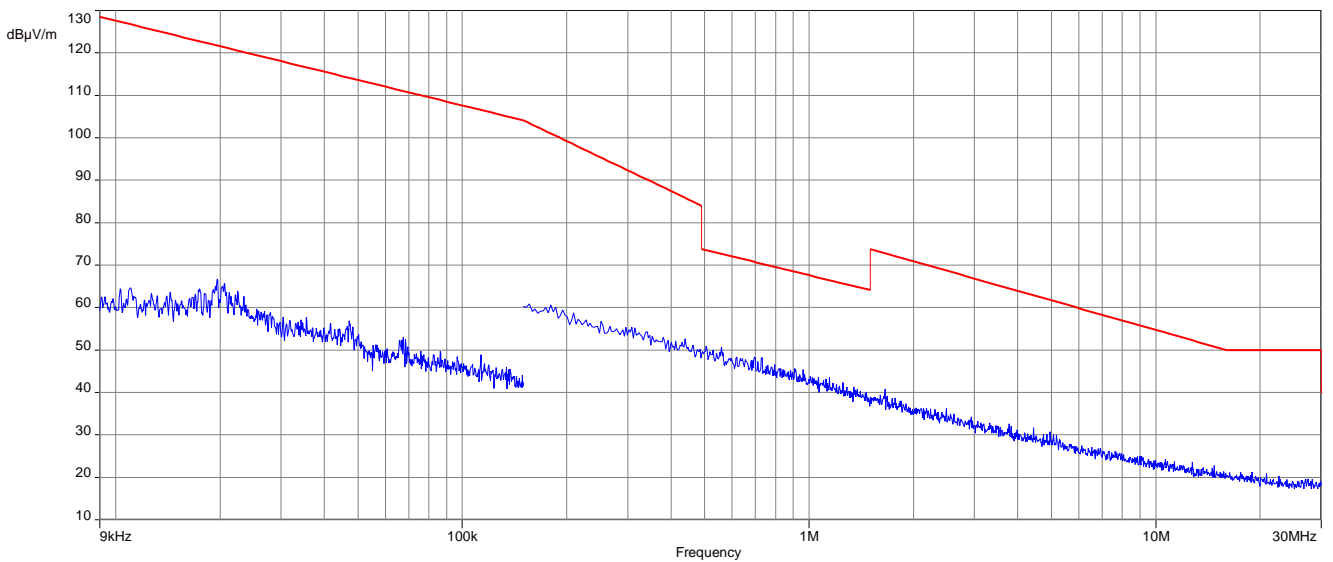

Plot 3: 9 kHz to 30 MHz, U-NII-1; highest channel

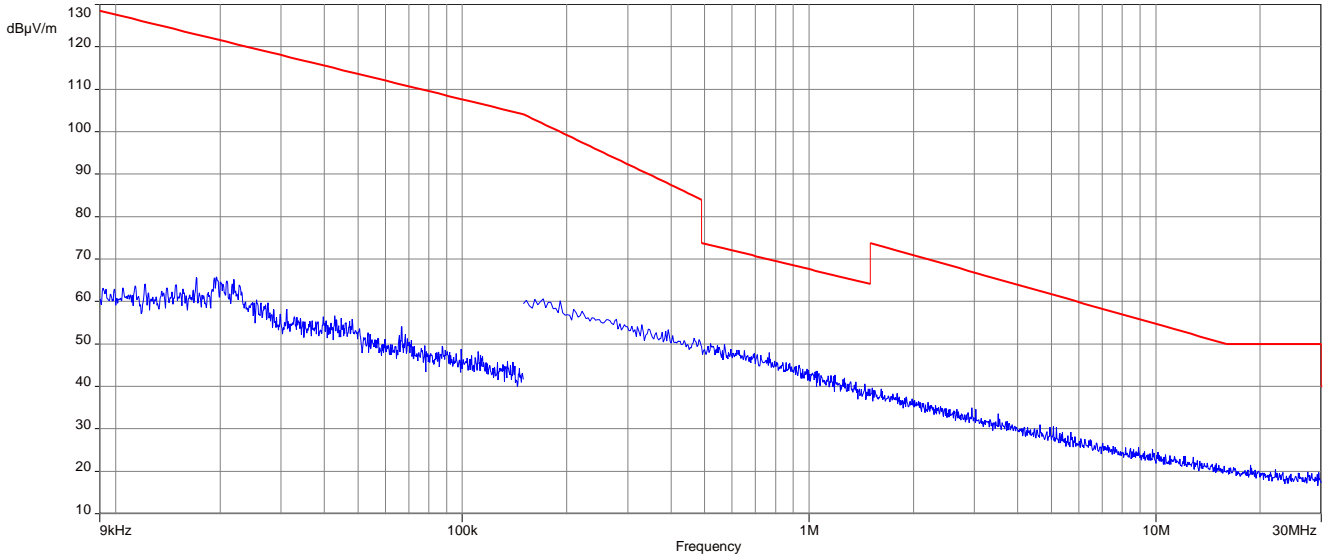

Plot 4: 9 kHz to 30 MHz, U-NII-3; lowest channel

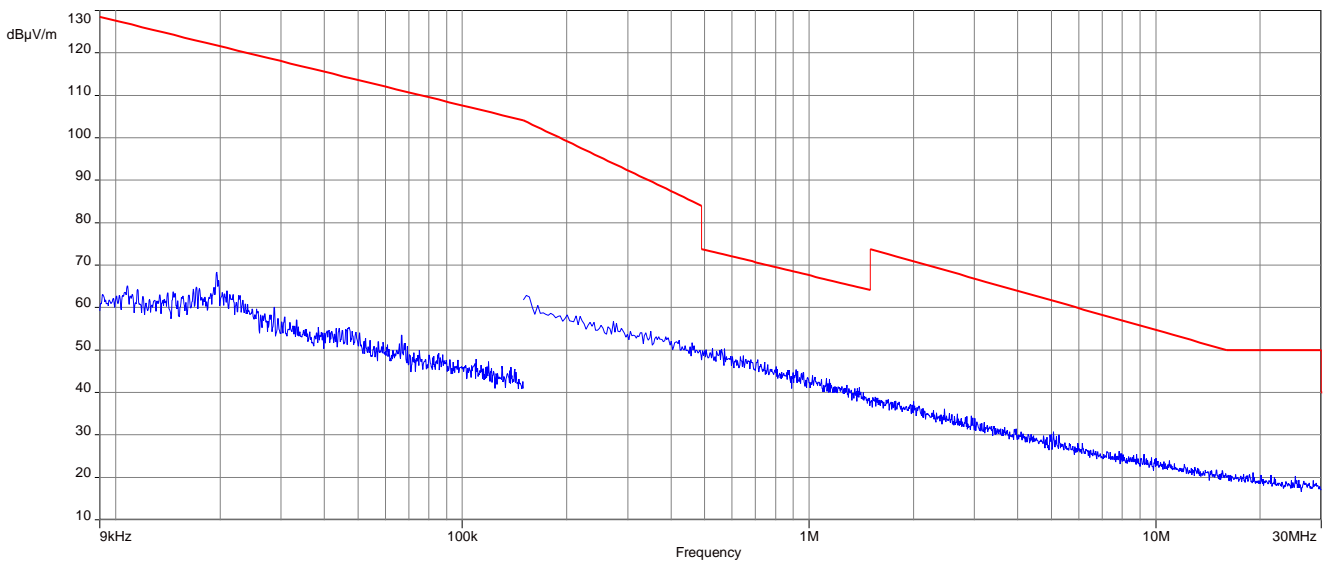

Plot 5: 9 kHz to 30 MHz, U-NII-3; middle channel

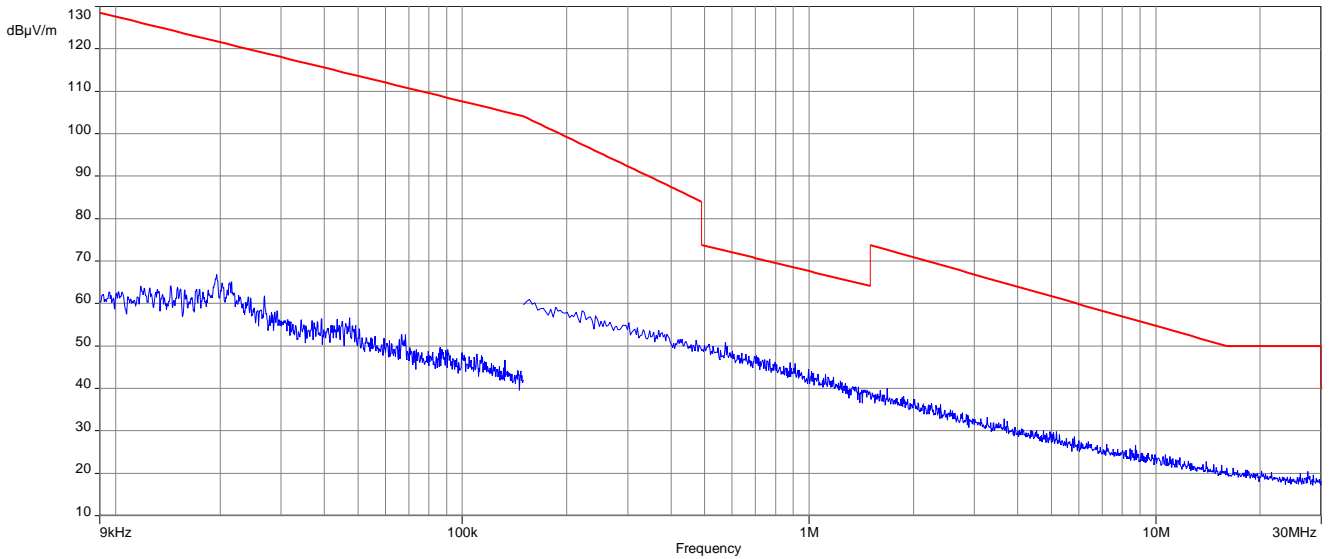

Plot 6: 9 kHz to 30 MHz, U-NII-3; highest channel

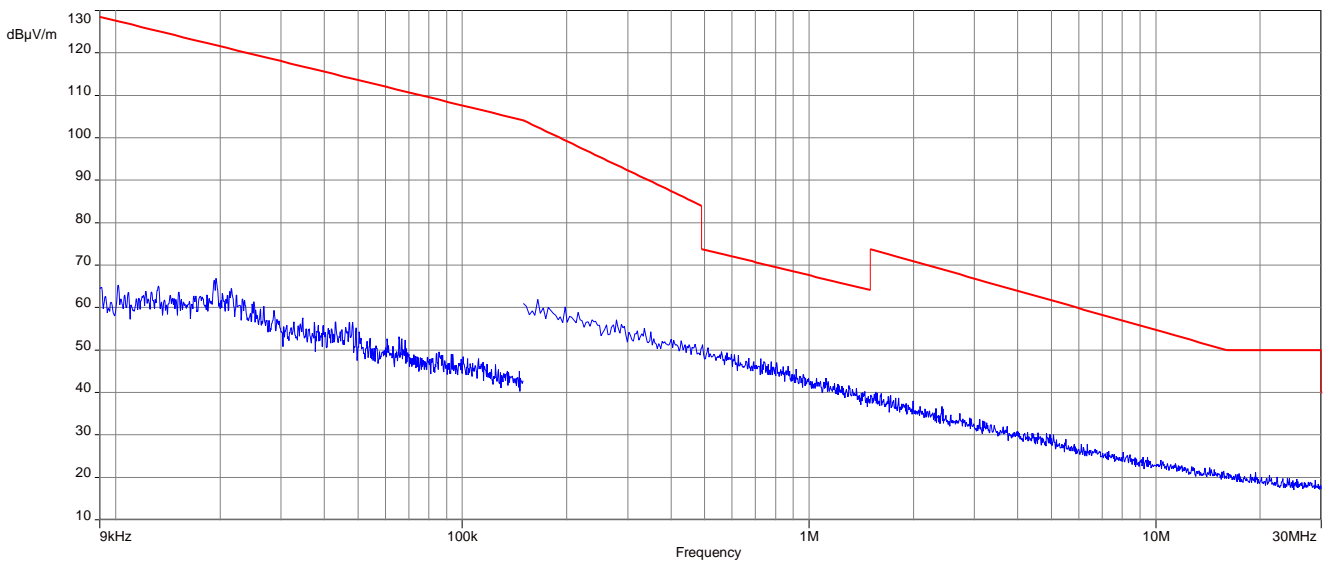

Plots: 40 MHz channel bandwidth

Plot 1: 9 kHz to 30 MHz, U-NII-1; lowest channel

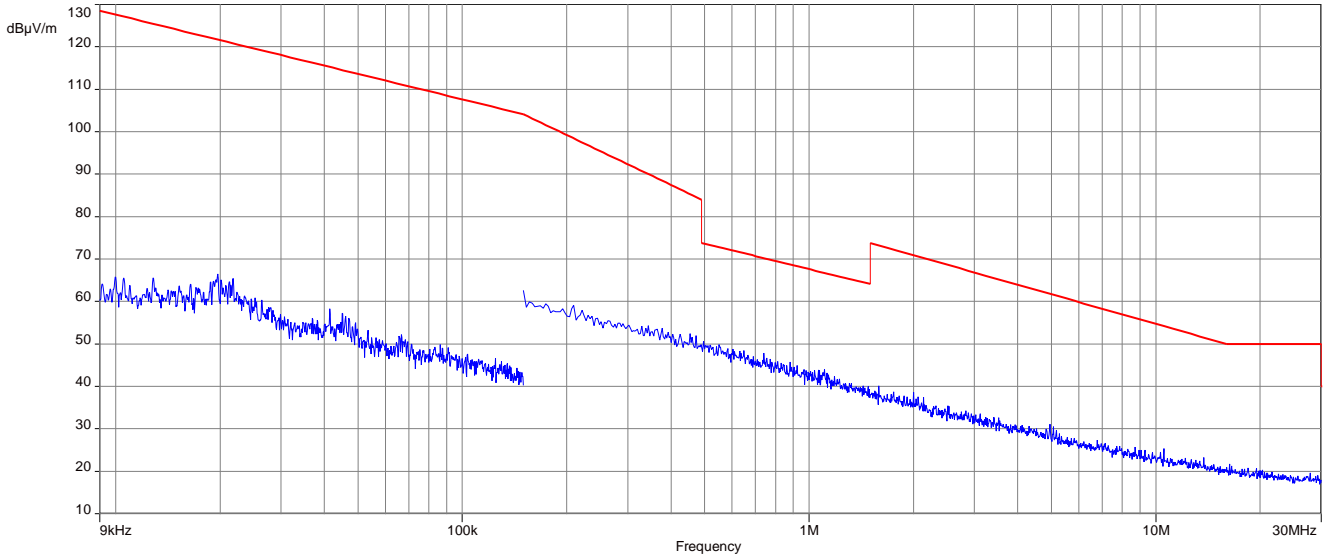

Plot 2: 9 kHz to 30 MHz, U-NII-1; highest channel

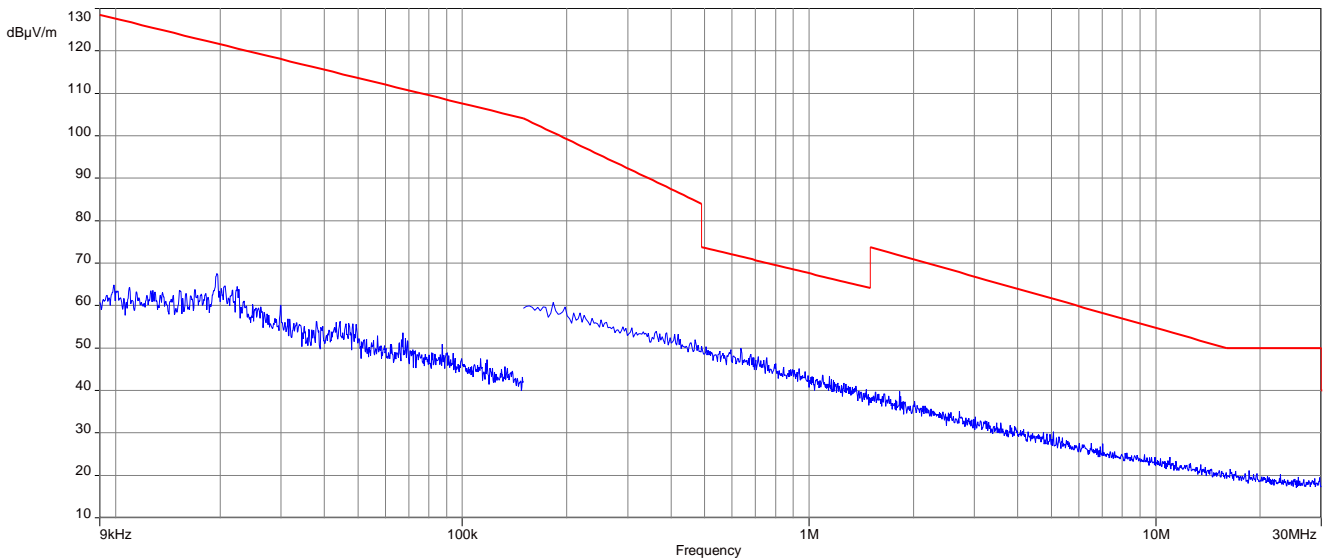

Plot 3: 9 kHz to 30 MHz, U-NII-3; lowest channel

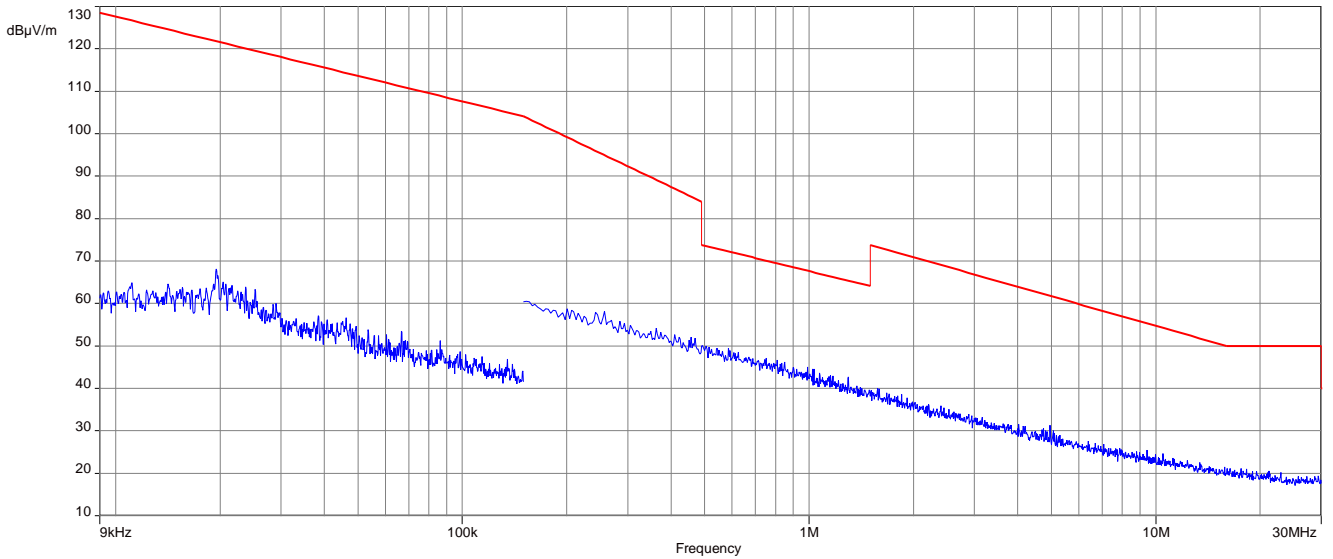

Plot 4: 9 kHz to 30 MHz, U-NII-3; highest channel

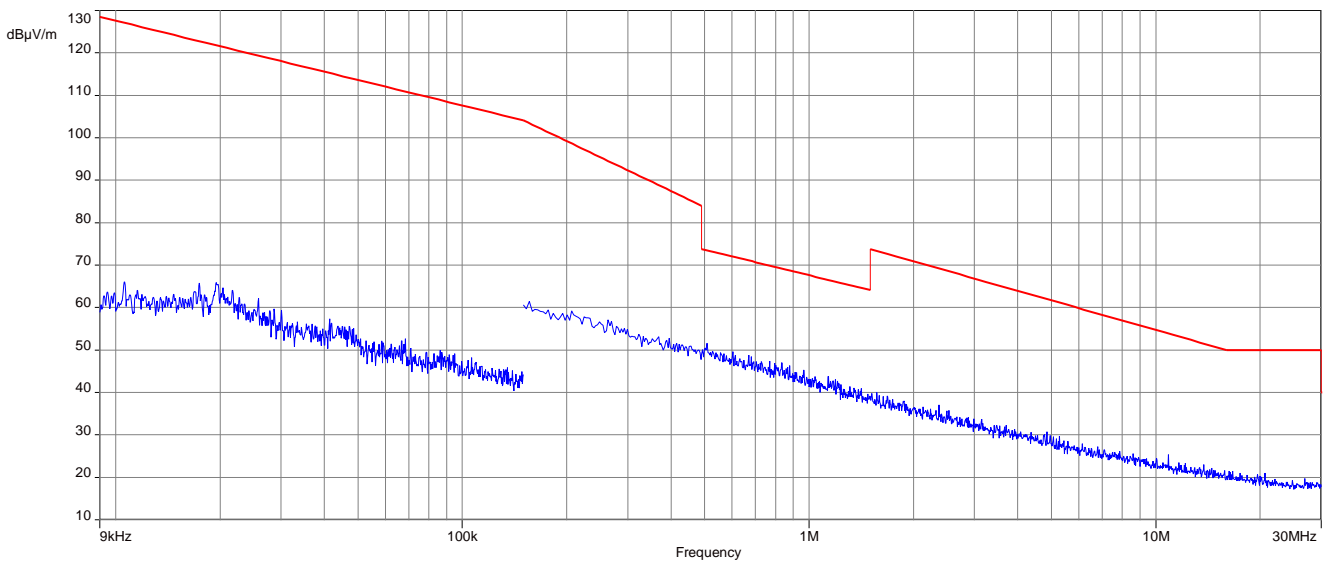

Plots: 80 MHz channel bandwidth

Plot 1: 9 kHz to 30 MHz, U-NII-1; middle channel

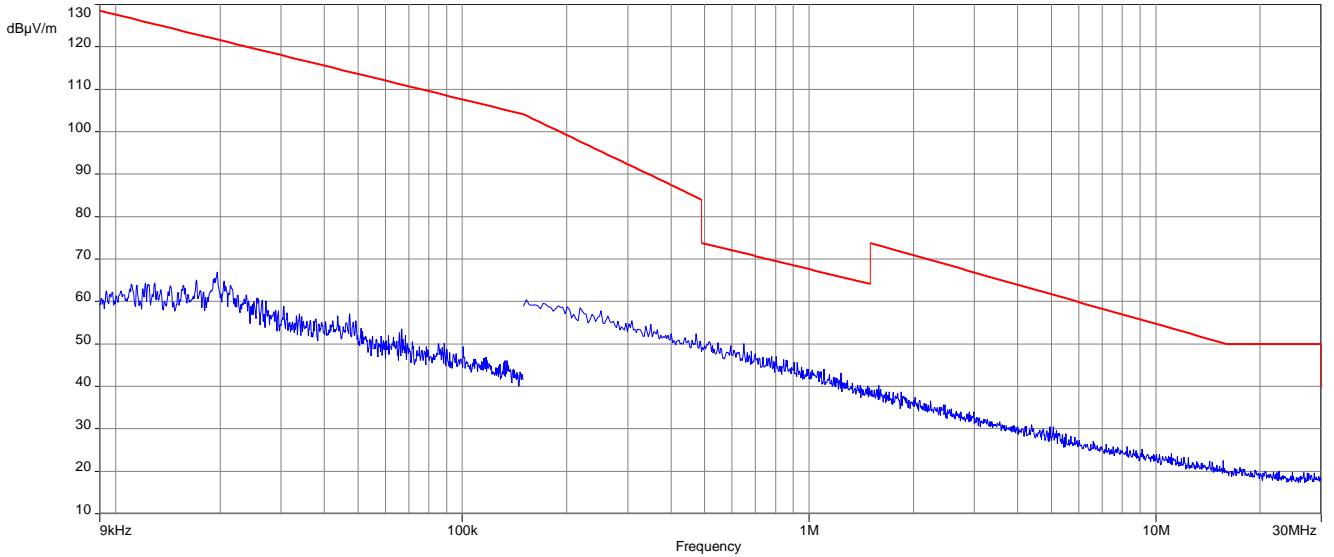

Plot 2: 9 kHz to 30 MHz, U-NII-3; middle channel

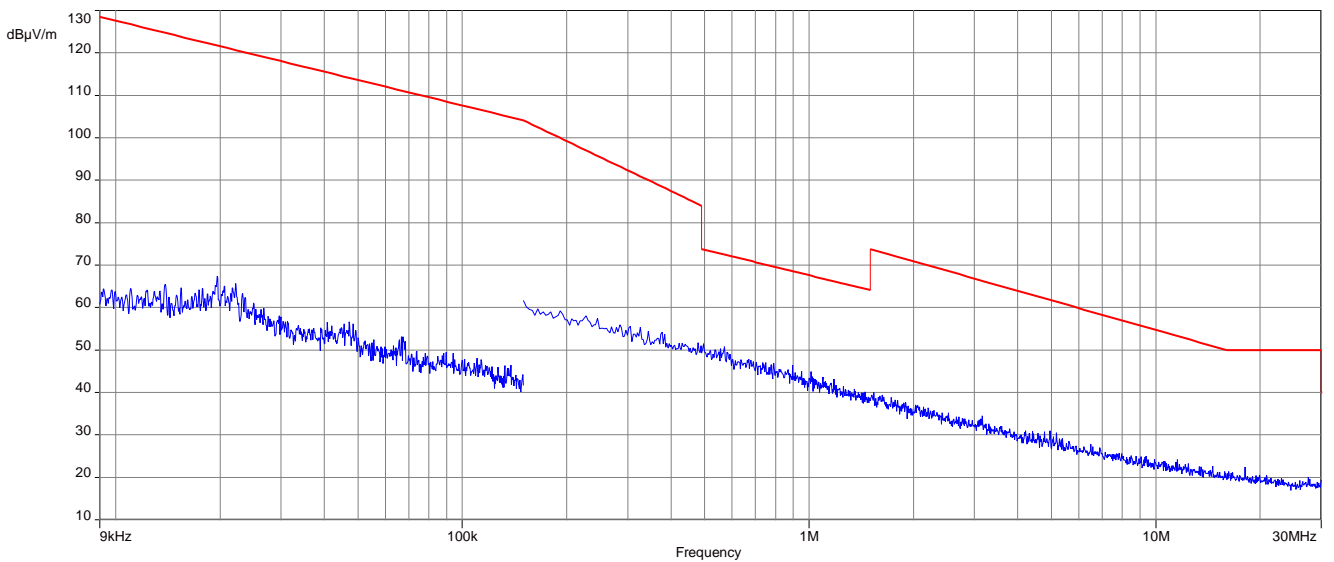

12.12 Spurious emissions radiated 30 MHz to 1 GHz

Measurement:

Measurement parameter	
Detector:	Quasi Peak
Sweep time:	Auto
Resolution bandwidth:	120 kHz
Video bandwidth:	500 kHz
Span:	30 MHz to 1 GHz
Test setup:	See sub clause 7.1 – A
Measurement uncertainty:	See chapter 9

Limits:

TX Spurious Emissions Radiated		
§15.209 / RSS-247		
Frequency (MHz)	Field Strength (dB μ V/m)	Measurement distance
30 - 88	30.0	10
88 – 216	33.5	10
216 – 960	36.0	10
Above 960	54.0	3

Plots: 20 MHz channel bandwidth

Plot 1: 30 MHz to 1 GHz; vertical & horizontal polarization; U-NII-1; valid for all channels and modes

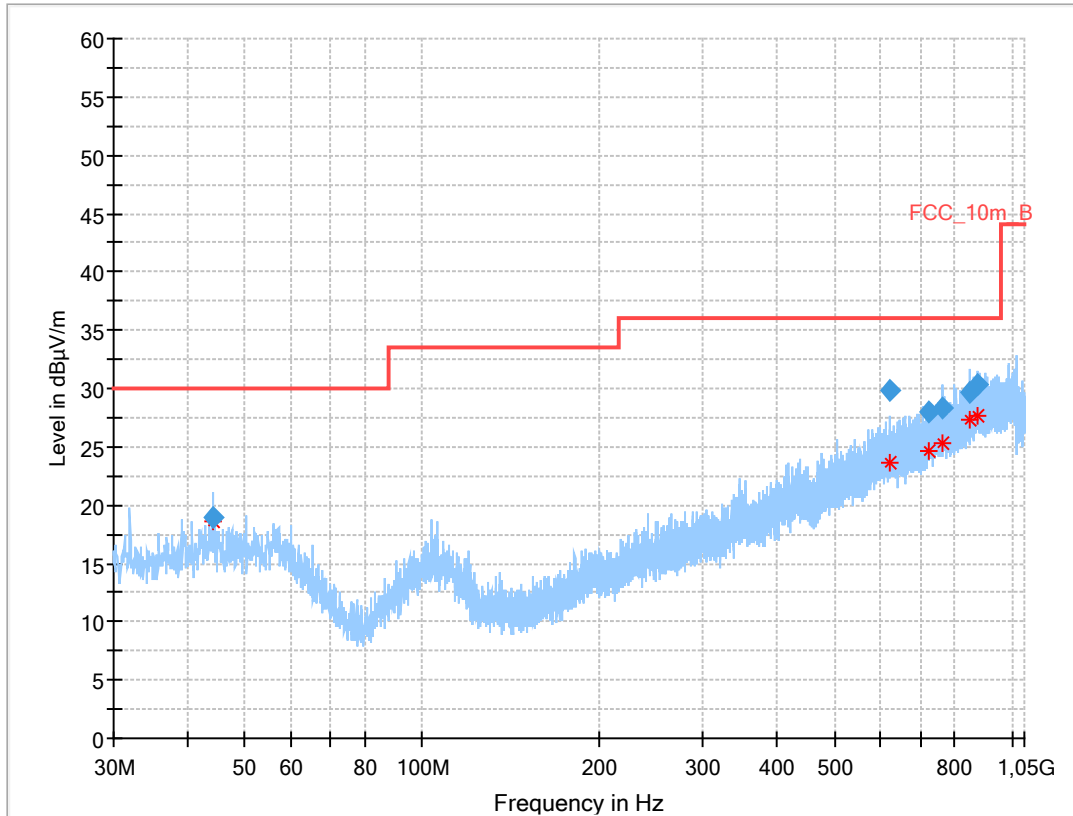

Results:

Frequency (MHz)	QuasiPeak (dBµV/m)	Limit (dBµV/m)	Margin (dB)	Meas. Time (ms)	Bandwidth (kHz)	Height (cm)	Pol	Azimuth (deg)	Corr. (dB)
44.230	18.99	30.0	11.0	1000	120.0	107.0	V	105	15
622.983	29.81	36.0	6.2	1000	120.0	195.0	V	52	22
720.906	27.98	36.0	8.0	1000	120.0	174.0	V	142	23
762.382	28.37	36.0	7.6	1000	120.0	195.0	V	52	24
845.778	29.63	36.0	6.4	1000	120.0	114.0	H	188	25
874.291	30.35	36.0	5.7	1000	120.0	140.0	H	142	25

Plot 2: 30 MHz to 1 GHz; vertical & horizontal polarization; U-NII-3; valid for all channels and modes

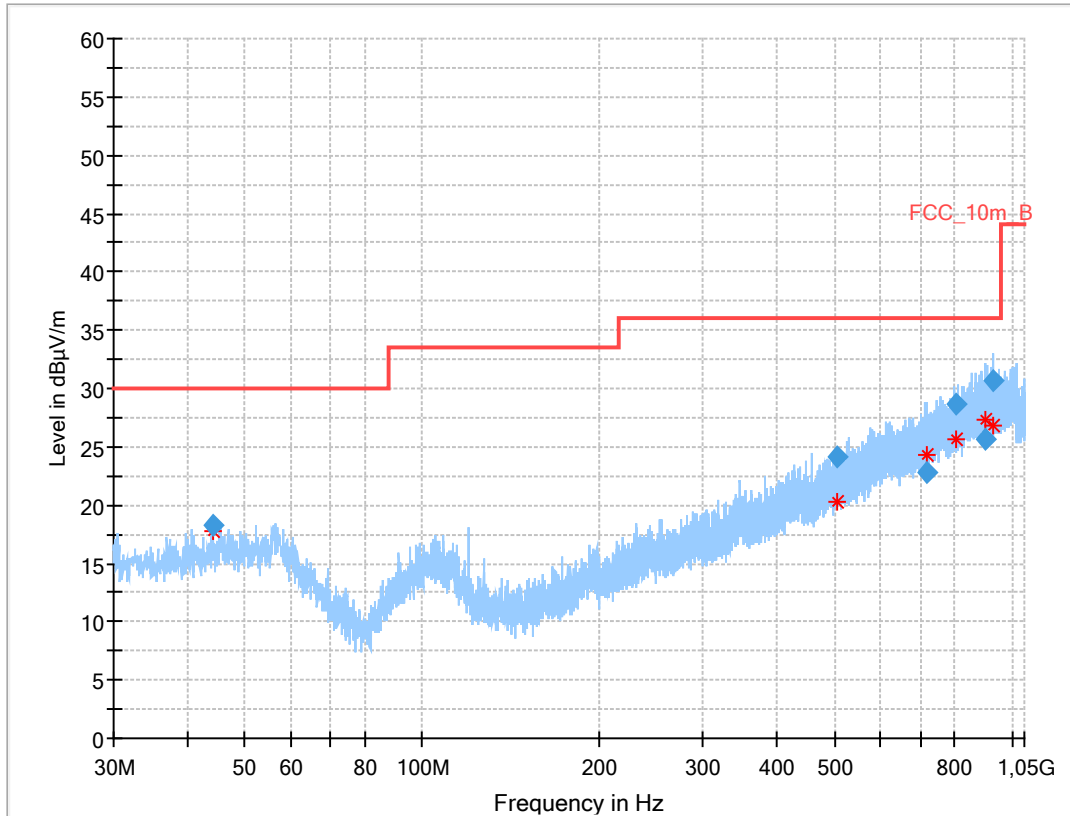

Results:

Frequency (MHz)	QuasiPeak (dBµV/m)	Limit (dBµV/m)	Margin (dB)	Meas. Time (ms)	Bandwidth (kHz)	Height (cm)	Pol	Azimuth (deg)	Corr. (dB)
44.218	18.21	30.0	11.8	1000	120.0	131.0	V	77	15
505.332	24.15	36.0	11.9	1000	120.0	195.0	V	142	20
718.093	22.84	36.0	13.2	1000	120.0	169.0	V	52	23
807.318	28.64	36.0	7.4	1000	120.0	182.0	H	232	24
900.357	25.66	36.0	10.3	1000	120.0	102.0	V	-22	25
930.600	30.71	36.0	5.3	1000	120.0	195.0	H	142	26

12.13 Spurious emissions radiated 1 GHz to 40 GHz

Description:

Measurement of the radiated spurious emissions and cabinet radiations from 1 GHz to 40 GHz.

Measurement:

Measurement parameter	
Detector:	Quasi Peak below 1 GHz (alternative Peak) Peak above 1 GHz / RMS
Sweep time:	Auto
Resolution bandwidth:	1 MHz
Video bandwidth:	3 MHz
Span:	1 GHz to 40 GHz
Test setup:	See sub clause 7.2 – B See sub clause 7.3 – A
Measurement uncertainty:	See chapter 9

Limits:

TX Spurious Emissions Radiated		
§15.209 / RSS-247		
Frequency (MHz)	Field Strength (dB μ V/m)	Measurement distance
Above 960	54.0	3
§15.407		
Outside the restricted bands!	-27 dBm / MHz	

NOTE: The carrier signal is notched by a band rejection filter during tests. All emissions are more than 20 dB below the limits.

Results: 20 MHz channel bandwidth

TX Spurious Emissions Radiated [dBµV/m] / dBm								
U-NII-1 (5150 MHz to 5250 MHz)								
Lowest channel			Middle channel			Highest channel		
F [MHz]	Detector	Level [dBµV/m]	F [MHz]	Detector	Level [dBµV/m]	F [MHz]	Detector	Level [dBµV/m]
-/-	Peak	-/-	-/-	Peak	-/-	-/-	Peak	-/-
	AVG	-/-	-/-	AVG	-/-		AVG	-/-

TX Spurious Emissions Radiated [dBµV/m] / dBm								
U-NII-3 (5725 MHz to 5850 MHz)								
Lowest channel			Middle channel			Highest channel		
F [MHz]	Detector	Level [dBµV/m]	F [MHz]	Detector	Level [dBµV/m]	F [MHz]	Detector	Level [dBµV/m]
-/-	Peak	-/-	-/-	Peak	-/-	-/-	Peak	-/-
	AVG	-/-	-/-	AVG	-/-		AVG	-/-

Results: 40 MHz channel bandwidth

TX Spurious Emissions Radiated [dBµV/m] / dBm								
U-NII-1 (5150 MHz to 5250 MHz)								
Lowest channel			Middle channel			Highest channel		
F [MHz]	Detector	Level [dBµV/m]	F [MHz]	Detector	Level [dBµV/m]	F [MHz]	Detector	Level [dBµV/m]
-/-	Peak	-/-	-/-	Peak	-/-	-/-	Peak	-/-
	AVG	-/-	-/-	AVG	-/-		AVG	-/-

TX Spurious Emissions Radiated [dBµV/m] / dBm								
U-NII-3 (5725 MHz to 5850 MHz)								
Lowest channel			Middle channel			Highest channel		
F [MHz]	Detector	Level [dBµV/m]	F [MHz]	Detector	Level [dBµV/m]	F [MHz]	Detector	Level [dBµV/m]
-/-	Peak	-/-	-/-	Peak	-/-	-/-	Peak	-/-
	AVG	-/-	-/-	AVG	-/-		AVG	-/-

Results: 80 MHz channel bandwidth

TX Spurious Emissions Radiated [dB μ V/m] / dBm		
U-NII-1 (5150 MHz to 5250 MHz)		
Middle channel		
F [MHz]	Detector	Level [dB μ V/m]
-/-	Peak	-/-
	AVG	-/-

TX Spurious Emissions Radiated [dB μ V/m] / dBm		
U-NII-3 (5725 MHz to 5850 MHz)		
Middle channel		
F [MHz]	Detector	Level [dB μ V/m]
-/-	Peak	-/-
	AVG	-/-

Plots: 20 MHz channel bandwidth

Plot 1: 1 GHz to 18 GHz; vertical & horizontal polarization; U-NII-1; lowest channel

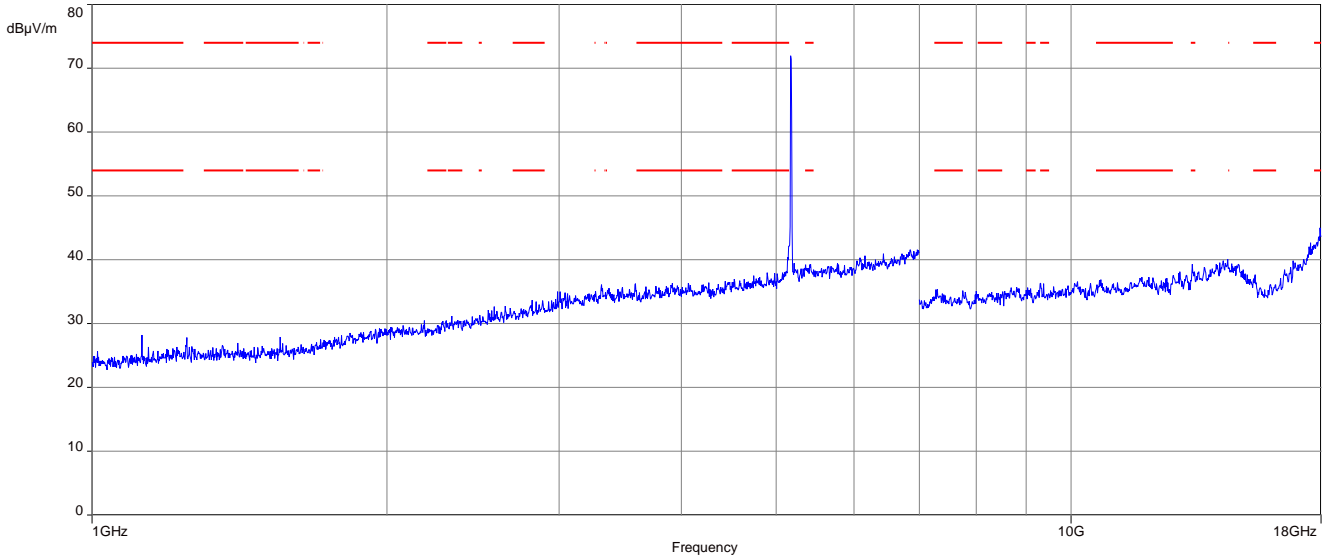

Plot 2: 1 GHz to 18 GHz; vertical & horizontal polarization; U-NII-1; middle channel

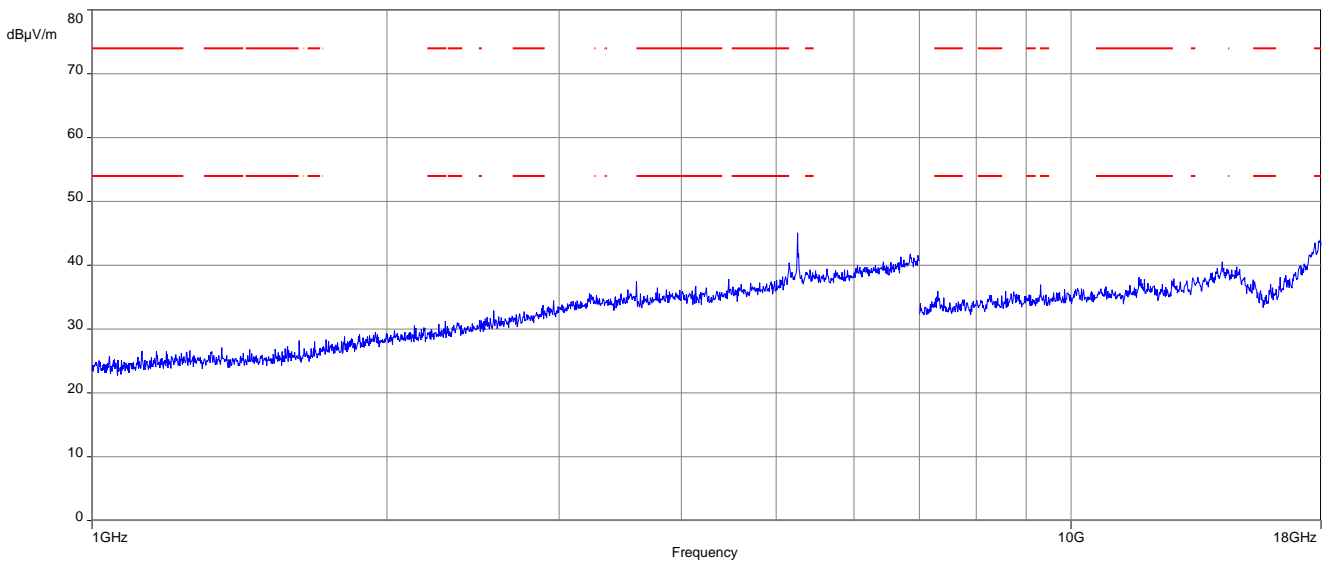

Plot 3: 1 GHz to 18 GHz; vertical & horizontal polarization; U-NII-1; highest channel

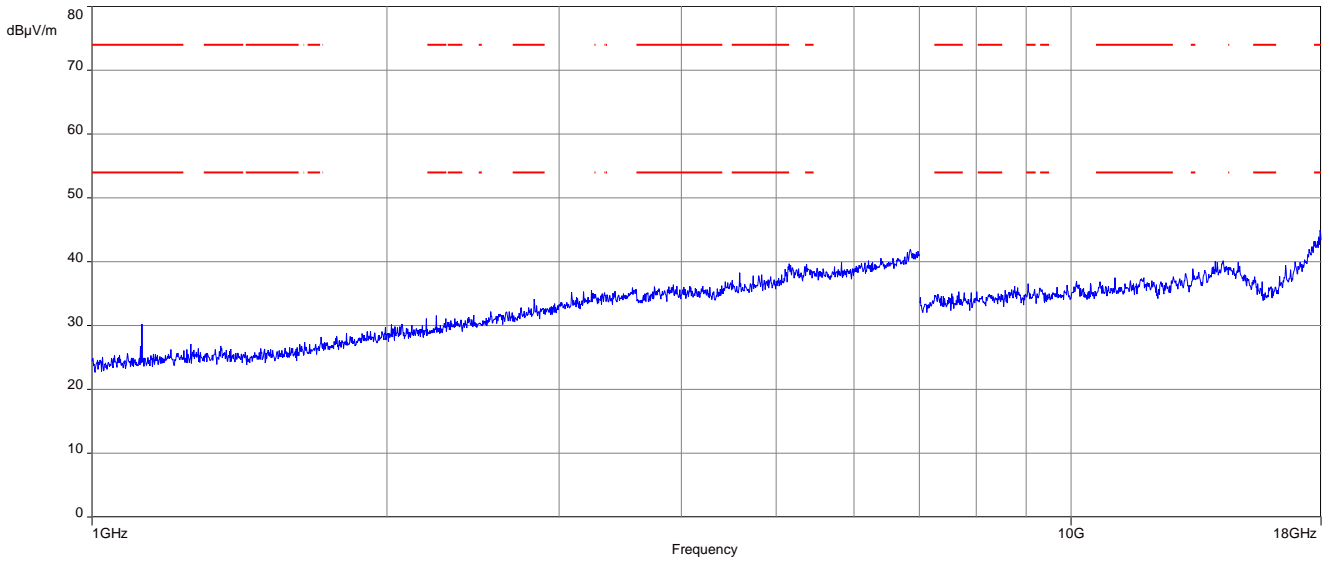

Plot 4: 1 GHz to 18 GHz; vertical & horizontal polarization; U-NII-3; lowest channel

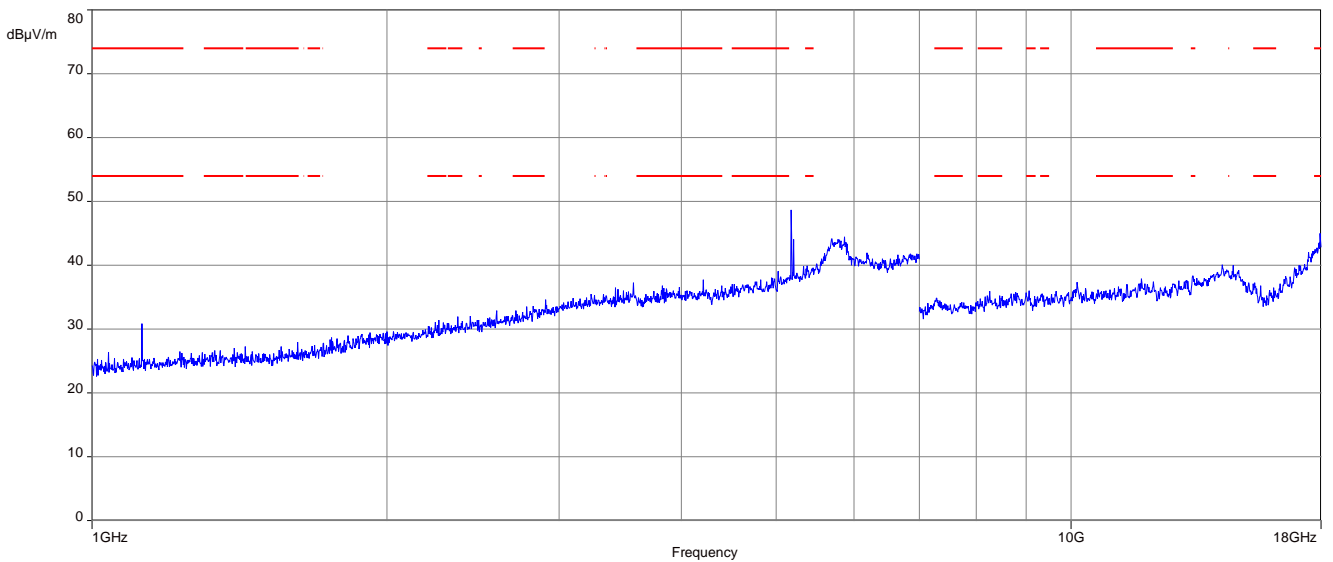

Plot 5: 1 GHz to 18 GHz; vertical & horizontal polarization; U-NII-3; middle channel

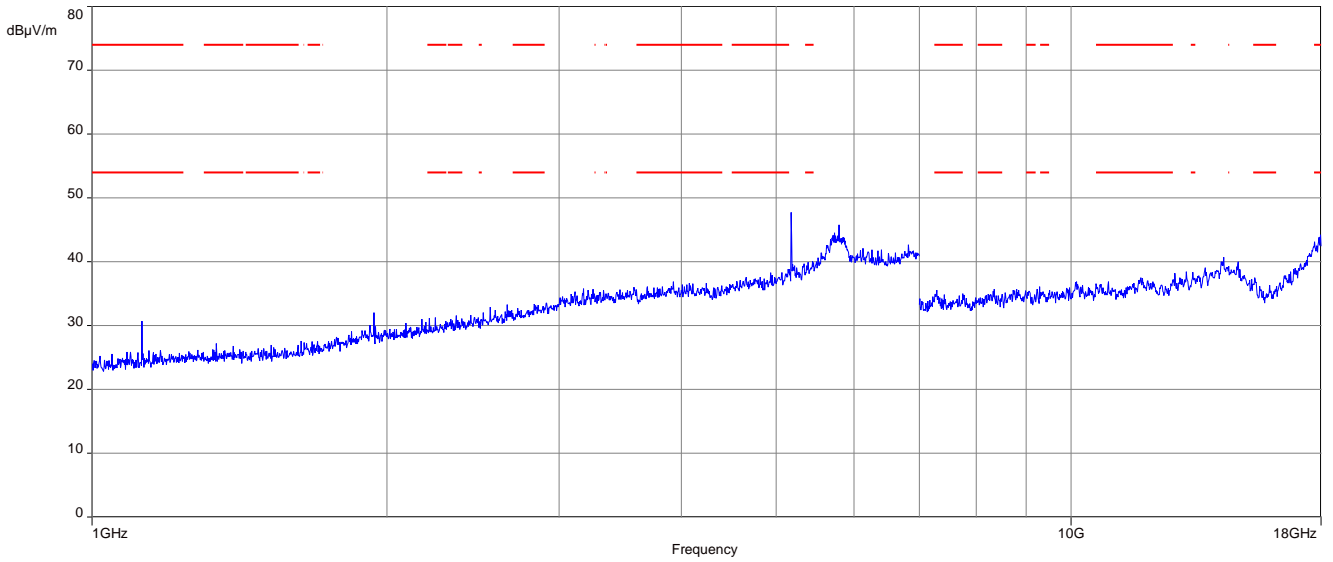

Plot 6: 1 GHz to 18 GHz; vertical & horizontal polarization; U-NII-3; highest channel

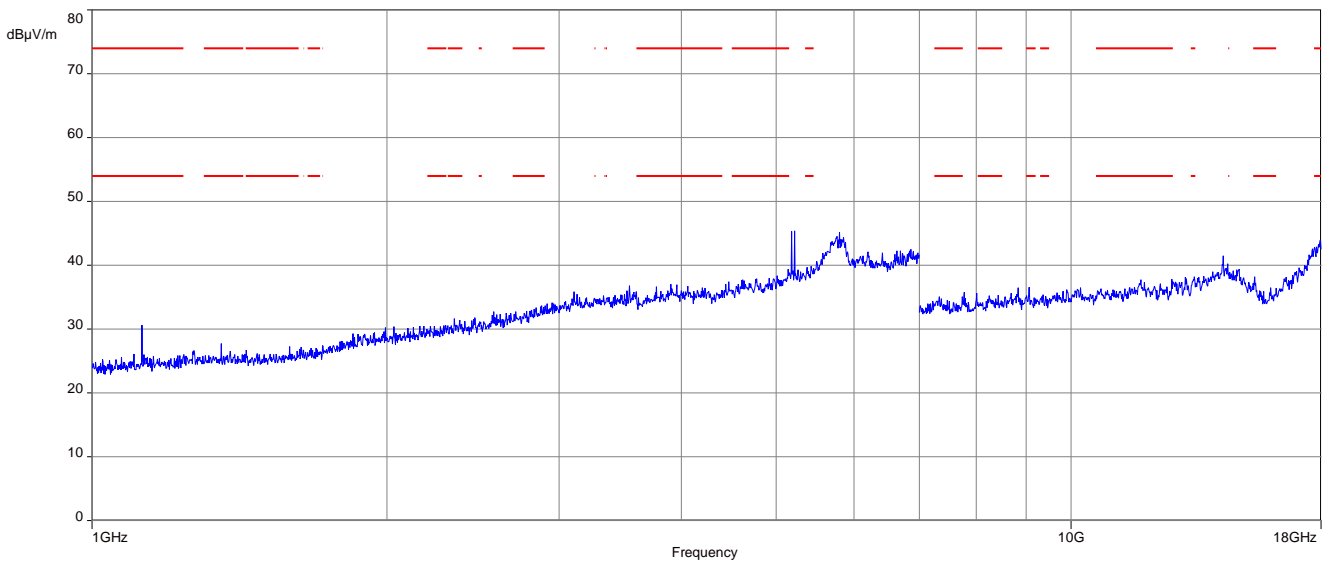

Plots: 40 MHz channel bandwidth

Plot 1: 1 GHz to 18 GHz; vertical & horizontal polarization; U-NII-1; lowest channel

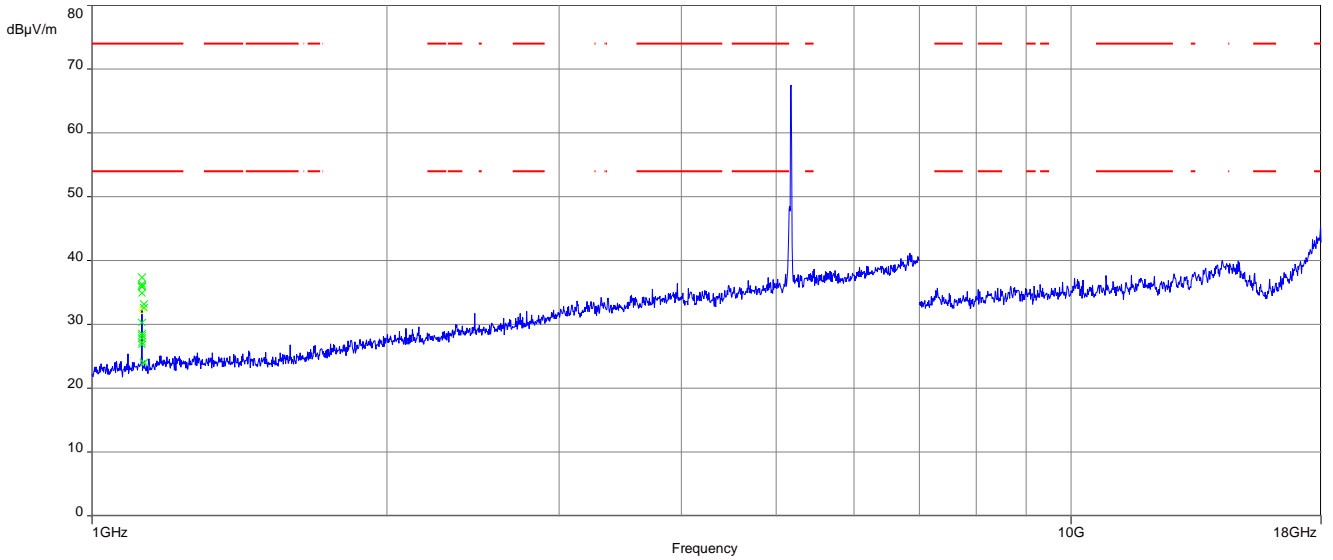

Plot 2: 1 GHz to 18 GHz; vertical & horizontal polarization; U-NII-1; highest channel

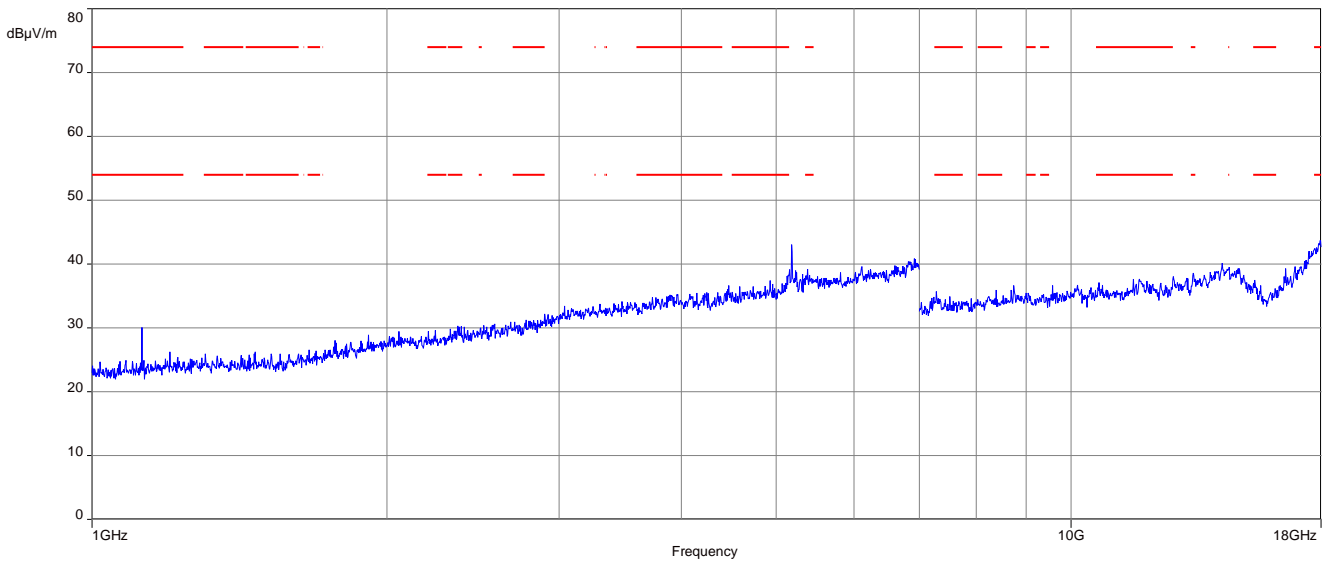

Plot 3: 1 GHz to 18 GHz; vertical & horizontal polarization; U-NII-3; lowest channel

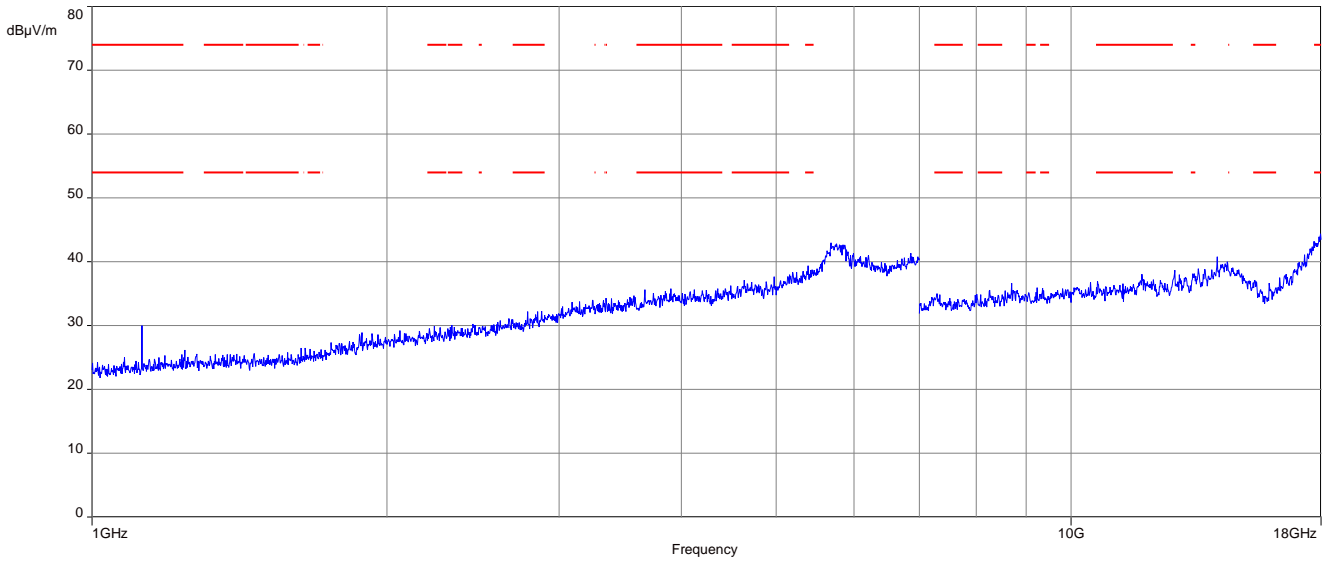

Plot 4: 1 GHz to 18 GHz; vertical & horizontal polarization; U-NII-3; highest channel

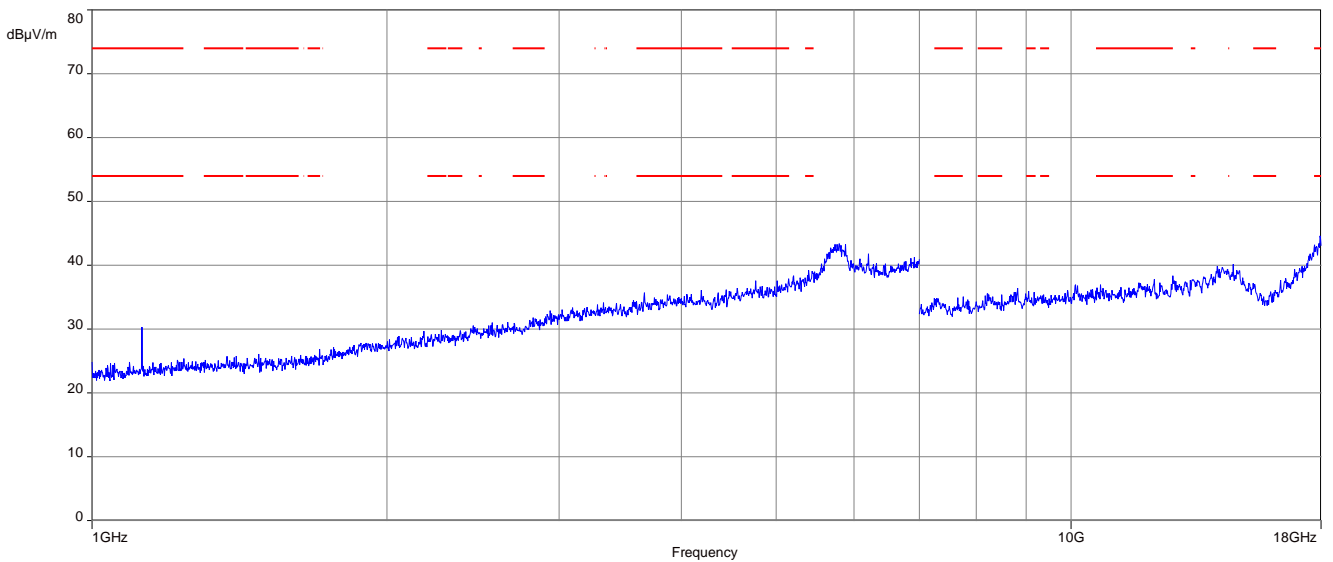

Plots: 80 MHz channel bandwidth

Plot 1: 1 GHz to 18 GHz; vertical & horizontal polarization; U-NII-1; middle channel

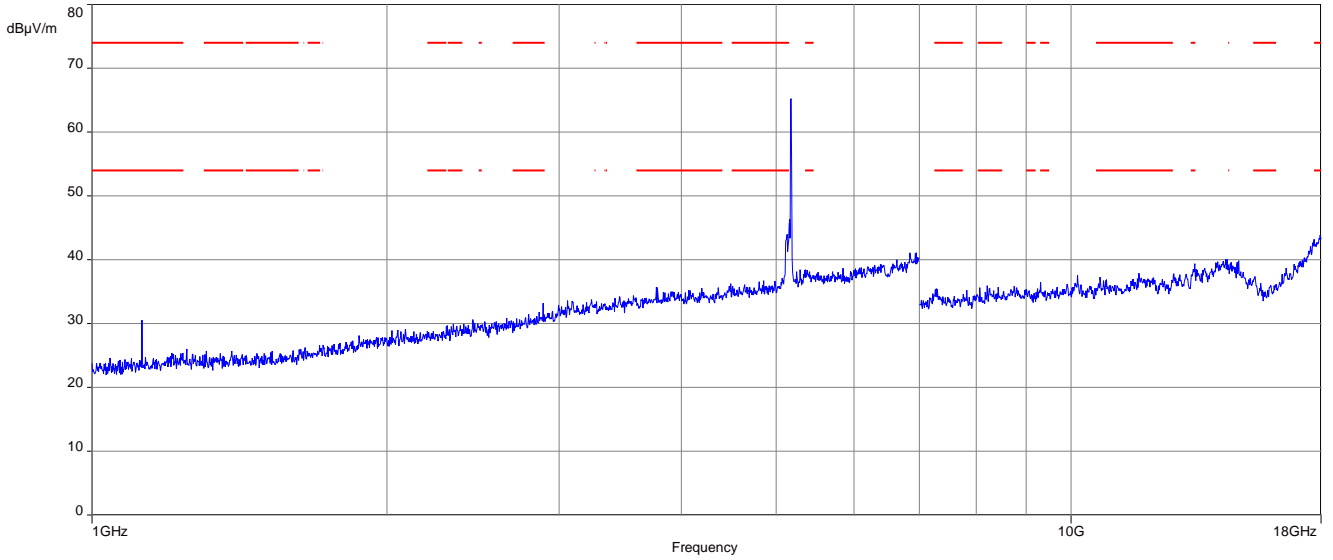

Plot 2: 1 GHz to 18 GHz; vertical & horizontal polarization; U-NII-3; middle channel

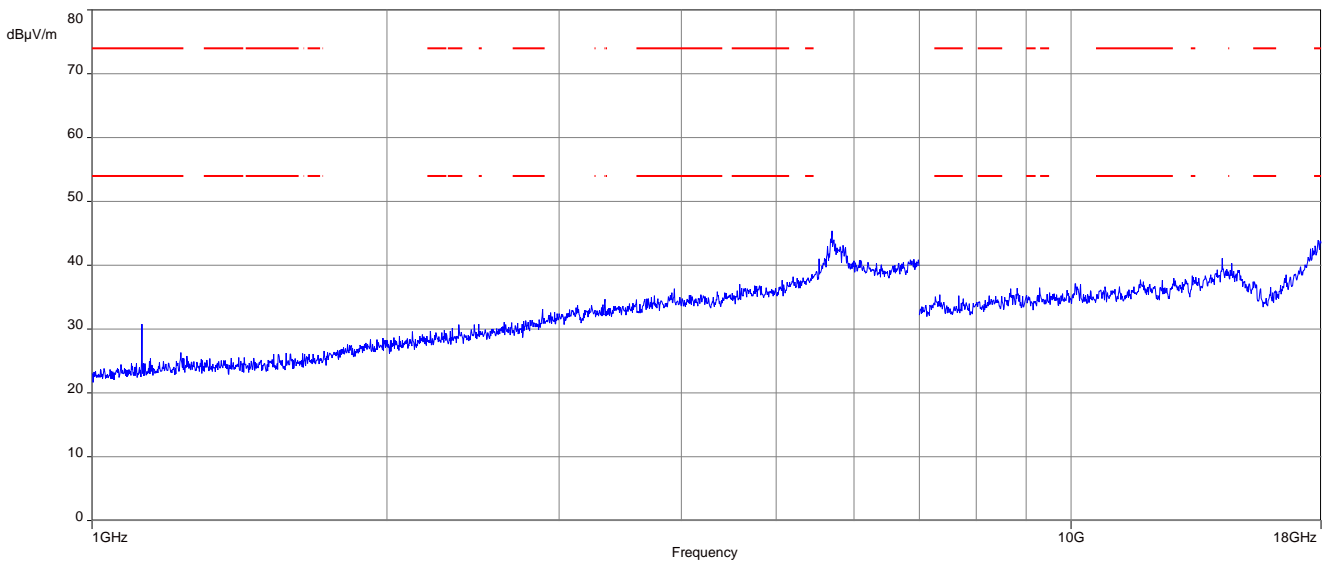

Plot 3: 18 GHz to 40 GHz; vertical & horizontal polarization; valid for all bands, modes and channels

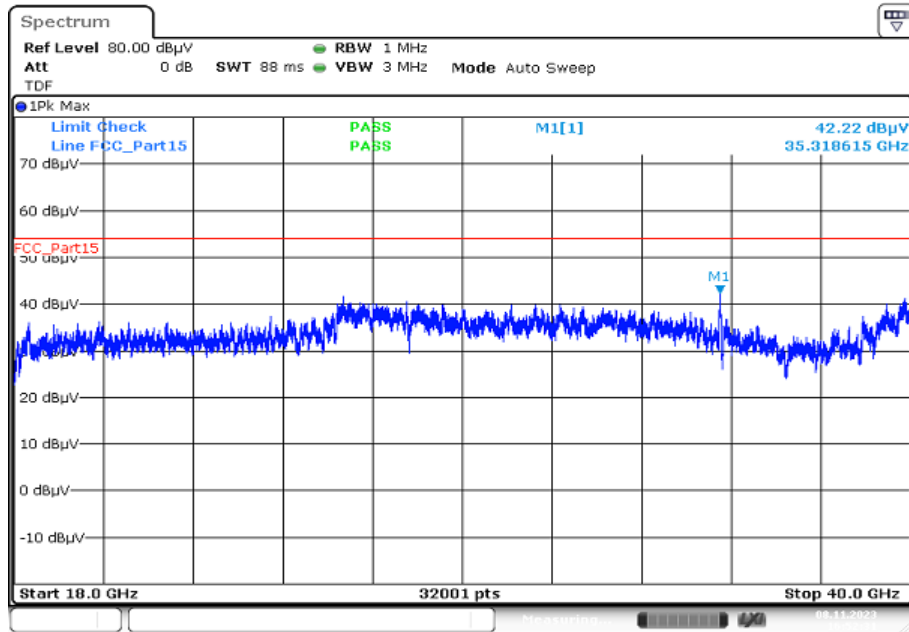

13 Glossary

AVG	Average
C	Compliant
C/N₀	Carrier to noise-density ratio, expressed in dB-Hz
CAC	Channel availability check
CW	Clean wave
DC	Duty cycle
DFS	Dynamic frequency selection
DSSS	Dynamic sequence spread spectrum
DUT	Device under test
EN	European Standard
ETSI	European Telecommunications Standards Institute
EMC	Electromagnetic Compatibility
EUT	Equipment under test
FCC	Federal Communications Commission
FCC ID	Company Identifier at FCC
FHSS	Frequency hopping spread spectrum
FVIN	Firmware version identification number
GNSS	Global Navigation Satellite System
GUE	GNSS User Equipment
HMN	Host marketing name
HVIN	Hardware version identification number
HW	Hardware
IC	Industry Canada
Inv. No.	Inventory number
MC	Modulated carrier
NA	Not applicable
NC	Not compliant
NOP	Non occupancy period
NP	Not performed
OBW	Occupied bandwidth
OC	Operating channel
OCW	Operating channel bandwidth
OFDM	Orthogonal frequency division multiplexing
OOB	Out of band
OP	Occupancy period
PER	Packet error rate
PMN	Product marketing name
PP	Positive peak
QP	Quasi peak
RLAN	Radio local area network
S/N or SN	Serial number
SW	Software
UUT	Unit under test
WLAN	Wireless local area network

14 Document history

Version	Applied changes	Date of release
-/-	Initial release	2024-03-01

END OF TEST REPORT