

RADIO PERFORMANCE TEST REPORT

Test Report No. : OT-223-RWD-044
Reception No. : 2112005097
Applicant : LG Innotek Co., Ltd.
Address : 26, Hanamsandan 5beon-ro Gwangsan-gu, Gwangju, 506-731, South Korea
Manufacturer : LG Innotek Co., Ltd.
Address : 26, Hanamsandan 5beon-ro Gwangsan-gu, Gwangju, 506-731, South Korea
Type of Equipment : RF Module
FCC ID. : YZP-ATC6NPL002
Model Name : ATC6NPL002
Multiple Model Name : N/A
Serial number : N/A
Total page of Report : 165 pages (including this page)
Date of Incoming : December 01, 2021
Date of issue : March 21, 2022

SUMMARY

The equipment complies with the regulation; *FCC PART 15 SUBPART E Section 15.407*
 This test report only contains the result of a single test of the sample supplied for the examination.
 It is not a generally valid assessment of the features of the respective products of the mass-production.



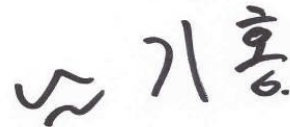

Tested by
 Youngyong Kim/ Manager
 ONETECH Corp.

Reviewed by
 Tae-Ho, Kim / Senior Manager
 ONETECH Corp.

Approved by
 Ki-Hong, Nam / General Manager
 ONETECH Corp.

CONTENTS

	PAGE
1. VERIFICATION OF COMPLIANCE	9
2. TEST SUMMARY.....	10
2.1 TEST ITEMS AND RESULTS	10
2.2 ADDITIONS, DEVIATIONS, EXCLUSIONS FROM STANDARDS.....	10
2.3 RELATED SUBMITTAL(S) / GRANT(S)	10
2.4 PURPOSE OF THE TEST	10
2.5 TEST METHODOLOGY.....	10
2.6 TEST FACILITY.....	10
3. GENERAL INFORMATION.....	11
3.1 PRODUCT DESCRIPTION.....	11
4. EUT MODIFICATIONS.....	32
5. SYSTEM TEST CONFIGURATION	33
5.1 JUSTIFICATION.....	33
5.2 PERIPHERAL EQUIPMENT	33
5.3 MODE OF OPERATION DURING THE TEST	34
5.4 CONFIGURATION OF TEST SYSTEM.....	40
5.5 ANTENNA REQUIREMENT	40
6. PRELIMINARY TEST	40
6.1 AC POWER LINE CONDUCTED EMISSIONS TESTS.....	40
6.2 GENERAL RADIATED EMISSIONS TESTS	40
7. 99 % OCCUPIED BANDWIDTH & MIMIMUM 26 DB BANDWIDTH	41
7.1 OPERATING ENVIRONMENT	41
7.2 TEST SET-UP	41
7.3 TEST DATE	41
7.4 TEST DATA FOR 802.11A RLAN MODE.....	42
7.4.1 Test data for Antenna 0	42
7.4.2 Test data for Antenna 1	44
7.5 TEST DATA FOR 802.11N_HT20 RLAN MODE.....	46
7.5.1 Test data for Antenna 0	46
7.5.2 Test data for Antenna 1	48
7.6 TEST DATA FOR 802.11N_HT40 RLAN MODE.....	50
7.6.1 Test data for Antenna 0	50

This Report is not correlated with the authentication of KOLAS

It should not be reproduced except in full, without the written approval of ONETECH Corp.

OTC-TRF-RF-001(0)

7.6.2 Test data for Antenna 152

7.7 TEST DATA FOR 802.11AC_VHT80 RLAN MODE.....54

 7.7.1 Test data for Antenna 054

 7.7.2 Test data for Antenna 155

8. 6 DB BANDWIDTH56

8.1 OPERATING ENVIRONMENT56

8.2 TEST SET-UP56

8.3 TEST DATE56

8.4 TEST DATA FOR 802.11A RLAN MODE.....57

 8.4.1 Test data for Antenna 057

 8.4.2 Test data for Antenna 157

 8.4.3 Test data for Staddle Channel_Antenna 057

 8.4.4 Test data for Staddle Channel_Antenna 157

8.5 TEST DATA FOR 802.11N_HT20 RLAN MODE.....58

 8.5.1 Test data for Antenna 058

 8.5.2 Test data for Antenna 158

 8.5.3 Test data for Staddle Channel_Antenna 058

 8.5.4 Test data for Staddle Channel_Antenna 158

8.6 TEST DATA FOR 802.11N_HT40 RLAN MODE.....59

 8.6.1 Test data for Antenna 059

 8.6.2 Test data for Antenna 159

 8.6.3 Test data for Staddle Channel_Antenna 059

 8.6.4 Test data for Staddle Channel_Antenna 159

8.7 TEST DATA FOR 802.11AC_VHT80 RLAN MODE.....60

 8.7.1 Test data for Antenna 060

 8.7.2 Test data for Antenna 160

 8.7.3 Test data for Staddle Channel_Antenna 060

 8.7.4 Test data for Staddle Channel_Antenna 160

9. MAXIMUM PEAK OUTPUT POWER61

9.1 OPERATING ENVIRONMENT61

9.2 TEST SET-UP61

9.3 TEST DATE61

9.4 TEST DATA FOR 802.11A RLAN MODE.....62

 9.4.1 Test data for Antenna 062

 9.4.2 Test data for Antenna 163

 9.4.3 Test data for Staddle Channel_Antenna 064

 9.4.4 Test data for Staddle Channel_Antenna 164

This Report is not correlated with the authentication of KOLAS

It should not be reproduced except in full, without the written approval of ONETECH Corp.

OTC-TRF-RF-001(0)

9.5 TEST DATA FOR 802.11N_HT20 RLAN MODE65

9.5.1 Test data for Antenna 0 65

9.5.2 Test data for Antenna 1 66

9.5.3 Test data for Multiple Transmit 67

9.5.4 Test data for Staddle Channel_Antenna 0 68

9.5.5 Test data for Staddle Channel_Antenna 1 68

9.5.6 Test data for Staddle Channel_Multiple Transmit 68

9.6 TEST DATA FOR 802.11N_HT40 RLAN MODE 69

9.6.1 Test data for Antenna 0 69

9.6.2 Test data for Antenna 1 70

9.6.3 Test data for Multiple Transmit 71

9.6.4 Test data for Staddle Channel_Antenna 0 72

9.6.5 Test data for Staddle Channel_Antenna 1 72

9.6.6 Test data for Staddle Channel_Multiple Transmit 72

9.7 TEST DATA FOR 802.11AC_HT80 RLAN MODE..... 73

9.7.1 Test data for Antenna 0 73

9.7.2 Test data for Antenna 1 73

9.7.3 Test data for Multiple Transmit 74

9.7.4 Test data for Staddle Channel_Antenna 0 75

9.7.5 Test data for Staddle Channel_Antenna 1 75

9.7.6 Test data for Staddle Channel_Multiple Transmit 75

10. PEAK POWER SPECTRUL DENSITY76

10.1 OPERATING ENVIRONMENT 76

10.2 TEST SET-UP 76

10.3 TEST DATE 76

10.4 TEST DATA FOR 802.11A RLAN MODE..... 77

10.4.1 Test data for Antenna 0 77

10.4.2 Test data for Antenna 1 78

10.4.3 Test data for Staddle Channel_Antenna 0 79

10.4.4 Test data for Staddle Channel_Antenna 1 79

10.5 TEST DATA FOR 802.11N_HT20 RLAN MODE..... 80

10.5.1 Test data for Antenna 0 80

10.5.2 Test data for Antenna 1 81

10.5.3 Test data for Multiple Transmit 82

10.5.4 Test data for Staddle Channel_Antenna 0 83

10.5.5 Test data for Staddle Channel_Antenna 1 83

10.5.6 Test data for Staddle Channel_Multiple Transmit 83

This Report is not correlated with the authentication of KOLAS

It should not be reproduced except in full, without the written approval of ONETECH Corp.

OTC-TRF-RF-001(0)

10.6 TEST DATA FOR 802.11N_HT40 RLAN MODE	84
<i>10.6.1 Test data for Antenna 0</i>	84
<i>10.6.2 Test data for Antenna 1</i>	84
<i>10.6.4 Test data for Staddle Channel_Antenna 0</i>	86
<i>10.6.5 Test data for Staddle Channel_Antenna 1</i>	86
<i>10.6.6 Test data for Staddle Channel_Multiple Transmit</i>	86
10.7 TEST DATA FOR 802.11AC_HT80 RLAN MODE	87
<i>10.7.1 Test data for Antenna 0</i>	87
<i>10.7.2 Test data for Antenna 1</i>	87
<i>10.7.3 Test data for Multiple Transmit</i>	88
<i>10.7.4 Test data for Staddle Channel_Antenna 0</i>	89
<i>10.7.5 Test data for Staddle Channel_Antenna 1</i>	89
<i>10.7.6 Test data for Staddle Channel_Multiple Transmit</i>	89
11. FREQUENCY STABILITY WITH TEMPERATURE VARIATION	90
11.1 OPERATING ENVIRONMENT	90
11.2 TEST SET-UP	90
11.3 TEST DATE	90
11.4 TEST DATA FOR U-NII-1	91
11.5 TEST DATA FOR U-NII-2A	92
11.6 TEST DATA FOR U-NII-2C	93
11.7 TEST DATA FOR U-NII-3	94
12. FREQUENCY STABILITY WITH VOLTAGE VARIATION	95
12.1 OPERATING ENVIRONMENT	95
12.2 TEST SET-UP	95
12.3 TEST DATE	95
12.4 TEST DATA FOR U-NII-1	96
12.5 TEST DATA FOR U-NII-2A	96
12.6 TEST DATA FOR U-NII-2C	97
12.7 TEST DATA FOR U-NII-3	97
13. RADIATED SPURIOUS EMISSIONS	98
13.1 OPERATING ENVIRONMENT	98
13.2 TEST SET-UP FOR CONDUCTED MEASUREMENT	98
13.3 TEST DATE	98
13.4 TEST DATA FOR BELOW 30 MHZ	99
13.5 TEST DATA FOR 30 MHZ ~ 1 000 MHZ	100
<i>13.5.1 Test data for WLAN 5 GHz</i>	100
<i>13.5.2 Test data for Intermodulation Mode(WLAN 5 GHz + Bluetooth)</i>	101

This Report is not correlated with the authentication of KOLAS

It should not be reproduced except in full, without the written approval of ONETECH Corp.

OTC-TRF-RF-001(0)

13.5.3 Test data for Intermodulation Mode(WLAN 5 GHz + Bluetooth LE) 102

13.5.4 Test data for Intermodulation Mode(WLAN 5 GHz + WLAN 2.4 GHz) 103

13.6 TEST DATA FOR ABOVE 1 GHZ..... 104

13.6.1 Test data for Frequency UNII I 104

13.6.2 Test data for Frequency UNII 2A 108

13.6.3 Test data for Frequency UNII 2C 113

13.6.4 Test data for Frequency UNII 3 118

14. RADIATED RESTRICTED BAND EDGE MEASUREMENTS 123

14.1 OPERATING ENVIRONMENT 123

14.2 TEST SET-UP FOR CONDUCTED MEASUREMENT 123

14.3 TEST DATE 123

14.4 TEST DATA FOR FREQUENCY UNII I..... 124

14.4.1 Test data for 802.11a RLAN Mode 124

14.4.2 Test data for 802.11n_HT20 RLAN Mode 125

14.4.3 Test data for 802.11n_HT40 RLAN Mode 126

14.4.4 Test data for 802.11ac_VHT80 RLAN Mode 127

14.5 TEST DATA FOR FREQUENCY UNII 2A..... 128

14.5.1 Test data for 802.11a RLAN Mode 128

14.5.2 Test data for 802.11n_HT20 RLAN Mode 129

14.5.3 Test data for 802.11n_HT40 RLAN Mode 130

14.5.4 Test data for 802.11ac_VHT80 RLAN Mode 131

14.6 TEST DATA FOR FREQUENCY UNII 2C..... 132

14.6.1 Test data for 802.11a RLAN Mode 132

14.6.2 Test data for 802.11n_HT20 RLAN Mode 133

14.6.3 Test data for 802.11n_HT40 RLAN Mode 134

14.6.4 Test data for 802.11ac_VHT80 RLAN Mode 135

14.7 TEST DATA FOR FREQUENCY U-NII-3..... 136

14.7.1 Test data for 802.11a RLAN Mode 136

14.7.2 Test data for 802.11n_HT20 RLAN Mode 140

14.7.3 Test data for 802.11n_HT40 RLAN Mode 142

14.7.4 Test data for 802.11ac_VHT80 RLAN Mode 144

14.7.5 U-NII-3 Emission Limits 145

15. CONDUCTED EMISSION TEST 146

15.1 OPERATING ENVIRONMENT 146

15.2 TEST SET-UP 146

15.3 TEST DATE 146

15.4 TEST DATA FOR WLAN 5 GHZ 147

This Report is not correlated with the authentication of KOLAS

It should not be reproduced except in full, without the written approval of ONETECH Corp.

OTC-TRF-RF-001(0)

16. DYNAMIC FREQUENCY SELECTION (DFS)155

16.1 OPERATING ENVIRONMENT 155

16.2 TEST SET-UPS 155

16.3 DFS TEST SIGNALS 157

16.4 TECHNICAL REQUIREMENT SPECIFICATION 158

16.5 TEST DATE 158

16.6 TEST DATA 159

16.6.1 UNII 2A 159

16.6.2 UNII 3 162

17. LIST OF TEST EQUIPMENT165

※ Please refer to the Annex section for All test plots

Revision History

Rev. No.	Issue Report No.	Issued Date	Revisions	Section Affected
0	OT-223-RWD-044	March 21, 2022	Initial Release	All

1. VERIFICATION OF COMPLIANCE

Applicant : LG Innotek Co., Ltd.
 Address : 26, Hanamsandan 5beon-ro Gwangsan-gu, Gwangju, 506-731, South Korea
 Contact Person : Jeong Inchang / Senior Research Engineer
 Telephone No. : +82-62-950-0332
 FCC ID : YZP-ATC6NPL002
 Model Name : ATC6NPL002
 Brand Name :  **LG Innotek**
 Serial Number : N/A
 Date : March 21, 2022

EQUIPMENT CLASS	Unlicensed National Information infrastructure(UNII)
E.U.T. DESCRIPTION	RF Module
THIS REPORT CONCERNS	Original Grant
MEASUREMENT PROCEDURES	ANSI C63.10: 2020
TYPE OF EQUIPMENT TESTED	Pre-Production
KIND OF EQUIPMENT AUTHORIZATION REQUESTED	Certification
EQUIPMENT WILL BE OPERATED UNDER FCC RULES PART(S)	FCC PART 15 SUBPART E Section 15.407 789033 D02 General UNII Test Procedures New Rules v02r01
Modifications on the Equipment to Achieve Compliance	None
Final Test was Conducted On	3 m, Semi Anechoic Chamber

-. The above equipment was tested by ONETECH Corp. for compliance with the requirement set forth in the FCC Rules and Regulations. This said equipment in the configuration described in this report, shows the maximum emission levels emanating from equipment are within the compliance requirements.

2. TEST SUMMARY

2.1 Test items and results

SECTION	TEST ITEMS	RESULTS
15.407(a)	26 dB Bandwidth	PASS
15.407(a)	Maximum Conducted Output Power	Met the Limit / PASS
15.407(a)	Peak Power Spectral Density	Met the Limit / PASS
15.407(e)	6 dB Bandwidth	Met the Limit / PASS
15.407(g)	Frequency Stability	Met the Limit / PASS
15.407(b)	Undesirable Emissions	Met the Limit / PASS
15.205, 15.407(b)	General Field Strength Limits (Restricted Bands and Radiated Emission Limits)	Met the Limit / PASS
15.207	Conducted Limits	Met the Limit / PASS

2.2 Additions, deviations, exclusions from standards

No additions, deviations or exclusions have been made from standard.

2.3 Related Submittal(s) / Grant(s)

Original submittal only

2.4 Purpose of the test

To determine whether the equipment under test fulfills the requirements of the regulation stated in FCC PART 15 SUBPART E Section 15.407

2.5 Test Methodology

Both conducted and radiated testing was performed according to the procedures in ANSI C63.10: 2020. Radiated testing was performed at a distance of 3 m from EUT to the antenna.

2.6 Test Facility

The Onetech Corp. has been designated to perform equipment testing in compliance with ISO/IEC 17025.

The Electromagnetic compatibility measurement facilities are located at 43-14, Jinsaegol-gil, Chowol-eup, Gwangju-si, Gyeonggi-do, 12735, Korea.

-. Site Filing:

VCCI (Voluntary Control Council for Interference) – Registration No. R-20122/ C-14617/ G-10666/ T-11842

ISED (Innovation, Science and Economic Development Canada) – Registration No. Site# 3736A-3

KOLAS (Korea Laboratory Accreditation Scheme) - Accreditation NO. KT085

FCC (Federal Communications Commission) - Accreditation No. KR0013

RRA (Radio Research Agency) – Designation No. KR0013

This Report is not correlated with the authentication of KOLAS

It should not be reproduced except in full, without the written approval of ONETECH Corp.

OTC-TRF-RF-001(0)

3. GENERAL INFORMATION

3.1 Product Description

The LG Innotek Co., Ltd., Model ATC6NPL002 (referred to as the EUT in this report) is a RF Module. The product specification described herein was obtained from product data sheet or user’s manual.

DEVICE TYPE	RF Module		
OPERATING FREQUENCY	Bluetooth LE	2 402 MHz ~ 2 480 MHz	
	Bluetooth	2 402 MHz ~ 2 480 MHz	
	WLAN 2.4 GHz	2 412 MHz ~ 2 462 MHz (802.11b/g/n(HT20)/ax(HE20))	
		2 422 MHz ~ 2 452 MHz (802.11n(HT40)/ax(HE40))	
	WLAN 5 150 MHz ~ 5 250 MHz Band	5 180 MHz ~ 5 240 MHz (802.11a/n(HT20)/ac(VHT20)/ax(HE20))	
		5 190 MHz ~ 5 230 MHz (802.11n(HT40)/ac(VHT40)/ax(HE40))	
		5 210 MHz (802.11ac(VHT80)/ax(HE80))	
	WLAN 5 250 MHz ~ 5 350 MHz Band	5 260 MHz ~ 5 320 MHz (802.11a/n(HT20)/ac(VHT20)/ax(HE20))	
		5 270 MHz ~ 5 310 MHz (802.11n(HT40)/ac(VHT40)/ax(HE40))	
		5 290 MHz (802.11ac(VHT80)/ax(HE80))	
	WLAN 5 470 MHz ~ 5 725 MHz Band	5 500 MHz ~ 5 720 MHz (802.11a/n(HT20)/ac(VHT20)/ax(HE20))	
		5 510 MHz ~ 5 710 MHz (802.11n(HT40)/ac(VHT40)/ax(HE40))	
		5 530 MHz ~ 5 690 MHz (802.11ac(VHT80)/ax(HE80))	
	WLAN 5 725 MHz ~ 5 850 MHz Band	5 745 MHz ~ 5 825 MHz (802.11a/n(HT20)/ac(VHT20)/ax(HE20))	
		5 755 MHz ~ 5 795 MHz (802.11n(HT40)/ac(VHT40)/ax(HE40))	
5 775 MHz (802.11ac(VHT80)/ax(HE80))			
MODULATION TYPE	Bluetooth LE	GFSK for 1 Mbps / 2 Mbps / 125 kbps / 500 kbps	
	Bluetooth	GFSK for 1Mbps, $\pi/4$ -DQPSK for 2Mbps, 8-DPSK for 3Mbps	
	WLAN 2.4 GHz	802.11b: DSSS Modulation(DBPSK/DQPSK/CCK)	
		802.11g/n(HT20)/n(HT40)/ax(HE20)/ax(HE40): OFDM Modulation(BPSK/QPSK/16QAM/64QAM)	
	WLAN 5 GHz	802.11a/n(HT20)/n(HT40)/ac(VHT80)/ax(HE20)/ax(HE40)/ax(HE80): OFDM Modulation(BPSK/QPSK/16QAM/64QAM)	

RF OUTPUT POWER	Bluetooth LE	1 Mbps	1.21 dBm
		2 Mbps	1.17 dBm
		125 kbps	1.22 dBm
		500 kbps	1.24 dBm
	Bluetooth	1 Mbps	0.67 dBm
		2 Mbps	-0.27 dBm
		3 Mbps	0.09 dBm
	WLAN 2.4 GHz	Antenna 0	15.57 dBm(802.11b)
			11.80 dBm(802.11g)
			11.67 dBm(802.11n_HT20)
			13.27 dBm(802.11ax_HE20)_26 Tone
			13.06 dBm(802.11ax_HE20)_52 Tone
			12.66 dBm(802.11ax_HE20)_106 Tone
11.85 dBm(802.11ax_HE20)_242 Tone			
11.47 dBm(802.11ax_HE20)_Single User			
11.31 dBm(802.11n_HT40)			
12.02 dBm(802.11ax_HE40)_26 Tone			
12.93 dBm(802.11ax_HE40)_52 Tone			
13.04 dBm(802.11ax_HE40)_106 Tone			
12.44 dBm(802.11ax_HE40)_242 Tone			
11.52 dBm(802.11ax_HE40)_484 Tone			
11.50 dBm(802.11ax_HE40)_Single User			

RF OUTPUT POWER	WLAN 2.4 GHz	Antenna 1	16.19 dBm(802.11b) 12.88 dBm(802.11g) 13.11 dBm(802.11n_HT20) 13.35 dBm(802.11ax_HE20)_26 Tone 13.57 dBm(802.11ax_HE20)_52 Tone 13.47 dBm(802.11ax_HE20)_106 Tone 13.33 dBm(802.11ax_HE20)_242 Tone 13.65 dBm(802.11ax_HE20)_Single User 12.11 dBm(802.11n_HT40) 12.31 dBm(802.11ax_HE40)_26 Tone 12.67 dBm(802.11ax_HE40)_52 Tone 12.70 dBm(802.11ax_HE40)_106 Tone 12.68 dBm(802.11ax_HE40)_242 Tone 12.48 dBm(802.11ax_HE40)_484 Tone 12.69 dBm(802.11ax_HE40)_Single User
		Multiple Antenna	15.46 dBm(802.11n_HT20) 16.32 dBm(802.11ax_HE20)_26 Tone 16.22 dBm(802.11ax_HE20)_52 Tone 16.09 dBm(802.11ax_HE20)_106 Tone 15.66 dBm(802.11ax_HE20)_242 Tone 15.70 dBm(802.11ax_HE20)_Single User 14.74 dBm(802.11n_HT40) 14.90 dBm(802.11ax_HE40)_26 Tone 15.78 dBm(802.11ax_HE40)_52 Tone 15.83 dBm(802.11ax_HE40)_106 Tone 15.57 dBm(802.11ax_HE40)_242 Tone 15.04 dBm(802.11ax_HE40)_484 Tone 15.15 dBm(802.11ax_HE40)_Single User

<p>RF OUTPUT POWER</p>	<p>WLAN 5 150 MHz ~ 5 250 MHz Band</p>	<p>Antenna 0</p>	<p>12.59 dBm(802.11a) 12.15 dBm(802.11n_HT20) 2.53 dBm(802.11ax_HE20)_26 Tone 4.65 dBm(802.11ax_HE20)_52 Tone 7.54 dBm(802.11ax_HE20)_106 Tone 10.29 dBm(802.11ax_HE20)_242 Tone 12.19 dBm(802.11ax_HE20)_Single User 9.02 dBm(802.11n_HT40) 3.32 dBm(802.11ax_HE40)_26 Tone 5.26 dBm(802.11ax_HE40)_52 Tone 7.72 dBm(802.11ax_HE40)_106 Tone 7.54 dBm(802.11ax_HE40)_242 Tone 7.43 dBm(802.11ax_HE40)_484 Tone 9.15 dBm(802.11ax_HE40)_Single User 8.33 dBm(802.11ac_VHT80) 3.10 dBm(802.11ax_HE40)_26 Tone 5.03 dBm(802.11ax_HE40)_52 Tone 4.87 dBm(802.11ax_HE40)_106 Tone 4.76 dBm(802.11ax_HE40)_242 Tone 4.72 dBm(802.11ax_HE40)_484 Tone 4.33 dBm(802.11ax_HE40)_996 Tone 8.55 dBm(802.11ax_HE40)_Single User</p>
----------------------------	--	------------------	--

<p>RF OUTPUT POWER</p>	<p>WLAN 5 150 MHz ~ 5 250 MHz Band</p>	<p>Antenna 1</p>	<p>12.45 dBm(802.11a) 12.01 dBm(802.11n_HT20) 3.45 dBm(802.11ax_HE20)_26 Tone 5.63 dBm(802.11ax_HE20)_52 Tone 8.30 dBm(802.11ax_HE20)_106 Tone 10.77 dBm(802.11ax_HE20)_242 Tone 12.02 dBm(802.11ax_HE20)_Single User 8.87 dBm(802.11n_HT40) 4.18 dBm(802.11ax_HE40)_26 Tone 6.25 dBm(802.11ax_HE40)_52 Tone 8.44 dBm(802.11ax_HE40)_106 Tone 8.29 dBm(802.11ax_HE40)_242 Tone 8.20 dBm(802.11ax_HE40)_484 Tone 9.21 dBm(802.11ax_HE40)_Single User 8.11 dBm(802.11ac_VHT80) 4.10 dBm(802.11ax_HE40)_26 Tone 6.10 dBm(802.11ax_HE40)_52 Tone 5.90 dBm(802.11ax_HE40)_106 Tone 5.81 dBm(802.11ax_HE40)_242 Tone 5.75 dBm(802.11ax_HE40)_484 Tone 5.50 dBm(802.11ax_HE40)_996 Tone 8.27 dBm(802.11ax_HE40)_Single User</p>
----------------------------	--	------------------	--

<p>RF OUTPUT POWER</p>	<p>WLAN 5 150 MHz ~ 5 250 MHz Band</p>	<p>Multiple Antenna</p>	<p>15.09 dBm(802.11n_HT20) 6.03 dBm(802.11ax_HE20)_26 Tone 8.18 dBm(802.11ax_HE20)_52 Tone 10.95 dBm(802.11ax_HE20)_106 Tone 13.55 dBm(802.11ax_HE20)_242 Tone 15.11 dBm(802.11ax_HE20)_Single User 11.95 dBm(802.11n_HT40) 6.78 dBm(802.11ax_HE40)_26 Tone 8.80 dBm(802.11ax_HE40)_52 Tone 11.11 dBm(802.11ax_HE40)_106 Tone 10.94 dBm(802.11ax_HE40)_242 Tone 10.84 dBm(802.11ax_HE40)_484 Tone 12.19 dBm(802.11ax_HE40)_Single User 11.24 dBm(802.11ac_VHT80) 6.64 dBm(802.11ax_HE40)_26 Tone 8.61 dBm(802.11ax_HE40)_52 Tone 8.42 dBm(802.11ax_HE40)_106 Tone 8.32 dBm(802.11ax_HE40)_242 Tone 8.27 dBm(802.11ax_HE40)_484 Tone 7.96 dBm(802.11ax_HE40)_996 Tone 11.42 dBm(802.11ax_HE40)_Single User</p>
----------------------------	--	-------------------------	---

<p>RF OUTPUT POWER</p>	<p>WLAN 5 250 MHz ~ 5 350 MHz Band</p>	<p>Antenna 0</p>	<p>12.38 dBm(802.11a) 11.90 dBm(802.11n_HT20) 2.66 dBm(802.11ax_HE20)_26 Tone 4.79 dBm(802.11ax_HE20)_52 Tone 7.63 dBm(802.11ax_HE20)_106 Tone 10.35 dBm(802.11ax_HE20)_242 Tone 11.97 dBm(802.11ax_HE20)_Single User 8.28 dBm(802.11n_HT40) 3.52 dBm(802.11ax_HE40)_26 Tone 5.62 dBm(802.11ax_HE40)_52 Tone 7.88 dBm(802.11ax_HE40)_106 Tone 5.55 dBm(802.11ax_HE40)_242 Tone 7.49 dBm(802.11ax_HE40)_484 Tone 8.44 dBm(802.11ax_HE40)_Single User 6.35 dBm(802.11ac_VHT80) 3.18 dBm(802.11ax_HE40)_26 Tone 5.13 dBm(802.11ax_HE40)_52 Tone 4.96 dBm(802.11ax_HE40)_106 Tone 4.88 dBm(802.11ax_HE40)_242 Tone 4.86 dBm(802.11ax_HE40)_484 Tone 4.82 dBm(802.11ax_HE40)_996 Tone 6.54 dBm(802.11ax_HE40)_Single User</p>
----------------------------	--	------------------	--

<p>RF OUTPUT POWER</p>	<p>WLAN 5 250 MHz ~ 5 350 MHz Band</p>	<p>Antenna 1</p>	<p>12.39 dBm(802.11a) 11.94 dBm(802.11n_HT20) 3.67 dBm(802.11ax_HE20)_26 Tone 5.73 dBm(802.11ax_HE20)_52 Tone 8.46 dBm(802.11ax_HE20)_106 Tone 10.87 dBm(802.11ax_HE20)_242 Tone 12.03 dBm(802.11ax_HE20)_Single User 8.21 dBm(802.11n_HT40) 4.43 dBm(802.11ax_HE40)_26 Tone 6.58 dBm(802.11ax_HE40)_52 Tone 8.63 dBm(802.11ax_HE40)_106 Tone 6.48 dBm(802.11ax_HE40)_242 Tone 8.39 dBm(802.11ax_HE40)_484 Tone 8.48 dBm(802.11ax_HE40)_Single User 6.23 dBm(802.11ac_VHT80) 4.28 dBm(802.11ax_HE40)_26 Tone 6.24 dBm(802.11ax_HE40)_52 Tone 6.07 dBm(802.11ax_HE40)_106 Tone 5.88 dBm(802.11ax_HE40)_242 Tone 5.90 dBm(802.11ax_HE40)_484 Tone 5.86 dBm(802.11ax_HE40)_996 Tone 6.54 dBm(802.11ax_HE40)_Single User</p>
----------------------------	--	------------------	--

<p>RF OUTPUT POWER</p>	<p>WLAN 5 250 MHz ~ 5 350 MHz Band</p>	<p>Multiple Antenna</p>	<p>14.89 dBm(802.11n_HT20) 6.21 dBm(802.11ax_HE20)_26 Tone 8.29 dBm(802.11ax_HE20)_52 Tone 11.07 dBm(802.11ax_HE20)_106 Tone 13.58 dBm(802.11ax_HE20)_242 Tone 15.01 dBm(802.11ax_HE20)_Single User 11.23 dBm(802.11n_HT40) 6.98 dBm(802.11ax_HE40)_26 Tone 9.14 dBm(802.11ax_HE40)_52 Tone 11.28 dBm(802.11ax_HE40)_106 Tone 9.05 dBm(802.11ax_HE40)_242 Tone 10.97 dBm(802.11ax_HE40)_484 Tone 11.47 dBm(802.11ax_HE40)_Single User 9.30 dBm(802.11ac_VHT80) 6.77 dBm(802.11ax_HE40)_26 Tone 8.73 dBm(802.11ax_HE40)_52 Tone 8.56 dBm(802.11ax_HE40)_106 Tone 8.41 dBm(802.11ax_HE40)_242 Tone 8.42 dBm(802.11ax_HE40)_484 Tone 8.38 dBm(802.11ax_HE40)_996 Tone 9.55 dBm(802.11ax_HE40)_Single User</p>
----------------------------	--	-------------------------	--

<p>RF OUTPUT POWER</p>	<p>WLAN 5 470 MHz ~ 5 725 MHz Band</p>	<p>Antenna 0</p>	<p>12.24 dBm(802.11a) 11.76 dBm(802.11n_HT20) 2.82 dBm(802.11ax_HE20)_26 Tone 4.98 dBm(802.11ax_HE20)_52 Tone 7.90 dBm(802.11ax_HE20)_106 Tone 10.64 dBm(802.11ax_HE20)_242 Tone 12.03 dBm(802.11ax_HE20)_Single User 9.62 dBm(802.11n_HT40) 3.69 dBm(802.11ax_HE40)_26 Tone 5.92 dBm(802.11ax_HE40)_52 Tone 8.02 dBm(802.11ax_HE40)_106 Tone 7.72 dBm(802.11ax_HE40)_242 Tone 7.76 dBm(802.11ax_HE40)_484 Tone 9.99 dBm(802.11ax_HE40)_Single User 5.91 dBm(802.11ac_VHT80) 3.20 dBm(802.11ax_HE40)_26 Tone 5.21 dBm(802.11ax_HE40)_52 Tone 4.98 dBm(802.11ax_HE40)_106 Tone 4.80 dBm(802.11ax_HE40)_242 Tone 4.78 dBm(802.11ax_HE40)_484 Tone 4.46 dBm(802.11ax_HE40)_996 Tone 6.27 dBm(802.11ax_HE40)_Single User</p>
----------------------------	--	------------------	--

<p>RF OUTPUT POWER</p>	<p>WLAN 5 470 MHz ~ 5 725 MHz Band</p>	<p>Antenna 0_Straddle</p>	<p>9.32 dBm(802.11a) 9.20 dBm(802.11n_HT20) 2.00 dBm(802.11ax_HE20)_26 Tone 4.19 dBm(802.11ax_HE20)_52 Tone 6.86 dBm(802.11ax_HE20)_106 Tone 8.57 dBm(802.11ax_HE20)_242 Tone 9.31 dBm(802.11ax_HE20)_Single User 7.36 dBm(802.11n_HT40) -14.30 dBm(802.11ax_HE40)_26 Tone -6.24 dBm(802.11ax_HE40)_52 Tone 3.73 dBm(802.11ax_HE40)_106 Tone 5.66 dBm(802.11ax_HE40)_242 Tone 6.45 dBm(802.11ax_HE40)_484 Tone 7.74 dBm(802.11ax_HE40)_Single User 4.72 dBm(802.11ac_VHT80) -15.24 dBm(802.11ax_HE40)_26 Tone -7.11 dBm(802.11ax_HE40)_52 Tone 1.12 dBm(802.11ax_HE40)_106 Tone 2.80 dBm(802.11ax_HE40)_242 Tone 3.65 dBm(802.11ax_HE40)_484 Tone 4.16 dBm(802.11ax_HE40)_996 Tone 5.03 dBm(802.11ax_HE40)_Single User</p>
----------------------------	--	---------------------------	--

<p>RF OUTPUT POWER</p>	<p>WLAN 5 470 MHz ~ 5 725 MHz Band</p>	<p>Antenna 1</p>	<p>12.50 dBm(802.11a) 11.89 dBm(802.11n_HT20) 3.90 dBm(802.11ax_HE20)_26 Tone 8.53 dBm(802.11ax_HE20)_52 Tone 8.55 dBm(802.11ax_HE20)_106 Tone 11.07 dBm(802.11ax_HE20)_242 Tone 12.15 dBm(802.11ax_HE20)_Single User 9.93 dBm(802.11n_HT40) 5.05 dBm(802.11ax_HE40)_26 Tone 7.13 dBm(802.11ax_HE40)_52 Tone 9.13 dBm(802.11ax_HE40)_106 Tone 8.84 dBm(802.11ax_HE40)_242 Tone 8.81 dBm(802.11ax_HE40)_484 Tone 10.15 dBm(802.11ax_HE40)_Single User 5.90 dBm(802.11ac_VHT80) 4.26 dBm(802.11ax_HE40)_26 Tone 6.28 dBm(802.11ax_HE40)_52 Tone 6.15 dBm(802.11ax_HE40)_106 Tone 6.02 dBm(802.11ax_HE40)_242 Tone 5.96 dBm(802.11ax_HE40)_484 Tone 5.71 dBm(802.11ax_HE40)_996 Tone 6.27 dBm(802.11ax_HE40)_Single User</p>
----------------------------	--	------------------	---

<p>RF OUTPUT POWER</p>	<p>WLAN 5 470 MHz ~ 5 725 MHz Band</p>	<p>Antenna 1_Straddle</p>	<p>9.42 dBm(802.11a) 9.23 dBm(802.11n_HT20) 3.92 dBm(802.11ax_HE20)_26 Tone 5.88 dBm(802.11ax_HE20)_52 Tone 8.59 dBm(802.11ax_HE20)_106 Tone 9.80 dBm(802.11ax_HE20)_242 Tone 9.35 dBm(802.11ax_HE20)_Single User 7.45 dBm(802.11n_HT40) -12.01 dBm(802.11ax_HE40)_26 Tone -4.37 dBm(802.11ax_HE40)_52 Tone 5.52 dBm(802.11ax_HE40)_106 Tone 7.38 dBm(802.11ax_HE40)_242 Tone 7.74 dBm(802.11ax_HE40)_484 Tone 7.79 dBm(802.11ax_HE40)_Single User 4.37 dBm(802.11ac_VHT80) -13.11 dBm(802.11ax_HE40)_26 Tone -5.17 dBm(802.11ax_HE40)_52 Tone 2.86 dBm(802.11ax_HE40)_106 Tone 4.42 dBm(802.11ax_HE40)_242 Tone 5.11 dBm(802.11ax_HE40)_484 Tone 5.32 dBm(802.11ax_HE40)_996 Tone 4.66 dBm(802.11ax_HE40)_Single User</p>
----------------------------	--	---------------------------	--

<p>RF OUTPUT POWER</p>	<p>WLAN 5 470 MHz ~ 5 725 MHz Band</p>	<p>Multiple Antenna</p>	<p>14.89 dBm(802.11n_HT20) 6.33 dBm(802.11ax_HE20)_26 Tone 9.99 dBm(802.11ax_HE20)_52 Tone 11.21 dBm(802.11ax_HE20)_106 Tone 13.87 dBm(802.11ax_HE20)_242 Tone 15.10 dBm(802.11ax_HE20)_Single User 12.79 dBm(802.11n_HT40) 7.44 dBm(802.11ax_HE40)_26 Tone 9.58 dBm(802.11ax_HE40)_52 Tone 11.62 dBm(802.11ax_HE40)_106 Tone 11.31 dBm(802.11ax_HE40)_242 Tone 11.33 dBm(802.11ax_HE40)_484 Tone 13.09 dBm(802.11ax_HE40)_Single User 8.92 dBm(802.11ac_VHT80) 6.77 dBm(802.11ax_HE40)_26 Tone 8.79 dBm(802.11ax_HE40)_52 Tone 8.61 dBm(802.11ax_HE40)_106 Tone 8.46 dBm(802.11ax_HE40)_242 Tone 8.42 dBm(802.11ax_HE40)_484 Tone 8.14 dBm(802.11ax_HE40)_996 Tone 9.28 dBm(802.11ax_HE40)_Single User</p>
----------------------------	--	-------------------------	---

<p>RF OUTPUT POWER</p>	<p>WLAN 5 470 MHz ~ 5 725 MHz Band</p>	<p>Multiple Antenna _Straddle</p>	<p>12.22 dBm(802.11n_HT20) 5.99 dBm(802.11ax_HE20)_26 Tone 8.12 dBm(802.11ax_HE20)_52 Tone 10.82 dBm(802.11ax_HE20)_106 Tone 12.24 dBm(802.11ax_HE20)_242 Tone 12.34 dBm(802.11ax_HE20)_Single User 10.41 dBm(802.11n_HT40) -9.99 dBm(802.11ax_HE40)_26 Tone -2.19 dBm(802.11ax_HE40)_52 Tone 7.73 dBm(802.11ax_HE40)_106 Tone 9.62 dBm(802.11ax_HE40)_242 Tone 10.15 dBm(802.11ax_HE40)_484 Tone 10.78 dBm(802.11ax_HE40)_Single User 7.56 dBm(802.11ac_VHT80) -11.04 dBm(802.11ax_HE40)_26 Tone -3.02 dBm(802.11ax_HE40)_52 Tone 5.08 dBm(802.11ax_HE40)_106 Tone 6.69 dBm(802.11ax_HE40)_242 Tone 7.45 dBm(802.11ax_HE40)_484 Tone 7.79 dBm(802.11ax_HE40)_996 Tone 7.86 dBm(802.11ax_HE40)_Single User</p>
----------------------------	--	---------------------------------------	--

<p>RF OUTPUT POWER</p>	<p>WLAN 5 725 MHz ~ 5 850 MHz Band</p>	<p>Antenna 0</p>	<p>11.47 dBm(802.11a) 11.43 dBm(802.11n_HT20) 10.25 dBm(802.11ax_HE20)_26 Tone 10.40 dBm(802.11ax_HE20)_52 Tone 10.13 dBm(802.11ax_HE20)_106 Tone 10.13 dBm(802.11ax_HE20)_242 Tone 11.28 dBm(802.11ax_HE20)_Single User 10.37 dBm(802.11n_HT40) 7.10 dBm(802.11ax_HE40)_26 Tone 7.39 dBm(802.11ax_HE40)_52 Tone 7.69 dBm(802.11ax_HE40)_106 Tone 7.32 dBm(802.11ax_HE40)_242 Tone 7.16 dBm(802.11ax_HE40)_484 Tone 10.38 dBm(802.11ax_HE40)_Single User 8.02 dBm(802.11ac_VHT80) 4.77 dBm(802.11ax_HE40)_26 Tone 4.91 dBm(802.11ax_HE40)_52 Tone 4.76 dBm(802.11ax_HE40)_106 Tone 4.66 dBm(802.11ax_HE40)_242 Tone 4.57 dBm(802.11ax_HE40)_484 Tone 4.48 dBm(802.11ax_HE40)_996 Tone 8.01 dBm(802.11ax_HE40)_Single User</p>
----------------------------	--	------------------	---

<p>RF OUTPUT POWER</p>	<p>WLAN 5 725 MHz ~ 5 850 MHz Band</p>	<p>Antenna 0_Straddle</p>	<p>3.14 dBm(802.11a) 3.50 dBm(802.11n_HT20) 1.68 dBm(802.11ax_HE20)_26 Tone 3.49 dBm(802.11ax_HE20)_52 Tone 3.76 dBm(802.11ax_HE20)_106 Tone 3.11 dBm(802.11ax_HE20)_242 Tone 3.94 dBm(802.11ax_HE20)_Single User -2.90 dBm(802.11n_HT40) 1.45 dBm(802.11ax_HE40)_26 Tone 4.04 dBm(802.11ax_HE40)_52 Tone 3.01 dBm(802.11ax_HE40)_106 Tone -0.30 dBm(802.11ax_HE40)_242 Tone -3.47 dBm(802.11ax_HE40)_484 Tone -2.02 dBm(802.11ax_HE40)_Single User -9.20 dBm(802.11ac_VHT80) 2.00 dBm(802.11ax_HE40)_26 Tone 3.63 dBm(802.11ax_HE40)_52 Tone 0.73 dBm(802.11ax_HE40)_106 Tone -2.85 dBm(802.11ax_HE40)_242 Tone -5.78 dBm(802.11ax_HE40)_484 Tone -8.89 dBm(802.11ax_HE40)_996 Tone -8.06 dBm(802.11ax_HE40)_Single User</p>
----------------------------	--	---------------------------	---

<p>RF OUTPUT POWER</p>	<p>WLAN 5 725 MHz ~ 5 850 MHz Band</p>	<p>Antenna 1</p>	<p>11.78 dBm(802.11a) 11.49 dBm(802.11n_HT20) 11.36 dBm(802.11ax_HE20)_26 Tone 11.55 dBm(802.11ax_HE20)_52 Tone 11.29 dBm(802.11ax_HE20)_106 Tone 11.21 dBm(802.11ax_HE20)_242 Tone 11.16 dBm(802.11ax_HE20)_Single User 10.47 dBm(802.11n_HT40) 8.73 dBm(802.11ax_HE40)_26 Tone 9.01 dBm(802.11ax_HE40)_52 Tone 9.13 dBm(802.11ax_HE40)_106 Tone 8.83 dBm(802.11ax_HE40)_242 Tone 8.72 dBm(802.11ax_HE40)_484 Tone 10.31 dBm(802.11ax_HE40)_Single User 7.69 dBm(802.11ac_VHT80) 6.50 dBm(802.11ax_HE40)_26 Tone 6.53 dBm(802.11ax_HE40)_52 Tone 6.39 dBm(802.11ax_HE40)_106 Tone 6.26 dBm(802.11ax_HE40)_242 Tone 6.26 dBm(802.11ax_HE40)_484 Tone 5.91 dBm(802.11ax_HE40)_996 Tone 7.47 dBm(802.11ax_HE40)_Single User</p>
----------------------------	--	------------------	---

<p>RF OUTPUT POWER</p>	<p>WLAN 5 725 MHz ~ 5 850 MHz Band</p>	<p>Antenna 1_Straddle</p>	<p>3.33 dBm(802.11a) 3.62 dBm(802.11n_HT20) 3.83 dBm(802.11ax_HE20)_26 Tone 5.36 dBm(802.11ax_HE20)_52 Tone 5.47 dBm(802.11ax_HE20)_106 Tone 4.50 dBm(802.11ax_HE20)_242 Tone 4.12 dBm(802.11ax_HE20)_Single User -2.38 dBm(802.11n_HT40) 3.33 dBm(802.11ax_HE40)_26 Tone 5.93 dBm(802.11ax_HE40)_52 Tone 4.85 dBm(802.11ax_HE40)_106 Tone 1.50 dBm(802.11ax_HE40)_242 Tone -1.68 dBm(802.11ax_HE40)_484 Tone -1.56 dBm(802.11ax_HE40)_Single User -8.90 dBm(802.11ac_VHT80) 3.96 dBm(802.11ax_HE40)_26 Tone 5.51 dBm(802.11ax_HE40)_52 Tone 2.53 dBm(802.11ax_HE40)_106 Tone -0.93 dBm(802.11ax_HE40)_242 Tone -3.96 dBm(802.11ax_HE40)_484 Tone -7.03 dBm(802.11ax_HE40)_996 Tone -7.70 dBm(802.11ax_HE40)_Single User</p>
----------------------------	--	---------------------------	--

<p>RF OUTPUT POWER</p>	<p>WLAN 5 725 MHz ~ 5 850 MHz Band</p>	<p>Multiple Antenna</p>	<p>14.34 dBm(802.11n_HT20) 13.70 dBm(802.11ax_HE20)_26 Tone 13.90 dBm(802.11ax_HE20)_52 Tone 13.63 dBm(802.11ax_HE20)_106 Tone 13.54 dBm(802.11ax_HE20)_242 Tone 14.17 dBm(802.11ax_HE20)_Single User 13.43 dBm(802.11n_HT40) 10.97 dBm(802.11ax_HE40)_26 Tone 11.25 dBm(802.11ax_HE40)_52 Tone 11.33 dBm(802.11ax_HE40)_106 Tone 11.04 dBm(802.11ax_HE40)_242 Tone 11.02 dBm(802.11ax_HE40)_484 Tone 13.34 dBm(802.11ax_HE40)_Single User 10.87 dBm(802.11ac_VHT80) 8.60 dBm(802.11ax_HE40)_26 Tone 8.61 dBm(802.11ax_HE40)_52 Tone 8.50 dBm(802.11ax_HE40)_106 Tone 8.50 dBm(802.11ax_HE40)_242 Tone 8.48 dBm(802.11ax_HE40)_484 Tone 8.26 dBm(802.11ax_HE40)_996 Tone 10.76 dBm(802.11ax_HE40)_Single User</p>
----------------------------	--	-------------------------	---

<p>RF OUTPUT POWER</p>	<p>WLAN 5 725 MHz ~ 5 850 MHz Band</p>	<p>Multiple Antenna _Straddle</p>	<p>6.57 dBm(802.11n_HT20) 5.90 dBm(802.11ax_HE20)_26 Tone 7.53 dBm(802.11ax_HE20)_52 Tone 7.71 dBm(802.11ax_HE20)_106 Tone 6.87 dBm(802.11ax_HE20)_242 Tone 7.04 dBm(802.11ax_HE20)_Single User 0.38 dBm(802.11n_HT40) 5.50 dBm(802.11ax_HE40)_26 Tone 8.10 dBm(802.11ax_HE40)_52 Tone 7.05 dBm(802.11ax_HE40)_106 Tone 3.70 dBm(802.11ax_HE40)_242 Tone 0.53 dBm(802.11ax_HE40)_484 Tone 1.23 dBm(802.11ax_HE40)_Single User -6.03 dBm(802.11ac_VHT80) 6.10 dBm(802.11ax_HE40)_26 Tone 7.68 dBm(802.11ax_HE40)_52 Tone 4.73 dBm(802.11ax_HE40)_106 Tone 1.23 dBm(802.11ax_HE40)_242 Tone -1.76 dBm(802.11ax_HE40)_484 Tone -4.85 dBm(802.11ax_HE40)_996 Tone -4.87 dBm(802.11ax_HE40)_Single User</p>
----------------------------	--	---------------------------------------	--

ANTENNA TYPE	Dipole Antenna			
ANTENNA GAIN	Bluetooth LE	7 dBi		
	Bluetooth	7 dBi		
	WLAN 2.4 GHz	Antenna 0	7 dBi	
		Antenna 1	7 dBi	
		Multiple Antenna	10.01 dBi	
	5 150 MHz ~ 5 250 MHz Band	Antenna 0	9 dBi	
		Antenna 1	9 dBi	
		Multiple Antenna	12.01 dBi	
	5 250 MHz ~ 5 350 MHz Band	Antenna 0	9 dBi	
		Antenna 1	9 dBi	
		Multiple Antenna	12.01 dBi	
	5 470 MHz ~ 5 725 MHz Band	Antenna 0	9 dBi	
		Antenna 1	9 dBi	
		Multiple Antenna	12.01 dBi	
	5 725 MHz ~ 5 850 MHz Band	Antenna 0	9 dBi	
		Antenna 1	9 dBi	
		Multiple Antenna	12.01 dBi	
	List of each Osc. or crystal Freq.(Freq. >= 1 MHz)	40 MHz		

3.2 Alternative type(s)/model(s); also covered by this test report.

-. None

4. EUT MODIFICATIONS

-. None

5. SYSTEM TEST CONFIGURATION

5.1 Justification

This device was configured for testing in a typical way as a normal customer is supposed to be used. During the test, the following components were installed inside of the EUT.

DEVICE TYPE	MANUFACTURER	MODEL/PART NUMBER	FCC ID
Main Board	LG Innotek Co., Ltd.	cTP3.0_Rev0.1	N/A

5.2 Peripheral equipment

Defined as equipment needed for correct operation of the EUT, but not considered as tested:

Model	Manufacturer	Description	Connected to
ATC6NPL002	LG Innotek Co., Ltd.	RF Module (EUT)	-
ZUP36-6	NEMIC-LAMBDA	DC Power Supply	EUT
ideapad320	Lenovo	Notebook PC	EUT

5.3 Mode of operation during the test

- Duty Cycle (Antenna 0)

Band	TEST Mode	Data Rate	On Time (ms)	Total Time (ms)	Duty Cycle (%)	Duty Cycle Factor (dB)
UNII (5.5 GHz)	802.11 a	6	1.430	1.445	98.96	0.045
		9	0.960	0.975	98.46	0.067
		12	0.725	0.740	97.97	0.089
		18	0.495	0.510	97.06	0.130
		24	0.378	0.393	96.18	0.169
		36	0.258	0.269	95.91	0.181
		48	0.200	0.214	93.46	0.294
		54	0.180	0.196	91.84	0.370
	802.11 n(HT20)	MCS0	1.340	1.355	98.89	0.048
		MCS1	0.685	0.700	97.86	0.094
		MCS2	0.472	0.486	97.12	0.127
		MCS3	0.364	0.378	96.30	0.164
		MCS4	0.256	0.272	94.12	0.263
		MCS5	0.200	0.214	93.46	0.294
		MCS6	0.184	0.198	92.93	0.318
		MCS7	0.168	0.182	92.31	0.348
	802.11 n(HT40)	MCS0	0.665	0.680	97.79	0.097
		MCS1	0.352	0.368	95.65	0.193
		MCS2	0.248	0.262	94.66	0.238
		MCS3	0.196	0.210	93.33	0.300
		MCS4	0.144	0.160	90.00	0.458
		MCS5	0.116	0.132	87.88	0.561
		MCS6	0.108	0.124	87.10	0.600
		MCS7	0.100	0.116	86.21	0.645
	802.11 ac(VHT80)	MCS0	0.334	0.350	95.43	0.203
		MCS1	0.188	0.204	92.16	0.355
		MCS2	0.144	0.160	90.00	0.458
		MCS3	0.116	0.132	87.88	0.561
		MCS4	0.096	0.112	85.71	0.669
		MCS5	0.080	0.096	83.33	0.792
		MCS6	0.076	0.092	82.61	0.830
		MCS7	0.072	0.088	81.82	0.872
		MCS8	0.068	0.084	80.95	0.918
MCS9		0.064	0.080	80.00	0.969	

- Duty Cycle (Antenna 1)

Band	TEST Mode	Data Rate	On Time (ms)	Total Time (ms)	Duty Cycle (%)	Duty Cycle Factor (dB)
UNII (5.5 GHz)	802.11 a	6	1.430	1.445	98.96	0.045
		9	0.960	0.975	98.46	0.067
		12	0.725	0.740	97.97	0.089
		18	0.490	0.505	97.03	0.131
		24	0.376	0.391	96.16	0.170
		36	0.256	0.267	95.88	0.183
		48	0.200	0.215	93.02	0.314
		54	0.180	0.197	91.37	0.392
	802.11 n(HT20)	MCS0	1.340	1.357	98.75	0.055
		MCS1	0.685	0.702	97.58	0.106
		MCS2	0.472	0.486	97.12	0.127
		MCS3	0.364	0.378	96.30	0.164
		MCS4	0.256	0.272	94.12	0.263
		MCS5	0.200	0.214	93.46	0.294
		MCS6	0.184	0.198	92.93	0.318
		MCS7	0.168	0.182	92.31	0.348
	802.11 n(HT40)	MCS0	0.662	0.680	97.35	0.117
		MCS1	0.350	0.368	95.11	0.218
		MCS2	0.248	0.262	94.66	0.238
		MCS3	0.196	0.210	93.33	0.300
		MCS4	0.144	0.160	90.00	0.458
		MCS5	0.116	0.132	87.88	0.561
		MCS6	0.108	0.124	87.10	0.600
		MCS7	0.100	0.116	86.21	0.645
	802.11 ac(VHT80)	MCS0	0.332	0.348	95.40	0.204
		MCS1	0.188	0.204	92.16	0.355
		MCS2	0.144	0.160	90.00	0.458
		MCS3	0.116	0.132	87.88	0.561
		MCS4	0.096	0.112	85.71	0.669
		MCS5	0.080	0.096	83.33	0.792
		MCS6	0.076	0.092	82.61	0.830
		MCS7	0.072	0.088	81.82	0.872
		MCS8	0.068	0.084	80.95	0.918
		MCS9	0.064	0.080	80.00	0.969

Note – Duty Cycle : (Tx On Time / (Tx On Time + Tx Off Time)) * 100

Correction Factor : 10 * Log(1 / (Duty Cycle / 100))

-. Test Plot_Antenna 0

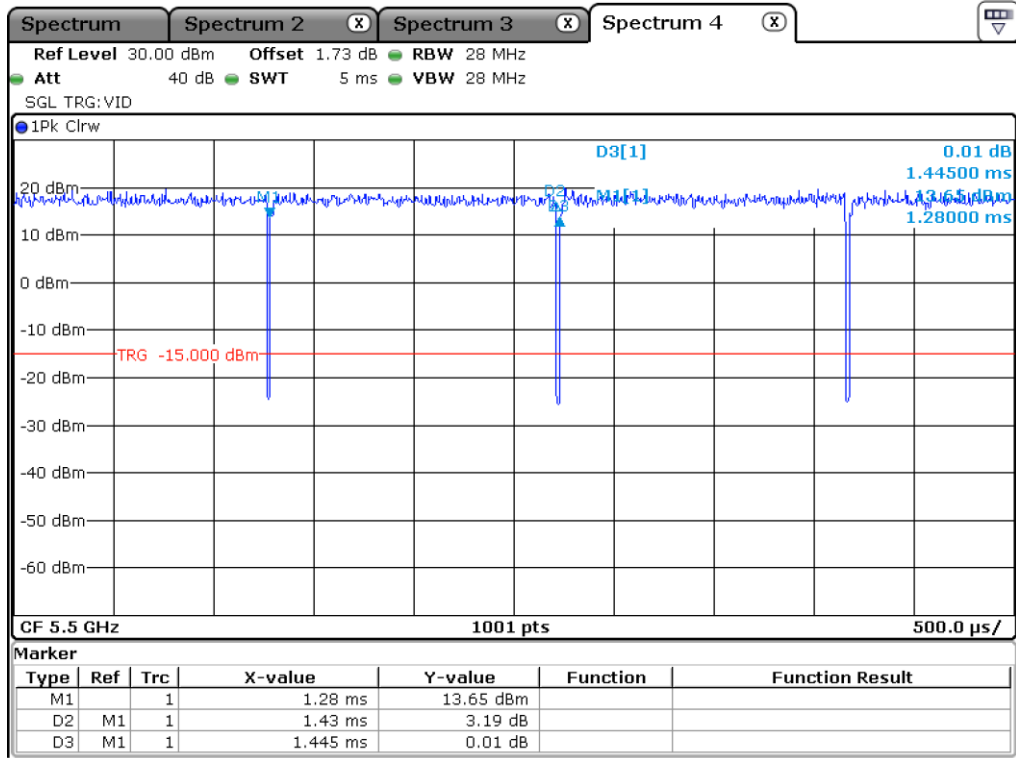

802.11 a

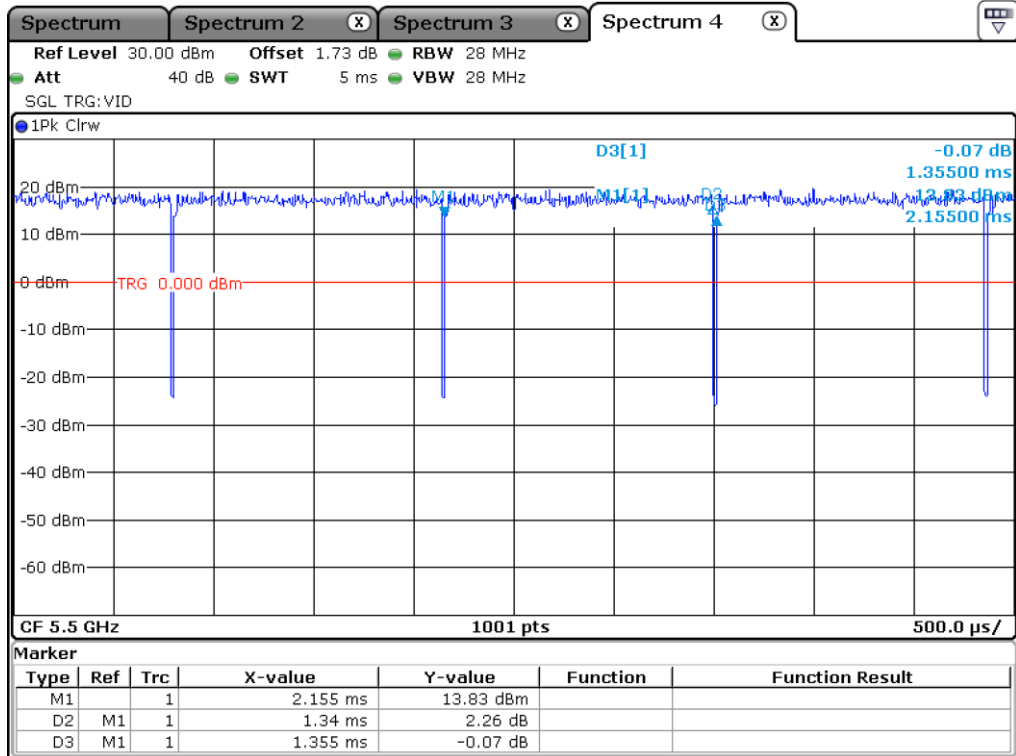

802.11 HT 20

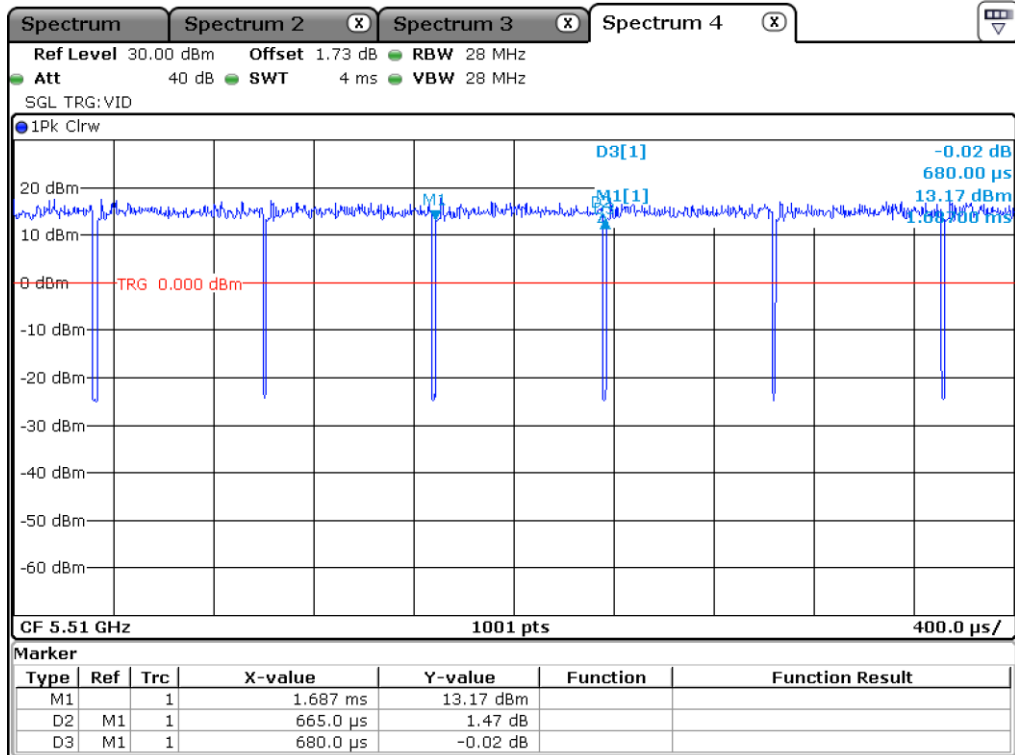

802.11 HT40

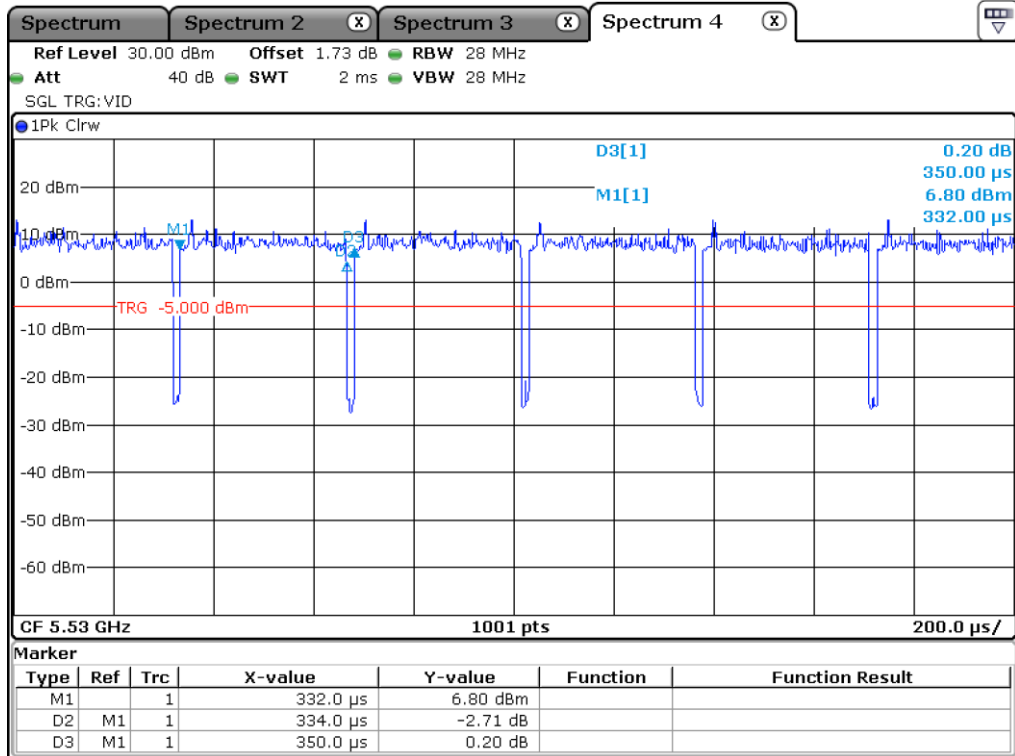

802.11 VHT 80

-. Test Plot_Antenna 1

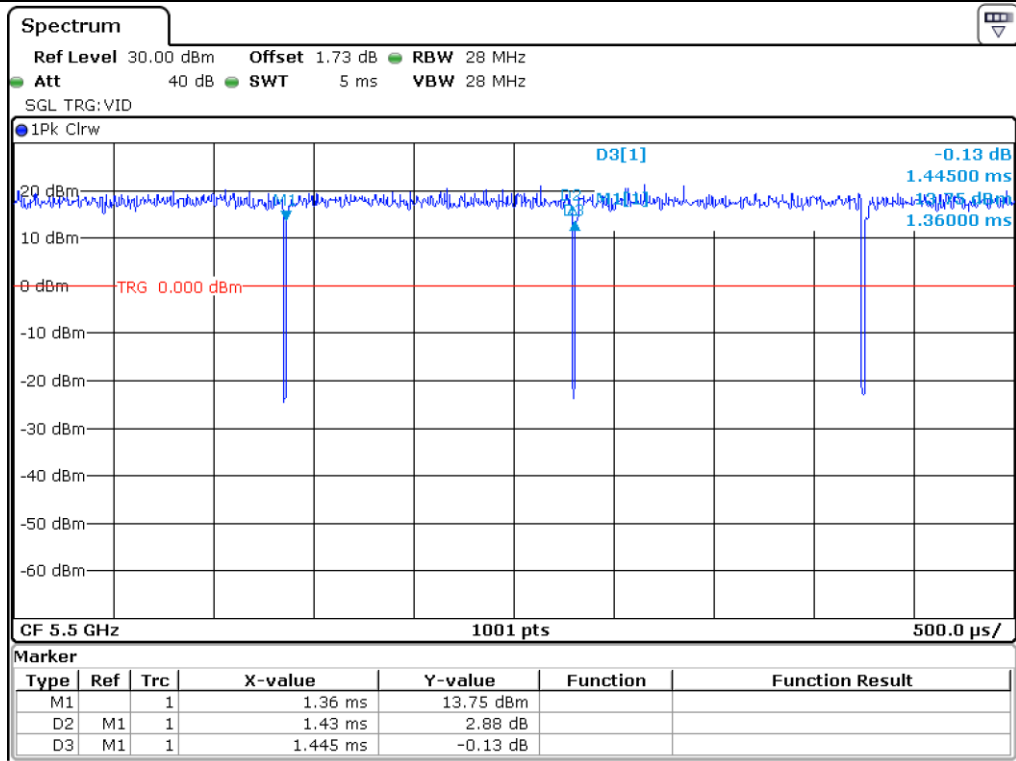

802.11 a

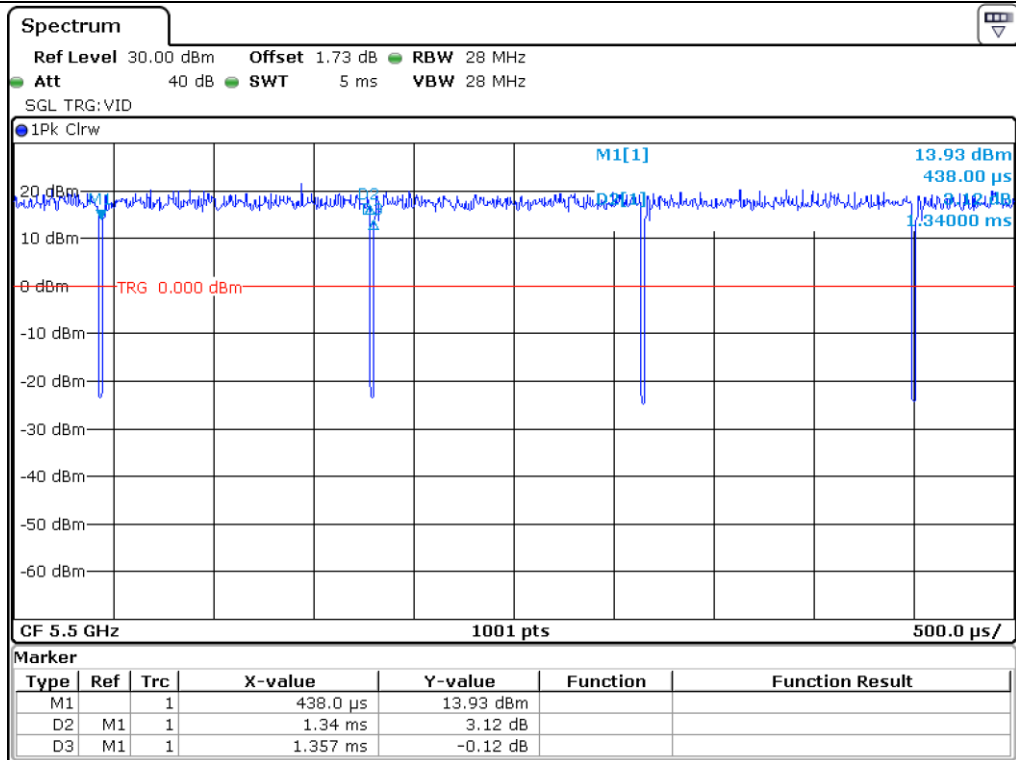

802.11 HT 20

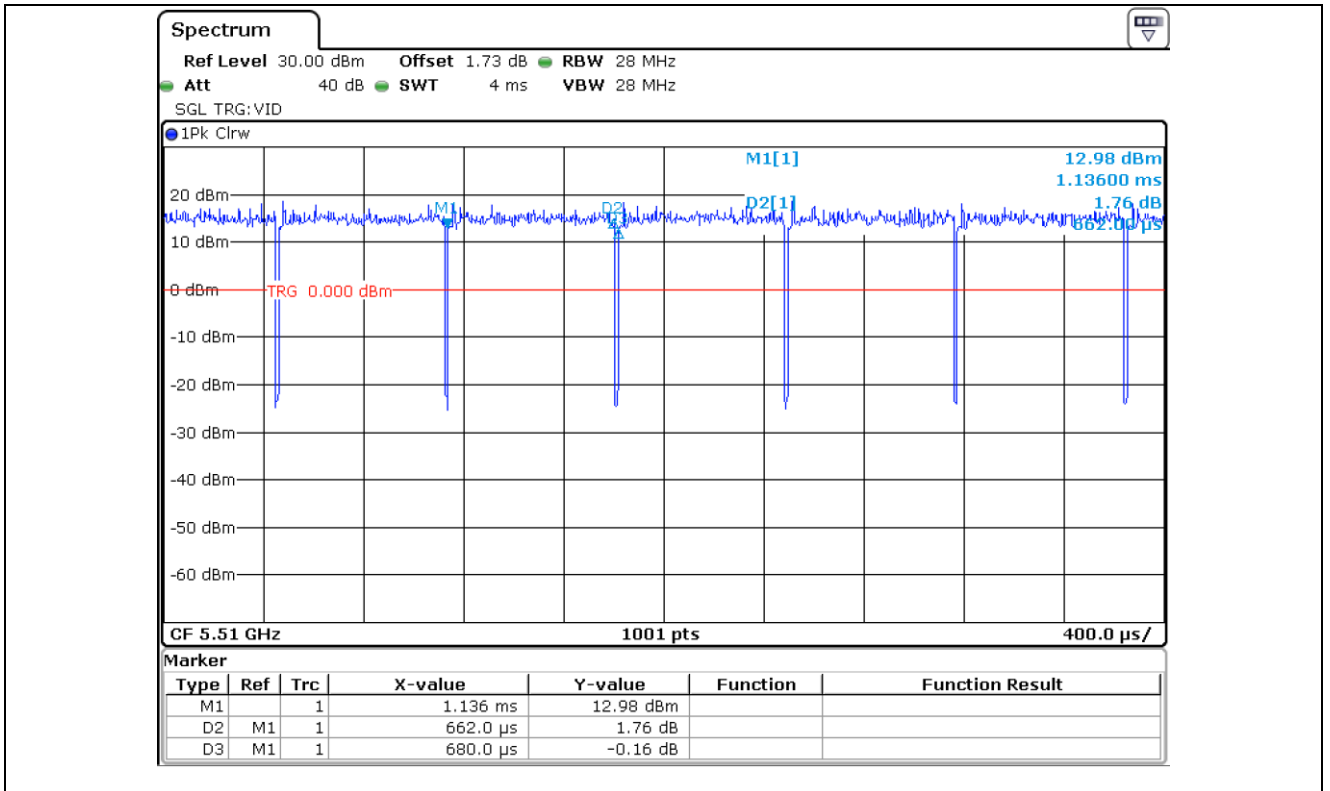

802.11 HT40

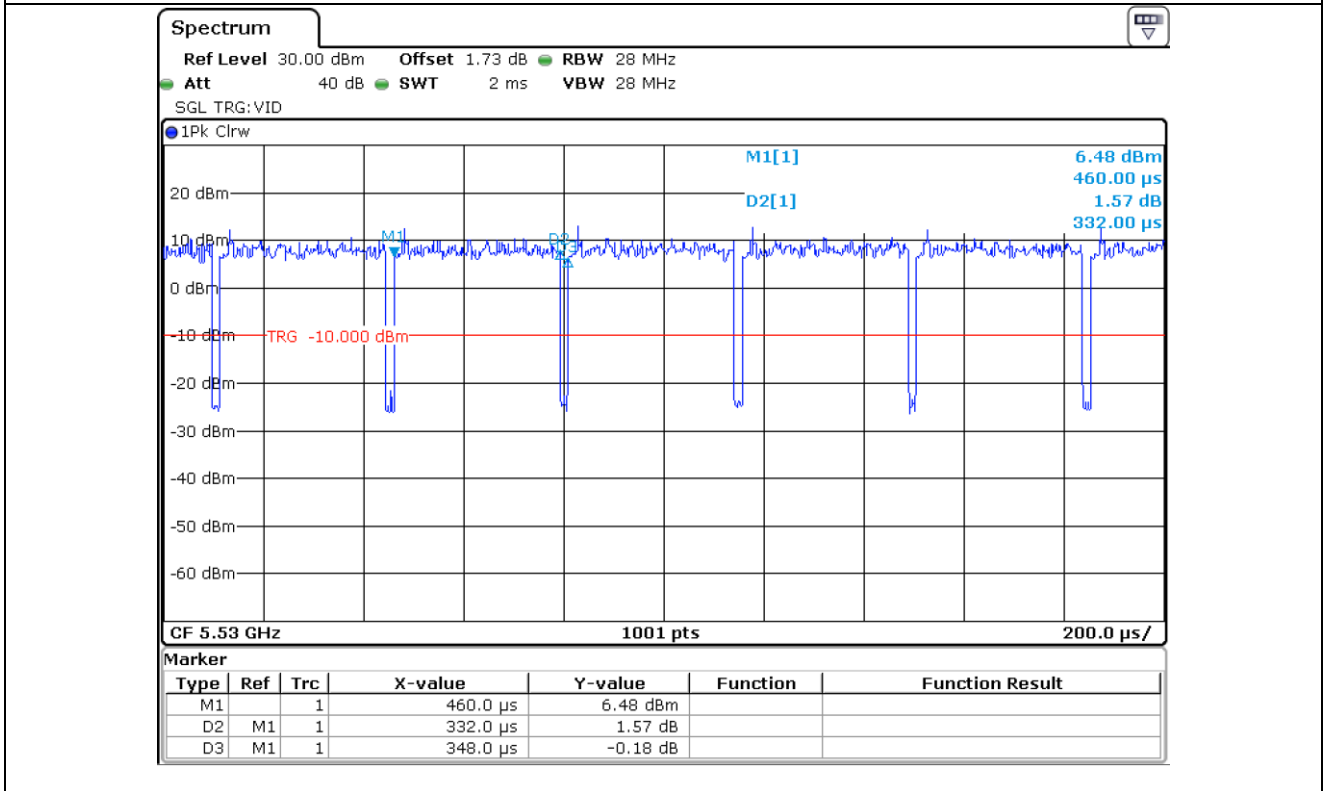

802.11 VHT 80

5.4 Configuration of Test System

Line Conducted Test: The EUT was tested in the Transmitting mode. All supporting equipment were connected to another LISN. Preliminary Power line Conducted Emission test was performed by using the procedure in ANSI C63.10: 2020 to determine the worse operating conditions.

Radiated Emission Test: Preliminary radiated emissions test were conducted using the procedure in ANSI C63.10: 2020 to determine the worse operating conditions. Final radiated emission tests were conducted at 3 meter Semi Anechoic Chamber.

The turntable was rotated through 360 degrees and the EUT was tested by positioned three orthogonal planes to obtain the highest reading on the field strength meter. Once maximum reading was determined, the search antenna was raised and lowered in both vertical and horizontal polarization.

5.5 Antenna Requirement

For intentional device, according to section 15.203, an intentional radiator shall be designed to ensure that no antenna other than that furnished by the responsible party shall be used with the device.

Antenna Construction:

The antenna of the EUT is a Dipole Antenna. However, The manufacture has designed a strucyure that connects to the antenna using a unique coupling connector of the Fakra Type. So no consideration of replacement by the user.

6. PRELIMINARY TEST

6.1 AC Power line Conducted Emissions Tests

During Preliminary Test, the following operating mode was investigated.

Operation Mode	The Worse operating condition (Please check one only)
Transmitting Mode	X

6.2 General Radiated Emissions Tests

During Preliminary Test, the following operating mode was investigated.

Operation Mode	The Worse operating condition (Please check one only)
Transmitting Mode	X

7. 99 % OCCUPIED BANDWIDTH & MIMIMUM 26 dB BANDWIDTH

7.1 Operating environment

Temperature : 24 °C
 Relative humidity : 45 % R.H.

7.2 Test set-up

The antenna output of the EUT was connected to the spectrum analyzer. The resolution bandwidth is set to 1%-5% OBW for 99% bandwidth, and peak detection was used. The 99 % bandwidth is the frequency bandwidth such that, below its lower and above its upper frequency limits, the mean powers are each equal to 0.5 % of the total mean power of the given emission.

The antenna output of the EUT was connected to the spectrum analyzer. The resolution bandwidth is set to approximately 1% of the emission bandwidth, and peak detection was used. The 26 dB bandwidth is defined as the total spectrum over which the power is higher than the peak power minus 26 dB.



7.3 Test Date

December 05, 2021 ~ March 08, 2022

7.4 Test data for 802.11a RLAN Mode

7.4.1 Test data for Antenna 0

7.4.1.1 99 % OCCUPIED BANDWIDTH

-. Test Result : Pass

FREQUENCY RANGE (MHz)	CHANNEL	FREQUENCY (MHz)	99 % Bandwidth (MHz)
5 150 ~ 5 250	Low	5 180.00	16.38
	Middle	5 220.00	16.53
	High	5 240.00	16.38
5 250 ~ 5 350	Low	5 260.00	16.53
	Middle	5 300.00	16.43
	High	5 320.00	16.38
5 470 ~ 5 725	Low	5 500.00	16.48
	Middle	5 580.00	16.43
	High	5 700.00	16.43
5 725 ~ 5 850	Low	5 745.00	16.43
	Middle	5 785.00	16.43
	High	5 825.00	16.48

7.4.1.2 MINIMUM 26 dB BANDWIDTH

-. Test Result : Pass

FREQUENCY RANGE (MHz)	CHANNEL	FREQUENCY (MHz)	26 dB Bandwidth (MHz)
5 150 ~ 5 250	Low	5 180.00	19.58
	Middle	5 220.00	18.88
	High	5 240.00	19.73
5 250 ~ 5 350	Low	5 260.00	19.48
	Middle	5 300.00	18.78
	High	5 320.00	19.28
5 470 ~ 5 725	Low	5 500.00	19.18
	Middle	5 580.00	19.23
	High	5 700.00	19.33
5 725 ~ 5 850	Low	5 745.00	20.03
	Middle	5 785.00	19.83
	High	5 825.00	19.78

[Staddle Channel]

FREQUENCY RANGE (MHz)	FREQUENCY (MHz)	26 dB Bandwidth (MHz)
5 470 ~ 5 725	5 720.00	14.59
5 725 ~ 5 850	5 720.00	4.54

Remark: See next page for measurement data.

7.4.2 Test data for Antenna 1

7.4.2.1 99 % OCCUPIED BANDWIDTH

-. Test Result : Pass

FREQUENCY RANGE (MHz)	CHANNEL	FREQUENCY (MHz)	99 % Bandwidth (MHz)
5 150 ~ 5 250	Low	5 180.00	16.43
	Middle	5 220.00	16.43
	High	5 240.00	16.43
5 250 ~ 5 350	Low	5 260.00	16.38
	Middle	5 300.00	16.43
	High	5 320.00	16.43
5 470 ~ 5 725	Low	5 500.00	16.48
	Middle	5 580.00	16.38
	High	5 700.00	16.43
5 725 ~ 5 850	Low	5 745.00	16.43
	Middle	5 785.00	16.48
	High	5 825.00	16.43

7.4.2.2 MINIMUM 26 dB BANDWIDTH

-. Test Result : Pass

FREQUENCY RANGE (MHz)	CHANNEL	FREQUENCY (MHz)	26 dB Bandwidth (MHz)
5 150 ~ 5 250	Low	5 180.00	19.18
	Middle	5 220.00	19.13
	High	5 240.00	19.03
5 250 ~ 5 350	Low	5 260.00	19.33
	Middle	5 300.00	19.28
	High	5 320.00	19.48
5 470 ~ 5 725	Low	5 500.00	19.18
	Middle	5 580.00	19.28
	High	5 700.00	19.23
5 725 ~ 5 850	Low	5 745.00	19.83
	Middle	5 785.00	19.88
	High	5 825.00	19.83

[Staddle Channel]

FREQUENCY RANGE (MHz)	FREQUENCY (MHz)	26 dB Bandwidth (MHz)
5 470 ~ 5 725	5 720.00	14.69
5 725 ~ 5 850	5 720.00	4.64

Remark: See next page for measurement data.

7.5 Test data for 802.11n_HT20 RLAN Mode

7.5.1 Test data for Antenna 0

7.5.1.1 99 % OCCUPIED BANDWIDTH

-. Test Result : Pass

FREQUENCY RANGE (MHz)	CHANNEL	FREQUENCY (MHz)	99 % Bandwidth (MHz)
5 150 ~ 5 250	Low	5 180.00	17.58
	Middle	5 220.00	17.58
	High	5 240.00	17.63
5 250 ~ 5 350	Low	5 260.00	17.63
	Middle	5 300.00	17.73
	High	5 320.00	17.63
5 470 ~ 5 725	Low	5 500.00	17.63
	Middle	5 580.00	17.63
	High	5 700.00	17.58
5 725 ~ 5 850	Low	5 745.00	17.58
	Middle	5 785.00	17.63
	High	5 825.00	17.63

7.5.1.2 MINIMUM 26 dB BANDWIDTH

-. Test Result : Pass

FREQUENCY RANGE (MHz)	CHANNEL	FREQUENCY (MHz)	26 dB Bandwidth (MHz)
5 150 ~ 5 250	Low	5 180.00	19.68
	Middle	5 220.00	19.73
	High	5 240.00	19.83
5 250 ~ 5 350	Low	5 260.00	19.68
	Middle	5 300.00	19.68
	High	5 320.00	19.78
5 470 ~ 5 725	Low	5 500.00	19.48
	Middle	5 660.00	19.98
	High	5 700.00	19.63
5 725 ~ 5 850	Low	5 745.00	19.93
	Middle	5 785.00	19.73
	High	5 825.00	19.13

[Staddle Channel]

FREQUENCY RANGE (MHz)	FREQUENCY (MHz)	26 dB Bandwidth (MHz)
5 470 ~ 5 725	5 720.00	14.84
5 725 ~ 5 850	5 720.00	4.84

Remark: See next page for measurement data.

7.5.2 Test data for Antenna 1

7.5.2.1 99 % OCCUPIED BANDWIDTH

-. Test Result : Pass

FREQUENCY RANGE (MHz)	CHANNEL	FREQUENCY (MHz)	99 % Bandwidth (MHz)
5 150 ~ 5 250	Low	5 180.00	17.58
	Middle	5 220.00	17.58
	High	5 240.00	17.58
5 250 ~ 5 350	Low	5 260.00	17.63
	Middle	5 300.00	17.58
	High	5 320.00	17.63
5 470 ~ 5 725	Low	5 500.00	17.58
	Middle	5 580.00	17.58
	High	5 700.00	17.58
5 725 ~ 5 850	Low	5 745.00	17.58
	Middle	5 785.00	17.63
	High	5 825.00	17.58

7.5.2.2 MINIMUM 26 dB BANDWIDTH

-. Test Result : Pass

FREQUENCY RANGE (MHz)	CHANNEL	FREQUENCY (MHz)	26 dB Bandwidth (MHz)
5 150 ~ 5 250	Low	5 180.00	19.58
	Middle	5 220.00	19.78
	High	5 240.00	19.48
5 250 ~ 5 350	Low	5 260.00	19.58
	Middle	5 300.00	19.58
	High	5 320.00	19.53
5 470 ~ 5 725	Low	5 500.00	19.73
	Middle	5 580.00	19.88
	High	5 700.00	19.58
5 725 ~ 5 850	Low	5 745.00	19.13
	Middle	5 785.00	19.38
	High	5 825.00	19.48

[Staddle Channel]

FREQUENCY RANGE (MHz)	FREQUENCY (MHz)	26 dB Bandwidth (MHz)
5 470 ~ 5 725	5 720.00	14.74
5 725 ~ 5 850	5 720.00	4.84

Remark: See next page for measurement data.

7.6 Test data for 802.11n_HT40 RLAN Mode

7.6.1 Test data for Antenna 0

7.6.1.1 99 % OCCUPIED BANDWIDTH

-. Test Result : Pass

FREQUENCY RANGE (MHz)	CHANNEL	FREQUENCY (MHz)	99 % Bandwidth (MHz)
5 150 ~ 5 250	Low	5 190.00	36.16
	High	5 230.00	36.06
5 250 ~ 5 350	Low	5 270.00	35.96
	High	5 310.00	36.06
5 470 ~ 5 725	Low	5 510.00	36.06
	Middle	5 550.00	36.06
	High	5 670.00	36.06
5 725 ~ 5 850	Low	5 755.00	36.16
	High	5 795.00	36.16

7.6.1.2 MINIMUM 26 dB BANDWIDTH

-. Test Result : Pass

FREQUENCY RANGE (MHz)	CHANNEL	FREQUENCY (MHz)	26 dB Bandwidth (MHz)
5 150 ~ 5 250	Low	5 190.00	39.36
	High	5 230.00	39.46
5 250 ~ 5 350	Low	5 270.00	39.96
	High	5 310.00	39.36
5 470 ~ 5 725	Low	5 510.00	39.66
	Middle	5 550.00	39.76
	High	5 670.00	39.66
5 725 ~ 5 850	Low	5 755.00	39.36
	High	5 795.00	39.56

[Staddle Channel]

FREQUENCY RANGE (MHz)	FREQUENCY (MHz)	26 dB Bandwidth (MHz)
5 470 ~ 5 725	5 710.00	34.58
5 725 ~ 5 850	5 710.00	4.68

Remark: See next page for measurement data.

7.6.2 Test data for Antenna 1

7.6.2.1 99 % OCCUPIED BANDWIDTH

-. Test Result : Pass

FREQUENCY RANGE (MHz)	CHANNEL	FREQUENCY (MHz)	99 % Bandwidth (MHz)
5 150 ~ 5 250	Low	5 190.00	36.06
	High	5 230.00	36.26
5 250 ~ 5 350	Low	5 270.00	36.06
	High	5 310.00	36.16
5 470 ~ 5 725	Low	5 510.00	36.06
	Middle	5 550.00	36.16
	High	5 670.00	36.06
5 725 ~ 5 850	Low	5 755.00	36.36
	High	5 795.00	36.26

7.6.2.2 MINIMUM 26 dB BANDWIDTH

-. Test Result : Pass

FREQUENCY RANGE (MHz)	CHANNEL	FREQUENCY (MHz)	26 dB Bandwidth (MHz)
5 150 ~ 5 250	Low	5 190.00	39.66
	High	5 230.00	40.06
5 250 ~ 5 350	Low	5 270.00	40.66
	High	5 310.00	40.46
5 470 ~ 5 725	Low	5 510.00	40.36
	Middle	5 550.00	40.26
	High	5 670.00	40.06
5 725 ~ 5 850	Low	5 755.00	40.46
	High	5 795.00	40.36

[Staddle Channel]

FREQUENCY RANGE (MHz)	FREQUENCY (MHz)	26 dB Bandwidth (MHz)
5 470 ~ 5 725	5 710.00	35.28
5 725 ~ 5 850	5 710.00	5.18

Remark: See next page for measurement data.

7.7 Test data for 802.11ac_VHT80 RLAN Mode

7.7.1 Test data for Antenna 0

7.7.1.1 99 % OCCUPIED BANDWIDTH

-. Test Result : Pass

FREQUENCY RANGE (MHz)	CHANNEL	FREQUENCY (MHz)	99 % Bandwidth (MHz)
5 150 ~ 5 250	Middle	5 210.00	75.72
5 250 ~ 5 350	Middle	5 290.00	76.12
5 470 ~ 5 725	Middle	5 530.00	76.32
5 725 ~ 5 850	Middle	5 775.00	76.12

7.7.1.2 MINIMUM 26 dB BANDWIDTH

-. Test Result : Pass

FREQUENCY RANGE (MHz)	CHANNEL	FREQUENCY (MHz)	26 dB Bandwidth (MHz)
5 150 ~ 5 250	Middle	5 210.00	81.52
5 250 ~ 5 350	Middle	5 290.00	80.95
5 470 ~ 5 725	Middle	5 530.00	80.12
5 725 ~ 5 850	Middle	5 775.00	79.52

[Staddle Channel]

FREQUENCY RANGE (MHz)	FREQUENCY (MHz)	26 dB Bandwidth (MHz)
5 470 ~ 5 725	5 690.00	75.76
5 725 ~ 5 850	5 690.00	5.76

Remark: See next page for measurement data.

7.7.2 Test data for Antenna 1

7.7.2.1 99 % OCCUPIED BANDWIDTH

-. Test Result : Pass

FREQUENCY RANGE (MHz)	CHANNEL	FREQUENCY (MHz)	99 % Bandwidth (MHz)
5 150 ~ 5 250	Middle	5 210.00	75.92
5 250 ~ 5 350	Middle	5 290.00	76.32
5 470 ~ 5 725	Middle	5 530.00	76.12
5 725 ~ 5 850	Middle	5 775.00	76.12

7.7.2.2 MINIMUM 26 dB BANDWIDTH

-. Test Result : Pass

FREQUENCY RANGE (MHz)	CHANNEL	FREQUENCY (MHz)	26 dB Bandwidth (MHz)
5 150 ~ 5 250	Middle	5 210.00	81.12
5 250 ~ 5 350	Middle	5 290.00	81.32
5 470 ~ 5 725	Middle	5 530.00	81.72
5 725 ~ 5 850	Middle	5 775.00	81.52

[Staddle Channel]

FREQUENCY RANGE (MHz)	FREQUENCY (MHz)	26 dB Bandwidth (MHz)
5 470 ~ 5 725	5 690.00	75.56
5 725 ~ 5 850	5 690.00	6.16

Remark: See next page for measurement data.

8. 6 dB BANDWIDTH

8.1 Operating environment

Temperature : 23 °C
 Relative humidity : 45 % R.H.

8.2 Test set-up

The antenna output of the EUT was connected to the spectrum analyzer. The resolution bandwidth is set to 100 kHz, and peak detection was used. The 6 dB bandwidth is defined as the total spectrum over which the power is higher than the peak power minus 6 dB.

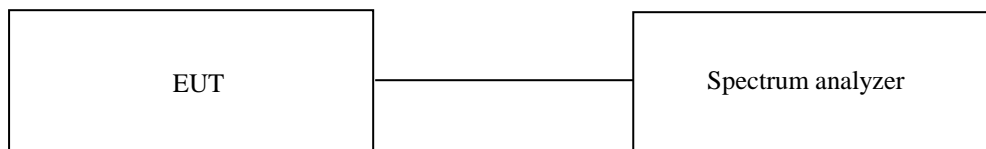

8.3 Test Date

December 05, 2021 ~ March 08, 2022

8.4 Test data for 802.11a RLAN Mode

8.4.1 Test data for Antenna 0

-. Test Result : Pass

FREQUENCY RANGE (MHz)	CHANNEL	FREQUENCY (MHz)	6 dB Bandwidth (MHz)
5 725 ~ 5 850	Low	5 745.00	16.33
	Middle	5 785.00	16.33
	High	5 825.00	16.33

8.4.2 Test data for Antenna 1

-. Test Result : Pass

FREQUENCY RANGE (MHz)	CHANNEL	FREQUENCY (MHz)	6 dB Bandwidth (MHz)
5 725 ~ 5 850	Low	5 745.00	16.33
	Middle	5 785.00	16.33
	High	5 825.00	16.33

8.4.3 Test data for Staddle Channel_Antenna 0

-. Test Result : Pass

FREQUENCY RANGE (MHz)	FREQUENCY (MHz)	6 dB Bandwidth (MHz)
5 470 ~ 5 725	5 720.00	13.14
5 725 ~ 5 850	5 720.00	3.19

8.4.4 Test data for Staddle Channel_Antenna 1

-. Test Result : Pass

FREQUENCY RANGE (MHz)	FREQUENCY (MHz)	6 dB Bandwidth (MHz)
5 470 ~ 5 725	5 720.00	13.14
5 725 ~ 5 850	5 720.00	3.19

8.5 Test data for 802.11n_HT20 RLAN Mode

8.5.1 Test data for Antenna 0

-. Test Result : Pass

FREQUENCY RANGE (MHz)	CHANNEL	FREQUENCY (MHz)	6 dB Bandwidth (MHz)
5 725 ~ 5 850	Low	5 745.00	17.63
	Middle	5 785.00	17.53
	High	5 825.00	17.63

8.5.2 Test data for Antenna 1

-. Test Result : Pass

FREQUENCY RANGE (MHz)	CHANNEL	FREQUENCY (MHz)	6 dB Bandwidth (MHz)
5 725 ~ 5 850	Low	5 745.00	17.53
	Middle	5 785.00	17.53
	High	5 825.00	17.53

8.5.3 Test data for Staddle Channel_Antenna 0

-. Test Result : Pass

FREQUENCY RANGE (MHz)	FREQUENCY (MHz)	6 dB Bandwidth (MHz)
5 470 ~ 5 725	5 720.00	13.79
5 725 ~ 5 850	5 720.00	3.89

8.5.4 Test data for Staddle Channel_Antenna 1

-. Test Result : Pass

FREQUENCY RANGE (MHz)	FREQUENCY (MHz)	6 dB Bandwidth (MHz)
5 470 ~ 5 725	5 720.00	13.74
5 725 ~ 5 850	5 720.00	3.79

8.6 Test data for 802.11n_HT40 RLAN Mode

8.6.1 Test data for Antenna 0

-. Test Result : Pass

FREQUENCY RANGE (MHz)	CHANNEL	FREQUENCY (MHz)	6 dB Bandwidth (MHz)
5 725 ~ 5 850	Low	5 755.00	35.56
	High	5 795.00	35.76

8.6.2 Test data for Antenna 1

-. Test Result : Pass

FREQUENCY RANGE (MHz)	CHANNEL	FREQUENCY (MHz)	6 dB Bandwidth (MHz)
5 725 ~ 5 850	Low	5 755.00	35.56
	High	5 795.00	35.66

Remark: See next page for measurement data.

8.6.3 Test data for Staddle Channel_Antenna 0

-. Test Result : Pass

FREQUENCY RANGE (MHz)	FREQUENCY (MHz)	6 dB Bandwidth (MHz)
5 470 ~ 5 725	5 710.00	33.08
5 725 ~ 5 850	5 710.00	3.18

8.6.4 Test data for Staddle Channel_Antenna 1

-. Test Result : Pass

FREQUENCY RANGE (MHz)	FREQUENCY (MHz)	6 dB Bandwidth (MHz)
5 470 ~ 5 725	5 710.00	32.78
5 725 ~ 5 850	5 710.00	2.88

8.7 Test data for 802.11ac_VHT80 RLAN Mode

8.7.1 Test data for Antenna 0

-. Test Result : Pass

FREQUENCY RANGE (MHz)	CHANNEL	FREQUENCY (MHz)	6 dB Bandwidth (MHz)
5 725 ~ 5 850	Middle	5 775.00	76.12

Remark: See next page for measurement data.

8.7.2 Test data for Antenna 1

-. Test Result : Pass

FREQUENCY RANGE (MHz)	CHANNEL	FREQUENCY (MHz)	6 dB Bandwidth (MHz)
5 725 ~ 5 850	Middle	5 775.00	76.52

Remark: See next page for measurement data.

8.7.3 Test data for Staddle Channel_Antenna 0

-. Test Result : Pass

FREQUENCY RANGE (MHz)	FREQUENCY (MHz)	6 dB Bandwidth (MHz)
5 470 ~ 5 725	5 690.00	73.16
5 725 ~ 5 850	5 690.00	3.16

8.7.4 Test data for Staddle Channel_Antenna 1

-. Test Result : Pass

FREQUENCY RANGE (MHz)	FREQUENCY (MHz)	6 dB Bandwidth (MHz)
5 470 ~ 5 725	5 690.00	73.16
5 725 ~ 5 850	5 690.00	3.36

9. MAXIMUM PEAK OUTPUT POWER

9.1 Operating environment

Temperature : 23 °C
 Relative humidity : 45 % R.H.

9.2 Test set-up

The maximum peak output power was measured with the Power Meter connected to the antenna output of the EUT. The EUT was operating in transmit mode at the appropriate center frequency. The test of the staddle channel is performed by spectrum.

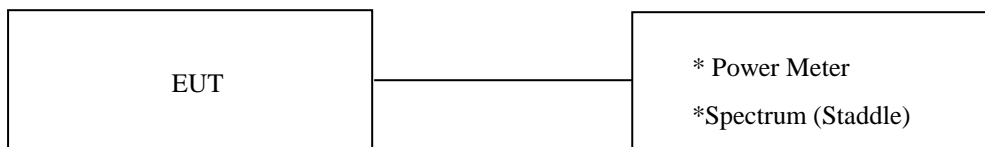

9.3 Test Date

December 05, 2021 ~ March 08, 2022

9.4 Test data for 802.11a RLAN Mode

9.4.1 Test data for Antenna 0

-. Test Result : Pass

-. Duty Cycle : 98.96 %

FREQUENCY RANGE (MHz)	CHANNEL	FREQUENCY (MHz)	MEASURED VALUE (dBm)	Duty Factor (dB)	Total Value (dBm)	LIMIT (dBm)	MARGIN (dB)
5 150 ~ 5 250	Low	5 180.00	11.60	0.045	11.65	21.00	9.36
	Middle	5 220.00	12.28	0.045	12.33	21.00	8.68
	High	5 240.00	12.54	0.045	12.59	21.00	8.42
5 250 ~ 5 350	Low	5 260.00	12.33	0.045	12.38	21.00	8.63
	Middle	5 300.00	12.13	0.045	12.18	21.00	8.83
	High	5 320.00	12.29	0.045	12.34	21.00	8.67
5 470 ~ 5 725	Low	5 500.00	11.42	0.045	11.47	21.00	9.54
	Middle	5 580.00	12.19	0.045	12.24	21.00	8.77
	High	5 700.00	11.70	0.045	11.75	21.00	9.26
5 725 ~ 5 850	Low	5 745.00	11.08	0.045	11.13	27.00	15.88
	Middle	5 785.00	11.42	0.045	11.47	27.00	15.54
	High	5 825.00	10.52	0.045	10.57	27.00	16.44

Remark : Margin = Limit –Total Value (=Measured Value +Duty Factor)

9.4.2 Test data for Antenna 1

-. Test Result : Pass

-. Duty Cycle : 98.96 %

FREQUENCY RANGE (MHz)	CHANNEL	FREQUENCY (MHz)	MEASURED VALUE (dBm)	Duty Factor (dB)	Total Value (dBm)	LIMIT (dBm)	MARGIN (dB)
5 150 ~ 5 250	Low	5 180.00	11.49	0.045	11.54	21.00	9.47
	Middle	5 220.00	12.21	0.045	12.26	21.00	8.75
	High	5 240.00	12.40	0.045	12.45	21.00	8.56
5 250 ~ 5 350	Low	5 260.00	12.34	0.045	12.39	21.00	8.62
	Middle	5 300.00	11.94	0.045	11.99	21.00	9.02
	High	5 320.00	12.11	0.045	12.16	21.00	8.85
5 470 ~ 5 725	Low	5 500.00	11.76	0.045	11.81	21.00	9.20
	Middle	5 580.00	12.45	0.045	12.50	21.00	8.51
	High	5 700.00	11.44	0.045	11.49	21.00	9.52
5 725 ~ 5 850	Low	5 745.00	11.73	0.045	11.78	27.00	15.23
	Middle	5 785.00	11.52	0.045	11.57	27.00	15.44
	High	5 825.00	11.25	0.045	11.30	27.00	15.71

Remark : Margin = Limit – Total Value (=Measured Value +Duty Factor)

9.4.3 Test data for Staddle Channel_Antenna 0

-. Test Result : Pass

-. Duty Cycle : 98.96 %

FREQUENCY RANGE (MHz)	CHANNEL	FREQUENCY (MHz)	MEASURED VALUE (dBm)	Duty Factor (dB)	Total Value (dBm)	LIMIT (dBm)	MARGIN (dB)
5 470 ~ 5 725	Middle	5 720.00	9.27	0.045	9.32	21.00	11.69
5 725 ~ 5 850	Middle	5 720.00	3.09	0.045	3.14	27.00	23.87

Remark : Margin = Limit –Total Value (=Measured Value +Duty Factor)

9.4.4 Test data for Staddle Channel_Antenna 1

-. Test Result : Pass

-. Duty Cycle : 98.96 %

FREQUENCY RANGE (MHz)	CHANNEL	FREQUENCY (MHz)	MEASURED VALUE (dBm)	Duty Factor (dB)	Total Value (dBm)	LIMIT (dBm)	MARGIN (dB)
5 470 ~ 5 725	Middle	5 720.00	9.37	0.045	9.42	21.00	11.59
5 725 ~ 5 850	Middle	5 720.00	3.28	0.045	3.33	27.00	23.68

Remark : Margin = Limit –Total Value (=Measured Value +Duty Factor)

9.5 Test data for 802.11n_HT20 RLAN Mode

9.5.1 Test data for Antenna 0

-. Test Result : Pass

-. Duty Cycle : 98.89 %

FREQUENCY RANGE (MHz)	CHANNEL	FREQUENCY (MHz)	MEASURED VALUE (dBm)	Duty Factor (dB)	Total Value (dBm)	LIMIT (dBm)	MARGIN (dB)
5 150 ~ 5 250	Low	5 180.00	11.23	0.048	11.28	21.00	9.72
	Middle	5 220.00	11.86	0.048	11.91	21.00	9.09
	High	5 240.00	12.10	0.048	12.15	21.00	8.85
5 250 ~ 5 350	Low	5 260.00	11.85	0.048	11.90	21.00	9.10
	Middle	5 300.00	11.59	0.048	11.64	21.00	9.36
	High	5 320.00	11.78	0.048	11.83	21.00	9.17
5 470 ~ 5 725	Low	5 500.00	10.94	0.048	10.99	21.00	10.01
	Middle	5 580.00	11.71	0.048	11.76	21.00	9.24
	High	5 700.00	11.12	0.048	11.17	21.00	9.83
5 725 ~ 5 850	Low	5 745.00	11.12	0.048	11.17	27.00	15.83
	Middle	5 785.00	11.38	0.048	11.43	27.00	15.57
	High	5 825.00	10.61	0.048	10.66	27.00	16.34

Remark : Margin = Limit –Total Value (=Measured Value +Duty Factor)

9.5.2 Test data for Antenna 1

-. Test Result : Pass

-. Duty Cycle : 98.75 %

FREQUENCY RANGE (MHz)	CHANNEL	FREQUENCY (MHz)	MEASURED VALUE (dBm)	Duty Factor (dB)	Total Value (dBm)	LIMIT (dBm)	MARGIN (dB)
5 150 ~ 5 250	Low	5 180.00	11.33	0.055	11.39	21.00	9.62
	Middle	5 220.00	11.77	0.055	11.83	21.00	9.18
	High	5 240.00	11.95	0.055	12.01	21.00	9.00
5 250 ~ 5 350	Low	5 260.00	11.77	0.055	11.83	21.00	9.18
	Middle	5 300.00	11.74	0.055	11.80	21.00	9.21
	High	5 320.00	11.88	0.055	11.94	21.00	9.07
5 470 ~ 5 725	Low	5 500.00	11.34	0.055	11.40	21.00	9.61
	Middle	5 580.00	11.83	0.055	11.89	21.00	9.12
	High	5 700.00	10.88	0.055	10.94	21.00	10.07
5 725 ~ 5 850	Low	5 745.00	11.43	0.055	11.49	27.00	15.52
	Middle	5 785.00	10.92	0.055	10.98	27.00	16.03
	High	5 825.00	10.75	0.055	10.81	27.00	16.20

Remark : Margin = Limit – Total Value (=Measured Value +Duty Factor)

9.5.3 Test data for Multiple Transmit

-. Test Result : Pass

FREQUENCY RANGE (MHz)	CHANNEL	FREQUENCY (MHz)	ANT 0 TOTAL VALUE (dBm)	ANT 1 TOTAL VALUE (dBm)	ANT0 + ANT1 TOTAL VALUE (dBm)	LIMIT (dBm)	MARGIN (dB)
5 150 ~ 5 250	Low	5 180.00	11.28	11.39	14.34	18.00	3.66
	Middle	5 220.00	11.91	11.83	14.88	18.00	3.12
	High	5 240.00	12.15	12.01	15.09	18.00	2.91
5 250 ~ 5 350	Low	5 260.00	11.90	11.83	14.87	18.00	3.13
	Middle	5 300.00	11.64	11.80	14.73	18.00	3.27
	High	5 320.00	11.83	11.94	14.89	18.00	3.11
5 470 ~ 5 725	Low	5 500.00	10.99	11.40	14.21	18.00	3.79
	Middle	5 580.00	11.76	11.89	14.83	18.00	3.17
	High	5 700.00	11.17	10.94	14.06	18.00	3.94
5 725 ~ 5 850	Low	5 745.00	11.17	11.49	14.34	24.00	9.66
	Middle	5 785.00	11.43	10.98	14.22	24.00	9.78
	High	5 825.00	10.66	10.81	13.74	24.00	10.26

Remark : Margin = Limit – Measured Value

9.5.4 Test data for Staddle Channel_Antenna 0

-. Test Result : Pass

-. Duty Cycle : 88.89 %

FREQUENCY RANGE (MHz)	CHANNEL	FREQUENCY (MHz)	MEASURED VALUE (dBm)	Duty Factor (dB)	Total Value (dBm)	LIMIT (dBm)	MARGIN (dB)
5 470 ~ 5 725	Middle	5 720.00	9.15	0.048	9.20	21.00	11.80
5 725 ~ 5 850	Middle	5 720.00	3.45	0.048	3.50	27.00	23.50

Remark : Margin = Limit –Total Value (=Measured Value +Duty Factor)

9.5.5 Test data for Staddle Channel_Antenna 1

-. Test Result : Pass

-. Duty Cycle : 88.75 %

FREQUENCY RANGE (MHz)	CHANNEL	FREQUENCY (MHz)	MEASURED VALUE (dBm)	Duty Factor (dB)	Total Value (dBm)	LIMIT (dBm)	MARGIN (dB)
5 470 ~ 5 725	Middle	5 720.00	9.17	0.055	9.23	21.00	11.78
5 725 ~ 5 850	Middle	5 720.00	3.56	0.055	3.62	27.00	23.39

Remark : Margin = Limit –Total Value (=Measured Value +Duty Factor)

9.5.6 Test data for Staddle Channel_Multiple Transmit

-. Test Result : Pass

FREQUENCY RANGE (MHz)	CHANNEL	FREQUENCY (MHz)	ANT 0 TOTAL VALUE (dBm)	ANT 1 TOTAL VALUE (dBm)	ANT0 + ANT1 TOTAL VALUE(dBm)	LIMIT (dBm)	MARGIN (dB)
5 470 ~ 5 725	Middle	5 720.00	9.20	9.23	12.22	18.00	5.78
5 725 ~ 5 850	Middle	5 720.00	3.50	3.62	6.57	24.00	17.43

Remark 1 : Margin = Limit – Measured Value (=Receiver Reading + Cable Loss)

Remark 2 : Calculated Output Power= 10log (10^(Antenna1 Output Power/10)+10^(Antenna2 Output Power/10))

9.6 Test data for 802.11n_HT40 RLAN Mode

9.6.1 Test data for Antenna 0

-. Test Result : Pass

-. Duty Cycle : 97.79 %

FREQUENCY RANGE (MHz)	CHANNEL	FREQUENCY (MHz)	MEASURED VALUE (dBm)	Duty Factor (dB)	Total Value (dBm)	LIMIT (dBm)	MARGIN (dB)
5 150 ~ 5 250	Low	5 190.00	8.35	0.097	8.45	21.00	12.55
	High	5 230.00	8.92	0.097	9.02	21.00	11.98
5 250 ~ 5 350	Low	5 270.00	8.18	0.097	8.28	21.00	12.72
	High	5 310.00	8.14	0.097	8.24	21.00	12.76
5 470 ~ 5 725	Low	5 510.00	8.95	0.097	9.05	21.00	11.95
	Middle	5 550.00	9.52	0.097	9.62	21.00	11.38
	High	5 670.00	9.21	0.097	9.31	21.00	11.69
5 725 ~ 5 850	Low	5 755.00	10.27	0.097	10.37	27.00	16.63
	High	5 795.00	10.16	0.097	10.26	27.00	16.74

Remark : Margin = Limit – Total Value (=Measured Value +Duty Factor)

9.6.2 Test data for Antenna 1

-. Test Result : Pass

-. Duty Cycle : 97.35 %

FREQUENCY RANGE (MHz)	CHANNEL	FREQUENCY (MHz)	MEASURED VALUE (dBm)	Duty Factor (dB)	Total Value (dBm)	LIMIT (dBm)	MARGIN (dB)
5 150 ~ 5 250	Low	5 190.00	8.41	0.117	8.53	21.00	12.47
	High	5 230.00	8.75	0.117	8.87	21.00	12.13
5 250 ~ 5 350	Low	5 270.00	8.03	0.117	8.15	21.00	12.85
	High	5 310.00	8.09	0.117	8.21	21.00	12.79
5 470 ~ 5 725	Low	5 510.00	9.18	0.117	9.30	21.00	11.70
	Middle	5 550.00	9.81	0.117	9.93	21.00	11.07
	High	5 670.00	9.01	0.117	9.13	21.00	11.87
5 725 ~ 5 850	Low	5 755.00	10.35	0.117	10.47	27.00	16.53
	High	5 795.00	9.72	0.117	9.84	27.00	17.16

Remark : Margin = Limit –Total Value (=Measured Value +Duty Factor)

9.6.3 Test data for Multiple Transmit

-. Test Result : Pass

FREQUENCY RANGE (MHz)	CHANNEL	FREQUENCY (MHz)	ANT 0 TOTAL VALUE (dBm)	ANT 1 TOTAL VALUE (dBm)	ANT0 + ANT1 TOTAL VALUE (dBm)	LIMIT (dBm)	MARGIN (dB)
5 150 ~ 5 250	Low	5 190.00	8.45	8.53	11.50	18.00	6.50
	High	5 230.00	9.02	8.87	11.95	18.00	6.05
5 250 ~ 5 350	Low	5 270.00	8.28	8.15	11.22	18.00	6.78
	High	5 310.00	8.24	8.21	11.23	18.00	6.77
5 470 ~ 5 725	Low	5 510.00	9.05	9.30	12.18	18.00	5.82
	Middle	5 550.00	9.62	9.93	12.79	18.00	5.21
	High	5 670.00	9.31	9.13	12.23	18.00	5.77
5 725 ~ 5 850	Low	5 755.00	10.37	10.47	13.43	24.00	10.57
	High	5 795.00	10.26	9.84	13.06	24.00	10.94

Remark : Margin = Limit –Total Value (=Measured Value +Duty Factor)

9.6.4 Test data for Staddle Channel_Antenna 0

-. Test Result : Pass

-. Duty Cycle : 71.11 %

FREQUENCY RANGE (MHz)	CHANNEL	FREQUENCY (MHz)	MEASURED VALUE (dBm)	Duty Factor (dB)	Total Value (dBm)	LIMIT (dBm)	MARGIN (dB)
5 470 ~ 5 725	Middle	5 710.00	7.26	0.10	7.36	21.00	13.64
5 725 ~ 5 850	Middle	5 710.00	-3.00	0.10	-2.90	27.00	29.90

Remark : Margin = Limit –Total Value (=Measured Value +Duty Factor)

9.6.5 Test data for Staddle Channel_Antenna 1

-. Test Result : Pass

-. Duty Cycle : 73.33 %

FREQUENCY RANGE (MHz)	CHANNEL	FREQUENCY (MHz)	MEASURED VALUE (dBm)	Duty Factor (dB)	Total Value (dBm)	LIMIT (dBm)	MARGIN (dB)
5 470 ~ 5 725	Middle	5 710.00	7.33	0.12	7.45	21.00	13.55
5 725 ~ 5 850	Middle	5 710.00	-2.50	0.12	-2.38	27.00	29.38

Remark : Margin = Limit –Total Value (=Measured Value +Duty Factor)

9.6.6 Test data for Staddle Channel_Multiple Transmit

-. Test Result : Pass

FREQUENCY RANGE (MHz)	CHANNEL	FREQUENCY (MHz)	ANT 0 TOTAL VALUE (dBm)	ANT 1 TOTAL VALUE (dBm)	ANT0 + ANT1 TOTAL VALUE (dBm)	LIMIT (dBm)	MARGIN (dB)
5 470 ~ 5 725	Middle	5 710.00	7.36	7.45	10.41	18.00	7.59
5 725 ~ 5 850	Middle	5 710.00	-2.90	-2.38	0.38	24.00	23.62

Remark 1 : Margin = Limit – Measured Value (=Receiver Reading + Cable Loss)

Remark 2 : Calculated Output Power= 10log (10^(Antenna1 Output Power/10)+10^(Antenna2 Output Power/10))

9.7 Test data for 802.11ac_HT80 RLAN Mode

9.7.1 Test data for Antenna 0

-. Test Result : Pass

-. Duty Cycle : 95.43 %

FREQUENCY RANGE (MHz)	CHANNEL	FREQUENCY (MHz)	MEASURED VALUE (dBm)	Duty Factor (dB)	Total Value (dBm)	LIMIT (dBm)	MARGIN (dB)
5 150 ~ 5 250	Middle	5 210.00	8.13	0.203	8.33	21.00	12.67
5 250 ~ 5 350	Middle	5 290.00	6.15	0.203	6.35	21.00	14.65
5 470 ~ 5 725	Middle	5 530.00	5.71	0.203	5.91	21.00	15.09
5 725 ~ 5 850	Middle	5 775.00	7.82	0.203	8.02	27.00	18.98

Remark : Margin = Limit –Total Value (=Measured Value +Duty Factor)

9.7.2 Test data for Antenna 1

-. Test Result : Pass

-. Duty Cycle : 95.40 %

FREQUENCY RANGE (MHz)	CHANNEL	FREQUENCY (MHz)	MEASURED VALUE (dBm)	Duty Factor (dB)	Total Value (dBm)	LIMIT (dBm)	MARGIN (dB)
5 150 ~ 5 250	Middle	5 210.00	7.91	0.204	8.11	21.00	12.89
5 250 ~ 5 350	Middle	5 290.00	6.03	0.204	6.23	21.00	14.77
5 470 ~ 5 725	Middle	5 530.00	5.70	0.204	5.90	21.00	15.10
5 725 ~ 5 850	Middle	5 775.00	7.49	0.204	7.69	27.00	19.31

Remark : Margin = Limit –Total Value (=Measured Value +Duty Factor)

9.7.3 Test data for Multiple Transmit

- Test Result : Pass

FREQUENCY RANGE (MHz)	CHANNEL	FREQUENCY (MHz)	ANT 0 TOTAL VALUE (dBm)	ANT 1 TOTAL VALUE (dBm)	ANT0 + ANT1 TOTAL VALUE (dBm)	LIMIT (dBm)	MARGIN (dB)
5 150 ~ 5 250	Middle	5 210.00	8.33	8.11	11.24	18.00	6.76
5 250 ~ 5 350	Middle	5 290.00	6.35	6.23	9.30	18.00	8.70
5 470 ~ 5 725	Middle	5 530.00	5.91	5.90	8.92	18.00	9.08
5 725 ~ 5 850	Middle	5 775.00	8.02	7.69	10.87	24.00	13.13

Remark 1: Margin = Limit – Measured Value (=Power Sensor Reading + Cable Loss)

Remark 2: Calculated Output Power= $10\log (10^{(\text{Antenna0 Output Power}/10)} + 10^{(\text{Antenna1 Output Power}/10)})$

9.7.4 Test data for Staddle Channel_Antenna 0

-. Test Result : Pass

-. Duty Cycle : 50.63 %

FREQUENCY RANGE (MHz)	CHANNEL	FREQUENCY (MHz)	MEASURED VALUE (dBm)	Duty Factor (dB)	Total Value (dBm)	LIMIT (dBm)	MARGIN (dB)
5 470 ~ 5 725	Middle	5 690.00	4.52	0.20	4.72	21.00	16.28
5 725 ~ 5 850	Middle	5 690.00	-9.40	0.20	-9.20	27.00	36.20

Remark : Margin = Limit –Total Value (=Measured Value +Duty Factor)

9.7.5 Test data for Staddle Channel_Antenna 1

-. Test Result : Pass

-. Duty Cycle : 53.8 %

FREQUENCY RANGE (MHz)	CHANNEL	FREQUENCY (MHz)	MEASURED VALUE (dBm)	Duty Factor (dB)	Total Value (dBm)	LIMIT (dBm)	MARGIN (dB)
5 470 ~ 5 725	Middle	5 690.00	4.17	0.20	4.37	21.00	16.63
5 725 ~ 5 850	Middle	5 690.00	-9.10	0.20	-8.90	27.00	35.90

Remark : Margin = Limit –Total Value (=Measured Value +Duty Factor)

9.7.6 Test data for Staddle Channel_Multiple Transmit

-. Test Result : Pass

FREQUENCY RANGE (MHz)	CHANNEL	FREQUENCY (MHz)	ANT 0 TOTAL VALUE (dBm)	ANT 1 TOTAL VALUE (dBm)	ANT0 + ANT1 TOTAL VALUE (dBm)	LIMIT (dBm)	MARGIN (dB)
5 470 ~ 5 725	Middle	5 690.00	4.72	4.37	7.56	18.00	10.44
5 725 ~ 5 850	Middle	5 690.00	-9.20	-8.90	-6.03	24.00	30.03

Remark 1 : Margin = Limit – Measured Value (=Receiver Reading + Cable Loss)

Remark 2 : Calculated Output Power= 10log (10^(Antenna1 Output Power/10)+10^(Antenna2 Output Power/10))

10. PEAK POWER SPECTRUL DENSITY

10.1 Operating environment

Temperature : 23 °C
 Relative humidity : 45 % R.H.

10.2 Test set-up

The antenna output of the EUT was connected to the spectrum analyzer. The resolution bandwidth is set to 1 MHz, the video bandwidth is set to 3 times the resolution bandwidth. The maximum level form the EUT in 1 MHz bandwidth was measured with above condition.

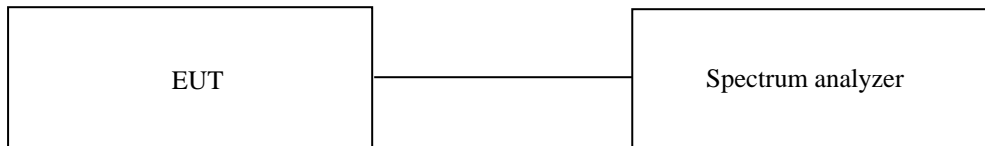

10.3 Test Date

December 05, 2021 ~ March 08, 2022

10.4 Test data for 802.11a RLAN Mode

10.4.1 Test data for Antenna 0

-. Operating condition : Highest Output Power Transmitting Mode

-. Test Result : Pass

FREQUENCY RANGE (MHz)	CHANNEL	FREQUENCY (MHz)	MEASURED VALUE (dBm)	Duty Factor (dB)	Result value' (dBm)	LIMIT (dBm)	MARGIN (dB)
5 150 ~ 5 250	Low	5 180.00	0.41	0.05	0.46	8.00	7.55
	Middle	5 220.00	0.81	0.05	0.86	8.00	7.15
	High	5 240.00	1.13	0.05	1.18	8.00	6.83
5 250 ~ 5 350	Low	5 260.00	0.90	0.05	0.95	8.00	7.06
	Middle	5 300.00	0.63	0.05	0.68	8.00	7.33
	High	5 320.00	0.76	0.05	0.81	8.00	7.20
5 470 ~ 5 725	Low	5 500.00	0.48	0.05	0.53	8.00	7.48
	Middle	5 580.00	0.84	0.05	0.89	8.00	7.12
	High	5 700.00	-0.06	0.05	-0.02	8.00	8.02
5 725 ~ 5 850	Low	5 745.00	-2.80	0.05	-2.76	27.00	29.76
	Middle	5 785.00	-2.68	0.05	-2.64	27.00	29.64
	High	5 825.00	-3.73	0.05	-3.69	27.00	30.69

Remark: See next page for measurement data.

10.4.2 Test data for Antenna 1

-. Operating condition : Highest Output Power Transmitting Mode

-. Test Result : Pass

FREQUENCY RANGE (MHz)	CHANNEL	FREQUENCY (MHz)	MEASURED VALUE (dBm)	Duty Factor (dB)	Result value' (dBm)	LIMIT (dBm)	MARGIN (dB)
5 150 ~ 5 250	Low	5 180.00	0.01	0.05	0.06	8.00	7.95
	Middle	5 220.00	0.17	0.05	0.22	8.00	7.79
	High	5 240.00	0.55	0.05	0.60	8.00	7.41
5 250 ~ 5 350	Low	5 260.00	0.25	0.05	0.30	8.00	7.71
	Middle	5 300.00	0.26	0.05	0.31	8.00	7.70
	High	5 320.00	0.46	0.05	0.51	8.00	7.50
5 470 ~ 5 725	Low	5 500.00	0.31	0.05	0.36	8.00	7.65
	Middle	5 580.00	0.72	0.05	0.77	8.00	7.24
	High	5 700.00	-0.32	0.05	-0.28	8.00	8.28
5 725 ~ 5 850	Low	5 745.00	-2.98	0.05	-2.94	27.00	29.94
	Middle	5 785.00	-3.65	0.05	-3.61	27.00	30.61
	High	5 825.00	-3.68	0.05	-3.64	27.00	30.64

Remark: See next page for measurement data.

10.4.3 Test data for Staddle Channel_Antenna 0

- . Operating condition : Highest Output Power Transmitting Mode
- . Test Result : Pass

FREQUENCY RANGE (MHz)	FREQUENCY (MHz)	MEASURED VALUE (dBm)	Duty Factor (dB)	Result Value (dBm)	LIMIT (dBm)	MARGIN (dB)
5 470 ~ 5 725	5 720.00	-0.58	0.05	-0.53	8.00	8.53
5 725 ~ 5 850	5 720.00	-4.05	0.05	-4.00	27.00	31.00

Remark: See next page for measurement data.

10.4.4 Test data for Staddle Channel_Antenna 1

- . Operating condition : Highest Output Power Transmitting Mode
- . Test Result : Pass

FREQUENCY RANGE (MHz)	FREQUENCY (MHz)	MEASURED VALUE (dBm)	Duty Factor (dB)	Result Value (dBm)	LIMIT (dBm)	MARGIN (dB)
5 470 ~ 5 725	5 720.00	-0.61	0.05	-0.56	8.00	8.56
5 725 ~ 5 850	5 720.00	-3.82	0.05	-3.77	27.00	30.77

Remark: See next page for measurement data.

10.5 Test data for 802.11n_HT20 RLAN Mode

10.5.1 Test data for Antenna 0

-. Operating condition : Highest Output Power Transmitting Mode

-. Test Result : Pass

FREQUENCY RANGE (MHz)	CHANNEL	FREQUENCY (MHz)	MEASURED VALUE (dBm)	Duty Factor (dB)	Result value' (dBm)	LIMIT (dBm)	MARGIN (dB)
5 150 ~ 5 250	Low	5 180.00	0.23	0.05	0.28	8.00	7.72
	Middle	5 220.00	0.75	0.05	0.80	8.00	7.20
	High	5 240.00	0.87	0.05	0.92	8.00	7.08
5 250 ~ 5 350	Low	5 260.00	0.54	0.05	0.59	8.00	7.41
	Middle	5 300.00	0.58	0.05	0.63	8.00	7.37
	High	5 320.00	0.67	0.05	0.72	8.00	7.28
5 470 ~ 5 725	Low	5 500.00	0.21	0.05	0.26	8.00	7.74
	Middle	5 580.00	0.67	0.05	0.72	8.00	7.28
	High	5 700.00	-0.04	0.05	0.01	8.00	7.99
5 725 ~ 5 850	Low	5 745.00	-2.94	0.05	-2.89	27.00	29.89
	Middle	5 785.00	-3.08	0.05	-3.03	27.00	30.03
	High	5 825.00	-3.73	0.05	-3.68	27.00	30.68

Remark: See next page for measurement data.

10.5.2 Test data for Antenna 1

-. Operating condition : Highest Output Power Transmitting Mode

-. Test Result : Pass

FREQUENCY RANGE (MHz)	CHANNEL	FREQUENCY (MHz)	MEASURED VALUE (dBm)	Duty Factor (dB)	Result value' (dBm)	LIMIT (dBm)	MARGIN (dB)
5 150 ~ 5 250	Low	5 180.00	-0.22	0.06	-0.17	8.00	8.17
	Middle	5 220.00	-0.02	0.06	0.04	8.00	7.97
	High	5 240.00	0.06	0.06	0.12	8.00	7.89
5 250 ~ 5 350	Low	5 260.00	-0.42	0.06	-0.37	8.00	8.37
	Middle	5 300.00	-0.20	0.06	-0.15	8.00	8.15
	High	5 320.00	0.17	0.06	0.23	8.00	7.78
5 470 ~ 5 725	Low	5 500.00	0.22	0.06	0.28	8.00	7.73
	Middle	5 580.00	0.46	0.06	0.52	8.00	7.49
	High	5 700.00	-0.50	0.06	-0.45	8.00	8.45
5 725 ~ 5 850	Low	5 745.00	-3.01	0.06	-2.96	27.00	29.96
	Middle	5 785.00	-3.91	0.06	-3.86	27.00	30.86
	High	5 825.00	-3.98	0.06	-3.93	27.00	30.93

Remark: See next page for measurement data.

10.5.3 Test data for Multiple Transmit

-. Operating condition : Highest Output Power Transmitting Mode

-. Test Result : Pass

FREQUENCY RANGE (MHz)	CHANNEL	FREQUENCY (MHz)	ANT 0 TOTAL VALUE (dBm)	ANT 1 TOTAL VALUE (dBm)	ANT0 + ANT1 TOTAL VALUE (dBm)	LIMIT (dBm)	MARGIN (dB)
5 150 ~ 5 250	Low	5 180.00	0.28	-0.17	3.07	5.00	1.93
	Middle	5 220.00	0.80	0.04	3.44	5.00	1.56
	High	5 240.00	0.92	0.12	3.55	5.00	1.45
5 250 ~ 5 350	Low	5 260.00	0.59	-0.37	3.15	5.00	1.85
	Middle	5 300.00	0.63	-0.15	3.27	5.00	1.73
	High	5 320.00	0.72	0.23	3.49	5.00	1.51
5 470 ~ 5 725	Low	5 500.00	0.26	0.28	3.28	5.00	1.72
	Middle	5 580.00	0.72	0.52	3.63	5.00	1.37
	High	5 700.00	0.01	-0.45	2.80	5.00	2.20
5 725 ~ 5 850	Low	5 745.00	-2.89	-2.96	0.09	24.00	23.91
	Middle	5 785.00	-3.03	-3.86	-0.41	24.00	24.41
	High	5 825.00	-3.68	-3.93	-0.79	24.00	24.79

10.5.4 Test data for Staddle Channel_Antenna 0

- . Operating condition : Highest Output Power Transmitting Mode
- . Test Result : Pass

FREQUENCY RANGE (MHz)	FREQUENCY (MHz)	MEASURED VALUE (dBm)	Duty Factor (dB)	Result Value (dBm)	LIMIT (dBm)	MARGIN (dB)
5 470 ~ 5 725	5 720.00	-0.96	0.05	-0.91	8.00	8.91
5 725 ~ 5 850	5 720.00	-4.09	0.05	-4.04	27.00	31.04

Remark: See next page for measurement data.

10.5.5 Test data for Staddle Channel_Antenna 1

- . Operating condition : Highest Output Power Transmitting Mode
- . Test Result : Pass

FREQUENCY RANGE (MHz)	FREQUENCY (MHz)	MEASURED VALUE (dBm)	Duty Factor (dB)	Result Value (dBm)	LIMIT (dBm)	MARGIN (dB)
5 470 ~ 5 725	5 720.00	-0.90	0.06	-0.84	8.00	8.84
5 725 ~ 5 850	5 720.00	-3.87	0.06	-3.81	27.00	30.81

Remark: See next page for measurement data.

10.5.6 Test data for Staddle Channel_Multiple Transmit

- . Operating condition : Highest Output Power Transmitting Mode
- . Test Result : Pass

FREQUENCY RANGE (MHz)	CHANNEL	FREQUENCY (MHz)	ANT 0 TOTAL VALUE (dBm)	ANT 1 TOTAL VALUE (dBm)	ANT0 + ANT1 TOTAL VALUE (dBm)	LIMIT (dBm)	MARGIN (dB)
5 470 ~ 5 725	Middle	5 720.00	-0.91	-0.84	2.14	5.00	2.86
5 725 ~ 5 850	Middle	5 720.00	-4.04	-3.81	-0.91	24.00	24.91

10.6 Test data for 802.11n_HT40 RLAN Mode

10.6.1 Test data for Antenna 0

-. Operating condition : Highest Output Power Transmitting Mode

-. Test Result : Pass

FREQUENCY RANGE (MHz)	CHANNEL	FREQUENCY (MHz)	MEASURED VALUE (dBm)	Duty Factor (dB)	Result Value (dBm)	LIMIT (dBm)	MARGIN (dB)
5 150 ~ 5 250	Low	5 190.00	-5.54	0.10	-5.44	8.00	13.44
	High	5 230.00	-4.97	0.10	-4.87	8.00	12.87
5 250 ~ 5 350	Low	5 270.00	-6.23	0.10	-6.13	8.00	14.13
	High	5 310.00	-6.16	0.10	-6.06	8.00	14.06
5 470 ~ 5 725	Low	5 510.00	-4.82	0.10	-4.72	8.00	12.72
	Middle	5 550.00	-4.64	0.10	-4.54	8.00	12.54
	High	5 670.00	-4.98	0.10	-4.88	8.00	12.88
5 725 ~ 5 850	Low	5 755.00	-6.92	0.10	-6.82	27.00	33.82
	High	5 795.00	-7.55	0.10	-7.45	27.00	34.45

Remark: See next page for measurement data.

10.6.2 Test data for Antenna 1

-. Operating condition : Highest Output Power Transmitting Mode

-. Test Result : Pass

FREQUENCY RANGE (MHz)	CHANNEL	FREQUENCY (MHz)	MEASURED VALUE (dBm)	Duty Factor (dB)	Result VALUE (dBm)	LIMIT (dBm)	MARGIN (dB)
5 150 ~ 5 250	Low	5 190.00	-6.25	0.12	-6.13	8.00	14.13
	High	5 230.00	-5.95	0.12	-5.83	8.00	13.83
5 250 ~ 5 350	Low	5 270.00	-6.84	0.12	-6.72	8.00	14.72
	High	5 310.00	-6.53	0.12	-6.41	8.00	14.41
5 470 ~ 5 725	Low	5 510.00	-4.80	0.12	-4.68	8.00	12.68
	Middle	5 550.00	-4.65	0.12	-4.53	8.00	12.53
	High	5 670.00	-5.32	0.12	-5.20	8.00	13.20
5 725 ~ 5 850	Low	5 755.00	-7.22	0.12	-7.10	27.00	34.10
	High	5 795.00	-7.83	0.12	-7.71	27.00	34.71

Remark: See next page for measurement data.

This Report is not correlated with the authentication of KOLAS

It should not be reproduced except in full, without the written approval of ONETECH Corp.

OTC-TRF-RF-001(0)

10.6.3 Test data for Multiple Transmit

-. Operating condition : Highest Output Power Transmitting Mode

-. Test Result : Pass

FREQUENCY RANGE (MHz)	CHANNEL	FREQUENCY (MHz)	ANT 0 TOTAL VALUE (dBm)	ANT 1 TOTAL VALUE (dBm)	ANT0 + ANT1 TOTAL VALUE (dBm)	LIMIT (dBm)	MARGIN (dB)
5 150 ~ 5 250	Low	5 190.00	-5.44	-6.13	-2.76	5.00	7.76
	High	5 230.00	-4.87	-5.83	-2.32	5.00	7.32
5 250 ~ 5 350	Low	5 270.00	-6.13	-6.72	-3.41	5.00	8.41
	High	5 310.00	-6.06	-6.41	-3.22	5.00	8.22
5 470 ~ 5 725	Low	5 510.00	-4.72	-4.68	-1.69	5.00	6.69
	Middle	5 550.00	-4.54	-4.53	-1.53	5.00	6.53
	High	5 670.00	-4.88	-5.20	-2.03	5.00	7.03
5 725 ~ 5 850	Low	5 755.00	-6.82	-7.10	-3.95	24.00	27.95
	High	5 795.00	-7.45	-7.71	-4.57	24.00	28.57

10.6.4 Test data for Staddle Channel_Antenna 0

- . Operating condition : Highest Output Power Transmitting Mode
- . Test Result : Pass

FREQUENCY RANGE (MHz)	FREQUENCY (MHz)	MEASURED VALUE (dBm)	DUTY FACTOR (dB)	Result VALUE (dBm)	LIMIT (dBm)	MARGIN (dB)
5 470 ~ 5 725	5 710.00	-6.38	0.10	-6.28	8.00	14.28
5 725 ~ 5 850	5 710.00	-9.76	0.10	-9.66	27.00	36.66

Remark: See next page for measurement data.

10.6.5 Test data for Staddle Channel_Antenna 1

- . Operating condition : Highest Output Power Transmitting Mode
- . Test Result : Pass

FREQUENCY RANGE (MHz)	FREQUENCY (MHz)	MEASURED VALUE (dBm)	DUTY FACTOR (dB)	Result VALUE (dBm)	LIMIT (dBm)	MARGIN (dB)
5 470 ~ 5 725	5 710.00	-6.25	0.12	-6.13	8.00	14.13
5 725 ~ 5 850	5 710.00	-9.32	0.12	-9.20	27.00	36.20

Remark: See next page for measurement data.

10.6.6 Test data for Staddle Channel_Multiple Transmit

- . Operating condition : Highest Output Power Transmitting Mode
- . Test Result : Pass

FREQUENCY RANGE (MHz)	CHANNEL	FREQUENCY (MHz)	ANT 0 TOTAL VALUE (dBm)	ANT 1 TOTAL VALUE (dBm)	ANT0 + ANT1 TOTAL VALUE (dBm)	LIMIT (dBm)	MARGIN (dB)
5 470 ~ 5 725	Middle	5 710.00	-6.28	-6.13	-3.19	5.00	8.19
5 725 ~ 5 850	Middle	5 710.00	-9.66	-9.20	-6.41	24.00	30.41

10.7 Test data for 802.11ac_HT80 RLAN Mode

10.7.1 Test data for Antenna 0

-. Operating condition : Highest Output Power Transmitting Mode

-. Test Result : Pass

FREQUENCY RANGE (MHz)	CHANNEL	FREQUENCY (MHz)	MEASURED VALUE (dBm)	Duty Factor (dB)	Result VALUE (dBm)	LIMIT (dBm)	MARGIN (dB)
5 150 ~ 5 250	Low	5 210.00	-9.22	0.20	-9.02	8.00	17.02
5 250 ~ 5 350	Low	5 290.00	-11.96	0.20	-11.76	8.00	19.76
5 470 ~ 5 725	Low	5 530.00	-11.84	0.20	-11.64	8.00	19.64
5 725 ~ 5 850	Low	5 775.00	-13.11	0.20	-12.91	27.00	39.91

Remark: See next page for measurement data.

10.7.2 Test data for Antenna 1

-. Operating condition : Highest Output Power Transmitting Mode

-. Test Result : Pass

FREQUENCY RANGE (MHz)	CHANNEL	FREQUENCY (MHz)	MEASURED VALUE (dBm)	Duty Factor (dB)	Result VALUE (dBm)	LIMIT (dBm)	MARGIN (dB)
5 150 ~ 5 250	Low	5 210.00	-10.23	0.20	-10.03	8.00	18.03
5 250 ~ 5 350	Low	5 290.00	-12.21	0.20	-12.01	8.00	20.01
5 470 ~ 5 725	Low	5 530.00	-12.09	0.20	-11.89	8.00	19.89
5 725 ~ 5 850	Low	5 775.00	-13.69	0.20	-13.49	27.00	40.49

Remark: See next page for measurement data.

10.7.3 Test data for Multiple Transmit

-. Operating condition : Highest Output Power Transmitting Mode

-. Test Result : Pass

FREQUENCY RANGE (MHz)	CHANNEL	FREQUENCY (MHz)	ANT 0 TOTAL VALUE (dBm)	ANT 1 TOTAL VALUE (dBm)	ANT0 + ANT1 TOTAL VALUE (dBm)	LIMIT (dBm)	MARGIN (dB)
5 150 ~ 5 250	Middle	5 210.00	-9.02	-10.03	-6.48	5.00	11.48
5 250 ~ 5 350	Middle	5 290.00	-11.76	-12.01	-8.87	5.00	13.87
5 470 ~ 5 725	Middle	5 530.00	-11.64	-11.89	-8.75	5.00	13.75
5 725 ~ 5 850	Middle	5 775.00	-12.91	-13.49	-10.18	24.00	34.18

10.7.4 Test data for Staddle Channel_Antenna 0

-. Operating condition : Highest Output Power Transmitting Mode

-. Test Result : Pass

FREQUENCY RANGE (MHz)	FREQUENCY (MHz)	MEASURED VALUE (dBm)	Duty Factor (dB)	Result VALUE (dBm)	LIMIT (dBm)	MARGIN (dB)
5 470 ~ 5 725	5 690.00	-12.63	0.20	-12.43	8.00	20.43
5 725 ~ 5 850	5 690.00	-16.74	0.20	-16.54	27.00	43.54

Remark: See next page for measurement data.

10.7.5 Test data for Staddle Channel_Antenna 1

-. Operating condition : Highest Output Power Transmitting Mode

-. Test Result : Pass

FREQUENCY RANGE (MHz)	FREQUENCY (MHz)	MEASURED VALUE (dBm)	Duty Factor (dB)	Result VALUE (dBm)	LIMIT (dBm)	MARGIN (dB)
5 470 ~ 5 725	5 690.00	-13.31	0.20	-13.11	8.00	21.11
5 725 ~ 5 850	5 690.00	-16.34	0.20	-16.14	27.00	43.14

Remark: See next page for measurement data.

10.7.6 Test data for Staddle Channel_Multiple Transmit

-. Operating condition : Highest Output Power Transmitting Mode

-. Test Result : Pass

FREQUENCY RANGE (MHz)	CHANNEL	FREQUENCY (MHz)	ANT 0 TOTAL VALUE (dBm)	ANT 1 TOTAL VALUE (dBm)	ANT0 + ANT1 TOTAL VALUE (dBm)	LIMIT (dBm)	MARGIN (dB)
5 470 ~ 5 725	Middle	5 690.00	-12.43	-13.11	-9.75	5.00	14.75
5 725 ~ 5 850	Middle	5 690.00	-16.54	-16.14	-13.33	24.00	37.33

11. FREQUENCY STABILITY WITH TEMPERATURE VARIATION

11.1 Operating environment

Temperature : 23 °C
 Relative humidity : 45 % R.H.

11.2 Test set-up

Turn EUT off and set chamber temperature to -20 °C and then allow sufficient time (approximately 20 min to 30 min after chamber reach the assigned temperature) for EUT to stabilize. Turn on the EUT and measure the EUT operating frequency and then turn off the EUT after the measurement. The temperature in the chamber was raised 10 °C step from -20 °C to +80 °C. Repeat above method for frequency measurements every 10 °C step and then record all measured frequencies on each temperature step.

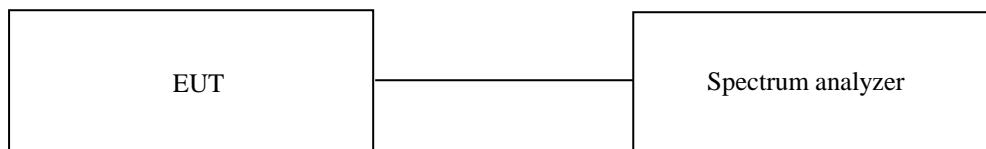

11.3 Test Date

December 05, 2021 ~ March 08, 2022

11.4 Test Data for U-NII-1

-. Result : Pass

Temperature (°C)	Carrier Freq. (Hz)	Measured Freq. (Hz)	Frequency Error (Hz)
-20	5 180 000 000	5 180 004 075	4 075
-10		5 180 008 867	8 867
0		5 180 006 537	6 537
10		5 180 010 974	10 974
20		5 180 013 886	13 886
30		5 180 016 943	16 943
40		5 180 013 930	13 930
50		5 180 017 081	17 081
-20		5 220 000 000	5 220 003 264
-10	5 220 005 573		5 573
0	5 220 007 758		7 758
10	5 220 009 672		9 672
20	5 220 012 393		12 393
30	5 220 016 063		16 063
40	5 220 019 236		19 236
50	5 220 022 895		22 895
-20	5 240 000 000		5 240 004 369
-10		5 240 006 795	6 795
0		5 240 010 129	10 129
10		5 240 012 763	12 763
20		5 240 013 260	13 260
30		5 240 016 991	16 991
40		5 240 020 411	20 411
50		5 240 022 948	22 948

Note : While maintaining a constant temperature inside the environmental chamber, turn the EUT ON and record the operating frequency at startup, and at 2 minutes, 5 minutes, and 10 minutes after the EUT is energized.

Four measurements in total are made.(ANSI C63.10-2020)

11.5 Test Data for U-NII-2A

-. Result : Pass

Temperature (°C)	Carrier Freq. (Hz)	Measured Freq. (Hz)	Frequency Error (Hz)
-20	5 260 000 000	5 260 004 657	4 657
-10		5 260 007 670	7 670
0		5 260 012 764	12 764
10		5 260 016 745	16 745
20		5 260 020 985	20 985
30		5 260 024 451	24 451
40		5 260 019 004	19 004
50		5 260 022 461	22 461
-20		5 300 000 000	5 300 004 006
-10	5 300 007 820		7 820
0	5 300 008 491		8 491
10	5 300 012 990		12 990
20	5 300 015 459		15 459
30	5 300 020 133		20 133
40	5 300 023 903		23 903
50	5 300 026 665		26 665
-20	5 320 000 000		5 320 003 801
-10		5 320 009 364	9 364
0		5 320 013 186	13 186
10		5 320 017 117	17 117
20		5 320 020 674	20 674
30		5 320 015 461	15 461
40		5 320 017 185	17 185
50		5 320 020 512	20 512

Note : While maintaining a constant temperature inside the environmental chamber, turn the EUT ON and record the operating frequency at startup, and at 2 minutes, 5 minutes, and 10 minutes after the EUT is energized.

Four measurements in total are made.(ANSI C63.10-2020)

11.6 Test Data for U-NII-2C

-. Result : Pass

Temperature (°C)	Carrier Freq. (Hz)	Measured Freq. (Hz)	Frequency Error (Hz)
-20	5 500 000 000	5 500 004 069	4 069
-10		5 500 007 970	7 970
0		5 500 012 716	12 716
10		5 500 016 545	16 545
20		5 500 018 254	18 254
30		5 500 021 500	21 500
40		5 500 024 449	24 449
50		5 500 028 954	28 954
-20		5 660 000 000	5 580 002 885
-10	5 580 005 384		5 384
0	5 580 010 167		10 167
10	5 580 012 455		12 455
20	5 580 016 276		16 276
30	5 580 019 312		19 312
40	5 580 021 328		21 328
50	5 580 023 226		23 226
-20	5 700 000 000		5 700 003 291
-10		5 700 005 766	5 766
0		5 700 008 861	8 861
10		5 700 012 879	12 879
20		5 700 017 721	17 721
30		5 700 019 416	19 416
40		5 700 021 473	21 473
50		5 700 024 221	24 221

Note : While maintaining a constant temperature inside the environmental chamber, turn the EUT ON and record the operating frequency at startup, and at 2 minutes, 5 minutes, and 10 minutes after the EUT is energized.

Four measurements in total are made.(ANSI C63.10-2020)

11.7 Test Data for U-NII-3

-. Result : Pass

Temperature (°C)	Carrier Freq. (Hz)	Measured Freq. (Hz)	Frequency Error (Hz)
-20	5 745 000 000	5 745 002 238	2 238
-10		5 745 003 538	3 538
0		5 745 007 319	7 319
10		5 745 012 146	12 146
20		5 745 016 935	16 935
30		5 745 021 338	21 338
40		5 745 025 744	25 744
50		5 745 028 820	28 820
-20		5 785 000 000	5 785 003 581
-10	5 785 008 206		8 206
0	5 785 010 843		10 843
10	5 785 012 762		12 762
20	5 785 013 284		13 284
30	5 785 014 781		14 781
40	5 785 016 194		16 194
50	5 785 019 131		19 131
-20	5 825 000 000		5 825 001 757
-10		5 825 003 636	3 636
0		5 825 005 059	5 059
10		5 825 007 127	7 127
20		5 825 009 891	9 891
30		5 825 013 868	13 868
40		5 825 018 290	18 290
50		5 825 022 065	22 065

Note : While maintaining a constant temperature inside the environmental chamber, turn the EUT ON and record the operating frequency at startup, and at 2 minutes, 5 minutes, and 10 minutes after the EUT is energized. Four measurements in total are made.(ANSI C63.10-2020)

12. FREQUENCY STABILITY WITH VOLTAGE VARIATION

12.1 Operating environment

Temperature : 23 °C
 Relative humidity : 45 % R.H.

12.2 Test set-up

An external DC power supply was connected to the input of the EUT. The voltage of EUT set to 115.0 % of the nominal value and then was reduced to 85.0 % of nominal voltage. The output frequency was recorded at each step.

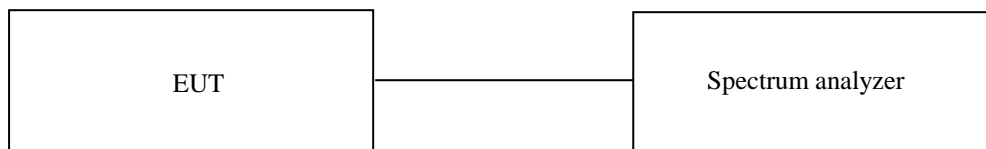

12.3 Test Date

December 05, 2021 ~ March 08, 2022

12.4 Test Data for U-NII-1

-. Result : Pass

Voltage (VDC)	Carrier Freq. (Hz)	Measured Freq. (Hz)	Frequency Error (Hz)
3.30	5 180 000 000	5 180 013 255	13 255
2.97		5 180 013 149	13 149
3.63		5 180 013 399	13 399
3.30	5 220 000 000	5 220 015 329	15 329
2.97		5 220 015 183	15 183
3.63		5 220 015 462	15 462
3.30	5 240 000 000	5 240 013 330	13 330
2.97		5 240 013 187	13 187
3.63		5 240 013 478	13 478

12.5 Test Data for U-NII-2A

-. Result : Pass

Voltage (VDC)	Carrier Freq. (Hz)	Measured Freq. (Hz)	Frequency Error (Hz)
3.30	5 260 000 000	5 260 012 895	12 895
2.97		5 260 012 762	12 762
3.63		5 260 013 016	13 016
3.30	5 300 000 000	5 300 016 125	16 125
2.97		5 300 016 007	16 007
3.63		5 300 016 289	16 289
3.30	5 320 000 000	5 320 013 710	13 710
2.97		5 320 013 597	13 597
3.63		5 320 013 862	13 862

This Report is not correlated with the authentication of KOLAS

It should not be reproduced except in full, without the written approval of ONETECH Corp.

OTC-TRF-RF-001(0)

12.6 Test Data for U-NII-2C

-. Result : Pass

Voltage (VDC)	Carrier Freq. (Hz)	Measured Freq. (Hz)	Frequency Error (Hz)
3.30	5 500 000 000	5 500 015 984	15 984
2.97		5 500 015 845	15 845
3.63		5 500 016 152	16 152
3.30	5 580 000 000	5 580 011 069	11 069
2.97		5 580 010 945	10 945
3.63		5 580 011 199	11 199
3.30	5 700 000 000	5 700 015 901	15 901
2.97		5 700 015 772	15 772
3.63		5 700 016 093	16 093

12.7 Test Data for U-NII-3

-. Result : Pass

Voltage (VDC)	Carrier Freq. (Hz)	Measured Freq. (Hz)	Frequency Error (Hz)
3.30	5 745 000 000	5 745 017 884	17 884
2.97		5 745 017 756	17 756
3.63		5 745 018 024	18 024
3.30	5 785 000 000	5 785 017 606	17 606
2.97		5 785 017 484	17 484
3.63		5 785 017 789	17 789
3.30	5 825 000 000	5 825 016 217	16 217
2.97		5 825 016 077	16 077
3.63		5 825 016 404	16 404

13. RADIATED SPURIOUS EMISSIONS

13.1 Operating environment

Temperature : 23 °C
 Relative humidity : 45 % R.H.

13.2 Test set-up for conducted measurement

The radiated emissions measurements were on the 3 m semi anechoic chamber. The EUT and other support equipment were placed on a non-conductive turntable above the ground plane. The interconnecting cables from outside test site were inserted into ferrite clamps at the point where the cables reach the turntable.

The frequency spectrum from 30 MHz to 40 GHz was scanned and maximum emission levels at each frequency recorded. The system was rotated 360°, and the antenna was varied in the height between 1.0 m and 4.0 m in order to determine the maximum emission levels. This procedure was performed for horizontal and vertical polarization of the receiving antenna.



13.3 Test Date

December 05, 2021 ~ March 08, 2022

13.4 Test data for Below 30 MHz

- Resolution bandwidth : 200 Hz (from 9 kHz to 0.15 MHz), 9 kHz (from 0.15 MHz to 30 MHz)
- Frequency range : 9 kHz ~ 30 MHz
- Measurement distance : 3 m
- Operating mode : Transmitting mode

Frequency (MHz)	Reading (dBμV)	Ant. Pol. (H/V)	Ant. Height (m)	Angle (°)	Ant. Factor (dB/m)	Cable Loss	Emission Level(dBμV/m)	Limits (dBμV/m)	Margin (dB)
Emission from the EUT more than 20 dB below the limit in each frequency range.									

13.5 Test data for 30 MHz ~ 1 000 MHz

13.5.1 Test data for WLAN 5 GHz

Humidity Level : 45 % R.H. Temperature: 23 °C

Limits apply to : FCC CFR 47, PART 15, SUBPART C, SECTION 15.247

Result : PASSED

EUT : RF Module

Detector : CISPR Quasi-Peak (6 dB Bandwidth: 120 kHz)

-. Antenna 0, Antenna 1 and Multiple transmit tested, but the worst data were recorded.

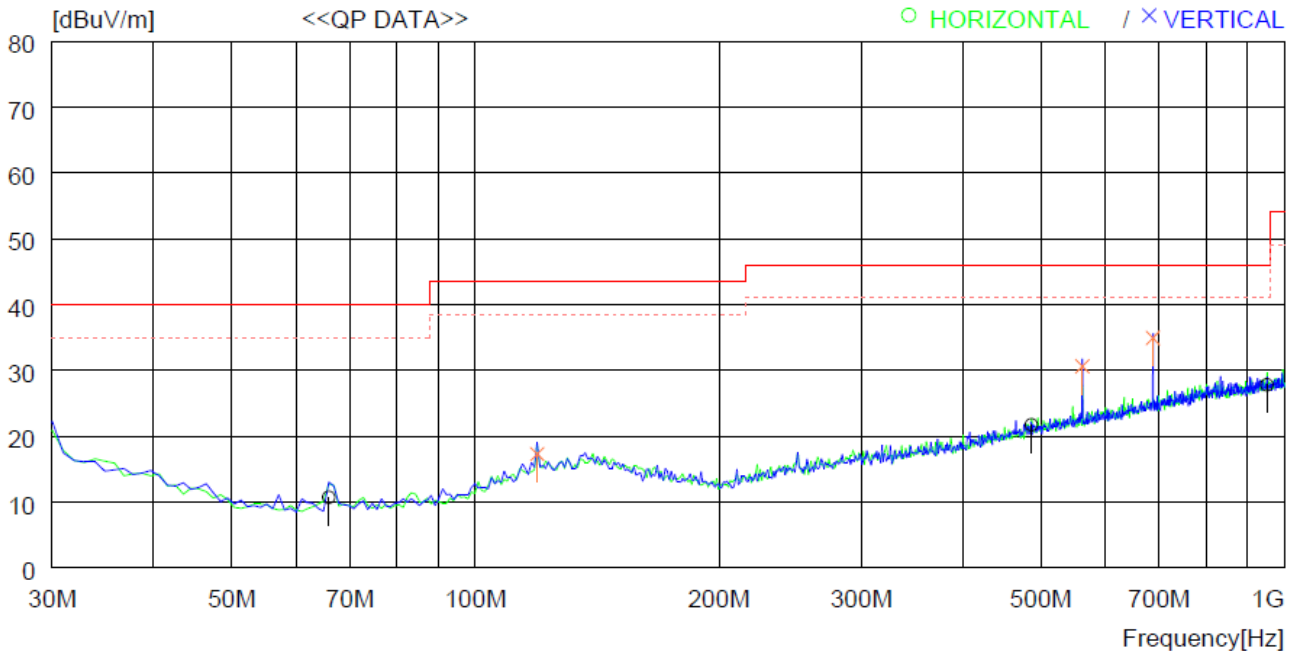

No.	FREQ [MHz]	READING QP [dBuV]	ANT FACTOR [dB]	LOSS [dB]	GAIN [dB]	RESULT [dBuV/m]	LIMIT [dBuV/m]	MARGIN [dB]	ANTENNA [cm]	TABLE [DEG]
----- Horizontal -----										
1	65.890	28.6	12.6	1.5	32.0	10.7	40.0	29.3	100	251
2	486.871	27.4	22.8	3.8	32.3	21.7	46.0	24.3	100	330
3	950.517	26.1	28.0	5.4	31.7	27.8	46.0	18.2	100	359
----- Vertical -----										
4	119.240	28.9	18.5	2.0	32.1	17.3	43.5	26.2	100	358
5	562.529	35.1	23.8	4.1	32.4	30.6	46.0	15.4	100	358
6	687.655	37.3	25.4	4.6	32.4	34.9	46.0	11.1	100	137

13.5.2 Test data for Intermodulation Mode(WLAN 5 GHz + Bluetooth)

Humidity Level : 45 % R.H. Temperature: 23 °C

Limits apply to : FCC CFR 47, PART 15, SUBPART C, SECTION 15.247

Result : PASSED

EUT : RF Module

Detector : CISPR Quasi-Peak (6 dB Bandwidth: 120 kHz)

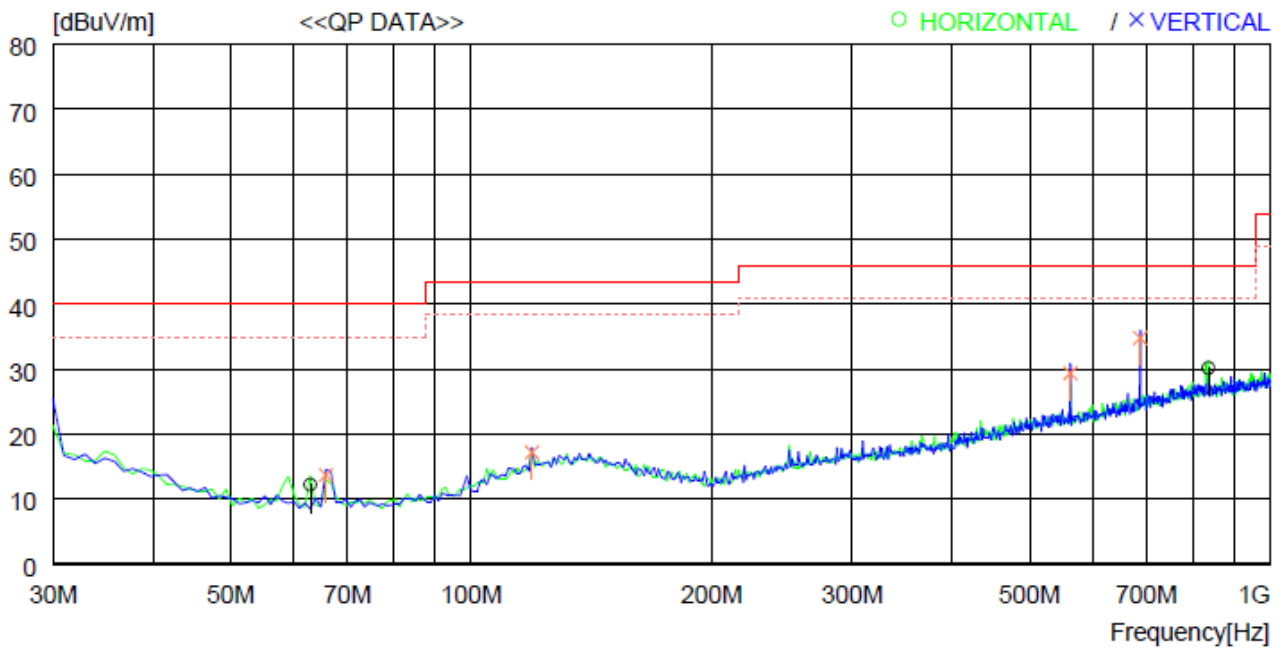

No.	FREQ [MHz]	READING QP [dBuV]	ANT FACTOR [dB]	LOSS [dB]	GAIN [dB]	RESULT [dBuV/m]	LIMIT [dBuV/m]	MARGIN [dB]	ANTENNA [cm]	TABLE [DEG]
----- Horizontal -----										
1	62.980	30.4	12.3	1.5	32.0	12.2	40.0	27.8	200	107
2	837.031	30.1	27.2	5.1	32.2	30.2	46.0	15.8	100	58
----- Vertical -----										
3	65.890	31.6	12.6	1.5	32.0	13.7	40.0	26.3	200	0
4	119.240	28.8	18.5	2.0	32.1	17.2	43.5	26.3	100	359
5	562.529	33.9	23.8	4.1	32.4	29.4	46.0	16.6	100	359
6	687.655	37.2	25.4	4.6	32.4	34.8	46.0	11.2	100	179

13.5.3 Test data for Intermodulation Mode(WLAN 5 GHz + Bluetooth LE)

Humidity Level : 45 % R.H. Temperature: 23 °C

Limits apply to : FCC CFR 47, PART 15, SUBPART C, SECTION 15.247

Result : PASSED

EUT : RF Module

Detector : CISPR Quasi-Peak (6 dB Bandwidth: 120 kHz)

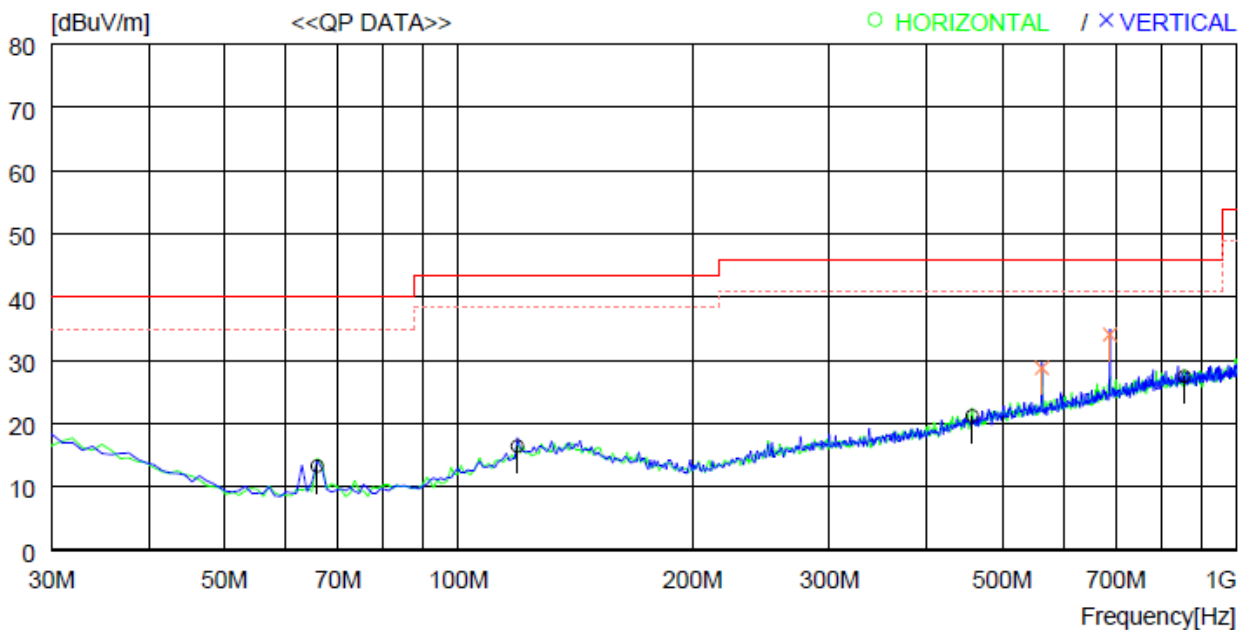

No.	FREQ [MHz]	READING QP [dBuV]	ANT FACTOR [dB]	LOSS [dB]	GAIN [dB]	RESULT [dBuV/m]	LIMIT [dBuV/m]	MARGIN [dB]	ANTENNA [cm]	TABLE [DEG]
----- Horizontal -----										
1	65.890	31.2	12.6	1.5	32.0	13.3	40.0	26.7	200	359
2	119.240	28.0	18.5	2.0	32.1	16.4	43.5	27.1	100	105
3	457.771	27.7	22.1	3.7	32.3	21.2	46.0	24.8	200	359
4	857.400	27.2	27.3	5.1	32.1	27.5	46.0	18.5	100	0
----- Vertical -----										
5	562.529	33.3	23.8	4.1	32.4	28.8	46.0	17.2	100	0
6	687.655	36.5	25.4	4.6	32.4	34.1	46.0	11.9	100	0

13.5.4 Test data for Intermodulation Mode(WLAN 5 GHz + WLAN 2.4 GHz)

Humidity Level : 45 % R.H. Temperature: 23 °C

Limits apply to : FCC CFR 47, PART 15, SUBPART C, SECTION 15.247

Result : PASSED

EUT : RF Module

Detector : CISPR Quasi-Peak (6 dB Bandwidth: 120 kHz)

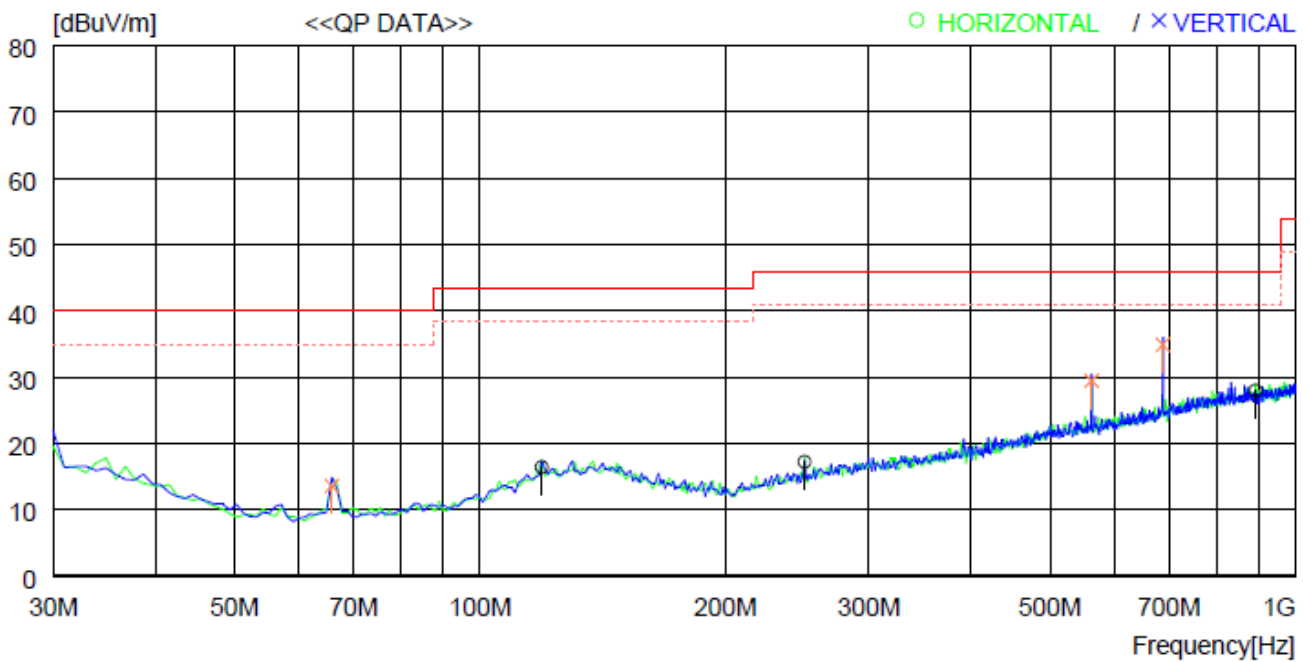

No.	FREQ [MHz]	READING QP [dBuV]	ANT FACTOR [dB]	LOSS [dB]	GAIN [dB]	RESULT [dBuV/m]	LIMIT [dBuV/m]	MARGIN [dB]	ANTENNA [cm]	TABLE [DEG]
----- Horizontal -----										
1	119.240	28.0	18.5	2.0	32.1	16.4	43.5	27.1	200	13
2	250.190	28.8	17.8	2.8	32.2	17.2	46.0	28.8	200	78
3	893.289	27.2	27.5	5.3	32.0	28.0	46.0	18.0	200	194
----- Vertical -----										
4	65.890	31.5	12.6	1.5	32.0	13.6	40.0	26.4	200	62
5	562.529	34.0	23.8	4.1	32.4	29.5	46.0	16.5	100	358
6	687.655	37.3	25.4	4.6	32.4	34.9	46.0	11.1	100	189

13.6 Test data for Above 1 GHz

13.6.1 Test data for Frequency UNII I

13.6.1.1 Test data for 802.11a RLAN Mode

- Resolution bandwidth : 1 MHz and Peak Detector for Peak Mode for the emissions fall in restricted band,
1 MHz and RMS Detector for Average Mode for the emissions fall in restricted band
100 kHz for Peak Mode for the emissions outside restricted band
- Video bandwidth : 3 MHz for Peak and Average Mode
- Frequency range : 1 GHz ~ 40 GHz
- Measurement distance : 3 m
- Duty Cycle : > 98 %
- Operating mode : Transmitting mode

Frequency (MHz)	Reading (dBμV)	Detector Mode	Ant. Pol. (H/V)	Ant. Factor	Cable Loss	Duty Factor(dB)	AMP Factor	Total (dBμV/m)	Limits (dBμV/m)	Margin (dB)
Antenna 0										
10 360.00	49.27	Peak	H	39.20	11.31	-	46.00	53.78	68.20	14.42
10 360.00	49.10	Peak	V	39.20	11.31	-	46.00	53.61	68.20	14.59
10 440.00	51.50	Peak	H	39.30	11.35	-	46.00	56.15	68.20	12.05
10 440.00	51.18	Peak	V	39.30	11.35	-	46.00	55.83	68.20	12.37
10 480.00	49.05	Peak	H	39.40	11.36	-	46.00	53.81	68.20	14.39
10 480.00	51.08	Peak	V	39.40	11.36	-	46.00	55.84	68.20	12.36
Antenna 1										
10 360.00	50.46	Peak	H	39.20	11.31	-	46.00	54.97	68.20	13.23
10 360.00	49.44	Peak	V	39.20	11.31	-	46.00	53.95	68.20	14.25
10 440.00	50.95	Peak	H	39.30	11.35	-	46.00	55.60	68.20	12.60
10 440.00	49.82	Peak	V	39.30	11.35	-	46.00	54.47	68.20	13.73
10 480.00	50.78	Peak	H	39.40	11.36	-	46.00	55.54	68.20	12.66
10 480.00	49.74	Peak	V	39.40	11.36	-	46.00	54.50	68.20	13.70

Remark - "H": Horizontal, "V": Vertical

Margin (dB) = Limits (dBμV/m) - Emission Level (dBμV/m)

13.6.1.2 Test data for 802.11n_HT20 RLAN Mode

13.6.1.2.1 Test data for Multiple Transmit

- Resolution bandwidth : 1 MHz and Peak Detector for Peak Mode for the emissions fall in restricted band,
1 MHz and RMS Detector for Average Mode for the emissions fall in restricted band
100 kHz for Peak Mode for the emissions outside restricted band
- Video bandwidth : 3 MHz for Peak and Average Mode
- Frequency range : 1 GHz ~ 40 GHz
- Measurement distance : 3 m
- Duty Cycle : > 98 %
- Operating mode : Transmitting mode

Frequency (MHz)	Reading (dBμV)	Detector Mode	Ant. Pol. (H/V)	Ant. Factor	Cable Loss	Duty Factor(dB)	AMP Factor	Total (dBμV/m)	Limits (dBμV/m)	Margin (dB)
Multiple Transmit										
10 360.00	49.72	Peak	H	39.20	11.31	-	46.00	54.23	68.20	13.97
10 360.00	50.55	Peak	V	39.20	11.31	-	46.00	55.06	68.20	13.14
10 440.00	50.26	Peak	H	39.30	11.35	-	46.00	54.91	68.20	13.29
10 440.00	49.75	Peak	V	39.30	11.35	-	46.00	54.40	68.20	13.80
10 480.00	49.19	Peak	H	39.40	11.36	-	46.00	53.95	68.20	14.25
10 480.00	49.32	Peak	V	39.40	11.36	-	46.00	54.08	68.20	14.12

Remark - “H”: Horizontal, “V”: Vertical

Margin (dB) = Limits (dBμV/m) - Emission Level (dBμV/m)

13.6.1.3 Test data for 802.11n_HT40 RLAN Mode

13.6.1.3.1 Test data for Multiple Transmit

- Resolution bandwidth : 1 MHz and Peak Detector for Peak Mode for the emissions fall in restricted band,
1 MHz and RMS Detector for Average Mode for the emissions fall in restricted band
100 kHz for Peak Mode for the emissions outside restricted band
- Video bandwidth : 3 MHz for Peak and Average Mode
- Frequency range : 1 GHz ~ 40 GHz
- Measurement distance : 3 m
- Duty Cycle : > 98 %
- Operating mode : Transmitting mode

Frequency (MHz)	Reading (dBμV)	Detector Mode	Ant. Pol. (H/V)	Ant. Factor	Cable Loss	Duty Factor(dB)	AMP Factor	Total (dBμV/m)	Limits (dBμV/m)	Margin (dB)
Multiple Transmit										
10 380.00	49.45	Peak	H	39.20	11.31	-	46.00	53.96	68.20	14.24
10 380.00	49.97	Peak	V	39.20	11.31	-	46.00	54.48	68.20	13.72
10 460.00	49.05	Peak	H	39.30	11.36	-	46.00	53.71	68.20	14.49
10 460.00	48.24	Peak	V	39.30	11.36	-	46.00	52.90	68.20	15.30

Remark - "H": Horizontal, "V": Vertical

Margin (dB) = Limits (dBμV/m) - Emission Level (dBμV/m)

13.6.1.4 Test data for 802.11ac_HT80 RLAN Mode

13.6.1.4.1 Test data for Multiple Transmit

- Resolution bandwidth : 1 MHz and Peak Detector for Peak Mode for the emissions fall in restricted band,
1 MHz and RMS Detector for Average Mode for the emissions fall in restricted band
100 kHz for Peak Mode for the emissions outside restricted band
- Video bandwidth : 3 MHz for Peak and Average Mode
- Frequency range : 1 GHz ~ 40 GHz
- Measurement distance : 3 m
- Duty Cycle : > 98 %
- Operating mode : Transmitting mode

Frequency (MHz)	Reading (dBμV)	Detector Mode	Ant. Pol. (H/V)	Ant. Factor	Cable Loss	Duty Factor(dB)	AMP Factor	Total (dBμV/m)	Limits (dBμV/m)	Margin (dB)
Multiple Transmit										
10 420.00	51.20	Peak	H	39.30	11.36	-	46.00	55.86	68.20	12.34
10 420.00	51.10	Peak	V	39.30	11.36	-	46.00	55.76	68.20	12.44

Remark - “H”: Horizontal, “V”: Vertical

Margin (dB) = Limits (dBμV/m) - Emission Level (dBμV/m)

13.6.2 Test data for Frequency UNII 2A

13.6.2.1 Test data for 802.11a RLAN Mode

- Resolution bandwidth : 1 MHz and Peak Detector for Peak Mode for the emissions fall in restricted band,
1 MHz and RMS Detector for Average Mode for the emissions fall in restricted band
100 kHz for Peak Mode for the emissions outside restricted band
- Video bandwidth : 3 MHz for Peak and Average Mode
- Frequency range : 1 GHz ~ 40 GHz
- Measurement distance : 3 m
- Duty Cycle : > 98 %
- Operating mode : Transmitting mode

Frequency (MHz)	Reading (dBμV)	Detector Mode	Ant. Pol. (H/V)	Ant. Factor	Cable Loss	Duty Factor(dB)	AMP Factor	Total (dBμV/m)	Limits (dBμV/m)	Margin (dB)
Antenna 0										
10 520.00	47.25	Peak	H	39.40	11.30	-	46.05	51.90	68.20	16.30
10 520.00	49.29	Peak	V	39.40	11.30	-	46.05	53.94	68.20	14.26
10 600.00	49.00	Peak	H	39.40	11.41	-	46.05	53.76	74.00	20.24
10 600.00	38.76	Average	H	39.40	11.41	0.05	46.05	43.57	54.00	10.44
10 600.00	50.25	Peak	V	39.40	11.41	-	46.05	55.01	74.00	18.99
10 600.00	38.87	Average	V	39.40	11.41	0.05	46.05	43.68	54.00	10.33
10 640.00	48.33	Peak	H	39.40	11.43	-	46.05	53.11	74.00	20.89
10 640.00	39.02	Average	H	39.40	11.43	0.05	46.05	43.85	54.00	10.16
10 640.00	49.68	Peak	V	39.40	11.43	-	46.05	54.51	74.00	19.50
10 640.00	39.63	Average	V	39.40	11.43	0.05	46.05	44.41	54.00	9.59

Frequency (MHz)	Reading (dBμV)	Detector Mode	Ant. Pol. (H/V)	Ant. Factor	Cable Loss	Duty Factor(dB)	AMP Factor	Total (dBμV/m)	Limits (dBμV/m)	Margin (dB)
Antenna 1										
10 520.00	48.22	Peak	H	39.40	11.30	-	46.05	52.87	68.20	15.33
10 520.00	48.41	Peak	V	39.40	11.30	-	46.05	53.06	68.20	15.14
10 600.00	49.04	Peak	H	39.40	11.41	-	46.05	53.80	74.00	20.20
10 600.00	39.00	Average	H	39.40	11.41	0.05	46.05	43.81	54.00	10.20
10 600.00	49.16	Peak	V	39.40	11.41	-	46.05	53.92	74.00	20.08
10 600.00	39.06	Average	V	39.40	11.41	0.05	46.05	43.87	54.00	10.14
10 640.00	47.17	Peak	H	39.40	11.43	-	46.05	51.95	74.00	22.05
10 640.00	38.66	Average	H	39.40	11.43	0.05	46.05	43.49	54.00	10.52
10 640.00	48.10	Peak	V	39.40	11.43	-	46.05	52.93	74.00	21.08
10 640.00	38.79	Average	V	39.40	11.43	0.05	46.05	43.57	54.00	10.43

Remark - "H": Horizontal, "V": Vertical

Margin (dB) = Limits (dBμV/m) - Emission Level (dBμV/m)

13.6.2.2 Test data for 802.11n_HT20 RLAN Mode

13.6.2.2.1 Test data for Multiple Transmit

- Resolution bandwidth : 1 MHz and Peak Detector for Peak Mode for the emissions fall in restricted band,
1 MHz and RMS Detector for Average Mode for the emissions fall in restricted band
100 kHz for Peak Mode for the emissions outside restricted band
- Video bandwidth : 3 MHz for Peak and Average Mode
- Frequency range : 1 GHz ~ 40 GHz
- Measurement distance : 3 m
- Duty Cycle : > 98 %
- Operating mode : Transmitting mode

Frequency (MHz)	Reading (dBμV)	Detector Mode	Ant. Pol. (H/V)	Ant. Factor	Cable Loss	Duty Factor(dB)	AMP Factor	Total (dBμV/m)	Limits (dBμV/m)	Margin (dB)
Multiple Transmit										
10 520.00	47.91	Peak	H	39.40	11.30	-	46.05	52.56	68.20	15.64
10 520.00	48.35	Peak	V	39.40	11.30	-	46.05	53.00	68.20	15.20
10 600.00	48.63	Peak	H	39.40	11.41	-	46.05	53.39	74.00	20.61
10 600.00	38.84	Average	H	39.40	11.41	0.06	46.05	43.66	54.00	10.35
10 600.00	49.25	Peak	V	39.40	11.41	-	46.05	54.01	74.00	19.99
10 600.00	38.92	Average	V	39.40	11.41	0.06	46.05	43.74	54.00	10.27
10 640.00	48.75	Peak	H	39.40	11.43	-	46.05	53.53	74.00	20.47
10 640.00	39.31	Average	H	39.40	11.43	0.06	46.05	44.15	54.00	9.85
10 640.00	49.06	Peak	V	39.40	11.43	-	46.05	53.84	74.00	20.16
10 640.00	38.79	Average	V	39.40	11.43	0.06	46.05	43.63	54.00	10.38

Remark - "H": Horizontal, "V": Vertical

Margin (dB) = Limits (dBμV/m) - Emission Level (dBμV/m)

13.6.2.3 Test data for 802.11n_HT40 RLAN Mode

13.6.2.3.1 Test data for Multiple Transmit

- Resolution bandwidth : 1 MHz and Peak Detector for Peak Mode for the emissions fall in restricted band,
1 MHz and RMS Detector for Average Mode for the emissions fall in restricted band
100 kHz for Peak Mode for the emissions outside restricted band
- Video bandwidth : 3 MHz for Peak and Average Mode
- Frequency range : 1 GHz ~ 40 GHz
- Measurement distance : 3 m
- Duty Cycle : > 98 %
- Operating mode : Transmitting mode

Frequency (MHz)	Reading (dBμV)	Detector Mode	Ant. Pol. (H/V)	Ant. Factor	Cable Loss	Duty Factor(dB)	AMP Factor	Total (dBμV/m)	Limits (dBμV/m)	Margin (dB)
Multiple Transmit										
10 540.00	47.42	Peak	H	39.40	11.30	-	46.05	52.07	68.20	16.13
10 540.00	48.84	Peak	V	39.40	11.30	-	46.05	53.49	68.20	14.71
10 620.00	47.52	Peak	H	39.40	11.43	-	46.05	52.30	74.00	21.70
10 620.00	39.01	Average	H	39.40	11.43	0.12	46.05	43.91	54.00	10.09
10 620.00	48.25	Peak	V	39.40	11.43	-	46.05	53.03	74.00	20.97
10 620.00	38.96	Average	V	39.40	11.43	0.12	46.05	43.86	54.00	10.14

Remark - “H”: Horizontal, “V”: Vertical

Margin (dB) = Limits (dBμV/m) - Emission Level (dBμV/m)

13.6.2.4 Test data for 802.11ac_HT80 RLAN Mode

13.6.2.4.1 Test data for Multiple Transmit

- Resolution bandwidth : 1 MHz and Peak Detector for Peak Mode for the emissions fall in restricted band,
1 MHz and RMS Detector for Average Mode for the emissions fall in restricted band
100 kHz for Peak Mode for the emissions outside restricted band
- Video bandwidth : 3 MHz for Peak and Average Mode
- Frequency range : 1 GHz ~ 40 GHz
- Measurement distance : 3 m
- Duty Cycle : > 98 %
- Operating mode : Transmitting mode

Frequency (MHz)	Reading (dBμV)	Detector Mode	Ant. Pol. (H/V)	Ant. Factor	Cable Loss	Duty Factor(dB)	AMP Factor	Total (dBμV/m)	Limits (dBμV/m)	Margin (dB)
Multiple Transmit										
10 580.00	48.36	Peak	H	39.40	11.41	-	46.05	53.12	68.20	15.08
10 580.00	48.38	Peak	V	39.40	11.41	-	46.05	53.14	68.20	15.06

Remark - “H”: Horizontal, “V”: Vertical

Margin (dB) = Limits (dBμV/m) - Emission Level (dBμV/m)

13.6.3 Test data for Frequency UNII 2C

13.6.3.1 Test data for 802.11a RLAN Mode

- Resolution bandwidth : 1 MHz and Peak Detector for Peak Mode for the emissions fall in restricted band,
1 MHz and RMS Detector for Average Mode for the emissions fall in restricted band
100 kHz for Peak Mode for the emissions outside restricted band
- Video bandwidth : 3 MHz for Peak and Average Mode
- Frequency range : 1 GHz ~ 40 GHz
- Measurement distance : 3 m
- Duty Cycle : > 98 %
- Operating mode : Transmitting mode

Frequency (MHz)	Reading (dBμV)	Detector Mode	Ant. Pol. (H/V)	Ant. Factor	Cable Loss	Duty Factor(dB)	AMP Factor	Total (dBμV/m)	Limits (dBμV/m)	Margin (dB)
Antenna 0										
11 000.00	49.88	Peak	H	39.00	11.85	-	46.50	54.23	74.00	19.77
11 000.00	41.36	Average	H	39.00	11.85	0.05	46.50	45.76	54.00	8.25
11 000.00	49.57	Peak	V	39.00	11.85	-	46.50	53.92	74.00	20.08
11 000.00	40.90	Average	V	39.00	11.85	0.05	46.50	45.30	54.00	8.71
11 160.00	48.76	Peak	H	39.00	12.36	-	46.50	53.62	74.00	20.38
11 160.00	40.27	Average	H	39.00	12.36	0.05	46.50	45.18	54.00	8.82
11 160.00	48.57	Peak	V	39.00	12.36	-	46.50	53.43	74.00	20.57
11 160.00	40.50	Average	V	39.00	12.36	0.05	46.50	45.41	54.00	8.60
11 400.00	50.70	Peak	H	39.00	13.11	-	46.50	56.31	74.00	17.69
11 400.00	40.71	Average	H	39.00	13.11	0.05	46.50	46.37	54.00	7.63
11 400.00	49.47	Peak	V	39.00	13.11	-	46.50	55.08	74.00	18.92
11 400.00	40.76	Average	V	39.00	13.11	0.05	46.50	46.42	54.00	7.59

Frequency (MHz)	Reading (dBμV)	Detector Mode	Ant. Pol. (H/V)	Ant. Factor	Cable Loss	Duty Factor(dB)	AMP Factor	Total (dBμV/m)	Limits (dBμV/m)	Margin (dB)
Antenna 1										
11 000.00	50.16	Peak	H	39.00	11.85	-	46.50	54.51	74.00	19.49
11 000.00	41.04	Average	H	39.00	11.85	0.05	46.50	45.44	54.00	8.57
11 000.00	50.02	Peak	V	39.00	11.85	-	46.50	54.37	74.00	19.63
11 000.00	41.41	Average	V	39.00	11.85	0.05	46.50	45.81	54.00	8.20
11 160.00	49.30	Peak	H	39.00	12.36	-	46.50	54.16	74.00	19.84
11 160.00	40.40	Average	H	39.00	12.36	0.05	46.50	45.31	54.00	8.69
11 160.00	49.00	Peak	V	39.00	12.36	-	46.50	53.86	74.00	20.14
11 160.00	40.06	Average	V	39.00	12.36	0.05	46.50	44.97	54.00	9.04
11 400.00	49.82	Peak	H	39.00	13.11	-	46.50	55.43	74.00	18.57
11 400.00	40.69	Average	H	39.00	13.11	0.05	46.50	46.35	54.00	7.66
11 400.00	49.77	Peak	V	39.00	13.11	-	46.50	55.38	74.00	18.62
11 400.00	40.64	Average	V	39.00	13.11	0.05	46.50	46.30	54.00	7.71

Remark - "H": Horizontal, "V": Vertical

Margin (dB) = Limits (dBμV/m) - Emission Level (dBμV/m)

13.6.3.2 Test data for 802.11n_HT20 RLAN Mode

13.6.3.2.1 Test data for Multiple Transmit

- Resolution bandwidth : 1 MHz and Peak Detector for Peak Mode for the emissions fall in restricted band,
1 MHz and RMS Detector for Average Mode for the emissions fall in restricted band
100 kHz for Peak Mode for the emissions outside restricted band
- Video bandwidth : 3 MHz for Peak and Average Mode
- Frequency range : 1 GHz ~ 40 GHz
- Measurement distance : 3 m
- Duty Cycle : > 98 %
- Operating mode : Transmitting mode

Frequency (MHz)	Reading (dBμV)	Detector Mode	Ant. Pol. (H/V)	Ant. Factor	Cable Loss	Duty Factor(dB)	AMP Factor	Total (dBμV/m)	Limits (dBμV/m)	Margin (dB)
Multiple Transmit										
11 000.00	50.52	Peak	H	39.00	11.85	-	46.50	54.87	74.00	19.13
11 000.00	42.36	Average	H	39.00	11.85	0.06	46.50	46.77	54.00	7.24
11 000.00	49.72	Peak	V	39.00	11.85	-	46.50	54.07	74.00	19.93
11 000.00	41.28	Average	V	39.00	11.85	0.06	46.50	45.69	54.00	8.32
11 160.00	49.41	Peak	H	39.00	12.36	-	46.50	54.27	74.00	19.73
11 160.00	40.73	Average	H	39.00	12.36	0.06	46.50	45.65	54.00	8.36
11 160.00	49.60	Peak	V	39.00	12.36	-	46.50	54.46	74.00	19.54
11 160.00	40.38	Average	V	39.00	12.36	0.06	46.50	45.30	54.00	8.71
11 400.00	50.98	Peak	H	39.00	13.11	-	46.50	56.59	74.00	17.41
11 400.00	41.35	Average	H	39.00	13.11	0.06	46.50	47.02	54.00	6.99
11 400.00	50.87	Peak	V	39.00	13.11	-	46.50	56.48	74.00	17.52
11 400.00	41.43	Average	V	39.00	13.11	0.06	46.50	47.10	54.00	6.90

Remark - "H": Horizontal, "V": Vertical

Margin (dB) = Limits (dBμV/m) - Emission Level (dBμV/m)

13.6.3.3 Test data for 802.11n_HT40 RLAN Mode

13.6.3.3.1 Test data for Multiple Transmit

- Resolution bandwidth : 1 MHz and Peak Detector for Peak Mode for the emissions fall in restricted band,
1 MHz and RMS Detector for Average Mode for the emissions fall in restricted band
100 kHz for Peak Mode for the emissions outside restricted band
- Video bandwidth : 3 MHz for Peak and Average Mode
- Frequency range : 1 GHz ~ 40 GHz
- Measurement distance : 3 m
- Duty Cycle : > 98 %
- Operating mode : Transmitting mode

Frequency (MHz)	Reading (dBμV)	Detector Mode	Ant. Pol. (H/V)	Ant. Factor	Cable Loss	Duty Factor(dB)	AMP Factor	Total (dBμV/m)	Limits (dBμV/m)	Margin (dB)
Multiple Transmit										
11 020.00	50.52	Peak	H	39.00	11.85	-	46.50	54.87	74.00	19.13
11 020.00	41.18	Average	H	39.00	11.85	0.12	46.50	45.65	54.00	8.35
11 020.00	49.79	Peak	V	39.00	11.85	-	46.50	54.14	74.00	19.86
11 020.00	41.26	Average	V	39.00	11.85	0.12	46.50	45.73	54.00	8.27
11 100.00	49.70	Peak	H	39.00	12.36	-	46.50	54.56	74.00	19.44
11 100.00	40.50	Average	H	39.00	12.36	0.12	46.50	45.48	54.00	8.52
11 100.00	50.50	Peak	V	39.00	12.36	-	46.50	55.36	74.00	18.64
11 100.00	40.51	Average	V	39.00	12.36	0.12	46.50	45.49	54.00	8.51
11 340.00	48.92	Peak	H	39.00	13.11	-	46.50	54.53	74.00	19.47
11 340.00	39.99	Average	H	39.00	13.11	0.12	46.50	45.72	54.00	8.28
11 340.00	49.37	Peak	V	39.00	13.11	-	46.50	54.98	74.00	19.02
11 340.00	40.34	Average	V	39.00	13.11	0.12	46.50	46.07	54.00	7.93

Remark - "H": Horizontal, "V": Vertical

Margin (dB) = Limits (dBμV/m) - Emission Level (dBμV/m)

13.6.3.4 Test data for 802.11ac_VHT80 RLAN Mode

13.6.3.4.1 Test data for Multiple Transmit

- Resolution bandwidth : 1 MHz and Peak Detector for Peak Mode for the emissions fall in restricted band,
1 MHz and RMS Detector for Average Mode for the emissions fall in restricted band
100 kHz for Peak Mode for the emissions outside restricted band
- Video bandwidth : 3 MHz for Peak and Average Mode
- Frequency range : 1 GHz ~ 40 GHz
- Measurement distance : 3 m
- Duty Cycle : > 98 %
- Operating mode : Transmitting mode

Frequency (MHz)	Reading (dBμV)	Detector Mode	Ant. Pol. (H/V)	Ant. Factor	Cable Loss	Duty Factor(dB)	AMP Factor	Total (dBμV/m)	Limits (dBμV/m)	Margin (dB)
Multiple Transmit										
11 060.00	50.00	Peak	H	39.00	11.85	-	46.50	54.35	74.00	19.65
11 060.00	40.84	Average	H	39.00	11.85	0.20	46.50	45.39	54.00	8.61
11 060.00	49.22	Peak	V	39.00	11.85	-	46.50	53.57	74.00	20.43
11 060.00	40.79	Average	V	39.00	11.85	0.20	46.50	45.34	54.00	8.66

Remark - "H": Horizontal, "V": Vertical

Margin (dB) = Limits (dBμV/m) - Emission Level (dBμV/m)

13.6.4 Test data for Frequency UNII 3

13.6.4.1 Test data for 802.11a RLAN Mode

- Resolution bandwidth : 1 MHz and Peak Detector for Peak Mode for the emissions fall in restricted band,
1 MHz and RMS Detector for Average Mode for the emissions fall in restricted band
100 kHz for Peak Mode for the emissions outside restricted band
- Video bandwidth : 3 MHz for Peak and Average Mode
- Frequency range : 1 GHz ~ 40 GHz
- Measurement distance : 3 m
- Duty Cycle : > 98 %
- Operating mode : Transmitting mode

Frequency (MHz)	Reading (dBμV)	Detector Mode	Ant. Pol. (H/V)	Ant. Factor	Cable Loss	Duty Factor(dB)	AMP Factor	Total (dBμV/m)	Limits (dBμV/m)	Margin (dB)
Antenna 0										
11 490.00	48.86	Peak	H	39.30	13.11	-	46.35	54.92	74.00	19.08
11 490.00	40.56	Average	H	39.30	13.11	0.05	46.35	46.67	54.00	7.34
11 490.00	49.39	Peak	V	39.30	13.11	-	46.35	55.45	74.00	18.55
11 490.00	40.60	Average	V	39.30	13.11	0.05	46.35	46.71	54.00	7.29
11 570.00	50.84	Peak	H	39.40	13.15	-	46.35	57.04	74.00	16.96
11 570.00	40.48	Average	H	39.40	13.15	0.05	46.35	46.73	54.00	7.28
11 570.00	49.44	Peak	V	39.40	13.15	-	46.35	55.64	74.00	18.36
11 570.00	40.36	Average	V	39.40	13.15	0.05	46.35	46.61	54.00	7.40
11 650.00	49.13	Peak	H	39.70	13.19	-	46.35	55.67	74.00	18.33
11 650.00	39.99	Average	H	39.70	13.19	0.05	46.35	46.58	54.00	7.43
11 650.00	49.81	Peak	V	39.70	13.19	-	46.35	56.35	74.00	17.65
11 650.00	40.33	Average	V	39.70	13.19	0.05	46.35	46.92	54.00	7.09

Frequency (MHz)	Reading (dBμV)	Detector Mode	Ant. Pol. (H/V)	Ant. Factor	Cable Loss	Duty Factor(dB)	AMP Factor	Total (dBμV/m)	Limits (dBμV/m)	Margin (dB)
Antenna 1										
11 490.00	49.13	Peak	H	39.30	13.11	-	46.35	55.19	74.00	18.81
11 490.00	40.47	Average	H	39.30	13.11	0.05	46.35	46.58	54.00	7.43
11 490.00	49.11	Peak	V	39.30	13.11	-	46.35	55.17	74.00	18.83
11 490.00	40.41	Average	V	39.30	13.11	0.05	46.35	46.52	54.00	7.49
11 570.00	49.16	Peak	H	39.40	13.15	-	46.35	55.36	74.00	18.64
11 570.00	40.53	Average	H	39.40	13.15	0.05	46.35	46.78	54.00	7.22
11 570.00	50.23	Peak	V	39.40	13.15	-	46.35	56.43	74.00	17.57
11 570.00	40.69	Average	V	39.40	13.15	0.05	46.35	46.94	54.00	7.06
11 650.00	49.47	Peak	H	39.70	13.19	-	46.35	56.01	74.00	17.99
11 650.00	40.12	Average	H	39.70	13.19	0.05	46.35	46.71	54.00	7.30
11 650.00	49.72	Peak	V	39.70	13.19	-	46.35	56.26	74.00	17.74
11 650.00	40.48	Average	V	39.70	13.19	0.05	46.35	47.07	54.00	6.94

Remark - "H": Horizontal, "V": Vertical

Margin (dB) = Limits (dBμV/m) - Emission Level (dBμV/m)

13.6.4.2 Test data for 802.11n_HT20 RLAN Mode

13.6.4.2.1 Test data for Test data for Multiple Transmit

- Resolution bandwidth : 1 MHz and Peak Detector for Peak Mode for the emissions fall in restricted band,
1 MHz and RMS Detector for Average Mode for the emissions fall in restricted band
100 kHz for Peak Mode for the emissions outside restricted band
- Video bandwidth : 3 MHz for Peak and Average Mode
- Frequency range : 1 GHz ~ 40 GHz
- Measurement distance : 3 m
- Duty Cycle : > 98 %
- Operating mode : Transmitting mode

Frequency (MHz)	Reading (dBμV)	Detector Mode	Ant. Pol. (H/V)	Ant. Factor	Cable Loss	Duty Factor(dB)	AMP Factor	Total (dBμV/m)	Limits (dBμV/m)	Margin (dB)
Multiple Transmit										
11 490.00	48.49	Peak	H	39.30	13.11	-	46.35	54.55	74.00	19.45
11 490.00	40.55	Average	H	39.30	13.11	0.06	46.35	46.67	54.00	7.34
11 490.00	49.61	Peak	V	39.30	13.11	-	46.35	55.67	74.00	18.33
11 490.00	40.68	Average	V	39.30	13.11	0.06	46.35	46.80	54.00	7.21
11 570.00	50.63	Peak	H	39.40	13.15	-	46.35	56.83	74.00	17.17
11 570.00	40.90	Average	H	39.40	13.15	0.06	46.35	47.16	54.00	6.85
11 570.00	49.05	Peak	V	39.40	13.15	-	46.35	55.25	74.00	18.75
11 570.00	40.72	Average	V	39.40	13.15	0.06	46.35	46.98	54.00	7.02
11 650.00	49.46	Peak	H	39.70	13.19	-	46.35	56.00	74.00	18.00
11 650.00	40.47	Average	H	39.70	13.19	0.06	46.35	47.07	54.00	6.94
11 650.00	49.20	Peak	V	39.70	13.19	-	46.35	55.74	74.00	18.26
11 650.00	40.43	Average	V	39.70	13.19	0.06	46.35	47.03	54.00	6.98

Remark - "H": Horizontal, "V": Vertical

Margin (dB) = Limits (dBμV/m) - Emission Level (dBμV/m)

13.6.4.3 Test data for 802.11n_HT40 RLAN Mode

13.6.4.3.1 Test data for Multiple Transmit

- Resolution bandwidth : 1 MHz and Peak Detector for Peak Mode for the emissions fall in restricted band,
1 MHz and RMS Detector for Average Mode for the emissions fall in restricted band
100 kHz for Peak Mode for the emissions outside restricted band
- Video bandwidth : 3 MHz for Peak and Average Mode
- Frequency range : 1 GHz ~ 40 GHz
- Measurement distance : 3 m
- Duty Cycle : > 98 %
- Operating mode : Transmitting mode

Frequency (MHz)	Reading (dBμV)	Detector Mode	Ant. Pol. (H/V)	Ant. Factor	Cable Loss	Duty Factor(dB)	AMP Factor	Total (dBμV/m)	Limits (dBμV/m)	Margin (dB)
Multiple Transmit										
11 510.00	50.15	Peak	H	39.30	13.11	-	46.35	56.21	74.00	17.79
11 510.00	40.30	Average	H	39.30	13.11	0.12	46.35	46.48	54.00	7.52
11 510.00	49.32	Peak	V	39.30	13.11	-	46.35	55.38	74.00	18.62
11 510.00	40.45	Average	V	39.30	13.11	0.12	46.35	46.63	54.00	7.37
11 590.00	49.26	Peak	H	39.40	13.15	-	46.35	55.46	74.00	18.54
11 590.00	40.22	Average	H	39.40	13.15	0.12	46.35	46.54	54.00	7.46
11 590.00	49.04	Peak	V	39.40	13.15	-	46.35	55.24	74.00	18.76
11 590.00	40.11	Average	V	39.40	13.15	0.12	46.35	46.43	54.00	7.57

Remark - "H": Horizontal, "V": Vertical

Margin (dB) = Limits (dBμV/m) - Emission Level (dBμV/m)

13.6.4.4 Test data for 802.11ac_VHT80 RLAN Mode

13.6.4.4.1 Test data for Multiple Transmit

- Resolution bandwidth : 1 MHz and Peak Detector for Peak Mode for the emissions fall in restricted band,
1 MHz and RMS Detector for Average Mode for the emissions fall in restricted band
100 kHz for Peak Mode for the emissions outside restricted band
- Video bandwidth : 3 MHz for Peak and Average Mode
- Frequency range : 1 GHz ~ 40 GHz
- Measurement distance : 3 m
- Duty Cycle : > 98 %
- Operating mode : Transmitting mode

Frequency (MHz)	Reading (dBμV)	Detector Mode	Ant. Pol. (H/V)	Ant. Factor	Cable Loss	Duty Factor(dB)	AMP Factor	Total (dBμV/m)	Limits (dBμV/m)	Margin (dB)
Multiple Transmit										
11550.00	49.01	Peak	H	39.40	13.15	-	46.50	55.06	74.00	18.94
11550.00	39.82	Average	H	39.40	13.15	0.20	46.50	46.07	54.00	7.93
11550.00	49.30	Peak	V	39.40	13.15	-	46.50	55.35	74.00	18.65
11550.00	39.69	Average	V	39.40	13.15	0.20	46.50	45.94	54.00	8.06

Remark - "H": Horizontal, "V": Vertical

Margin (dB) = Limits (dBμV/m) - Emission Level (dBμV/m)

14. RADIATED RESTRICTED BAND EDGE MEASUREMENTS

14.1 Operating environment

Temperature : 23 °C
 Relative humidity : 45 % R.H.

14.2 Test set-up for conducted measurement

The radiated emissions measurements were performed on the 3 m, open-field test site. The EUT was placed on a non-conductive turntable above the ground plane.

The system was rotated 360°, and the antenna was varied in the height between 1.0 m and 4.0 m in order to determine the maximum emission levels. This procedure was performed for horizontal and vertical polarization of the receiving antenna.

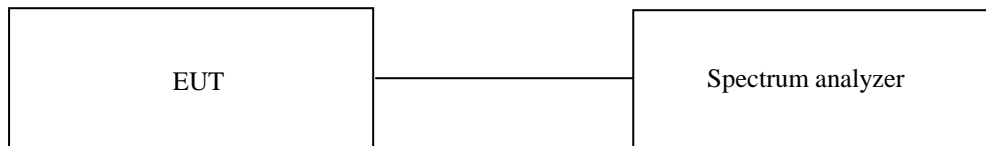

14.3 Test Date

December 05, 2021 ~ March 08, 2022

14.4 Test data for Frequency UNII I

14.4.1 Test data for 802.11a RLAN Mode

- Resolution bandwidth : 1 MHz and Peak Detector for Peak Mode
1 MHz and RMS Detector for Average Mode
- Video bandwidth : 3 MHz for Peak and Average Mode
- Measurement distance : 3 m
- Duty Cycle : > 98 %
- Result : Pass

Frequency (MHz)	Reading (dBμV)	Detector Mode	Ant. Pol. (H/V)	Ant. Factor	Cable Loss	Duty Factor(dB)	AMP Factor	ATT Factor	Total (dBμV/m)	Limits (dBμV/m)	Margin (dB)
Antenna 0											
5 149.770	57.38	Peak	H	34.20	8.21	-	45.03	6.16	60.92	74.00	13.08
5 149.091	44.98	Average	H	34.20	8.21	0.05	45.03	6.16	48.57	54.00	5.43
5 147.732	59.77	Peak	V	34.20	8.21	-	45.03	6.16	63.31	74.00	10.69
5 149.770	45.15	Average	V	34.20	8.21	0.05	45.03	6.16	48.74	54.00	5.27
Antenna 1											
5 139.580	54.30	Peak	H	34.20	8.21	-	45.03	6.16	57.84	74.00	16.16
5 146.374	44.33	Average	H	34.20	8.21	0.05	45.03	6.16	47.92	54.00	6.08
4 979.940	53.75	Peak	V	34.20	8.21	-	45.03	6.16	57.29	74.00	16.71
5 149.770	44.43	Average	V	34.20	8.21	0.05	45.03	6.16	48.02	54.00	5.99

Tabulated test data for Restricted Band

Remark - “H”: Horizontal, “V”: Vertical

$$\text{Margin (dB)} = \text{Limits (dB}\mu\text{V/m)} - \text{Emission Level (dB}\mu\text{V/m)}$$

14.4.2 Test data for 802.11n_HT20 RLAN Mode

- Resolution bandwidth : 1 MHz and Peak Detector for Peak Mode
1 MHz and RMS Detector for Average Mode
- Video bandwidth : 3 MHz for Peak and Average Mode
- Measurement distance : 3 m
- Duty Cycle : > 98 %
- Result : Pass

Frequency (MHz)	Reading (dBμV)	Detector Mode	Ant. Pol. (H/V)	Ant. Factor	Cable Loss	Duty Factor(dB)	AMP Factor	ATT Factor	Total (dBμV/m)	Limits (dBμV/m)	Margin (dB)
Multiple Transmit											
5 149.770	62.12	Peak	H	34.20	8.21	-	45.03	6.16	65.66	74.00	8.34
5 120.559	45.89	Average	H	34.20	8.21	0.06	45.03	6.16	49.49	54.00	4.51
5 149.770	62.76	Peak	V	34.20	8.21	-	45.03	6.16	66.30	74.00	7.70
5 146.374	45.56	Average	V	34.20	8.21	0.06	45.03	6.16	49.16	54.00	4.85

Tabulated test data for Restricted Band

Remark - “H”: Horizontal, “V”: Vertical

$$\text{Margin (dB)} = \text{Limits (dB}\mu\text{V/m)} - \text{Emission Level (dB}\mu\text{V/m)}$$

14.4.3 Test data for 802.11n_HT40 RLAN Mode

- Resolution bandwidth : 1 MHz and Peak Detector for Peak Mode
1 MHz and RMS Detector for Average Mode
- Video bandwidth : 3 MHz for Peak and Average Mode
- Measurement distance : 3 m
- Duty Cycle : > 98 %
- Result : Pass

Frequency (MHz)	Reading (dBμV)	Detector Mode	Ant. Pol. (H/V)	Ant. Factor	Cable Loss	Duty Factor(dB)	AMP Factor	ATT Factor	Total (dBμV/m)	Limits (dBμV/m)	Margin (dB)
Multiple Transmit											
5 144.336	61.18	Peak	H	34.20	8.21	-	45.03	6.16	64.72	74.00	9.28
5 148.412	48.53	Average	H	34.20	8.21	0.12	45.03	6.16	52.19	54.00	1.81
5 147.732	61.01	Peak	V	34.20	8.21	-	45.03	6.16	64.55	74.00	9.45
5 149.091	48.42	Average	V	34.20	8.21	0.12	45.03	6.16	52.08	54.00	1.92

Tabulated test data for Restricted Band

Remark - “H”: Horizontal, “V”: Vertical

$$\text{Margin (dB)} = \text{Limits (dB}\mu\text{V/m)} - \text{Emission Level (dB}\mu\text{V/m)}$$

14.4.4 Test data for 802.11ac_VHT80 RLAN Mode

- Resolution bandwidth : 1 MHz and Peak Detector for Peak Mode
1 MHz and RMS Detector for Average Mode
- Video bandwidth : 3 MHz for Peak and Average Mode
- Measurement distance : 3 m
- Duty Cycle : > 98 %
- Result : Pass

Frequency (MHz)	Reading (dBμV)	Detector Mode	Ant. Pol. (H/V)	Ant. Factor	Cable Loss	Duty Factor(dB)	AMP Factor	ATT Factor	Total (dBμV/m)	Limits (dBμV/m)	Margin (dB)
Multiple Transmit											
5 149.091	58.28	Peak	H	34.20	8.21	-	45.03	6.16	61.82	74.00	12.18
5 148.412	48.76	Average	H	34.20	8.21	0.20	45.03	6.16	52.50	54.00	1.50
5 147.053	60.79	Peak	V	34.20	8.21	-	45.03	6.16	64.33	74.00	9.67
5 148.412	48.86	Average	V	34.20	8.21	0.20	45.03	6.16	52.60	54.00	1.40

Tabulated test data for Restricted Band

Remark - “H”: Horizontal, “V”: Vertical

$$\text{Margin (dB)} = \text{Limits (dB}\mu\text{V/m)} - \text{Emission Level (dB}\mu\text{V/m)}$$

14.5 Test data for Frequency UNII 2A

14.5.1 Test data for 802.11a RLAN Mode

- Resolution bandwidth : 1 MHz and Peak Detector for Peak Mode
1 MHz and RMS Detector for Average Mode
- Video bandwidth : 3 MHz for Peak and Average Mode
- Measurement distance : 3 m
- Duty Cycle : > 98 %
- Result : Pass

Frequency (MHz)	Reading (dBμV)	Detector Mode	Ant. Pol. (H/V)	Ant. Factor	Cable Loss	Duty Factor(dB)	AMP Factor	ATT Factor	Total (dBμV/m)	Limits (dBμV/m)	Margin (dB)
Antenna 0											
5 350.839	61.91	Peak	H	34.10	8.58	-	45.21	6.16	65.54	74.00	8.46
5 350.839	45.48	Average	H	34.10	8.58	0.05	45.21	6.16	49.16	54.00	4.85
5 350.140	62.74	Peak	V	34.10	8.58	-	45.21	6.16	66.37	74.00	7.63
5 350.280	45.49	Average	V	34.10	8.58	0.05	45.21	6.16	49.17	54.00	4.83
Antenna 1											
5 350.280	62.80	Peak	H	34.10	8.58	-	45.21	6.16	66.43	74.00	7.57
5 350.559	45.30	Average	H	34.10	8.58	0.05	45.21	6.16	48.98	54.00	5.02
5 350.420	61.55	Peak	V	34.10	8.58	-	45.21	6.16	65.18	74.00	8.82
5 351.538	45.28	Average	V	34.10	8.58	0.05	45.21	6.16	48.96	54.00	5.05

Tabulated test data for Restricted Band

Remark - "H": Horizontal, "V": Vertical

$$\text{Margin (dB)} = \text{Limits (dB}\mu\text{V/m)} - \text{Emission Level (dB}\mu\text{V/m)}$$

14.5.2 Test data for 802.11n_HT20 RLAN Mode

- Resolution bandwidth : 1 MHz and Peak Detector for Peak Mode
1 MHz and RMS Detector for Average Mode
- Video bandwidth : 3 MHz for Peak and Average Mode
- Measurement distance : 3 m
- Duty Cycle : > 98 %
- Result : Pass

Frequency (MHz)	Reading (dBμV)	Detector Mode	Ant. Pol. (H/V)	Ant. Factor	Cable Loss	Duty Factor(dB)	AMP Factor	ATT Factor	Total (dBμV/m)	Limits (dBμV/m)	Margin (dB)
Multiple Transmit											
5 351.259	63.30	Peak	H	34.10	8.58	-	45.21	6.16	66.93	74.00	7.07
5 350.140	46.04	Average	H	34.10	8.58	0.06	45.21	6.16	49.73	54.00	4.28
5 351.259	63.14	Peak	V	34.10	8.58	-	45.21	6.16	66.77	74.00	7.23
5 350.699	46.35	Average	V	34.10	8.58	0.06	45.21	6.16	50.04	54.00	3.97

Tabulated test data for Restricted Band

Remark - “H”: Horizontal, “V”: Vertical

$$\text{Margin (dB)} = \text{Limits (dB}\mu\text{V/m)} - \text{Emission Level (dB}\mu\text{V/m)}$$

14.5.3 Test data for 802.11n_HT40 RLAN Mode

- Resolution bandwidth : 1 MHz and Peak Detector for Peak Mode
1 MHz and RMS Detector for Average Mode
- Video bandwidth : 3 MHz for Peak and Average Mode
- Measurement distance : 3 m
- Duty Cycle : > 98 %
- Result : Pass

Frequency (MHz)	Reading (dBμV)	Detector Mode	Ant. Pol. (H/V)	Ant. Factor	Cable Loss	Duty Factor(dB)	AMP Factor	ATT Factor	Total (dBμV/m)	Limits (dBμV/m)	Margin (dB)
Multiple Transmit											
5 351.958	64.90	Peak	H	34.10	8.58	-	45.21	6.16	68.53	74.00	5.47
5 352.098	48.04	Average	H	34.10	8.58	0.12	45.21	6.16	51.79	54.00	2.21
5 350.420	63.45	Peak	V	34.10	8.58	-	45.21	6.16	67.08	74.00	6.92
5 353.497	47.83	Average	V	34.10	8.58	0.12	45.21	6.16	51.58	54.00	2.42

Tabulated test data for Restricted Band

Remark - “H”: Horizontal, “V”: Vertical

$$\text{Margin (dB)} = \text{Limits (dB}\mu\text{V/m)} - \text{Emission Level (dB}\mu\text{V/m)}$$

14.5.4 Test data for 802.11ac_VHT80 RLAN Mode

- Resolution bandwidth : 1 MHz and Peak Detector for Peak Mode
1 MHz and RMS Detector for Average Mode
- Video bandwidth : 3 MHz for Peak and Average Mode
- Measurement distance : 3 m
- Duty Cycle : > 98 %
- Result : Pass

Frequency (MHz)	Reading (dBμV)	Detector Mode	Ant. Pol. (H/V)	Ant. Factor	Cable Loss	Duty Factor(dB)	AMP Factor	ATT Factor	Total (dBμV/m)	Limits (dBμV/m)	Margin (dB)
Multiple Transmit											
5 358.392	58.15	Peak	H	34.10	8.58	-	45.21	6.16	61.78	74.00	12.22
5 353.217	46.95	Average	H	34.10	8.58	0.20	45.21	6.16	50.78	54.00	3.22
5 353.077	57.96	Peak	V	34.10	8.58	-	45.21	6.16	61.59	74.00	12.41
5 352.517	47.12	Average	V	34.10	8.58	0.20	45.21	6.16	50.95	54.00	3.05

Tabulated test data for Restricted Band

Remark - “H”: Horizontal, “V”: Vertical

$$\text{Margin (dB)} = \text{Limits (dB}\mu\text{V/m)} - \text{Emission Level (dB}\mu\text{V/m)}$$

14.6 Test data for Frequency UNII 2C

14.6.1 Test data for 802.11a RLAN Mode

- Resolution bandwidth : 1 MHz and Peak Detector for Peak Mode
1 MHz and RMS Detector for Average Mode
- Video bandwidth : 3 MHz for Peak and Average Mode
- Measurement distance : 3 m
- Duty Cycle : > 98 %
- Result : Pass

Frequency (MHz)	Reading (dBμV)	Detector Mode	Ant. Pol. (H/V)	Ant. Factor	Cable Loss	Duty Factor(dB)	AMP Factor	ATT Factor	Total (dBμV/m)	Limits (dBμV/m)	Margin (dB)
Antenna 0											
5 459.016	56.75	Peak	H	34.10	8.58	-	45.21	6.16	60.38	74.00	13.62
5 449.575	44.11	Average	H	34.10	8.58	0.05	45.21	6.16	47.79	54.00	6.21
5 456.169	55.81	Peak	V	34.10	8.58	-	45.21	6.16	59.44	74.00	14.56
5 446.728	44.22	Average	V	34.10	8.58	0.05	45.21	6.16	47.90	54.00	6.11
Antenna 1											
5 460.000	56.17	Peak	H	34.10	8.58	-	45.21	6.16	59.80	74.00	14.20
5 451.973	44.04	Average	H	34.10	8.58	0.05	45.21	6.16	47.72	54.00	6.29
5 451.673	56.31	Peak	V	34.10	8.58	-	45.21	6.16	59.94	74.00	14.06
5 459.765	44.29	Average	V	34.10	8.58	0.05	45.21	6.16	47.97	54.00	6.04

Tabulated test data for Restricted Band

Remark - "H": Horizontal, "V": Vertical

$$\text{Margin (dB)} = \text{Limits (dB}\mu\text{V/m)} - \text{Emission Level (dB}\mu\text{V/m)}$$

14.6.2 Test data for 802.11n_HT20 RLAN Mode

- Resolution bandwidth : 1 MHz and Peak Detector for Peak Mode
1 MHz and RMS Detector for Average Mode
- Video bandwidth : 3 MHz for Peak and Average Mode
- Measurement distance : 3 m
- Duty Cycle : > 98 %
- Result : Pass

Frequency (MHz)	Reading (dBμV)	Detector Mode	Ant. Pol. (H/V)	Ant. Factor	Cable Loss	Duty Factor(dB)	AMP Factor	ATT Factor	Total (dBμV/m)	Limits (dBμV/m)	Margin (dB)
Multiple Transmit											
5 459.615	58.26	Peak	H	34.10	8.58	-	45.21	6.16	61.89	74.00	12.11
5 459.615	44.54	Average	H	34.10	8.58	0.06	45.21	6.16	48.23	54.00	5.78
5 456.319	57.47	Peak	V	34.10	8.58	-	45.21	6.16	61.10	74.00	12.90
5 460.000	44.21	Average	V	34.10	8.58	0.06	45.21	6.16	47.90	54.00	6.11

Tabulated test data for Restricted Band

Remark - “H”: Horizontal, “V”: Vertical

$$\text{Margin (dB)} = \text{Limits (dB}\mu\text{V/m)} - \text{Emission Level (dB}\mu\text{V/m)}$$

14.6.3 Test data for 802.11n_HT40 RLAN Mode

- Resolution bandwidth : 1 MHz and Peak Detector for Peak Mode
1 MHz and RMS Detector for Average Mode
- Video bandwidth : 3 MHz for Peak and Average Mode
- Measurement distance : 3 m
- Duty Cycle : > 98 %
- Result : Pass

Frequency (MHz)	Reading (dBμV)	Detector Mode	Ant. Pol. (H/V)	Ant. Factor	Cable Loss	Duty Factor(dB)	AMP Factor	ATT Factor	Total (dBμV/m)	Limits (dBμV/m)	Margin (dB)
Multiple Transmit											
5 459.915	58.29	Peak	H	34.10	8.58	-	45.21	6.16	61.92	74.00	12.08
5 459.615	45.56	Average	H	34.10	8.58	0.12	45.21	6.16	49.31	54.00	4.69
5 451.523	58.02	Peak	V	34.10	8.58	-	45.21	6.16	61.65	74.00	12.35
5 459.765	45.22	Average	V	34.10	8.58	0.12	45.21	6.16	48.97	54.00	5.03

Tabulated test data for Restricted Band

Remark - “H”: Horizontal, “V”: Vertical

$$\text{Margin (dB)} = \text{Limits (dB}\mu\text{V/m)} - \text{Emission Level (dB}\mu\text{V/m)}$$

14.6.4 Test data for 802.11ac_VHT80 RLAN Mode

- Resolution bandwidth : 1 MHz and Peak Detector for Peak Mode
1 MHz and RMS Detector for Average Mode
- Video bandwidth : 3 MHz for Peak and Average Mode
- Measurement distance : 3 m
- Duty Cycle : > 98 %
- Result : Pass

Frequency (MHz)	Reading (dBμV)	Detector Mode	Ant. Pol. (H/V)	Ant. Factor	Cable Loss	Duty Factor(dB)	AMP Factor	ATT Factor	Total (dBμV/m)	Limits (dBμV/m)	Margin (dB)
Multiple Transmit											
5 458.117	59.86	Peak	H	34.10	8.58	-	45.21	6.16	63.49	74.00	10.51
5 457.817	47.07	Average	H	34.10	8.58	0.20	45.21	6.16	50.90	54.00	3.10
5 453.322	58.17	Peak	V	34.10	8.58	-	45.21	6.16	61.80	74.00	12.20
5 458.417	47.01	Average	V	34.10	8.58	0.20	45.21	6.16	50.84	54.00	3.16

Tabulated test data for Restricted Band

Remark - “H”: Horizontal, “V”: Vertical

$$\text{Margin (dB)} = \text{Limits (dB}\mu\text{V/m)} - \text{Emission Level (dB}\mu\text{V/m)}$$

14.7 Test data for Frequency U-NII-3

14.7.1 Test data for 802.11a RLAN Mode

- Resolution bandwidth : 1 MHz and Peak Detector for Peak Mode
1 MHz and RMS Detector for Average Mode
- Video bandwidth : 3 MHz for Peak and Average Mode
- Measurement distance : 3 m
- Duty Cycle : > 98 %
- Result : Pass

Frequency (MHz)	Reading (dBμV)	Detector Mode	Ant. Pol. (H/V)	Ant. Factor	Cable Loss	DUTY Factor	AMP Factor	ATT Factor	Total (dBμV/m)	Limits (dBμV/m)	Margin (dB)
Low Channel (Antenna 0)											
5 672.650	52.12	Peak	H	34.10	8.71	-	45.31	6.15	55.77	84.96	29.19
5 718.170	51.49	Peak	H	34.10	8.71	-	45.31	6.15	55.14	110.29	55.15
5 724.830	50.62	Peak	H	34.10	8.71	-	45.31	6.15	54.27	121.81	67.54
5 851.400	52.66	Peak	H	34.40	8.91	-	45.19	6.14	56.92	119.01	62.09
5 871.910	52.69	Peak	H	34.40	8.91	-	45.19	6.14	56.95	106.07	49.12
5 891.910	52.94	Peak	H	34.40	8.91	-	45.19	6.14	57.20	92.69	35.49
5 684.940	52.29	Peak	V	34.10	8.71	-	45.31	6.15	55.94	94.06	38.12
5 711.680	53.03	Peak	V	34.10	8.71	-	45.31	6.15	56.68	108.47	51.79
5 723.780	52.82	Peak	V	34.10	8.71	-	45.31	6.15	56.47	119.42	62.95
5 855.000	51.77	Peak	V	34.40	8.91	-	45.19	6.14	56.03	110.80	54.77
5 867.960	52.70	Peak	V	34.40	8.91	-	45.19	6.14	56.96	107.17	50.21
5 881.770	53.79	Peak	V	34.40	8.91	-	45.19	6.14	58.05	100.19	42.14

Tabulated test data for Restricted Band

Remark - "H": Horizontal, "V": Vertical

$$\text{Margin (dB)} = \text{Limits (dB}\mu\text{V/m)} - \text{Emission Level (dB}\mu\text{V/m)}$$

Frequency (MHz)	Reading (dBμV)	Detector Mode	Ant. Pol. (H/V)	Ant. Factor	Cable Loss	DUTY Factor	AMP Factor	ATT Factor	Total (dBμV/m)	Limits (dBμV/m)	Margin (dB)
High Channel (Antenna 0)											
5 681.090	52.17	Peak	H	34.10	8.71	-	45.31	6.15	55.82	91.21	35.39
5 714.580	51.26	Peak	H	34.10	8.71	-	45.31	6.15	54.91	109.28	54.37
5 722.840	51.85	Peak	H	34.10	8.71	-	45.31	6.15	55.50	117.28	61.78
5 852.570	53.37	Peak	H	34.40	8.91	-	45.19	6.14	57.63	116.34	58.71
5 870.470	52.28	Peak	H	34.40	8.91	-	45.19	6.14	56.54	106.47	49.93
5 909.840	53.14	Peak	H	34.40	8.91	-	45.19	6.14	57.40	79.42	22.02
5 674.050	51.79	Peak	V	34.10	8.71	-	45.31	6.15	55.44	86.00	30.56
5 718.130	53.10	Peak	V	34.10	8.71	-	45.31	6.15	56.75	110.28	53.53
5 723.790	52.33	Peak	V	34.10	8.71	-	45.31	6.15	55.98	119.44	63.46
5 851.620	53.54	Peak	V	34.40	8.91	-	45.19	6.14	57.80	118.51	60.71
5 860.700	52.91	Peak	V	34.40	8.91	-	45.19	6.14	57.17	109.20	52.03
5 892.410	53.05	Peak	V	34.40	8.91	-	45.19	6.14	57.31	92.32	35.01

Tabulated test data for Restricted Band

Remark - "H": Horizontal, "V": Vertical

$$\text{Margin (dB)} = \text{Limits (dB}\mu\text{V/m)} - \text{Emission Level (dB}\mu\text{V/m)}$$

Tabulated test data for Restricted Band

Frequency (MHz)	Reading (dBμV)	Detector Mode	Ant. Pol. (H/V)	Ant. Factor	Cable Loss	DUTY Factor	AMP Factor	ATT Factor	Total (dBμV/m)	Limits (dBμV/m)	Margin (dB)
Low Channel (Antenna 1)											
5 657.870	52.19	Peak	H	34.10	8.71	-	45.31	6.15	55.84	74.02	18.18
5 705.280	51.39	Peak	H	34.10	8.71	-	45.31	6.15	55.04	106.68	51.64
5 722.210	52.25	Peak	H	34.10	8.71	-	45.31	6.15	55.90	115.84	59.94
5 850.040	50.96	Peak	H	34.40	8.91	-	45.19	6.14	55.22	122.11	66.89
5 862.320	52.47	Peak	H	34.40	8.91	-	45.19	6.14	56.73	108.75	52.02
5 884.070	52.54	Peak	H	34.40	8.91	-	45.19	6.14	56.80	98.49	41.69
5 672.250	53.32	Peak	V	34.10	8.71	-	45.31	6.15	56.97	84.67	27.70
5 714.680	53.05	Peak	V	34.10	8.71	-	45.31	6.15	56.70	109.31	52.61
5 720.110	52.50	Peak	V	34.10	8.71	-	45.31	6.15	56.15	111.05	54.90
5 850.000	52.96	Peak	V	34.40	8.91	-	45.19	6.14	57.22	122.20	64.98
5 862.840	53.60	Peak	V	34.40	8.91	-	45.19	6.14	57.86	108.60	50.74
5 924.980	53.60	Peak	V	34.40	8.91	-	45.19	6.14	57.86	68.21	10.35

Tabulated test data for Restricted Band

Remark - "H": Horizontal, "V": Vertical

$$\text{Margin (dB)} = \text{Limits (dB}\mu\text{V/m)} - \text{Emission Level (dB}\mu\text{V/m)}$$

Frequency (MHz)	Reading (dBμV)	Detector Mode	Ant. Pol. (H/V)	Ant. Factor	Cable Loss	DUTY Factor	AMP Factor	ATT Factor	Total (dBμV/m)	Limits (dBμV/m)	Margin (dB)
High Channel (Antenna 1)											
5 673.700	51.72	Peak	H	34.10	8.71	-	45.31	6.15	55.37	85.74	30.37
5 706.860	52.29	Peak	H	34.10	8.71	-	45.31	6.15	55.94	107.12	51.18
5 720.080	51.59	Peak	H	34.10	8.71	-	45.31	6.15	55.24	110.98	55.74
5 851.140	51.51	Peak	H	34.40	8.91	-	45.19	6.14	55.77	119.60	63.83
5 866.720	52.59	Peak	H	34.40	8.91	-	45.19	6.14	56.85	107.52	50.67
5 876.820	53.84	Peak	H	34.40	8.91	-	45.19	6.14	58.10	103.85	45.75
5 697.030	53.03	Peak	V	34.10	8.71	-	45.31	6.15	56.68	103.00	46.32
5 718.830	53.28	Peak	V	34.10	8.71	-	45.31	6.15	56.93	110.47	53.54
5 721.840	52.22	Peak	V	34.10	8.71	-	45.31	6.15	55.87	115.00	59.13
5 853.140	52.69	Peak	V	34.40	8.91	-	45.19	6.14	56.95	115.04	58.09
5 868.980	54.04	Peak	V	34.40	8.91	-	45.19	6.14	58.30	106.89	48.59
5 899.450	53.04	Peak	V	34.40	8.91	-	45.19	6.14	57.30	87.11	29.81

Tabulated test data for Restricted Band

Remark - “H”: Horizontal, “V”: Vertical

$$\text{Margin (dB)} = \text{Limits (dB}\mu\text{V/m)} - \text{Emission Level (dB}\mu\text{V/m)}$$

14.7.2 Test data for 802.11n_HT20 RLAN Mode

- Resolution bandwidth : 1 MHz and Peak Detector for Peak Mode
1 MHz and RMS Detector for Average Mode
- Video bandwidth : 3 MHz for Peak and Average Mode
- Measurement distance : 3 m
- Duty Cycle : > 98 %
- Result : Pass

Frequency (MHz)	Reading (dBμV)	Detector Mode	Ant. Pol. (H/V)	Ant. Factor	Cable Loss	DUTY Factor	AMP Factor	AMP Factor	Total (dBμV/m)	Limits (dBμV/m)	Margin (dB)
Low Channel (Multiple Transmit)											
5 678.900	52.27	Peak	H	34.10	8.71	-	45.31	6.15	55.92	89.59	33.67
5 707.720	51.97	Peak	H	34.10	8.71	-	45.31	6.15	55.62	107.36	51.74
5 724.870	54.30	Peak	H	34.10	8.71	-	45.31	6.15	57.95	121.90	63.95
5 851.180	52.38	Peak	H	34.40	8.91	-	45.19	6.14	56.64	119.51	62.87
5 749.990	52.14	Peak	H	34.40	8.91	-	45.19	6.14	56.40	140.20	83.80
5 884.920	54.07	Peak	H	34.40	8.91	-	45.19	6.14	58.33	97.86	39.53
5 665.810	52.26	Peak	V	34.10	8.71	-	45.31	6.15	55.91	79.90	23.99
5 707.040	53.97	Peak	V	34.10	8.71	-	45.31	6.15	57.62	107.17	49.55
5 723.080	52.74	Peak	V	34.10	8.71	-	45.31	6.15	56.39	117.82	61.43
5 851.120	51.85	Peak	V	34.40	8.91	-	45.19	6.14	56.11	119.65	63.54
5 861.920	52.52	Peak	V	34.40	8.91	-	45.19	6.14	56.78	108.86	52.08
5 918.280	53.21	Peak	V	34.40	8.91	-	45.19	6.14	57.47	73.17	15.70

Tabulated test data for Restricted Band

Remark - “H”: Horizontal, “V”: Vertical

Margin (dB) = Limits (dBμV/m) - Emission Level (dBμV/m)

Frequency (MHz)	Reading (dBμV)	Detector Mode	Ant. Pol. (H/V)	Ant. Factor	Cable Loss	DUTY Factor	AMP Factor	AMP Factor	Total (dBμV/m)	Limits (dBμV/m)	Margin (dB)
High Channel (Multiple Transmit)											
5 661.160	52.11	Peak	H	34.10	8.71	-	45.31	6.15	55.76	76.46	20.70
5 718.850	52.08	Peak	H	34.10	8.71	-	45.31	6.15	55.73	110.48	54.75
5 724.160	53.08	Peak	H	34.10	8.71	-	45.31	6.15	56.73	120.28	63.55
5 850.590	53.98	Peak	H	34.40	8.91	-	45.19	6.14	58.24	120.85	62.61
5 872.810	52.93	Peak	H	34.40	8.91	-	45.19	6.14	57.19	105.81	48.62
5 900.650	52.38	Peak	H	34.40	8.91	-	45.19	6.14	56.64	86.22	29.58
5 682.540	53.14	Peak	V	34.10	8.71	-	45.31	6.15	56.79	92.28	35.49
5 706.300	51.99	Peak	V	34.10	8.71	-	45.31	6.15	55.64	106.96	51.32
5 722.210	51.52	Peak	V	34.10	8.71	-	45.31	6.15	55.17	115.84	60.67
5 850.000	54.50	Peak	V	34.40	8.91	-	45.19	6.14	58.76	122.20	63.44
5 866.540	54.20	Peak	V	34.40	8.91	-	45.19	6.14	58.46	107.57	49.11
5 896.150	52.81	Peak	V	34.40	8.91	-	45.19	6.14	57.07	89.55	32.48

Tabulated test data for Restricted Band

Remark - “H”: Horizontal, “V”: Vertical

$$\text{Margin (dB)} = \text{Limits (dB}\mu\text{V/m)} - \text{Emission Level (dB}\mu\text{V/m)}$$

14.7.3 Test data for 802.11n_HT40 RLAN Mode

- Resolution bandwidth : 1 MHz and Peak Detector for Peak Mode
1 MHz and RMS Detector for Average Mode
- Video bandwidth : 3 MHz for Peak and Average Mode
- Measurement distance : 3 m
- Duty Cycle : > 98 %
- Result : Pass

Frequency (MHz)	Reading (dBμV)	Detector Mode	Ant. Pol. (H/V)	Ant. Factor	Cable Loss	DUTY Factor	AMP Factor	AMP Factor	Total (dBμV/m)	Limits (dBμV/m)	Margin (dB)
Low Channel (Multiple Transmit)											
5 671.150	52.56	Peak	H	34.10	8.71	-	45.31	6.15	56.21	83.85	27.64
5 717.490	55.99	Peak	H	34.10	8.71	-	45.31	6.15	59.64	110.10	50.46
5 721.930	55.43	Peak	H	34.10	8.71	-	45.31	6.15	59.08	115.20	56.12
5 851.350	52.27	Peak	H	34.40	8.91	-	45.19	6.14	56.53	119.12	62.59
5 870.810	52.30	Peak	H	34.40	8.91	-	45.19	6.14	56.56	106.37	49.81
5 901.850	52.95	Peak	H	34.40	8.91	-	45.19	6.14	57.21	85.33	28.12
5 674.200	52.70	Peak	V	34.10	8.71	-	45.31	6.15	56.35	86.11	29.76
5 719.990	59.40	Peak	V	34.10	8.71	-	45.31	6.15	63.05	110.80	47.75
5 724.090	61.45	Peak	V	34.10	8.71	-	45.31	6.15	65.10	120.13	55.03
5 854.870	52.63	Peak	V	34.40	8.91	-	45.19	6.14	56.89	111.10	54.21
5 870.330	53.48	Peak	V	34.40	8.91	-	45.19	6.14	57.74	106.51	48.77
5 896.150	52.59	Peak	V	34.40	8.91	-	45.19	6.14	56.85	89.55	32.70

Tabulated test data for Restricted Band

Remark - “H”: Horizontal, “V”: Vertical

$$\text{Margin (dB)} = \text{Limits (dB}\mu\text{V/m)} - \text{Emission Level (dB}\mu\text{V/m)}$$

Frequency (MHz)	Reading (dBμV)	Detector Mode	Ant. Pol. (H/V)	Ant. Factor	Cable Loss	DUTY Factor	AMP Factor	AMP Factor	Total (dBμV/m)	Limits (dBμV/m)	Margin (dB)
High Channel (Multiple Transmit)											
5 665.460	51.96	Peak	H	34.10	8.71	-	45.31	6.15	55.61	79.64	24.03
5 715.410	51.93	Peak	H	34.10	8.71	-	45.31	6.15	55.58	109.51	53.93
5 723.460	51.48	Peak	H	34.10	8.71	-	45.31	6.15	55.13	118.69	63.56
5 855.000	51.32	Peak	H	34.40	8.91	-	45.19	6.14	55.58	110.80	55.22
5 865.500	52.88	Peak	H	34.40	8.91	-	45.19	6.14	57.14	107.86	50.72
5 888.810	53.39	Peak	H	34.40	8.91	-	45.19	6.14	57.65	94.98	37.33
5 664.010	51.95	Peak	V	34.10	8.71	-	45.31	6.15	55.60	78.57	22.97
5 711.760	51.39	Peak	V	34.10	8.71	-	45.31	6.15	55.04	108.49	53.45
5 721.380	51.11	Peak	V	34.10	8.71	-	45.31	6.15	54.76	113.95	59.19
5 851.300	52.00	Peak	V	34.40	8.91	-	45.19	6.14	56.26	119.24	62.98
5 866.840	52.24	Peak	V	34.40	8.91	-	45.19	6.14	56.50	107.48	50.98
5 902.050	52.05	Peak	V	34.40	8.91	-	45.19	6.14	56.31	85.18	28.87

Tabulated test data for Restricted Band

Remark - "H": Horizontal, "V": Vertical

$$\text{Margin (dB)} = \text{Limits (dB}\mu\text{V/m)} - \text{Emission Level (dB}\mu\text{V/m)}$$

14.7.4 Test data for 802.11ac_VHT80 RLAN Mode

- Resolution bandwidth : 1 MHz and Peak Detector for Peak Mode
1 MHz and RMS Detector for Average Mode
- Video bandwidth : 3 MHz for Peak and Average Mode
- Measurement distance : 3 m
- Duty Cycle : > 98 %
- Result : Pass

Frequency (MHz)	Reading (dBμV)	Detector Mode	Ant. Pol. (H/V)	Ant. Factor	Cable Loss	DUTY Factor	AMP Factor	AMP Factor	Total (dBμV/m)	Limits (dBμV/m)	Margin (dB)
Low Channel (Multiple Transmit)											
5 695.130	51.24	Peak	H	34.10	8.71	-	45.31	6.15	54.89	101.60	46.71
5 704.910	50.91	Peak	H	34.10	8.71	-	45.31	6.15	54.56	106.57	52.01
5 723.670	50.17	Peak	H	34.10	8.71	-	45.31	6.15	53.82	119.17	65.35
5 854.090	51.54	Peak	H	34.40	8.91	-	45.19	6.14	55.80	112.87	57.07
5 867.440	51.40	Peak	H	34.40	8.91	-	45.19	6.14	55.66	107.32	51.66
5 906.990	53.00	Peak	H	34.40	8.91	-	45.19	6.14	57.26	81.53	24.27
5 686.490	53.20	Peak	V	34.10	8.71	-	45.31	6.15	56.85	95.20	38.35
5 712.320	52.59	Peak	V	34.10	8.71	-	45.31	6.15	56.24	108.65	52.41
5 724.660	52.38	Peak	V	34.10	8.71	-	45.31	6.15	56.03	121.42	65.39
5 852.440	53.18	Peak	V	34.40	8.91	-	45.19	6.14	57.44	116.64	59.20
5 860.140	53.50	Peak	V	34.40	8.91	-	45.19	6.14	57.76	109.36	51.60
5 924.980	51.56	Peak	V	34.40	8.91	-	45.19	6.14	55.82	68.21	12.39

Tabulated test data for Restricted Band

Remark - “H”: Horizontal, “V”: Vertical

$$\text{Margin (dB)} = \text{Limits (dB}\mu\text{V/m)} - \text{Emission Level (dB}\mu\text{V/m)}$$

14.7.5 U-NII-3 Emission Limits

14.7.5.1 Emission Mask Plots

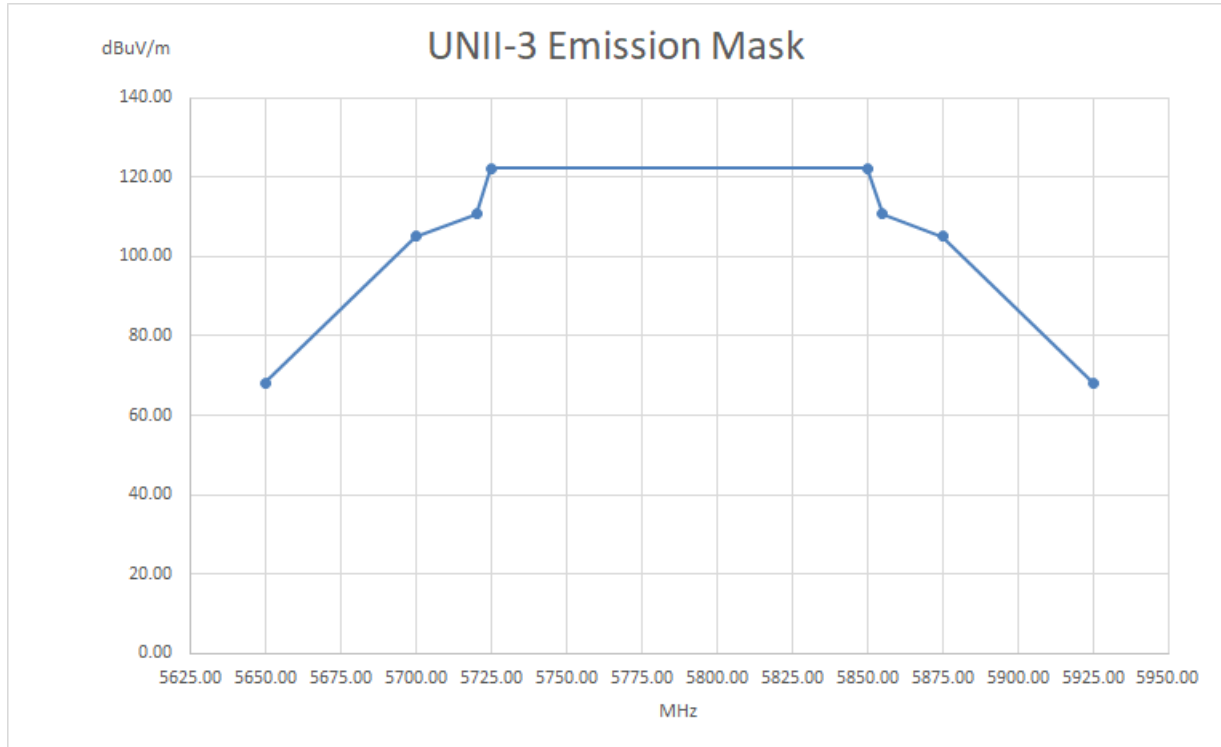

Remark.

- Title 47 → Part 15 → Subpart E—UNLICENSED NATIONAL INFORMATION INFRASTRUCTURE DEVICES

§ 15.407 General technical requirements.

(4) For transmitters operating in the 5.725-5.85 GHz band:

- (i) All emissions shall be limited to a level of -27 dBm/MHz at 75 MHz or more above or below the band edge increasing linearly to 10 dBm/MHz at 25 MHz above or below the band edge, and from 25 MHz above or below the band edge increasing linearly to a level of 15.6 dBm/MHz at 5 MHz above or below the band edge, and from 5 MHz above or below the band edge increasing linearly to a level of 27 dBm/MHz at the band edge.

15. CONDUCTED EMISSION TEST

15.1 Operating environment

Temperature : 23 °C
Relative humidity : 45 % R.H.

15.2 Test set-up

The EUT was placed on a wooden table, 0.8 m height above the floor. Power was fed to the EUT through a 50 Ω / 50 μ H + 5 Ω Artificial Mains Network (AMN). The ground plane was electrically bonded to the reference ground system and all power lines were filtered from ambient.

15.3 Test Date

December 05, 2021 ~ March 08, 2022

15.4 Test data for WLAN 5 GHz

- Resolution bandwidth : 9 kHz
- Frequency range : 0.15 MHz ~ 30 MHz
- Tested Line : LIVE LINE
- Antenna 0, Antenna 1 and Multiple transmit tested, but the worst data were recorded.

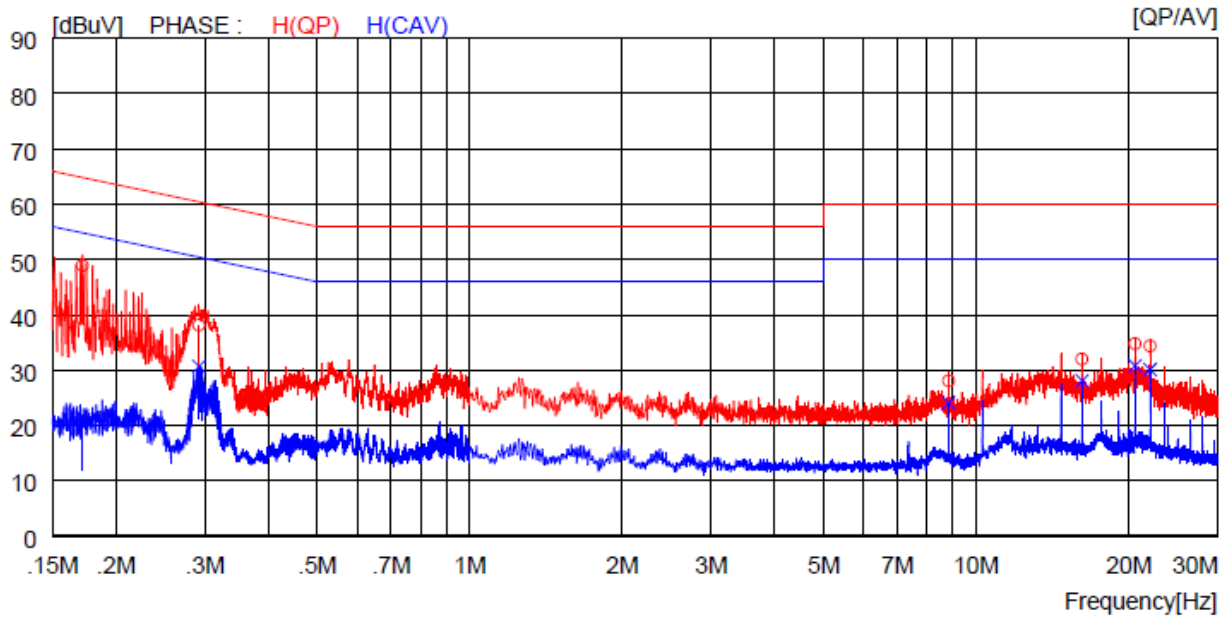

NO	FREQ [MHz]	READING		C.FACTOR [dB]	RESULT		LIMIT		MARGIN		PHASE
		QP [dBuV]	AV [dBuV]		QP [dBuV]	AV [dBuV]	QP [dBuV]	AV [dBuV]	QP [dBuV]	AV [dBuV]	
1	0.17200	38.9	----	10.0	48.9	----	64.9	----	16.0	----	H(QP)
2	0.29200	28.1	----	10.0	38.1	----	60.5	----	22.4	----	H(QP)
3	8.83500	17.9	----	10.2	28.1	----	60.0	----	31.9	----	H(QP)
4	16.19000	21.7	----	10.3	32.0	----	60.0	----	28.0	----	H(QP)
5	20.60000	24.4	----	10.4	34.8	----	60.0	----	25.2	----	H(QP)
6	22.08000	24.0	----	10.4	34.4	----	60.0	----	25.6	----	H(QP)
7	0.17200	----	11.6	10.0	----	21.6	----	54.9	----	33.3	H(CAV)
8	0.29200	----	20.7	10.0	----	30.7	----	50.5	----	19.8	H(CAV)
9	8.83500	----	13.9	10.2	----	24.1	----	50.0	----	25.9	H(CAV)
10	16.19000	----	17.8	10.3	----	28.1	----	50.0	----	21.9	H(CAV)
11	20.60000	----	20.4	10.4	----	30.8	----	50.0	----	19.2	H(CAV)
12	22.08000	----	19.7	10.4	----	30.1	----	50.0	----	19.9	H(CAV)

This Report is not correlated with the authentication of KOLAS

It should not be reproduced except in full, without the written approval of ONETECH Corp.

OTC-TRF-RF-001(0)

-. Tested Line : NEUTRAL LINE

Remark: Margin (dB) = Limit – Level (Result)

The emission level in above table is included the transducer factor that means insertion loss (LISN), cable loss and attenuator.

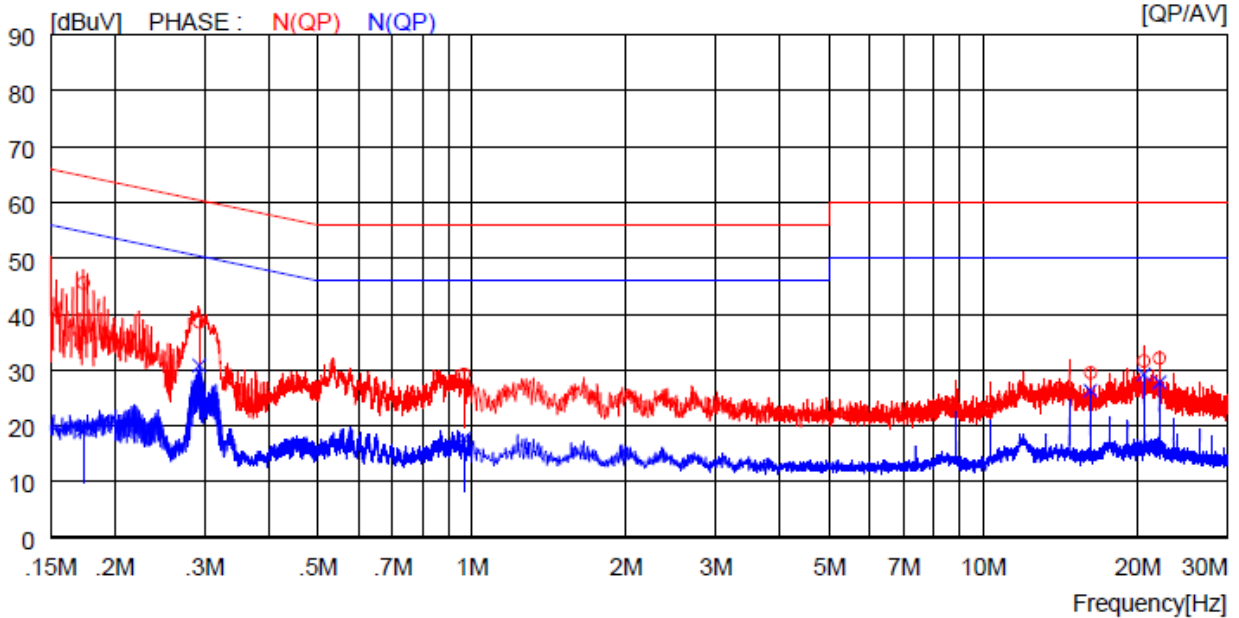

NO	FREQ [MHz]	READING		C.FACTOR [dB]	RESULT		LIMIT		MARGIN		PHASE
		QP [dBuV]	AV [dBuV]		QP [dBuV]	AV [dBuV]	QP [dBuV]	AV [dBuV]	QP [dBuV]	AV [dBuV]	
1	0.17400	35.6	----	10.0	45.6	----	64.8	----	19.2	----	N(QP)
2	0.29300	28.6	----	10.0	38.6	----	60.4	----	21.8	----	N(QP)
3	0.96500	19.2	----	10.0	29.2	----	56.0	----	26.8	----	N(QP)
4	16.20000	19.2	----	10.3	29.5	----	60.0	----	30.5	----	N(QP)
5	20.61000	21.2	----	10.4	31.6	----	60.0	----	28.4	----	N(QP)
6	22.09000	21.7	----	10.4	32.1	----	60.0	----	27.9	----	N(QP)
7	0.17400	----	9.3	10.0	----	19.3	----	54.8	----	35.5	N(CAV)
8	0.29300	----	20.8	10.0	----	30.8	----	50.4	----	19.6	N(CAV)
9	0.96500	----	7.7	10.0	----	17.7	----	46.0	----	28.3	N(CAV)
10	16.20000	----	16.0	10.3	----	26.3	----	50.0	----	23.7	N(CAV)
11	20.61000	----	18.8	10.4	----	29.2	----	50.0	----	20.8	N(CAV)
12	22.09000	----	17.4	10.4	----	27.8	----	50.0	----	22.2	N(CAV)

15.6 Test data for Intermodulation Mode(WLAN 5 GHz + Bluetooth)

- Resolution bandwidth : 9 kHz
- Frequency range : 0.15 MHz ~ 30 MHz
- Tested Line : LIVE LINE

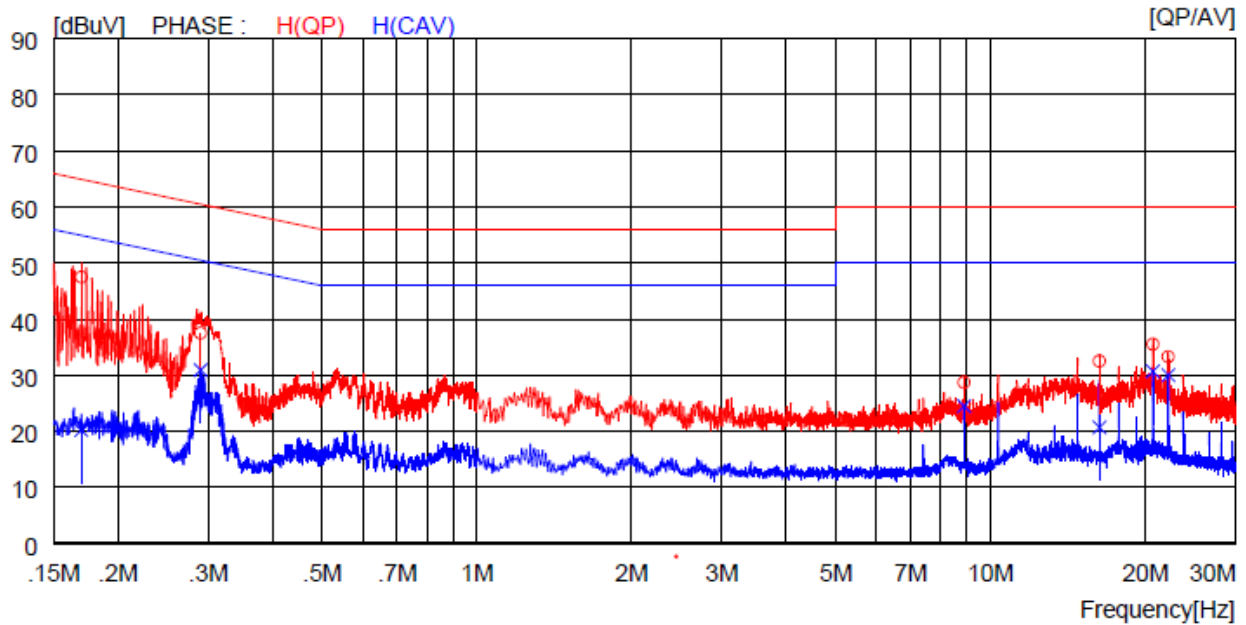

NO	FREQ [MHz]	READING		C. FACTOR [dB]	RESULT		LIMIT		MARGIN		PHASE
		QP [dBuV]	AV [dBuV]		QP [dBuV]	AV [dBuV]	QP [dBuV]	AV [dBuV]	QP [dBuV]	AV [dBuV]	
1	0.17000	37.5	----	10.0	47.5	----	65.0	----	17.5	----	H (QP)
2	0.29000	27.5	----	10.0	37.5	----	60.5	----	23.0	----	H (QP)
3	8.88500	18.5	----	10.2	28.7	----	60.0	----	31.3	----	H (QP)
4	16.30000	22.2	----	10.3	32.5	----	60.0	----	27.5	----	H (QP)
5	20.73000	25.1	----	10.4	35.5	----	60.0	----	24.5	----	H (QP)
6	22.21000	22.9	----	10.4	33.3	----	60.0	----	26.7	----	H (QP)
7	0.17000	----	10.2	10.0	----	20.2	----	55.0	----	34.8	H (CAV)
8	0.29000	----	20.9	10.0	----	30.9	----	50.5	----	19.6	H (CAV)
9	8.88500	----	14.3	10.2	----	24.5	----	50.0	----	25.5	H (CAV)
10	16.30000	----	10.4	10.3	----	20.7	----	50.0	----	29.3	H (CAV)
11	20.73000	----	20.3	10.4	----	30.7	----	50.0	----	19.3	H (CAV)
12	22.21000	----	19.6	10.4	----	30.0	----	50.0	----	20.0	H (CAV)

This Report is not correlated with the authentication of KOLAS

It should not be reproduced except in full, without the written approval of ONETECH Corp.

OTC-TRF-RF-001(0)

- Tested Line : NEUTRAL LINE

Remark: Margin (dB) = Limit – Level (Result)

The emission level in above table is included the transducer factor that means insertion loss (LISN), cable loss and attenuator.

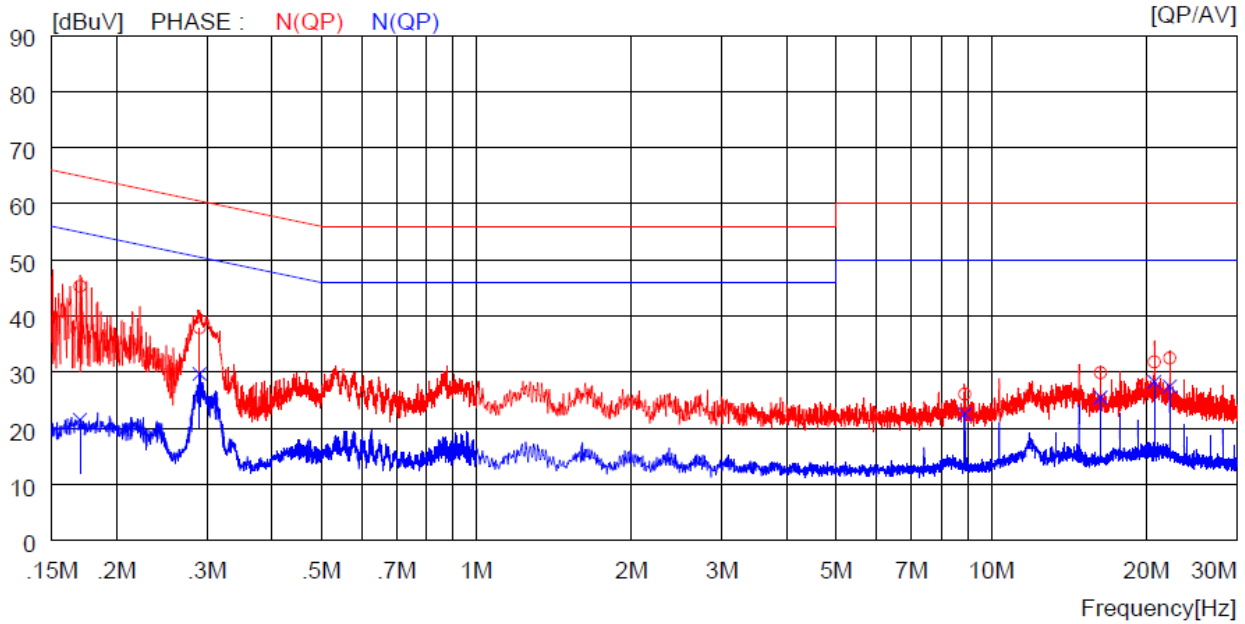

NO	FREQ [MHz]	READING		C. FACTOR [dB]	RESULT		LIMIT		MARGIN		PHASE
		QP [dBuV]	AV [dBuV]		QP [dBuV]	AV [dBuV]	QP [dBuV]	AV [dBuV]	QP [dBuV]	AV [dBuV]	
1	0.17000	35.3	----	10.0	45.3	----	65.0	----	19.7	----	N (QP)
2	0.29000	27.9	----	10.0	37.9	----	60.5	----	22.6	----	N (QP)
3	8.89000	15.9	----	10.2	26.1	----	60.0	----	33.9	----	N (QP)
4	16.30000	19.6	----	10.3	29.9	----	60.0	----	30.1	----	N (QP)
5	20.74000	21.4	----	10.4	31.8	----	60.0	----	28.2	----	N (QP)
6	22.22000	22.1	----	10.4	32.5	----	60.0	----	27.5	----	N (QP)
7	0.17000	----	11.5	10.0	----	21.5	----	55.0	----	33.5	N (CAV)
8	0.29000	----	19.7	10.0	----	29.7	----	50.5	----	20.8	N (CAV)
9	8.89000	----	12.4	10.2	----	22.6	----	50.0	----	27.4	N (CAV)
10	16.30000	----	15.2	10.3	----	25.5	----	50.0	----	24.5	N (CAV)
11	20.74000	----	17.9	10.4	----	28.3	----	50.0	----	21.7	N (CAV)
12	22.22000	----	17.1	10.4	----	27.5	----	50.0	----	22.5	N (CAV)

15.7 Test data for Intermodulation Mode(WLAN 5 GHz + Bluetooth LE)

- Resolution bandwidth : 9 kHz
- Frequency range : 0.15 MHz ~ 30 MHz
- Tested Line : LIVE LINE

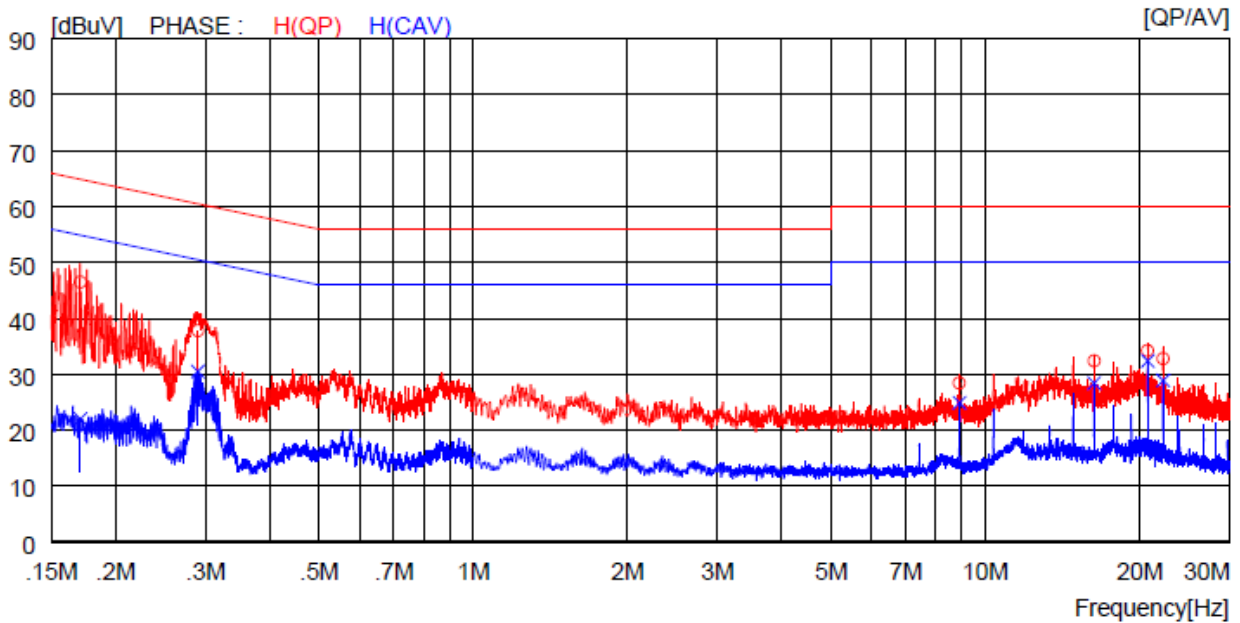

NO	FREQ [MHz]	READING		C. FACTOR [dB]	RESULT		LIMIT		MARGIN		PHASE
		QP [dBuV]	AV [dBuV]		QP [dBuV]	AV [dBuV]	QP [dBuV]	AV [dBuV]	QP [dBuV]	AV [dBuV]	
1	0.17100	36.5	----	10.0	46.5	----	64.9	----	18.4	----	H(QP)
2	0.29000	27.8	----	10.0	37.8	----	60.5	----	22.7	----	H(QP)
3	8.90500	18.2	----	10.2	28.4	----	60.0	----	31.6	----	H(QP)
4	16.32000	22.1	----	10.3	32.4	----	60.0	----	27.6	----	H(QP)
5	20.77000	23.8	----	10.4	34.2	----	60.0	----	25.8	----	H(QP)
6	22.25000	22.4	----	10.4	32.8	----	60.0	----	27.2	----	H(QP)
7	0.17100	----	12.0	10.0	----	22.0	----	54.9	----	32.9	H(CAV)
8	0.29000	----	20.5	10.0	----	30.5	----	50.5	----	20.0	H(CAV)
9	8.90500	----	14.7	10.2	----	24.9	----	50.0	----	25.1	H(CAV)
10	16.32000	----	18.1	10.3	----	28.4	----	50.0	----	21.6	H(CAV)
11	20.77000	----	22.0	10.4	----	32.4	----	50.0	----	17.6	H(CAV)
12	22.25000	----	18.5	10.4	----	28.9	----	50.0	----	21.1	H(CAV)

This Report is not correlated with the authentication of KOLAS

It should not be reproduced except in full, without the written approval of ONETECH Corp.

OTC-TRF-RF-001(0)

- Tested Line : NEUTRAL LINE

Remark: Margin (dB) = Limit – Level (Result)

The emission level in above table is included the transducer factor that means insertion loss (LISN), cable loss and attenuator.

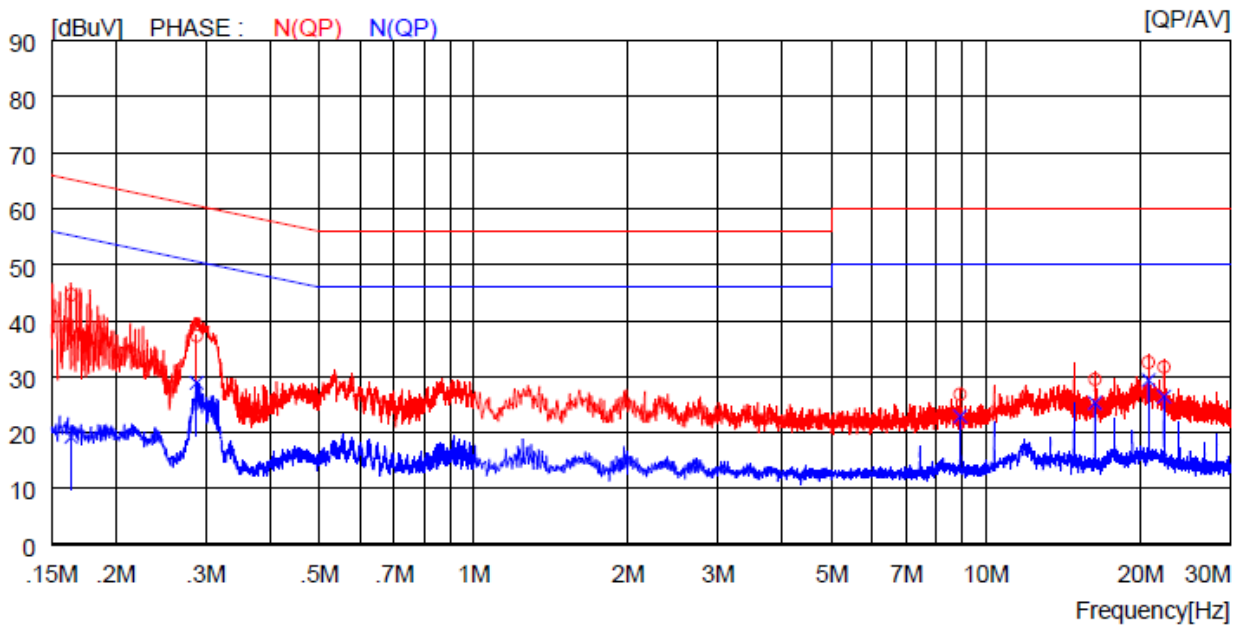

NO	FREQ [MHz]	READING		C. FACTOR [dB]	RESULT		LIMIT		MARGIN		PHASE
		QP [dBuV]	AV [dBuV]		QP [dBuV]	AV [dBuV]	QP [dBuV]	AV [dBuV]	QP [dBuV]	AV [dBuV]	
1	0.16400	34.6	----	10.0	44.6	----	65.3	----	20.7	----	N (QP)
2	0.28800	27.3	----	10.0	37.3	----	60.6	----	23.3	----	N (QP)
3	8.90500	16.6	----	10.2	26.8	----	60.0	----	33.2	----	N (QP)
4	16.32000	19.2	----	10.3	29.5	----	60.0	----	30.5	----	N (QP)
5	20.77000	22.2	----	10.4	32.6	----	60.0	----	27.4	----	N (QP)
6	22.26000	21.3	----	10.4	31.7	----	60.0	----	28.3	----	N (QP)
7	0.16400	----	9.2	10.0	----	19.2	----	55.3	----	36.1	N (CAV)
8	0.28800	----	18.9	10.0	----	28.9	----	50.6	----	21.7	N (CAV)
9	8.90500	----	12.7	10.2	----	22.9	----	50.0	----	27.1	N (CAV)
10	16.32000	----	15.0	10.3	----	25.3	----	50.0	----	24.7	N (CAV)
11	20.77000	----	19.0	10.4	----	29.4	----	50.0	----	20.6	N (CAV)
12	22.26000	----	16.0	10.4	----	26.4	----	50.0	----	23.6	N (CAV)

15.5 Test data for Intermodulation Mode(WLAN 5 GHz + WLAN 2.4 GHz)

- Resolution bandwidth : 9 kHz
- Frequency range : 0.15 MHz ~ 30 MHz
- Tested Line : LIVE LINE

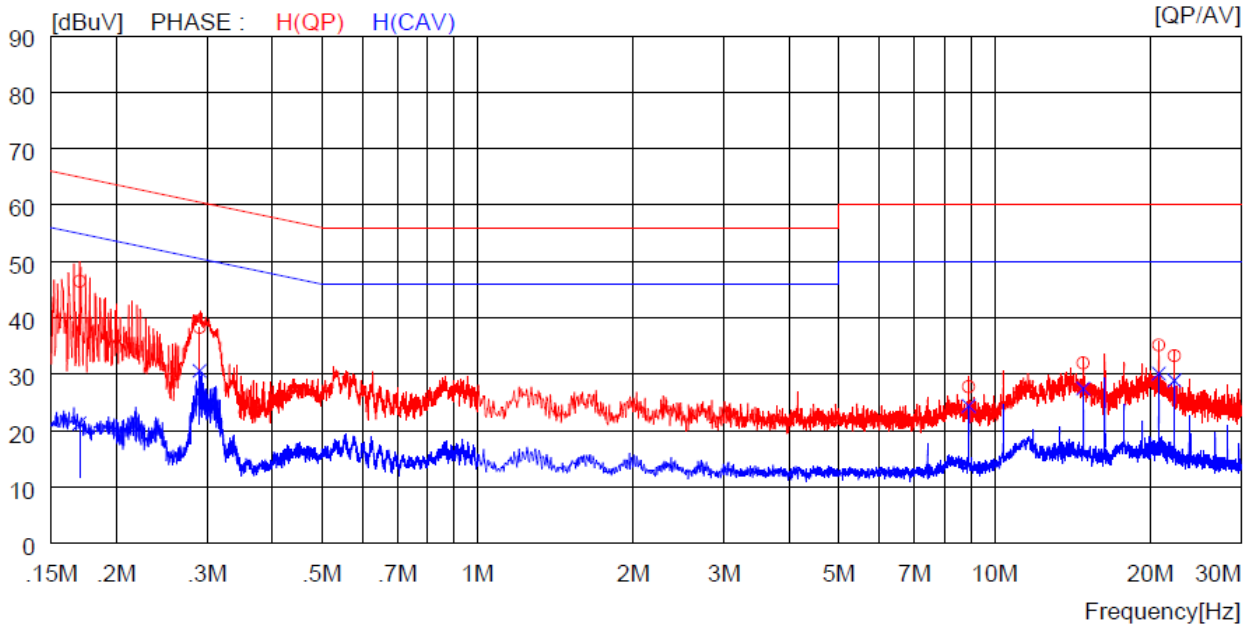

NO	FREQ [MHz]	READING		C.FACTOR [dB]	RESULT		LIMIT		MARGIN		PHASE
		QP [dBuV]	AV [dBuV]		QP [dBuV]	AV [dBuV]	QP [dBuV]	AV [dBuV]	QP [dBuV]	AV [dBuV]	
1	0.17000	36.5	----	10.0	46.5	----	65.0	----	18.5	----	H(QP)
2	0.29000	28.3	----	10.0	38.3	----	60.5	----	22.2	----	H(QP)
3	8.91500	17.6	----	10.2	27.8	----	60.0	----	32.2	----	H(QP)
4	14.85000	21.7	----	10.3	32.0	----	60.0	----	28.0	----	H(QP)
5	20.79000	24.8	----	10.4	35.2	----	60.0	----	24.8	----	H(QP)
6	22.27000	22.9	----	10.4	33.3	----	60.0	----	26.7	----	H(QP)
7	0.17000	----	11.3	10.0	----	21.3	----	55.0	----	33.7	H(CAV)
8	0.29000	----	20.6	10.0	----	30.6	----	50.5	----	19.9	H(CAV)
9	8.91500	----	14.2	10.2	----	24.4	----	50.0	----	25.6	H(CAV)
10	14.85000	----	17.2	10.3	----	27.5	----	50.0	----	22.5	H(CAV)
11	20.79000	----	19.7	10.4	----	30.1	----	50.0	----	19.9	H(CAV)
12	22.27000	----	18.5	10.4	----	28.9	----	50.0	----	21.1	H(CAV)

This Report is not correlated with the authentication of KOLAS

It should not be reproduced except in full, without the written approval of ONETECH Corp.

OTC-TRF-RF-001(0)

- Tested Line : NEUTRAL LINE

Remark: Margin (dB) = Limit – Level (Result)

The emission level in above table is included the transducer factor that means insertion loss (LISN), cable loss and attenuator.

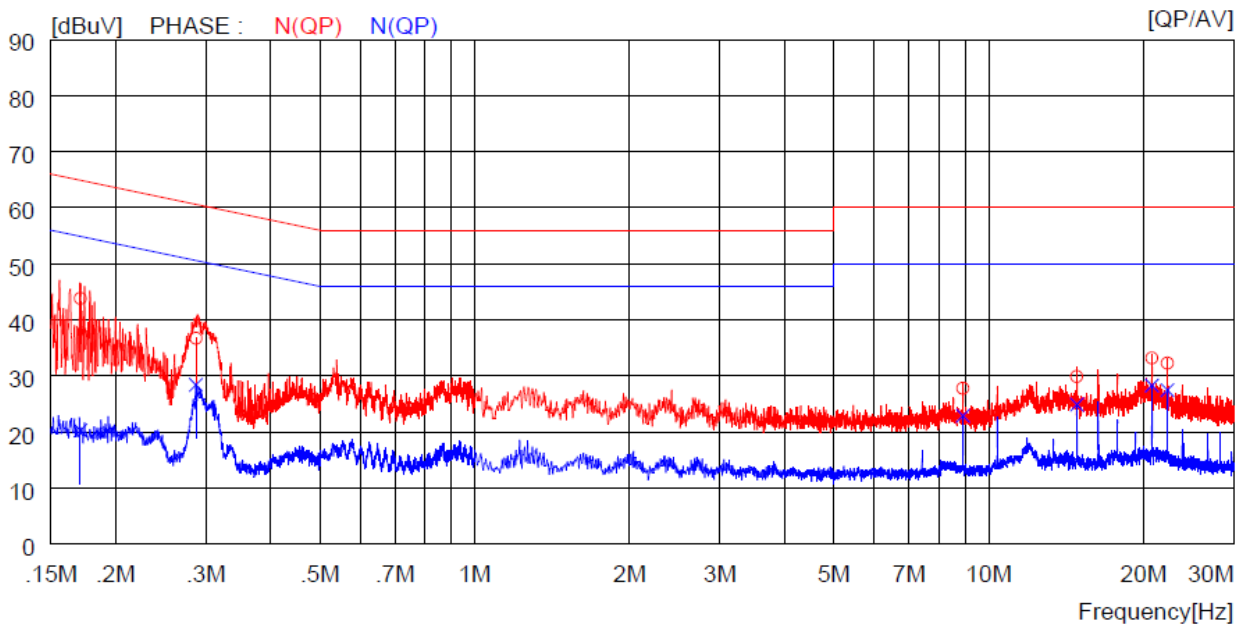

NO	FREQ [MHz]	READING		C. FACTOR [dB]	RESULT		LIMIT		MARGIN		PHASE
		QP [dBuV]	AV [dBuV]		QP [dBuV]	AV [dBuV]	QP [dBuV]	AV [dBuV]	QP [dBuV]	AV [dBuV]	
1	0.17100	33.8	----	10.0	43.8	----	64.9	----	21.1	----	N (QP)
2	0.28700	26.7	----	10.0	36.7	----	60.6	----	23.9	----	N (QP)
3	8.91000	17.6	----	10.2	27.8	----	60.0	----	32.2	----	N (QP)
4	14.85000	19.6	----	10.3	29.9	----	60.0	----	30.1	----	N (QP)
5	20.79000	22.8	----	10.4	33.2	----	60.0	----	26.8	----	N (QP)
6	22.27000	21.9	----	10.4	32.3	----	60.0	----	27.7	----	N (QP)
7	0.17100	----	10.3	10.0	----	20.3	----	54.9	----	34.6	N (CAV)
8	0.28700	----	18.4	10.0	----	28.4	----	50.6	----	22.2	N (CAV)
9	8.91000	----	12.7	10.2	----	22.9	----	50.0	----	27.1	N (CAV)
10	14.85000	----	14.6	10.3	----	24.9	----	50.0	----	25.1	N (CAV)
11	20.79000	----	17.9	10.4	----	28.3	----	50.0	----	21.7	N (CAV)
12	22.27000	----	17.1	10.4	----	27.5	----	50.0	----	22.5	N (CAV)

16. DYNAMIC FREQUENCY SELECTION (DFS)

16.1 Operating environment

Temperature : 24 °C
 Relative humidity : 45 % R.H.

16.2 Test set-ups

The FCC 06-96 and RSS-210 A9.3 describes a conducted test setup. A conducted test setup was used for this testing. Figure 1 shows the typical test setup. Each one channel selected between 5 250 MHz and 5 350 MHz, 5 470 MHz and 5 725 MHz is chosen for the testing.

Figure 1. Setup for Client with injection at the Master

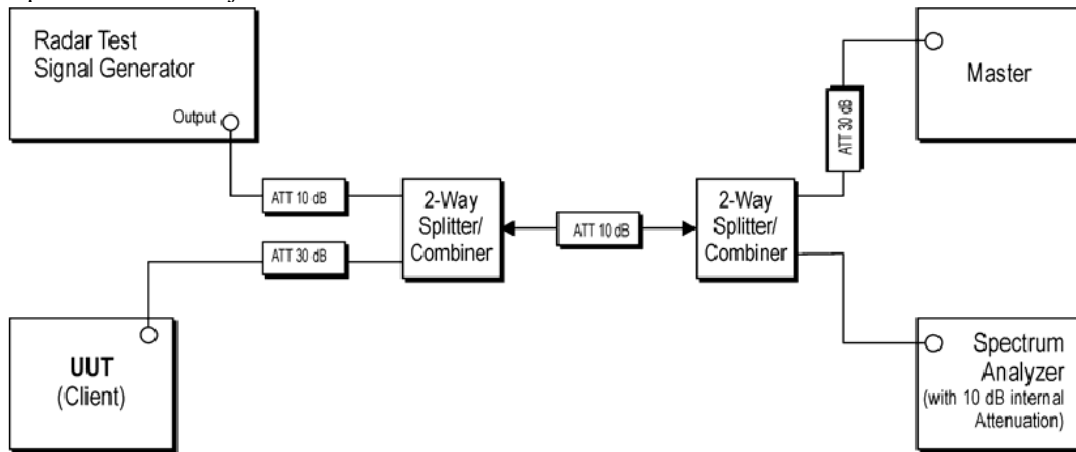

The operational behavior and individual DFS requirements that are associated with these modes are as follows:

<Master Devices>

- a) The Master Device will use DFS in order to detect Radar Waveforms with received signal strength above the DFS Detection Threshold in the 5 250 – 5 350 MHz and 5 470 – 5 725 MHz bands. DFS is not required in the 5 150 – 5 250 MHz or 5 725 – 5 825 MHz bands.
- b) Before initiating a network on a Channel, the Master Device will perform a Channel Availability Check for a specified time duration (Channel Availability Check Time) to ensure that there is no radar system operating on the Channel, using DFS described under subsection a) above.
- c) The Master Device initiates a U-NII network by transmitting control signals that will enable other U-NII devices to Associate with the Master Device.
- d) During normal operation, the Master Device will monitor the Channel (In-Service Monitoring) to ensure that there is no radar system operating on the Channel, using DFS described under a).
- e) If the Master Device has detected a Radar Waveform during In-Service Monitoring as described under d), the Operating Channel of the U-NII network is no longer an Available Channel. The Master Device will instruct all associated Client Device(s) to stop transmitting on this Channel within the Channel Move Time. The transmissions during the Channel Move Time will be limited to the Channel Closing Transmission Time.

f) Once the Master Device has detected a Radar Waveform it will not utilize the Channel for the duration of the Non-Occupancy Period. 3

g) If the Master Device delegates the In-Service Monitoring to a Client Device, then the combination will be tested to the requirements described under d) through f) above.

<Client Devices>

a) A Client Device will not transmit before having received appropriate control signals from a Master Device.

b) A Client Device will stop all its transmissions whenever instructed by a Master Device to which it is associated and will meet the Channel Move Time and Channel Closing Transmission Time requirements. The Client Device will not resume any transmissions until it has again received control signals from a Master Device.

c) If a Client Device is performing In-Service Monitoring and detects a Radar Waveform above the DFS Detection Threshold, it will inform the Master Device. This is equivalent to the Master Device detecting the Radar Waveform and d) through f) of section 5.1.1 apply.

d) Irrespective of Client Device or Master Device detection the Channel Move Time and Channel Closing Transmission Time requirements remain the same.

e) The client test frequency must be monitored to ensure no transmission of any type has occurred for 30 minutes. Note: If the client moves with the master, the device is considered compliant if nothing appears in the client non-occupancy period test. For devices that shut down (rather than moving channels), no beacons should appear.

<Channel Connection Information>

a) Master Devices : RF-AX88U

b) Client(=EUT) Devices : WTP3

c) Connect to test channel : See next page for measurement data.

16.3 DFS Test Signals

Table 5 – Short Pulse Radar Test Waveforms

Radar Type	Pulse Width (μsec)	PRI (μsec)	Number of Pulses	Minimum Percentage of Successful Detection	Minimum Number of Trials
0	1	1428	18	See Note 1	See Note 1
1	1	Test A: 15 unique PRI values randomly selected from the list of 23 PRI values in Table 5a	Roundup $\left\{ \begin{matrix} \left(\frac{1}{360} \right) \cdot \\ \left(\frac{19 \cdot 10^6}{\text{PRI}_{\mu\text{sec}}} \right) \end{matrix} \right\}$	60%	30
		Test B: 15 unique PRI values randomly selected within the range of 518-3066 μ sec, with a minimum increment of 1 μ sec, excluding PRI values selected in Test A			
2	1-5	150-230	23-29	60%	30
3	6-10	200-500	16-18	60%	30
4	11-20	200-500	12-16	60%	30
Aggregate (Radar Types 1-4)				80%	120

Table 6 – Long Pulse Radar Test Waveform

Radar Type	Pulse Width (μsec)	Chirp Width (MHz)	PRI (μsec)	Number of Pulses per Burst	Number of Bursts	Minimum Percentage of Successful Detection	Minimum Number of Trials
5	50-100	5-20	1000-2000	1-3	8-20	80%	30

16.4 Technical Requirement Specification

Table 1: Applicability of DFS Requirements Prior to Use of a Channel

Requirement	Operational Mode		
	Master	Client (without DFS)	Client (with DFS)
<i>Non-Occupancy Period</i>	Yes	Not required	Yes
<i>DFS Detection Threshold</i>	Yes	Not required	Yes
<i>Channel Availability Check Time</i>	Yes	Not required	Not required
<i>Uniform Spreading</i>	Yes	Not required	Not required
<i>U-NII Detection Bandwidth</i>	Yes	Not required	Yes

Table 2: Applicability of DFS requirements during normal operation

Requirement	Operational Mode		
	Master	Client (without DFS)	Client (with DFS)
<i>DFS Detection Threshold</i>	Yes	Not required	Yes
<i>Channel Closing Transmission Time</i>	Yes	Yes	Yes
<i>Channel Move Time</i>	Yes	Yes	Yes
<i>U-NII Detection Bandwidth</i>	Yes	Not required	Yes

16.5 Test Date

December 05, 2021 ~ March 08, 2022

16.6 Test data

Band	Frequency (MHz)	Channel move time(s)		Channel closing transmission time(ms)	
		Measured	Limit	Measured	Limit
UNII 2A	5 290.00	0.88	10.00	4.8	200 milliseconds + an aggregate of 60 milliseconds over remaining 10 second period.
UNII 2C	5 530.00	0.84		3.6	

Note. Channel closing transmission time: 0.4 x 12 = 4.8 ms, 0.4 x 9 = 3.6 ms

16.6.1 UNII 2A

16.6.1.1 Plot of Radar waveform type 0

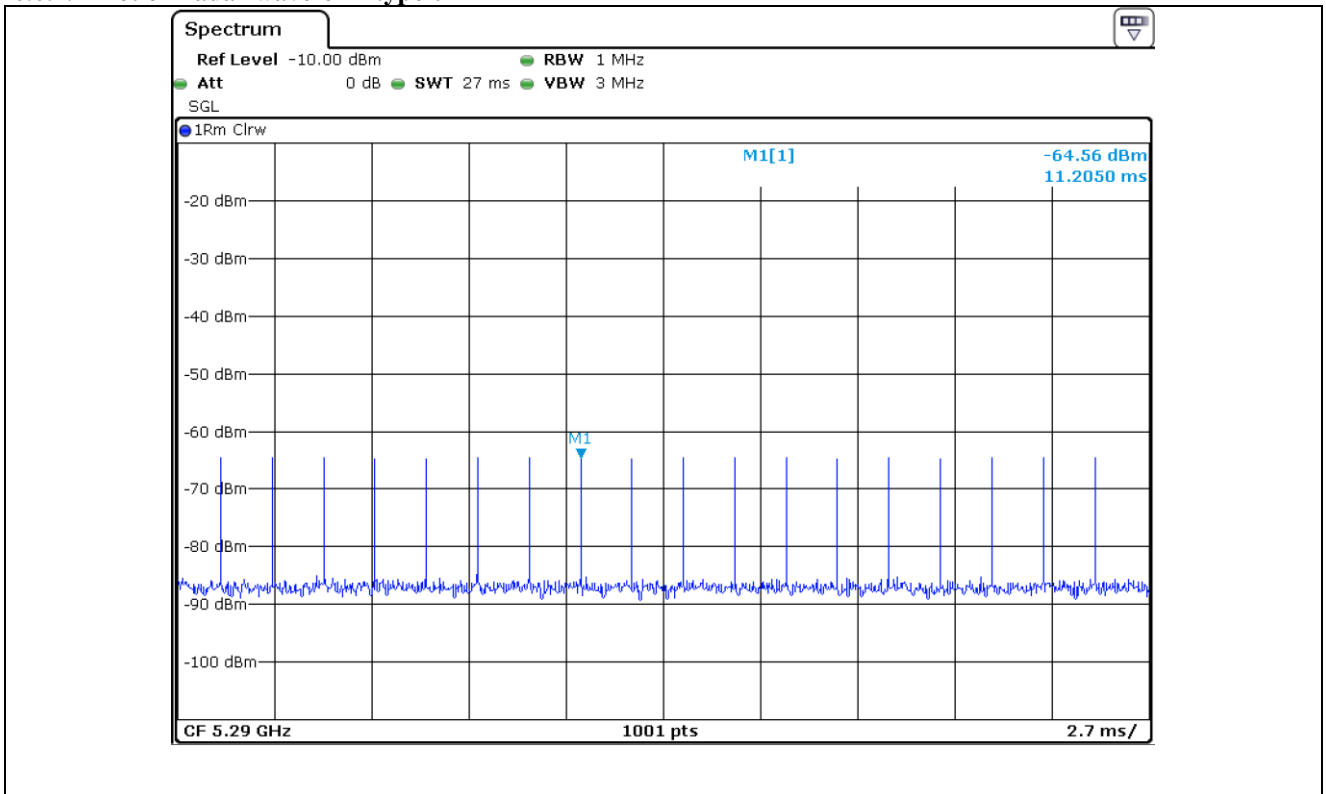

Note: The calibrated conducted DFS detection threshold level is set to -64.56 dBm (-62+1+9= -52.00 dBm)

16.6.1.2 No traffic signal(master signal)

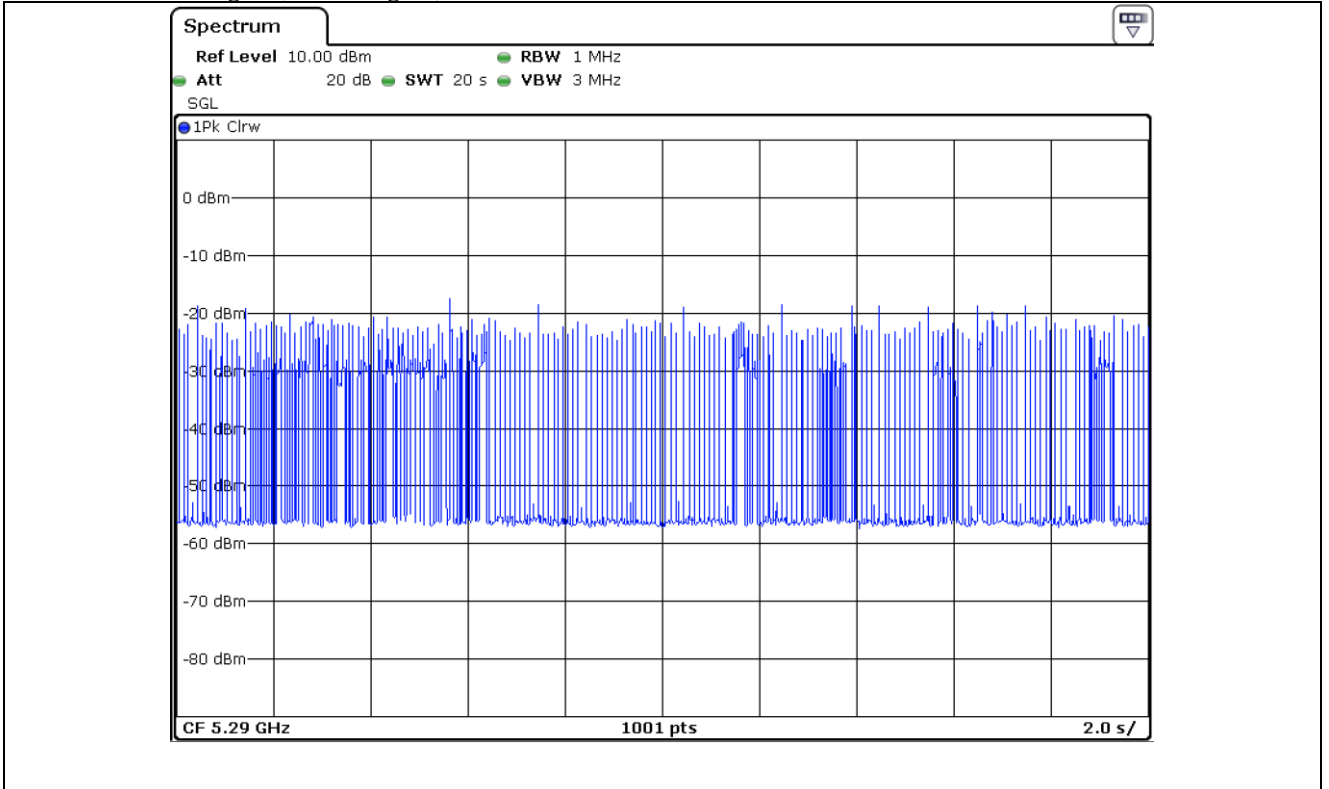

16.6.1.3 Client(EUT) Data Traffic Signal

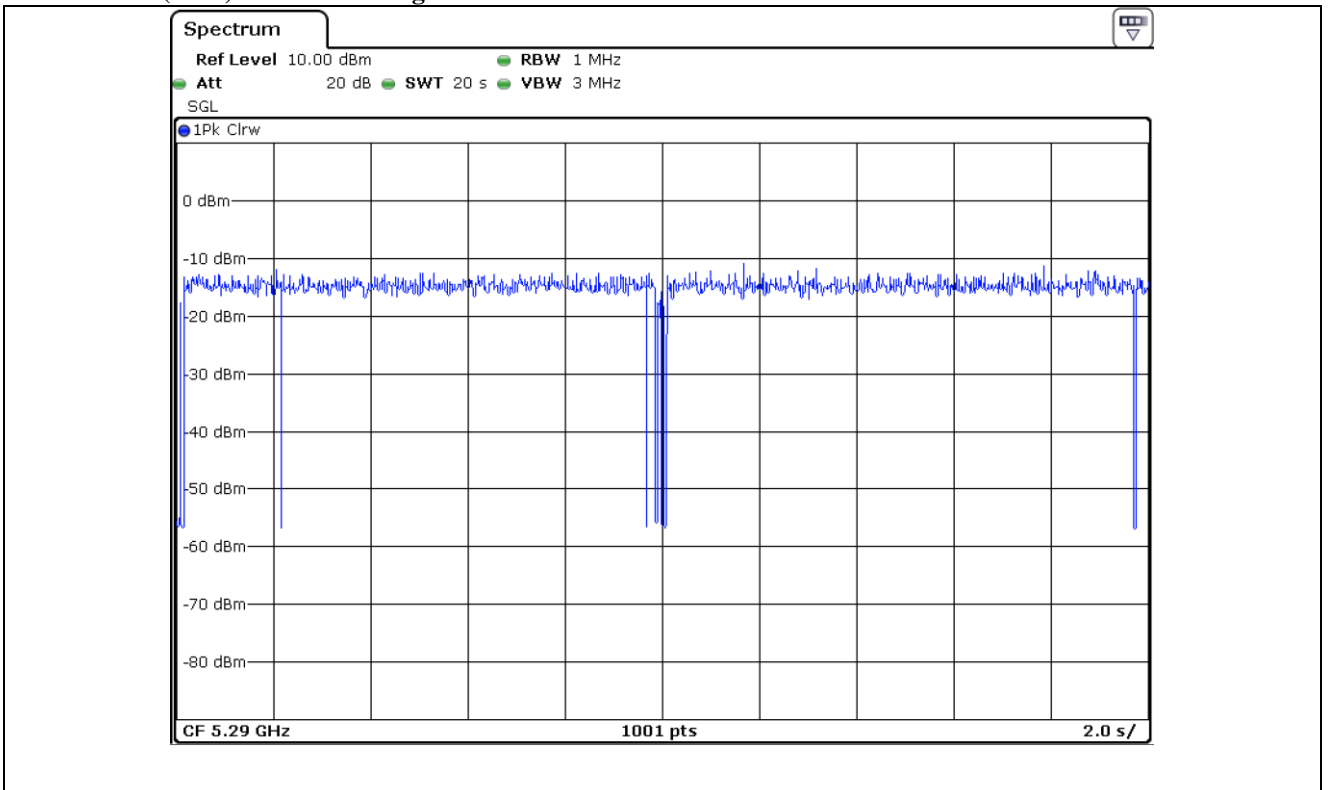

This Report is not correlated with the authentication of KOLAS

It should not be reproduced except in full, without the written approval of ONETECH Corp.

OTC-TRF-RF-001(0)

16.6.1.4 Channel move and Channel Closing transmission time

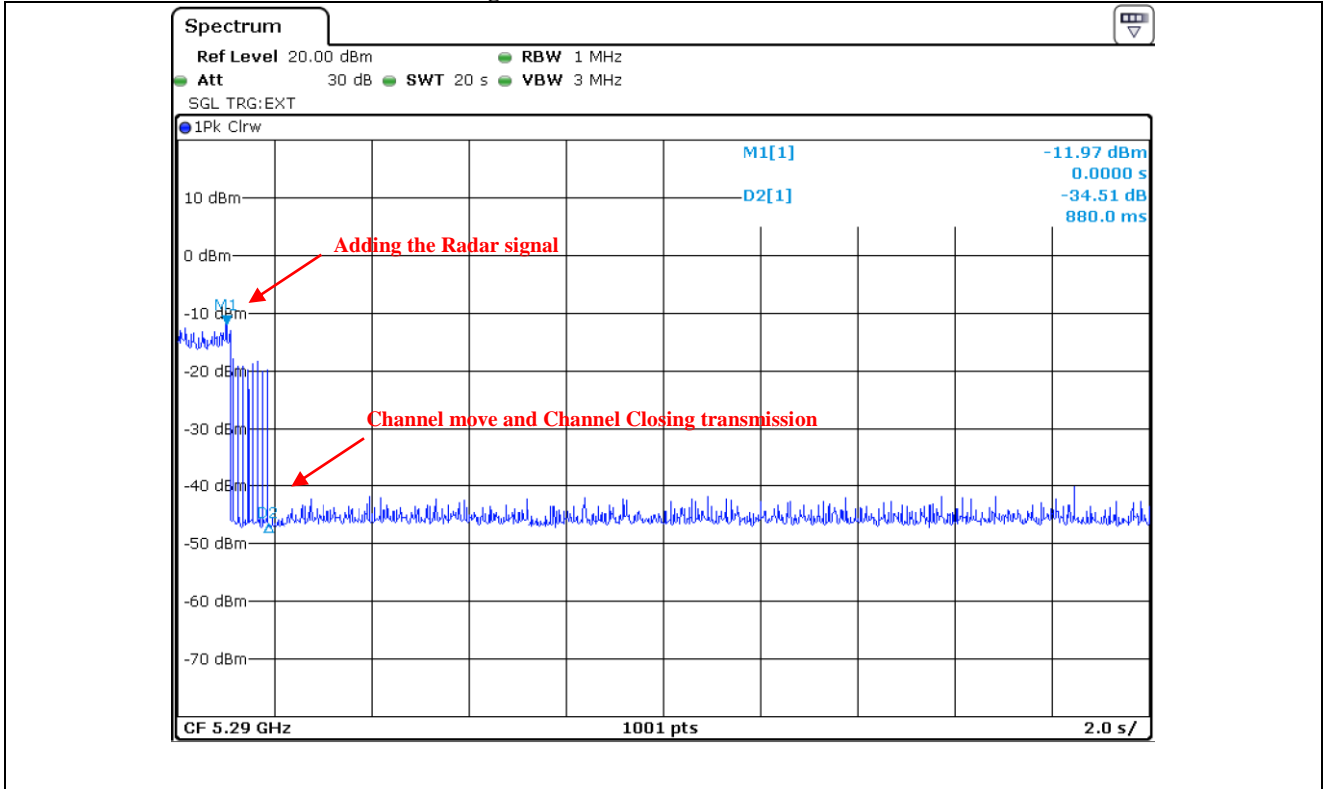

16.6.2 UNII 3

16.6.2.1 Plot of Radar waveform type 1

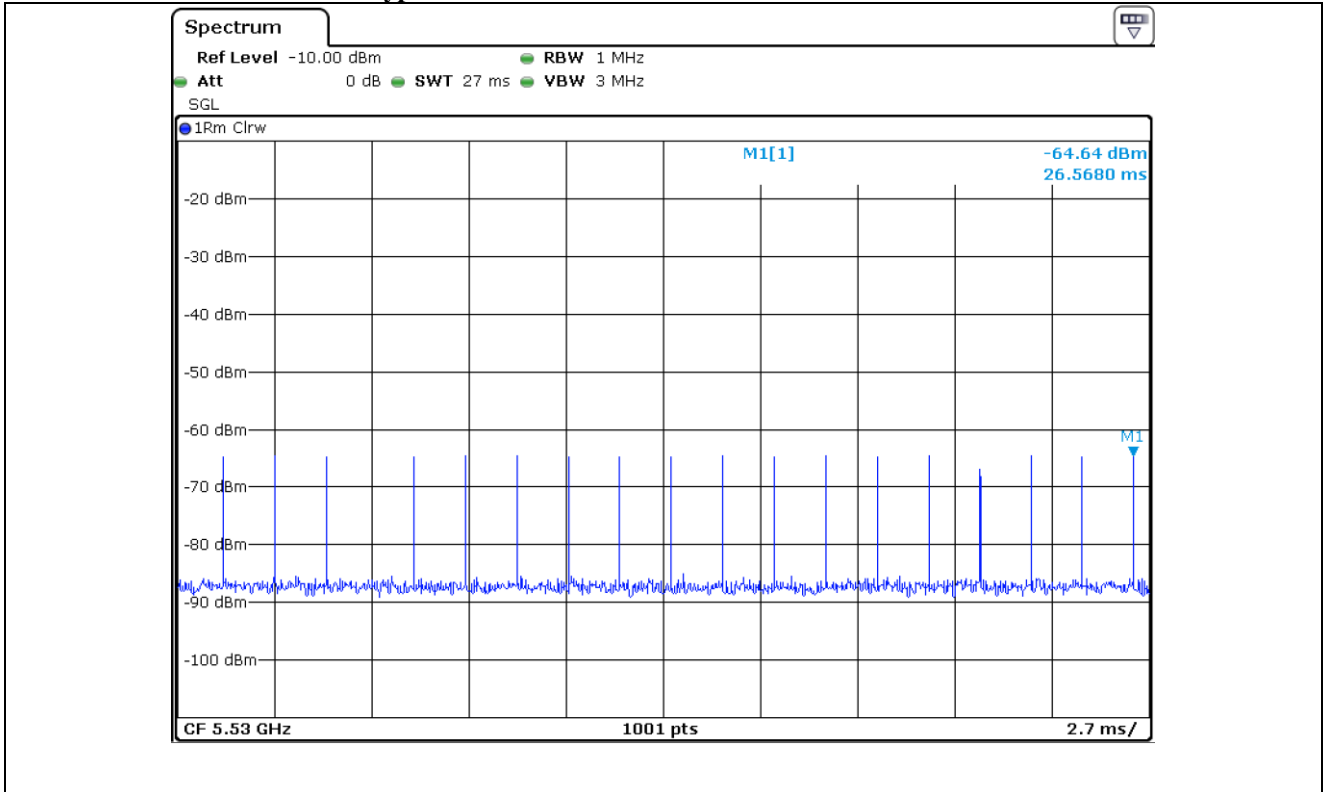

Note: The calibrated conducted DFS detection threshold level is set to -64.64 dBm ($-62+1+9 = -52.00$ dBm)

16.6.2.2 No traffic signal(master signal)

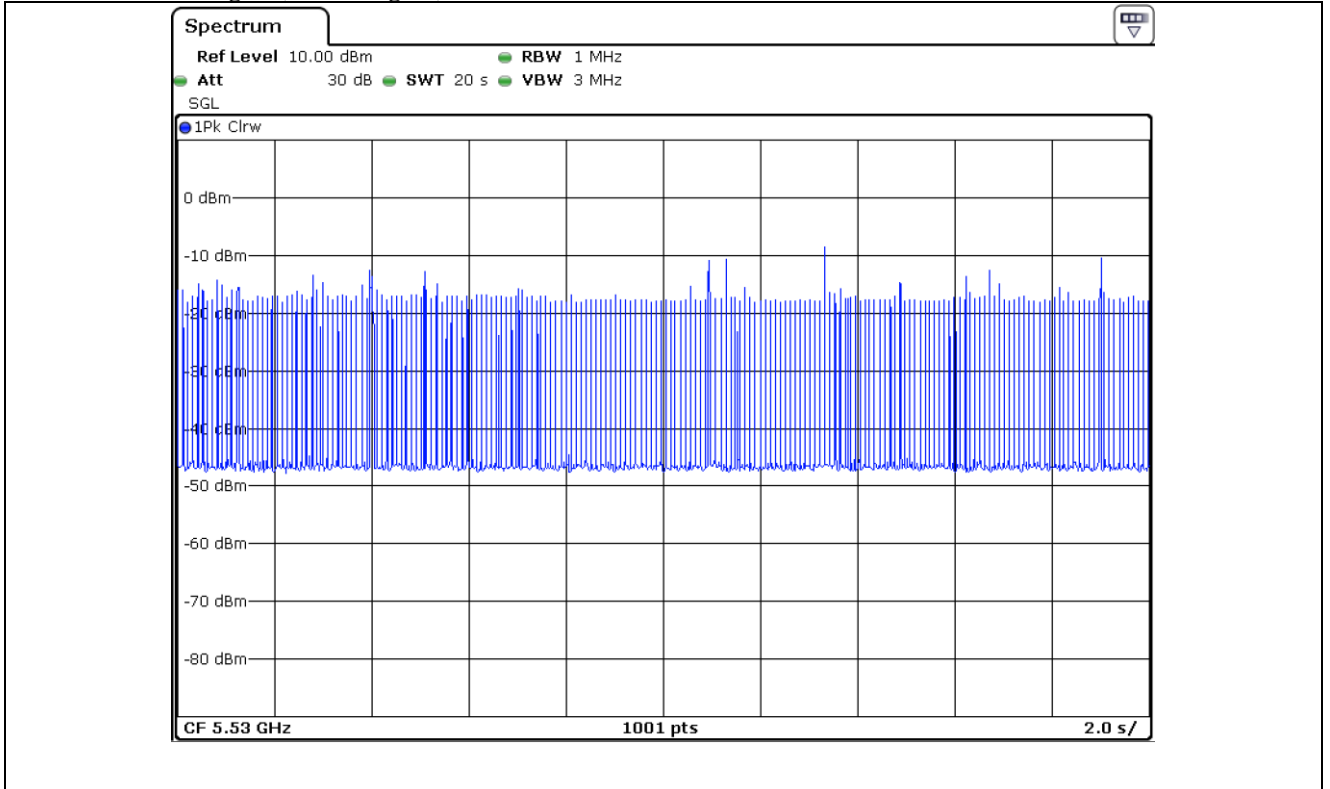

16.6.2.3 Client(EUT) Data Traffic Signal

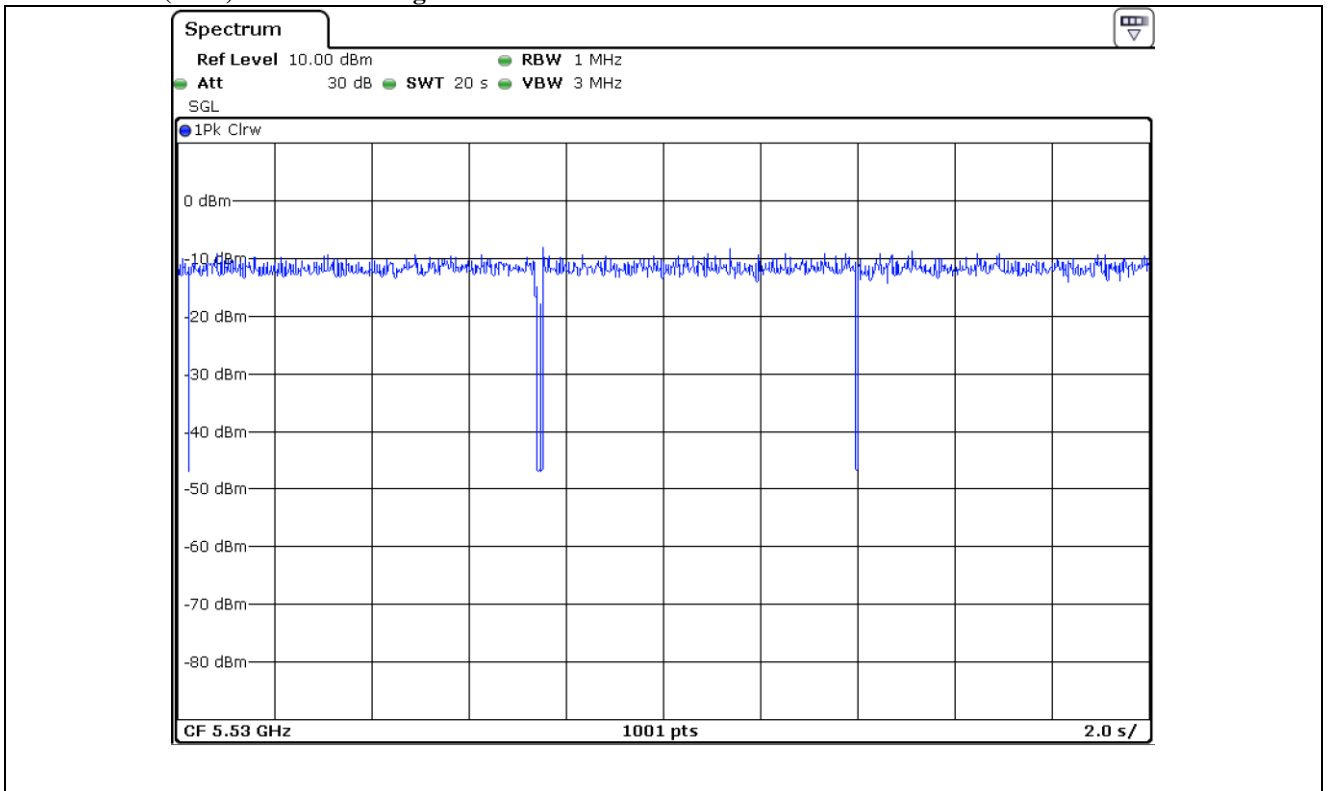

This Report is not correlated with the authentication of KOLAS

It should not be reproduced except in full, without the written approval of ONETECH Corp.

OTC-TRF-RF-001(0)

16.6.2.4 Channel move and Channel Closing transmission time

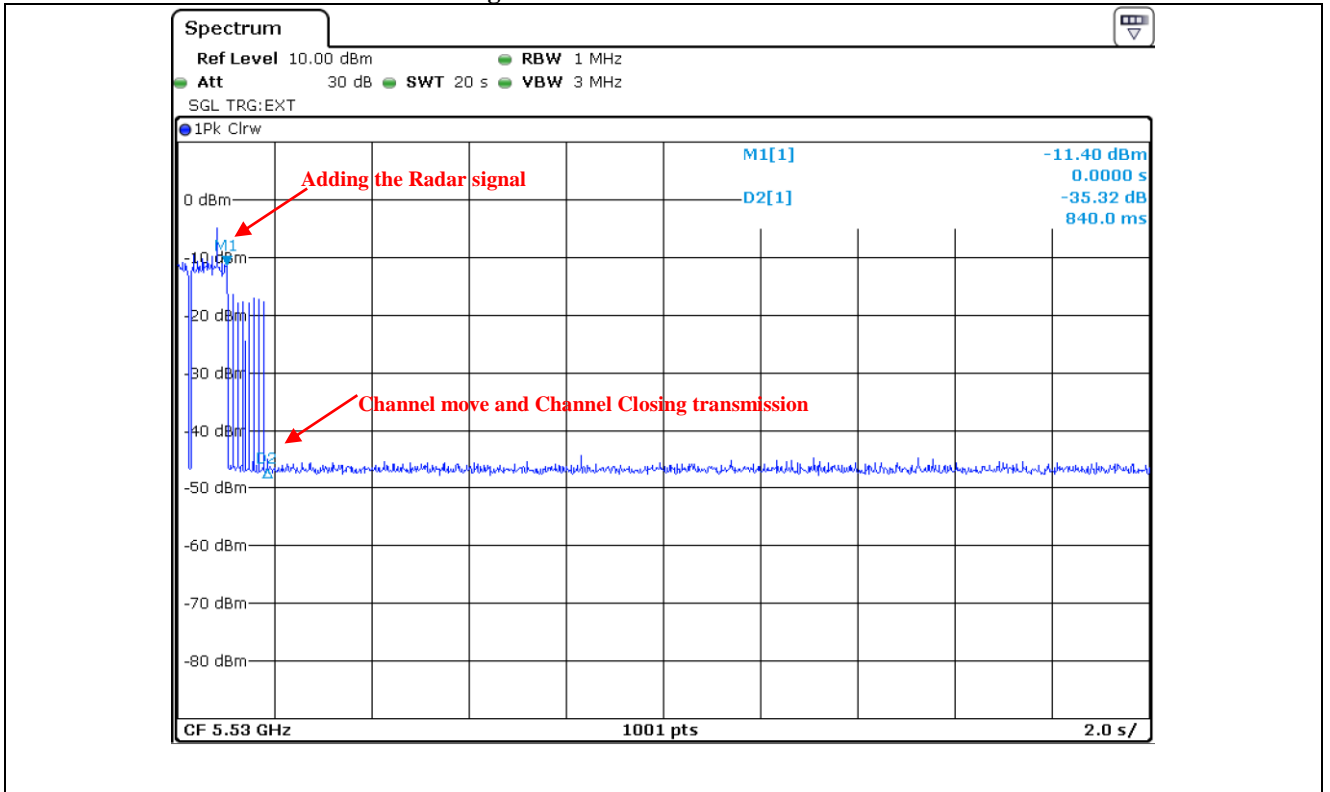

17. LIST OF TEST EQUIPMENT

Model Number	Manufacturer	Description	Serial Number	Last Cal.(Interval)
FSV40-N	Rohde & Schwarz	Signal Analyzer	102177	Apr. 16, 2021 (1Y)
ESW 44	Rohde & Schwarz	EMI Test Receiver	101851	Mar. 08, 2022 (1Y)
SSE-43CI-A	Samkun Tech	Humidity Chamber	60712	Jan. 18, 2022 (1Y)
ZUP36-6	NEMIC-LAMBDA	DC Power Supply	YJV-535Z14-0018	Apr. 16, 2021(1Y)
310N	Sonoma Instrument	Pre-Amplifier	392756	Oct. 14, 2021 (1Y)
SCU18	Rohde & Schwarz	Pre-Amplifier	102266	Jul. 14, 2021 (1Y)
PAM-118A	Com-Power	Pre-Amplifier	18040081	Oct. 12, 2021 (1Y)
PAM-840A	Com-Power	Pre-Amplifier	461339	Oct. 18, 2021 (1Y)
F-40-5000-RF	RLC Electronis	High Pass Filter	0425	Feb. 01, 2022(1Y)
HPF 3GHz	Rohde & Schwarz	High Pass Filter	N/A	Jan. 19, 2022(1Y)
DT3000-3t	Innco System	Turn Table	DT3000/093	N/A
MA-4000XPET	Innco System	Antenna Master	MA4000/509	N/A
FMZB 1513	Schwarzbeck	Loop Antenna	1513-235	Mar. 24, 2022 (2Y)
HLP-2008	TDK	Hybrid Antenna	131314	Feb. 25, 2022 (2Y)
AH-118	Com-Power	Horn Antenna	10050061	Oct. 15, 2021 (1Y)
BBHA9170	Schwarzbeck	Horn Antenna	BBHA9170178	Jan. 06, 2022(1Y)
ESCI	Rohde & Schwarz	EMI TEST RECEIVER	101012	Oct. 20, 2021 (1Y)
NSLK8126	Schwarzbeck	AMN	8126-404	Mar. 14, 2022 (1Y)
ESH3-Z2	Rohde & Schwarz	PULSE LIMITER	100655	Mar. 14, 2022 (1Y)
D-05180-2	RLC Electronis Inc.	Combiner	0813	N/A
11636B	Hewlett Packard	Combiner	12268	N/A
SMBV100A	R/S	Signal Generator	260423	Jan 17, 2022 (1Y)
RF-AX88U	ASUS	Dual Band Gigabit Router	NA	N/A

All test equipment used is calibrated on a regular basis.