

Contents

Introduction	1
Getting started	2
Audio system	3
Hands-Free Phone	4
Information	5
Navigation (if equipped)	6
Voice recognition	7
Troubleshooting guide	8
Index	9

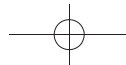

(2,1)

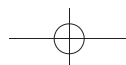
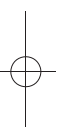
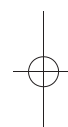

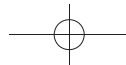

(3,1)

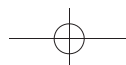
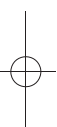
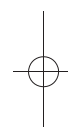

FOREWORD

AV1NJA1-801B9B40-26BD-49A7-A3FA-A8D4A5112094

Thank you for purchasing a NISSAN vehicle.

This user's manual is for NissanConnect System offered in your NISSAN vehicle.

Operation instructions for the following systems are included in this manual.

- Audio
- Hands-free phone
- Apple CarPlay
- Android Auto
- Navigation
- Voice recognition
- Information and settings viewable on NissanConnect

Please read this manual carefully to ensure safe operation of NissanConnect System.

- Because of possible specification changes and optional equipment, some sections of this manual may not apply to your vehicle.
- All information, specifications and illustrations in this manual are those in effect at the time of printing. NISSAN reserves the right to change specifications or design at any time without notice.

- Do not remove this manual from the vehicle when selling this vehicle. The next user of the system may need the manual.

© 2020 NISSAN MOTOR CO., LTD.

1 Introduction

How to use this manual	1-2
For safe operation	1-2
Reference symbols	1-2
Screen illustrations	1-2
Safety information	1-3
Regulatory information	1-3
Radio approval number and information	1-3
Trademarks	1-4
Licenses	1-4
Software Licenses	1-4

HOW TO USE THIS MANUAL

AV1NJA1-D8FFB8FA-A072-42AA-8D6D-9FEA0AD9B6F9

This manual uses special words, symbols, icons and illustrations organized by function.

Please refer to the following items and familiarize yourself with them.

FOR SAFE OPERATION

AV1NJA1-AF356C63-BABE-4B54-878D-6D8BA7D7E683



WARNING:

This is used to indicate the presence of a hazard that could cause death or serious personal injury. To avoid or reduce the risk, the procedures must be followed precisely.



CAUTION:

This is used to indicate the presence of a hazard that could cause minor or moderate personal injury or damage to your vehicle. To avoid or reduce the risk, the procedures must be followed carefully.



NOTE:

Indicates items that help you understand and maximize the performance of your vehicle. If ignored, they may lead to a malfunction or poor performance.

REFERENCE SYMBOLS

AV1NJA1-A9CE57CF-4F6A-454A-9EF8-91C4E396725F



INFO:

This indicates information that is necessary for efficient use of your vehicle or accessories.



Reference page:

This indicates the title and page that you should refer to.

< >:

This indicates a button on the control panel or the steering wheel.

[]:

This indicates a key/item displayed on the screen.

SCREEN ILLUSTRATIONS

AV1NJA1-5F699818-FF71-447B-881E-832E1898366B

- The illustrations in this manual are representatives of various models and may not be identical with the design and specifications of your vehicle.
- Icons and menu items displayed on the screen may be abbreviated or omitted from the screen illustrations when appropriate. The omitted icons and menu items are described as dotted lines as illustrated.

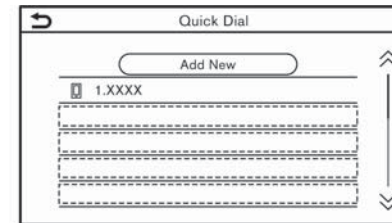

PBH0162X

1-2 Introduction

Condition:

[Edit: 2020/ 5/ 28 Model: AV1NJ-A]

SAFETY INFORMATION

AV1NJA1-E215E2CD-5877-46AC-B4EF-5D0B6683FCA9

This system is primarily designed to help you support pleasant driving as outlined in this manual. However, you, the driver, must use the system safely and properly. Information and the availability of services may not always be up to date. The system is not a substitute for safe, proper and legal driving.

Before using the system, please read the following safety information. Always use the system as outlined in this manual.

WARNING:

- **To operate the system, first park the vehicle in a safe location and set the parking brake. Operating the system while driving can distract the driver and may result in a serious accident.**
- **Exercise extreme caution at all times so full attention may be given to vehicle operation. If the system does not respond immediately, please be patient and keep your eyes on the road. Inattentive driving may lead to a crash resulting in serious injuries or death.**
- **Do not rely on route guidance (if equipped) alone. Always be sure that all driving maneuvers are legal and safe in order to avoid accidents.**
- **Do not disassemble or modify this system. If you do, it may result in accidents, fire or electrical shock.**

- **If you notice any foreign objects in the system hardware, spill liquid on the system or notice smoke or a smell coming from it, stop using the system immediately and it is recommended you contact a NISSAN dealer. Ignoring such conditions may lead to accidents, fire or electrical shock.**

CAUTION:

- **Some jurisdictions may have laws limiting the use of video screens while driving. Use this system only where it is legal to do so.**
- **Extreme temperature conditions [below -20°C (-4°F) and above 70°C (158°F)] could affect the performance of the system.**
- **The display screen may break if it is hit with a hard or sharp object. If the display screen breaks, do not touch it. Doing so could result in an injury.**

NOTE:

Do not keep the system running with the engine stopped. Doing so may discharge the vehicle battery. When you use the system, always keep the engine running.

REGULATORY INFORMATION

AV1NJA1-E1B76219-B24A-4588-A087-0985C8AA0D4C

RADIO APPROVAL NUMBER AND INFORMATION

AV1NJA1-43B104F9-DF13-4079-A70D-A7FA2CF10CD3

Hereby, Robert Bosch GmbH declares that the radio equipment type AIVIP33A0 is in compliance with Directive 2014/53/EU.

The full text of the EU declaration of conformity is available at the following internet address:

<https://eu-doc.bosch.com>



PBA0034X

Frequency Band

2400 MHz - 2480 MHz

Radiated Power [EIRP]

Bluetooth < 10 mW

WLAN < 100 mW

Hints/Restrictions

Internal Antenna

Internal antenna not accessible by user. Any change of the user will violate the legal approval of this product.

TRADEMARKS

AV1NJA1-9FC03AD0-EBF8-481D-A9E5-F229D1F2B583



Siri

Siri is a trademark of Apple Inc., registered in the U.S. and other countries.

PBA0032X

Google/Android/Google Play/Android Auto

Google, Android, Google Play, Android Auto, and other marks are trademarks of Google LLC.

5GD0030X



Apple, iPhone, iPod, and iPod touch are trademarks of Apple Inc., registered in the U.S. and other countries. Apple CarPlay is a trademark of Apple Inc. Use of the Apple CarPlay logo means that a vehicle user interface meets Apple performance standards. Apple is not responsible for the operation of this vehicle or its compliance with safety and regulatory standards. Please note that the use of this product with iPhone or iPod may affect wireless performance.



5GA0023X

Bluetooth® is a trademark owned by Bluetooth SIG, Inc. and licensed to Robert Bosch GmbH and Clarion Co., Ltd.

App Store

Apple and the Apple logo are trademarks of Apple Inc., registered in the U.S. and other countries. App Store is a service mark of Apple Inc.

1-4 Introduction

Condition:

LICENSES

AV1NJA1-5FE782B1-F1F2-4C43-B7B0-EE88A41A6D05

SOFTWARE LICENSES

AV1NJA1-E5E8A8CA-F06A-4CB9-A570-37F39CE42842

- Open Source Software Licenses
<http://oss.bosch-cm.com/nissan.html>
- This product is protected by certain intellectual property rights of Microsoft. Use or distribution of such technology outside of this product is prohibited without a license from Microsoft.

2 Getting started

Control buttons and touch screen display	2-2
Buttons on control panel	2-2
Touch screen display	2-3
Switches on steering wheel	2-4
USB (Universal Serial Bus) connection ports	2-5
Starting system	2-6
Start-up screen	2-6
Basic operation	2-6
Selecting menu from Launch Bar	2-6
How to view and operate HOME MENU screen	2-7
Swipe-down notifications	2-7
Functions disabled while driving (if equipped)	2-8
System settings	2-9
Settings menu	2-9
Connections settings	2-11

CONTROL BUTTONS AND TOUCH SCREEN DISPLAY

AV1NJA1-1D7E0D66-C372-4533-A154-A968B3FBAE87

BUTTONS ON CONTROL PANEL

AV1NJA1-434FB768-F8C5-41B6-9826-25EC1B0D3971

The control panel buttons are located at the center of the instrument panel. Available functions, designs, locations, etc. may differ depending on the specifications, control panel types and software versions.

Button	Function
<MENU>	Push to display the HOME MENU screen. ☞ "How to view and operate HOME MENU screen" (page 2-7)
<☀/☾>	Push to switch between the day screen (bright) and the night screen (dark) and to adjust the level of screen brightness. Push and hold the button to turn off the display. Push the button again to turn on the display.
<↶ BACK>/<↷>	Depending on the screen, pushing the button will display the previous screen.
<AUDIO>	Push to display the audio screen. When this button is pushed while the audio screen is displayed, a screen to select an audio source will be displayed. ☞ "Selecting audio source" (page 3-7)
<VOL/ ⏻ >/<VOL/PUSH ⏻ >	Push to turn the power of the audio system on/off. Turn to adjust the volume.
<⏮>/<⏭>	Use the buttons for audio operations. ☞ "Audio operations" (page 3-7)
<⏸/⏹ /PUSH SOUND>/<TUNE SCROLL/PUSH SOUND>	Depending on the conditions when a menu screen is displayed, turning the dial can select items on the screen. Push to confirm the selected item or setting. Depending on the models, the button can also be used for audio operations. ☞ "Audio operations" (page 3-7) Models with navigation system: Turning the dial can adjust the map scale on the navigation screen.
<MAP>	Push to display the current location map. When a split map screen is displayed, push this button to display the full map screen. When available, voice guidances can be repeated by pushing and holding this button. ☞ "6. Navigation"
< 📞 >	Push to display the phone screen. ☞ "4. Hands-Free Phone"

2-2 Getting started

Condition:

[Edit: 2020/ 5/ 28 Model: AV1NJ-A]

INFO:

For **<CAMERA>** operation, refer to the vehicle Owner's Manual.

TOUCH SCREEN DISPLAY

AV1NJAJ1-96D1984E8-5CC8-4FDD-A060-67EBCB2CB12A

The touch screen display is located at the center of the instrument panel. Various information and operation menus are displayed on the touch screen display. Touch keys and icons on the screen for operation.

Liquid crystal display

AV1NJAJ1-37ZA0E1B-44A4-402D-B2E2-BBC1C2EE95EA

The touch screen display on this unit is a liquid crystal display and should be handled with care.

WARNING:

Never disassemble the display. Some parts utilize extremely high voltage. Touching them may result in serious personal injury.

Characteristics of liquid crystal display:

- If the temperature inside the vehicle is especially low, the display will stay relatively dim or the movement of the images may be slow. These conditions are normal. The display will function normally when the interior of the vehicle has warmed up.
- Some pixels in the display are darker or brighter than others. This condition is an inherent characteristic of liquid

crystal displays, and it is not a malfunction.

- A remnant of the previous display image may remain on the screen. This screen burn is inherent in liquid crystal displays, and it is not a malfunction.
- The screen may become distorted by strong magnetic fields.
- Depending on the condition, brightness may be adjusted automatically to prevent the display from screen burning.

Maintenance of display:

To clean the display screen, use a dry, soft cloth. If additional cleaning is necessary, use a small amount of neutral detergent with a soft cloth. Never spray the screen with water or detergent. Dampen the cloth first, then wipe the screen.

CAUTION:

























- **Clean the display with the ignition switch in the OFF position. If the display is cleaned while the ignition switch is placed in the ON position, unintentional operation may occur.**
- **To clean the display, never use a rough cloth, alcohol, benzene, thinner or any kind of solvent or paper towel with a chemical cleaning agent. They will scratch or deteriorate the panel.**

- **Do not splash any liquid, such as water or car fragrance, on the display. Contact with liquid will cause the system to malfunction.**

SWITCHES ON STEERING WHEEL

AV1NJAI-9CD7B933-51F1-458A-A0B4-1F33CE4FCDE5

Switches on the steering wheel can be used to perform operations such as taking phone calls, changing volume, and conducting voice operations. Available functions and designs may differ depending on the specifications, switch types and software versions.

Switch	Function
<  >	Push to answer a received call, to end an active call or to read a received text message. Push and hold to reject an incoming call or to ignore a received text message. When no phone call is received or when there is no active call, pushing this switch will display the phone screen. Pushing and holding this switch will start a voice recognition session for making a phone call.  "4. Hands-Free Phone"
<  > (TALK)	Push to use the Voice Recognition System. Push and hold to end the voice recognition session.  "Giving voice commands" (page 7-2) If your iPhone is connected to the in-vehicle system via Bluetooth®, Siri Eyes Free (if equipped) can be activated by pushing and holding this switch without having to activate Apple CarPlay.  "Siri Eyes Free" (page 5-10) When Apple CarPlay (if equipped) or Android Auto (if equipped) is active, pushing and holding this switch will start a Siri or Google Assistant voice control session.  "Siri operation" (page 5-5)  "Google Assistant™ operation" (page 5-8)
<  >	Push to go back to the previous screen while operating the Voice Recognition System. Push and hold to end a voice recognition session.
<  >	Push the + or - side of the switch to adjust the volume.
<  >/<  >/<  >/<  >	Push <  >/<  > to select the voice command while operating the Voice Recognition menu screen. Push <  >/<  > to read the previous or next message while displaying received message screen.  "Hands-free text messaging assistant" (page 4-6) Push <  >/<  > to switch to the previous or next page while operating the Voice Recognition menu screen.  "Voice recognition" (page 7-2)
<OK>	Push to confirm the selected item.
<  >/<  >	This switch can be used for audio operations.  "Audio operations" (page 3-7)

2-4 Getting started

Condition:

[Edit: 2020/ 5/ 28 Model: AV1NJ-A]

INFO:

Steering wheel switches are mainly for the vehicle information display control and may not be able to operate the touch screen display depending on the conditions. For details of the vehicle information display, refer to the vehicle Owner's Manual.

USB (Universal Serial Bus) CONNECTION PORTS

AV1NJ-A1-E9AC7D61-BCC2-48F6-87C6-43CA8EAE0D5D

WARNING:

Do not connect, disconnect or operate the USB device while driving. Doing so can be a distraction. If distracted you could lose control of your vehicle and cause an accident or serious injury.

CAUTION:

- **Do not force the USB device into the USB connection port. Inserting the USB device tilted or up-side-down into the port may damage the port. Make sure that the USB device is connected correctly into the USB connection port.**
- **Do not grab the USB connection port cover (if equipped) when pulling the USB device out of the port. This could damage the port and the cover.**

- **Do not leave the USB cable in a place where it can be pulled unintentionally. Pulling the cable may damage the port.**

The vehicle is equipped with USB connection ports. When connected, the in-vehicle audio system can play audio contents from the compatible device.

The USB connection ports are located on the lower part of the instrument panel.

INFO:

- Refer to your USB device manufacturer's owner information regarding the proper use and care of the device.
- Cables made by Apple Inc. should be used to connect electronic devices marketed by Apple Inc.

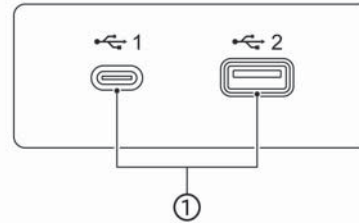

PBH0171X

① USB connection ports:

Connect a compatible device to play media such as an iPod or a USB memory device.

Connect an iPhone or an Android phone to use Apple CarPlay (if equipped) or Android Auto (if equipped).

STARTING SYSTEM

AV1NJJA1-F7A7E93C-1CA4-4F06-A2C8-03063B07BE78

The system starts when the ignition switch is placed in the ACC or ON position.

START-UP SCREEN

AV1NJJA1-1CCFB241-BAB4-4C9C-8412-EF467F738826

The start-up screen is displayed when the ignition switch is placed in the ACC or ON position.

NOTE:

Do not keep the system running with the engine stopped. Doing so may discharge the vehicle battery. When you use the system, always keep the engine running.

BASIC OPERATION

AV1NJJA1-A9E6F207-4B16-4522-84EB-16B8F63D435

The system can be operated with the touch panel as well as the switches on the control panel and the steering wheel.

This manual mainly describes the touch panel operation.

SELECTING MENU FROM LAUNCH BAR

AV1NJJA1-F5B8AC5D-C122-4534-9FC7-2A14ED1A68AA

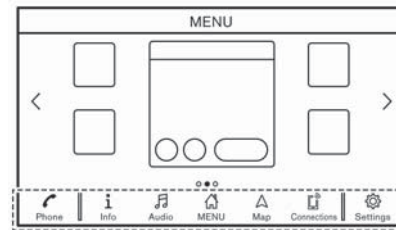

①
Example

PBA0106X

Various system functions can be accessed by touching the items on the Launch Bar ① which is displayed on most of the main menu screens. (The Launch Bar does not appear on some screens such as scrolled map screen, keyboard screen, etc.)

Touch the item on the Launch Bar to display the corresponding screens.

The items on the Launch Bar differ according to which button on the control panel is pushed.

The following menus are available on the Launch Bar. (Displayed items may vary

depending on models, specifications and software versions.)

When pushing <MENU>:

Shortcuts for various functions are displayed.

- [Phone]*
☞ "Phone" (page 4-4)
- [Info]
☞ "Information menu" (page 5-2)
- [Audio]
☞ "Audio operations" (page 3-7)
- [MENU]
Touching [MENU] on the Launch Bar will display the center page of the HOME MENU screen.
- [Map]
☞ "Displaying navigation screen" (page 6-2)
- [Connections]
☞ "Connections settings" (page 2-11)
- [Settings]
☞ "System settings" (page 2-9)

*: [Phone] will be replaced by [🎧] when Apple CarPlay (if equipped) is active, and it will be replaced by [📶] when Android Auto (if equipped) is active.

When pushing <AUDIO>:

Shortcuts mainly for the audio functions are displayed.

- ☞ "Selecting audio source" (page 3-7)

When pushing <MAP> (if equipped):

2-6 Getting started

Condition:

[Edit: 2020/ 5/ 28 Model: AV1NJ-A]

Shortcuts mainly for the navigation functions are displayed.

☞ “Launch Bar” (page 6-2)

HOW TO VIEW AND OPERATE HOME MENU SCREEN

Push <MENU> to display the HOME MENU screen.

The HOME MENU consists of 3 pages which can display preferred shortcuts and widgets.

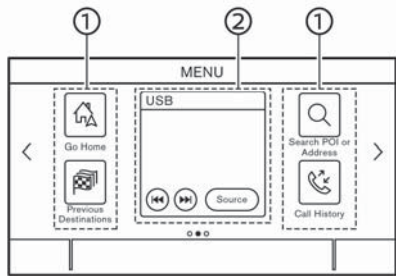

Example

- ① **Shortcut icons:**
Icons for frequently used menu items can be placed on the HOME MENU screens as shortcuts.
- ② **Widget:**
Useful information from primary menu functions can be displayed as widgets. Depending on the contents of the widget, keys may be available for operation of the function.

Customizing HOME MENU screen

The HOME MENU screen can be personalized by selecting which shortcuts and widgets are to be displayed and where to place them on the screen.

Selecting shortcut or widget:

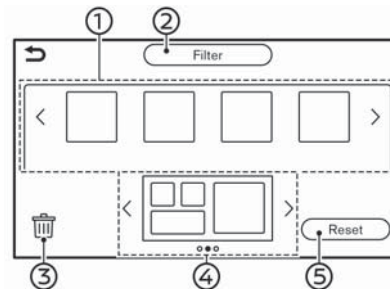

Example

1. Touch [Settings] on the Launch Bar.
2. Touch [Customise Home Menu].
3. Drag the shortcut or widget icon ① to each page layout ④.

If a different shortcut or a widget is already located on the page layout ④, a message will be displayed. Touch [Yes] to replace the shortcut/widget. The page layout ④ can be changed by dragging the icons.

The categories of shortcuts or widgets can be narrowed down by touching [Filter] ② and selecting preferred categories.

Dragging an icon into the ③ can delete the current shortcut or widget to create a blank spot.

INFO:

- Touch ③, and then a message will appear. While the message is displayed, touching any icon on the page layout ④ and then touching [Delete] can delete the selected icon. To delete all icons, touch [Select All] and then touch [Delete].
- Touch [Reset] ⑤ to reset the HOME MENU screen to the default setting.

SWIPE-DOWN NOTIFICATIONS

By swiping down on the touch screen display, a list of notifications (such as missed calls, text message reception) can be displayed.

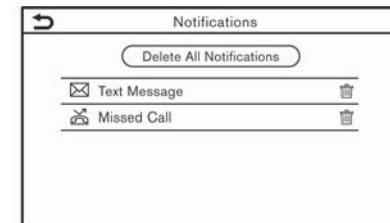

INFO:

- Touch an item on the list to see the details of the item.

Getting started 2-7

- Touch  to delete an item.
- Touch [Delete All Notifications] to delete all items.

FUNCTIONS DISABLED WHILE DRIVING (if equipped)

AV1NJAT-96075C81-A5BC-42F2-A4C5-DF0BB2863C3F

To ensure safe driving, some functions cannot be operated while driving.

The on-screen functions that are not available while driving will be “grayed-out” or muted. In some cases, certain text will not be displayed on the screen.

To use these functions, first park the vehicle in a safe location and then operate the system.

2-8 Getting started

Condition:

[Edit: 2020/ 5/ 28 Model: AV1NJ-A]

SYSTEM SETTINGS

AV1NJAI-811B4F8E-8E41-435D-BA44-76204FB0B276

The system settings can be changed for personal convenience.





SETTINGS MENU

AV1NJAI-12A7E9D2-EBD5-4390-9640-2629B7A307F5



Touch [Settings] on the Launch Bar, and then touch a setting item you wish to adjust.

Available setting items may vary depending on models, specifications and software versions.

Available setting items

Setting item	Result	
[Connections]	Displays the Devices, Wi-Fi (if equipped) and USB setting screen.  "Connections settings" (page 2-11)	
[Phone]	Displays the Phone and text message settings screen.  "Phone and text message settings" (page 4-10)	
[Navigation]	Displays the navigation settings screen.  "Navigation settings" (page 6-28)	
[Sound]	Displays the audio settings screen.	
[Volume & Beeps]	Displays the volume adjustment screen.	
[Clock]	Displays the clock adjustment screen.	
[Customise Home Menu]	Displays the HOME MENU editing screen.	
[Customise Audio Sources]	Displays the editing screen for audio source menus on the Launch Bar.  "Selecting from Launch Bar" (page 3-8)	
[System Voice]	Displays the system voice settings screen.  "System Voice settings" (page 7-4)	
[Camera]	Displays the camera settings screen. See the vehicle Owner's Manual for details of the monitor system.	
[General]	[Display]	Displays the display settings screen.
	[Language]	Displays the language settings screen.
	[Keyboard Type]	Keyboard type can be selected.
	[Return All Settings to Default]	This resets all settings to default.

Getting started 2-9

[System Update]	[Version Information]	Displays the version information screen.
	[Map Update]	The map data can be updated.  "How to update map data" (page 6-35)
[Apps]	[Smartphone Connection]	Displays the Connections screen.  "Connections settings" (page 2-11)
	[Notifications]	Displays the swipe-down notification setting screen.  "Swipe-down notifications" (page 2-7)

 **INFO:**

The map (if equipped) update menus can also be accessed from [System Information] on the information screen, even if the menus are not available from the settings screen.

 ["Information menu" \(page 5-2\)](#)

2-10 Getting started

Condition:

[Edit: 2020/ 5/ 28 Model: AV1NJ-A]

CONNECTIONS SETTINGS

AV1NJJA1-B1D6479B-2DE5-4B50-AD8F-54A4EC13EA7D

Changing the settings and viewing information of connected devices, Wi-Fi (if equipped) and USB are available on the Connections screen.

Setting devices

AV1NJJA1-BEE172A8-E0E0-4F75-8762-230628E44312

Settings of the devices connected via Bluetooth®, USB or Wi-Fi (if equipped), such as smartphones used for Hands-Free Phone, Apple CarPlay (if equipped), Android Auto (if equipped), etc., can be changed.

The information of the devices can also be confirmed.

- ☞ "Apple CarPlay" (page 5-3)
- ☞ "Android Auto™" (page 5-7)
- ☞ "USB memory device, iPod and Bluetooth® audio operation" (page 3-13)
- ☞ "Bluetooth® Hands-Free Phone System" (page 4-2)

Connecting cellular phone/audio device:

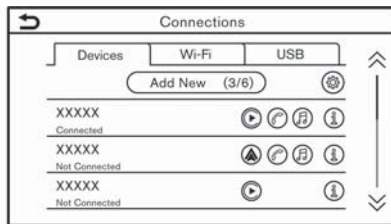

PBA0107X

Example

To use the Bluetooth® device with the in-

vehicle system for the first time, the device connection operation is required.

1. Push **<MENU>** and touch [Connections] on the Launch Bar.
2. Touch [Devices] and touch [Add New]. A message is displayed.



INFO:

If no Bluetooth® device is connected and Apple CarPlay (if equipped) or Android Auto (if equipped) is not active, the same screen can be displayed by pushing and holding **<⏮>** on the steering wheel.

3. Operate as guided by the system.



NOTE:

Some cellular phones or other devices may cause interference or a buzzing noise to come from the audio system speakers. Storing the device in a different location may reduce or eliminate the noise.



INFO:

- The paired phone will be added to the list on the Devices screen.
- Touching name of the other device on the list will switch the connected device.
- Touching [▶] will allow the device to activate/deactivate Apple CarPlay (if

equipped). This icon is displayed if the device is compatible with Apple CarPlay.

- Touching [▲] will allow the device to activate/deactivate Android Auto (if equipped). This icon is displayed if the device is compatible with Android Auto.
- Touching [☞] will allow the device to be connected via Bluetooth® and be used on the Hands-Free Phone System.
- You can register a favorite hands-free phone. The [☞] by the phone device name selected as a favorite will be marked with "★".
☞ "Bluetooth® settings" (page 2-12)
- Touching [🎵] will allow the device to be connected via Bluetooth® and be used for Bluetooth® Audio.
- You can register a favorite Bluetooth® audio device. The [🎵] by the device name selected as a favorite will be marked with "★".
☞ "Bluetooth® settings" (page 2-12)
- Touching [i] will display the information of the device.
- Up to 6 Bluetooth® devices can be registered. If 6 devices are already registered, one of the devices must first be deleted before another device can be registered.

Getting started 2-11

- The pairing procedure of the cellular phone varies according to each cellular phone. See the cellular phone Owner's Manual for the details.
- Consult a NISSAN dealer for information regarding Bluetooth® device connection to your vehicle.

Bluetooth® settings:

The Bluetooth® settings can be changed according to your preference.

1. Push **<MENU>** and touch [Connections] on the Launch Bar.
2. Touch [Devices].
3. Touch .

Available setting items may vary depending on models, specifications and software versions.

Available setting items

Setting item	Action
[Bluetooth]	Turns the Bluetooth® connection on/off.
[Allow 2 Phones Simultaneously]	When turned on, up to 2 Bluetooth® devices can be connected as hands-free phones to the in-vehicle system simultaneously.

[Favourite Phone]	A Bluetooth® device can be registered as a favorite hands-free phone. If the hands-free phone device is within the range with Bluetooth® turned on, the device registered as favorite will automatically be connected to the in-vehicle system with priority upon the system activation.
[Favourite Audio]	A Bluetooth® device can be registered as a favorite audio device. If the Bluetooth® audio device is within the range with Bluetooth® turned on, the device registered as favorite will automatically be connected to the in-vehicle system with priority upon the system activation.
[Device Name]	The device name can be changed.
[PIN]	The PIN code can be changed.

INFO:

With [Device Name], the device name that appears on the screen can be changed and be renamed from the name set as default to the preferred name (such as "Steve's Car" for example).



Device information:

You can display the information of the devices connected to the vehicle.

1. Push **<MENU>** and touch [Connections] on the Launch Bar.
2. Touch [Devices].
3. Touching  by the device name will display the information of the device.

Available items may vary depending on models, specifications and software versions.

Available items

Setting item	Action
[Delete]	Paired devices can be deleted from the list.
[Device Information]	Displays the information of connected Bluetooth® device.
[Smartphone Projection]	Displays the smartphone setting screen.  "Apple CarPlay" (page 5-3)  "Android Auto™" (page 5-7)

Deleting device information:

Paired devices can be deleted from the list.

1. Push **<MENU>** and touch [Connections] on the Launch Bar.

2-12 Getting started

2. Touch [Devices].
3. Touch [i] by the cellular phone name you wish to delete.
4. Touch [Delete]. Touch [Yes] when a message appears.

Wi-Fi setting (if equipped)

AV1NJ-A-5B574DBB-6833-4IC9-A054-FAC518DD656A

A Wi-Fi connection can be made by using an available Wi-Fi network near the vehicle or tethering function of smartphone, etc.

Connecting to a Wi-Fi network:

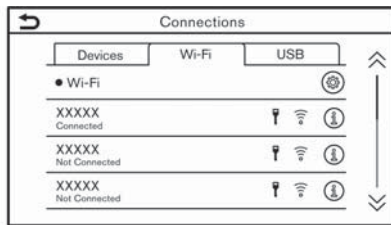

PBH0163X

Example

To use the Wi-Fi connection for the first time, the following connecting procedures are required.

1. Push <MENU> and touch [Connections] on the Launch Bar.
2. Touch [Wi-Fi].
3. Touch the name of the device you wish to connect.

	Indicates that a password is set.
	Indicates the strength of the signal the Wi-Fi device is receiving.

4. Enter the network password and touch [OK]. The device will be connected.

If a listed device is in a status capable of making Wi-Fi connection, touching the device name on the list will start the connection.



INFO:

- Enter the password correctly, including capitalization.
- Touching [i] will display the network information. Turning [Auto Connect] on will automatically connect the vehicle to the network if the network is available.
- The system can connect to only WPA2 security network (not connect WEP, WPA1 network).
- Wi-Fi networks that require a web browser cannot be accessed through this unit.

Wi-Fi settings:

The Wi-Fi settings can be changed according to your preference.

1. Push <MENU> and touch [Connections] on the Launch Bar.
2. Touch [Wi-Fi].
3. Touch [i].
4. Touch a preferred item.

Available setting items may vary depending on models, specifications and software versions.

Available setting items

Setting item	Action
[Wi-Fi]	Turns the Wi-Fi connection on/off.

Deleting Wi-Fi network:

The stored Wi-Fi network can be deleted from the list.

1. Push <MENU> and touch [Connections] on the Launch Bar.
2. Touch [Wi-Fi].
3. Touch [i] by the name of the network you wish to delete.
4. Touch [Forget This Network]. Touch [Yes] when a message appears.

Displaying USB device information

AV1NJ-A1-0410F8D5-4D74-4C02-A786-2D75AB254FEC

The information of the connected USB device can be viewed.

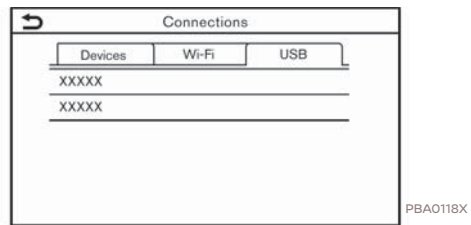

Example

1. Push **<MENU>** and touch [Connections] on the Launch Bar.
2. Touch [USB].
3. Touch the name of the device you wish to check. The name and the type of the device are displayed.

2-14 Getting started

Condition:

[Edit: 2020/ 5/ 28 Model: AV1NJ-A]

3 Audio system

Audio operation precautions	3-2
Radio	3-2
USB (Universal Serial Bus) connection port	3-3
Compressed Audio Files (MP3/WMA/AAC)	3-4
Bluetooth® audio	3-7
Audio operations	3-7
Audio main operation	3-7
Radio	3-8
USB memory device, iPod and Bluetooth® audio player	3-11
Smartphone audio (if equipped)	3-17
Audio settings	3-18
Audio adjustments with audio adjust bar	3-19
USB memory device care and cleaning	3-19
USB memory device	3-19



AUDIO OPERATION PRECAUTIONS

AV1NJJA1-B0DBBB37-B849-425F-902A-DDABE30FE9B4



CAUTION:

- **Operate the audio system only when the vehicle engine is running. Operating the audio system for extended periods of time with the engine turned off can discharge the vehicle battery.**
- **Do not allow the system to get wet. Excessive moisture such as spilled liquids may cause the system to malfunction.**
- **Park the vehicle in a safe location and apply the parking brake to view movies (if equipped) on the touch screen display.**

RADIO

AV1NJJA1-2E7BDA12-EFEE-40F2-BD7E-0CIAD5ECA109

Place the ignition switch in the ACC or ON position before turning on the radio. If you listen to the radio with the engine not running, the ignition switch should be placed in the ACC position.

Radio reception is affected by station signal strength, distance from radio transmitter, buildings, bridges, mountains and other external influences. Intermittent changes in reception quality normally are caused by these external influences.

Using a cellular phone in or near the vehicle may influence radio reception quality.

3-2 Audio system

Condition:

Radio reception

AV1NJJA1-89FE3704-0B57-4447-88CD-7BD9D337A7DC

Your radio system is equipped with state-of-the-art electronic circuits to enhance radio reception. These circuits are designed to extend reception range, and to enhance the quality of that reception.

However there are some general characteristics of both FM and AM radio signals that can affect radio reception quality in a moving vehicle, even when the finest equipment is used. These characteristics are completely normal in a given reception area, and do not indicate any malfunction in your radio system.

Reception conditions will constantly change because of vehicle movement. Buildings, terrain, signal distance and interference from other vehicles can work against ideal reception. Described below are some of the factors that can affect your radio reception.

Some cellular phones or other devices may cause interference or a buzzing noise to come from the audio system speakers. Storing the device in a different location may reduce or eliminate the noise.

FM radio reception

AV1NJJA1-275BC1BF-3C52-437B-9A90-2B55439E4402

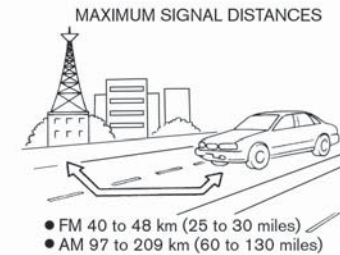

5GA0053X

Range: FM range is normally limited to 40 to 48 km (25 to 30 miles), with monaural (single station) FM having slightly more range than stereo FM. External influences may sometimes interfere with FM station reception even if the FM station is within 40 km (25 miles). The strength of the FM signal is directly related to the distance between the transmitter and receiver. FM signals follow a line-of-sight path, exhibiting many of the same characteristics as light. For example they will reflect off objects.

Fade and drift: As your vehicle moves away from a station transmitter, the signals will tend to fade and/or drift.

Static and flutter: During signal interference from buildings, large hills or due to antenna position, usually in conjunction with an increased distance from the station transmitter, static or flutter can be heard. This can be reduced by low-

ering the treble setting to reduce the treble response.

Multipath reception: Because of the reflective characteristics of FM signals, direct and reflected signals reach the receiver at the same time. The signals may cancel each other, resulting in momentary flutter or loss of sound.

AM radio reception

AV1NJAF3C8ECE4-EFC7-4ED4-9553-9C805FE5ED54

AM signals, because of their low frequency, can bend around objects and skip along the ground. In addition, the signals can bounce off the ionosphere and be bent back to earth. Because of these characteristics, AM signals are also subject to interference as they travel from transmitter to receiver.

Fading: Occurs while the vehicle is passing through motorway underpasses or in areas with many tall buildings. It can also occur for several seconds during ionospheric turbulence even in areas where no obstacles exist.

Static: Caused by thunderstorms, electrical power lines, electric signs and even traffic lights.

USB (Universal Serial Bus) CONNECTION PORT

AV1NJAI-B14770CC-B357-4196-BAA4-5BEF948ED871



WARNING:

Do not connect, disconnect or operate the USB device while driving. Doing so can be a distraction. If distracted you

could lose control of your vehicle and cause an accident or serious injury.



CAUTION:

- **Do not force the USB device into the USB connection port. Inserting the USB device tilted or up-side-down into the port may damage the port. Make sure that the USB device is connected correctly into the USB connection port.**
- **Do not grab the USB connection port cover (if equipped) when pulling the USB device out of the port. This could damage the port and the cover.**
- **Do not leave the USB cable in a place where it can be pulled unintentionally. Pulling the cable may damage the port.**

The vehicle is not equipped with a USB device. USB devices should be purchased separately as necessary.

This system cannot be used to format USB devices. To format a USB device, use a personal computer.

This system supports various USB memory devices, USB hard drives and iPod players. Some USB devices may not be supported by this system.

- Partitioned USB devices may not be played correctly.

- Some characters used in other languages (Chinese, Japanese, etc.) are not displayed properly on the display. Using English language characters with a USB device is recommended.

General notes for USB use:

Refer to your device manufacturer's owner information regarding the proper care of the device.

Notes for iPod use:

iPod is a trademark of Apple Inc., registered in the U.S. and other countries.

- Improperly plugging in the iPod may cause a checkmark to be displayed on and off (flickering). Always make sure that the iPod is connected properly.
- Audiobooks may not play in the same order as they appear on an iPod.

Compatibility:

Made for

- iPhone 8 Plus
- iPhone 8
- iPhone 7 Plus
- iPhone 7
- iPhone SE
- iPhone 6s Plus
- iPhone 6s
- iPhone 6 Plus

- iPhone 6
- iPhone 5s
- iPod touch (6th generation)

INFO:

- Make sure that iOS is updated.
- The Lightning connector works with iPhone (5s through 8 Plus) and iPod touch (6th generation). USB works with iPhone (5s through 8 Plus) and iPod touch (6th generation).
- Refer to your device manufacturer's owner information regarding the proper use and care of the device.

COMPRESSED AUDIO FILES (MP3/WMA/AAC)

AV1NJAJ1-59506932-77E0-4626-8C21-4A60DD222070

Explanation of terms

AV1NJAJ1-EB91730C-DOC7-441C-9028-C9C6F27A417B

- **MP3** – MP3 is short for Moving Pictures Experts Group Audio Layer 3. MP3 is the most well-known compressed digital audio file format. This format allows for near "CD quality" sound, but at a fraction of the size of normal audio files. MP3 conversion of an audio track can reduce the file size by approximately a 10:1 ratio (Sampling: 44.1 kHz, Bit rate: 128 kbps) with virtually no perceptible loss in quality. The compression reduces certain parts of sound that seem inaudible to most people.

3-4 Audio system

Condition:

- **WMA** – Windows Media Audio (WMA) is a compressed audio format created by Microsoft as an alternative to MP3. The WMA codec offers greater file compression than the MP3 codec, enabling storage of more digital audio tracks in the same amount of space when compared to MP3s at the same level of quality.
- **Bit rate** – Bit rate denotes the number of bits per second used by a digital music file. The size and quality of a compressed digital audio file is determined by the bit rate used when encoding the file.
- **Sampling frequency** – Sampling frequency is the rate at which the samples of a signal are converted from analog to digital (A/D conversion) per second.
- **Multisession** – Multisession is one of the methods for writing data to media. Writing data once to the media is called a single session, and writing more than once is called a multisession.
- **ID3/WMA tag** – The ID3/WMA tag is the part of the encoded MP3 or WMA file that contains information about the digital music file such as song title, artist, album title, encoding bit rate, track time duration, etc. ID3 tag information is displayed on the Album/Artist/Track title line on the display.

- **AAC** – Advanced Audio Coding (AAC) is a compressed audio format. AAC offers greater file compression than MP3 and enables music file creation and storage at the same quality as MP3.

Playback order

AV1NJAJ1-2ABE94F5-2F22-4C97-ACEA-E869F1816CEF

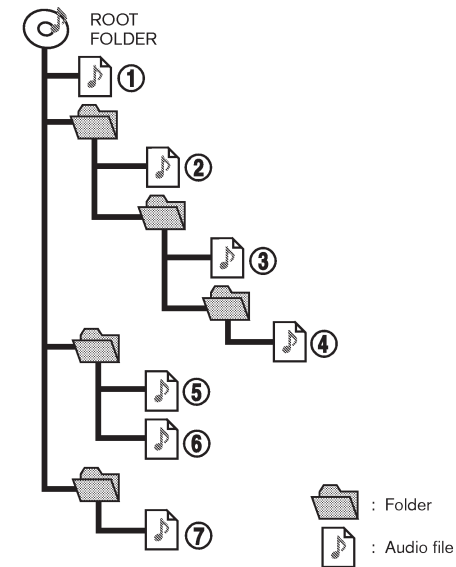

SAA2494

- Names of folders not containing compressed audio files are not shown on the display.

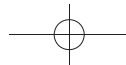

(27,1)

- The playback order is the order in which the files were written by the writing software, so the files might not play in the desired order.
- Music playback order of compressed audio files is as illustrated.

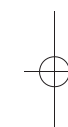
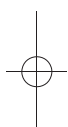

Audio system 3-5

Condition:

[Edit: 2020/ 5/ 28 Model: AV1NJ-A]

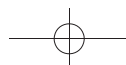

Specification chart for USB

AV1NJ-A1-6D2C4A13-89EC-4642-A614-FF0B956F762C

Supported media	USB2.0
Supported file systems	FAT16, FAT32
Folder levels	Folder levels: 8, Files via folder: 255, Folders: 512 (including root folder), Files: 8000
Tag information (Song title, Artist name and Album name)	ID3 tag VER1.0, VER1.1, VER2.2, VER2.3, VER2.4 (MP3 only)
	WMA tag (WMA only)
	AAC tag (AAC only)

Format			Sampling frequency	Supported bitrate
MP3 *1	MPEG1	Layer-3	32, 44.1, 48 kHz	32-320 kbps
	MPEG2		16, 22.05, 24 kHz	8-160 kbps
WMA *2			8, 11.025, 16, 22.05, 32, 44.1, 48 kHz	12-192 kbps
AAC (MPEG4) *3 (Extension "m4a" only)			11.025, 16, 22.05, 32, 44.1, 48 kHz	8-320 kbps
FLAC			8-192 kHz	128-12,288 kbps
WAV			8-192 kHz	128-12,288 kbps

*1 MPEG2.5 is not supported.

*2 WMA7, WMA8, WMA9, WMA9.1, WMA9.2 are supported. (WMA9 Professional, Lossless, Voice are not supported.)

*3 Only AAC files encoded by iTunes are supported. HE-AAC (High-Efficiency) is not supported.

3-6 Audio system

Condition:

[Edit: 2020/ 5/ 28 Model: AV1NJ-A]

BLUETOOTH® AUDIO

AV1NJA1-24BDA0F9-283E-4615-995E-7F61FFF7F7B7

- Some Bluetooth® audio devices may not be recognized by the in-vehicle audio system.
- It is necessary to set up the wireless connection between a compatible Bluetooth® audio device and the in-vehicle Bluetooth® module before using the Bluetooth® audio.
- The Bluetooth® audio may stop playing when
 - receiving a hands-free call.
 - checking the connection to the hands-free phone.
 - connecting the hands-free phone or the audio device.
 - downloading the phonebook memory from the connected cellular phone.
- Do not place a Bluetooth® audio device in an area surrounded by metal or far away from the in-vehicle Bluetooth® module to prevent tone quality degradation and wireless connection disruption.
- While an audio device is connected through a Bluetooth® wireless connection, the battery of the device may discharge quicker than usual.
- This system supports the Bluetooth® Advanced Audio Distribution Profile

(A2DP) and Audio/Video Remote Control Profile (AVRCP).

- Wireless LAN (Wi-Fi) and the Bluetooth® functions share the same frequency band (2.4 GHz). Using the Bluetooth® and the wireless LAN functions at the same time may slow down or disconnect the communication and cause undesired noise. It is recommended that you turn off the wireless LAN (Wi-Fi) when using the Bluetooth® functions.

AUDIO OPERATIONS





AV1NJA1-8910DA01-FA52-4035-BC56-AEEA46A2B06E

AUDIO MAIN OPERATION



AV1NJA1-21A3DF2-D88E-4CCE-B170-B9485A368E7F

Turning audio system on/off

AV1NJA1-DEC1D59C-0B79-4535-9FBF-86BD31187CDD

The ignition switch must be in the ACC or ON position to turn on the audio system. Push **<VOL/  >/<VOL/PUSH  >** or **<AUDIO>** to turn on the last audio source that was playing immediately before the system was turned off. To turn off the audio system, push **<VOL/  >/<VOL/PUSH  >** again.

INFO:

The audio system can also be turned on by turning **<VOL/  >/<VOL/PUSH  >** when the system is turned off.

Selecting audio source

AV1NJA1-2A84B441-03C2-4E17-9A89-AC3DD54D9273

Selecting from source menu screen:

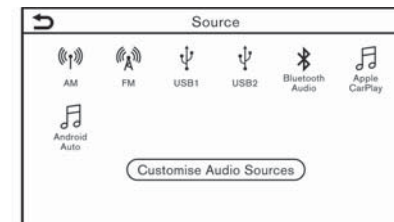

PBA0128X

Example

1. Push **<AUDIO>** when the audio screen is displayed.
2. Select an audio source you prefer to play.

Audio system 3-7

Condition:

INFO:

- Touching [Source] on the upper left corner of the audio screen will also display the audio source menu screen.
- When [Rear Display] (if equipped) is selected, audio source will switch to the Rear Entertainment System (RES) (if equipped). However, the image from the HDMI-connected device cannot be displayed on the touch screen display. For details, see the vehicle Owner's Manual.
- Depending on the models, specifications and software versions, the audio source can also be changed by operating the vehicle information display. Refer to the vehicle Owner's Manual for the detail of the vehicle information display.

Selecting from Launch Bar:

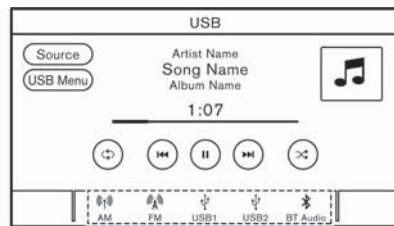

Example

The source icons are displayed on the Launch Bar. Touch the icon to select the preferred audio source.

3-8 Audio system

Customizing Launch Bar:

The source icons displayed on the Launch Bar can be customized.

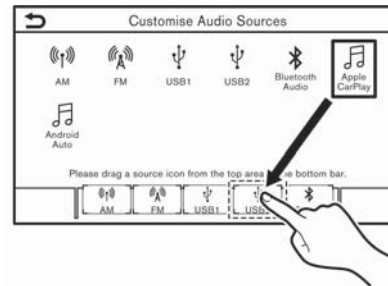

Example

1. Push **<AUDIO>** or touch [Source], while the Audio screen is displayed.
2. Touch [Customise Audio Sources].
3. Drag the preferred source icon to the Launch Bar.
4. Push **<BACK>** or touch **[]** to confirm the setting.

RADIO

AV1NJAI-952EDDB7-2BDB-4ADF-BF9F-C1407C8FAA3E

Radio operation

AV1NJAI-80A929F3-7DCC-4A07-8E24-1D5FD0478011

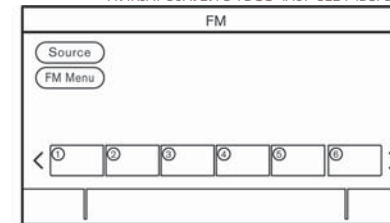

PBA0131X

Radio activation and band selection:

To listen to the radio, turn on the audio system and select a preferred radio band. Refer to "Selecting audio source" (page 3-7)

INFO:

When the stereo broadcast signal is weak, the radio will automatically change from stereo to monaural reception.

AM/FM radio operation:

General operations of AM and FM radio are as follows.

Available functions and buttons/switches may vary depending on the models, specifications, software versions and conditions.

Function	Operation
Manual tuning (AM/FM)	<ul style="list-style-type: none"> • Control panel <ul style="list-style-type: none"> – Turn <TUNE SCROLL/PUSH SOUND>. – Push <◀▶>/<▶▶>.
Seek tuning	<ul style="list-style-type: none"> • Control panel <ul style="list-style-type: none"> – Push and hold <◀▶>/<▶▶>. • Steering wheel switch <ul style="list-style-type: none"> – Push and hold <◀▶>/<▶▶>.
Presetting stations	<ul style="list-style-type: none"> • Touch screen display <ol style="list-style-type: none"> 1. Select a radio band. 2. Tune to the station you wish to store. 3. Touch and hold one of the preset numbers in the preset list on the radio screen. <p>The information such as frequency etc. will be displayed on the preset list.</p>
Selecting preset stations	<ul style="list-style-type: none"> • Steering wheel switch <ul style="list-style-type: none"> – Push <◀▶>/<▶▶>. • Touch screen display <ul style="list-style-type: none"> – Briefly touch a preferred station on the preset list on the radio screen.

Menu items

AV1NJ-A1-D950716C-9E53-45AA-A4AF-8EC5B4A2CD6E

Touch [FM Menu] or [AM Menu] on each radio screen to display the corresponding menu screen.

Available menu items may vary depending on models, specifications and software versions.

[TA]*	When this item is turned on, received TA (Traffic Announcement) will interrupt the audio source that is playing.
[Refresh]	Touch to update the station list displayed on the right side of the FM or AM menu screen.
Station List	Displays the station list on the right side of the FM or AM menu screen.

*: Depending on the models, specifications and software versions, [TA] may be displayed on the main operation screens for some audio sources.

3-10 Audio system

Condition:

[Edit: 2020/ 5/ 28 Model: AV1NJ-A]

USB MEMORY DEVICE, iPod AND BLUETOOTH® AUDIO PLAYER

AV1NJAI-FOEE40EE-2CO9-446F-91CA-698A1974E7F4



WARNING:

Do not connect, disconnect or operate the USB device while driving. Doing so can be a distraction. If distracted you could lose control of your vehicle and cause an accident or serious injury.



CAUTION:

- Do not force the USB device into the USB connection port. Inserting the USB device tilted or up-side-down into the port may damage the port. Make sure that the USB device is connected correctly into the USB connection port.
- Do not grab the USB connection port cover (if equipped) when pulling the USB device out of the port. This could damage the port and the cover.
- Do not leave the USB cable in a place where it can be pulled unintentionally. Pulling the cable may damage the port.

Connection and activation

AV1NJAI-74389BE8-107F-4C10-AB2B-6DBF3470668D

USB memory device:

Connection

Connect a compatible USB memory device into the port.

👉 "USB (Universal Serial Bus) connection ports" (page 2-5)

Refer to your device manufacturer's owner information regarding the proper use and care of the device.

Activation

USB memory device can be played by selecting the source on the audio source menu screen.

👉 "Selecting audio source" (page 3-7)

iPod:

Connection

Connect a compatible iPod to the USB connection port via a USB cable.

👉 "USB (Universal Serial Bus) connection ports" (page 2-5)

The battery of the iPod will be charged while the device is connected to the vehicle if the iPod supports charging via a USB connection.

Depending on the device and firmware version of the iPod, the display on the iPod shows a NISSAN or Accessory Attached screen when the connection is completed. When the iPod is connected to the vehicle, the iPod music library can only be operated by the vehicle audio

controls.

Activation

The iPod can be played by selecting the source on the audio source menu screen.

👉 "Selecting audio source" (page 3-7)

Bluetooth® audio:

Your vehicle is equipped with Bluetooth® Audio. If you have a compatible Bluetooth® device with streaming audio capability (A2DP profile), you can set up a wireless connection between your Bluetooth® device and the in-vehicle audio system. This connection allows you to listen to the audio from the Bluetooth® device using your vehicle speakers. It also may allow basic control of the device for playing and skipping audio files using the AVRCP Bluetooth® profile. Not all Bluetooth® devices have the same level of controls for AVRCP. Please consult the manual for your Bluetooth® device for more details.

Connection

Connect a compatible streaming audio capable Bluetooth® device (A2DP profile) to set up a wireless connection between the Bluetooth® device and the in-vehicle system. Bluetooth® connection can be set up from the Connections screen.

👉 "Setting devices" (page 2-11)

Audio system 3-11

 **INFO:**

- Depending on the Bluetooth® audio device that is connected, it may not be possible to perform audio operations or a delay may occur before music is played back.
- Not all Bluetooth® devices have the same level of controls for AVRCP. Consult the manual for your Bluetooth® device for more details.
- Wireless LAN (Wi-Fi) and the Bluetooth® functions share the same frequency band (2.4 GHz). Using the Bluetooth® and the wireless LAN functions at the same time may slow down or disconnect the communication and cause undesired noise. It is recommended that you turn off the wireless LAN (Wi-Fi) when using the Bluetooth® functions.

Activation

A Bluetooth® audio device can be played by selecting the source on the audio source menu screen.

 ["Selecting audio source" \(page 3-7\)](#)

3-12 Audio system

Condition:

[Edit: 2020/ 5/ 28 Model: AV1NJ-A]

USB memory device, iPod and Bluetooth® audio operation

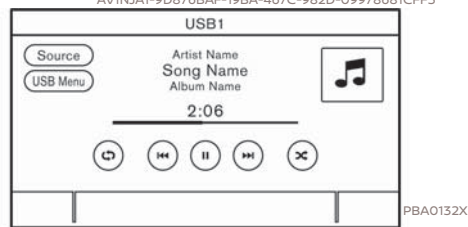

General operations of USB memory device, iPod and Bluetooth® audio are as follows. Available functions and buttons/switches may vary depending on the models, specifications, software versions and conditions.

Function	Operation	Applicable source
Play	<ul style="list-style-type: none"> • Touch screen display <ul style="list-style-type: none"> – Touch [▶]. 	USB, iPod, Bluetooth® audio
Pause	<ul style="list-style-type: none"> • Touch screen display <ul style="list-style-type: none"> – Touch [⏸]. 	USB, iPod, Bluetooth® audio
Skipping tracks	<ul style="list-style-type: none"> • Control panel <ul style="list-style-type: none"> – Push < ⏮ > / < ⏭ > . – Turn < TUNE SCROLL/PUSH SOUND > *. • Steering wheel switch <ul style="list-style-type: none"> – Push < ⏮ > / < ⏭ > . • Touch screen display <ul style="list-style-type: none"> – Touch [⏮] / [⏭] . <p>*: Depending on the models, turning < TUNE SCROLL/PUSH SOUND > may change folders when available.</p>	USB, iPod, Bluetooth® audio
Rewinding/fast-forwarding	<ul style="list-style-type: none"> • Control panel <ul style="list-style-type: none"> – Push and hold < ⏮ > / < ⏭ > . • Steering wheel switch <ul style="list-style-type: none"> – Push and hold < ⏮ > / < ⏭ > . • Touch screen display <ul style="list-style-type: none"> – Touch and hold [⏮] / [⏭] . 	USB, iPod, Bluetooth® audio

Function	Operation	Applicable source
Changing play mode	<ul style="list-style-type: none">• Touch screen display<ul style="list-style-type: none">– Touch [↺] to change the repeat mode.– Touch [↻] to change the random mode.	USB, iPod, Bluetooth® audio

3-14 Audio system

Condition:

Menu items

AV1NJA1-F1414186-D724-45CC-8EB1-C5063A9CC599

Touch [USB Menu], [iPod Menu] and [BT Menu] on each audio screen to display the corresponding audio menu screen. Available setting items may vary depending on models, specifications, software versions and the connected audio device. Depending on the connected Bluetooth® device, [BT Menu] may not be displayed.

[USB Menu]:

[TA]*	When this item is turned on, received TA (Traffic Announcement) will interrupt the audio source that is playing.
[Now Playing]	Touch to display the USB screen.
[Folder List]	Touch to display the folder list. Touch an item on the list to select the folder. The sub-folder or track list will be displayed. Select a sub-folder or track from the list.
[Album Artwork]	Touch to turn on/off the album artwork display on the USB screen.
[Playlists]	Touch to display the list according to the selected item.
[Artists]	
[Albums]	
[Songs]	
[Genres]	
[Composers]	

[iPod Menu]:

[TA]*	When this item is turned on, received TA (Traffic Announcement) will interrupt the audio source that is playing.
[Now Playing]	Touch to display the iPod screen.
[Current List]	Touch to display the current list. A list of tracks in the currently selected category is displayed.
[Album Artwork]	Touch to turn on/off the album artwork display on the iPod screen.

[Playlists]	Touch to display the list according to the selected item.
[Artists]	
[Albums]	
[Songs]	
[Genres]	
[Composers]	
[Audiobooks]	
[Podcasts]	

[BT Menu]:

[TA]*	When this item is turned on, received TA (Traffic Announcement) will interrupt the audio source that is playing.
[Now Playing]	Touch to display the Bluetooth® audio screen.
[Current List]	Touch to display the current list. A list of tracks in the currently selected folder is displayed.
[Connections]	Touch to display the Connections screen.  "Connections settings" (page 2-11)
Folder list	Touch an item on the list to select the folder.

*: Depending on the models, specifications and software versions, [TA] may be displayed on the main operation screens for some audio sources.

3-16 Audio system

Condition:

[Edit: 2020/ 5/ 28 Model: AV1NJ-A]

SMARTPHONE AUDIO (if equipped)

You can also listen to music from your compatible smartphone using Apple CarPlay or Android Auto.

-  "Apple CarPlay" (page 5-3)
-  "Android Auto™" (page 5-7)

Connecting smartphone

Connect the iPhone or Android phone to the USB connection port.

-  "USB (Universal Serial Bus) connection ports" (page 2-5)

Depending on the models, iPhone devices can also be connected wirelessly for Apple CarPlay.

-  "Connecting wirelessly" (page 5-4)

Smartphone audio operation

1. Connect the iPhone or Android phone and activate Apple CarPlay or Android Auto.
2. Push **<AUDIO>**.
3. Touch [Source].
4. Touch [Apple CarPlay] or [Android Auto] in the audio source menu screen, and the smartphone audio starts activating.

-  "Selecting audio source" (page 3-7)

AUDIO SETTINGS

AV1NJA1-ECFE1718-B192-4A27-91B2-70E3D8B84B09

Audio settings can be adjusted or audio related functions can be turned on/off with the following procedure.

Touch [Settings] on the Launch Bar, and then touch [Sound].

Available setting items may vary depending on models, specifications and software versions.

Setting items	Action
[Bass]	Adjust the speaker tone quality and sound balance by touching [-]/[+], [L]/[R] or [R]/[F].
[Mid]	
[Treble]	
[Balance]	
[Fader]	
[Bass Enhancer]	When this item is turned on, the system enhances bass sound.
[Speed-Sensitive Volume]	Automatically adjusts the volume depending on the vehicle speed. Touch [-]/[+] to change the sensitivity level.

3-18 Audio system

Condition:

[Edit: 2020/ 5/ 28 Model: AV1NJ-A]

AUDIO ADJUSTMENTS WITH AUDIO ADJUST BAR

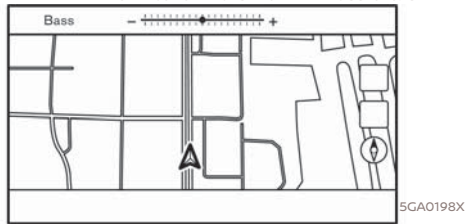

Example

Sound quality can be adjusted with the following buttons.

- /PUSH SOUND>*
- <TUNE SCROLL/PUSH SOUND>*

*: if equipped

When the list screen is not displayed, pushing any of the buttons listed above will display the audio adjustment bar. Each time the button is pushed, the menu will shift to the available setting items.

Turn the button to adjust the level of the selected setting item.

INFO:

This function may not be available when a menu is highlighted on the screen.

USB MEMORY DEVICE CARE AND CLEANING

AV1NJ1-382E2C0C-F95D-4F32-83DB-7AC976003DF3

USB MEMORY DEVICE

AV1NJ1-F355BB54-6B69-4B59-B94F-C82FA1BFE34F

- Never touch the terminal portion of the USB memory device.
- Do not place heavy objects on the USB memory device.
- Do not store the USB memory device in highly humid locations.
- Do not expose the USB memory device to direct sunlight.
- Do not spill any liquids on the USB memory device.

Refer to the USB memory device Owner's Manual for the details.

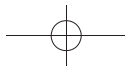

(42,1)



MEMO

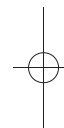
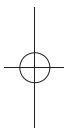

3-20 Audio system



Condition:

[Edit: 2020/ 5/ 28 Model: AV1NJ-A]

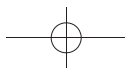

4 Hands-Free Phone

Bluetooth® Hands-Free Phone System	4-2
Phone screen	4-3
Indicators	4-3
Phone	4-4
Hands-free text messaging assistant	4-6
Phone and text message settings	4-10



BLUETOOTH® HANDS-FREE PHONE SYSTEM

AV1NJA1-99952F72-0167-4BT1-9D0E-D9F1C385EEA8

WARNING:

- **Use a phone after stopping your vehicle in a safe location. If you have to use a phone while driving, exercise extreme caution at all times so full attention may be given to vehicle operation.**
- **If you find yourself unable to devote full attention to vehicle operation while talking on the phone, pull off the road to a safe location and stop your vehicle before doing so.**

CAUTION:

To avoid draining the vehicle battery, use a phone only after starting the engine.

Your vehicle is equipped with Bluetooth® Hands-Free Phone System. If you are an owner of a compatible Bluetooth® enabled cellular phone, you can set up the wireless connection between your cellular phone and the in-vehicle phone module. With Bluetooth® wireless technology, you can make or receive a phone call with your cellular phone in your pocket.

Once a cellular phone is connected to the in-vehicle phone module, the procedure for connecting the phone does not need to be performed again. Your phone is automatically selected with the in-vehicle phone module when the ignition switch is

placed in the ACC or ON position with the selected cellular phone turned on and carried in the vehicle.

You can register up to 6 different Bluetooth® devices in the in-vehicle phone module. However, you can talk on only one cellular phone at a time.

The Voice Recognition System supports phone commands, so dialing a phone number using your voice is possible.

 "Voice recognition" (page 7-2)

Before using the Bluetooth® Hands-Free Phone System, refer to the following notes.

- Wireless LAN (Wi-Fi) and the Bluetooth® functions share the same frequency band (2.4 GHz). Using the Bluetooth® and the wireless LAN functions at the same time may slow down or disconnect the communication and cause undesired noise. It is recommended that you turn off the wireless LAN (Wi-Fi) when using the Bluetooth® functions.
- Set up the wireless connection between a compatible cellular phone and the in-vehicle phone module before using the Bluetooth® Hands-Free Phone System.
- Some Bluetooth® enabled cellular phones may not be recognized by the in-vehicle phone module. Consult a NISSAN dealer for phone compatibility.
- You will not be able to use a hands-free phone under the following conditions:
 - Your vehicle is outside of the phone service area.
 - Your vehicle is in an area where it is difficult to receive radio waves; such as in a tunnel, in an underground parking garage, behind a tall building or in a mountainous area.
 - Your cellular phone is locked in order to prevent dialing.
- When the radio wave condition is not ideal or ambient sound is too loud, it may be difficult to hear the other person's voice during a call.
- Immediately after the ignition switch is placed in the ACC or ON position, it may be impossible to receive a call for a short period of time.
- Do not place the cellular phone in an area surrounded by metal or far away from the in-vehicle phone module to prevent tone quality degradation and wireless connection disruption.
- While a cellular phone is connected through the Bluetooth® wireless connection, the battery power of the cellular phone may discharge quicker than usual.
- Consult a NISSAN dealer if the Blue-

4-2 Hands-Free Phone

Condition:

[Edit: 2020/ 5/ 28 Model: AV1NJ-A]



tooth® Hands-Free Phone System seems to be malfunctioning.

- Some cellular phones or other devices may cause interference or a buzzing noise to come from the audio system speakers. Storing the device in a different location may reduce or eliminate the noise.
- Refer to the cellular phone Owner's Manual regarding the phone pairing procedure specific to your phone, battery charging, cellular phone antenna, etc.
- The antenna display on the screen may not coincide with the antenna display of some cellular phones.
- The battery display on the screen may not coincide with the battery display of some cellular phones.
- The microphone is located near the map light.
- Keep the interior of the vehicle as quiet as possible to hear the caller's voice clearly as well as to minimize its echoes.
- If reception between callers is unclear, adjusting the outgoing call volume may improve the clarity.
 "Control buttons and touch screen display" (page 2-2)





PHONE SCREEN



AV1NJJA1-70ACF9EA-0A9A-452F-9CC6-B6BDEA9398AC

The phone screen can be displayed by following operations.

- Push <  > on the control panel (if equipped)
- Push <  > on the steering wheel
- Touch [Phone] on the Launch Bar

Available items

Menu item	Action
[Quick Dial]	Displays the Quick Dial screen.  "Making a call" (page 4-4)
[Phone Book]	Displays the phone book screen.  "Making a call" (page 4-4)
[Call History]	Displays the call history screen.  "Making a call" (page 4-4)
[Dial Number]	Displays the phone number entry screen.  "Making a call" (page 4-4)
[Text Message]	Displays the received message list screen.  "Displaying received message list" (page 4-7)

[Connections]	Displays the Connections screen.  "Setting devices" (page 2-11)
[Volume]	Displays the volume adjustment screen.  "Volume settings" (page 4-11)



INFO:

Depending on the connected device, some functions cannot be used.

INDICATORS

AV1NJJA1-DF17CCD9-47EB-42F9-B647-1A1218B25DA1

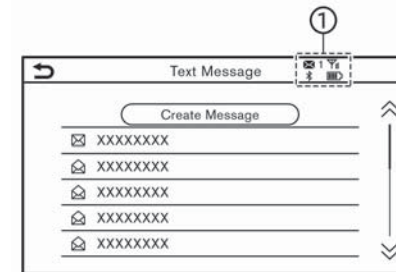





PBF0025X

Example

When a cellular phone is connected through the Bluetooth® wireless connection, indicators ① for phone and text messaging are displayed on the top of the screen.

Available indicators may vary depending on models, specifications and software versions.

Hands-Free Phone 4-3

 1	Indicates the number of unread received messages.
	Indicates that Bluetooth® device(s) are connected.
	Indicates the strength of the signal the Bluetooth® device is receiving.
	Indicates the amount of remaining Bluetooth® device battery.

PHONE

AV1NJJA1-023A5F01-7310-424C-B3E9-547E1F8FC21F

Connecting Bluetooth® Hands-Free Phone

AV1NJJA1-46BD8347-EF56-4BDE-AE6B-DB97C7EC282D

A cellular phone device must be connected to the Bluetooth® Hands-Free Phone System before operation. Up to 6 Bluetooth® devices can be registered to the system.

 "Setting devices" (page 2-11)

Phone selection



AV1NJJA1-205885D8-3C6A-48D8-97F0-5631F1B29D25

Follow the instructions below to select a connected device for use with the Bluetooth® Hands-Free Phone System:

1. Touch [Phone] on the Launch Bar.
2. Touch [Connections] and touch [Devices]. A list of the connected cellular phones is displayed.
3. Touch one of the connected cellular phones from the list.

When the connection is successful,

4-4 Hands-Free Phone

"Connected" is displayed under the device name.
If  is displayed in gray, touch .



INFO:

To select a phone, the Bluetooth® of the cellular phone needs to be turned on.

Making a call

AV1NJJA1-A10664E4-4636-4046-949D-803558D90AF1

1. Touch [Phone] on the Launch Bar.
2. Select one of the following methods to make a call.

[Quick Dial]	Select a telephone number registered as a Quick Dial number.  "Quick Dial" (page 4-12)
[Phone book]	Select a person and the phone number you wish to call from the phonebook. Depending on the device, the phonebook will be downloaded from the cellular phone automatically when it is connected. If the automatic download does not take place, the telephone number must be transferred to the hands-free phone system from the cellular phone prior to using this method.  "Phone settings" (page 4-10)
[Call History]	Select a telephone number from recent incoming, outgoing or missed calls.

[Dial Number]	Enter the phone number manually using the keypad displayed on the screen.
---------------	---

INFO:

Either of the connected phone devices can be selected for dialing operation when [Allow 2 Phones Simultaneously] is turned on.

 "Bluetooth® settings" (page 2-12)

Receiving a call

AV1NJJA1-309AF505-32BC-4C5C-80D1-0E512251C11B

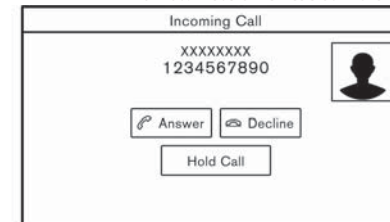

PBF0041X

When you receive a phone call, the display switches to the Incoming Call screen and the ringtone is played through the vehicle's audio system.

Taking a call:

To answer the call, take one of the following actions.

- Push <  > on the steering wheel.
- Touch [Answer].

Rejecting a call:

To reject the call, take one of the following actions.

- Push and hold < > on the steering wheel.
- Touch [Decline].

Holding a call:

To hold the call, touch [Hold Call].

INFO:

If [Allow 2 Phones Simultaneously] is turned on, two hands-free phone devices can be connected at the same time. If one of the connected devices receives an incoming call while the other device is already online, a pop-up message will hang up the line of the other connected device. Touch [Answer] to answer the call and hang up the line on the other device. Touch [Decline] to continue the conversation on the other device.

During a call

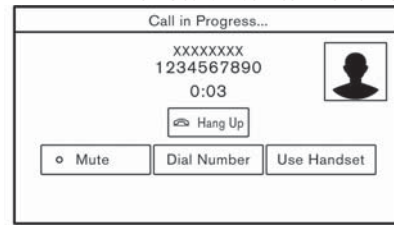

Example

The Call in Progress screen will appear during a call.

To hang up the phone, touch [Hang Up].

Operations during a call:

There are some options available other than hanging up a call or answering/rejecting incoming calls.

Touch one of the following displayed keys on the screen to take action.

Available item	Action
[Use Handset]	Transfer the call to the cellular phone.
[Mute]	When muted, your voice will not be heard by the person on the other end of the line.
[Dial Number]	Using the touch tone, send digits to the connected party for using services such as voicemail.

[Switch Call]*	Answer another incoming call. The person you are talking to will be placed on hold. Touch once more to speak to the person on hold again.
----------------	---

*: Available when a call is received while on the line with another person. The availability of this function depends on the cellular phone.

INFO:

To adjust the person's voice to be louder or quieter, push < > on the steering wheel or turn <VOL/ > / <VOL/ > on the control panel while talking on the phone.

Call from a second person:

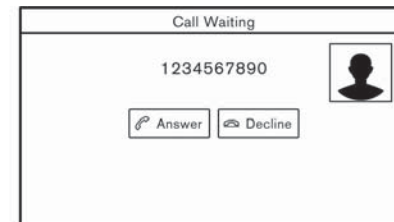

When another phone call is received during a call, the Call Waiting screen will appear.

Answering call from a second person:

To answer the call from the second person and place the first caller on hold, take one of the following actions.

- Push < > on the steering wheel.
- Touch [Answer].

Rejecting call from a second person:

To reject a call from the second person and continue the conversation with the first caller, touch [Decline].

During a call with a second person:

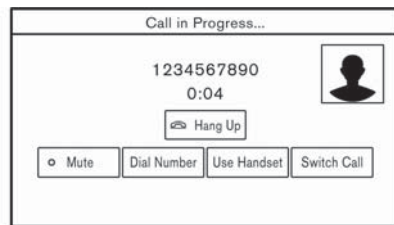

Example

To hang up the phone and return to the conversation with the first caller, touch [Hang Up].

To switch between two calls on line, touch [Switch Call].

HANDS-FREE TEXT MESSAGING ASSISTANT

AV1NJA1-9092E6E3-0312-4427-83C9-7BCEA4744D55

WARNING:

- **Use the text messaging feature after parking your vehicle in a safe location. If you have to use the feature while driving, exercise extreme caution at all times so full attention may be given to vehicle operation.**
- **Laws in some jurisdictions may restrict the use of "Text-to-Speech." Check local regulations before using this feature.**
- **Laws in some jurisdictions may restrict the use of some of the applications and features, such as social networking and texting. Check local regulations for any requirements.**

- **If you are unable to devote full attention to vehicle operation while using the text messaging feature, pull off the road to a safe location and stop your vehicle.**

CAUTION:

This feature is disabled if the connected device does not support it. See the phone's Owner's Manual for details and instructions.

The system allows for the sending and receiving of text messages through the

vehicle interface.

The availability of the text message function may vary depending on the cellular phone.

Receiving a message

AV1NJA1-21DB93A3-3B89-4A41-BD63-D9FB66E9ED45

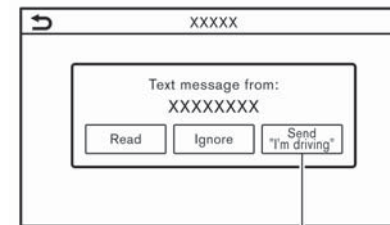

PBF0026X

When the cellular phone connected to the vehicle receives a text message, a notification will appear on the touch screen display with a tone. (Depending on the models, the notification will also appear on the vehicle information display.)

To check the message, touch [Read]. Touch [Ignore] to save the message to be checked later.

If you want to respond using a predefined message, touch the message for auto reply ①.

The text message for auto reply can be edited.

"Phone settings" (page 4-10)

4-6 Hands-Free Phone

Condition:

INFO:

- Depending on the cellular phone, the notification display setting may need to be activated on the cellular phone.
- Whether to read or ignore the message can be selected operating the switch on the steering wheel. Push < ⤵ > to read the message. Push and hold the switch to ignore the message.

Displaying received message list

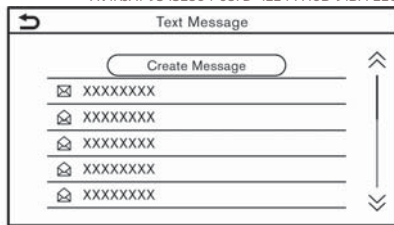

1. Touch [Phone] on the Launch Bar.
2. Touch [Text Message].
3. Touch an item on the list to read or reply to the message.

INFO:

- Up to 100 messages can be stored in the message list.
- Either of the connected phone devices can be selected for text message viewing operation when [Allow 2

Phones Simultaneously] is turned on. Touch "Bluetooth® settings" (page 2-12)

Received message screen



Example

Touching [Read] on the new message notification screen or selecting a message from the message list will show the details of the received message on the display.

Available actions:

- [Prev.]: Touch to read the previous message.
- [Next]: Touch to read the next message.
- [Play]/[Stop]: Touch [Play] to have the hands-free phone system read out the received message. Touch [Stop] to stop reading.
- [Call]: If the sender of the message is registered in the phonebook, touch this icon to make a call to the sender.

- [Reply]: A reply message can be selected from the template. Touch "Sending a text message" (page 4-8)

INFO:

- Push < ▲ >/< ▼ > on the steering wheel to read the previous or next message.
- Depending on the language setting, the "Text-to-Speech" function may not be available.
- Available keys may vary depending on the situations and models.
- If the sender's name and phone number are registered in the phonebook, the name of the sender is displayed when a message is received.
- To adjust the message reading voice volume, push < 🔊 > on the steering wheel or turn < VOL/ 🔊 >/< VOL/ 🔊 > on the control panel.

Sending a text message

AV1NJAI-2F6880B3-BAEC-469F-91B4-5465323E6184

This function may not be supported depending on the cellular phone.

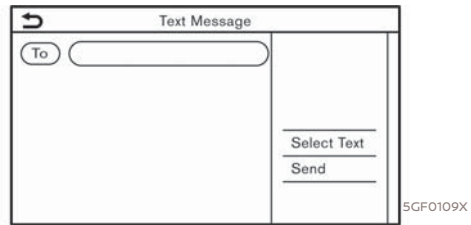

1. Touch [Phone] on the Launch Bar.
2. Touch [Text Message].
3. Touch [Create Message].

INFO:

Either of the connected phone devices can be selected for text message sending operation when [Allow 2 Phones Simultaneously] is turned on.

 ["Bluetooth® settings" \(page 2-12\)](#)

The following items are available.

Available item		Action
[To]	[Enter Number with Keypad]	Enter the phone number of the recipient using the keypad. Touch [OK] to confirm.
	[Quick Dial]	Select a recipient from the Quick Dial list.
	[Phone Book]	Select a recipient from the phonebook.
	[Call History]	Select a recipient/phone number from call history.

4-8 Hands-Free Phone

Condition:

[Edit: 2020/ 5/ 28 Model: AV1NJ-A]

[Select Text]	[Fixed]	Touch to display a list of fixed text messages.
	[Customised]	Touch to display a list of custom text message templates. Custom text can be created or edited from the setting menu. ☞ "Phone and text message settings" (page 4-10)
[Send]		Touch to send the message.



PHONE AND TEXT MESSAGE SETTINGS

AV1NJAI-1513E8E2-AF29-4D62-968F-3689E6A05889

Phone settings

AV1NJAI-13ACEB2-74B1-46EA-92C5-7C0462E956E7



Bluetooth® Hands-Free Phone System settings can be changed according to the user's preference.

Touch [Phone] on the setting menu screen.

 "System settings" (page 2-9).

Available setting items may vary depending on models, specifications and software versions.

Available setting items

Setting item		Action
[Connections]		Displays the Connections screen. Phone connection, selection, deletion and other features are available.  "Connections settings" (page 2-11)
[Quick Dial]	[Edit]	Entries in the Quick Dial can be edited. Touch [Add New] to register a new entry.  "Quick Dial" (page 4-12)
	[Delete All]	Deletes all of the phone numbers in the Quick Dial.
[Phone Book]	[Download Entire Phone Book]	All of the phone numbers that are stored in a phonebook of a cellular phone that is connected to the vehicle are downloaded at once.
	[Auto Download]	Turns on/off automatic downloading of the phonebook from the connected cellular phone.
	[Sort Phonebook by]	Changes the sorted order of contacts in the phonebook.
[Text Message]	[Text Message]	Turns the text messaging function on/off.
	[Text Message Ringtone]	Turns the incoming message sound on/off.
	[Signature]	Turns the signature setting for the outgoing text message on/off.
	[Auto Reply]	Turns on/off the automatic text message reply function.
	[Auto Reply Text Message]	Selects the text message to be used for the automatic reply function.
	[Edit Custom Text]	Creates or edits a customized text message reply.

4-10 Hands-Free Phone

Condition:

[Edit: 2020/ 5/ 28 Model: AV1NJ-A]

[Notifications]	[Driver Only]	When this item is turned on, incoming call notification is displayed only in the vehicle information display.
	[Ringtone]	Turns the vehicle ringtone on/off.
[Automatic Hold]		When this item is turned on, an incoming phone call will be put on hold automatically.

i INFO:

The setting of [Driver Only] is unavailable while Apple CarPlay (if equipped) or Android Auto (if equipped) is active.

Volume settings

AV1NJAI-144OFF88-223C-48E5-961F-4C0707FFD6FA

Volume settings can be adjusted.

1. Touch [Phone] on the Launch Bar.
2. Touch [Volume].

The following volume setting items are available.

Setting items	Action
[Ringtone]	Adjusts the volume level of the ringtone of incoming calls.
[Outgoing Call]	Adjusts the volume level of the outgoing calls.

i INFO:

The volume settings can also be accessed from the setting menu screen.

 ["System settings" \(page 2-9\)](#)

Quick Dial

AV1NJAI-0FB27751-B822-433A-977A-435B2430D290

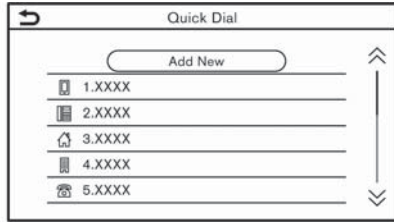

PBF0029X

Up to 20 Quick Dial entries can be registered.

Quick Dial entries can be used to quickly make a call or send text messages.

Registration:

1. Touch [Phone] on the Launch Bar.
2. Touch [Quick Dial].
3. Touch [Edit].
4. Touch [Add New] to register a phone number to the Quick Dial list.
5. Select a method for registration.

Available methods:

- [Copy from Call History]:
A phone number can be selected from [All], [Incoming], [Outgoing], or [Missed] call history lists.
- [Copy from Phone Book]:
A phone number can be selected from the phonebook.
- [Enter Number with Keypad]:
A phone number can be entered

4-12 Hands-Free Phone

manually using keypad.

INFO:

Available methods may vary depending on cellular phone support.

6. When a phone number has been selected, the registration screen is displayed. Enter the phone number and edit the entry information as necessary.
7. Touch [OK] to save the entry.

INFO:

- Quick Dial entries can also be registered from [Phone] on the setting menu screen.
☞ "Phone settings" (page 4-10)
- Either of the connected phone devices can be selected for dialing operation when [Allow 2 Phones Simultaneously] is turned on.
☞ "Bluetooth® settings" (page 2-12)

Voice Tag:

A voice tag can be recorded for each of the registered Quick Dial numbers and can be used to dial the number by speaking it.

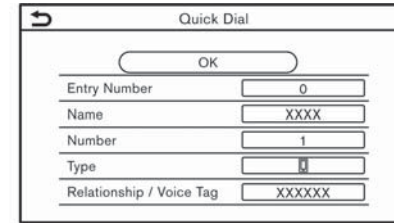

PBF0037X

On the Quick Dial registration screen, select [Relationship / Voice Tag].

- Select a preferred relationship from the list.
- Touch [Customise] and touch [Record] to register your original voice tag.

INFO:

- Touch [Play] to play the recorded voice tag.
- Touch [Delete] to delete the voice tag.

5 Information

- Information menu 5-2
- Apple CarPlay (if equipped) 5-3
 - Compatibility 5-3
 - Connecting iPhone 5-3
 - Apple CarPlay operation 5-4
 - Apple CarPlay settings 5-6
 - Apple CarPlay system limitations 5-7
- Android Auto™ (if equipped) 5-7
 - Compatibility 5-7
 - Initial Android Auto settings 5-8
 - Android Auto operation 5-8
 - Android Auto settings 5-9
 - Android Auto system limitations 5-10
- Siri Eyes Free (if equipped) 5-10
 - Requirements 5-10
 - Siri Eyes Free activation 5-10
 - Operating Siri Eyes Free 5-10



INFORMATION MENU

AV1NJA1-5E9B2C85-D229-414A-96FE-2A3389057A2B

The information screen sets or displays various information.

Push **<MENU>** and then touch [Info] on the Launch Bar to display the Information menu.

Available items may vary depending on models, specifications and software versions. Items displayed on the screen may not function depending on various conditions.

Menu item		Action
[Notifications]		Displays a list of notifications. ☞ "Swipe-down notifications" (page 2-7)
[Vehicle]	[ECO Drive Report]	Displays the ECO Drive Report screen.
[Where Am I?]		The name and distance of the next/previous street, and other information that indicates the current vehicle location are displayed. Latitude and longitude of the current vehicle location are shown on the bottom right.
[System Information]	[Version Information]	Displays the version information screen.
	[Map Update]	The map data can be updated. ☞ "How to update map data" (page 6-35)
	[Licence Information]	Displays the Open Source Software licenses information.
[GPS Position]		Displays Global Navigation Satellite System (GNSS) information, such as number of satellites, latitude/longitude, and approximate altitude, etc.
[Smartphone Connection]	[Apple CarPlay]	Displays the Apple CarPlay screen. ☞ "Apple CarPlay" (page 5-3)
	[Android Auto]	Displays the Android Auto screen. ☞ "Android Auto™" (page 5-7)

5-2 Information

Condition:

[Edit: 2020/ 5/ 28 Model: AV1NJ-A]

Apple CarPlay (if equipped)

AV1NJA1-2F4A0198-4EA3-402B-905C-8A97B30EE3C1



WARNING:

- **Stop your vehicle in a safe location and apply the parking brake before connecting your iPhone to the vehicle or operating your connected iPhone for setup.**
- **If you are unable to devote full attention to vehicle operation while using Apple CarPlay, pull off the road to a safe location and stop your vehicle.**

You can use Apple CarPlay by connecting a compatible iPhone to your vehicle via a USB cable or wirelessly (if equipped).

With Apple CarPlay, your in-vehicle system can be used as a display and a controller for some of the iPhone functions. Apple CarPlay features Siri which enables operations via voice controls. Visit apple.com for information about the functions that are available and details about Apple's privacy policy.

Certain vehicle information (e.g. location and speed) may be shared with your device while Apple CarPlay is in use. Carrier charges may apply to use Apple CarPlay.

COMPATIBILITY

AV1NJA1-57200BDF-E943-45F8-9ED1-7BFD321F3774

Refer to the Apple website for compatible devices.



INFO:

- In some countries, iPhone in the market may not be supported by Apple CarPlay.
- For best results, always update your device to the latest software version.
- Apple CarPlay will take the place of your Bluetooth® audio and Bluetooth® hands-free phone functionality.
- Phone menu and access to the connected phone through Voice Recognition System will be disabled while Apple CarPlay is connected. To access your phone, use the Siri function or select the phone icon in the Apple CarPlay top menu screen.
- If you set a route guidance destination with Apple CarPlay, the route setting previously set on NissanConnect navigation system (if equipped) will be canceled.

CONNECTING iPhone

GUID-5A19E5E1-AAA5-498F-A11D-B33846664001

This system supports wireless Apple CarPlay (if equipped). To connect Apple CarPlay wirelessly, the Bluetooth® and Wi-Fi network must be available with the in-vehicle system before operation.

["Setting devices" \(page 2-11\)](#)

["Wi-Fi setting" \(page 2-13\)](#)



INFO:

Depending on the device and firmware version of the iPhone, wireless Apple CarPlay (if equipped) cannot be used. Always update your device to the latest software version.

Connecting with the USB cable

GUID-95C22ED9-D8A4-45C6-81A6-D93D85B3207A



INFO:

To connect your iPhone with the in-vehicle system, it is recommended to use the Apple Lightning cable (Mfi certified) that was provided with your iPhone.

1. Connect the iPhone to the USB connection port.
 ["USB \(Universal Serial Bus\) connection port" \(page 3-3\)](#)
2. Depending on the setting, a Startup Information screen will appear. Touch [Yes] to use Apple CarPlay.
3. Apple CarPlay starts and the Apple CarPlay screen will appear.

Information 5-3

Condition:

[Edit: 2020/ 5/ 28 Model: AV1NJ-A]

- If a notification appears on the iPhone, select whether or not to use the wireless connection (if equipped). Once you enable wireless Apple CarPlay (if equipped) on the notification, Apple CarPlay will automatically start wirelessly from next time.

Connecting wirelessly (if equipped)

GUID-954039D7-4667-4110-BCD1-439DFFE1274E

- Connect the iPhone to the in-vehicle system via Bluetooth®.
 - ☞ "Setting devices" (page 2-11)

INFO:

If no Bluetooth® device is connected and Apple CarPlay or Android Auto is not active, pushing and holding  on the steering wheel can display the Connections screen.

- Depending on the setting, a Startup Information screen will appear. Touch [Yes] to use Apple CarPlay.
- A notification will appear on the iPhone. Select to use the wireless connection.

INFO:

If you select not to use the wireless connection, the iPhone will be connected as a Bluetooth® device.

- Wireless Apple CarPlay will start and the Apple CarPlay screen will appear.

5-4 Information

Condition:

INFO:

If the Wi-Fi connection is off on the Wi-Fi setting screen, a notification will appear. Touch [Yes] to use wireless Apple CarPlay.

- ☞ "Wi-Fi setting" (page 2-13)

Operating tips

GUID-AA795079-7EE7-466A-BB41-4D70D15974AA

- If you do not wish to display the Startup Information screen each time you activate Apple CarPlay, turn on [Don't Ask Any More] on the Startup Information screen. The Startup Information screen will not be displayed from the next Apple CarPlay activation. The Startup Information screen can be set to appear again in the Apple CarPlay setting menu.
 - ☞ "Apple CarPlay settings" (page 5-6)
- The map update will be stopped while using wireless Apple CarPlay (if equipped).
- The connection with the other Bluetooth® device may be disconnected when wireless Apple CarPlay (if equipped) is activated.
- Once the wireless connection (if equipped) has been established, Apple CarPlay will be automatically connected wirelessly next time.
- Wireless Apple CarPlay (if equipped) uses the Wi-Fi network. After connecting the in-vehicle system to the Wi-Fi network, the Bluetooth® connection

with wireless Apple CarPlay (if equipped) connected device will be disconnected.

- If you connect the iPhone that is using wireless Apple CarPlay (if equipped) via USB cable, the in-vehicle system provides power to the iPhone.
- If wireless Apple CarPlay (if equipped) does not start automatically, touch  on the device settings screen.
 - ☞ "Setting devices" (page 2-11)
- If you are using Apple CarPlay or Android Auto, you cannot start Apple CarPlay with the other iPhone. To use Apple CarPlay with the other iPhone, disconnect the current device, or deactivate Apple CarPlay or Android Auto on the Connections settings.
 - ☞ "Connections settings" (page 2-11)

Apple CarPlay OPERATION

AV1NJAI-A682AF5E-1560-4F44-8560-DO4EE0074E05

After starting Apple CarPlay, the iPhone functions displayed on the screen can be operated using the in-vehicle system.

After exiting the Apple CarPlay screen, return to the Apple CarPlay by touching  on the Launch Bar.

INFO:

When your iPhone is locked, Apple CarPlay can still be activated by operating the iPhone and allowing Apple CarPlay activation.

Siri operation

AV1NJ1-016CA560-9A82-4480-ACFF-C212BEB65587

With Siri, some of the functions in your iPhone can be voice controlled.

Make sure that Siri on your iPhone is turned on.

Activation:

Push and hold <  > on the steering wheel to start a Siri session.



- Push <  > to end Siri operation.
- Keep the interior of the vehicle as quiet as possible. Close the windows to eliminate the surrounding noises (traffic noises, vibration sounds, etc.), which may prevent the system from recognizing the voice commands correctly.
- For functions that can be used with Siri, please refer to the Apple website.

Phone operation

AV1NJ1-CA86E5DA-1E0E-4802-B5B9-38BE555174E6

If you wish to use the phone with Apple CarPlay, follow the procedure below:

1. Touch [Phone] on the Apple CarPlay top menu.
2. Operate the screen displayed to make a call, etc.

Apple CarPlay SETTINGS

AV1NJAI-65850203-ZBC2-4381-947B-B8A88B6EF111

1. Push **<MENU>**.
2. Touch [Connections] on the Launch Bar and then touch [Devices].
3. Touch  by the iPhone name you wish to change the settings.
4. Touch [Smartphone Projection].

Available items:

Available setting items may vary depending on models, specifications and software versions.

Setting item 1	Setting item 2	Action
[Start-up Options]	[Auto]	Activates Apple CarPlay automatically when an iPhone is connected to the in-vehicle system.
	[Ask Every Time]	Displays the Apple CarPlay Startup Information screen when an iPhone is connected to the in-vehicle system.
	[Never Start]	Apple CarPlay will not activate even if an iPhone is connected to the in-vehicle system.
[Nissan's Help for Apple CarPlay]		Displays helpful tips for Apple CarPlay operation.

INFO:

Access to songs on your iPod via in-vehicle voice recognition system will not be available when connected to Apple CarPlay. To access to your iPod music, use the Siri function or select the music icon in the Apple CarPlay top menu screen.

5-6 Information

Condition:

[Edit: 2020/ 5/ 28 Model: AV1NJ-A]

Android Auto™ (if equipped)

AV1NJA1-412822B5-2ED1-4B16-AFE8-C7987322F2B9

Apple CarPlay SYSTEM LIMITATIONS

AV1NJA1-DE810B65-32DE-4575-96BD-BF2007415096

For all features of Apple CarPlay to operate correctly, it is necessary to have a compatible iPhone, a cellular connection and a data plan.

When Apple CarPlay is operating, system performance is affected by the strength of the cellular connection or performance of the phone itself. If performance of the system decreases:

- Disconnect and reconnect your phone
- Cycle phone power off/on to restart

Changing government regulations may also affect operation of Apple CarPlay.



WARNING:

- **Stop your vehicle in a safe location and apply the parking brake before connecting your Android™ phone to the vehicle or operating your connected Android phone for setup.**
- **If you are unable to devote full attention to vehicle operation while using Android Auto, pull off the road to a safe location and stop your vehicle.**

You can use Android Auto by connecting a compatible Android phone to your vehicle via a USB cable. It is also recommended to use the Android phone OEM cable that was provided with your phone.

With Android Auto, your in-vehicle system can be used as a display and a controller for some of the Android phone functions. Voice control of some of the Android phone functions is also possible with Android Auto. Visit www.android.com/auto for information about the functions that are available and details about Google's privacy policy.

Certain vehicle information (e.g. location and speed) may be shared with your device while Android Auto is in use. Carrier charges may apply to use Android Auto.

COMPATIBILITY

AV1NJA1-182297CC-D302-4CCC-ABC9-9C0A51082A34

Refer to the Android Auto website for compatible devices.



INFO:

- In some countries, Android phone in the market may not be supported by Android Auto.
- Download the Android Auto App from Google Play™ to Android phone in advance.
- For best results, always update your device to the latest Android software and Android Auto App version. When you connect the Android phone to the in-vehicle system, it will automatically update the Android software and Android Auto App version.
- Android Auto will take the place of your Bluetooth® audio and Bluetooth® hands-free phone functionality.
- When setting a route with the navigation system (if equipped), if you set a destination with Android Auto, the route setting of the navigation system will be cancelled.
- The Phone menu and access to the connected phone through the Voice Recognition System will be disabled while Android Auto is connected. To access your phone, talk to your Goo-

gle Assistant or select the phone icon in the Android Auto top menu screen.

INITIAL Android Auto SETTINGS

AV1NJAI-52E7591D-B45F-4A36-9262-329DFD5AAAF96

Before using Android Auto, the Android Auto App must be downloaded on your Android phone.

Download the Android Auto App from the Google Play store on your Android phone. It may be necessary to operate the Android phone when connected first.

Depending on the selection, such as approval, some of the features of Android Auto are not available.

Android Auto OPERATION

AV1NJAI-D0FCADBE-7B14-4C0C-9561-B2096C501B47

Unlock your phone's screen before connecting your Android phone.

1. Connect your Android phone to USB connection port.
 "USB (Universal Serial Bus) connection ports" (page 2-5)
2. Depending on the setting, a Startup Information screen will appear. Touch [Yes] to use Android Auto.

INFO:

- If you do not wish to display the Startup Information screen each time you activate Android Auto, turn on [Don't Ask Any More] on the Startup Information screen. The Startup Information screen will not be displayed from the next Android

5-8 Information

Auto activation. The Startup Information screen can be set to appear again in the Android Auto setting menu.

 "Android Auto settings" (page 5-9)

- Your phone's Bluetooth® will be turned on automatically when Android Auto is activated. Keep the Bluetooth® turned on to use the phone functions.
 - Some functions of Android Auto are not available if the Bluetooth® is not connected.
3. The Android Auto top menu screen will appear. The Android phone functions displayed on the screen should now be operable using the in-vehicle system.

INFO:

- While Android Auto is activated on the Android phone, the phone operations, such as making or receiving calls, can only be done with Android Auto.
- Depending on the device, an Android phone requires MTP mode to be selected in the USB transfer setting.
- After exiting the Android Auto screen, return to the Android Auto screen by taking one of the following actions.

- Touch  on the Launch Bar.
- Touch [Smartphone Connection] on the information screen, and then touch [Android Auto].



Google Assistant™ operation

AV1NJAI-AD68865B-24C2-483F-BD02-E7D3E5384D38

Some of the functions on your Android phone can be voice controlled when Android Auto is active.

Activation:

Perform one of the following operations to start a Google Assistant session.

- Push and hold <  > on the steering wheel.
- Touch  on the Android Auto screen.

INFO:

- Push <  > to end voice operation.
- Keep the interior of the vehicle as quiet as possible. Close the windows to eliminate the surrounding noises (traffic noises, vibration sounds, etc.), which may prevent the system from recognizing the voice commands correctly.
- For functions that can be used with the voice operation, refer to www.android.com/auto.

Phone operation

AV1NJJA1-EFF4E878-069B-4A3E-96E6-19701CFCD403

If you wish to use your phone while Android Auto is activated, follow the procedure below:

1. Touch [] on the Android Auto screen.
2. Operate the screen displayed to make a call, etc.

Android Auto SETTINGS

AV1NJJA1-EC243861-E1D2-4256-996B-13627A0E5F53

1. Push **<MENU>**.
2. Touch [Connections] on the Launch Bar and then touch [Devices].
3. Touch [] by the Android phone name you wish to change the settings.
4. Touch [Smartphone Projection].

Available items:

Available setting items may vary depending on models, specifications and software versions.

Setting item 1	Setting item 2	Action
[Start-up Options]	[Auto]	Activates Android Auto automatically when an Android phone is connected to the in-vehicle system.
	[Ask Every Time]	Displays the Android Auto Startup Information screen when an Android phone is connected to the in-vehicle system.
	[Never Start]	Android Auto will not activate even if an Android phone is connected to the in-vehicle system.
[Nissan's Help for Android Auto]		Displays helpful tips for Android Auto operation.

Android Auto SYSTEM LIMITATIONS

For all features of Android Auto to operate correctly, it is necessary to have a compatible Android phone, a cellular connection and a data plan.

When Android Auto is operating, system performance is affected by the strength of the cellular connection or performance of the phone itself. If performance of the system decreases:

- Disconnect and reconnect your phone
- Close all apps and restart them
- Cycle phone power off/on to restart

It should also be confirmed that the latest version of both Android OS and the Android Auto App are installed on the cellular phone.

Functionality of Android Auto may decrease or be lost if there are changes to operating systems, hardware, software or other technologies central to supporting the system that are outside of NISSAN's control. Changing government regulations may also affect the operation of Android Auto.

Siri Eyes Free (if equipped)

Apple Siri Eyes Free personal assistant can be accessed from the vehicle. Siri Eyes Free can be accessed in Siri Eyes Free mode to reduce user distraction. In this mode, Siri Eyes Free is available for interaction by voice control. After connecting a compatible Apple device via Bluetooth®, Siri Eyes Free can be activated by using <  > on the steering wheel.

Siri is a trademark of Apple Inc., registered in the U.S. and other countries.



INFO:

- Some Siri Eyes Free functions, such as opening apps, may not be available during driving.
- For best results, always update your device to the latest software version.
- Keep the interior of the vehicle as quiet as possible. Close the windows to eliminate the surrounding noises (traffic noises, vibration sounds, etc.), which may prevent the system from recognizing the voice commands correctly.
- For functions that can be used in Siri Eyes Free, please refer to the Apple website.

REQUIREMENTS



Visit Apple's website for details about device compatibility.

Siri must be enabled on the phone. Please check phone settings.

If the device has a lock screen, Siri must be accessible from the lock screen. Please check phone settings.

Siri Eyes Free ACTIVATION

Siri Eyes Free function can be activated using <  > on the steering wheel.

1. Connect a Siri Eyes Free enabled iPhone to the vehicle.
 "Setting devices" (page 2-11)
2. After the Bluetooth® connection is established, push and hold <  > on the steering wheel to activate the Siri Eyes Free function.

OPERATING Siri Eyes Free

1. Push and hold <  > on the steering wheel.
2. Speak your command and then listen to the Siri Eyes Free reply.

After starting Siri Eyes Free, push <  > on the steering wheel again within five seconds of the end of the Siri Eyes Free announcement to extend the session.

5-10 Information

Condition:

[Edit: 2020/ 5/ 28 Model: AV1NJ-A]

6 Navigation (if equipped)

Safety information	6-2	General information for navigation system	6-30
Navigation screen	6-2	Current vehicle location	6-30
Displaying navigation screen	6-2	Route calculation	6-33
Launch Bar	6-2	Route guidance	6-34
Map operation	6-3	How to update map data	6-35
Map types	6-3		
Road color	6-6		
Moving map	6-6		
Changing scale of map	6-6		
Map settings	6-7		
Map Menu screen	6-10		
Setting destination	6-10		
Basic operations	6-10		
Options before starting the route guidance	6-12		
Route guidance	6-12		
About route guidance	6-12		
Route menu	6-13		
Route Preference	6-16		
Recalculating route	6-18		
Editing route	6-18		
Guidance settings	6-20		
Storing a location/route	6-21		
Storing location	6-21		
Storing route	6-22		
Storing avoid area	6-22		
Editing stored information	6-23		
Deleting stored item	6-26		
Navigation settings	6-28		

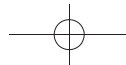

SAFETY INFORMATION

AV1NJ1A1-86E86BA3-BF7E-40C4-BA2C-BCE97C60A7D2

The navigation system is primarily designed to help you reach your destination. However, you, the driver, must use the system safely and properly. Information concerning road conditions, traffic signs and the availability of services may not always be up to date. The system is not a substitute for safe, proper, and legal driving.

WARNING:

Do not rely on route guidance alone. Always be sure that all driving maneuvers are legal and safe in order to avoid accidents.

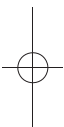

NAVIGATION SCREEN

AV1NJ1A1-C5FCA318-4BBA-4D15-A857-9B542ACCC9A3

DISPLAYING NAVIGATION SCREEN

AV1NJ1A1-D8AC00A2-1C2D-4A70-9906-9AEEE4DB75F8

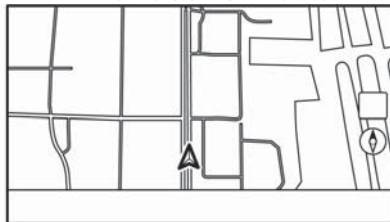

5GB0760X

Before setting the destination

To display the current location map which can be operated, push **<MENU>** and then touch [Map] on the Launch Bar or push **<MAP>**.

LAUNCH BAR

AV1NJ1A1-D5D4DD54-609E-45E6-8000-80EE515CBEAF

The Launch Bar related to operating the navigation system is displayed on the current location map screen. Displayed items vary depending on the route settings.



5GB0762X

After setting the destination

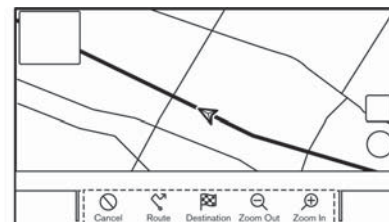

5GB0761X

After setting the destination

Menu item	Action
[Add Home]/ [Go Home]	[Add Home]: When the home location is not stored, a home location can be stored in the system. "Storing home or work location" (page 6-21) [Go Home]: When the home location is stored, sets the home location as a destination.
[POI]	Searches for a Points of Interest to set as a destination.
[Destination]	Displays the destination menu. "Setting destination" (page 6-10)
[Zoom Out]	Zoom out the map. "Changing scale of map" (page 6-6)
[Zoom In]	Zoom in the map. "Changing scale of map" (page 6-6)

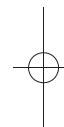

6-2 Navigation (if equipped)

Condition:

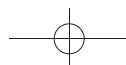

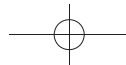

MAP OPERATION

AV1NJA1-D4FC98C8-FC44-47CD-AB7C-DFB95B4C855A

MAP TYPES

AV1NJA1-8F144229-3732-40A7-BB7E-81F06E4649A2

Two types of map views are available: 2D and 3D.

2D map

AV1NJA1-6195AF2E-E3F1-4B35-A541-FFCD4075A511

The 2D map displays the map in a two-dimensional environment similar to a road map.

[Cancel]	Cancels the route guidance.
[Route]	Displays the route menu screen.  "Route menu" (page 6-13)

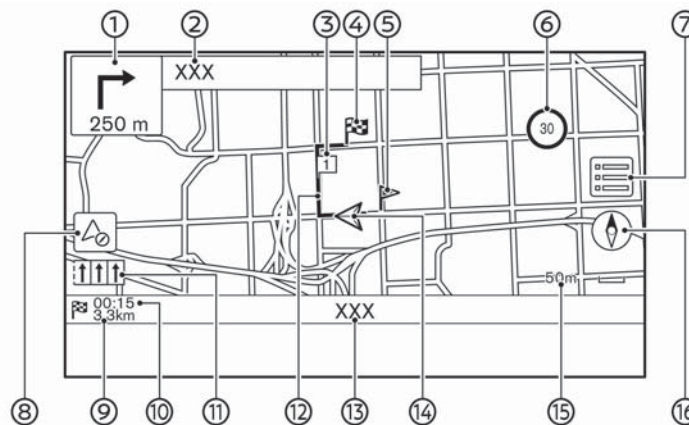

Example

PBB0109X

The location of the displayed icons and information may vary depending on models, specifications and software versions.

Screen information:

- ①  Arrow and distance:
Indicates the distance to the next guide point and the turning direction at that guide point.
If the current vehicle position is off the road, an arrow indicating the

direction to the nearest road may be displayed instead of displaying the next turn arrow/distance.

- ② Next street name:
Displays the next street name during the route guidance.
- ③  Waypoint:
Displays the location of the waypoint that the vehicle will stop by before heading to the final destination. A maximum of 20 waypoints can be set.

Navigation (if equipped) 6-3

Condition:

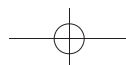

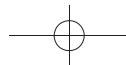

- ④ Destination:
Indicates the location of the final destination.
- ⑤ Stored location:
Displays the locations that are stored in the Address Book.
 "Storing location" (page 6-21)
The icons can be changed according to your preferences.
- ⑥ Speed limit indicator:
Displays the speed limit of the road which the vehicle is on.
When the vehicle speed exceeds the limit, the indicator flashes.
The settings for the speed limit indicator can be changed.
 "Navigation settings" (page 6-28)
- ⑦ :
Touch to display the Map Menu.
 "Map Menu screen" (page 6-10)
- ⑧ (if equipped):
Touch to display the compass mode display.
 "Compass mode display" (page 6-5)
- ⑨ Remaining distance to the destination:
Indicates the approximate remaining distance to the destination or the waypoint. This indicator will appear when a destination is set and route

- guidance is started.
- ⑩ Remaining time/Time of arrival:
Indicates the remaining time to the destination/waypoint, or it can be set to display the estimated arrival time. This indicator will appear when a destination is set and the route guidance is started.
The remaining time or arrival time display can be selected to your preference.
 "Route Preference" (page 6-16)
- ⑪ Recommended lane indicator:
When a route is set, the arrow and the recommended driving lane may be displayed depending on the road.
Blue: Recommended
Gray: Not recommended
- ⑫ Suggested route:
Appears in bold blue during route guidance.
- ⑬ Street name:
Displays the name of the street that the vehicle is currently driving on.
- ⑭ Vehicle icon:
Indicates the current vehicle location and the direction that the vehicle is heading.
- ⑮ Scale indicator:
Indicates the scale of the map.

- ⑯ :
Indicates the directional setting of the map.
Touch to change the map view and the map orientation.

3D map AV1NJ-A1-C63CE7A8-5F3A-43AB-9739-240E40D6FC71
The 3D map displays the map from an elevated perspective. In 3D map, it is easy to recognize an image of the route because it provides a panoramic view over a long distance.

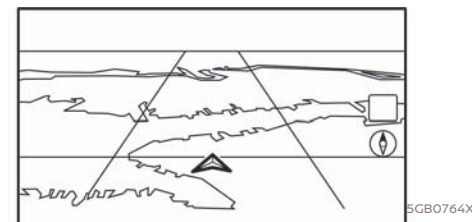

INFO:
The 3D map always appears with the current forward direction facing up.

6-4 Navigation (if equipped)

Condition:

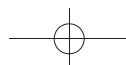

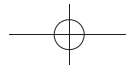

Building graphics

AV1NJ-A-1-D52D68EF-B8E2-45F4-A665-3D4F393E1605

Building graphics are stored in the map data for certain areas, and can be displayed when the map is zoomed in.

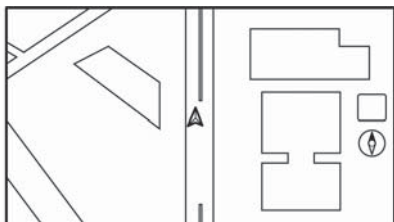

5GB0765X

2D building graphics

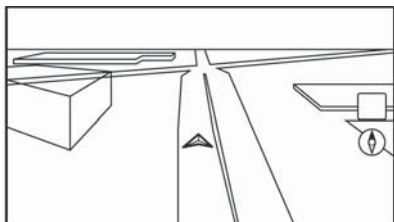

5GB0831X

3D building graphics

INFO:

In an area where the building graphics are not stored in the map data, the normal map is displayed even when the map is zoomed in.

Compass mode display (if equipped)

AV1NJ-A1-4184597B-FE28-4BEB-890D-BDA3118AB6FD

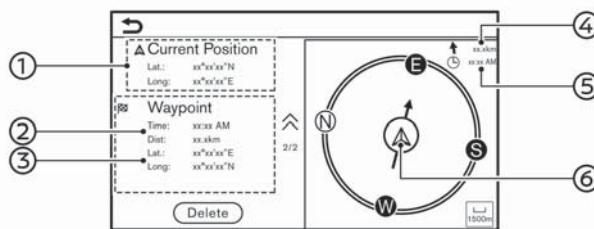

The compass mode can be useful in areas such as deserts where there are no roads or where the area information is not included in the map data. This mode helps the driver to get to the destination by showing the current vehicle location at the center of the map.

Touch  on the map screen to switch to the compass mode screen.

- ① Latitude/longitude of current location
- ② Estimated time of arrival and distance to waypoint/destination
- ③ Latitude/longitude of waypoint/destination
- ④ Direction and straight distance to the destination
- ⑤ Estimated time of arrival at the destination

- ⑥ Current vehicle location and the direction to waypoint/destination

If no destination has been set, only the latitude and longitude of the current location are displayed.

INFO:

- When the compass mode is active, route guidance will not be provided.
- Touch [Delete] to delete the information of waypoint/destination. Once deleted, the deleted information cannot be displayed again.
- Details of this function are subject to change.

Navigation (if equipped) 6-5

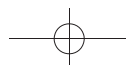

ROAD COLOR

AV1NJJA1-16035A1E-B7A3-449E-857D-82CE718C0B3B

The road types are differentiated by color.

Color	Road type
Yellow and red outline	Motorway
Red or orange	Main road
Yellow or white	Narrow street

MOVING MAP

AV1NJJA1-7786F4B5-D56C-4754-9A7C-B9979A7906F1

The map can be scrolled by the touch panel operations. Map scrolling operations may be limited while driving.

Touch:

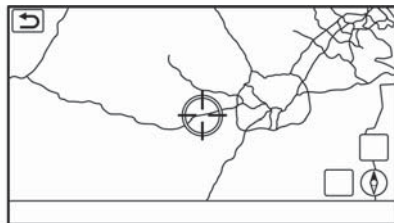

5GB0707X

When a point on the map is touched, the cross pointer is displayed and the position touched is moved to the center of the screen.

After moving the map, touch [↶] on the map screen or push <MAP> to display the current location map screen.

Long touch:

Touch the direction to move to. The map continues to scroll while the screen is touched.

Drag:

Drag the screen to scroll the map.

Swipe/flick:

Swipe or flick the screen to scroll the map screen quickly.

CHANGING SCALE OF MAP

AV1NJJA1-9DD1AE71-61BA-4F81-A0EB-6A8BF290FBF9

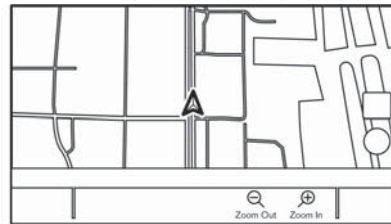

5GB0767X

To change the map scale, touch [Zoom Out] or [Zoom In] on the Launch Bar.

Other operations:

- While the cross pointer is displayed, the scale bar can be displayed by touching the scale indicator on the map. Touching [⊖] or [⊕] on the scale bar can change the map scale while the scale bar is displayed.
- Rotating <⌂> /PUSH SOUND> can also change the map scale.

- While the cross pointer is displayed, pinching in or out with your fingers on the map screen can also change the map scale.

Free Zoom:

Rotating <⌂> /PUSH SOUND> to change the map scale may adjust the scale normally, or it may engage the free zoom (finer scale adjustment in smaller steps).

☞ "Map settings" (page 6-7)

INFO:

While driving, pinch-in and pinch-out operations may be disabled.

6-6 Navigation (if equipped)

Condition:

MAP SETTINGS

AV1NJ-A1-1F6AA0DC-5FB8-4E2E-9C33-C843D820D840

The setup for the map view is performed from the Map Menu on the touch screen display.

1. Touch  on the current location map screen.
2. Touch [Map Settings].

Available setting items may vary depending on models, specifications and software versions.

Menu item		Action
[Dual Map View]	[2D Map]	Displays 2D map.
	[Split: 2D Map]	Displays 2D map on both left and right side of the split screen. You can see the different scale and settings of 2D maps at the same time.
	[3D Map]	Displays 3D map.
	[Split: 3D Map]	Displays 2D map on the left side and 3D map on the right side of the split screen.
[Left Side Info]	[Intersection]	Displays the enlarged view of the next intersection on the left side of the screen during route guidance.
	[Turn List]	Displays the turn list on the left side of the screen when a route is set.
	[Drive Report]	Displays your eco drive report on the left side of the screen.
	[Full Map]	Displays full map screen.
[Map Icons]		Select the categories of POI icons to display on the map screen.
[More Settings]	[Map Orientation]	The map orientation can be selected from [North Up] or [Heading Up]. [Map Orientation] is available only when 2D map is displayed.
	[Long Range]	The position of the vehicle icon is located slightly lower than the center of the screen to view a wider area in the traveling direction. Long Range is available only when the map view is in [Heading Up] mode.

Menu item		Action	
	[Left Split Map Settings]	[Map Orientation]	The map orientation for the left side of split screen can be selected from [North Up] or [Heading Up].
		[Long Range]	With this item turned on, the vehicle position icon on the left screen will be located slightly lower than the center of the screen so that a wider area in the traveling direction can be viewed. Long Range Map View is available only when the left side of split screen is in [Heading Up] mode.
		[Map Scale]	Sets the map scale of the left screen.
	[Audio Display on Map]		Turns on/off the audio information displayed at the top of the map screen.
	[Map Colour]		Sets map color from [Standard], [Emphasise Roads] and [Emphasise Text].
	[Map Text Size]	[Large]	Sets the font size of the text displayed on the map screen.
		[Medium]	
		[Small]	
	[Select Text to Display on Map]	[Place Names]	Allows place, facility and road names to be displayed on the map screen.
	[Facility Names]		
	[Road Names]		
[Map Scrolling Information]		Information about the location, on which the center of the cross pointer is placed by scrolling on the map, can be set to be displayed.	

6-8 Navigation (if equipped)

Condition:

[Edit: 2020/ 5/ 28 Model: AV1NJ-A]

(73,1)

Menu item		Action	
	[Tracking Dots Displayed on Map]	[Record & Show Tracking Dots on Map]	Turns the route tracking dots display on/off.
		[Tracking Dot Distance]	Select the interval between tracking dots.
		[Delete Track to Current Location]	Deletes the route tracking dots up to the current location.
	[Small Step Zoom with Dial]		Sets the free zoom function on/off. When this setting is on, it is possible to adjust the scale in smaller steps than with normal scale adjustment.
	[Show all M-way Exits on Route]		Turns on/off the motorway exit information display.
	[Auto. Show Turn List on M-way]		The turn list can be displayed automatically while driving on a motorway.
[North Up when Zoomed Out]		When this setting is turned on, the orientation of the map is automatically changed to [North Up] when the widest map scale is selected.	
[Back to Map]		Back to the current location map.	

Navigation (if equipped) 6-9

Condition:

[Edit: 2020/ 5/ 28 Model: AV1NJ-A]

MAP MENU SCREEN

Touch  while the current location map screen or a scrolled map screen is displayed to display the menu corresponding to that screen.

This menu can be used to quickly access helpful functions, such as setting a destination or searching for points of interest nearby.

SETTING DESTINATION

AV1NJJA1-501A39C4-2FAD-451F-B110-26D6B2F785A4

The system can provide route guidance once a destination is set.

BASIC OPERATIONS

AV1NJJA1-F50ACAED-A068-494D-AA64-CD603677AFC9

Displaying destination setting menu

AV1NJJA1-B2EBC8BC-3B61-48B8-A7CB-A84B9994A079

There are several methods that can be used to set a destination. Select a preferred method for finding and setting a destination.

Push **<MAP>** and then touch [Destination] on the Launch Bar.

Availability of the destination setting methods varies depending on the models, specifications and software versions. Items displayed on the screen may not function depending on various conditions.

6-10 Navigation (if equipped)

Condition:

[Edit: 2020/ 5/ 28 Model: AV1NJ-A]



Available destination setting methods:

Setting item	Action
[Enter POI / Address]	Searches for a destination by inputting the address or POI names.
[Go Home]	Searches for a route from the current location to the previously stored home location.
[Street Address]	Searches for a destination by address.
[Points of Interest]	Searches for a destination from various categories.
[Address Book]	Searches for a destination from the vehicle Address Book.
[Previous Destinations]	Searches for the destination from the previous destinations and a previous start point.
[Go to Work]	Searches for a route from the current location to the previously stored work location.
[Phone Number]	Searches for a point of interest by a phone number.
[Saved Routes]	Sets a route from the saved route data.
[By Map]	Searches for a destination by map.
[Latitude/Longitude]	Sets a destination from latitude and longitude.

! NOTE:**Notice for Point of Interest search:**

Locations and business hours of facilities are subject to change, which may not be reflected in the map data. Double-check this information before you go to an emergency facility to ensure that you can receive the proper support. Otherwise, you may not receive emergency help when you arrive at the destination. A confirmation message also appears on the navigation screen. Follow the displayed instructions and check the items required.

i INFO:

- After setting a destination, the location of the destination can be adjusted and the location can be stored in the Address Book, etc.
 ["Options before starting the route guidance" \(page 6-12\)](#)
- The destinations can be canceled and edited/added.
 ["Route menu" \(page 6-13\)](#)

OPTIONS BEFORE STARTING THE ROUTE GUIDANCE

AV1NJAJ-E83C964B-BC32-48FB-AF85-60942AFE2170

Before starting the route guidance, select menus for route details to modify the route, preview the turn list, or store the route.

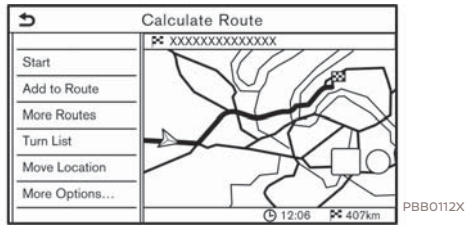

- [Start]: Starts route guidance to the selected destination.
- [Add to Route]: Adds a location to the route previously set.
- [More Routes]: Suggests alternative routes.

INFO:

Touch [1 Type] to display alternative routes calculated with a route search condition selected on the [Basic Route Type] setting screen.

 "Route Preference" (page 6-16)

Touch [3 Types] to display alternative routes calculated in all three route search conditions ([Fastest], [ECO] and [Short-

est]).

- [Turn List]: Displays a detailed turn list. The map can be displayed and the turn can be avoided by touching a turning point.
- [Move Location]: Displays a map screen and allows the location of the destination to be adjusted.
- [More Options...]: Option such as viewing place information and saving locations/routes can be selected.

ROUTE GUIDANCE

AV1NJAJ-FD38A9D2-BD38-4915-90E1-EFF73D4DAEA9

ABOUT ROUTE GUIDANCE

AV1NJAJ-FD5538DC-DAD3-4D25-9388-EEEE98B01107

After setting the route, select [Start] to start the route guidance.

During route guidance, the system navigates you through the guide points using visual and voice guidance.

WARNING:

- The navigation system's visual and voice guidance is for reference purposes only. The contents of the guidance may be inappropriate depending on the situation.
- Follow all traffic regulations when driving along the suggested route (e.g., one-way traffic).
 "Route guidance" (page 6-34)

Voice guidance during route guidance

AV1NJAJ-B9542D5E-9818-4B43-8BA0-4E1F33E37BDB

Basics of voice guidance:

Voice guidance announces which direction to turn when approaching an intersection for which a turn is necessary.

INFO:

- There may be some cases in which voice guidance and actual road conditions do not correspond. This may occur because of discrepancies between the actual road and the infor-

6-12 Navigation (if equipped)

Condition:

mation on the map data, or may also be due to the vehicle speed.

- In case voice guidance does not correspond to the actual road conditions, follow the information obtained from traffic signs or notices on the road.
- When approaching a guide point (intersection or corner) or destination/waypoint during route guidance, voice guidance announces the remaining distance and/or turning direction. Push and hold **<MAP>** to repeat voice guidance.

ROUTE MENU

AV1NJ-A1-A1C01E8A-570A-408B-B0D8-CEBD91E269C3



WARNING:

Always stop the vehicle in a safe location before modifying the route conditions. Modifying the route conditions while driving may cause an accident.

During route guidance, the route conditions can be modified and the route information can be confirmed. Set route conditions according to your personal preference.

Push **<MAP>** when a destination is set, and then touch [Route] on the Launch Bar.

The route menu screen is displayed.

Available settings

Menu item		Result
[Cancel Route]		Cancels the current route guidance.
[Turn List]		Displays the details of the suggested route.
[Detour]		A detour of a specified distance can be calculated.
[Route Preference]		Set the route search conditions.
[Recalculate]		Manually search for the route again after changing the search conditions, etc. and have the system calculate a route.
[Show Destination]	[Move Location]	Displays a map screen and allows the location of the destination to be adjusted.
	[Nearby POIs]	Search for points of interest near the destination, such as restaurants and gas stations, etc. The location can be set as a destination or a waypoint.
	[Save Location]	Save the destination in the Address Book.
[Edit/Add to Route]		A destination or waypoint can be edited/added to a route that has already been set.
[Guidance Settings]		Various guidance settings can be customized.
[Save Route]		The current route (a destination and waypoints) can be saved. A maximum of 10 routes can be saved. The saved routes can easily be recalled for future use. Saved route includes only the location information, not the route itself. Route may vary depending on various conditions.
[Map Scroll]		Displays the current map screen which can be scrolled to confirm the location of the destination, waypoints, route, etc.

6-14 Navigation (if equipped)

Condition:

[Edit: 2020/ 5/ 28 Model: AV1NJ-A]

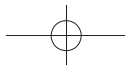

[Simulation]	<p>Simulates the route guidance. This function provides a detailed image of the route with voice guidance.</p> <p>The following operations are available:</p> <p>[]: Pauses the simulation.</p> <p>[▶]: Resumes the simulation.</p> <p>[■]: Ends the simulation.</p> <p>[⏩]: Increases the play speed.</p> <p>[⏪]: Decrease the play speed.</p>
--------------	---

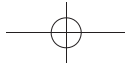
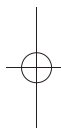
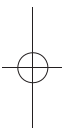

ROUTE PREFERENCE

AV1NJ1-126160A4-D2D4-4B8A-8C2C-7E583DEBCA04

It is possible to set the conditions of the route search.

1. Touch [Navigation] on the setting menu screen.
 ["System settings" \(page 2-9\)](#)
2. Touch [Route Preference].
3. Touch the item you would like to set.

Available items may vary depending on models, specifications and software versions.

Setting Item		Action	
[Basic Route Type]	[Fastest Route]	Prioritizes the use of fastest route.	
	[ECO]	Prioritizes a route which uses less energy.	
	[Shortest Distance]	Prioritizes the shortest route. The route may not be the shortest because the system prioritizes roads that are easy to drive on for safety reasons.	
[Other Routing Choices]	[Minimise Motorways]	Minimizes the use of motorways.	
	[Minimise Toll Roads]	Minimizes the use of toll roads.	
	[Time Restricted Roads]	[Use Restriction Info]	Calculates route taking time restriction information into consideration.
		[Do Not Use Restriction Info]	Calculates route without taking time restriction information into consideration.
		[Avoid]	Calculates route avoiding the use of time restricted roads.
	[Seasonal Restricted Roads]	[Use Restriction Info]	Calculates route taking seasonal restriction information into consideration.
		[Do Not Use Restriction Info]	Calculates route without taking seasonal restriction information into consideration.
		[Avoid]	Calculates route avoiding the use of seasonal restricted roads.

6-16 Navigation (if equipped)

Condition:

[Edit: 2020/ 5/ 28 Model: AV1NJ-A]

	[Use Avoid Area Settings]	When enabled, the system avoids the previously defined avoid areas.
	[Use Ferries]	Includes the use of ferries.
	[Use Unpaved Roads]	Includes the use of unpaved roads.
	[Use Learned Routes]	Uses the roads that are most frequently traveled with the help of self-learning technology.
[Customise More Routes]	[3 Types]	Calculates 3 types of route when confirming other routes.
	[1 Type]	Calculates routes with a route search condition selected on the [Basic Route Type] setting screen. ▶ "Route Preference" (page 6-16)
[Estimated Time]	[Destination]	Displays the estimated time of arrival or remaining time to the destination during route guidance.
	[Waypoint]	Displays the estimated time of arrival or remaining time to the waypoint during the route guidance.
[Time Shown on Map]	[ETA]	Displays the estimated time of arrival.
	[Remaining]	Displays the remaining time to arrival.

 **INFO:**

- [Route Preference] can also be accessed from route menu screen.
- If the vehicle greatly deviates from the suggested route, the system calculates a new route.
- If [Do Not Use Restriction Info] is selected for [Time Restricted Roads] setting, the system calculates a route without any consideration of the regulations concerning the time or day of the week. Therefore, the suggested route may include a road subject to traffic regulations concerning the time or day of the week. When driving along the route, always follow all traffic regulations regardless of whether [Time Restricted Roads] is set to be considered or not.
- The system calculates to reduce the time required for the entire route from the start to the destination. If there are no appropriate routes, the system may lead to a route where a traffic jam occurs instead of leading to a detour.

Navigation (if equipped) 6-17

RECALCULATING ROUTE

AV1NJAJ-338AF520-F4FD-419B-8060-6AF4890C9F43

A route can be manually searched again after changing the search conditions, etc.

1. Push **<MAP>** and then touch [Route] on the Launch Bar.
2. Touch [Recalculate]. A message is displayed and the route is recalculated.
3. Touch [Start] or conduct other operations as necessary.
 ↳ "Options before starting the route guidance" (page 6-12)

INFO:

- When a waypoint has been set on the route, the system will search for only one route, even if route recalculation is performed.
- When the vehicle deviates from the suggested route, the route from the current location to the destination is automatically searched again by the Auto Reroute function.

6-18 Navigation (if equipped)

Condition:

EDITING ROUTE

AV1NJAJ-0CPA5674-26DB-4DBD-94B4-07D1D137A60E

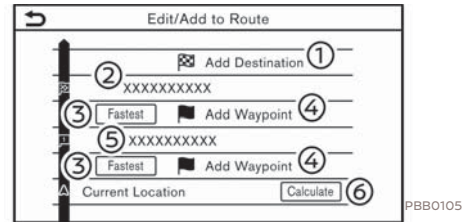

1. Push **<MAP>** and then touch [Route] on the Launch Bar.
2. Touch [Edit/Add to Route].
3. Edit the following settings and touch [Calculate].

Available settings

- ① [Add Destination]:
Touch to add a new destination.
- ② Current destination:
Touch to edit or delete the destination.
↳ "Editing/deleting destination or waypoint" (page 6-19)
- ③ Criteria for calculating a route to the destination/waypoint:
Touch to change the conditions for route calculation.
↳ "Changing route calculation conditions" (page 6-19)
- ④ [Add Waypoint]:
Touch to add a waypoint.
↳ "Setting destination or waypoint" (page 6-18)

(page 6-18)

- ⑤ Current waypoint:
Touch to edit or delete the waypoint.
↳ "Editing/deleting destination or waypoint" (page 6-19)
- ⑥ [Calculate]:
After editing the route, touch to recalculate a route with new conditions.

Setting destination or waypoint

AV1NJAJ-0BB2FCA4-907D-47E4-BFEC-38F304C36A5C

A destination or waypoint can be added to a route that has already been set. Up to 20 waypoints besides one destination can be set.

1. Push **<MAP>** and then touch [Route] on the Launch Bar.
2. Touch [Edit/Add to Route].
3. Touch [Add Destination] or [Add Waypoint].

INFO:

- If [Add Destination] is selected, the current destination changes to a waypoint.
- 4. Set a destination or waypoint. The method of searching for a waypoint is the same as the one for a destination.
↳ "Setting destination" (page 6-10)
- 5. Touch [Add to Route] to add the location to the route.

- The route information with the selected location added to the route is displayed. Adjust the route calculation conditions as necessary.
 ["Changing route calculation conditions"](#) (page 6-19)
- Touch [Calculate] to confirm the route change. The route will be recalculated.

INFO:

The prior route will be deleted automatically.

Editing/deleting destination or waypoint

AV1NJJA1-CD749FF6-3A0C-4C28-9B11-71083532CB3D

A destination or waypoint that has already been set can be modified or deleted.

- Push **<MAP>** and then touch [Route] on the Launch Bar.
- Touch [Edit/Add to Route].
- Touch a destination or waypoint that is already set.
- Touch to edit the following settings:

Available settings

- [Delete]:
A selected destination or waypoint that has already been set can be deleted.
- [Change Order]:
The order of a destination and waypoints that are already set can

be changed.

- [Move Destination]:
The location of the destination or waypoint can be adjusted by moving the cross pointer across the map on the touch screen display.

- Touch [Calculate] to apply the change.

INFO:

If the destination is deleted, the route guidance will be canceled.

Changing route calculation conditions

AV1NJJA1-2CFF4089-B7EE-40B4-A210-DBBEF76EFO2B

Each section of the route between waypoints can have different route calculation conditions.

- Push **<MAP>** and then touch [Route] on the Launch Bar.
- Touch [Edit/Add to Route].
- Touch the route condition shown on the preferred section of the route to the destination or waypoint.
- Touch the preferred condition.
 ["Route Preference"](#) (page 6-16)
 The conditions are changed and the display returns to the edit route screen.
- Touch [Calculate] to apply the change.

INFO:

The recalculated route may not be the shortest route because the system prioritizes roads that are easy to drive on for safety reasons.

Changing order of destination and waypoints

AV1NJJA1-A503E69F-4403-4F87-813B-70DF8CB10CE1

The order of a destination and waypoints that are already set can be changed.

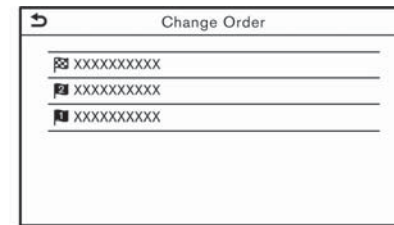

PBB0098X

- Push **<MAP>** and then touch [Route] on the Launch Bar.
- Touch [Edit/Add to Route].
- Touch a destination or waypoint that is already set.
- Touch [Change Order].
- Touch a preferred destination or waypoint to replace the previously selected destination or waypoint.
- Touch [Calculate] to apply the change.

Navigation (if equipped) 6-19

GUIDANCE SETTINGS

AV1NJAI-7A6444E0-AFEC-465E-93B2-F84FA292326B





Various settings are available to customize the guidance information provided by the system.

1. Touch [Navigation] on the setting menu screen.
 "System settings" (page 2-9)
2. Touch [Guidance Settings].
3. Touch an item you would like to set.

Available items may vary depending on models, specifications and software versions.

Setting item	Action
[Guidance Volume]	Adjusts the volume level of voice guidance.
[Guidance Voice]	Activates or deactivates voice guidance.
[Toll Booth Guide]	Activates or deactivates the function to notify that the vehicle is approaching a toll booth.

INFO:

- [Guidance Settings] can also be accessed from the route menu screen.
 "Route menu" (page 6-13)
- The guidance volume can also be adjusted by turning <VOL/  >/<VOL/PUSH  > or pushing <  > on the steering wheel while voice guidance is being announced.

6-20 Navigation (if equipped)

Condition:

[Edit: 2020/ 5/ 28 Model: AV1NJ-A]

STORING A LOCATION/ROUTE

AV1NJAJ1-D56E2757-E480-448D-84DE-0D0260214C62

STORING LOCATION

AV1NJAJ1-944965B9-F333-49EA-BE90-4D6BE51EE5F0

Often visited locations can be stored in the Address Book. The stored addresses can be easily retrieved to set them as a destination or waypoint. The Address Book can store up to 200 locations.

Storing home or work location

AV1NJAJ1-18F9446E-22F6-4B69-B465-63E96AFC7E1D

A home or work location can be stored in the system.

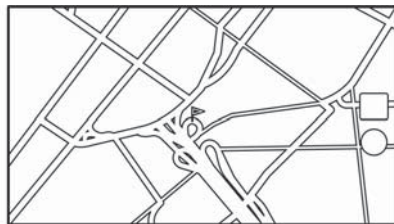

5GB0785X

1. Touch [Navigation] on the setting menu screen.
👉 "System settings" (page 2-9)
2. Touch [Address Book].
3. Touch [Add Home Location] or [Add Work Location].
4. Touch an appropriate method to set a location. Refer to the search methods used for destination setting.
👉 "Setting destination" (page 6-10)
5. Touch [OK].
6. A message is displayed, and the address of the location is stored in the Address Book.

7. Adjust and edit the contents of the stored item as necessary. Touch [OK] to confirm.
👉 "Editing stored location" (page 6-23)

i INFO:

If you touch [Go Home (Save Location)] or [Go to Work (Save Location)] on the destination screen while the home or work location is not stored yet, the system will display a message asking if you wish to store a home or work location. Touch [Yes] to store the home or work location.

Storing location by searching

AV1NJAJ1-6B0517E8-1830-49EB-812C-0BAAD4ECOCEA

It is possible to store a location by searching in various ways.

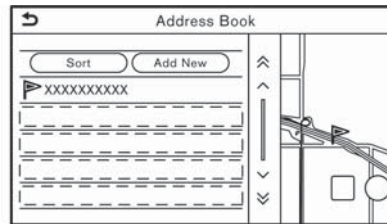

PBB0113X

1. Touch [Navigation] on the setting menu screen.
👉 "System settings" (page 2-9)
2. Touch [Address Book].
3. Touch [Saved Locations].

4. Touch [Add New].
5. Touch an appropriate method to set a location. Refer to the search methods used for destination setting.
👉 "Setting destination" (page 6-10)
6. Touch [OK].
7. A message is displayed, and the address of the location is stored in the Address Book.
8. Adjust and edit the contents of the stored item as necessary. Touch [OK] to confirm.
👉 "Editing stored location" (page 6-23)

i INFO:

- When the location is stored in the [Saved Locations], [Address Book] can be used to search for the location.
- When 200 locations are already stored, a new location cannot be stored until a currently stored location is deleted.

Navigation (if equipped) 6-21

Condition:

[Edit: 2020/ 5/ 28 Model: AV1NJ-A]

Storing location by moving map

AV1NJAI-F725F4DF-5CDD-4070-ADB6-94BF2474895F

1. Move to the preferred location on the map and touch  on the touch screen display.

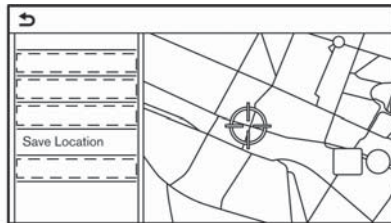

5GB0745X

2. Touch [Save Location]. A message is displayed.
3. The icon representing the stored location is displayed on the map. Push **<MAP>** to return to the current location map screen.

STORING ROUTE

AV1NJAI-B3907DCE-924F-48CO-BAC8-A06712252587

A maximum of 10 calculated routes can be stored. Stored routes can be easily retrieved and set as the suggested route.

A route requires at least one waypoint in order to be stored.

1. Push **<MAP>** and then touch [Route] on the Launch Bar.
2. Touch [Save Route]. A confirmation message is displayed. If asked, touch [Yes] to store the current route.



INFO:

- At least 1 waypoint must be set for the route to be stored.
- A stored route includes only locations (destination and waypoints) and route calculation conditions, not the route itself.
- The route is stored in the first available position number in the stored routes list.
- When 10 routes are already stored in the address book, a new route cannot be stored until a route is deleted.  ["Deleting stored item" \(page 6-26\)](#)

STORING AVOID AREA



AV1NJAI-495A7589-BAZ5-41EF-82F6-33DEBDE7742E

An Avoid Area can be stored. The Avoid Area is an area that can be excluded from a route, such as a road that is always congested. Once Avoid Areas are stored, the system avoids those areas when calculating a route. Up to 10 Avoid Areas can be stored.

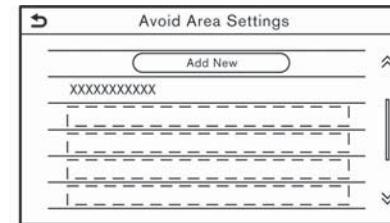
1. Touch [Navigation] on the setting menu screen.  ["System settings" \(page 2-9\)](#)
2. Touch [Address Book].
3. Touch [Avoid Area].



PBB0100X

4. Touch [Add New].
Touch an appropriate method to search for a location.  ["Setting destination" \(page 6-10\)](#)
5. Touch [OK].
6. Adjust the information of the Avoid Area as necessary.  ["Editing avoid area" \(page 6-26\)](#)
7. Touch [OK] to store the avoid area information.



INFO:

A maximum of 10 Avoid Areas can be stored. When 10 Avoid Areas are already stored, a new Avoid Area cannot be stored until a currently stored Avoid Area is deleted.

-  ["Deleting stored item" \(page 6-26\)](#)

6-22 Navigation (if equipped)

Condition:

EDITING STORED INFORMATION

AV1NJAI-39CF1CB1-4830-4B31-BE7E-70154B58A89C

Items stored in the system can be edited.

Editing stored location

AV1NJAI-D9E4FAC6-0EAD-4C1E-9D3C-A1EBC19926E1

1. Touch [Navigation] on the setting menu screen.
 "System settings" (page 2-9)

2. Touch [Address Book].

Available items may vary depending on models, specifications and software versions.

Setting item		Action	
[Home Location]*	[Edit]	[Show Icon on Map]	Displays the home icon on the map.
		[Icon]	Selects a home icon of a preferred design.
		[Sound]	Sets the type of the alarm that sounds when the vehicle approaches home.
		[Direction]	Sets the alarm to sound when approaching from a specific direction.
		[Distance]	Sets the alarm to sound when reaching a specific distance to home.
	[Phone Number]	Stores the home phone number.	
	[Move Location]	Adjusts the stored home location.	
	[Delete]	Deletes the stored home location.	
	[OK]	Confirms and saves the edited home information.	
[Work Location]*	[Edit]	[Show Icon on Map]	Displays the work icon on the map.
		[Icon]	Selects a work icon of a preferred design.
		[Sound]	Sets the type of the alarm that sounds when the vehicle approaches work.

Navigation (if equipped) 6-23

		[Direction]	Sets the alarm to sound when approaching from a specific direction.	
		[Distance]	Sets the alarm to sound when reaching a specific distance to work.	
		[Phone Number]	Stores the work phone number.	
	[Move Location]		Adjusts the stored work location.	
	[Delete]		Deletes the stored work location.	
	[OK]		Confirms and saves the edited work information.	
[Saved Locations]	[Sort]	[Sort by Number]	Sorts the saved locations.	
		[Sort by Name]		
		[Sort by Icon]		
		[Sort by Group]		
	[Add New]		Adds a new location. 🗨️ "Storing location by searching" (page 6-21)	
	Saved Location List	[Edit]	[Show Icon on Map]	Displays the icon of a stored location on the map.
			[Name]	Registers a name of the entry.
			[Voice Tag]	Registers a voice tag for the entry which allows the entry to be used with the Voice Recognition System.
			[Icon]	Selects an icon for the entry.
			[Sound]	Sets the type of the alarm that sounds when the vehicle approaches the location.
			[Direction]	Sets the alarm to sound when approaching from a specific direction.
			[Distance]	Sets the alarm to sound when reaching a specific distance to the location.

6-24 Navigation (if equipped)

Condition:

[Edit: 2020/ 5/ 28 Model: AV1NJ-A]

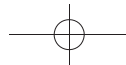

		[Phone Number]	Registers a phone number for the location.
		[Group]	Registers a group of the entry.
		[Entry Numbers]	Registers an entry number for the location.
		[Move Location]	Adjusts the stored location information.
		[Delete]	Deletes the stored location information.
		[OK]	Confirms and saves the edited stored location information.

*: When home or work location has not been stored, [Add Home Location] or [Add Work Location] is displayed and a home or work location can be stored from the menu.

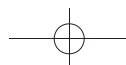
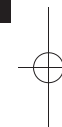
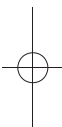

Editing stored route

AV1NJAT-FAB19EB7-2462-4CCA-9FCA-6945BF4DA07F

1. Touch [Navigation] on the setting menu screen.
 "System settings" (page 2-9)
2. Touch [Address Book].
3. Touch [Saved Routes].
4. Touch the preferred saved route from the list. Saved Routes settings screen will be displayed.

Setting item	Action
[Rename]	Changes the saved route name.
[Replace]	Overwrites the saved route with the current route.
[Delete]	Deletes the saved route.
[OK]	Applies the edited settings.

Editing avoid area

AV1NJAI-7741D32C-748E-4BE2-9BE8-E72FF75E70C6

1. Touch [Navigation] on the setting menu screen.
 "System settings" (page 2-9)
2. Touch [Address Book] and then touch [Avoid Area].
3. Touch a preferred Avoid Area from the list. Avoid Area settings screen will be displayed.

Setting item	Action
[Rename]	Changes the name of an Avoid Area.
[Move Location]	Adjusts the Avoid Area location.
[Resize Area]	Adjusts the size of the Avoid Area.
[Motorway]	Sets the Avoid Area to include or not include motorways. The color of the Avoid Area changes depending on the setting. Motorway ON: Green Motorway OFF: Blue
[Delete]	Deletes an Avoid Area.
[OK]	Applies the edited setting.

DELETING STORED ITEM

AV1NJAI-A49F7444-AEBA-437D-B1BF-DA7457A3F577

The locations and routes in the Address Book can be deleted. Deleting an individual item and deleting all stored items are available.



INFO:

Deleted items cannot be restored. Before deleting an item, always make sure that the item is no longer needed.

6-26 Navigation (if equipped)

Condition:

[Edit: 2020/ 5/ 28 Model: AV1NJ-A]

Deleting stored item individually

AV1NJ-A1-B68C2A81-E5C0-4DB2-A740-FC904C09AB2A

1. Touch [Navigation] on the setting menu screen.
 "System settings" (page 2-9)
2. Touch [Address Book].
3. Touch [Delete Saved Items].

Select the preferred item and touch [Yes] to confirm deletion.

Step 1	Step 2	Action
[Delete Home Location]		Deletes home location.
[Delete Work Location]		Deletes work location.
[Delete Address Book]	[Delete All]	Deletes all stored locations.
	[Delete One]	Deletes a selected stored location.
[Delete Saved Routes]	[Delete All]	Deletes all stored routes.
	[Delete One]	Deletes a selected stored route.
[Delete Avoid Areas]	[Delete All]	Deletes all Avoid Areas.
	[Delete One]	Deletes a selected Avoid Area.
[Delete Previous Destinations]	[Delete All Previous Destinations]	Deletes all of the previous destinations.
	[Delete One Previous Destination]	Deletes a selected previous destination.
	[Delete Previous Starting Point]	Deletes the previous starting point.
[Delete Learned Routes]		Deletes the learned routes.

Deleting individual item on map

AV1NJ-A1-62D39B7F-7242-4DA7-8F88-21A769ADE3F7

1. Align the cross pointer over the stored location to be deleted by moving on the map, and then touch .

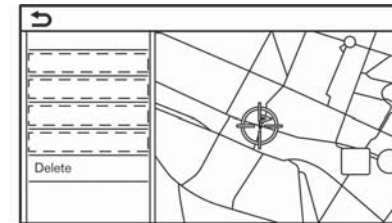

2. Touch [Delete].
3. A confirmation message is displayed. Confirm the contents of the message and touch [Yes].
 The stored item is deleted from the Address Book.

Navigation (if equipped) 6-27

Condition:

[Edit: 2020/ 5/ 28 Model: AV1NJ-A]

NAVIGATION SETTINGS

AV1NJAI-9D8690FE-57C7-4383-A650-C4EAEDB9B2D7

The navigation system can be customized according to the user's preference.

1. Touch [Navigation] on the setting menu screen.

 "System settings" (page 2-9)

2. Touch the item you would like to set.

Available setting items may vary depending on models, specifications and software versions.

Available items:

- **[Map Settings]**

Sets the display method and direction of the map.

 "Map settings" (page 6-7)

- **[Guidance Settings]**

Sets the various functions for route guidance.



 "Guidance settings" (page 6-20)

- **[Route Preference]**

Changes the routing preferences.

 "Route Preference" (page 6-16)

- **[Safety Guide Settings]**

Setting item	Action
[Speed Limit Indication on Map]	When this item is turned on, the speed limit indicator will appear on the right side of the map screen when there is a speed limit on the road the vehicle is driving on.  "2D map" (page 6-3)
[Speed Limit Warning]	When this item is turned on, the speed limit indicator will blink and warn the driver when the vehicle speed exceeds the speed limit.  "2D map" (page 6-3)
[Speed Limit Sens.]	Adjusts the speed limit sensitivity for [Speed Limit Warning].

- **[Address Book]**

Stores locations and routes. Stored items can be edited or deleted.

 "Storing a location/route" (page 6-21)

6-28 Navigation (if equipped)

Condition:

[Edit: 2020/ 5/ 28 Model: AV1NJ-A]

- **[Customise POIs]**
Sets the POI categories to be displayed on the Points of Interest screen.
- **[Adjust Current Location]**
If the vehicle icon indicating the current vehicle location is not in the correct position, the location of the vehicle icon on the map screen can be adjusted.
- **[Delete Saved Items]**
Deletes a saved location or route.
☞ "Deleting stored item individually" (page 6-27)
- **[Delete Previous Destinations]**
Deletes all or one of the previous destinations or the previous start point.
☞ "Deleting stored item individually" (page 6-27)
- **[Predictable Destination Settings]**

Setting item	Action
[Offer Predictable Destinations]	Turns on/off the driving habit learning function. When this item is turned on, the system learns the driving habits and suggests the predicted destinations if available upon the system activation.
[Delete Prediction Information]	Deletes the learned driving habits.

- **[Reset All Navigation Settings to Default]**
This resets various settings (display, volume level, etc.) to the default settings.

GENERAL INFORMATION FOR NAVIGATION SYSTEM

AV1NJAJ1-53E79F5D-9AE6-4984-955E-CB2A39EB4D66

CURRENT VEHICLE LOCATION

AV1NJAJ1-3DB2B29E-7959-42E7-A529-EBC2E6E1A510

Display of current vehicle location

AV1NJAJ1-AC334D4E-00C5-4F0B-889E-D50DC5D61202

This navigation system combines the data obtained from the vehicle (by gyro sensor) and from Global Navigation Satellite System (GNSS) to calculate the current location of the vehicle. This position is then displayed throughout route guidance to a destination.

What is Global Navigation Satellite System (GNSS)?

AV1NJAJ1-A33AD639-F86B-4DA8-B59E-2726CD899634

GNSS is a general term for positioning systems that use signals from satellites. This navigation system receives radio signals from three or more different satellites, and detect the position of the vehicle by utilizing the principle of triangulation.

Positioning adjustment:

When the system judges that the vehicle position is not accurate based on vehicle speed and gyro sensor data calculations, the system will automatically adjust the position of the vehicle icon using GNSS signals.

Receiving signals from GNSS satellites:

The reception of GNSS signals can be weak, depending on the environment. Vehicles in the following areas/environments may not receive GNSS signals.

6-30 Navigation (if equipped)

Condition:

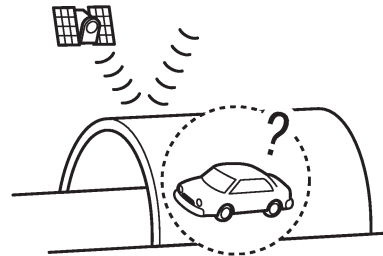

NAIO422

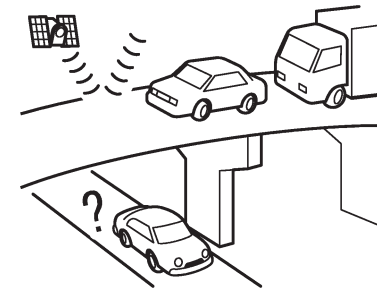

NAIO424

- Inside tunnels or parking garages

- Under multi-layered highways



NAIO423

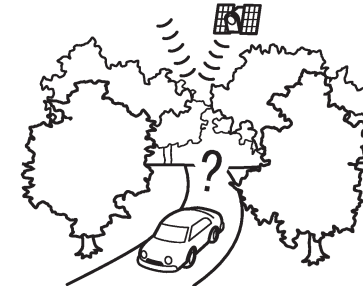

NAIO425

- In areas with numerous tall buildings

- Areas with numerous tall trees

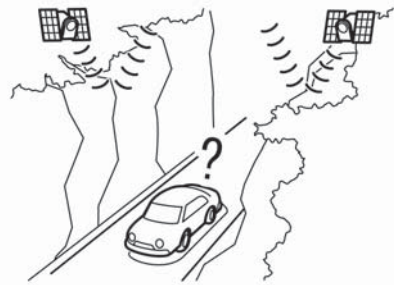

NAI0713

- In canyons

INFO:

The GNSS antenna is located on the instrument panel inside the vehicle. Do not place any objects, especially cellular phones or transceivers, on the instrument panel. Because the strength of the GNSS signal is weak, phones and transceivers will affect or may totally disrupt the signal.

Incorrect display of vehicle position

AV1NJ1-B4EC1A08-66C4-4494-8E5E-6CB5C47F02B9

The following cases may affect the display accuracy of the vehicle's position or traveling direction. The accuracy will return to normal if the driving conditions return to normal.

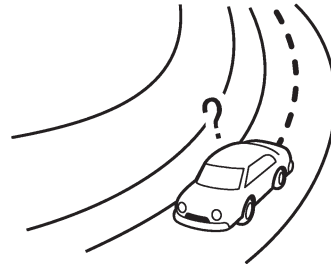

NAI0426

- When there is a similar road nearby.

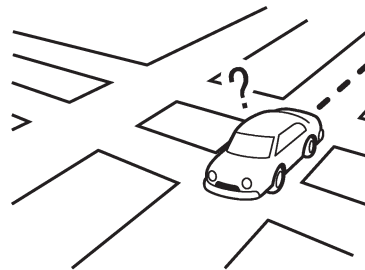

NAI0427

- When the vehicle is traveling in an area with a grid pattern road system.

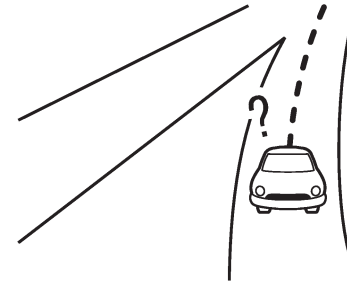

NAI0428

- When the vehicle is passing through a large Y-shaped intersection/junction.

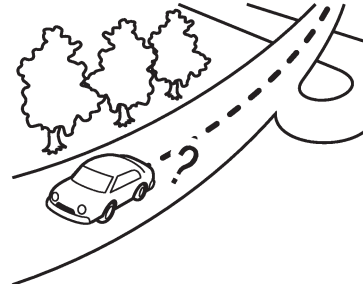

NAI0429

- When the vehicle is traveling on a continuous, slowly curving road.

Navigation (if equipped) 6-31

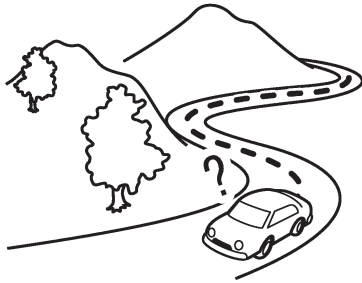

NAI0430

- When the vehicle is traveling on a road with repeating S-shaped curves.



NAI0432

- When the vehicle is on a snow-covered or unpaved road.

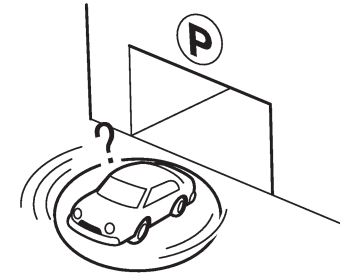

NAI0434

- When the vehicle is rotated on a parking lot turntable while the ignition switch placed in the OFF position.

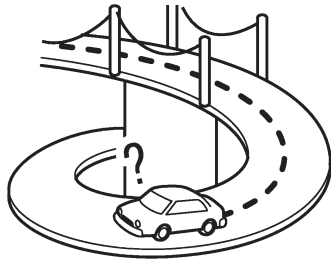

NAI0431

- When the vehicle is on a loop bridge.

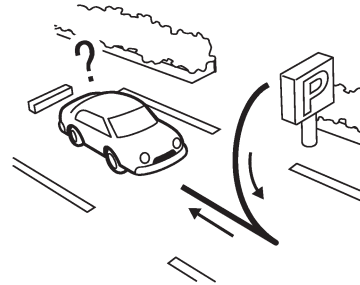

NAI0433

- When repeatedly turning left or right, or driving in zigzags.

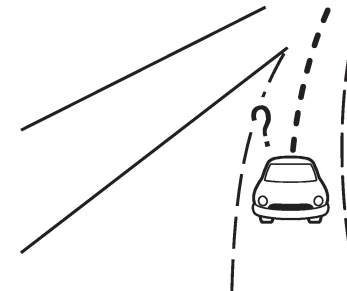

NAI0435

- When driving on a road not displayed on the map screen or a road that has been changed due to additional construction or other reasons.

6-32 Navigation (if equipped)

Condition:

[Edit: 2020/ 5/ 28 Model: AV1NJ-A]

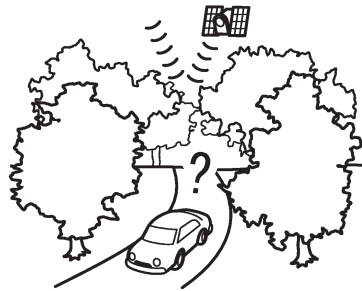

NAI0436

- When the GNSS positioning accuracy is low.

INFO:

- The vehicle icon may be misaligned when starting the vehicle just after starting the engine.
- The vehicle icon may also be misaligned if different sized tires or tire chains are installed.
- The system has a function that automatically corrects the vehicle icon position when it is misaligned from the actual position.
- Vehicle position correction by GNSS may not function when the vehicle is stopped.
- If the vehicle icon position does not return to normal even after driving for a while, correct the vehicle icon position manually.

Detailed Map Coverage Areas (MCA) for navigation system

AV1NJAI-A7915219-FB6B-4305-A8B1-86FF7C9DABCD

This system is designed to help guiding to the destination, and it also performs other functions as outlined in this manual. However, the system must be used safely and properly. Information concerning road conditions, traffic signs and the availability of services may not always be up-to-date. The system is not a substitute for safe, proper and legal driving.

Map data covers select metropolitan areas.

Map data includes two types of areas: "Detailed coverage areas" providing all detailed road data and other areas showing "Main roads only".

INFO:

Detailed map data is not available in many areas and is generally limited to select major metropolitan areas.

ROUTE CALCULATION

AV1NJAI-983B6490-022A-46D3-96FA-0F22CB58F824

- The suggested route may not be the shortest, nor are other circumstances such as traffic jams considered.
- Because of the inevitable difference in road conditions and circumstances between the time you use this system and the time the information was produced for the map data, there may be discrepancies in roads and regulations. In such cases, actual road

conditions and regulations take precedence over map data information.

- During route calculation, the map will not scroll, however the vehicle icon will move according to the actual vehicle's movement.
- During route calculation, buttons such as **<MAP>** and **<MENU>** will be disabled.
- In some cases, after the calculation is complete, the calculated route may not be immediately displayed.
- Waypoints that have been passed will be disregarded by rerouting calculation.
- If you scroll the map while the suggested route is being drawn, it may take more time to finish drawing.
- Route calculation may not be completed in the following cases.
 - If there is no main road within a range of 2.5 km (1.5 miles) from the vehicle, a message saying so will appear on the screen. Try recalculating when the vehicle is closer to a main road.
 - If there is no main road within a range of 2.5 km (1.5 miles) from the destination or waypoint, a message saying so will appear on the screen. Try setting the location closer to a main road.

Navigation (if equipped) 6-33

- If the vehicle is too close to the destination or if there are no roads to the destination, a message saying so will appear on the screen.
- If it is impossible to reach the destination or waypoints because of traffic regulations, etc.
- If the only route to reach the destination or waypoints is extremely complicated.
- The following may occur when the route is displayed.
 - If you calculate a route on a main road, the starting point of the route may not exactly match the current vehicle location.
 - The endpoint of the route may not exactly match the destination.
 - If you calculate a route on a main road, the system may display a route from another main road. This may be because the position of the vehicle icon is not accurate. In this case, park the vehicle in a safe location and reset the vehicle icon, or continue driving to see if the position of the vehicle icon is automatically adjusted before recalculating the route.
 - There are cases in which the system shows an indirect route to reach the destination or waypoints, if you set them from stored or

facility information. In order to correct this, you must be careful about the traffic direction, especially when lanes with different travel directions are shown separately, such as interchanges and service areas.

- This system makes no distinction between limited traffic control and total control (blockage). It may show an indirect route even if the road is usable.
- Even if the ferry preference is set to OFF, a route that uses a ferry line may be suggested.

ROUTE GUIDANCE

AV1NJAI-D4460D59-8C4D-4A28-8361-F3C3C250F896



INFO:

The system will announce street names when the system language is set to English.

Repeating voice guidance

AV1NJAI-43C350DF-CAB4-4E5D-8440-651D34A03D54

This function is available throughout route guidance, from the time after the route calculation is completed until the vehicle arrives at the destination. Push and hold **<MAP>**. Voice guidance will be repeated.

Notes on voice guidance

AV1NJAI-D97CE07-69B5-4213-9710-6F7BC47DE9D0

- Voice guidance in this system should be regarded as a supplementary function. When driving the vehicle, check the route on the map and follow the actual roads and traffic regulations.
- Voice guidance is activated only for intersections with certain conditions. There may be cases where the vehicle has to turn, but voice guidance is not provided.
- Voice guidance contents may vary, depending on the direction of the turn and the type of intersection.
- The voice guidance timing will vary depending on the situation.
- When the vehicle has deviated from the suggested route, voice guidance is not available. The system will not announce this. Refer to the map and recalculate the route.
 - 🗺️ ["Recalculating route" \(page 6-18\)](#)
- Voice guidance may not accurately correspond with road numbers and directions at motorway junctions.
- The displayed street names may sometimes differ from the actual names.
- Voice guidance is not available when [Guidance Voice] is turned off.
- Voice guidance will start when the vehicle enters the suggested route.

6-34 Navigation (if equipped)

Condition:

[Edit: 2020/ 5/ 28 Model: AV1NJ-A]

Refer to the map for directions to the starting point of the route.

- When approaching a waypoint, the voice guidance will announce and inform the driver that the vehicle has reached a waypoint. Voice guidance will switch to the next section of the route. When voice guidance is not available, refer to the map for directions.
- In some cases, voice guidance ends before arrival at the destination. Refer to the destination icon on the map to reach the destination.
- Voice guidance may be partially operational or inoperative due to the angle of roads at an intersection.
- Motorway exit information may differ from the information on the actual exit signs.
- Because it is not possible to consider data concerning roads that are seasonally available or unavailable, a route may be displayed that does not match the actual traffic restrictions. Be sure to follow the actual traffic restrictions while driving.

HOW TO UPDATE MAP DATA

AV1NJ-A1-12B14EED-F217-4681-BB6D-9C3DAFF9250C

Navigation map data can be updated via USB memory device.

The map data can be updated with the latest information by downloading a new map database to a USB memory device and installing it in the vehicle.

For map update, use the USB memory with the following specifications:

Supported media: USB2.0

Supported file system: FAT32

1. Push **<MENU>**.

2. Touch [Info] on the Launch Bar and then touch [System Information].

3. Touch [Map Update].

4. Touch [Save Map Information to USB Device].

5. Insert blank USB memory device into the USB connection port.

 "USB (Universal Serial Bus) connection ports" (page 2-5)



INFO:

If data is in the USB memory, it may be deleted.

6. Touch [Start].

7. Touch [OK] after saving the map information to USB.

8. Access to the designated website with your personal computer. Download and install the map update tool in your personal computer. (Consult a

NISSAN dealer for details.)

9. Download the updated data and store it in the USB memory with the map update tool.

10. Push **<MENU>**.

11. Touch [Info] on the Launch Bar and then touch [System Information].

12. Touch [Map Update].

13. Touch [Install Map Update from USB Device].

14. Insert the USB memory into the USB connection port.

A confirmation message is displayed. Confirm the contents of the message and touch [Yes].

15. Touch [OK] after completing the update.



INFO:

- The navigation system cannot be operated while the map updates.

- Map data should be updated while the engine is running to prevent discharge of the vehicle battery.

- The same operation can be performed from [System Update] on the setting menu screen.

 "System settings" (page 2-9)

Navigation (if equipped) 6-35

Automotive products End User License Provisions

AV1NJAJ1-9D16307C-E87E-4BC4-8781-DF54FA921AF2

This End-User License Agreement ("**EULA**") is an agreement between you and TomTom International B.V. ("**TomTom**"). You agree that this EULA is enforceable. This EULA applies to your use of the TomTom Map data, software, Traffic and Travel services or any other TomTom products (together the "**Services**").

Please read this EULA carefully. By using the Services you agree to all the terms and conditions of this EULA.

1. **GRANT OF LICENSE:** In consideration of you agreeing to abide by the terms of this EULA, TomTom hereby grants to you a non-exclusive, license to use the Services solely in connection with the vehicle. If upgrades, updates or supplements to the Services are provided the use of such upgrades or updates is governed by this EULA.
2. **RESTRICTIONS:** You are prohibited from renting, lending, public presentation, performance or broadcasting or any other kind of distribution of the Services. Other than as permitted by applicable legislation, you will not, and you will not allow any person to, copy or modify the Services or any part thereof or to reverse engineer, decompile or disassemble the Services.
3. **OWNERSHIP:** Copyright and other intellectual, industrial and/or proprie-

tary rights to the Services are owned by TomTom and/or its suppliers. TomTom permits you to use the Services only in accordance with the terms of this EULA. All rights not specifically granted in this EULA are reserved by TomTom. To the extent applicable, you acknowledge that you have no right to have access to the Services in source code or in unlocked coding.

4. **THIRD PARTY SOFTWARE LICENSES:** The Services may make use of third party software. Notwithstanding Clauses 2 and 3, use of some third party materials included in the Software may be subject to other terms and conditions. The official copyright notices and specific license conditions of these third party software codes and algorithms are to be found via <http://www.tomtom.com>. You hereby agree to the terms and conditions for such third party software.
5. **LIMITED WARRANTY:**
 - YOU ACKNOWLEDGE THAT THE SERVICES HAVE NOT BEEN DEVELOPED TO MEET YOUR INDIVIDUAL REQUIREMENTS AND THAT IT IS THEREFORE YOUR RESPONSIBILITY TO ENSURE THAT THE FACILITIES AND FUNCTIONS OF THE SERVICES MEET YOUR REQUIREMENTS. TOMTOM DOES NOT AND CANNOT WARRANT THAT THE SERVICES OPERATE UNINTERRUPTED OR ER-

ROR-FREE. YOU SHOULD BE PARTICULARLY AWARE OF THE FACT THAT CALCULATION ERRORS MAY OCCUR WHEN USING SOFTWARE IN A NAVIGATION SYSTEM FOR INSTANCE CAUSED BY LOCAL ENVIRONMENTAL CONDITIONS AND/OR INCOMPLETE DATA.

- TO THE MAXIMUM EXTENT PERMITTED BY APPLICABLE LAW, TOMTOM AND ITS SUPPLIERS PROVIDE THE SERVICES "AS IS", AND HEREBY DISCLAIM ALL OTHER WARRANTIES AND CONDITIONS, WHETHER EXPRESS, IMPLIED OR STATUTORY, INCLUDING, BUT NOT LIMITED TO, ANY (IF ANY) IMPLIED WARRANTIES, DUTIES OR CONDITIONS OF SATISFACTORY QUALITY, OF FITNESS FOR A PARTICULAR PURPOSE, OF RELIABILITY OR AVAILABILITY, OF ACCURACY OR COMPLETENESS OF RESPONSES, OF RESULTS, WITH REGARD TO THE SERVICES, AND THE PROVISION OF OR FAILURE TO PROVIDE SUPPORT OR OTHER SERVICES, INFORMATION, SOFTWARE, AND RELATED CONTENT THROUGH THE SERVICES OR OTHERWISE ARISING OUT OF THE USE OF THE SERVICES.

SAFETY: THE SERVICES ARE INTENDED TO BE USED FOR PROVIDING INFORMATION AND NAVIGATION SERVICES RELATED TO YOUR JOURNEY ONLY AND

6-36 Navigation (if equipped)

Condition:

[Edit: 2020/ 5/ 28 Model: AV1NJ-A]

ARE NOT INTENDED TO BE USED AS A SAFETY RELATED TOOL AND CANNOT WARN YOU ABOUT ALL DANGERS AND HAZARDS WITH RESPECT TO THE ROAD YOU ARE DRIVING. THEREFORE, IT REMAINS YOUR DUTY TO DRIVE IN A CAREFUL AND SAFE MANNER (PAYING ALL DUE CARE AND ATTENTION TO THE ROAD) AS WELL AS OBSERVING ALL APPLICABLE TRAFFIC REGULATIONS AND RULES. IT IS YOUR RESPONSIBILITY NOT TO USE THE SERVICES IN A MANNER THAT WOULD DISTRACT YOU FROM DRIVING SAFELY.

6. LIMITATION OF LIABILITY:

TO THE MAXIMUM EXTENT PERMITTED BY APPLICABLE LAW, NEITHER TOMTOM NOR ITS LICENSORS AND SUPPLIERS, OFFICERS, DIRECTORS OR EMPLOYEES SHALL BE LIABLE TO YOU OR TO ANY THIRD PARTY FOR ANY DAMAGES, WHETHER DIRECT, SPECIAL, INCIDENTAL, INDIRECT OR CONSEQUENTIAL (INCLUDING BUT NOT LIMITED TO, DAMAGES FOR THE INABILITY TO USE OR ACCESS THE SERVICES, LOSS OF DATA, LOSS OF BUSINESS, LOSS OF PROFITS, BUSINESS INTERRUPTION OR THE LIKE) ARISING OUT OF OR RELATED TO THE USE OF, THE INABILITY TO USE OR ACCESS, OR OTHERWISE THE PERFORMANCE OF THE SERVICES, EVEN IF NISSAN HAS

BEEN ADVISED OF THE POSSIBILITY OF SUCH DAMAGES.

TO THE EXTENT TOMTOM IS NOT PERMITTED UNDER APPLICABLE LAW TO EXCLUDE ITS LIABILITY PURSUANT TO CLAUSE 6.1 ABOVE, TOMTOM'S TOTAL AGGREGATE LIABILITY TO YOU SHALL BE LIMITED TO THE AMOUNT OF US \$100.00.

THE ABOVE LIMITATIONS OF LIABILITY UNDER THIS CLAUSE 6 DO NOT: (I) AFFECT YOUR RIGHTS UNDER ANY APPLICABLE MANDATORY NATIONAL LEGISLATION; (II) EXCLUDE OR LIMIT ANY LIABILITY THAT CANNOT BE EXCLUDED OR LIMITED UNDER APPLICABLE LAW.

7. TERMINATION: Without prejudice to any other rights, TomTom may immediately terminate this EULA if you fail to comply with any of its terms and conditions. The provisions of this Agreement, which by their nature are intended to survive termination, will remain in effect after termination of this EULA.

8. LINKS TO THIRD PARTY SITES: TomTom and other third parties involved in making the Services available to you ("Third Parties") are not responsible for the contents of any third-party sites or services, any links contained in third-party sites or services, or any changes or updates to third-party sites or services which are

delivered by the Services or otherwise. TomTom (and, as applicable, each of the Third Parties) is providing these links and access to third-party sites and services to you only as a convenience, and the inclusion of any link or access does not imply an endorsement by TomTom or any Third Parties of the third-party site or service. Any use by you of such links or third party sites and the manner in which you use such third party sites and links shall be your responsibility and at your risk and you shall not use them in any illegal or fraudulent manner.

Should you have any questions concerning this EULA, or if you desire to contact TomTom for any reason, please visit TomTom's website at <http://www.tomtom.com>.

Navigation (if equipped) 6-37

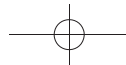

(102,1)



MEMO

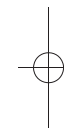
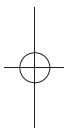

6-38 Navigation (if equipped)



Condition:

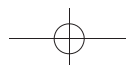

[Edit: 2020/ 5/ 28 Model: AV1NJ-A]



7 Voice recognition

Voice recognition	7-2
Using Voice Recognition System	7-2
Before starting	7-2
Giving voice commands	7-2
System Voice settings	7-4

VOICE RECOGNITION

AV1NJA1-FAF38580-C669-4F26-B8D0-7EC58692FC6D

USING VOICE RECOGNITION SYSTEM

AV1NJA1-1C8F749E-4AF3-47FE-9FEO-7B0B8B8AF458

Initialization

AV1NJA1-60C8EC21-9C96-4FBC-A946-5937BAB414EC

When the ignition switch is in the ACC or ON position, voice recognition is initialized. When the initialization is complete, the system is ready to accept voice commands. If on the steering wheel is operated before the initialization completes, the display will show a message to wait until the system is ready.

BEFORE STARTING

AV1NJA1-17B90F0D-2C92-4147-8CBB-60019E6215D6

To get the best recognition performance from voice recognition, observe the following items.

- The interior of the vehicle should be as quiet as possible. Close the windows to eliminate the surrounding noises (traffic noise, vibration sounds, etc.) and turn down the fan speed level of the heater/air conditioner to lower the noise which may prevent the system from correctly recognizing the voice commands.
- Wait until the tone sounds before speaking a command.
- Speak in a natural conversational voice without pausing between words.
- The system cannot recognize voice

7-2 Voice recognition

Condition:

commands spoken from passenger seats.

GIVING VOICE COMMANDS

AV1NJA1-B79272C7-32FE-481D-B7B3-A50FF427C81A

1. Push on the steering wheel.

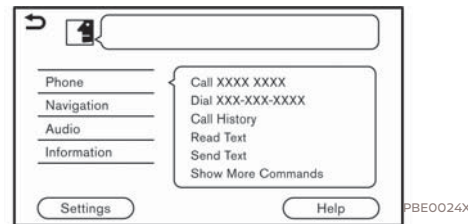

Example

2. A list of commands appears on the screen, and the system provides the voice menu prompt.

Available category commands are displayed on the left side of the screen. Speak or touch a category command from the category command list.

INFO:

- Some of the commands for each category are shown on the right side of the screen and they can also be spoken without selecting a category.
- After executing the category command, only the commands related to the selected category can be recognized.

3. After the tone sounds and the icon on the screen changes from to , speak a command. You can also select a command by directly touching the screen, using / on the steering wheel or using // on the control panel.

INFO:

The Voice Recognition System will pause its operation when no command is given after a few prompts. To resume the operation, push on the steering wheel.

4. Continue to follow the voice menu prompts and speak the voice commands after the tone sounds until the preferred operation is executed.

INFO:

- To exit the Voice Recognition System, push and hold or on the steering wheel.
- Depending on the language setting, the Voice Recognition System cannot be used.

Operating tips

AV1NJAI-SEBEIC81-7EAE-4A5C-8323-F92B58DC3259

- Speak a command after the tone.
- If the command is not recognized, the system will prompt you to speak the command again. Repeat the command in a clear voice.
- Touch [↩] on the touch screen display or push <↩> on the steering wheel to return to the previous screen.
- To adjust the volume of the system feedback, push <🔊> on the steering wheel or turn <VOL/🔊>/<VOL/PUSH 🔊> while the system is making an announcement.

Voice Prompt Interrupt:

In most cases, you can interrupt the voice feedback to speak the next command by pushing <🔊> on the steering wheel. After interrupting the system, wait for a tone before speaking your command.

One Shot Call:

To use the system faster when making a call, you may speak the second level command skipping speaking the first level command. For example, push <🔊> on the steering wheel and say "Redial" after the tone without first saying "Phone".

How to see voice command screen

AV1NJAI-DA7924C7-AD6F-4EBB-A519-06BD7EFD97EA

1. Push <🔊> on the steering wheel to display the first screen of the voice command list.
2. Speak a command or select an item on the voice command list. The second screen is displayed.
3. Speak a command or select an item on the voice command list. The command is executed or the next screen for further command is displayed.
4. Follow the prompts to complete the commands.

Voice command screens:

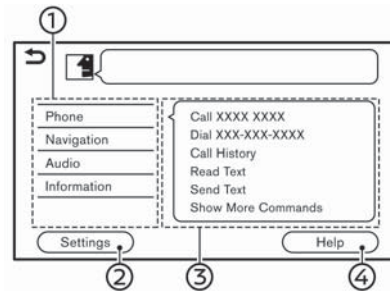

Example

- ① Shows a list of available categories. Speak a category command or touch the key of the corresponding category.

- ② Touch [Settings] or say "Settings" to display the system voice settings.
- ③ Shows a list of available commands for the selected category. Speak a preferred command.
- ④ Touch [Help] or say "Help" to hear help announcements on how to use the system.

INFO:

Push <🔊> on the steering wheel to stop the help announcements.

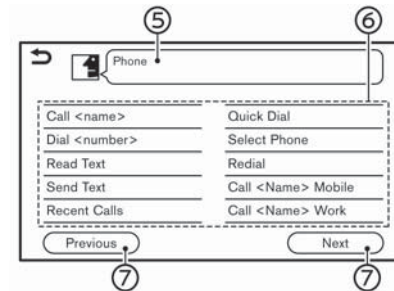

Example

- ⑤ Previously selected command
- ⑥ Command list

You can speak a command from the list or touch the corresponding key. Preferred words can be spoken for the part of the command enclosed in <>.

Voice recognition 7-3

Condition:

⑦ [Previous]/[Next]

Say as a command or touch to go to the previous/next screen.

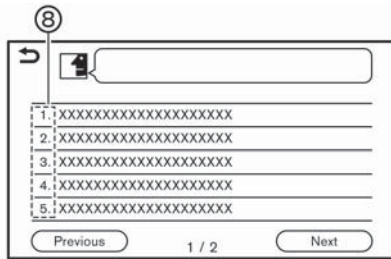

PBE0027X

⑧ Speak a number from 1 to 5 or touch an item on the list screen to select the item.

How to speak numbers

AV1NJAI-71FDCB5E-F8C6-44F6-B150-DA7EA47CDF74

The Voice Recognition System requires the user to speak numbers in a certain way when giving voice commands.

General rule:

Only single digits "0" (zero) to "9" can be used. (For example, for the number "600", speaking "six zero zero" can be recognized by the system, but "six hundred" cannot be recognized.)

INFO:

For the best recognition, speak "zero" for the number "0", and "oh" for the letter "o".

7-4 Voice recognition

Condition:

SYSTEM VOICE SETTINGS

AV1NJAI-67D614E7-55A6-4EA8-BDE1-5FF2EFEB3D40

The system voice settings can be changed.

1. Touch [System Voice] on the setting menu screen.
  "System settings" (page 2-9)
2. Touch the item you would like to set.

Available setting items may vary depending on models, specifications and software versions.

Available item	Action
[Initial Voice Prompt]	When this item is turned on, voice prompts are announced.
[Short Voice Prompts]	When this item is turned on, short and minimized voice feedback will be provided.
[Best Match Lists]	When these items are turned on, the voice recognition results are displayed on the list in the order of reliable recognition.
[Phone Book] [Music Commands]	
[Voice Preference]	Guidance voice setting can be selected from a male or female voice. Depending on the language setting, the guidance voice setting cannot be changed.
[Speech Rate]	Adjusts the speech rate of prompt.

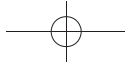

(108,1)



MEMO



7-6 Voice recognition



Condition:

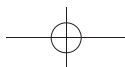

[Edit: 2020/ 5/ 28 Model: AV1NJ-A]



8 Troubleshooting guide

System unit	8-2
Liquid crystal display	8-2
Wi-Fi connection (if equipped)	8-3
Audio system	8-4
AM radio	8-4
iPod player	8-5
USB memory device	8-7
Bluetooth® audio	8-8
Bluetooth® Hands-Free Phone System	8-10
Apple CarPlay (if equipped)	8-13
Android Auto (if equipped)	8-14
Siri Eyes Free (if equipped)	8-15
Navigation (if equipped)	8-16
Basic operations	8-16
Map screen	8-17
Route calculation and visual guidance	8-19
Voice guidance	8-21
Voice recognition	8-22

SYSTEM UNIT

AV1NJA1-31400E7C-F4D3-4689-A9F6-88A5A28E5475

LIQUID CRYSTAL DISPLAY

AV1NJA1-EAA5898F-0334-4D4C-A1E3-D24F8C3455F2

Symptom	Possible cause	Possible solution
The screen is too dark.	The cabin temperature is too low.	Wait until the cabin temperature becomes moderate.
	Screen brightness is set to the maximum darkness.	Adjust the brightness setting of the screen.
The screen is too bright.	Screen brightness is set to the maximum brightness.	Adjust the brightness setting of the screen.
A small black spot or a small bright spot appears on the screen.	This is a typical phenomenon for liquid crystal displays.	This is not a malfunction.
A dot or stripe pattern appears on the screen.	Electromagnetic waves that are generated from neon billboards, high voltage electric power cables, ham radios or other radio devices equipped to other vehicles may adversely affect the screen.	This is not a malfunction.
Image lag appears on the screen.	This is a typical phenomenon for liquid crystal displays.	This is not a malfunction.
Image motion displayed on the screen is slow.	The cabin temperature is less than 10°C (50°F).	Wait until the cabin temperature rises to within 10°C (50°F) and 50°C (122°F).
When looking at the screen from an angle, the screen lightens or darkens.	This is a typical phenomenon for liquid crystal displays.	Adjust the brightness setting of the screen.
The screen turns blue or an error message is displayed on the touch screen display.	A system malfunction has occurred.	It is recommended that you contact a NISSAN dealer for an inspection.

8-2 Troubleshooting guide

Condition:

[Edit: 2020/ 5/ 28 Model: AV1NJ-A]

WI-FI CONNECTION (if equipped)

GUID-822D550C-BE0A-45A7-B402-984AD0F92BEA

Symptom	Possible cause	Possible solution
The name of the device which you wish to connect is not displayed on the Connections screen.	The device is turned off.	Check that the device is turned on.
	The device does not support a WPA2 security network.	Check that the security network is supported by the device.
The in-vehicle system cannot connect to the Wi-Fi network.	The device is turned off.	Check that the device is turned on.
	The network password is incorrect.	Check that the network password is correct.
		Check the entered password is correct.

AUDIO SYSTEM

AV1NJAT-A966E4C8-AA58-414B-9A6A-500CC260D786

AM RADIO

AV1NJAT-03098BF6-A35B-4E27-82A2-F350BEF4EA49

Symptom	Possible cause	Possible solution
AM reception deteriorates at night.	AM stations are required to lower their power at night.	This is not a malfunction.

8-4 Troubleshooting guide

Condition:

[Edit: 2020/ 5/ 28 Model: AV1NJ-A]

iPod PLAYER

AV1NJ-A1-4D70A092-9EC2-4F72-A4BF-DO40AE970C29

Symptom	Possible cause	Possible solution
The system does not recognize an iPod.	A connector cable is not correctly connected, or the iPod does not correctly operate.	Connect the connector cable again. If the system does not recognize the iPod after performing this procedure above, reset the iPod.
	The iPod that is to be connected is not compatible with the system.	Check the iPod model and firmware versions available for the system.
	The connected USB extension cable is not compatible with the system.	Replace the USB extension cable if the system still does not recognize the iPod after reconnecting the cable properly a number of times.
	The cable is rapidly connected to or disconnected from the USB connection port.	Slowly connect or disconnect the USB cable.
An iPod cannot be operated.	The iPod is connected to the in-vehicle audio system while headsets, etc. are connected to the iPod.	Remove all equipment from the iPod after disconnecting the iPod from the system, and then connect it to the system again.
	The iPod is not operating normally.	Disconnect the iPod from the in-vehicle audio system, and then connect it to the system again.
	The system plays back an album/file that includes a particular album art.	Disconnect the iPod from the in-vehicle audio system, and then reset the iPod. Disable the album art, and then connect the iPod to the system.
An iPod does not respond.	There are too many files in a category.	Decrease the number of files in a category (less than 65500 files).
	The shuffle function is turned on.	Turn off the shuffle function if many files are stored on the iPod.
Music cannot be played back.	A connector is not connected to the iPod.	Firmly connect the connector to the iPod.
Playback cuts out.	The sound cuts due to vibration resulting from an unstable location of the iPod.	Place the iPod on a stable location where it does not roll over.

Troubleshooting guide 8-5

Symptom	Possible cause	Possible solution
Battery charge of an iPod takes longer.	Battery charge of the iPod may take longer while an iPod is playing back.	If the iPod needs to be charged, it is recommended to stop playing the music.
Battery charge of an iPod is unavailable.	The cable that is connected to the iPod may be damaged or improperly connected.	Check the cable currently in use.
Functions cannot be operated using an iPod that is connected to the in-vehicle audio system.	-	The operation of an iPod must be performed using the in-vehicle audio system after the iPod is connected to the system.
Sound skips.	Surrounding circumstances (noise, etc.) may cause the sound to skip.	This does not indicate a malfunction.
	A USB extension cable is used.	Do not use a USB extension cable.

8-6 Troubleshooting guide

Condition:

[Edit: 2020/ 5/ 28 Model: AV1NJ-A]

USB MEMORY DEVICE

AV1NJ-A1-9B58E82E-0419-4E45-A82E-F6C87CFB97F2

Symptom	Possible cause	Possible solution
The system does not recognize a USB device.	A USB extension cable is used.	Do not use a USB extension cable.
	A USB hub is used.	Do not use a USB hub.
	A USB device is rapidly connected to or disconnected from the USB connection port.	Slowly connect or disconnect the USB device.

BLUETOOTH® AUDIO

AV1NJ-A1-31B3F814-D7EA-4A60-B53A-A05CC7472680

Symptom	Possible cause	Possible solution
Registration cannot be performed.	The Bluetooth® audio device is not compatible with the in-vehicle audio system.	Check the Bluetooth® audio device Owner's Manual.
	Bluetooth® is disabled on device.	Check that the Bluetooth® function is enabled on device.
	The PIN code is incorrect.	Check the PIN code for the Bluetooth® audio device that is to be registered.
		Check that the PIN code for the Bluetooth® audio device is consistent with that for the in-vehicle audio system.
Another Bluetooth® device is used in the vehicle.	Turn off the other Bluetooth® device until the registration is completed.	
Music cannot be played back.	The Bluetooth® audio device is not compatible with the in-vehicle audio system.	Check the Bluetooth® audio device Owner's Manual.
	The system is not set to the Bluetooth® audio mode.	Push <AUDIO> and select the Bluetooth® audio mode.  "Selecting audio source" (page 3-7)
	A Bluetooth® adapter is turned off.	Turn on a Bluetooth® adapter when it is used for a Bluetooth® audio device.
Playback stops.	The Bluetooth® audio device is not compatible with the in-vehicle audio system.	Use a device compatible with the system. Ask a NISSAN dealer for information regarding model compatibility.
	A cellular call is active.	This is not a malfunction.
	Sound may cut out when a Bluetooth® audio device is operated.	Push <AUDIO> and select the Bluetooth® audio mode, and then operate a function on the touch screen display of the in-vehicle system instead of conducting the operation on the Bluetooth® audio device.

8-8 Troubleshooting guide

Condition:

[Edit: 2020/ 5/ 28 Model: AV1NJ-A]

Symptom	Possible cause	Possible solution
Audio operation cannot be performed.	A Bluetooth® audio device that does not support audio operations is in use.	Use a device compatible with the system. Ask a NISSAN dealer for information regarding model compatibility.
	An error occurs when connecting to a Bluetooth® audio profile.	Turn the power source of the Bluetooth® audio player off and on, and then resume connection with the system.

BLUETOOTH® HANDS-FREE PHONE SYSTEM



AV1NJ1-BC6BB4C1-95BF-4792-A967-D8DDE888D56D

Symptom	Possible cause	Possible solution
A cellular phone cannot be registered.	The cellular phone is not compatible with the in-vehicle hands-free phone system.	Use a cellular phone compatible with the system. Ask a NISSAN dealer for information regarding model compatibility.
	Registration of the cellular phone has been performed incorrectly.	Check the registration procedure, and then register the cellular phone again.
A cellular phone cannot be connected or is disconnected after the registration is completed.	The Bluetooth® setting of the in-vehicle hands-free phone system is turned off.	Turn on the Bluetooth® setting of the system.
	The Bluetooth® setting of the cellular phone is turned off.	Turn on the Bluetooth® setting of the cellular phone.
	The remaining battery level of the cellular phone is low.	Charge the battery of the cellular phone.
	The wireless Bluetooth® connection may be disrupted depending on the location of the cellular phone.	Do not place the cellular phone in an area surrounded by metal or far away from the in-vehicle hands-free phone system. Do not place the cellular phone close to the seats or your body.
	Registration of the cellular phone is not completed.	Perform registration of the cellular phone.
A call to a particular phone number fails.	If the system tries to make a call several times to the same phone number (for example: the party does not respond to the call, the party is out of the service area, or the call is abandoned before the party responds), the system may reject a request to make a call to the phone number.	Turn off the cellular phone and turn it on again to reset the connection.

8-10 Troubleshooting guide

Condition:

[Edit: 2020/ 5/ 28 Model: AV1NJ-A]

Symptom	Possible cause	Possible solution
The system does not recognize the connection of a cellular phone. The system does not receive or make a call.	The cellular phone is not compatible with the in-vehicle hands-free phone system.	Use a cellular phone compatible with the system. Ask a NISSAN dealer for information regarding model compatibility.
	The cellular phone is not connected.	Check the registration procedure, and then register the cellular phone again.
	The phone operation is limited by the functions (such as dial lock, etc.) of the registered cellular phone.	Remove any settings that are limiting use of the cellular phone, and then perform registration again.
The other party cannot hear your voice. The other party can hear your voice, but it cracks or cuts out.	Mute function is enabled.	Verify mute function is disabled.
	The cellular phone is not connected.	Check the registration procedure, and then register the cellular phone again.
	The fan speed of the heater/air conditioner is too fast.	Decrease the fan speed of the heater/air conditioner.
	The ambient noise level is excessive. (For example: heavy rain, construction sites, inside a tunnel, oncoming vehicles, etc.)	Close the windows to shut out ambient noise.
	The noise generated by driving the vehicle is too loud.	Reduce the vehicle speed.
	The incoming voice volume is too loud/soft.	Adjust the volume using <VOL/  >/<VOL/ PUSH  > or <  >.
	The outgoing voice volume is too loud/soft.	Adjust the volume from volume adjustment screen.
The voice is cut out or noise is heard during a call.	The wireless Bluetooth® connection may be disrupted depending on the location of the cellular phone.	Do not place the cellular phone in an area surrounded by metal or far away from the in-vehicle hands-free phone system. Do not place a cellular phone close to the seats or your body.
When a cellular phone is operated to make a call, the hands-free function becomes unavailable.	Some models of a cellular phone do not switch to the hands-free mode when they are operated to make a call.	This is not a malfunction. Make another call using the hands-free function.

Troubleshooting guide 8-11

Symptom	Possible cause	Possible solution
The other party's voice cannot be heard. There is no ringtone.	The volume level is set to the minimum.	Adjust the volume level.
	A cellular phone is not connected.	Check the registration procedure, and then register the cellular phone again.
Each volume level (ringtone, incoming voice or outgoing voice) is different.	Each volume level is not adjusted properly.	Adjust each volume level properly.
The antenna display is different between the touch screen display and a cellular phone screen. Making or receiving a call is unavailable even though the antenna display shows that it is possible to do so.	The antenna display varies depending on the model of cellular phone.	This does not indicate a malfunction. The antenna display and remaining battery level shown on the touch screen display may be different from those shown on the cellular phone screen. Use them as a reference.
A voice cannot be heard clearly when using a cellular phone behind tall buildings.	Some structures such as tall buildings, etc. may cause irregular reflection of radio waves or completely shut out radio waves that are used for cellular phones.	Move to a place without tall buildings.
Noise is heard when using a cellular phone under/near areas of elevated railroads, high voltage electric power cables, traffic signals, neon billboards, etc.	Electromagnetic waves that are generated from radio devices may adversely affect the cellular phone.	This is not a malfunction.
Noise is heard in the sound from the audio system while using a cellular phone.	Radio waves that are generated from a cellular phone may adversely affect the sound from the audio system.	This is not a malfunction.
Sound skips or stutters.	The cellular phone may have turned on the wireless LAN (Wi-Fi).	Turn off the wireless LAN (Wi-Fi).
Phonebook cannot be downloaded.	An error occurred during the phone pairing process.	Please delete the Bluetooth® pairing information from both the cellular phone and vehicle system before registering it again.
	Phone does not support phonebook download function.	Use a cellular phone compatible with the system. Ask a NISSAN dealer for information regarding model compatibility.

8-12 Troubleshooting guide

Condition:

[Edit: 2020/ 5/ 28 Model: AV1NJ-A]

Apple CarPlay (if equipped)

AV1NJAI-921676AA-D7C1-4E97-9EC4-367674E9315B

Symptom	Cause and Countermeasure
Cannot start Apple CarPlay though it is tethered to the vehicle.	The USB cable is not connected to the USB connection port. Properly connect the USB cable to the USB connection port. 🔗 "USB (Universal Serial Bus) connection ports" (page 2-5)
	[Start-up Options] is set to [Never Start]. Change the setting to [Auto] or [Ask Every Time]. 🔗 "Apple CarPlay settings" (page 5-6)
	Use an Apple Lightning cable (Mfi certified) to connect your phone to the USB connection port and check that the cable is not broken.
	Apple CarPlay setting is not active on your iPhone. Turn on "CarPlay" on your iPhone.
	The device is not compatible with Apple CarPlay. Check the compatibility requirements.
Apple CarPlay performance decreases. For example, slow connectivity or slow application functionality. or An error message appears when trying to access features of Apple CarPlay. A blank screen appears when trying to access maps.	Confirm you have a compatible iPhone, a cellular connection and an active data plan.
	Use an Apple Lightning cable (Mfi certified) to connect your phone to the USB connection port.
	Phone's performance or cellular connection. Disconnect and reconnect your phone.
Cannot access Siri using < 🗣️ > on the steering wheel.	The USB cable may not be properly connected. Disconnect and reconnect the USB cable.
	Siri setting is not enabled on the phone. Turn on Siri on your phone.
	Check that you are pushing and holding < 🗣️ > instead of just pushing the switch to initiate Siri operation.

Android Auto (if equipped)

AV1NJA1-6A75FEAF-7FAF-487C-9FFB-E2C40B65CC39

Symptom	Cause and Countermeasure
Cannot start Android Auto though it is connected to the vehicle.	The USB cable is not connected to the USB connection port. Properly connect the USB cable to the USB connection port. ☞ "USB (Universal Serial Bus) connection ports" (page 2-5)
	[Start-up Options] is set to [Never Start]. Change the setting to [Auto] or [Ask Every Time]. ☞ "Android Auto settings" (page 5-9)
	To activate Android Auto, touch [▲] on the Launch Bar or touch [Smartphone Connection] on the information screen and then touch [Android Auto]. ☞ "Selecting menu from Launch Bar" (page 2-6) ☞ "Information menu" (page 5-2)
	The connected device is not compatible with Android Auto. Check the compatibility requirements.
	Your Android phone may not be recognized if its battery is low. Charge your Android phone then try again.
Android Auto performance decreases. For example, slow connectivity or slow application functionality. or An error message appears when trying to access features of Android Auto. A blank screen appears when trying to access maps.	Confirm you have a compatible Android phone, a cellular connection and an active data plan.
	Use the Android phone OEM cable to connect your phone to the USB connection port.
	Phone's performance or cellular connection. Disconnect and reconnect your phone.
	Phone's performance or cellular connection. Close all apps and restart them.
Cannot start voice operation using < 🗣️ > on the steering wheel.	Phone's performance or cellular connection. Cycle phone power off/on to restart.
	The USB cable may not be properly connected. Disconnect and reconnect the USB cable.
	Voice operation cannot be performed while driving. Turn on appropriate settings on your Android phone.
	Check that you are pushing and holding < 🗣️ > instead of just pushing the switch to initiate voice operation.



8-14 Troubleshooting guide

Condition:

[Edit: 2020/ 5/ 28 Model: AV1NJ-A]

Siri Eyes Free (if equipped)

AV1NJA1-C0A3173E-939B-470C-AAED-0CAF1B795D9E

Symptom	Cause and Countermeasure
Cannot access Siri Eyes Free using <  > on the steering wheel.	Check if a Bluetooth® connection is established between the iPhone and the system.
	Check if Siri is enabled on the device. On your phone, go to Siri setting.
	Check that Siri can be accessed from the device lock screen. This can be set in the settings menu of your phone.
Audio source does not change automatically to iPod or Bluetooth® Audio mode.	For best results, use the native music app. Performance of music control function while using Podcasts, Audiobook or other third party music apps may vary.
	For best results, play media already stored on your device. Streaming music or playback from cloud storage may degrade performance.
	Switch the source manually.  "Selecting audio source" (page 3-7)
Play, pause, next track, previous track or play timer does not work.	For best results, use the native music app. Performance of music control function while using Podcasts, Audiobook or other third party music apps may vary and is controlled by the device.
Cannot hear any music/audio being played back from a connected iPhone.	Check that the audio source is set to Bluetooth® Audio or iPod mode. A USB connection is required for iPod mode.
Models with navigation system: Cannot hear map turn-by-turn direction guidance from a connected iPhone.	Check that the audio source is set to Bluetooth® Audio or iPod mode. A USB connection is required for iPod mode.
Cannot receive text message notifications on the vehicle audio system.	Check if notification setting is enabled on your phone.
Cannot reply to text message notifications using Siri Eyes Free.	After receiving an incoming text message, follow the on-screen guidance. Push and hold <  > on the steering wheel for Siri Eyes Free operation. After Siri Eyes Free starts, speak an appropriate command to reply to the message using Siri Eyes Free.

NAVIGATION (if equipped)

AV1NJA1-9CDB1CD7-F25C-4AF6-97FF-6E29E3C9EB64

BASIC OPERATIONS

AV1NJA1-63D868E1-81BC-4C67-BECA-983902BED4C1

Symptom	Possible cause	Possible solution
No image is displayed.	The brightness is at the lowest setting.	Adjust the brightness of the display.
	The display is turned off.	Push <*/> to turn on the display.
The volume of the voice guidance is too high or too low.	The volume is not set correctly, or the voice guidance setting is turned off.	Adjust the volume of the voice guidance or turn on the voice guidance setting.
No map is displayed on the screen.	A screen other than a map screen is displayed.	Touch [Map] on the Launch Bar or push <MAP> .
The screen is too dim. The movement is slow.	The temperature in the interior of the vehicle is low.	Wait until the interior of the vehicle has warmed up.
Some pixels in the display are darker or brighter than others.	This condition is an inherent characteristic of liquid crystal displays.	This is not a malfunction.
Some menu items cannot be selected.	Some menu items become unavailable while the vehicle is driven.	Park the vehicle in a safe location, and then operate the navigation system.

8-16 Troubleshooting guide

Condition:

[Edit: 2020/ 5/ 28 Model: AV1NJ-A]

MAP SCREEN

AV1NJAT-COC1C898-A889-456C-A1BE-60ABF2162EC7

Symptom	Possible cause	Possible solution
Names of roads and locations differ between 2D and 3D view.	This is because the quantity of the displayed information is reduced so that the screen does not become too cluttered. There is also a chance that names of the roads or locations may be displayed multiple times, and the names appearing on the screen may be different because of a processing procedure.	This is not a malfunction.
The location of the vehicle icon is misaligned from the actual position.	The vehicle was transported after the ignition switch was placed in the OFF position, for example, by a ferry or car transporter.	Drive the vehicle for a period of time on a road where Global Navigation Satellite System (GNSS) signals can be received.
	The position and direction of the vehicle icon may be incorrect depending on the driving environments and the levels of positioning accuracy of the navigation system.	This is not a malfunction. Drive the vehicle for a period of time to automatically correct the position and direction of the vehicle icon. ☞ "Current vehicle location" (page 6-30)
	Driving with tire chains or tires that have been replaced may result in an incorrect vehicle location display due to miscalculation by the speed sensor.	Drive the vehicle for a period of time (at approximately 30 km/h (19 MPH) for about 30 minutes) to automatically correct the vehicle icon position. If this does not correct the vehicle icon position, it is recommended you contact a NISSAN dealer.
	The map data has a mistake or is incomplete (the vehicle icon position is always misaligned in the same area).	Updated road information will be included in the next version of the map data. ☞ "How to update map data" (page 6-35)
When the vehicle is traveling on a new road, the vehicle icon is located on another road nearby.	Because the new road is not stored in the map data, the system automatically places the vehicle icon on the nearest road available.	Updated road information will be included in the next version of the map data. ☞ "How to update map data" (page 6-35)
The screen does not switch to the night screen even after turning on the headlights.	The daytime screen was set the last time the headlights were turned on.	Set the screen to the night screen mode using  when turning on the headlights.

Troubleshooting guide 8-17

Symptom	Possible cause	Possible solution
The map does not scroll even when the vehicle is moving.	The current location map screen is not displayed.	Touch [Map] on the Launch Bar or push <MAP> .
The vehicle icon is not displayed.	The current location map screen is not displayed.	Touch [Map] on the Launch Bar or push <MAP> .

8-18 Troubleshooting guide

Condition:

ROUTE CALCULATION AND VISUAL GUIDANCE

AV1NJAI-1302203A-3BB3-4E27-A68F-EB2EC58942E3

Symptom	Possible cause	Possible solution
Waypoints are not included in the auto reroute calculation.	Waypoints that have been already passed are not included in the auto reroute calculation.	To go to that waypoint again, edit the route.
Route information is not displayed.	Route calculation has not yet been performed.	Set the destination and perform route calculation.
	The vehicle is not on the suggested route.	Drive on the suggested route.
	Route guidance is turned off.	Turn on route guidance.
	Route information is not provided for certain types of roads.	This is not a malfunction.
The auto reroute calculation (or detour calculation) suggests the same route as the one previously suggested.	Route calculations took priority conditions into consideration, but the same route was calculated.	This is not a malfunction.
A waypoint cannot be added.	Twenty waypoints are already set on the route, including ones that the vehicle has already passed.	A maximum of 20 waypoints can be set on the route. To go to 21 or more waypoints, perform route calculations multiple times as necessary.
The suggested route is not displayed.	Roads near the destination cannot be calculated.	Reset the destination to a main or ordinary road, and recalculate the route.
	The starting point and destination are too close.	Set a more distant destination.
	The starting point and destination are too far away.	Divide the trip by selecting one or two intermediate destinations, and perform route calculations multiple times.
	There are time restricted roads (by the day of the week, by time) near the current vehicle location or destination.	Select [Do Not Use Restriction Info] in the [Time Restricted Roads] setting.  "Route Preference" (page 6-16)
A part of the route is not displayed.	The suggested route includes narrow streets.	This is not a malfunction.

Troubleshooting guide 8-19

Condition:

[Edit: 2020/ 5/ 28 Model: AV1NJ-A]

Symptom	Possible cause	Possible solution
The part of the route that the vehicle has already passed is deleted.	A route is managed by sections between waypoints. If the vehicle passed the first waypoint, the section between the starting point and the waypoint is deleted (it may not be deleted depending on the area).	This is not a malfunction.
An indirect route is suggested.	If there are restrictions (such as one-way streets) on roads close to the starting point or destination, the system may suggest an indirect route.	Adjust the location of the starting point or destination.
	The system may suggest an indirect route because route calculation does not take into consideration some areas such as narrow streets.	Reset the destination to a main or ordinary road, and recalculate the route.
The landmark information does not correspond to the actual information.	This may be caused by insufficient or incorrect map data.	Updated information will be included in the next version of the map data.  "How to update map data" (page 6-35)
The suggested route does not exactly connect to the starting point, waypoints or destination.	There is no data for route calculation closer to these locations.	Set the starting point, waypoints and destination on a main road, and perform route calculation.

8-20 Troubleshooting guide

Condition:

[Edit: 2020/ 5/ 28 Model: AV1NJ-A]

VOICE GUIDANCE

AV1NJ1-A3BC94B6-484D-4996-8E51-9B1AA5530FE5

Symptom	Possible cause	Possible solution
Voice guidance is not available.	The vehicle has deviated from the suggested route.	Go back to the suggested route or request route calculation again.
	Voice guidance is turned off.	Turn on voice guidance.
	Route guidance is turned off.	Turn on route guidance.
The guidance content does not correspond to the actual road conditions.	The content of voice guidance may vary, depending on the types of intersections at which turns are made.	Follow all traffic rules and regulations.

VOICE RECOGNITION

AV1NJ1A1-A8BC0EA8-7703-45A1-ACE6-B63B09F42786

Symptom	Possible cause	Possible solution
The system does not operate or fails to interpret the command correctly.	The interior of the vehicle is too noisy.	Close the windows or have the other occupants be quiet.
	The fan speed of the heater/air conditioner is too fast.	Decrease the fan speed of the heater/air conditioner.
	The noise generated by driving the vehicle is too loud.	Reduce the vehicle speed.
	The voice command is spoken in a low voice.	Speak the command in a louder voice.
	The timing of speaking a command is too early.	Speak the command after confirming the following: a voice guidance is announced, a tone sounds, and an icon on the screen changes from gray to orange.
	The command is spoken too slowly.	Speak in a natural voice without pausing between words.
The system prompts to repeat a command.	Pronunciation is unclear.	Speak clearly.
	The command is spoken too late after the tone.	Speak the command within 5 seconds after confirming the following: a voice guidance is announced, a tone sounds, and an icon on the screen changes from gray to orange.
	An improper command is spoken.	Speak the command or a number that is displayed on the screen. Speak a command that is shown in the command list.
The system does not correctly recognize a number spoken.	Too many numbers are spoken at once.	Place a pause between the appropriate digits for correct recognition by the system. When speaking a phone number, place a pause between area codes, dial codes, etc.
USB memory device cannot be operated with voice commands.	Depending on the device, iPhone or iPod may be recognized as a USB memory device.	This is not a malfunction.
The USB/iPod operation screen is grayed out.	The audio device is not connected.	Connect an audio device to the system.

8-22 Troubleshooting guide

Condition:

[Edit: 2020/ 5/ 28 Model: AV1NJ-A]

Symptom	Possible cause	Possible solution
An error message is displayed when trying to select a track and operate USB/iPod.	The track information is being processed for registration by the system.	Song information will be loaded into the system when a new audio device is registered for the first time or when the song information in the pre-registered device has been changed. Please wait for the loading to complete which may take a few minutes to up to an hour.
	A number of songs exceeding the amount the device can contain are stored in the connected audio device.	Decrease the number of songs stored in the audio device.
	No song is stored in the audio device.	Store songs in the connected audio device. Storing songs with information such as artist name, album name, song name, playlist, etc., will make voice recognition song search available.



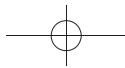

(132,1)



MEMO

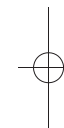
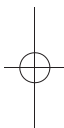

8-24 Troubleshooting guide



Condition:

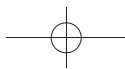

[Edit: 2020/ 5/ 28 Model: AV1NJ-A]



9 Index

Number

- 2D map 6-3
- 3D map 6-4

A

- About route guidance 6-12
- Android Auto 5-7
- Apple CarPlay 5-3
- Audio operation precautions 3-2
- Audio operations 3-7

B

- Bluetooth® audio 3-7
- Bluetooth® Hands-Free Phone System 4-2
- Building graphics 6-5

C

- Changing order of destination and waypoints 6-19
- Changing scale of map 6-6
- Compass mode display 6-5
- Connecting Bluetooth® Hands-Free Phone 4-4
- Connections settings 2-11
- Control buttons and touch screen display 2-2
- Current vehicle location 6-30

D

- Deleting stored item 6-26
- Destination setting menu 6-10
- Displaying navigation screen 6-2
- During a call 4-5

E

- Editing route 6-18
- Editing stored information 6-23

F

- Functions disabled while driving 2-8

G

- Giving voice commands 7-2

H

- Hands-free text messaging assistant 4-6
- How to see voice command screen ... 7-3

I

- Information menu 5-2

L

- Launch Bar 2-6
- Licenses 1-4
- Liquid crystal display 2-3

M

- Making a call 4-4
- Map Menu screen 6-10
- Map types 6-3
- Map view settings 6-7
- Moving map 6-6

N

- Navigation screen 6-2
- Navigation settings 6-28

O

- One Shot Call 7-3
- Options before starting the route guidance 6-12

P

- Phone 4-4
- Phone selection 4-4
- Phone settings 4-10

Q

- Quick Dial 4-12

R

- Radio 3-2, 3-8
- Recalculating route 6-18
- Receiving a call 4-4

Route calculation 6-33
 Route guidance 6-12, 6-34

S

Safety information 1-3, 6-2
 Settings menu 2-9
 Siri Eyes Free 5-10
 Starting system 2-6
 Storing a location/route 6-21
 Storing avoid area 6-22
 Storing home location 6-21
 Storing location 6-21
 Storing route 6-22
 Swipe-down notifications 2-7
 System settings 2-9
 System voice settings 7-4

T

Text message settings 4-10
 Touch screen display 2-3
 Trademarks 1-4

U

USB (Universal Serial Bus)
 connection ports 2-5
 USB memory device care
 and cleaning 3-19

V

Voice Prompt Interrupt 7-3
 Voice recognition 7-2

9-2 Index

Condition:

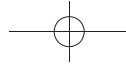

(135,1)



MEMO

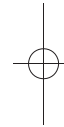
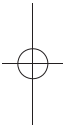

Index 9-3



Condition:

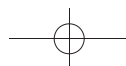

[Edit: 2020/ 5/ 28 Model: AV1NJ-A]



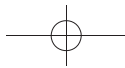

(136,1)



MEMO

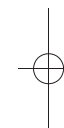
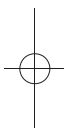

9-4 Index



Condition:

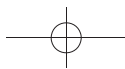

[Edit: 2020/ 5/ 28 Model: AV1NJ-A]



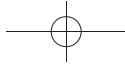

(137,1)



MEMO

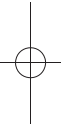
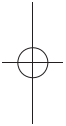

Index 9-5



Condition:

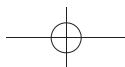

[Edit: 2020/ 5/ 28 Model: AV1NJ-A]

