

FCC RF Test Report

(U-NII)

Report No.: JYTSZ-R12-2400168
Applicant: Hangzhou Roombanker Technology Co., Ltd.
Address of Applicant: A#801 Wantong center, Hangzhou, China

Equipment Under Test (EUT)

Product Name: Industrial AI Edge Computing Gateway
Model No.: DSGW-380, DSGW-380-1, DSGW-380-2, DSGW-380-3, DSGW-380-4, DSGW-380-X(X:1~29)
Trade Mark: Roombanker
FCC ID: 2AUXBDSGW-380
Applicable Standards: FCC CFR Title 47 Part 15E (§15.407)
Date of Sample Receipt: 26 Feb., 2024
Date of Test: 27 Feb., to 29 May, 2024
Date of Report Issued: 09 Aug., 2024
Test Result: PASS

Tested by:		Date:	09 Aug., 2024
Reviewed by:	Project Engineer	Date:	09 Aug., 2024
Approved by:	Senior Engineer Janet Wei Manager	Date:	09 Aug., 2024

This equipment has been shown to be capable of compliance with the applicable technical standards as indicated in the measurement report and was tested in accordance with the measurement procedures specified in above the application standard version. Test results reported herein relate only to the item(s) tested.

This document cannot be reproduced except in full, without prior written approval of the Company. Any unauthorized alteration, forgery or falsification of the content or appearance of this document is unlawful and offenders may be prosecuted to the fullest extent of the law. Unless otherwise stated the results shown in this test report refer only to the sample(s) tested and such sample(s) are retained for 90 days only.

1 Version

Version No.	Date	Description
00	29 May, 2024	Original
01	09 Aug., 2024	Update Page 12

2 Contents

Page

Cover Page	1
1 Version	2
2 Contents	3
3 General Information	4
3.1 Client Information	4
3.2 General Description of E.U.T.	4
3.3 Test Mode and Environment	5
3.4 Description of Test Auxiliary Equipment	5
3.5 Measurement Uncertainty	5
3.6 Additions to, Deviations, or Exclusions from the Method	5
3.7 Laboratory Facility	6
3.8 Laboratory Location	6
3.9 Test Instruments List	7
4 Measurement Setup and Procedure	9
4.1 Test Channel	9
4.2 Test Setup	9
4.3 Test Procedure	11
5 Test Results	12
5.1 Summary	12
5.1.1 Clause and Data Summary	12
5.1.2 Test Limit	13
5.2 Antenna requirement	15
5.3 AC Power Line Conducted Emission	16
5.4 Unwanted Emissions	18

3 General Information

3.1 Client Information

Applicant:	Hangzhou Roombanker Technology Co., Ltd.
Address:	A#801 Wantong center, Hangzhou, China
Manufacturer/ Factory:	Zhejiang Dusun Electron Co., Ltd.
Address:	No.640 Feng Qing St, DeQing Zhejiang China

3.2 General Description of E.U.T.

Product Name:	Industrial AI Edge Computing Gateway
Model No.:	DSGW-380, DSGW-380-1, DSGW-380-2, DSGW-380-3, DSGW-380-4, DSGW-380-X(X:1~29)
Operation Frequency:	Band 1: 5150 MHz - 5250 MHz
	Band 4: 5725 MHz - 5850 MHz
Channel Numbers:	Band 1: 4 , Band 4: 5 (802.11a, n-HT20, ac-VHT20, ax-HE20)
	Band 1, 4: 2 (802.11n-HT40, ac-VHT40, ax-HE40)
	Band 1, 4: 1 (802.11ac-VHT80, ax-HE80)
Modulation Technology: (IEEE 802.11a/802.11n)	OFDM-BPSK, QPSK, 16QAM, 64QAM
Modulation Technology: (IEEE 802.11ac)	OFDM-BPSK, QPSK, 16QAM, 64QAM, 256QAM
Modulation Technology: (IEEE 802.11ax)	OFDMA-BPSK, QPSK, 16QAM, 64QAM, 256QAM, 1024QAM
Antenna Type:	External Antenna
Antenna Gain:	Wi-Fi ANT 1 : 5.2G 0.75 dBi (declare by applicant) 5.8G 0.87 dBi (declare by applicant) Wi-Fi ANT 2 : 5.2G 0.75 dBi (declare by applicant) 5.8G 0.87 dBi (declare by applicant)
Antenna Transmit Mode:	MIMO (2TX, 2RX)
Power Supply:	DC 12V
Remark:	Model No.: DSGW-380, DSGW-380-1, DSGW-380-2, DSGW-380-3, DSGW-380-4, DSGW-380-X(X:1~29) were identical inside, the electrical circuit design, layout, components used and internal wiring, with only difference being model name.
Test Sample Condition:	The test samples were provided in good working order with no visible defects.

3.3 Test Mode and Environment

Test Mode:	
Transmitting mode:	Keep the EUT in continuous transmitting with modulation
Per-scan all kind of data rate, the follow list were the worst case:	
Mode	Data rate
802.11a	6.0 Mbps
802.11n-HT20	6.5 Mbps
802.11n-HT40	13.5 Mbps
802.11ac-VHT20	6.5 Mbps
802.11ac-VHT40	13.5 Mbps
802.11ac-VHT80	29.3 Mbps
802.11ax-HE20	8.6 Mbps
802.11ax-HE40	17.2 Mbps
802.11ax-HE80	36.0 Mbps
<p><i>Remark: For AC power line conducted emission and radiated spurious emission (below 1GHz), pre-scan 802.11a, n, ac, ax modulation mode, found 802.11a modulation mode was worse case mode. The report only reflects the test data of worst mode.</i></p>	
Operating Environment:	
Temperature:	15°C ~ 35°C
Humidity:	20 % ~ 75 % RH
Atmospheric Pressure:	1008 mbar
Voltage:	Nominal: 12.0 Vdc, Extreme: Low 10.2 Vdc, High 13.8 Vdc
Test Engineer:	Robin Gu, Asher Zhang(Radiated measurement)

3.4 Description of Test Auxiliary Equipment

The EUT has been tested as an independent unit.

3.5 Measurement Uncertainty

Parameter	Expanded Uncertainty (Confidence of 95%(U = 2Uc(y)))
Conducted Emission for LISN (9kHz ~ 150kHz)	3.57 dB
Conducted Emission for LISN (150kHz ~ 30MHz)	3.14 dB
Radiated Emission (30MHz ~ 200MHz) (10m SAC)	4.3 dB
Radiated Emission (200MHz ~ 1000MHz) (10m SAC)	4.3 dB
Radiated Emission (30MHz ~ 1GHz) (3m FAR)	3.43 dB
Radiated Emission (1GHz ~ 6GHz) (3m FAR)	4.95 dB
Radiated Emission (6GHz ~ 18GHz) (3m FAR)	5.23 dB
Radiated Emission (18GHz ~ 40GHz) (3m FAR)	5.32 dB
<p><i>Note: All the measurement uncertainty value were shown with a coverage k=2 to indicate 95% level of confidence. The measurement data show herein meets or exceeds the CISPR measurement uncertainty values specified in CISPR 16-4-2 and can be compared directly to specified limit to determine compliance.</i></p>	

3.6 Additions to, Deviations, or Exclusions from the Method

No

3.7 Laboratory Facility

The test facility is recognized, certified, or accredited by the following organizations:

- **FCC - Designation No.: CN1211**

JianYan Testing Group Shenzhen Co., Ltd. has been accredited as a testing laboratory by FCC(Federal Communications Commission). The test firm Registration No. is 727551.

- **ISED – CAB identifier.: CN0021**

The 3m Semi-anechoic chamber and 10m Semi-anechoic chamber of JianYan Testing Group Shenzhen Co., Ltd. has been Registered by Certification and Engineering Bureau of Industry Canada for radio equipment testing with Registration No.: 10106A-1.

- **CNAS - Registration No.: CNAS L15527**

JianYan Testing Group Shenzhen Co., Ltd. is accredited to ISO/IEC 17025:2017 General Requirements for the Competence of Testing and Calibration laboratories for the competence of testing. The Registration No. is CNAS L15527.

- **A2LA - Registration No.: 4346.01**

This laboratory is accredited in accordance with the recognized International Standard ISO/IEC 17025:2017 General requirements for the competence of testing and calibration laboratories. The test scope can be found as below link: <https://portal.a2la.org/scopepdf/4346-01.pdf>

3.8 Laboratory Location

JianYan Testing Group Shenzhen Co., Ltd.

Address: No.101, Building 8, Innovation Wisdom Port, No.155 Hongtian Road, Huangpu Community, Xinqiao Street, Bao'an District, Shenzhen, Guangdong, People's Republic of China.

Tel: +86-755-23118282, Fax: +86-755-23116366

Email: info-JYTee@lets.com, Website: <http://jyt.lets.com>

3.9 Test Instruments List

Radiated Emission(3m FAR):					
Test Equipment	Manufacturer	Model No.	Manage No.	Cal. Date (mm-dd-yy)	Cal. Due date (mm-dd-yy)
3m FAR	YUNYI	9m*6m*6m	WXJ097	06-15-2023	06-14-2028
BiConiLog Antenna	Schwarzbeck	VULB9163	WXJ097-2	07-13-2023	07-12-2024
Biconical Antenna	Schwarzbeck	VUBA9117	WXJ002-1	07-02-2021	07-01-2024
Horn Antenna	Schwarzbeck	BBHA9120D	WXJ097-3	07-14-2023	07-13-2024
Horn Antenna	Schwarzbeck	BBHA9120D	WXJ002-3	12-28-2023	12-27-2024
Horn Antenna	Schwarzbeck	BBHA9170	WXJ002-5	12-28-2023	12-27-2024
Horn Antenna	Schwarzbeck	BBHA9170	WXJ002-6	12-28-2023	12-27-2024
Pre-amplifier (30MHz ~ 1GHz)	YUNYI	PAM-310N	WXJ097-5	05-14-2023	05-13-2024
				04-24-2024	04-23-2025
Pre-amplifier (1GHz ~ 18GHz)	YUNYI	PAM-118N	WXJ097-6	05-14-2023	05-13-2024
				04-24-2024	04-23-2025
Pre-amplifier (18GHz ~ 40GHz)	RF System	TRLA-180400G45B	WXJ002-7	12-28-2023	12-27-2024
EMI Test Receiver	Rohde & Schwarz	ESCI3	WXJ003	12-27-2023	12-26-2024
Spectrum Analyzer	Rohde & Schwarz	FSP 30	WXJ004	12-27-2023	12-26-2024
Spectrum Analyzer	KEYSIGHT	N9010B	WXJ081-1	06-13-2023	06-12-2024
Coaxial Cable (30MHz ~ 1GHz)	JYTSZ	JYT3M-1G-NN-13M	WXG097-1	08-01-2023	07-31-2024
Coaxial Cable (1GHz ~ 18GHz)	JYTSZ	JYT3M-18G-NN-8M	WXG097-2	08-01-2023	07-31-2024
Coaxial Cable (18GHz ~ 40GHz)	JYTSZ	JYT3M-40G-SS-8M	WXG097-3	08-01-2023	07-31-2024
High Band Reject Filter Group	Tonscend	JS0806-F	WXJ089	N/A	
Low Band Reject Filter Group	Tonscend	JS0806-F	WXJ097-4	N/A	
Test Software	Tonscend	TS+	Version: 5.0.0		

Radiated Emission(10m SAC):					
Test Equipment	Manufacturer	Model No.	Manage No.	Cal. Date (mm-dd-yy)	Cal. Due date (mm-dd-yy)
10m SAC	ETS	RFSD-100-F/A	WXJ090	04-28-2021	04-27-2026
BiConiLog Antenna	SCHWARZBECK	VULB 9168	WXJ090-1	01-05-2024	01-04-2025
BiConiLog Antenna	SCHWARZBECK	VULB 9168	WXJ090-2	12-28-2023	12-27-2024
EMI Test Receiver	R&S	ESR 3	WXJ090-3	12-27-2023	12-26-2024
EMI Test Receiver	R&S	ESR 3	WXJ090-4	12-27-2023	12-26-2024
Low Pre-amplifier	Bost	LNA 0920N	WXJ090-6	12-27-2023	12-26-2024
Low Pre-amplifier	Bost	LNA 0920N	WXJ090-7	12-27-2023	12-26-2024
Cable	Bost	JYT10M-1G-NN-10M	WXG002-7	01-17-2024	01-16-2025
Cable	Bost	JYT10M-1G-NN-10M	WXG002-8	01-17-2024	01-16-2025
Test Software	R&S	EMC32	Version: 10.50.40		

Conducted Emission:					
Test Equipment	Manufacturer	Model No.	Manage No.	Cal. Date (mm-dd-yy)	Cal. Due date (mm-dd-yy)
EMI Test Receiver	Rohde & Schwarz	ESR3	WXJ003-2	07-05-2023	07-04-2024
LISN	Schwarzbeck	NSLK 8127	QCJ001-13	12-27-2023	12-26-2024
LISN	Rohde & Schwarz	ESH3-Z5	WXJ005-1	12-27-2023	12-26-2024
LISN Coaxial Cable (9kHz ~ 30MHz)	JYTSZ	JYTCE-1G-NN-2M	WXG003-1	01-17-2024	01-16-2025
Test Software	AUDIX	E3	Version: 6.110919b		

Conducted Method:					
Test Equipment	Manufacturer	Model No.	Manage No.	Cal. Date (mm-dd-yy)	Cal. Due date (mm-dd-yy)
Spectrum Analyzer	Keysight	N9010B	WXJ004-3	11-01-2023	10-31-2024
Temperature Humidity Chamber	ZHONG ZHI	CZ-A-80D	WXJ032-3	01-09-2023	01-08-2025
Power Detector Box	MWRFTTEST	MW100-PSB	WXJ007-4	09-25-2023	09-24-2024
RF Control Unit	MWRFTTEST	MW100-RFCB	WXG006	N/A	
RF Switch	TOP PRECISION	RSU0301	WXG003	N/A	
DC Power Supply	Keysight	E3642A	WXJ025-2	N/A	
Test Software	MWRFTTEST	MTS 8310	Version: 2.0.0.0		

4 Measurement Setup and Procedure

4.1 Test Channel

According to ANSI C63.10-2013 chapter 5.6.1 Table 4 requirement, select lowest channel, middle channel, and highest channel in the frequency range in which device operates for testing. The detailed frequency points are as follows:

Operation frequency: 5150 MHz – 5250 MHz						
Modulation mode	Lowest channel		Middle channel		Highest channel	
	Channel No.	Frequency (MHz)	Channel No.	Frequency (MHz)	Channel No.	Frequency (MHz)
802.11a, n-HT20, ac-VHT20, ax-HE20	36	5180	40	5200	48	5240
802.11n-HT40, ac-VHT40, ax-HE40	38	5190	/	/	46	5230
802.11ac-VHT80, ax-HE80	/	/	42	5210	/	/

Operation frequency: 5725 MHz – 5850 MHz						
Modulation mode	Lowest channel		Middle channel		Highest channel	
	Channel No.	Frequency (MHz)	Channel No.	Frequency (MHz)	Channel No.	Frequency (MHz)
802.11a, n-HT20, ac-VHT20, ax-HE20	149	5745	157	5785	165	5825
802.11n-HT40, ac-VHT40, ax-HE40	151	5755	/	/	159	5795
802.11ac-VHT80, ax-HE80	/	/	155	5775	/	/

4.2 Test Setup

1) Conducted emission measurement:

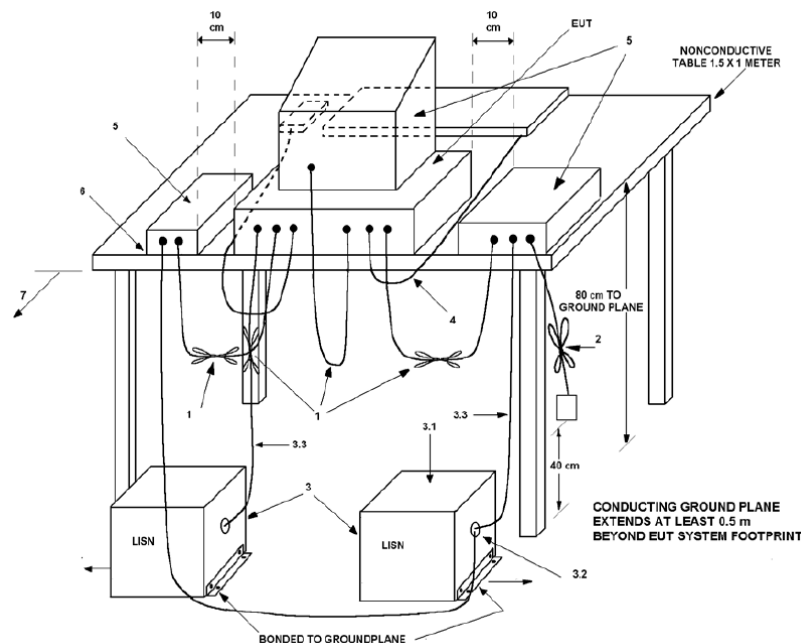

Note: The detailed descriptions please refer to Figure 8 of ANSI C63.4:2014.

2) Radiated emission measurement:

Below 1GHz (10m SAC)

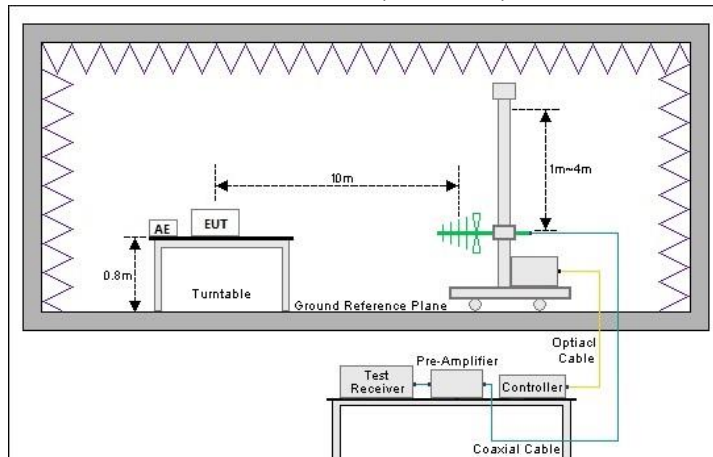

Above 1GHz (3m FAR)

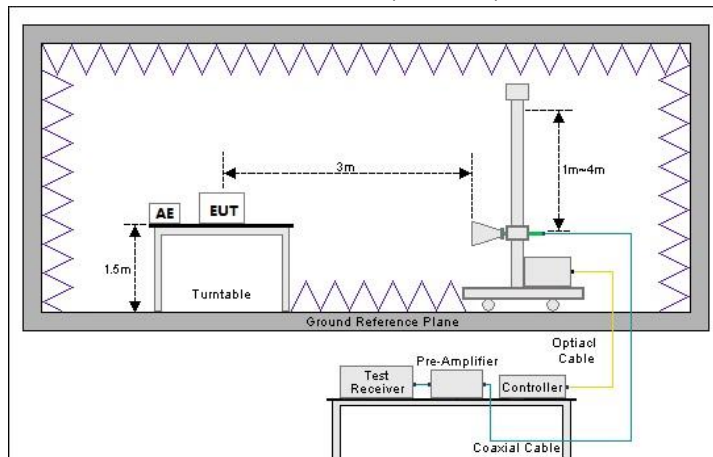

3) Conducted test method

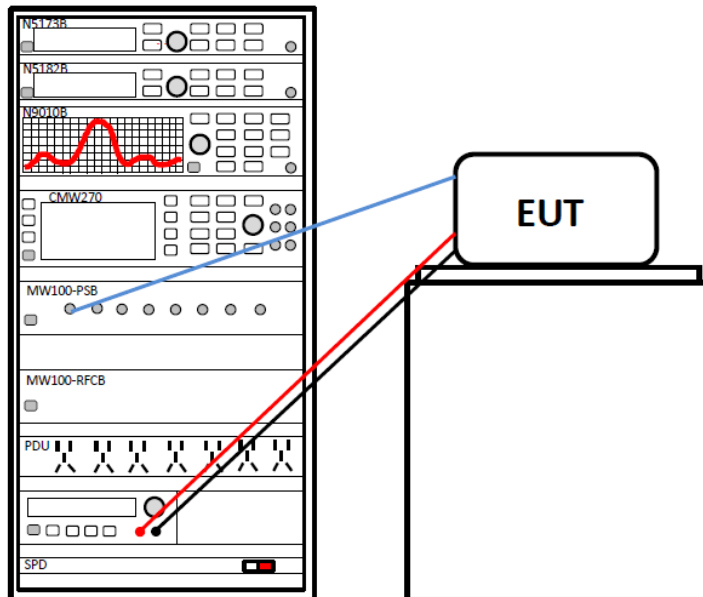

4.3 Test Procedure

Test method	Test step
Conducted emission	<ol style="list-style-type: none"> The E.U.T and simulators are connected to the main power through a line impedance stabilization network (L.I.S.N.). This provides a 50ohm/50uH coupling impedance for the measuring equipment. The peripheral devices are also connected to the main power through a LISN that provides a 50ohm/50uH coupling impedance with 50ohm termination. (Please refer to the block diagram of the test setup and photographs). Both sides of A.C. line are checked for maximum conducted interference. In order to find the maximum emission, the relative positions of equipment and all of the interface cables must be changed according to ANSI C63.10 on conducted measurement.
Radiated emission	<p>For below 1GHz:</p> <ol style="list-style-type: none"> The EUT was placed on the table top of a rotating table 0.8 m the ground at a 10 m semi anechoic chamber. The measurement distance from the EUT to the receiving antenna is 10 m. EUT works in each mode of operation that needs to be tested , and having the EUT continuously working, respectively on 3 axis (X, Y & Z) and considered typical configuration to obtain worst position. The highest signal levels relative to the limit shall be determined by rotating the EUT from 0° to 360° and with varying the measurement antenna height between 1 m and 4 m in vertical and horizontal polarizations. Open the test software to control the test antenna and test turntable. Perform the test, save the test results, and export the test data. <p>For above 1GHz:</p> <ol style="list-style-type: none"> The EUT was placed on the table top of a rotating table 1.5 m the ground at a 3 m fully anechoic room. The measurement distance from the EUT to the receiving antenna is 3 m. EUT works in each mode of operation that needs to be tested , and having the EUT continuously working, respectively on 3 axis (X, Y & Z) and considered typical configuration to obtain worst position. The highest signal levels relative to the limit shall be determined by rotating the EUT from 0° to 360° and with varying the measurement antenna height between 1 m and 4 m in vertical and horizontal polarizations. Open the test software to control the test antenna and test turntable. Perform the test, save the test results, and export the test data.
Conducted test method	<ol style="list-style-type: none"> The Wi-Fi antenna port of EUT was connected to the test port of the test system through an RF cable. The EUT is keeping in continuous transmission mode and tested in all modulation modes. Open the test software, prepare a test plan, and control the system through the software. After the test is completed, the test report is exported through the test software.

5 Test Results

5.1 Summary

5.1.1 Clause and Data Summary

Test items	Standard clause	Test data	Result
Antenna Requirement	15.203	See Section 5.2	Pass
AC Power Line Conducted Emission	15.207 15.407 (b)(9)	See Section 5.3	Pass
Duty Cycle	ANSI C63.10-2013	Please refer to FCC ID: 2AL6KBL-M8852BS2, report No.: ZKT-2310248076E-3.	Please refer to FCC ID: 2AL6KBL-M8852BS2, report No.: ZKT-2310248076E-3.
Conducted Peak Output Power Power Spectral Density	15.407 (a)(1)(iv)-(B1), (a)(3)(i)-(B4)	1. Appendix A– 5G Wi-Fi Appendix A– 5G Wi-Fi (Power) 2. Please refer to FCC ID: 2AL6KBL-M8852BS2, report No.: ZKT-2310248076E-3.	1.Pass 2. Please refer to FCC ID: 2AL6KBL-M8852BS2, report No.: ZKT-2310248076E-3.
26dB Emission Bandwidth 99% Occupied Bandwidth	15.407 (a)(12)	Please refer to FCC ID: 2AL6KBL-M8852BS2, report No.: ZKT-2310248076E-3.	Please refer to FCC ID: 2AL6KBL-M8852BS2, report No.: ZKT-2310248076E-3.
6dB Emission Bandwidth	15.407 (e)	Please refer to FCC ID: 2AL6KBL-M8852BS2, report No.: ZKT-2310248076E-3.	Please refer to FCC ID: 2AL6KBL-M8852BS2, report No.: ZKT-2310248076E-3.
Unwanted Emissions	15.205 15.209 15.407 (b)(1) -(B1), (4) - (B4), (9), (10)	Please refer to FCC ID: 2AL6KBL-M8852BS2, report No.: ZKT-2310248076E-3.	Please refer to FCC ID: 2AL6KBL-M8852BS2, report No.: ZKT-2310248076E-3.
Frequency Stability	15.407 (g)	Please refer to FCC ID: 2AL6KBL-M8852BS2, report No.: ZKT-2310248076E-3.	Please refer to FCC ID: 2AL6KBL-M8852BS2, report No.: ZKT-2310248076E-3.
Dynamic frequency selection	15.407 (h)(2)	N/A	N/A
Remark: 1. Pass: The EUT complies with the essential requirements in the standard. 2. The cable insertion loss used by “RF Output Power” and other conduction measurement items is 1.0dB (provided by the customer). 3. N/A: Not require. 4. Please refer to 2AL6KBL-M8852BS2, report No.: ZKT-2310248076E-3. issued by Shenzhen ZKT Technology Co., Ltd. 5. FCC ID: 2AL6KBL-M8852BS2 module also support 5G Wi-Fi Band 2 and Band 3, they will be disabled on the software, so there no need to test 5G Wi-Fi Band 2 and Band 3.			
Test Method:	ANSI C63.10-2013 KDB 789033 D02 General U-NII Test Procedures New Rules v02r01		

5.1.2 Test Limit

Test items	Limit															
AC Power Line Conducted Emission	<table border="1"> <thead> <tr> <th data-bbox="603 280 898 342">Frequency (MHz)</th> <th colspan="2" data-bbox="898 280 1437 315">Limit (dBµV)</th> </tr> <tr> <td></td> <th data-bbox="898 315 1171 342">Quasi-Peak</th> <th data-bbox="1171 315 1437 342">Average</th> </tr> </thead> <tbody> <tr> <td data-bbox="603 342 898 371">0.15 – 0.5</td> <td data-bbox="898 342 1171 371">66 to 56 ^{Note 1}</td> <td data-bbox="1171 342 1437 371">56 to 46 ^{Note 1}</td> </tr> <tr> <td data-bbox="603 371 898 400">0.5 – 5</td> <td data-bbox="898 371 1171 400">56</td> <td data-bbox="1171 371 1437 400">46</td> </tr> <tr> <td data-bbox="603 400 898 430">5 – 30</td> <td data-bbox="898 400 1171 430">60</td> <td data-bbox="1171 400 1437 430">50</td> </tr> </tbody> </table> <p data-bbox="614 439 1310 463">Note 1: The limit level in dBµV decreases linearly with the logarithm of frequency.</p> <p data-bbox="614 465 1166 490">Note 2: The more stringent limit applies at transition frequencies.</p>	Frequency (MHz)	Limit (dBµV)			Quasi-Peak	Average	0.15 – 0.5	66 to 56 ^{Note 1}	56 to 46 ^{Note 1}	0.5 – 5	56	46	5 – 30	60	50
Frequency (MHz)	Limit (dBµV)															
	Quasi-Peak	Average														
0.15 – 0.5	66 to 56 ^{Note 1}	56 to 46 ^{Note 1}														
0.5 – 5	56	46														
5 – 30	60	50														
Conducted Peak Output Power Power Spectral Density	<p data-bbox="579 517 932 542">For the 5.15-5.25 GHz band:</p> <p data-bbox="579 555 1474 801">For client devices in the 5.15-5.25 GHz band, the maximum conducted output power over the frequency band of operation shall not exceed 250 mW provided the maximum antenna gain does not exceed 6 dBi. In addition, the maximum power spectral density shall not exceed 11 dBm in any 1 megahertz band. If transmitting antennas of directional gain greater than 6 dBi are used, both the maximum conducted output power and the maximum power spectral density shall be reduced by the amount in dB that the directional gain of the antenna exceeds 6 dBi.</p> <p data-bbox="579 853 962 878">For the band 5.725-5.895 GHz:</p> <p data-bbox="579 891 1474 1391">For the band 5.725-5.850 GHz, the maximum conducted output power over the frequency band of operation shall not exceed 1 W. In addition, the maximum power spectral density shall not exceed 30 dBm in any 500-kHz band. If transmitting antennas of directional gain greater than 6 dBi are used, both the maximum conducted output power and the maximum power spectral density shall be reduced by the amount in dB that the directional gain of the antenna exceeds 6 dBi. However, Fixed point-to-point U-NII devices operating in this band may employ transmitting antennas with directional gain greater than 6 dBi without any corresponding reduction in transmitter conducted power. Fixed, point-to-point operations exclude the use of point-to-multipoint systems, omnidirectional applications, and multiple collocated transmitters transmitting the same information. The operator of the U-NII device, or if the equipment is professionally installed, the installer, is responsible for ensuring that systems employing high gain directional antennas are used exclusively for fixed, point-to-point operations.</p>															
26dB Emission Bandwidth 99% Occupied Bandwidth	N/A															
6dB Emission Bandwidth	Within the 5.725-5.850 GHz and 5.850-5.895 GHz bands, the minimum 6 dB bandwidth of U-NII devices shall be at least 500 kHz.															

<p>Unwanted Emissions</p>	<p>(1) For transmitters operating in the 5.15-5.25 GHz band: All emissions outside of the 5.15-5.35 GHz band shall not exceed an e.i.r.p. of 27 dBm/MHz.</p> <p>(4) For transmitters operating solely in the 5.725-5.850 GHz band: All emissions shall be limited to a level of 27 dBm/MHz at 75 MHz or more above or below the band edge increasing linearly to 10 dBm/MHz at 25 MHz above or below the band edge, and from 25 MHz above or below the band edge increasing linearly to a level of 15.6 dBm/MHz at 5 MHz above or below the band edge, and from 5 MHz above or below the band edge increasing linearly to a level of 27 dBm/MHz at the band edge.</p> <p>(5) Unwanted emissions below 1 GHz must comply with the general field strength limits set forth in § 15.209. The provisions of § 15.205 apply to intentional radiators operating under this section:</p> <table border="1" data-bbox="580 732 1455 929"> <thead> <tr> <th rowspan="2">Frequency (MHz)</th> <th colspan="2">Limit (dBµV/m)</th> <th rowspan="2">Detector</th> </tr> <tr> <th>@ 3m</th> <th>@ 10m</th> </tr> </thead> <tbody> <tr> <td>30 – 88</td> <td>40.0</td> <td>30.0</td> <td>Quasi-peak</td> </tr> <tr> <td>88 – 216</td> <td>43.5</td> <td>33.5</td> <td>Quasi-peak</td> </tr> <tr> <td>216 – 960</td> <td>46.0</td> <td>36.0</td> <td>Quasi-peak</td> </tr> <tr> <td>960 – 1000</td> <td>54.0</td> <td>44.0</td> <td>Quasi-peak</td> </tr> </tbody> </table> <p>Note: The more stringent limit applies at transition frequencies.</p> <table border="1" data-bbox="580 958 1455 1064"> <thead> <tr> <th rowspan="2">Frequency</th> <th colspan="2">Limit (dBµV/m) @ 3m</th> </tr> <tr> <th>Average</th> <th>Peake</th> </tr> </thead> <tbody> <tr> <td>Above 1 GHz</td> <td>54.0</td> <td>74.0</td> </tr> </tbody> </table> <p>Note: The measurement bandwidth shall be 1 MHz or greater.</p>	Frequency (MHz)	Limit (dBµV/m)		Detector	@ 3m	@ 10m	30 – 88	40.0	30.0	Quasi-peak	88 – 216	43.5	33.5	Quasi-peak	216 – 960	46.0	36.0	Quasi-peak	960 – 1000	54.0	44.0	Quasi-peak	Frequency	Limit (dBµV/m) @ 3m		Average	Peake	Above 1 GHz	54.0	74.0
Frequency (MHz)	Limit (dBµV/m)		Detector																												
	@ 3m	@ 10m																													
30 – 88	40.0	30.0	Quasi-peak																												
88 – 216	43.5	33.5	Quasi-peak																												
216 – 960	46.0	36.0	Quasi-peak																												
960 – 1000	54.0	44.0	Quasi-peak																												
Frequency	Limit (dBµV/m) @ 3m																														
	Average	Peake																													
Above 1 GHz	54.0	74.0																													
<p>Frequency Stability</p>	<p>Manufacturers of U-NII devices are responsible for ensuring frequency stability such that an emission is maintained within the band of operation under all conditions of normal operation as specified in the users manual.</p>																														

5.2 Antenna requirement

Standard requirement:	FCC Part 15 C Section 15.203
<p>15.203 requirement: An intentional radiator shall be designed to ensure that no antenna other than that furnished by the responsible party shall be used with the device. The use of a permanently attached antenna or of an antenna that uses a unique coupling to the intentional radiator, the manufacturer may design the unit so that a broken antenna can be replaced by the user, but the use of a standard antenna jack or electrical connector is prohibited.</p>	
E.U.T Antenna:	
<p>The Wi-Fi antenna is external antenna which cannot replace by end-user, the best case gain of the antenna are Wi-Fi ANT 1:5.2G Wi-Fi 0.75 dBi ,5.8G Wi-Fi 0.87 dBi and Wi-Fi ANT 1:5.2G Wi-Fi 0.75 dBi ,5.8G Wi-Fi 0.87 dBi. See product internal photos for details.</p>	

5.3 AC Power Line Conducted Emission

Product name:	Industrial AI Edge Computing Gateway	Product model:	DSGW-380
Test by:	Asher Zhang	Test mode:	5G Wi-Fi mode
Test frequency:	150 kHz ~ 30 MHz	Phase:	Line
Test voltage:	AC 120 V/60 Hz		

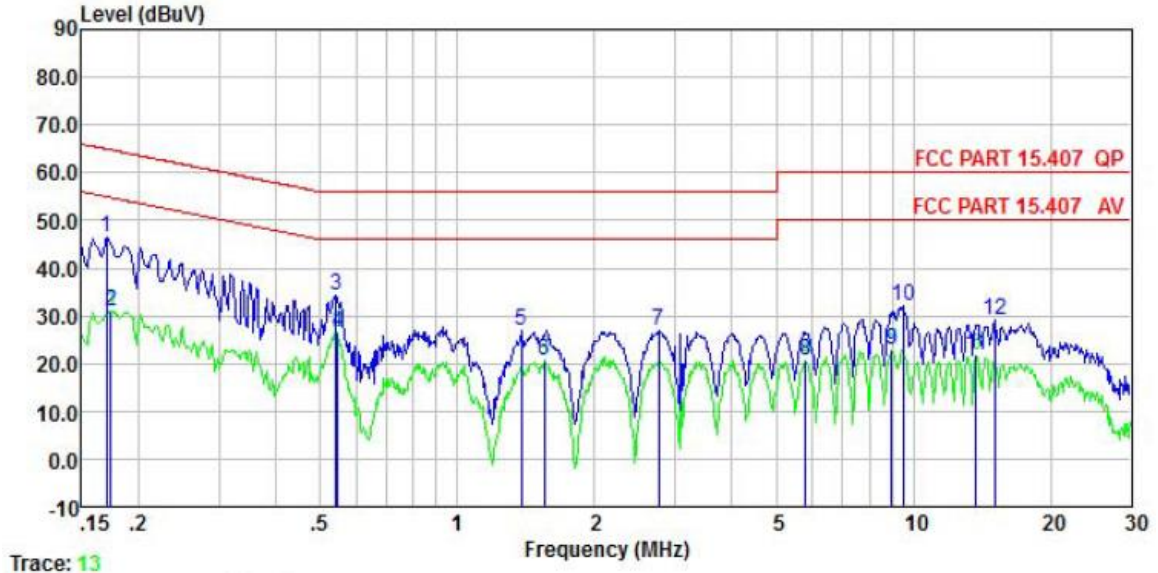

Trace: 13

	Read Freq	Read Level	LISN Factor	Aux Factor	Aux2 Factor	Cable Loss	Level	Limit Line	Over Limit	Remark
	MHz	dBuV	dB	dB	dB	dB	dBuV	dBuV	dB	
1	0.170	35.70	0.20	0.00	10.50	0.01	46.41	64.94	-18.53	QP
2	0.174	20.39	0.20	0.00	10.50	0.01	31.10	54.77	-23.67	Average
3	0.541	23.46	0.20	0.00	10.50	0.03	34.19	56.00	-21.81	QP
4	0.546	15.73	0.20	0.00	10.50	0.03	26.46	46.00	-19.54	Average
5	1.381	16.14	0.20	0.00	10.50	0.13	26.97	56.00	-29.03	QP
6	1.552	9.84	0.20	0.00	10.50	0.15	20.69	46.00	-25.31	Average
7	2.765	16.10	0.20	0.00	10.50	0.10	26.90	56.00	-29.10	QP
8	5.805	9.93	0.20	0.00	10.50	0.09	20.72	50.00	-29.28	Average
9	8.964	12.01	0.20	0.00	10.50	0.11	22.82	50.00	-27.18	Average
10	9.502	21.21	0.20	0.00	10.50	0.12	32.03	60.00	-27.97	QP
11	13.695	10.72	0.28	0.00	10.50	0.12	21.62	50.00	-28.38	Average
12	15.066	18.10	0.30	0.00	10.50	0.14	29.04	60.00	-30.96	QP

Remark:

1. Level = Read level + LISN Factor + Cable Loss.

Product name:	Industrial AI Edge Computing Gateway	Product model:	DSGW-380
Test by:	Asher Zhang	Test mode:	5G Wi-Fi mode
Test frequency:	150 kHz ~ 30 MHz	Phase:	Neutral
Test voltage:	AC 120 V/60 Hz		

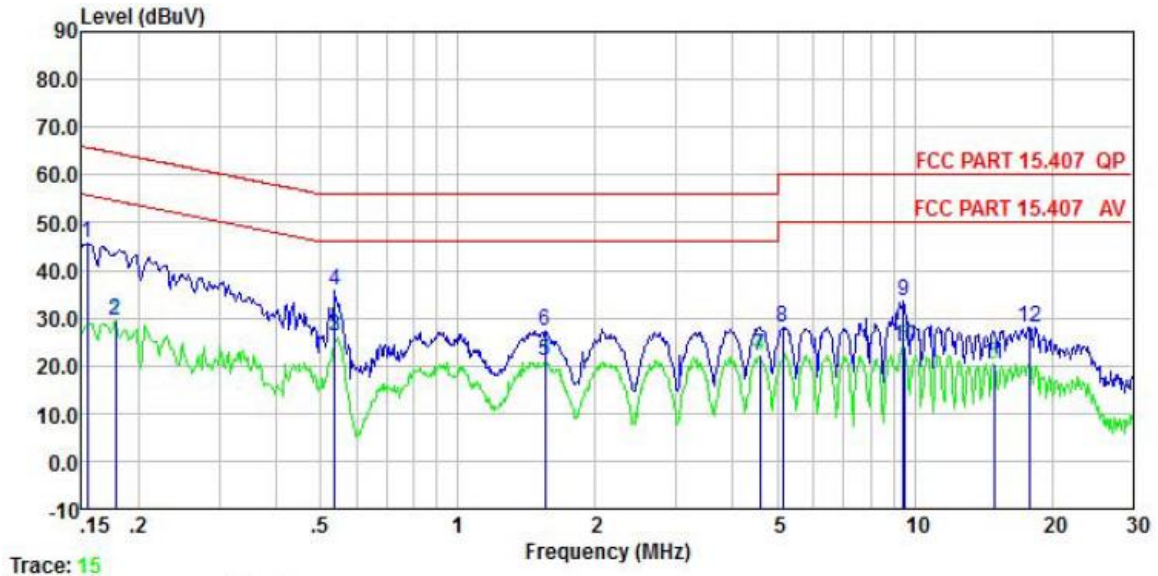

Trace: 15

	Freq	Read Level	LISN Factor	Aux Factor	Aux2 Factor	Cable Loss	Level	Limit Line	Over Limit	Remark
	MHz	dBuV	dB	dB	dB	dB	dBuV	dBuV	dB	
1	0.154	34.87	0.20	0.00	10.50	0.01	45.58	65.78	-20.20	QP
2	0.178	18.66	0.20	0.00	10.50	0.01	29.37	54.59	-25.22	Average
3	0.538	15.36	0.20	0.00	10.50	0.03	26.09	46.00	-19.91	Average
4	0.538	24.84	0.20	0.00	10.50	0.03	35.57	56.00	-20.43	QP
5	1.552	10.02	0.26	0.00	10.50	0.15	20.93	46.00	-25.07	Average
6	1.552	16.40	0.26	0.00	10.50	0.15	27.31	56.00	-28.69	QP
7	4.574	11.29	0.30	0.00	10.50	0.09	22.18	46.00	-23.82	Average
8	5.139	17.28	0.30	0.00	10.50	0.09	28.17	60.00	-31.83	QP
9	9.451	22.68	0.38	0.00	10.50	0.12	33.68	60.00	-26.32	QP
10	9.502	12.83	0.38	0.00	10.50	0.12	23.83	50.00	-26.17	Average
11	14.907	9.40	0.40	0.00	10.50	0.14	20.44	50.00	-29.56	Average
12	17.849	17.04	0.40	0.00	10.50	0.15	28.09	60.00	-31.91	QP

Remark:

1. Level = Read level + LISN Factor + Cable Loss.

5.4 Unwanted Emissions

Below 1GHz:

Product Name:	Industrial AI Edge Computing Gateway	Product Model:	DSGW-380
Test By:	Asher Zhang	Test mode:	5G Wi-Fi mode
Test Frequency:	30 MHz ~ 1 GHz	Polarization:	Vertical
Test Voltage:	AC 120/60Hz		

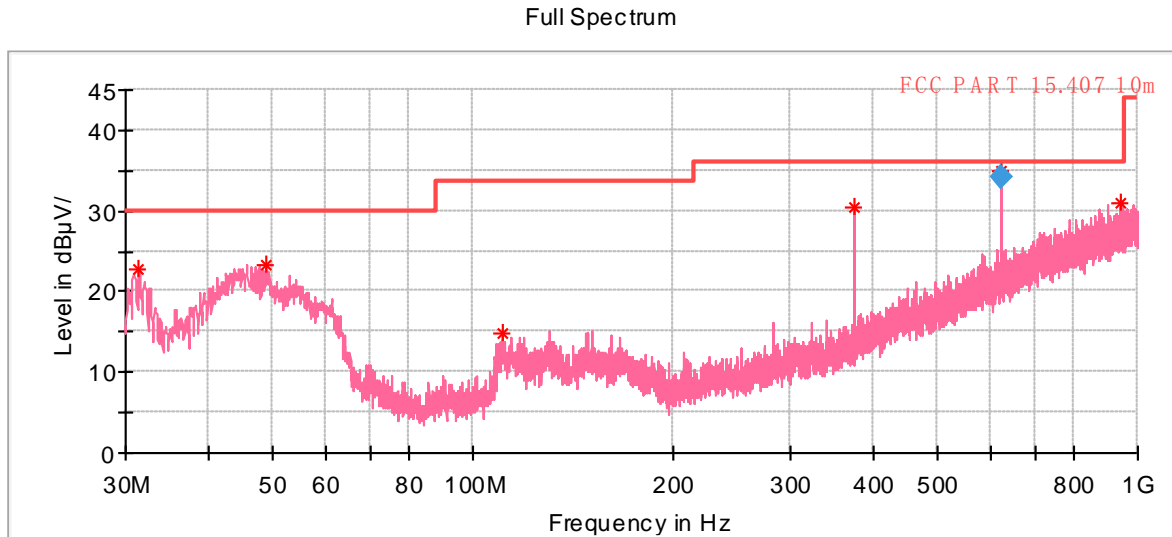

— Preview Result 1V-PK+ * Critical_Freqs PK+
— FCC PART 15.407 10m ◆ Final_Result QPK

Critical_Freqs

Frequency (MHz)	MaxPeak (dB µ V/m)	Limit (dB µ V/m)	Margin (dB)	Height (cm)	Pol	Azimuth (deg)	Corr. (dB/m)
31.455000	22.84	30.00	7.16	100.0	V	33.0	-17.3
48.866500	23.42	30.00	6.58	100.0	V	244.0	-16.5
111.043500	14.90	33.50	18.60	100.0	V	293.0	-18.3
374.980500	30.34	36.00	5.66	100.0	V	256.0	-13.0
624.998000	34.88	36.00	1.12	100.0	V	151.0	-6.0
945.098000	30.94	36.00	5.06	100.0	V	5.0	-0.3

Final_Result

Frequency (MHz)	QuasiPeak (dB µ V/m)	Limit (dB µ V/m)	Margin (dB)	Height (cm)	Pol	Azimuth (deg)	Corr. (dB/m)
624.998000	34.15	36.00	1.85	100.0	V	151.0	-6.0

Remark:

1. Level = Reading + Factor(Antenna Factor + Cable Loss – Preamplifier Factor).

Product Name:	Industrial AI Edge Computing Gateway	Product Model:	DSGW-380
Test By:	Asher Zhang	Test mode:	5G Wi-Fi mode
Test Frequency:	30 MHz ~ 1 GHz	Polarization:	Horizontal
Test Voltage:	AC 120/60Hz		

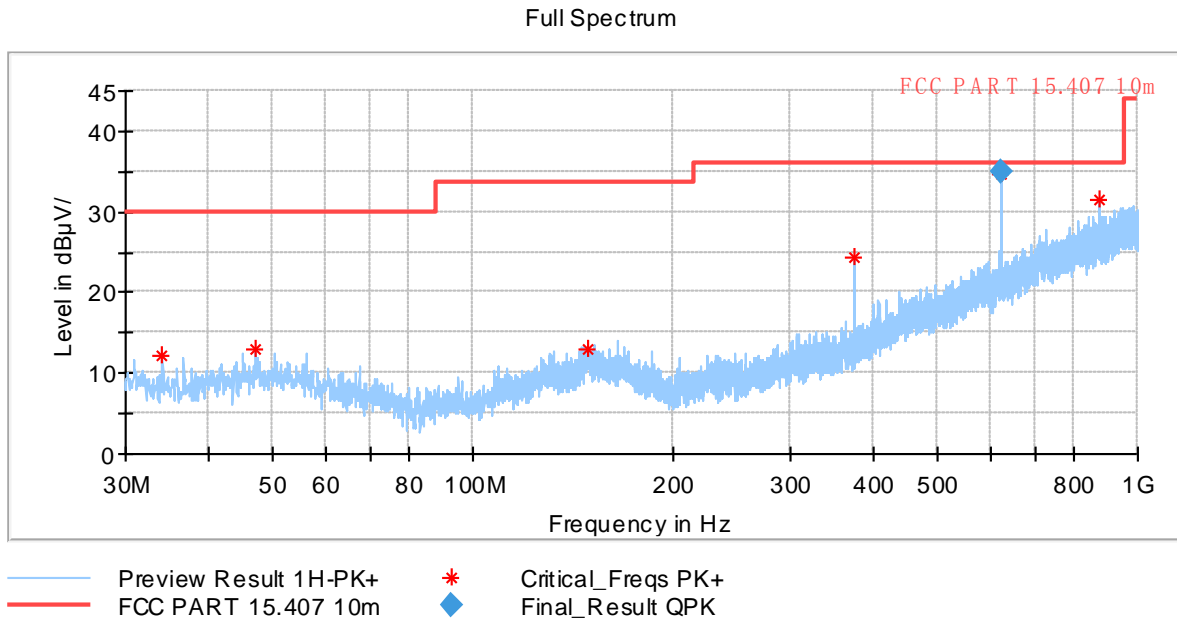

Critical_Freqs

Frequency (MHz)	MaxPeak (dB µ V/m)	Limit (dB µ V/m)	Margin (dB)	Height (cm)	Pol	Azimuth (deg)	Corr. (dB/m)
34.122500	12.15	30.00	17.85	100.0	H	138.0	-17.1
47.072000	12.99	30.00	17.01	100.0	H	234.0	-16.5
149.407000	12.84	33.50	20.66	100.0	H	251.0	-15.3
374.980500	24.25	36.00	11.75	100.0	H	7.0	-13.0
624.998000	34.64	36.00	1.36	100.0	H	306.0	-6.0
875.015500	31.62	36.00	4.38	100.0	H	41.0	-1.7

Final_Result

Frequency (MHz)	QuasiPeak (dB µ V/m)	Limit (dB µ V/m)	Margin (dB)	Height (cm)	Pol	Azimuth (deg)	Corr. (dB/m)
624.998000	34.89	36.00	1.11	100.0	H	306.0	-6.0

Remark:

1. Level = Reading + Factor(Antenna Factor + Cable Loss – Preamplifier Factor).

Above 1GHz:

ANT1:

Band 1: 5150 MHz - 5250 MHz, 802.11a						
Test channel: Lowest channel						
Detector: Peak Value						
Frequency (MHz)	Read Level (dBμV)	Factor (dB)	Level (dBμV/m)	Limit (dBμV/m)	Margin (dB)	Polarization
5150.00	61.95	-6.26	55.69	74.00	18.31	Vertical
10360.00	50.80	1.27	52.07	68.20	16.13	Vertical
5150.00	60.03	-6.26	53.77	74.00	20.23	Horizontal
10360.00	47.16	1.27	48.43	68.20	19.77	Horizontal
Detector: Average Value						
Frequency (MHz)	Read Level (dBμV)	Factor (dB)	Level (dBμV/m)	Limit (dBμV/m)	Margin (dB)	Polarization
5150.00	50.43	-6.26	44.17	54.00	9.83	Vertical
5150.00	60.03	-6.26	53.77	54.00	0.23	Horizontal
Test channel: Middle channel						
Detector: Peak Value						
Frequency (MHz)	Read Level (dBμV)	Factor (dB)	Level (dBμV/m)	Limit (dBμV/m)	Margin (dB)	Polarization
10400.00	50.47	2.39	52.86	68.20	15.34	Vertical
10400.00	46.03	2.39	48.42	68.20	19.78	Horizontal
Test channel: Highest channel						
Detector: Peak Value						
Frequency (MHz)	Read Level (dBμV)	Factor (dB)	Level (dBμV/m)	Limit (dBμV/m)	Margin (dB)	Polarization
5350.00	60.67	-6.32	54.35	74.00	19.65	Vertical
10480.00	50.19	2.80	52.99	68.20	15.21	Vertical
5350.00	59.68	-6.32	53.36	74.00	20.64	Horizontal
10480.00	46.89	2.80	49.69	68.20	18.51	Horizontal
Detector: Average Value						
Frequency (MHz)	Read Level (dBμV)	Factor (dB)	Level (dBμV/m)	Limit (dBμV/m)	Margin (dB)	Polarization
5350.00	48.60	-6.32	42.28	54.00	11.72	Vertical
5350.00	48.69	-6.32	42.37	54.00	11.63	Horizontal
Remark:						
1. <i>Level = Reading + Factor.</i>						
2. <i>Test Frequency up to 40GHz, and the emission levels of other frequencies are lower than the limit 20dB, not show in test report.</i>						

ANT2:

Band 1: 5150 MHz - 5250 MHz, 802.11a						
Test channel: Lowest channel						
Detector: Peak Value						
Frequency (MHz)	Read Level (dBμV)	Factor (dB)	Level (dBμV/m)	Limit (dBμV/m)	Margin (dB)	Polarization
5150.00	60.43	-6.26	54.17	74.00	19.83	Vertical
10360.00	49.48	1.27	50.75	68.20	17.45	Vertical
5150.00	59.12	-6.26	52.86	74.00	21.14	Horizontal
10360.00	47.32	1.27	48.59	68.20	19.61	Horizontal
Detector: Average Value						
Frequency (MHz)	Read Level (dBμV)	Factor (dB)	Level (dBμV/m)	Limit (dBμV/m)	Margin (dB)	Polarization
5150.00	49.68	-6.26	43.42	54.00	10.58	Vertical
5150.00	48.46	-6.26	42.20	54.00	11.80	Horizontal
Test channel: Middle channel						
Detector: Peak Value						
Frequency (MHz)	Read Level (dBμV)	Factor (dB)	Level (dBμV/m)	Limit (dBμV/m)	Margin (dB)	Polarization
10400.00	49.79	2.39	52.18	68.20	16.02	Vertical
10400.00	46.38	2.39	48.77	68.20	19.43	Horizontal
Test channel: Highest channel						
Detector: Peak Value						
Frequency (MHz)	Read Level (dBμV)	Factor (dB)	Level (dBμV/m)	Limit (dBμV/m)	Margin (dB)	Polarization
5350.00	60.02	-6.32	53.70	74.00	20.30	Vertical
10480.00	50.14	2.80	52.94	68.20	15.26	Vertical
5350.00	60.01	-6.32	53.69	74.00	20.31	Horizontal
10480.00	47.15	2.80	49.95	68.20	18.25	Horizontal
Detector: Average Value						
Frequency (MHz)	Read Level (dBμV)	Factor (dB)	Level (dBμV/m)	Limit (dBμV/m)	Margin (dB)	Polarization
5350.00	48.79	-6.32	42.47	54.00	11.53	Vertical
5350.00	48.66	-6.32	42.34	54.00	11.66	Horizontal
Remark:						
3. <i>Level = Reading + Factor.</i>						
4. <i>Test Frequency up to 40GHz, and the emission levels of other frequencies are lower than the limit 20dB, not show in test report.</i>						

Band 1: 5150 MHz - 5250 MHz, 802.11n-HT20						
Test channel: Lowest channel						
Detector: Peak Value						
Frequency (MHz)	Read Level (dBμV)	Factor (dB)	Level (dBμV/m)	Limit (dBμV/m)	Margin (dB)	Polarization
5150.00	65.98	-6.26	59.72	74.00	14.28	Vertical
10360.00	52.26	1.27	53.53	68.20	14.67	Vertical
5150.00	59.36	-6.26	53.10	74.00	20.90	Horizontal
10360.00	52.49	1.27	53.76	68.20	14.44	Horizontal
Detector: Average Value						
Frequency (MHz)	Read Level (dBμV)	Factor (dB)	Level (dBμV/m)	Limit (dBμV/m)	Margin (dB)	Polarization
5150.00	51.18	-6.26	44.92	54.00	9.08	Vertical
5150.00	48.47	-6.26	42.21	54.00	11.79	Horizontal
Test channel: Middle channel						
Detector: Peak Value						
Frequency (MHz)	Read Level (dBμV)	Factor (dB)	Level (dBμV/m)	Limit (dBμV/m)	Margin (dB)	Polarization
10400.00	50.06	2.39	52.45	68.20	15.75	Vertical
10400.00	46.51	2.39	48.90	68.20	19.30	Horizontal
Test channel: Highest channel						
Detector: Peak Value						
Frequency (MHz)	Read Level (dBμV)	Factor (dB)	Level (dBμV/m)	Limit (dBμV/m)	Margin (dB)	Polarization
5350.00	59.75	-6.32	53.43	74.00	20.57	Vertical
10480.00	49.79	2.80	52.59	68.20	15.61	Vertical
5350.00	60.07	-6.32	53.75	74.00	20.25	Horizontal
10480.00	45.96	2.80	48.76	68.20	19.44	Horizontal
Detector: Average Value						
Frequency (MHz)	Read Level (dBμV)	Factor (dB)	Level (dBμV/m)	Limit (dBμV/m)	Margin (dB)	Polarization
5350.00	48.63	-6.32	42.31	54.00	11.69	Vertical
5350.00	48.60	-6.32	42.28	54.00	11.72	Horizontal
Remark:						
1. Level = Reading + Factor.						
2. Test Frequency up to 40GHz, and the emission levels of other frequencies are lower than the limit 20dB, not show in test report.						

Band 1: 5150 MHz - 5250 MHz, 802.11n-HT40						
Test channel: Lowest channel						
Detector: Peak Value						
Frequency (MHz)	Read Level (dBμV)	Factor (dB)	Level (dBμV/m)	Limit (dBμV/m)	Margin (dB)	Polarization
5150.00	66.45	-6.26	60.19	74.00	13.81	Vertical
10380.00	50.13	1.84	51.97	68.20	16.23	Vertical
5150.00	59.57	-6.26	53.31	74.00	20.69	Horizontal
10380.00	47.11	1.84	48.95	68.20	19.25	Horizontal
Detector: Average Value						
Frequency (MHz)	Read Level (dBμV)	Factor (dB)	Level (dBμV/m)	Limit (dBμV/m)	Margin (dB)	Polarization
5150.00	54.34	-6.26	48.08	54.00	5.92	Vertical
5150.00	48.50	-6.26	42.24	54.00	11.76	Horizontal
Test channel: Highest channel						
Detector: Peak Value						
Frequency (MHz)	Read Level (dBμV)	Factor (dB)	Level (dBμV/m)	Limit (dBμV/m)	Margin (dB)	Polarization
5350.00	59.63	-6.32	53.31	74.00	20.69	Vertical
10460.00	49.69	1.65	51.34	68.20	16.86	Vertical
5350.00	60.39	-6.32	54.07	74.00	19.93	Horizontal
10460.00	46.37	1.65	48.02	68.20	20.18	Horizontal
Detector: Average Value						
Frequency (MHz)	Read Level (dBμV)	Factor (dB)	Level (dBμV/m)	Limit (dBμV/m)	Margin (dB)	Polarization
5350.00	48.48	-6.32	42.16	54.00	11.84	Vertical
5350.00	48.58	-6.32	42.26	54.00	11.74	Horizontal
Remark:						
1. $Level = Reading + Factor$.						
2. Test Frequency up to 40GHz, and the emission levels of other frequencies are lower than the limit 20dB, not show in test report.						

Band 1: 5150 MHz - 5250 MHz, 802.11ac-VHT20						
Test channel: Lowest channel						
Detector: Peak Value						
Frequency (MHz)	Read Level (dB μ V)	Factor (dB)	Level (dB μ V/m)	Limit (dB μ V/m)	Margin (dB)	Polarization
5150.00	65.64	-6.26	59.38	74.00	14.62	Vertical
10360.00	52.47	1.27	53.74	68.20	14.46	Vertical
5150.00	59.23	-6.26	52.97	74.00	21.03	Horizontal
10360.00	52.07	1.27	53.34	68.20	14.86	Horizontal
Detector: Average Value						
Frequency (MHz)	Read Level (dB μ V)	Factor (dB)	Level (dB μ V/m)	Limit (dB μ V/m)	Margin (dB)	Polarization
5150.00	50.82	-6.26	44.56	54.00	9.44	Vertical
5150.00	48.55	-6.26	42.29	54.00	11.71	Horizontal
Test channel: Middle channel						
Detector: Peak Value						
Frequency (MHz)	Read Level (dB μ V)	Factor (dB)	Level (dB μ V/m)	Limit (dB μ V/m)	Margin (dB)	Polarization
10400.00	49.62	2.39	52.01	68.20	16.19	Vertical
10400.00	46.77	2.39	49.16	68.20	19.04	Horizontal
Test channel: Highest channel						
Detector: Peak Value						
Frequency (MHz)	Read Level (dB μ V)	Factor (dB)	Level (dB μ V/m)	Limit (dB μ V/m)	Margin (dB)	Polarization
5350.00	59.51	-6.32	53.19	74.00	20.81	Vertical
10480.00	49.68	2.80	52.48	68.20	15.72	Vertical
5350.00	59.82	-6.32	53.50	74.00	20.50	Horizontal
10480.00	45.63	2.80	48.43	68.20	19.77	Horizontal
Detector: Average Value						
Frequency (MHz)	Read Level (dB μ V)	Factor (dB)	Level (dB μ V/m)	Limit (dB μ V/m)	Margin (dB)	Polarization
5350.00	48.61	-6.32	42.29	54.00	11.71	Vertical
5350.00	48.78	-6.32	42.46	54.00	11.54	Horizontal
Remark:						
1. Level = Reading + Factor.						
2. Test Frequency up to 40GHz, and the emission levels of other frequencies are lower than the limit 20dB, not show in test report.						

Band 1: 5150 MHz - 5250 MHz, 802.11ac-VHT40						
Test channel: Lowest channel						
Detector: Peak Value						
Frequency (MHz)	Read Level (dB μ V)	Factor (dB)	Level (dB μ V/m)	Limit (dB μ V/m)	Margin (dB)	Polarization
5150.00	66.10	-6.26	59.84	74.00	14.16	Vertical
10380.00	49.69	1.84	51.53	68.20	16.67	Vertical
5150.00	59.70	-6.26	53.44	74.00	20.56	Horizontal
10380.00	46.71	1.84	48.55	68.20	19.65	Horizontal
Detector: Average Value						
Frequency (MHz)	Read Level (dB μ V)	Factor (dB)	Level (dB μ V/m)	Limit (dB μ V/m)	Margin (dB)	Polarization
5150.00	54.50	-6.26	48.24	54.00	5.76	Vertical
5150.00	48.12	-6.26	41.86	54.00	12.14	Horizontal
Test channel: Highest channel						
Detector: Peak Value						
Frequency (MHz)	Read Level (dB μ V)	Factor (dB)	Level (dB μ V/m)	Limit (dB μ V/m)	Margin (dB)	Polarization
5350.00	59.23	-6.32	52.91	74.00	21.09	Vertical
10460.00	49.57	1.65	51.22	68.20	16.98	Vertical
5350.00	60.05	-6.32	53.73	74.00	20.27	Horizontal
10460.00	46.76	1.65	48.41	68.20	19.79	Horizontal
Detector: Average Value						
Frequency (MHz)	Read Level (dB μ V)	Factor (dB)	Level (dB μ V/m)	Limit (dB μ V/m)	Margin (dB)	Polarization
5350.00	48.54	-6.32	42.22	54.00	11.78	Vertical
5350.00	48.13	-6.32	41.81	54.00	12.19	Horizontal
Remark:						
1. Level = Reading + Factor.						
2. Test Frequency up to 40GHz, and the emission levels of other frequencies are lower than the limit 20dB, not show in test report.						

Band 1: 5150 MHz - 5250 MHz, 802.11ac-VHT80						
Test channel: Middle channel						
Detector: Peak Value						
Frequency (MHz)	Read Level (dBμV)	Factor (dB)	Level (dBμV/m)	Limit (dBμV/m)	Margin (dB)	Polarization
5150.00	68.06	-6.26	61.80	74.00	12.2	Vertical
5350.00	59.93	-6.32	53.61	74.00	20.39	Vertical
10420.00	49.88	1.85	51.73	68.20	16.47	Vertical
5150.00	60.25	-6.26	53.99	74.00	20.01	Horizontal
5350.00	59.91	-6.32	53.59	74.00	20.41	Horizontal
10420.00	47.12	1.85	48.97	68.20	19.23	Horizontal
Detector: Average Value						
Frequency (MHz)	Read Level (dBμV)	Factor (dB)	Level (dBμV/m)	Limit (dBμV/m)	Margin (dB)	Polarization
5150.00	52.60	-6.26	46.34	54.00	7.66	Vertical
5350.00	48.55	-6.32	42.23	54.00	11.77	Vertical
5150.00	48.65	-6.26	42.39	54.00	11.61	Horizontal
5350.00	48.60	-6.32	42.28	54.00	11.72	Horizontal
Remark:						
1. <i>Level = Reading + Factor.</i>						
2. <i>Test Frequency up to 40GHz, and the emission levels of other frequencies are lower than the limit 20dB, not show in test report.</i>						

Band 1: 5150 MHz - 5250 MHz, 802.11ax-HE20						
Test channel: Lowest channel						
Detector: Peak Value						
Frequency (MHz)	Read Level (dBμV)	Factor (dB)	Level (dBμV/m)	Limit (dBμV/m)	Margin (dB)	Polarization
5150.00	65.59	-6.26	59.33	74.00	14.67	Vertical
10360.00	52.60	1.27	53.87	68.20	14.33	Vertical
5150.00	59.60	-6.26	53.34	74.00	20.66	Horizontal
10360.00	52.23	1.27	53.50	68.20	14.70	Horizontal
Detector: Average Value						
Frequency (MHz)	Read Level (dBμV)	Factor (dB)	Level (dBμV/m)	Limit (dBμV/m)	Margin (dB)	Polarization
5150.00	50.95	-6.26	44.69	54.00	9.31	Vertical
5150.00	48.48	-6.26	42.22	54.00	11.78	Horizontal
Test channel: Middle channel						
Detector: Peak Value						
Frequency (MHz)	Read Level (dBμV)	Factor (dB)	Level (dBμV/m)	Limit (dBμV/m)	Margin (dB)	Polarization
10400.00	50.11	2.39	52.50	68.20	15.70	Vertical
10400.00	46.49	2.39	48.88	68.20	19.32	Horizontal
Test channel: Highest channel						
Detector: Peak Value						
Frequency (MHz)	Read Level (dBμV)	Factor (dB)	Level (dBμV/m)	Limit (dBμV/m)	Margin (dB)	Polarization
5350.00	59.78	-6.32	53.46	74.00	20.54	Vertical
10480.00	50.19	2.80	52.99	68.20	15.21	Vertical
5350.00	60.19	-6.32	53.87	74.00	20.13	Horizontal
10480.00	45.63	2.80	48.43	68.20	19.77	Horizontal
Detector: Average Value						
Frequency (MHz)	Read Level (dBμV)	Factor (dB)	Level (dBμV/m)	Limit (dBμV/m)	Margin (dB)	Polarization
5350.00	48.21	-6.32	41.89	54.00	12.11	Vertical
5350.00	48.54	-6.32	42.22	54.00	11.78	Horizontal
Remark:						
1. Level = Reading + Factor.						
2. Test Frequency up to 40GHz, and the emission levels of other frequencies are lower than the limit 20dB, not show in test report.						

Band 1: 5150 MHz - 5250 MHz, 802.11ax-HE40						
Test channel: Lowest channel						
Detector: Peak Value						
Frequency (MHz)	Read Level (dBμV)	Factor (dB)	Level (dBμV/m)	Limit (dBμV/m)	Margin (dB)	Polarization
5150.00	66.34	-6.26	60.08	74.00	13.92	Vertical
10380.00	50.27	1.84	52.11	68.20	16.09	Vertical
5150.00	59.47	-6.26	53.21	74.00	20.79	Horizontal
10380.00	46.78	1.84	48.62	68.20	19.58	Horizontal
Detector: Average Value						
Frequency (MHz)	Read Level (dBμV)	Factor (dB)	Level (dBμV/m)	Limit (dBμV/m)	Margin (dB)	Polarization
5150.00	54.70	-6.26	48.44	54.00	5.56	Vertical
5150.00	48.76	-6.26	42.50	54.00	11.50	Horizontal
Test channel: Highest channel						
Detector: Peak Value						
Frequency (MHz)	Read Level (dBμV)	Factor (dB)	Level (dBμV/m)	Limit (dBμV/m)	Margin (dB)	Polarization
5350.00	59.93	-6.32	53.61	74.00	20.39	Vertical
10460.00	49.96	1.65	51.61	68.20	16.59	Vertical
5350.00	60.21	-6.32	53.89	74.00	20.11	Horizontal
10460.00	46.44	1.65	48.09	68.20	20.11	Horizontal
Detector: Average Value						
Frequency (MHz)	Read Level (dBμV)	Factor (dB)	Level (dBμV/m)	Limit (dBμV/m)	Margin (dB)	Polarization
5350.00	48.22	-6.32	41.90	54.00	12.10	Vertical
5350.00	48.38	-6.32	42.06	54.00	11.94	Horizontal
Remark:						
1. Level = Reading + Factor.						
2. Test Frequency up to 40GHz, and the emission levels of other frequencies are lower than the limit 20dB, not show in test report.						

Band 1: 5150 MHz - 5250 MHz, 802.11ax-HE80						
Test channel: Middle channel						
Detector: Peak Value						
Frequency (MHz)	Read Level (dBμV)	Factor (dB)	Level (dBμV/m)	Limit (dBμV/m)	Margin (dB)	Polarization
5150.00	68.20	-6.26	61.94	74.00	12.06	Vertical
5350.00	59.69	-6.32	53.37	74.00	20.63	Vertical
10580.00	49.73	2.05	51.78	68.20	16.42	Vertical
5150.00	59.82	-6.26	53.56	74.00	20.44	Horizontal
5350.00	59.90	-6.32	53.58	74.00	20.42	Horizontal
10580.00	47.51	2.05	49.56	68.20	18.64	Horizontal
Detector: Average Value						
Frequency (MHz)	Read Level (dBμV)	Factor (dB)	Level (dBμV/m)	Limit (dBμV/m)	Margin (dB)	Polarization
5150.00	52.49	-6.26	46.23	54.00	7.77	Vertical
5350.00	48.33	-6.32	42.01	54.00	11.99	Vertical
5150.00	48.93	-6.26	42.67	54.00	11.33	Horizontal
5350.00	48.60	-6.32	42.28	54.00	11.72	Horizontal
Remark:						
1. <i>Level = Reading + Factor.</i>						
2. <i>Test Frequency up to 40GHz, and the emission levels of other frequencies are lower than the limit 20dB, not show in test report.</i>						

ANT1:

Band 4: 5725 MHz - 5825 MHz, 802.11a						
Test channel: Lowest channel						
Detector: Peak Value						
Frequency (MHz)	Read Level (dBμV)	Factor (dB)	Level (dBμV/m)	Limit (dBμV/m)	Margin (dB)	Polarization
5650.00	60.37	-6.53	53.84	68.20	14.36	Vertical
5700.00	60.80	-6.49	54.31	105.20	50.89	Vertical
5720.00	67.26	-6.26	61.00	110.80	49.80	Vertical
5725.00	73.68	-6.20	67.48	122.20	54.72	Vertical
11490.00	51.87	2.44	54.31	74.00	19.69	Vertical
5650.00	59.88	-6.53	53.35	68.20	14.85	Horizontal
5700.00	60.32	-6.49	53.83	105.20	51.37	Horizontal
5720.00	61.05	-6.26	54.79	110.80	56.01	Horizontal
5725.00	59.90	-6.20	53.70	122.20	68.50	Horizontal
11490.00	46.37	2.44	48.81	74.00	25.19	Horizontal
Detector: Average Value						
Frequency (MHz)	Read Level (dBμV)	Factor (dB)	Level (dBμV/m)	Limit (dBμV/m)	Margin (dB)	Polarization
11490.00	41.97	2.44	44.41	54.00	9.59	Vertical
11490.00	36.03	2.44	38.47	54.00	15.53	Horizontal
Test channel: Middle channel						
Detector: Peak Value						
Frequency (MHz)	Read Level (dBμV)	Factor (dB)	Level (dBμV/m)	Limit (dBμV/m)	Margin (dB)	Polarization
11570.00	51.17	3.02	54.19	74.00	19.81	Vertical
11570.00	45.22	3.02	48.24	74.00	25.76	Horizontal
Detector: Average Value						
Frequency (MHz)	Read Level (dBμV)	Factor (dB)	Level (dBμV/m)	Limit (dBμV/m)	Margin (dB)	Polarization
11570.00	40.75	3.02	43.77	54.00	10.23	Vertical
11570.00	35.09	3.02	38.11	54.00	15.89	Horizontal
Remark:						
1. Level = Reading + Factor.						
2. Test Frequency up to 40GHz, and the emission levels of other frequencies are lower than the limit 20dB, not show in test report.						

Test channel: Highest channel						
Detector: Peak Value						
Frequency (MHz)	Read Level (dBμV)	Factor (dB)	Level (dBμV/m)	Limit (dBμV/m)	Margin (dB)	Polarization
5850.00	59.02	-5.49	53.53	122.20	68.67	Vertical
5855.00	59.24	-5.51	53.73	110.80	57.07	Vertical
5875.00	58.65	-5.60	53.05	105.20	52.15	Vertical
5925.00	58.90	-5.61	53.29	68.20	14.91	Vertical
11650.00	51.35	2.24	53.59	74.00	20.41	Vertical
5850.00	59.09	-5.49	53.60	122.20	68.60	Horizontal
5855.00	59.32	-5.51	53.81	110.80	56.99	Horizontal
5875.00	59.38	-5.60	53.78	105.20	51.42	Horizontal
5925.00	59.17	-5.61	53.56	68.20	14.64	Horizontal
11650.00	45.61	2.24	47.85	74.00	26.15	Horizontal
Detector: Average Value						
Frequency (MHz)	Read Level (dBμV)	Factor (dB)	Level (dBμV/m)	Limit (dBμV/m)	Margin (dB)	Polarization
11650.00	41.00	2.24	43.24	54.00	10.76	Vertical
11650.00	35.23	2.24	37.47	54.00	16.53	Horizontal
Remark:						
1. Level = Reading + Factor.						
2. Test Frequency up to 40GHz, and the emission levels of other frequencies are lower than the limit 20dB, not show in test report.						

ANT2:

Band 4: 5725 MHz - 5825 MHz, 802.11a						
Test channel: Lowest channel						
Detector: Peak Value						
Frequency (MHz)	Read Level (dBμV)	Factor (dB)	Level (dBμV/m)	Limit (dBμV/m)	Margin (dB)	Polarization
5650.00	60.38	-6.53	53.85	68.20	14.35	Vertical
5700.00	60.29	-6.49	53.80	105.20	51.40	Vertical
5720.00	70.58	-6.26	64.32	110.80	46.48	Vertical
5725.00	76.01	-6.20	69.81	122.20	52.39	Vertical
11490.00	51.56	2.44	54.00	74.00	20.00	Vertical
5650.00	60.57	-6.53	54.04	68.20	14.16	Horizontal
5700.00	59.47	-6.49	52.98	105.20	52.22	Horizontal
5720.00	59.94	-6.26	53.68	110.80	57.12	Horizontal
5725.00	60.04	-6.20	53.84	122.20	68.36	Horizontal
11490.00	47.63	2.44	50.07	74.00	23.93	Horizontal
Detector: Average Value						
Frequency (MHz)	Read Level (dBμV)	Factor (dB)	Level (dBμV/m)	Limit (dBμV/m)	Margin (dB)	Polarization
11490.00	41.88	2.44	44.32	54.00	9.68	Vertical
11490.00	36.55	2.44	38.99	54.00	15.01	Horizontal
Test channel: Middle channel						
Detector: Peak Value						
Frequency (MHz)	Read Level (dBμV)	Factor (dB)	Level (dBμV/m)	Limit (dBμV/m)	Margin (dB)	Polarization
11570.00	51.19	3.02	54.21	74.00	19.79	Vertical
11570.00	45.99	3.02	49.01	74.00	24.99	Horizontal
Detector: Average Value						
Frequency (MHz)	Read Level (dBμV)	Factor (dB)	Level (dBμV/m)	Limit (dBμV/m)	Margin (dB)	Polarization
11570.00	41.93	3.02	44.95	54.00	9.05	Vertical
11570.00	35.60	3.02	38.62	54.00	15.38	Horizontal
Remark:						
3. Level = Reading + Factor.						
4. Test Frequency up to 40GHz, and the emission levels of other frequencies are lower than the limit 20dB, not show in test report.						

Test channel: Highest channel						
Detector: Peak Value						
Frequency (MHz)	Read Level (dBμV)	Factor (dB)	Level (dBμV/m)	Limit (dBμV/m)	Margin (dB)	Polarization
5850.00	64.68	-5.49	59.19	122.20	63.01	Vertical
5855.00	60.29	-5.51	54.78	110.80	56.02	Vertical
5875.00	59.18	-5.60	53.58	105.20	51.62	Vertical
5925.00	59.39	-5.61	53.78	68.20	14.42	Vertical
11650.00	51.84	2.24	54.08	74.00	19.92	Vertical
5850.00	59.29	-5.49	53.80	122.20	68.40	Horizontal
5855.00	59.59	-5.51	54.08	110.80	56.72	Horizontal
5875.00	59.38	-5.60	53.78	105.20	51.42	Horizontal
5925.00	59.48	-5.61	53.87	68.20	14.33	Horizontal
11650.00	45.26	2.24	47.50	74.00	26.50	Horizontal
Detector: Average Value						
Frequency (MHz)	Read Level (dBμV)	Factor (dB)	Level (dBμV/m)	Limit (dBμV/m)	Margin (dB)	Polarization
11650.00	40.90	2.24	43.14	54.00	10.86	Vertical
11650.00	35.60	2.24	37.84	54.00	16.16	Horizontal
Remark:						
3. <i>Level = Reading + Factor.</i>						
4. <i>Test Frequency up to 40GHz, and the emission levels of other frequencies are lower than the limit 20dB, not show in test report.</i>						

Band 4: 5725 MHz - 5825 MHz, 802.11n-HT20						
Test channel: Lowest channel						
Detector: Peak Value						
Frequency (MHz)	Read Level (dBμV)	Factor (dB)	Level (dBμV/m)	Limit (dBμV/m)	Margin (dB)	Polarization
5650.00	60.07	-6.53	53.54	68.20	14.66	Vertical
5700.00	60.96	-6.49	54.47	105.20	50.73	Vertical
5720.00	67.35	-6.26	61.09	110.80	49.71	Vertical
5725.00	73.30	-6.20	67.10	122.20	55.10	Vertical
11490.00	51.64	2.44	54.08	74.00	19.92	Vertical
5650.00	60.11	-6.53	53.58	68.20	14.62	Horizontal
5700.00	60.42	-6.49	53.93	105.20	51.27	Horizontal
5720.00	61.43	-6.26	55.17	110.80	55.63	Horizontal
5725.00	59.93	-6.20	53.73	122.20	68.47	Horizontal
11490.00	46.29	2.44	48.73	74.00	25.27	Horizontal
Detector: Average Value						
Frequency (MHz)	Read Level (dBμV)	Factor (dB)	Level (dBμV/m)	Limit (dBμV/m)	Margin (dB)	Polarization
11490.00	41.98	2.44	44.42	54.00	9.58	Vertical
11490.00	36.07	2.44	38.51	54.00	15.49	Horizontal
Test channel: Middle channel						
Detector: Peak Value						
Frequency (MHz)	Read Level (dBμV)	Factor (dB)	Level (dBμV/m)	Limit (dBμV/m)	Margin (dB)	Polarization
11570.00	50.73	3.02	53.75	74.00	20.25	Vertical
11570.00	45.10	3.02	48.12	74.00	25.88	Horizontal
Detector: Average Value						
Frequency (MHz)	Read Level (dBμV)	Factor (dB)	Level (dBμV/m)	Limit (dBμV/m)	Margin (dB)	Polarization
11570.00	40.75	3.02	43.77	54.00	10.23	Vertical
11570.00	35.34	3.02	38.36	54.00	15.64	Horizontal
Remark:						
1. Level = Reading + Factor.						
2. Test Frequency up to 40GHz, and the emission levels of other frequencies are lower than the limit 20dB, not show in test report.						

Test channel: Highest channel						
Detector: Peak Value						
Frequency (MHz)	Read Level (dB μ V)	Factor (dB)	Level (dB μ V/m)	Limit (dB μ V/m)	Margin (dB)	Polarization
5850.00	58.66	-5.49	53.17	122.20	69.03	Vertical
5855.00	58.98	-5.51	53.47	110.80	57.33	Vertical
5875.00	58.52	-5.60	52.92	105.20	52.28	Vertical
5925.00	59.00	-5.61	53.39	68.20	14.81	Vertical
11650.00	51.56	2.24	53.80	74.00	20.20	Vertical
5850.00	58.84	-5.49	53.35	122.20	68.85	Horizontal
5855.00	59.00	-5.51	53.49	110.80	57.31	Horizontal
5875.00	59.67	-5.60	54.07	105.20	51.13	Horizontal
5925.00	58.74	-5.61	53.13	68.20	15.07	Horizontal
11650.00	45.34	2.24	47.58	74.00	26.42	Horizontal
Detector: Average Value						
Frequency (MHz)	Read Level (dB μ V)	Factor (dB)	Level (dB μ V/m)	Limit (dB μ V/m)	Margin (dB)	Polarization
11650.00	41.31	2.24	43.55	54.00	10.45	Vertical
11650.00	34.94	2.24	37.18	54.00	16.82	Horizontal
Remark:						
1. Level = Reading + Factor.						
2. Test Frequency up to 40GHz, and the emission levels of other frequencies are lower than the limit 20dB, not show in test report.						

Band 4: 5725 MHz - 5825 MHz, 802.11n-HT40						
Test channel: Lowest channel						
Detector: Peak Value						
Frequency (MHz)	Read Level (dB μ V)	Factor (dB)	Level (dB μ V/m)	Limit (dB μ V/m)	Margin (dB)	Polarization
5650.00	61.06	-6.53	54.53	68.20	13.67	Vertical
5700.00	60.69	-6.49	54.20	105.20	51.00	Vertical
5720.00	66.58	-6.26	60.32	110.80	50.48	Vertical
5725.00	66.14	-6.20	59.94	122.20	62.26	Vertical
11510.00	51.06	2.63	53.69	74.00	20.31	Vertical
5650.00	60.14	-6.53	53.61	68.20	14.59	Horizontal
5700.00	59.89	-6.49	53.40	105.20	51.80	Horizontal
5720.00	60.12	-6.26	53.86	110.80	56.94	Horizontal
5725.00	60.71	-6.20	54.51	122.20	67.69	Horizontal
11510.00	46.22	2.63	48.85	74.00	25.15	Horizontal
Detector: Average Value						
Frequency (MHz)	Read Level (dB μ V)	Factor (dB)	Level (dB μ V/m)	Limit (dB μ V/m)	Margin (dB)	Polarization
11510.00	41.44	2.63	44.07	54.00	9.93	Vertical
11510.00	35.94	2.63	38.57	54.00	15.43	Horizontal
Test channel: Highest channel						
Detector: Peak Value						
Frequency (MHz)	Read Level (dB μ V)	Factor (dB)	Level (dB μ V/m)	Limit (dB μ V/m)	Margin (dB)	Polarization
5850.00	58.79	-5.49	53.30	122.20	68.90	Vertical
5855.00	58.90	-5.51	53.39	110.80	57.41	Vertical
5875.00	58.83	-5.60	53.23	105.20	51.97	Vertical
5925.00	60.16	-5.61	54.55	68.20	13.65	Vertical
11590.00	50.80	3.10	53.90	74.00	20.10	Vertical
5850.00	59.12	-5.49	53.63	122.20	68.57	Horizontal
5855.00	59.78	-5.51	54.27	110.80	56.53	Horizontal
5875.00	59.47	-5.60	53.87	105.20	51.33	Horizontal
5925.00	59.86	-5.61	54.25	68.20	13.95	Horizontal
11590.00	45.37	3.10	48.47	74.00	25.53	Horizontal
Detector: Average Value						
Frequency (MHz)	Read Level (dB μ V)	Factor (dB)	Level (dB μ V/m)	Limit (dB μ V/m)	Margin (dB)	Polarization
11590.00	41.54	3.10	44.64	54.00	9.36	Vertical
11590.00	35.48	3.10	38.58	54.00	15.42	Horizontal
Remark:						
1. Level = Reading + Factor.						
2. Test Frequency up to 40GHz, and the emission levels of other frequencies are lower than the limit 20dB, not show in test report.						

Band 4: 5725 MHz - 5825 MHz, 8802.11ac-VHT20						
Test channel: Lowest channel						
Detector: Peak Value						
Frequency (MHz)	Read Level (dBμV)	Factor (dB)	Level (dBμV/m)	Limit (dBμV/m)	Margin (dB)	Polarization
5650.00	60.73	-6.53	54.20	68.20	14.00	Vertical
5700.00	60.07	-6.49	53.58	105.20	51.62	Vertical
5720.00	68.15	-6.26	61.89	110.80	48.91	Vertical
5725.00	81.09	-6.20	74.89	122.20	47.31	Vertical
11490.00	55.80	2.44	58.24	74.00	15.76	Vertical
5650.00	60.43	-6.53	53.90	68.20	14.30	Horizontal
5700.00	60.36	-6.49	53.87	105.20	51.33	Horizontal
5720.00	59.94	-6.26	53.68	110.80	57.12	Horizontal
5725.00	59.88	-6.20	53.68	122.20	68.52	Horizontal
11490.00	49.79	2.44	52.23	74.00	21.77	Horizontal
Detector: Average Value						
Frequency (MHz)	Read Level (dBμV)	Factor (dB)	Level (dBμV/m)	Limit (dBμV/m)	Margin (dB)	Polarization
11490.00	46.26	2.44	48.70	54.00	5.30	Vertical
11490.00	40.32	2.44	42.76	54.00	11.24	Horizontal
Test channel: Middle channel						
Detector: Peak Value						
Frequency (MHz)	Read Level (dBμV)	Factor (dB)	Level (dBμV/m)	Limit (dBμV/m)	Margin (dB)	Polarization
11570.00	51.20	3.02	54.22	74.00	19.78	Vertical
11570.00	46.34	3.02	49.36	74.00	24.64	Horizontal
Detector: Average Value						
Frequency (MHz)	Read Level (dBμV)	Factor (dB)	Level (dBμV/m)	Limit (dBμV/m)	Margin (dB)	Polarization
11570.00	41.55	3.02	44.57	54.00	9.43	Vertical
11570.00	34.90	3.02	37.92	54.00	16.08	Horizontal
Remark:						
1. Level = Reading + Factor.						
2. Test Frequency up to 40GHz, and the emission levels of other frequencies are lower than the limit 20dB, not show in test report.						

Test channel: Highest channel						
Detector: Peak Value						
Frequency (MHz)	Read Level (dBμV)	Factor (dB)	Level (dBμV/m)	Limit (dBμV/m)	Margin (dB)	Polarization
5850.00	58.55	-5.49	53.06	122.20	69.14	Vertical
5855.00	58.99	-5.51	53.48	110.80	57.32	Vertical
5875.00	58.72	-5.60	53.12	105.20	52.08	Vertical
5925.00	59.28	-5.61	53.67	68.20	14.53	Vertical
11650.00	50.66	2.24	52.90	74.00	21.10	Vertical
5850.00	59.01	-5.49	53.52	122.20	68.68	Horizontal
5855.00	59.08	-5.51	53.57	110.80	57.23	Horizontal
5875.00	59.77	-5.60	54.17	105.20	51.03	Horizontal
5925.00	59.03	-5.61	53.42	68.20	14.78	Horizontal
11650.00	45.73	2.24	47.97	74.00	26.03	Horizontal
Detector: Average Value						
Frequency (MHz)	Read Level (dBμV)	Factor (dB)	Level (dBμV/m)	Limit (dBμV/m)	Margin (dB)	Polarization
11650.00	41.01	2.24	43.25	54.00	10.75	Vertical
11650.00	34.83	2.24	37.07	54.00	16.93	Horizontal
Remark:						
1. Level = Reading + Factor.						
2. Test Frequency up to 40GHz, and the emission levels of other frequencies are lower than the limit 20dB, not show in test report.						

Band 4: 5725 MHz - 5825 MHz, 802.11ac-VHT40						
Test channel: Lowest channel						
Detector: Peak Value						
Frequency (MHz)	Read Level (dBμV)	Factor (dB)	Level (dBμV/m)	Limit (dBμV/m)	Margin (dB)	Polarization
5650.00	60.81	-6.53	54.28	68.20	13.92	Vertical
5700.00	60.24	-6.49	53.75	105.20	51.45	Vertical
5720.00	66.97	-6.26	60.71	110.80	50.09	Vertical
5725.00	66.52	-6.20	60.32	122.20	61.88	Vertical
11510.00	50.67	2.63	53.30	74.00	20.70	Vertical
5650.00	60.52	-6.53	53.99	68.20	14.21	Horizontal
5700.00	60.17	-6.49	53.68	105.20	51.52	Horizontal
5720.00	59.77	-6.26	53.51	110.80	57.29	Horizontal
5725.00	60.93	-6.20	54.73	122.20	67.47	Horizontal
11510.00	46.09	2.63	48.72	74.00	25.28	Horizontal
Detector: Average Value						
Frequency (MHz)	Read Level (dBμV)	Factor (dB)	Level (dBμV/m)	Limit (dBμV/m)	Margin (dB)	Polarization
11510.00	41.56	2.63	44.19	54.00	9.81	Vertical
11510.00	36.29	2.63	38.92	54.00	15.08	Horizontal
Test channel: Highest channel						
Detector: Peak Value						
Frequency (MHz)	Read Level (dBμV)	Factor (dB)	Level (dBμV/m)	Limit (dBμV/m)	Margin (dB)	Polarization
5850.00	58.80	-5.49	53.31	122.20	68.89	Vertical
5855.00	58.94	-5.51	53.43	110.80	57.37	Vertical
5875.00	58.96	-5.60	53.36	105.20	51.84	Vertical
5925.00	60.49	-5.61	54.88	68.20	13.32	Vertical
11590.00	50.93	3.10	54.03	74.00	19.97	Vertical
5850.00	58.63	-5.49	53.14	122.20	69.06	Horizontal
5855.00	60.13	-5.51	54.62	110.80	56.18	Horizontal
5875.00	59.48	-5.60	53.88	105.20	51.32	Horizontal
5925.00	60.01	-5.61	54.40	68.20	13.80	Horizontal
11590.00	45.45	3.10	48.55	74.00	25.45	Horizontal
Detector: Average Value						
Frequency (MHz)	Read Level (dBμV)	Factor (dB)	Level (dBμV/m)	Limit (dBμV/m)	Margin (dB)	Polarization
11590.00	41.61	3.10	44.71	54.00	9.29	Vertical
11590.00	35.82	3.10	38.92	54.00	15.08	Horizontal
Remark:						
1. Level = Reading + Factor.						
2. Test Frequency up to 40GHz, and the emission levels of other frequencies are lower than the limit 20dB, not show in test report.						

Band 4: 5725 MHz - 5825 MHz, 802.11ac-VHT80						
Test channel: Lowest channel						
Detector: Peak Value						
Frequency (MHz)	Read Level (dBμV)	Factor (dB)	Level (dBμV/m)	Limit (dBμV/m)	Margin (dB)	Polarization
5650.00	61.54	-6.53	55.01	68.20	13.19	Vertical
5700.00	62.27	-6.49	55.78	105.20	49.42	Vertical
5720.00	64.85	-6.26	58.59	110.80	52.21	Vertical
5725.00	64.36	-6.20	58.16	122.20	64.04	Vertical
5850.00	59.82	-5.49	54.33	122.20	67.87	Vertical
5855.00	60.32	-5.51	54.81	110.80	55.99	Vertical
5875.00	58.59	-5.60	52.99	105.20	52.21	Vertical
5925.00	59.34	-5.61	53.73	68.20	14.47	Vertical
11550.00	51.50	2.95	54.45	74.00	19.55	Vertical
5650.00	60.38	-6.53	53.85	68.20	14.35	Horizontal
5700.00	60.61	-6.49	54.12	105.20	51.08	Horizontal
5720.00	60.23	-6.26	53.97	110.80	56.83	Horizontal
5725.00	59.54	-6.20	53.34	122.20	68.86	Horizontal
5850.00	60.39	-5.49	54.90	122.20	67.30	Horizontal
5855.00	59.31	-5.51	53.80	110.80	57.00	Horizontal
5875.00	59.53	-5.60	53.93	105.20	51.27	Horizontal
5925.00	58.63	-5.61	53.02	68.20	15.18	Horizontal
11550.00	45.25	2.95	48.20	74.00	25.80	Horizontal
Detector: Average Value						
Frequency (MHz)	Read Level (dBμV)	Factor (dB)	Level (dBμV/m)	Limit (dBμV/m)	Margin (dB)	Polarization
11550.00	40.92	2.95	43.87	54.00	10.13	Vertical
11550.00	35.43	2.95	38.38	54.00	15.62	Horizontal
Remark:						
1. Level = Reading + Factor.						
2. Test Frequency up to 40GHz, and the emission levels of other frequencies are lower than the limit 20dB, not show in test report.						

Band 4: 5725 MHz - 5825 MHz, 802.11ax-HE20						
Test channel: Lowest channel						
Detector: Peak Value						
Frequency (MHz)	Read Level (dBμV)	Factor (dB)	Level (dBμV/m)	Limit (dBμV/m)	Margin (dB)	Polarization
5650.00	60.69	-6.53	54.16	68.20	14.04	Vertical
5700.00	60.41	-6.49	53.92	105.20	51.28	Vertical
5720.00	67.54	-6.26	61.28	110.80	49.52	Vertical
5725.00	73.54	-6.20	67.34	122.20	54.86	Vertical
11490.00	51.57	2.44	54.01	74.00	19.99	Vertical
5650.00	59.46	-6.53	52.93	68.20	15.27	Horizontal
5700.00	59.82	-6.49	53.33	105.20	51.87	Horizontal
5720.00	60.82	-6.26	54.56	110.80	56.24	Horizontal
5725.00	59.79	-6.20	53.59	122.20	68.61	Horizontal
11490.00	45.90	2.44	48.34	74.00	25.66	Horizontal
Detector: Average Value						
Frequency (MHz)	Read Level (dBμV)	Factor (dB)	Level (dBμV/m)	Limit (dBμV/m)	Margin (dB)	Polarization
11490.00	41.70	2.44	44.14	54.00	9.86	Vertical
11490.00	35.58	2.44	38.02	54.00	15.98	Horizontal
Test channel: Middle channel						
Detector: Peak Value						
Frequency (MHz)	Read Level (dBμV)	Factor (dB)	Level (dBμV/m)	Limit (dBμV/m)	Margin (dB)	Polarization
11570.00	50.73	3.02	53.75	74.00	20.25	Vertical
11570.00	44.96	3.02	47.98	74.00	26.02	Horizontal
Detector: Average Value						
Frequency (MHz)	Read Level (dBμV)	Factor (dB)	Level (dBμV/m)	Limit (dBμV/m)	Margin (dB)	Polarization
11570.00	41.11	3.02	44.13	54.00	9.87	Vertical
11570.00	35.01	3.02	38.03	54.00	15.97	Horizontal
Remark:						
1. Level = Reading + Factor.						
2. Test Frequency up to 40GHz, and the emission levels of other frequencies are lower than the limit 20dB, not show in test report.						

Test channel: Highest channel						
Detector: Peak Value						
Frequency (MHz)	Read Level (dBμV)	Factor (dB)	Level (dBμV/m)	Limit (dBμV/m)	Margin (dB)	Polarization
5850.00	59.31	-5.49	53.82	122.20	68.38	Vertical
5855.00	59.36	-5.51	53.85	110.80	56.95	Vertical
5875.00	58.21	-5.60	52.61	105.20	52.59	Vertical
5925.00	58.59	-5.61	52.98	68.20	15.22	Vertical
11650.00	51.66	2.24	53.90	74.00	20.10	Vertical
5850.00	59.40	-5.49	53.91	122.20	68.29	Horizontal
5855.00	59.23	-5.51	53.72	110.80	57.08	Horizontal
5875.00	59.60	-5.60	54.00	105.20	51.20	Horizontal
5925.00	58.92	-5.61	53.31	68.20	14.89	Horizontal
11650.00	45.66	2.24	47.90	74.00	26.10	Horizontal
Detector: Average Value						
Frequency (MHz)	Read Level (dBμV)	Factor (dB)	Level (dBμV/m)	Limit (dBμV/m)	Margin (dB)	Polarization
11650.00	40.98	2.24	43.22	54.00	10.78	Vertical
11650.00	35.57	2.24	37.81	54.00	16.19	Horizontal
Remark:						
1. Level = Reading + Factor.						
2. Test Frequency up to 40GHz, and the emission levels of other frequencies are lower than the limit 20dB, not show in test report.						

Band 4: 5725 MHz - 5825 MHz, 802.11ax-HE40						
Test channel: Lowest channel						
Detector: Peak Value						
Frequency (MHz)	Read Level (dBμV)	Factor (dB)	Level (dBμV/m)	Limit (dBμV/m)	Margin (dB)	Polarization
5650.00	60.64	-6.53	54.11	68.20	14.09	Vertical
5700.00	60.74	-6.49	54.25	105.20	50.95	Vertical
5720.00	66.52	-6.26	60.26	110.80	50.54	Vertical
5725.00	66.36	-6.20	60.16	122.20	62.04	Vertical
11510.00	50.84	2.63	53.47	74.00	20.53	Vertical
5650.00	59.98	-6.53	53.45	68.20	14.75	Horizontal
5700.00	59.58	-6.49	53.09	105.20	52.11	Horizontal
5720.00	59.75	-6.26	53.49	110.80	57.31	Horizontal
5725.00	60.30	-6.20	54.10	122.20	68.10	Horizontal
11510.00	46.23	2.63	48.86	74.00	25.14	Horizontal
Detector: Average Value						
Frequency (MHz)	Read Level (dBμV)	Factor (dB)	Level (dBμV/m)	Limit (dBμV/m)	Margin (dB)	Polarization
11510.00	41.20	2.63	43.83	54.00	10.17	Vertical
11510.00	36.10	2.63	38.73	54.00	15.27	Horizontal
Test channel: Highest channel						
Detector: Peak Value						
Frequency (MHz)	Read Level (dBμV)	Factor (dB)	Level (dBμV/m)	Limit (dBμV/m)	Margin (dB)	Polarization
5850.00	59.13	-5.49	53.64	122.20	68.56	Vertical
5855.00	59.24	-5.51	53.73	110.80	57.07	Vertical
5875.00	58.42	-5.60	52.82	105.20	52.38	Vertical
5925.00	60.12	-5.61	54.51	68.20	13.69	Vertical
11590.00	50.82	3.10	53.92	74.00	20.08	Vertical
5850.00	58.70	-5.49	53.21	122.20	68.99	Horizontal
5855.00	59.73	-5.51	54.22	110.80	56.58	Horizontal
5875.00	59.09	-5.60	53.49	105.20	51.71	Horizontal
5925.00	60.21	-5.61	54.60	68.20	13.60	Horizontal
11590.00	45.39	3.10	48.49	74.00	25.51	Horizontal
Detector: Average Value						
Frequency (MHz)	Read Level (dBμV)	Factor (dB)	Level (dBμV/m)	Limit (dBμV/m)	Margin (dB)	Polarization
11590.00	41.33	3.10	44.43	54.00	9.57	Vertical
11590.00	35.78	3.10	38.88	54.00	15.12	Horizontal
Remark:						
1. Level = Reading + Factor.						
2. Test Frequency up to 40GHz, and the emission levels of other frequencies are lower than the limit 20dB, not show in test report.						

Band 4: 5725 MHz - 5825 MHz, 802.11ax-HE80						
Test channel: Middle channel						
Detector: Peak Value						
Frequency (MHz)	Read Level (dBμV)	Factor (dB)	Level (dBμV/m)	Limit (dBμV/m)	Margin (dB)	Polarization
5650.00	61.17	-6.53	54.64	68.20	13.56	Vertical
5700.00	62.36	-6.49	55.87	105.20	49.33	Vertical
5720.00	64.86	-6.26	58.60	110.80	52.20	Vertical
5725.00	63.96	-6.20	57.76	122.20	64.44	Vertical
5850.00	59.64	-5.49	54.15	122.20	68.05	Vertical
5855.00	60.08	-5.51	54.57	110.80	56.23	Vertical
5875.00	58.31	-5.60	52.71	105.20	52.49	Vertical
5925.00	59.17	-5.61	53.56	68.20	14.64	Vertical
11550.00	51.56	2.95	54.51	74.00	19.49	Vertical
5650.00	60.13	-6.53	53.60	68.20	14.60	Horizontal
5700.00	60.85	-6.49	54.36	105.20	50.84	Horizontal
5720.00	60.36	-6.26	54.10	110.80	56.70	Horizontal
5725.00	59.70	-6.20	53.50	122.20	68.70	Horizontal
5850.00	60.45	-5.49	54.96	122.20	67.24	Horizontal
5855.00	59.60	-5.51	54.09	110.80	56.71	Horizontal
5875.00	59.40	-5.60	53.80	105.20	51.40	Horizontal
5925.00	58.13	-5.61	52.52	68.20	15.68	Horizontal
11550.00	45.24	2.95	48.19	74.00	25.81	Horizontal
Detector: Average Value						
Frequency (MHz)	Read Level (dBμV)	Factor (dB)	Level (dBμV/m)	Limit (dBμV/m)	Margin (dB)	Polarization
11550.00	41.15	2.95	44.10	54.00	9.90	Vertical
11550.00	35.51	2.95	38.46	54.00	15.54	Horizontal
Remark:						
1. <i>Level = Reading + Factor.</i>						
2. <i>Test Frequency up to 40GHz, and the emission levels of other frequencies are lower than the limit 20dB, not show in test report.</i>						

-----End of report-----