

# FCC RF Test Report

## (BLE)

**Applicant:** Hangzhou Roombanker Technology Co., Ltd.  
**Address of Applicant:** A#801 Wantong center, Hangzhou, China  
**Equipment Under Test (EUT)**  
Product Name: Multi Protocol Host Gateway  
Model No.: DSGW-291, DSGW-291-X (X:1~18)  
**FCC ID:** 2AUXBDSGW-291  
**Applicable Standards:** FCC CFR Title 47 Part 15C (§15.247)  
**Date of Sample Receipt:** 27 Feb., 2023  
**Date of Test:** 28 Feb., to 26 May, 2023  
**Date of Report Issued:** 29 May, 2023  
**Test Result:** PASS

**Tested by:** June Li **Date:** 29 May, 2023  
**Reviewed by:** anet **Date:** 29 May, 2023  
**Approved by:** Project Engineer **Date:** 29 May, 2023  
**Manager**

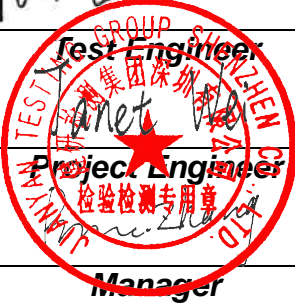

This equipment has been shown to be capable of compliance with the applicable technical standards as indicated in the measurement report and was tested in accordance with the measurement procedures specified in above the application standard version. Test results reported herein relate only to the item(s) tested.

This document cannot be reproduced except in full, without prior written approval of the Company. Any unauthorized alteration, forgery or falsification of the content or appearance of this document is unlawful and offenders may be prosecuted to the fullest extent of the law. Unless otherwise stated the results shown in this test report refer only to the sample(s) tested and such sample(s) are retained for 90 days only.

## 1 Version

| Version No. | Date         | Description |
|-------------|--------------|-------------|
| 00          | 29 May, 2023 | Original    |
|             |              |             |
|             |              |             |
|             |              |             |
|             |              |             |

## 2 Contents

Page

|   |    |
|---|----|
| Cover Page .....  | 1  |
| 1 Version .....   | 2  |
| 2 Contents .....  | 3  |
| 3 General Information .....                                       | 4  |
| 3.1 Client Information .....                                      | 4  |
| 3.2 General Description of E.U.T. ....                            | 4  |
| 3.3 Test Mode and Test Environment .....                          | 4  |
| 3.4 Description of Test Auxiliary Equipment .....                 | 4  |
| 3.5 Measurement Uncertainty .....                                 | 5  |
| 3.6 Additions to, Deviations, or Exclusions from the Method ..... | 5  |
| 3.7 Laboratory Facility .....                                     | 5  |
| 3.8 Laboratory Location .....                                     | 5  |
| 3.9 Test Instruments List .....                                   | 6  |
| 4 Measurement Setup and Procedure .....                           | 7  |
| 4.1 Test Channel .....  | 7  |
| 4.2 Test Setup .....  | 7  |
| 4.3 Test Procedure .....  | 9  |
| 5 Test Results .....  | 10 |
| 5.1 Summary .....   | 10 |
| 5.1.1 Clause and Data Summary .....                               | 10 |
| 5.1.2 Test Limit .....  | 11 |
| 5.2 Antenna requirement .....                                     | 12 |
| 5.3 AC Power Line Conducted Emission .....                        | 13 |
| 5.4 Emissions in Restricted Frequency Bands .....                 | 15 |
| 5.5 Emissions in Non-restricted Frequency Bands .....             | 31 |

### 3 General Information

#### 3.1 Client Information

|               |  |
|---------------|--|
| Applicant:    | Hangzhou Roombanker Technology Co., Ltd. |
| Address:      | A#801 Wantong center, Hangzhou, China    |
| Manufacturer: | Hangzhou Roombanker Technology Co., Ltd. |
| Address:      | A#801 Wantong center, Hangzhou, China    |

#### 3.2 General Description of E.U.T.

|                        |   |
|------------------------|---|
| Product Name:          | Multi Protocol Host Gateway   |
| Model No.:             | DSGW-291, DSGW-291-X (X:1~18)   |
| Operation Frequency:   | 2402 MHz - 2480 MHz   |
| Channel Numbers:       | 40  |
| Channel Separation:    | 2MHz  |
| Modulation Technology: | GFSK  |
| Data Speed:            | 1 Mbps (LE 1M PHY), 2 Mbps (LE 2M PHY), 125 kbps (LE Coded PHY, S=8), 500 kbps (LE Coded PHY, S=2)  |
| Antenna Type:          | External Antenna  |
| Antenna Gain:          | 2.41 dBi (declare by applicant)   |
| Antenna transmit mode: | SISO (1TX, 1RX)   |
| Power Supply:          | DC 12V  |
| Test Sample Condition: | The test samples were provided in good working order with no visible defects.   |
| Remark:                | DSGW-291, DSGW-291-X (X:1~18) were identical inside, the electrical circuit design, layout, components used and internal wiring, with only difference being model name. |

#### 3.3 Test Mode and Test Environment

|  |   |
|--|---|
| <b>Test Mode:</b>  |   |
| Transmitting mode  | Keep the EUT in continuous transmitting with modulation |
| <b>Remark:</b>   |   |
| 1. For AC power line conducted emission and radiated spurious emission (below 1GHz), pre-scan all data speed, found 1 Mbps (LE 1M PHY) was worse case mode. The report only reflects the test data of worst mode.<br>2. Channel Low, Mid and High for each type band with rated data rate were chosen for full testing. The field strength of spurious radiation emission was measured as EUT stand-up position (H mode) and lie down position (E1, E2 mode) for these modes. Just the worst case position (H mode) shown in report. |   |
| <b>Operating Environment:</b>  |   |
| Temperature:   | 15°C ~ 35°C   |
| Humidity:  | 20 % ~ 75 % RH  |
| Atmospheric Pressure:  | 1008 mbar   |

#### 3.4 Description of Test Auxiliary Equipment

|   |
|---|
| The EUT has been tested as an independent unit. |
|---|

### 3.5 Measurement Uncertainty

| Parameter                                   | Expanded Uncertainty<br>(Confidence of 95%(U = 2Uc(y))) |
|---|---|
| Conducted Emission for LISN (9kHz ~ 10MHz)  | 1.9 dB  |
| Conducted Emission for LISN (10MHz ~ 30MHz) | 2.6 dB  |
| Radiated Emission (30MHz ~ 1GHz) (3m SAC)   | 3.8 dB  |
| Radiated Emission (1GHz ~ 18GHz) (3m SAC)   | 3.6 dB  |
| Radiated Emission (18GHz ~ 40GHz) (3m SAC)  | 5.34 dB   |
| Radiated Emission (30MHz ~ 1GHz) (10m SAC)  | 3.7 dB  |

**Note:** All the measurement uncertainty value were shown with a coverage  $k=2$  to indicate 95% level of confidence. The measurement data show herein meets or exceeds the CISPR measurement uncertainty values specified in CISPR 16-4-2 and can be compared directly to specified limit to determine compliance.

### 3.6 Additions to, Deviations, or Exclusions from the Method

|    |
|----|
| No |
|----|

### 3.7 Laboratory Facility

|   |
|---|
| <p>The test facility is recognized, certified, or accredited by the following organizations:</p> <ul style="list-style-type: none"> <li>● <b>FCC - Designation No.: CN1211</b><br/>JianYan Testing Group Shenzhen Co., Ltd. has been accredited as a testing laboratory by FCC(Federal Communications Commission). The test firm Registration No. is 727551.</li> <li>● <b>ISED – CAB identifier.: CN0021</b><br/>The 3m Semi-anechoic chamber and 10m Semi-anechoic chamber of JianYan Testing Group Shenzhen Co., Ltd. has been Registered by Certification and Engineering Bureau of Industry Canada for radio equipment testing with Registration No.: 10106A-1.</li> <li>● <b>CNAS - Registration No.: CNAS L15527</b><br/>JianYan Testing Group Shenzhen Co., Ltd. is accredited to ISO/IEC 17025:2017 General Requirements for the Competence of Testing and Calibration laboratories for the competence of testing. The Registration No. is CNAS L15527.</li> <li>● <b>A2LA - Registratrion No.: 4346.01</b><br/>This laboratory is accredited in accordance with the recognized International Standard ISO/IEC 17025:2017 General requirements for the competence of testing and calibration laboratories. The test scope can be found as below link: <a href="https://portal.a2la.org/scopepdf/4346-01.pdf">https://portal.a2la.org/scopepdf/4346-01.pdf</a></li> </ul> |
|---|

### 3.8 Laboratory Location

|   |
|---|
| <p>JianYan Testing Group Shenzhen Co., Ltd.<br/>Address: No.101, Building 8, Innovation Wisdom Port, No.155 Hongtian Road, Huangpu Community, Xinqiao Street, Bao'an District, Shenzhen, Guangdong, People's Republic of China.<br/>Tel: +86-755-23118282, Fax: +86-755-23116366<br/>Email: info-JYTee@lets.com, Website: <a href="http://jyt.lets.com">http://jyt.lets.com</a></p> |
|---|

### 3.9 Test Instruments List

| Radiated Emission(3m SAC):    |                 |                 |                  |                      |                          |
|-------------------------------|-----------------|-----------------|------------------|----------------------|--------------------------|
| Test Equipment                | Manufacturer    | Model No.       | Manage No.       | Cal. Date (mm-dd-yy) | Cal. Due date (mm-dd-yy) |
| 3m SAC                        | ETS             | 9m*6m*6m        | WXJ001-1         | 04-14-2021           | 04-13-2024               |
| Loop Antenna                  | Schwarzbeck     | FMZB 1519 B     | WXJ002-4         | 02-09-2023           | 02-08-2024               |
| BiConiLog Antenna             | Schwarzbeck     | VULB9163        | WXJ002           | 02-09-2023           | 02-08-2024               |
| Horn Antenna                  | Schwarzbeck     | BBHA9120D       | WXJ002-2         | 02-09-2023           | 02-08-2024               |
| Horn Antenna                  | Schwarzbeck     | BBHA9170        | WXJ002-5         | 01-09-2023           | 01-08-2024               |
| Pre-amplifier (30MHz ~ 1GHz)  | Schwarzbeck     | BBV9743B        | WXJ001-2         | 01-10-2023           | 01-09-2024               |
| Pre-amplifier (1GHz ~ 18GHz)  | SKET            | LNPA_0118G-50   | WXJ001-3         | 01-10-2023           | 01-09-2024               |
| Pre-amplifier (18GHz ~ 40GHz) | RF System       | TRLA-180400G45B | WXJ002-7         | 01-11-2023           | 01-10-2024               |
| EMI Test Receiver             | Rohde & Schwarz | ESRP7           | WXJ003-1         | 01-11-2023           | 01-10-2024               |
| Spectrum Analyzer             | Rohde & Schwarz | FSP 30          | WXJ004           | 01-10-2023           | 01-09-2024               |
| Spectrum Analyzer             | KEYSIGHT        | N9010B          | WXJ004-2         | 10-17-2022           | 10-16-2023               |
| Coaxial Cable (30MHz ~ 1GHz)  | JYTSZ           | JYT3M-1G-NN-8M  | WXG001-4         | 01-18-2023           | 01-17-2024               |
| Coaxial Cable (1GHz ~ 18GHz)  | JYTSZ           | JYT3M-18G-NN-8M | WXG001-5         | 01-18-2023           | 01-17-2024               |
| Coaxial Cable (18GHz ~ 40GHz) | JYTSZ           | JYT3M-40G-SS-8M | WXG001-7         | 01-18-2023           | 01-17-2024               |
| Band Reject Filter Group      | Tonscend        | JS0806-F        | WXJ089           | N/A                  |                          |
| Test Software                 | Tonscend        | TS+             | Version: 3.0.0.1 |                      |                          |

| Conducted Emission:               |                 |                |                    |                      |                          |
|-----------------------------------|-----------------|----------------|--------------------|----------------------|--------------------------|
| Test Equipment                    | Manufacturer    | Model No.      | Manage No.         | Cal. Date (mm-dd-yy) | Cal. Due date (mm-dd-yy) |
| EMI Test Receiver                 | Rohde & Schwarz | ESR3           | WXJ003-2           | 07-12-2022           | 07-11-2023               |
| LISN                              | Schwarzbeck     | NSLK 8127      | QCJ001-13          | 01-10-2023           | 01-09-2024               |
| LISN                              | Rohde & Schwarz | ESH3-Z5        | WXJ005-1           | 01-11-2023           | 01-10-2024               |
| LISN Coaxial Cable (9kHz ~ 30MHz) | JYTSZ           | JYTCE-1G-NN-2M | WXG003-1           | 02-22-2023           | 02-21-2024               |
| RF Switch                         | TOP PRECISION   | RSU0301        | WXG003             | N/A                  |                          |
| Test Software                     | AUDIX           | E3             | Version: 6.110919b |                      |                          |

| Conducted Method:            |              |            |                  |                      |                          |
|------------------------------|--------------|------------|------------------|----------------------|--------------------------|
| Test Equipment               | Manufacturer | Model No.  | Manage No.       | Cal. Date (mm-dd-yy) | Cal. Due date (mm-dd-yy) |
| Spectrum Analyzer            | Keysight     | N9010B     | WXJ004-3         | 10-17-2022           | 10-16-2023               |
| Temperature Humidity Chamber | ZHONG ZHI    | CZ-A-80D   | WXJ032-3         | 01-09-2023           | 01-08-2025               |
| Power Detector Box           | MWRFTTEST    | MW100-PSB  | WXJ007-4         | 10-17-2022           | 10-16-2023               |
| DC Power Supply              | Keysight     | E3642A     | WXJ025-2         | N/A                  |                          |
| RF Control Unit              | MWRFTTEST    | MW100-RFCB | WXG006           | N/A                  |                          |
| Test Software                | MWRFTTEST    | MTS 8310   | Version: 2.0.0.0 |                      |                          |

## 4 Measurement Setup and Procedure

### 4.1 Test Channel

According to ANSI C63.10-2013 chapter 5.6.1 Table 4 requirement, select lowest channel, middle channel, and highest channel in the frequency range in which device operates for testing. The detailed frequency points are as follows:

| Lowest channel |                 | Middle channel |                 | Highest channel |                 |
|----------------|-----------------|----------------|-----------------|-----------------|-----------------|
| Channel No.    | Frequency (MHz) | Channel No.    | Frequency (MHz) | Channel No.     | Frequency (MHz) |
| 0              | 2402            | 20             | 2442            | 39              | 2480            |

### 4.2 Test Setup

#### 1) Conducted emission measurement:

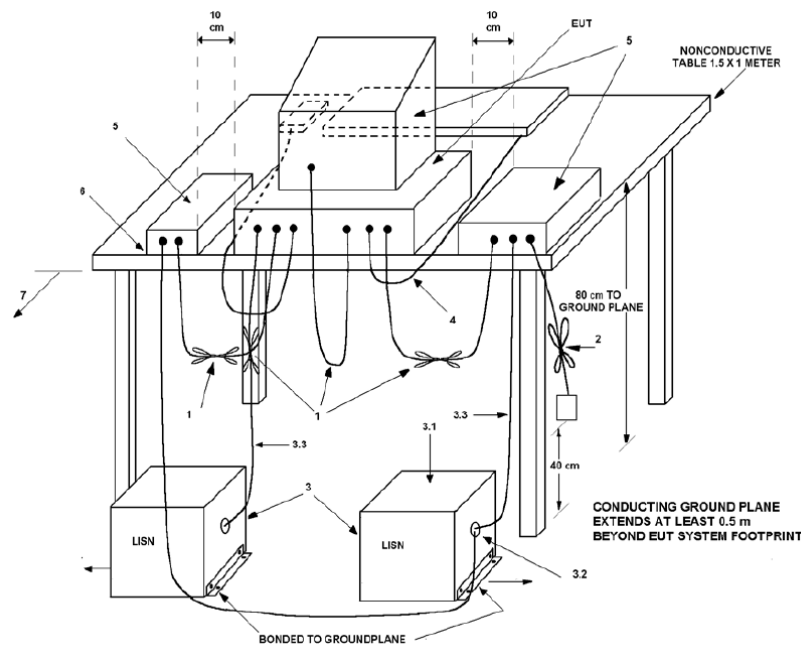

**Note:** The detailed descriptions please refer to Figure 8 of ANSI C63.4:2014.

#### 2) Radiated emission measurement:

Below 1GHz (3m SAC)

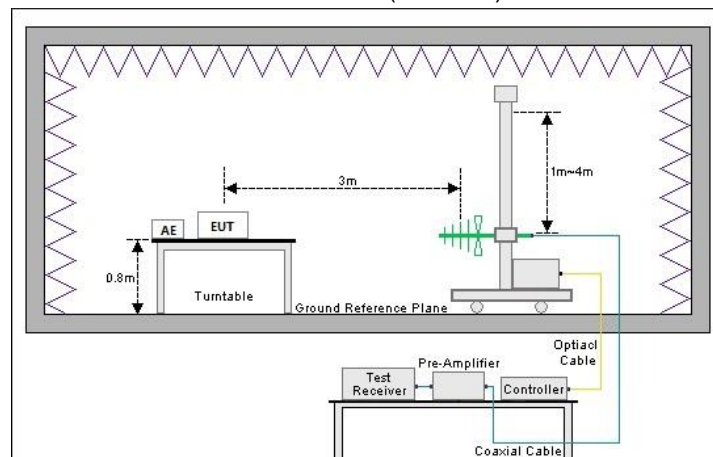

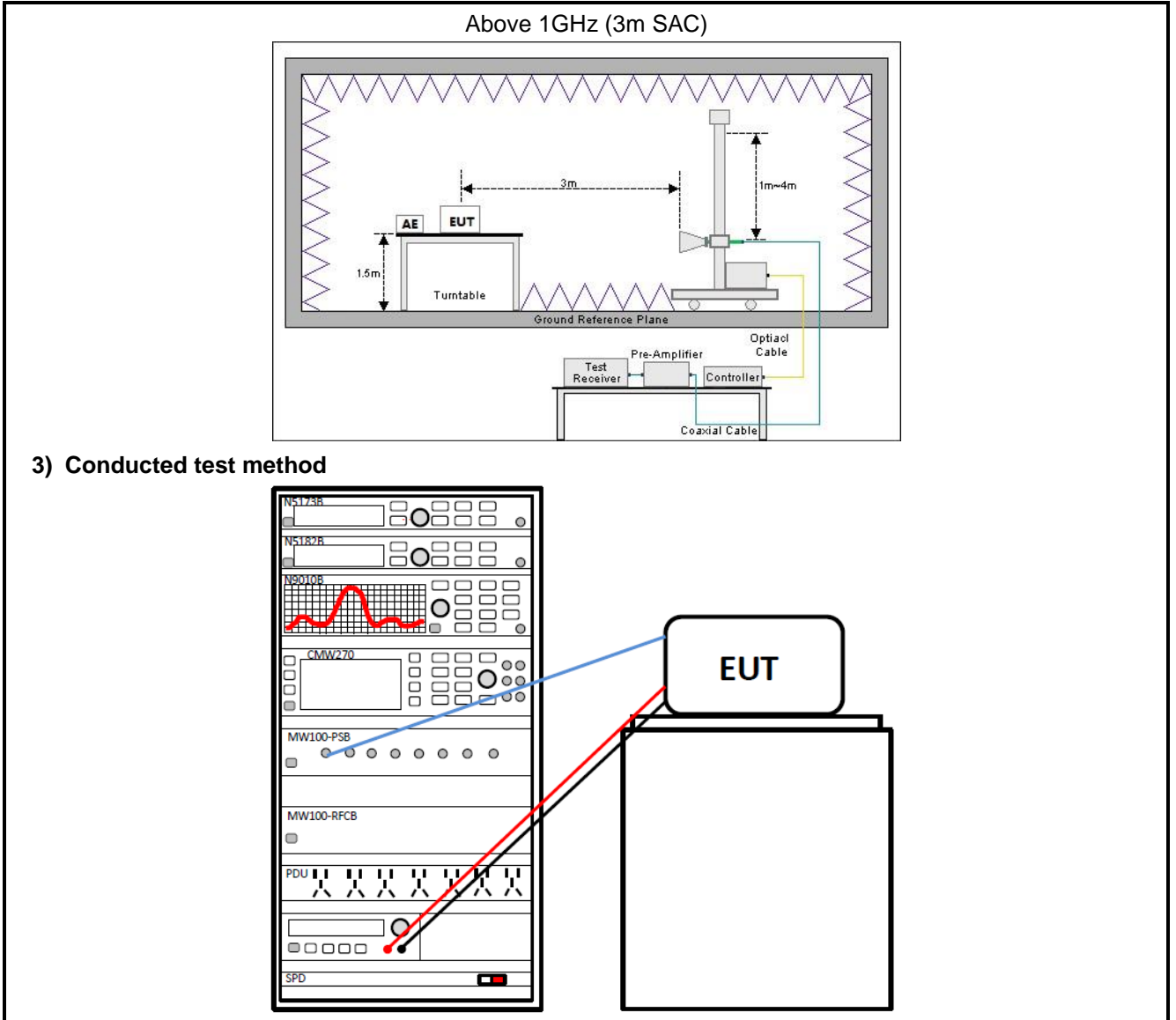



### 4.3 Test Procedure

| Test method           | Test step   |
|-----------------------|---|
| Conducted emission    | <ol style="list-style-type: none"> <li>1. The E.U.T and simulators are connected to the main power through a line impedance stabilization network (L.I.S.N.). This provides a 50ohm/50uH coupling impedance for the measuring equipment.</li> <li>2. The peripheral devices are also connected to the main power through a LISN that provides a 50ohm/50uH coupling impedance with 50ohm termination. (Please refer to the block diagram of the test setup and photographs).</li> <li>3. Both sides of A.C. line are checked for maximum conducted interference. In order to find the maximum emission, the relative positions of equipment and all of the interface cables must be changed according to ANSI C63.10 on conducted measurement.</li> </ol>   |
| Radiated emission     | <p><b>For below 1GHz:</b></p> <ol style="list-style-type: none"> <li>1. The EUT was placed on the tabletop of a rotating table 0.8 m the ground at a 3 m semi anechoic chamber. The measurement distance from the EUT to the receiving antenna is 3 m.</li> <li>2. EUT works in each mode of operation that needs to be tested , and having the EUT continuously working, respectively on 3 axis (X, Y &amp; Z) and considered typical configuration to obtain worst position. The highest signal levels relative to the limit shall be determined by rotating the EUT from 0° to 360° and with varying the measurement antenna height between 1 m and 4 m in vertical and horizontal polarizations.</li> <li>3. Open the test software to control the test antenna and test turntable. Perform the test, save the test results, and export the test data.</li> </ol> <p><b>For above 1GHz:</b></p> <ol style="list-style-type: none"> <li>1. The EUT was placed on the tabletop of a rotating table 1.5 m the ground at a 3 m fully anechoic room. The measurement distance from the EUT to the receiving antenna is 3 m.</li> <li>2. EUT works in each mode of operation that needs to be tested , and having the EUT continuously working, respectively on 3 axis (X, Y &amp; Z) and considered typical configuration to obtain worst position. The highest signal levels relative to the limit shall be determined by rotating the EUT from 0° to 360° and with varying the measurement antenna height between 1 m and 4 m in vertical and horizontal polarizations.</li> <li>3. Open the test software to control the test antenna and test turntable. Perform the test, save the test results, and export the test data.</li> </ol> |
| Conducted test method | <ol style="list-style-type: none"> <li>1. The BLE antenna port of EUT was connected to the test port of the test system through an RF cable.</li> <li>2. The EUT is keeping in continuous transmission mode and tested in all modulation modes.</li> <li>3. Open the test software, prepare a test plan, and control the system through the software. After the test is completed, the test report is exported through the test software.</li> </ol>  |

## 5 Test Results

### 5.1 Summary

#### 5.1.1 Clause and Data Summary

| Test items   | Standard clause  | Test data  | Result |
|--|--|--|--------|
| Antenna Requirement  | 15.203<br>15.247 (b)(4)  | See Section 5.2  | Pass   |
| AC Power Line Conducted Emission   | 15.207   | See Section 5.3  | Pass   |
| Conducted Output Power   | 15.247 (b)(3)  | Appendix A – BLE-1M PHY<br>Appendix A – BLE-2M PHY<br>Appendix A – BLE-Coded PHY,S=2<br>Appendix A – BLE-Coded PHY,S=8 | Pass   |
| 6dB Emission Bandwidth<br>99% Occupied Bandwidth   | 15.247 (a)(2)  | Appendix A – BLE-1M PHY<br>Appendix A – BLE-2M PHY<br>Appendix A – BLE-Coded PHY,S=2<br>Appendix A – BLE-Coded PHY,S=8 | Pass   |
| Power Spectral Density   | 15.247 (e)   | Appendix A – BLE-1M PHY<br>Appendix A – BLE-2M PHY<br>Appendix A – BLE-Coded PHY,S=2<br>Appendix A – BLE-Coded PHY,S=8 | Pass   |
| Band-edge Emission<br>Conduction Spurious Emission   | 15.247 (d)   | Appendix A – BLE-1M PHY<br>Appendix A – BLE-2M PHY<br>Appendix A – BLE-Coded PHY,S=2<br>Appendix A – BLE-Coded PHY,S=8 | Pass   |
| Emissions in Restricted<br>Frequency Bands   | 15.205<br>15.247 (d)   | See Section 5.4  | Pass   |
| Emissions in Non-restricted<br>Frequency Bands   | 15.209<br>15.247(d)  | See Section 5.5  | Pass   |
| <b>Remark:</b><br>1. Pass: The EUT complies with the essential requirements in the standard.<br>2. N/A: Not Applicable.<br>3. The cable insertion loss used by “RF Output Power” and other conduction measurement items is 0.5dB (provided by the customer). |  |  |        |
| <b>Test Method:</b>  | ANSI C63.10-2013<br>KDB 558074 D01 15.247 Meas Guidance v05r02 |  |        |

### 5.1.2 Test Limit

| Test items   | Limit  |                                |                      |  |            |         |            |                                |                                |         |            |          |        |      |            |           |      |      |            |            |      |      |            |           |                           |  |         |       |             |      |      |
|--|--|--------------------------------|----------------------|--|------------|---------|------------|--------------------------------|--------------------------------|---------|------------|----------|--------|------|------------|-----------|------|------|------------|------------|------|------|------------|-----------|---------------------------|--|---------|-------|-------------|------|------|
| AC Power Line Conducted Emission   | <table border="1"> <thead> <tr> <th rowspan="2">Frequency (MHz)</th> <th colspan="2">Limit (dB<math>\mu</math>V)</th> </tr> <tr> <th>Quasi-Peak</th> <th>Average</th> </tr> </thead> <tbody> <tr> <td>0.15 – 0.5</td> <td>66 to 56 <small>Note 1</small></td> <td>56 to 46 <small>Note 1</small></td> </tr> <tr> <td>0.5 – 5</td> <td>56</td> <td>46</td> </tr> <tr> <td>5 – 30</td> <td>60</td> <td>50</td> </tr> </tbody> </table> <p><b>Note 1:</b> The limit level in dB<math>\mu</math>V decreases linearly with the logarithm of frequency.<br/> <b>Note 2:</b> The more stringent limit applies at transition frequencies.</p>  | Frequency (MHz)                | Limit (dB $\mu$ V)   |  | Quasi-Peak | Average | 0.15 – 0.5 | 66 to 56 <small>Note 1</small> | 56 to 46 <small>Note 1</small> | 0.5 – 5 | 56         | 46       | 5 – 30 | 60   | 50         |           |      |      |            |            |      |      |            |           |                           |  |         |       |             |      |      |
| Frequency (MHz)  | Limit (dB $\mu$ V)   |                                |                      |  |            |         |            |                                |                                |         |            |          |        |      |            |           |      |      |            |            |      |      |            |           |                           |  |         |       |             |      |      |
|  | Quasi-Peak   | Average                        |                      |  |            |         |            |                                |                                |         |            |          |        |      |            |           |      |      |            |            |      |      |            |           |                           |  |         |       |             |      |      |
| 0.15 – 0.5   | 66 to 56 <small>Note 1</small>   | 56 to 46 <small>Note 1</small> |                      |  |            |         |            |                                |                                |         |            |          |        |      |            |           |      |      |            |            |      |      |            |           |                           |  |         |       |             |      |      |
| 0.5 – 5  | 56   | 46                             |                      |  |            |         |            |                                |                                |         |            |          |        |      |            |           |      |      |            |            |      |      |            |           |                           |  |         |       |             |      |      |
| 5 – 30   | 60   | 50                             |                      |  |            |         |            |                                |                                |         |            |          |        |      |            |           |      |      |            |            |      |      |            |           |                           |  |         |       |             |      |      |
| Conducted Output Power   | For systems using digital modulation in the 902-928 MHz, 2400-2483.5 MHz, and 5725-5850 MHz bands: 1 Watt.   |                                |                      |  |            |         |            |                                |                                |         |            |          |        |      |            |           |      |      |            |            |      |      |            |           |                           |  |         |       |             |      |      |
| 6dB Emission Bandwidth   | The minimum 6 dB bandwidth shall be at least 500 kHz.  |                                |                      |  |            |         |            |                                |                                |         |            |          |        |      |            |           |      |      |            |            |      |      |            |           |                           |  |         |       |             |      |      |
| 99% Occupied Bandwidth   | N/A  |                                |                      |  |            |         |            |                                |                                |         |            |          |        |      |            |           |      |      |            |            |      |      |            |           |                           |  |         |       |             |      |      |
| Power Spectral Density   | For digitally modulated systems, the power spectral density conducted from the intentional radiator to the antenna shall not be greater than 8 dBm in any 3 kHz band during any time interval of continuous transmission.  |                                |                      |  |            |         |            |                                |                                |         |            |          |        |      |            |           |      |      |            |            |      |      |            |           |                           |  |         |       |             |      |      |
| Band-edge Emission<br><br>Conduction Spurious Emission                                     | In any 100 kHz bandwidth outside the frequency band in which the spread spectrum or digitally modulated intentional radiator is operating, the radio frequency power that is produced by the intentional radiator shall be at least 20 dB below that in the 100 kHz bandwidth within the band that contains the highest level of the desired power, based on either an RF conducted or a radiated measurement, provided the transmitter demonstrates compliance with the peak conducted power limits. If the transmitter complies with the conducted power limits based on the use of RMS averaging over a time interval, as permitted under paragraph (b)(3) of this section, the attenuation required under this paragraph shall be 30 dB instead of 20 dB. Attenuation below the general limits specified in §15.209(a) is not required. In addition, radiated emissions which fall in the restricted bands, as defined in §15.205(a), must also comply with the radiated emission limits specified in §15.209(a) (see §15.205(c)). |                                |                      |  |            |         |            |                                |                                |         |            |          |        |      |            |           |      |      |            |            |      |      |            |           |                           |  |         |       |             |      |      |
| Emissions in Restricted Frequency Bands<br><br>Emissions in Non-restricted Frequency Bands | <table border="1"> <thead> <tr> <th rowspan="2">Frequency (MHz)</th> <th colspan="2">Limit (dB<math>\mu</math>V/m)</th> <th rowspan="2">Detector</th> </tr> <tr> <th>@ 3m</th> <th>@ 10m</th> </tr> </thead> <tbody> <tr> <td>30 – 88</td> <td>40.0</td> <td>30.0</td> <td>Quasi-peak</td> </tr> <tr> <td>88 – 216</td> <td>43.5</td> <td>33.5</td> <td>Quasi-peak</td> </tr> <tr> <td>216 – 960</td> <td>46.0</td> <td>36.0</td> <td>Quasi-peak</td> </tr> <tr> <td>960 – 1000</td> <td>54.0</td> <td>44.0</td> <td>Quasi-peak</td> </tr> </tbody> </table> <p><b>Note:</b> The more stringent limit applies at transition frequencies.</p> <table border="1"> <thead> <tr> <th rowspan="2">Frequency</th> <th colspan="2">Limit (dB<math>\mu</math>V/m) @ 3m</th> </tr> <tr> <th>Average</th> <th>Peake</th> </tr> </thead> <tbody> <tr> <td>Above 1 GHz</td> <td>54.0</td> <td>74.0</td> </tr> </tbody> </table> <p><b>Note:</b> The measurement bandwidth shall be 1 MHz or greater.</p>   | Frequency (MHz)                | Limit (dB $\mu$ V/m) |  | Detector   | @ 3m    | @ 10m      | 30 – 88                        | 40.0                           | 30.0    | Quasi-peak | 88 – 216 | 43.5   | 33.5 | Quasi-peak | 216 – 960 | 46.0 | 36.0 | Quasi-peak | 960 – 1000 | 54.0 | 44.0 | Quasi-peak | Frequency | Limit (dB $\mu$ V/m) @ 3m |  | Average | Peake | Above 1 GHz | 54.0 | 74.0 |
| Frequency (MHz)  | Limit (dB $\mu$ V/m)   |                                | Detector             |  |            |         |            |                                |                                |         |            |          |        |      |            |           |      |      |            |            |      |      |            |           |                           |  |         |       |             |      |      |
|  | @ 3m   | @ 10m                          |                      |  |            |         |            |                                |                                |         |            |          |        |      |            |           |      |      |            |            |      |      |            |           |                           |  |         |       |             |      |      |
| 30 – 88  | 40.0   | 30.0                           | Quasi-peak           |  |            |         |            |                                |                                |         |            |          |        |      |            |           |      |      |            |            |      |      |            |           |                           |  |         |       |             |      |      |
| 88 – 216   | 43.5   | 33.5                           | Quasi-peak           |  |            |         |            |                                |                                |         |            |          |        |      |            |           |      |      |            |            |      |      |            |           |                           |  |         |       |             |      |      |
| 216 – 960  | 46.0   | 36.0                           | Quasi-peak           |  |            |         |            |                                |                                |         |            |          |        |      |            |           |      |      |            |            |      |      |            |           |                           |  |         |       |             |      |      |
| 960 – 1000   | 54.0   | 44.0                           | Quasi-peak           |  |            |         |            |                                |                                |         |            |          |        |      |            |           |      |      |            |            |      |      |            |           |                           |  |         |       |             |      |      |
| Frequency  | Limit (dB $\mu$ V/m) @ 3m  |                                |                      |  |            |         |            |                                |                                |         |            |          |        |      |            |           |      |      |            |            |      |      |            |           |                           |  |         |       |             |      |      |
|  | Average  | Peake                          |                      |  |            |         |            |                                |                                |         |            |          |        |      |            |           |      |      |            |            |      |      |            |           |                           |  |         |       |             |      |      |
| Above 1 GHz  | 54.0   | 74.0                           |                      |  |            |         |            |                                |                                |         |            |          |        |      |            |           |      |      |            |            |      |      |            |           |                           |  |         |       |             |      |      |

## 5.2 Antenna requirement

|   |   |
|---|---|
| <b>Standard requirement:</b>  | FCC Part 15 C Section 15.203 /247(b)(4) |
| <p><b>15.203 requirement:</b><br/>An intentional radiator shall be designed to ensure that no antenna other than that furnished by the responsible party shall be used with the device. The use of a permanently attached antenna or of an antenna that uses a unique coupling to the intentional radiator, the manufacturer may design the unit so that a broken antenna can be replaced by the user, but the use of a standard antenna jack or electrical connector is prohibited.</p>  |   |
| <p><b>15.247(b) (4) requirement:</b><br/>(4) The conducted output power limit specified in paragraph (b) of this section is based on the use of antennas with directional gains that do not exceed 6 dBi. Except as shown in paragraph (c) of this section, if transmitting antennas of directional gain greater than 6 dBi are used, the conducted output power from the intentional radiator shall be reduced below the stated values in paragraphs (b)(1), (b)(2), and (b)(3) of this section, as appropriate, by the amount in dB that the directional gain of the antenna exceeds 6 dBi.</p> |   |
| <b>E.U.T Antenna:</b>   |   |
| <p>The BLE antenna is an Internal antenna which cannot replace by end-user, the best case gain of the antenna is 2.41 dBi. See product internal photos for details.</p>   |   |

### 5.3 AC Power Line Conducted Emission

|                        |                             |                       |                     |
|------------------------|-----------------------------|-----------------------|---------------------|
| <b>Product name:</b>   | Multi Protocol Host Gateway | <b>Product model:</b> | DSGW-291-X (X:1~18) |
| <b>Test by:</b>        | June                        | <b>Test mode:</b>     | BLE Tx (LE 1M PHY)  |
| <b>Test frequency:</b> | 150 kHz ~ 30 MHz            | <b>Phase:</b>         | Line                |
| <b>Test voltage:</b>   | AC 120 V/60 Hz              |                       |                     |

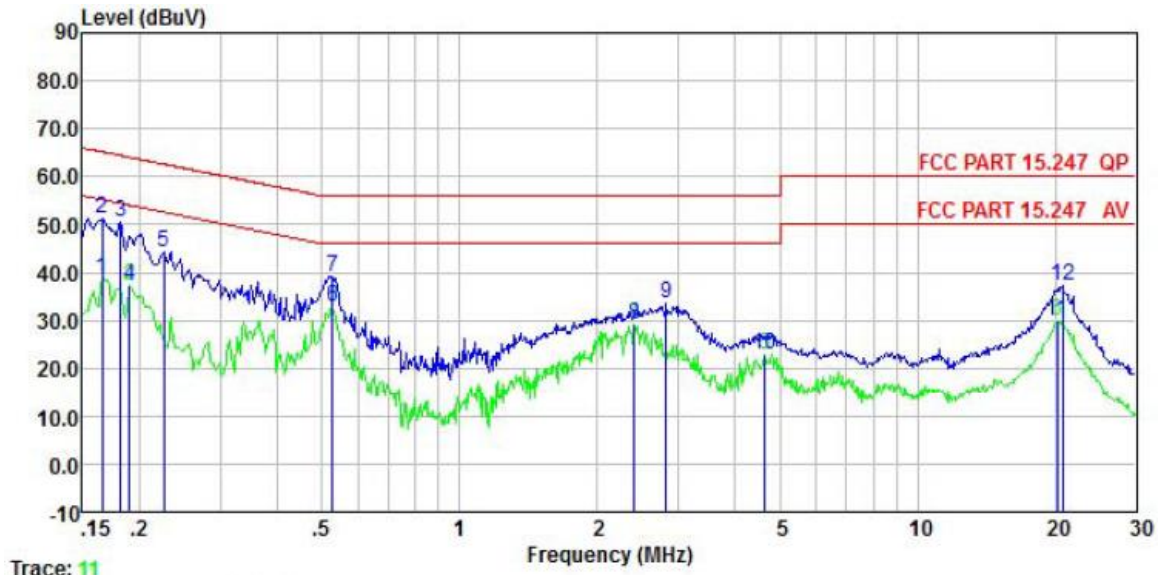

Trace: 11

|    | Freq   | Read Level | LISN Factor | Aux2 Factor | Cable Loss | Level | Limit Line | Over Limit | Remark  |
|----|--------|------------|-------------|-------------|------------|-------|------------|------------|---------|
|    | MHz    | dBuV       | dB          | dB          | dB         | dBuV  | dBuV       | dB         |         |
| 1  | 0.166  | 28.10      | 0.04        | 10.50       | 0.01       | 38.65 | 55.16      | -16.51     | Average |
| 2  | 0.166  | 40.56      | 0.04        | 10.50       | 0.01       | 51.11 | 65.16      | -14.05     | QP      |
| 3  | 0.182  | 39.99      | 0.05        | 10.50       | 0.01       | 50.55 | 64.42      | -13.87     | QP      |
| 4  | 0.190  | 26.66      | 0.05        | 10.50       | 0.03       | 37.24 | 54.02      | -16.78     | Average |
| 5  | 0.226  | 33.80      | 0.05        | 10.50       | 0.02       | 44.37 | 62.61      | -18.24     | QP      |
| 6  | 0.527  | 22.39      | 0.05        | 10.50       | 0.03       | 32.97 | 46.00      | -13.03     | Average |
| 7  | 0.527  | 28.57      | 0.05        | 10.50       | 0.03       | 39.15 | 56.00      | -16.85     | QP      |
| 8  | 2.409  | 18.50      | 0.08        | 10.50       | 0.15       | 29.23 | 46.00      | -16.77     | Average |
| 9  | 2.824  | 22.86      | 0.09        | 10.50       | 0.09       | 33.54 | 56.00      | -22.46     | QP      |
| 10 | 4.647  | 12.31      | 0.12        | 10.50       | 0.09       | 23.02 | 46.00      | -22.98     | Average |
| 11 | 20.162 | 18.90      | 0.34        | 10.50       | 0.19       | 29.93 | 50.00      | -20.07     | Average |
| 12 | 20.704 | 26.18      | 0.35        | 10.50       | 0.18       | 37.21 | 60.00      | -22.79     | QP      |

**Remark:**

1. Level = Read level + LISN Factor + Cable Loss.

|                        |                             |                       |                     |
|------------------------|-----------------------------|-----------------------|---------------------|
| <b>Product name:</b>   | Multi Protocol Host Gateway | <b>Product model:</b> | DSGW-291-X (X:1~18) |
| <b>Test by:</b>        | June                        | <b>Test mode:</b>     | BLE Tx (LE 1M PHY)  |
| <b>Test frequency:</b> | 150 kHz ~ 30 MHz            | <b>Phase:</b>         | Neutral             |
| <b>Test voltage:</b>   | AC 120 V/60 Hz              |                       |                     |

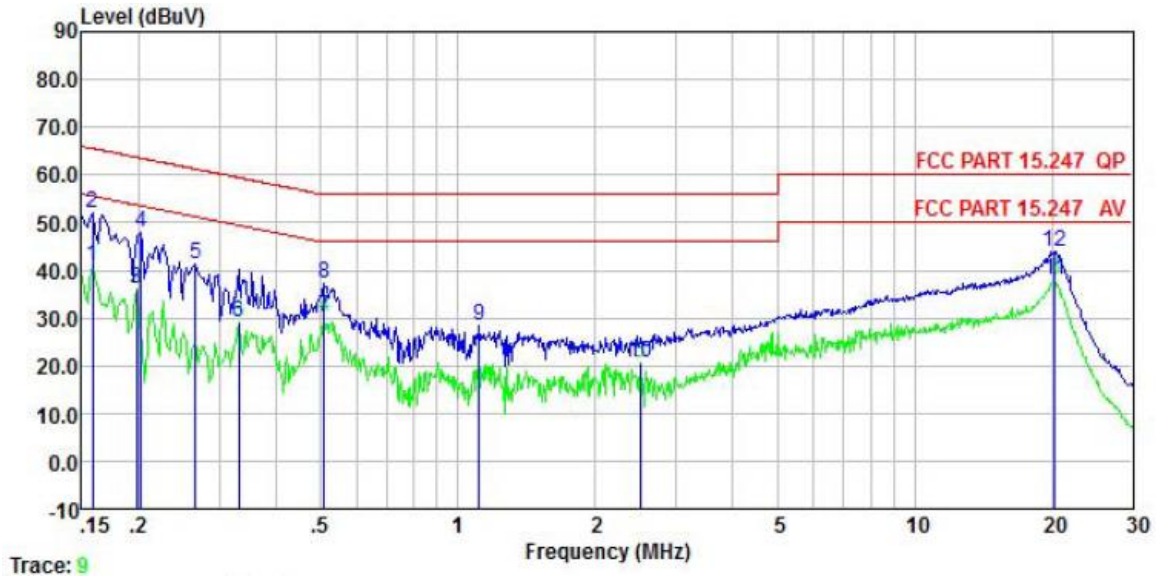

|    | Freq   | Read Level | LISN Factor | Aux2 Factor | Cable Loss | Level | Limit Line | Over Limit | Remark  |
|----|--------|------------|-------------|-------------|------------|-------|------------|------------|---------|
|    | MHz    | dBuV       | dB          | dB          | dB         | dBuV  | dBuV       | dB         |         |
| 1  | 0.158  | 30.37      | 0.06        | 10.50       | 0.01       | 40.94 | 55.56      | -14.62     | Average |
| 2  | 0.158  | 41.36      | 0.06        | 10.50       | 0.01       | 51.93 | 65.56      | -13.63     | QP      |
| 3  | 0.198  | 25.53      | 0.05        | 10.50       | 0.04       | 36.12 | 53.71      | -17.59     | Average |
| 4  | 0.202  | 37.40      | 0.05        | 10.50       | 0.04       | 47.99 | 63.54      | -15.55     | QP      |
| 5  | 0.266  | 30.58      | 0.05        | 10.50       | 0.02       | 41.15 | 61.25      | -20.10     | QP      |
| 6  | 0.330  | 18.42      | 0.05        | 10.50       | 0.02       | 28.99 | 49.44      | -20.45     | Average |
| 7  | 0.510  | 19.70      | 0.04        | 10.50       | 0.03       | 30.27 | 46.00      | -15.73     | Average |
| 8  | 0.510  | 26.69      | 0.04        | 10.50       | 0.03       | 37.26 | 56.00      | -18.74     | QP      |
| 9  | 1.111  | 17.60      | 0.06        | 10.50       | 0.07       | 28.23 | 56.00      | -27.77     | QP      |
| 10 | 2.500  | 9.74       | 0.08        | 10.50       | 0.13       | 20.45 | 46.00      | -25.55     | Average |
| 11 | 20.270 | 27.10      | 0.34        | 10.50       | 0.19       | 38.13 | 50.00      | -11.87     | Average |
| 12 | 20.270 | 32.87      | 0.34        | 10.50       | 0.19       | 43.90 | 60.00      | -16.10     | QP      |

**Remark:**

1. Level = Read level + LISN Factor + Cable Loss.



### 5.4 Emissions in Restricted Frequency Bands

|                      |                             |                       |                     |
|----------------------|-----------------------------|-----------------------|---------------------|
| <b>Product Name:</b> | Multi Protocol Host Gateway | <b>Product Model:</b> | DSGW-291-X (X:1~18) |
| <b>Test By:</b>      | June                        | <b>Test mode:</b>     | BLE Tx (LE 1M PHY)  |
| <b>Test Channel:</b> | Lowest channel              | <b>Polarization:</b>  | Vertical            |
| <b>Test Voltage:</b> | DC 12V                      |                       |                     |

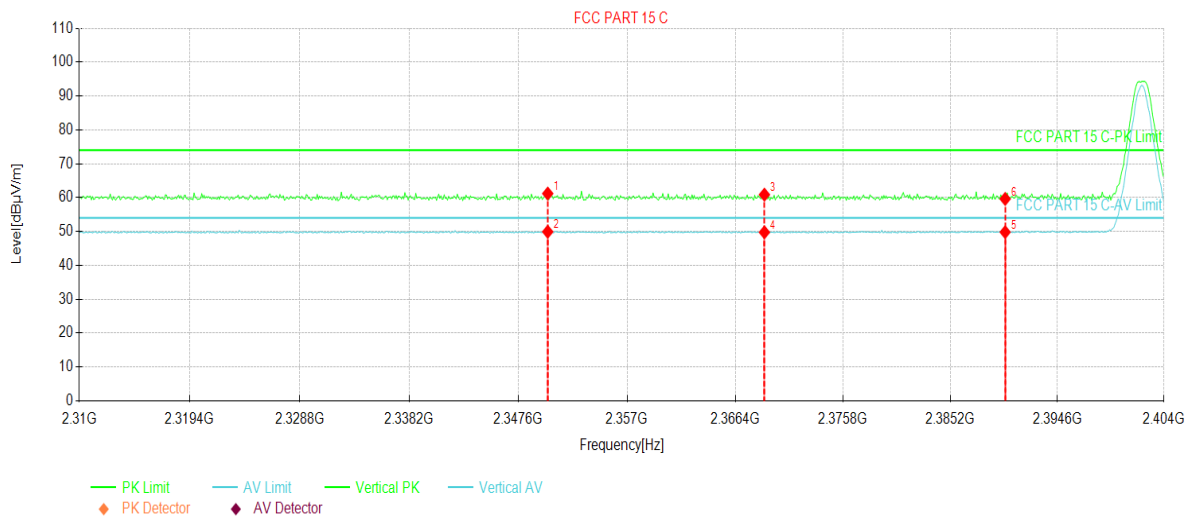

| Suspected Data List |             |                  |             |                |                |             |       |          |
|---------------------|-------------|------------------|-------------|----------------|----------------|-------------|-------|----------|
| NO.                 | Freq. [MHz] | Reading [dBµV/m] | Factor [dB] | Level [dBµV/m] | Limit [dBµV/m] | Margin [dB] | Trace | Polarity |
| 1                   | 2350.13     | 25.90            | 35.30       | 61.20          | 74.00          | 12.80       | PK    | Vertical |
| 2                   | 2350.13     | 14.63            | 35.30       | 49.93          | 54.00          | 4.07        | AV    | Vertical |
| 3                   | 2368.93     | 25.44            | 35.44       | 60.88          | 74.00          | 13.12       | PK    | Vertical |
| 4                   | 2368.93     | 14.32            | 35.44       | 49.76          | 54.00          | 4.24        | AV    | Vertical |
| 5                   | 2390.00     | 14.22            | 35.60       | 49.82          | 54.00          | 4.18        | AV    | Vertical |
| 6                   | 2390.00     | 24.02            | 35.60       | 59.62          | 74.00          | 14.38       | PK    | Vertical |

**Remark:**

1. Level = Reading + Factor(Antenna Factor + Cable Loss – Pre-amplifier Factor).

|                      |                             |                       |                     |
|----------------------|-----------------------------|-----------------------|---------------------|
| <b>Product Name:</b> | Multi Protocol Host Gateway | <b>Product Model:</b> | DSGW-291-X (X:1~18) |
| <b>Test By:</b>      | June                        | <b>Test mode:</b>     | BLE Tx (LE 1M PHY)  |
| <b>Test Channel:</b> | Lowest channel              | <b>Polarization:</b>  | Horizontal          |
| <b>Test Voltage:</b> | DC 12V                      |                       |                     |

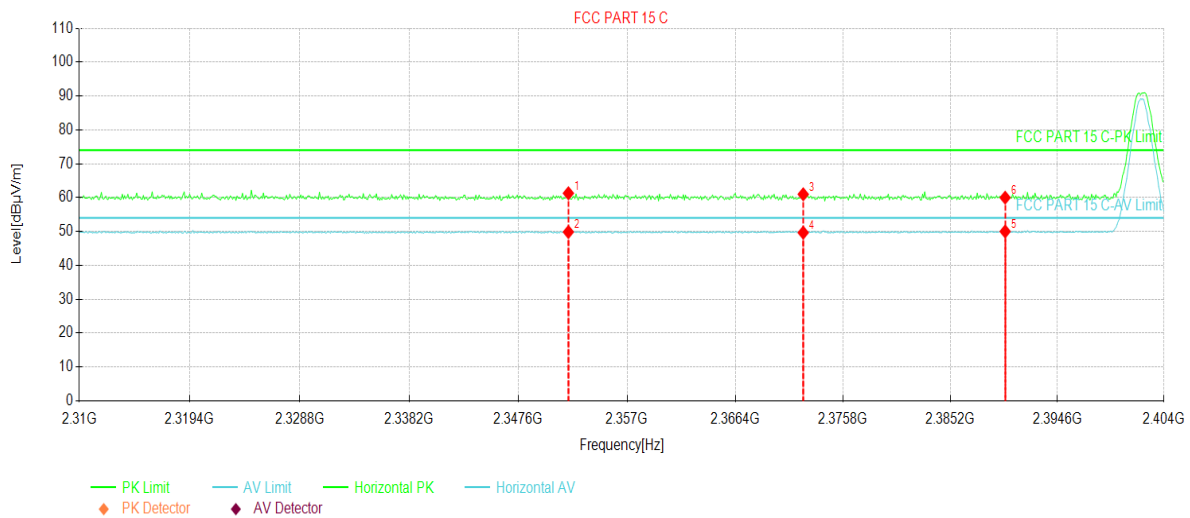

| Suspected Data List |             |                  |             |                |                |             |       |            |
|---------------------|-------------|------------------|-------------|----------------|----------------|-------------|-------|------------|
| NO.                 | Freq. [MHz] | Reading [dBµV/m] | Factor [dB] | Level [dBµV/m] | Limit [dBµV/m] | Margin [dB] | Trace | Polarity   |
| 1                   | 2351.92     | 25.98            | 35.31       | 61.29          | 74.00          | 12.71       | PK    | Horizontal |
| 2                   | 2351.92     | 14.56            | 35.31       | 49.87          | 54.00          | 4.13        | AV    | Horizontal |
| 3                   | 2372.32     | 25.53            | 35.46       | 60.99          | 74.00          | 13.01       | PK    | Horizontal |
| 4                   | 2372.32     | 14.20            | 35.46       | 49.66          | 54.00          | 4.34        | AV    | Horizontal |
| 5                   | 2390.00     | 14.42            | 35.60       | 50.02          | 54.00          | 3.98        | AV    | Horizontal |
| 6                   | 2390.00     | 24.40            | 35.60       | 60.00          | 74.00          | 14.00       | PK    | Horizontal |

**Remark:**

1. Level = Reading + Factor(Antenna Factor + Cable Loss – Preamplifier Factor).



|                      |                             |                       |                     |
|----------------------|-----------------------------|-----------------------|---------------------|
| <b>Product Name:</b> | Multi Protocol Host Gateway | <b>Product Model:</b> | DSGW-291-X (X:1~18) |
| <b>Test By:</b>      | June                        | <b>Test mode:</b>     | BLE Tx (LE 1M PHY)  |
| <b>Test Channel:</b> | Highest channel             | <b>Polarization:</b>  | Vertical            |
| <b>Test Voltage:</b> | DC 12V                      |                       |                     |

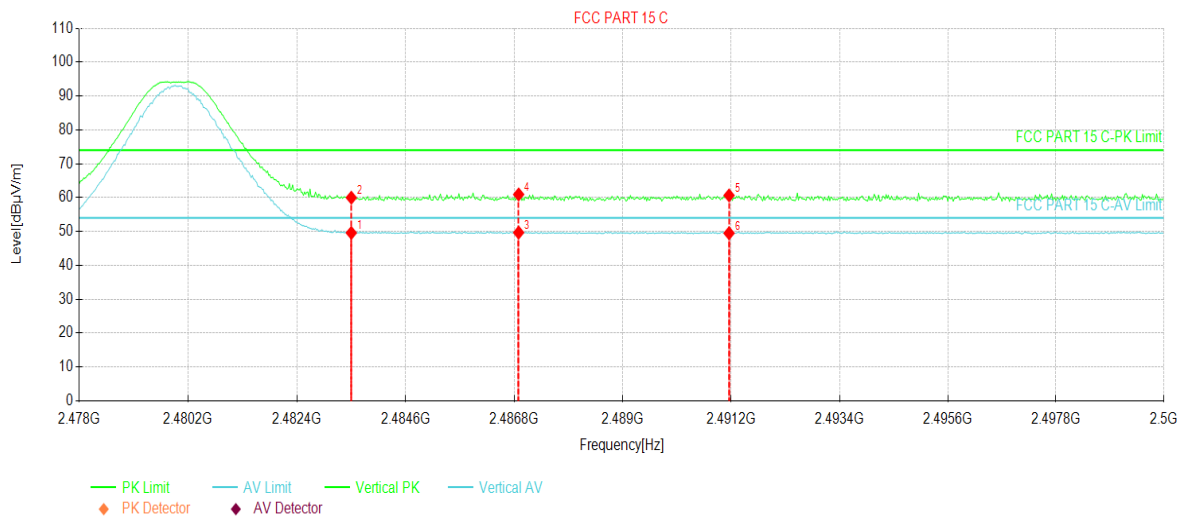

| Suspected Data List |             |                  |             |                |                |             |       |          |
|---------------------|-------------|------------------|-------------|----------------|----------------|-------------|-------|----------|
| NO.                 | Freq. [MHz] | Reading [dBµV/m] | Factor [dB] | Level [dBµV/m] | Limit [dBµV/m] | Margin [dB] | Trace | Polarity |
| 1                   | 2483.50     | 14.08            | 35.51       | 49.59          | 54.00          | 4.41        | AV    | Vertical |
| 2                   | 2483.50     | 24.48            | 35.51       | 59.99          | 74.00          | 14.01       | PK    | Vertical |
| 3                   | 2486.88     | 14.18            | 35.50       | 49.68          | 54.00          | 4.32        | AV    | Vertical |
| 4                   | 2486.88     | 25.44            | 35.50       | 60.94          | 74.00          | 13.06       | PK    | Vertical |
| 5                   | 2491.15     | 25.17            | 35.50       | 60.67          | 74.00          | 13.33       | PK    | Vertical |
| 6                   | 2491.15     | 13.99            | 35.50       | 49.49          | 54.00          | 4.51        | AV    | Vertical |

**Remark:**

1. Level = Reading + Factor(Antenna Factor + Cable Loss – Pre-amplifier Factor).

|                      |                             |                       |                     |
|----------------------|-----------------------------|-----------------------|---------------------|
| <b>Product Name:</b> | Multi Protocol Host Gateway | <b>Product Model:</b> | DSGW-291-X (X:1~18) |
| <b>Test By:</b>      | June                        | <b>Test mode:</b>     | BLE Tx (LE 1M PHY)  |
| <b>Test Channel:</b> | Highest channel             | <b>Polarization:</b>  | Horizontal          |
| <b>Test Voltage:</b> | DC 12V                      |                       |                     |

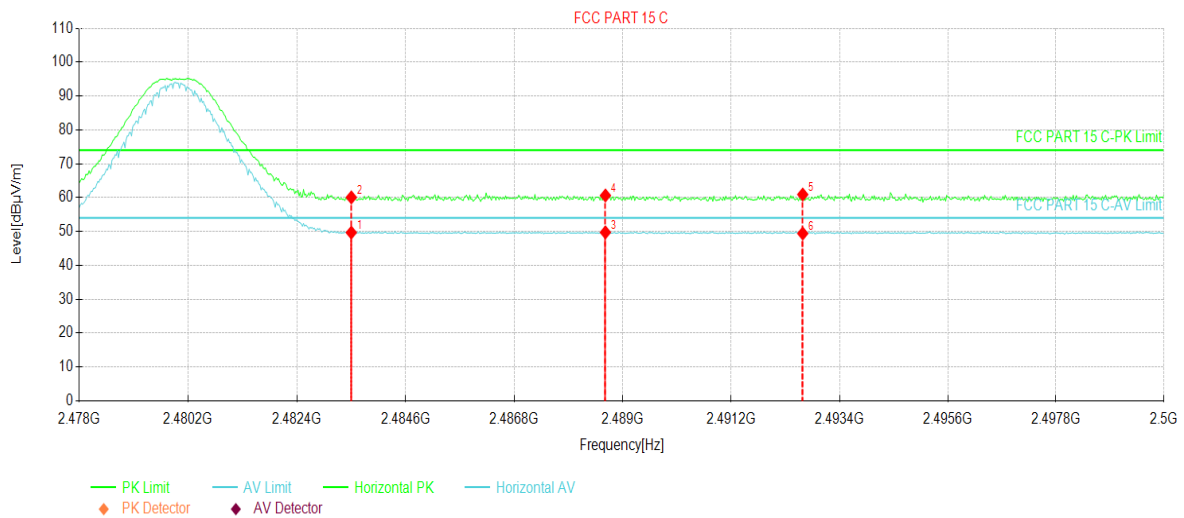

**Suspected Data List**

| NO. | Freq. [MHz] | Reading [dBµV/m] | Factor [dB] | Level [dBµV/m] | Limit [dBµV/m] | Margin [dB] | Trace | Polarity   |
|-----|-------------|------------------|-------------|----------------|----------------|-------------|-------|------------|
| 1   | 2483.50     | 14.18            | 35.51       | 49.69          | 54.00          | 4.31        | AV    | Horizontal |
| 2   | 2483.50     | 24.56            | 35.51       | 60.07          | 74.00          | 13.93       | PK    | Horizontal |
| 3   | 2488.64     | 14.25            | 35.50       | 49.75          | 54.00          | 4.25        | AV    | Horizontal |
| 4   | 2488.64     | 25.14            | 35.50       | 60.64          | 74.00          | 13.36       | PK    | Horizontal |
| 5   | 2492.65     | 25.43            | 35.49       | 60.92          | 74.00          | 13.08       | PK    | Horizontal |
| 6   | 2492.65     | 13.93            | 35.49       | 49.42          | 54.00          | 4.58        | AV    | Horizontal |

**Remark:**

1. Level = Reading + Factor(Antenna Factor + Cable Loss – Preamplifier Factor).

|                      |                             |                       |                     |
|----------------------|-----------------------------|-----------------------|---------------------|
| <b>Product Name:</b> | Multi Protocol Host Gateway | <b>Product Model:</b> | DSGW-291-X (X:1~18) |
| <b>Test By:</b>      | June                        | <b>Test mode:</b>     | BLE Tx (LE 2M PHY)  |
| <b>Test Channel:</b> | Lowest channel              | <b>Polarization:</b>  | Vertical            |
| <b>Test Voltage:</b> | DC 12V                      |                       |                     |

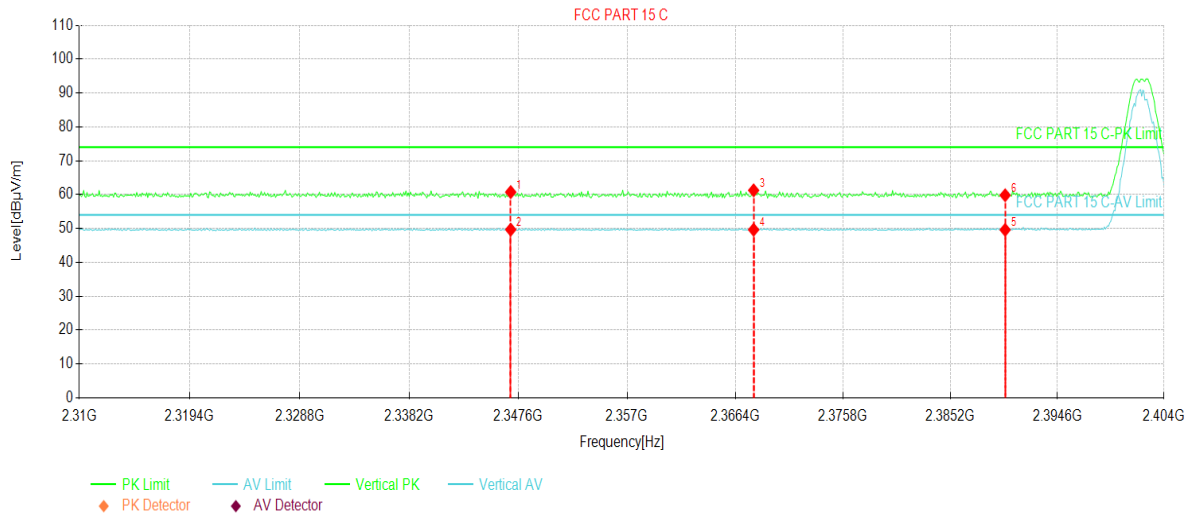

| Suspected Data List |             |                  |             |                |                |             |       |          |
|---------------------|-------------|------------------|-------------|----------------|----------------|-------------|-------|----------|
| NO.                 | Freq. [MHz] | Reading [dBµV/m] | Factor [dB] | Level [dBµV/m] | Limit [dBµV/m] | Margin [dB] | Trace | Polarity |
| 1                   | 2346.94     | 25.48            | 35.27       | 60.75          | 74.00          | 13.25       | PK    | Vertical |
| 2                   | 2346.94     | 14.41            | 35.27       | 49.68          | 54.00          | 4.32        | AV    | Vertical |
| 3                   | 2367.99     | 25.84            | 35.43       | 61.27          | 74.00          | 12.73       | PK    | Vertical |
| 4                   | 2367.99     | 14.21            | 35.43       | 49.64          | 54.00          | 4.36        | AV    | Vertical |
| 5                   | 2390.00     | 14.01            | 35.60       | 49.61          | 54.00          | 4.39        | AV    | Vertical |
| 6                   | 2390.00     | 24.22            | 35.60       | 59.82          | 74.00          | 14.18       | PK    | Vertical |

**Remark:**

1. Level = Reading + Factor(Antenna Factor + Cable Loss – Pre-amplifier Factor).

|                      |                             |                       |                     |
|----------------------|-----------------------------|-----------------------|---------------------|
| <b>Product Name:</b> | Multi Protocol Host Gateway | <b>Product Model:</b> | DSGW-291-X (X:1~18) |
| <b>Test By:</b>      | June                        | <b>Test mode:</b>     | BLE Tx (LE 2M PHY)  |
| <b>Test Channel:</b> | Lowest channel              | <b>Polarization:</b>  | Horizontal          |
| <b>Test Voltage:</b> | DC 12V                      |                       |                     |

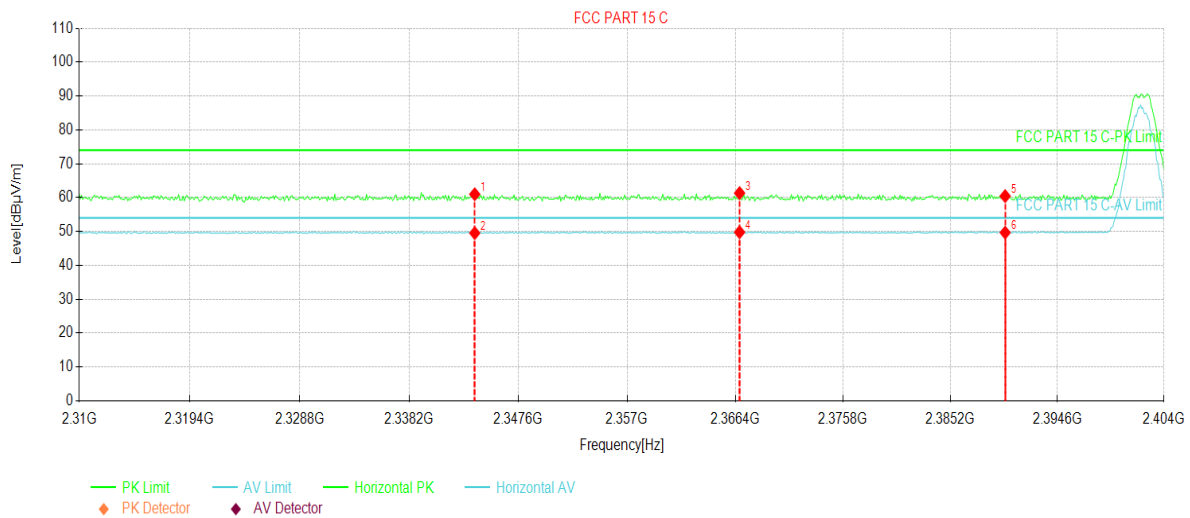

| Suspected Data List |             |                  |             |                |                |             |       |            |
|---------------------|-------------|------------------|-------------|----------------|----------------|-------------|-------|------------|
| NO.                 | Freq. [MHz] | Reading [dBµV/m] | Factor [dB] | Level [dBµV/m] | Limit [dBµV/m] | Margin [dB] | Trace | Polarity   |
| 1                   | 2343.84     | 25.75            | 35.25       | 61.00          | 74.00          | 13.00       | PK    | Horizontal |
| 2                   | 2343.84     | 14.28            | 35.25       | 49.53          | 54.00          | 4.47        | AV    | Horizontal |
| 3                   | 2366.77     | 25.92            | 35.42       | 61.34          | 74.00          | 12.66       | PK    | Horizontal |
| 4                   | 2366.77     | 14.38            | 35.42       | 49.80          | 54.00          | 4.20        | AV    | Horizontal |
| 5                   | 2390.00     | 24.84            | 35.60       | 60.44          | 74.00          | 13.56       | PK    | Horizontal |
| 6                   | 2390.00     | 14.07            | 35.60       | 49.67          | 54.00          | 4.33        | AV    | Horizontal |

**Remark:**

1. Level = Reading + Factor(Antenna Factor + Cable Loss – Pre-amplifier Factor).

|                      |                             |                       |                     |
|----------------------|-----------------------------|-----------------------|---------------------|
| <b>Product Name:</b> | Multi Protocol Host Gateway | <b>Product Model:</b> | DSGW-291-X (X:1~18) |
| <b>Test By:</b>      | June                        | <b>Test mode:</b>     | BLE Tx (LE 2M PHY)  |
| <b>Test Channel:</b> | Highest channel             | <b>Polarization:</b>  | Vertical            |
| <b>Test Voltage:</b> | DC 12V                      |                       |                     |

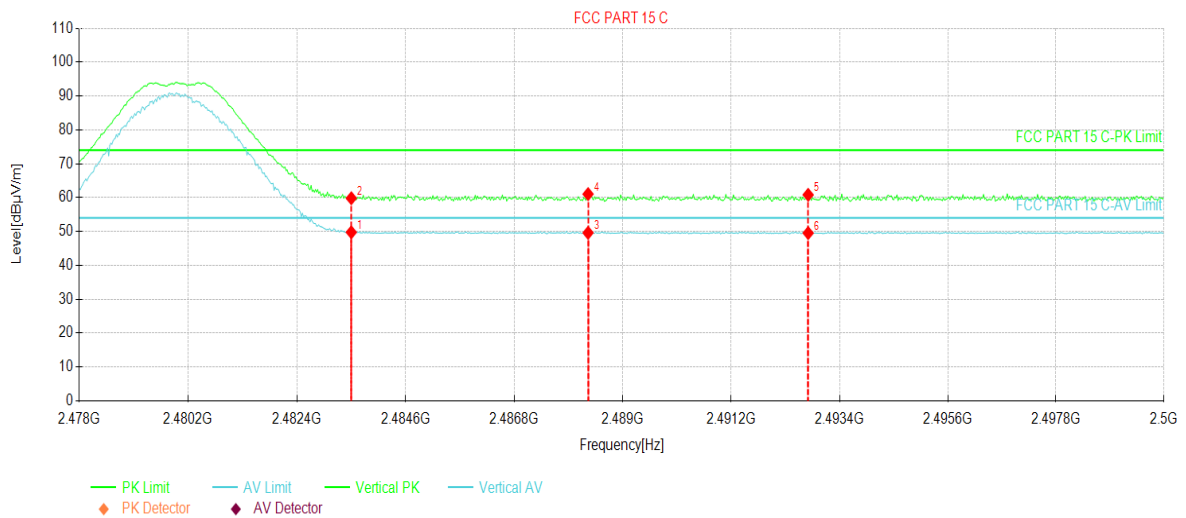

**Suspected Data List**

| NO. | Freq. [MHz] | Reading [dBµV/m] | Factor [dB] | Level [dBµV/m] | Limit [dBµV/m] | Margin [dB] | Trace | Polarity |
|-----|-------------|------------------|-------------|----------------|----------------|-------------|-------|----------|
| 1   | 2483.50     | 14.26            | 35.51       | 49.77          | 54.00          | 4.23        | AV    | Vertical |
| 2   | 2483.50     | 24.31            | 35.51       | 59.82          | 74.00          | 14.18       | PK    | Vertical |
| 3   | 2488.29     | 14.12            | 35.50       | 49.62          | 54.00          | 4.38        | AV    | Vertical |
| 4   | 2488.29     | 25.55            | 35.50       | 61.05          | 74.00          | 12.95       | PK    | Vertical |
| 5   | 2492.76     | 25.34            | 35.49       | 60.83          | 74.00          | 13.17       | PK    | Vertical |
| 6   | 2492.76     | 14.05            | 35.49       | 49.54          | 54.00          | 4.46        | AV    | Vertical |

**Remark:**

1. Level = Reading + Factor(Antenna Factor + Cable Loss – Pre-amplifier Factor).

|                      |                             |                       |                     |
|----------------------|-----------------------------|-----------------------|---------------------|
| <b>Product Name:</b> | Multi Protocol Host Gateway | <b>Product Model:</b> | DSGW-291-X (X:1~18) |
| <b>Test By:</b>      | June                        | <b>Test mode:</b>     | BLE Tx (LE 2M PHY)  |
| <b>Test Channel:</b> | Highest channel             | <b>Polarization:</b>  | Horizontal          |
| <b>Test Voltage:</b> | DC 12V                      |                       |                     |

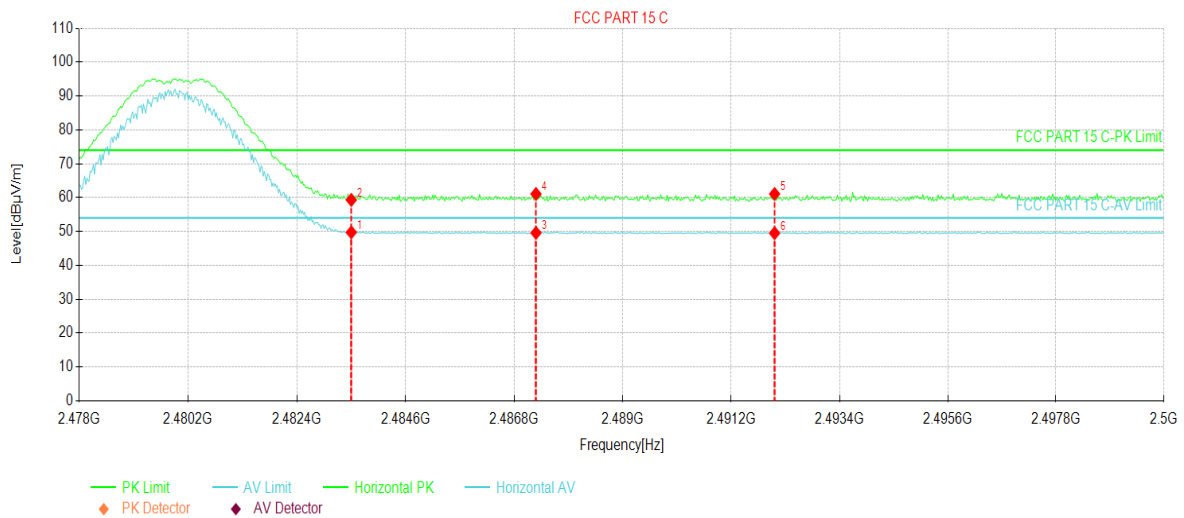

| Suspected Data List |             |                  |             |                |                |             |       |            |
|---------------------|-------------|------------------|-------------|----------------|----------------|-------------|-------|------------|
| NO.                 | Freq. [MHz] | Reading [dBµV/m] | Factor [dB] | Level [dBµV/m] | Limit [dBµV/m] | Margin [dB] | Trace | Polarity   |
| 1                   | 2483.50     | 14.25            | 35.51       | 49.76          | 54.00          | 4.24        | AV    | Horizontal |
| 2                   | 2483.50     | 23.82            | 35.51       | 59.33          | 74.00          | 14.67       | PK    | Horizontal |
| 3                   | 2487.24     | 14.09            | 35.50       | 49.59          | 54.00          | 4.41        | AV    | Horizontal |
| 4                   | 2487.24     | 25.58            | 35.50       | 61.08          | 74.00          | 12.92       | PK    | Horizontal |
| 5                   | 2492.08     | 25.58            | 35.50       | 61.08          | 74.00          | 12.92       | PK    | Horizontal |
| 6                   | 2492.08     | 14.00            | 35.50       | 49.50          | 54.00          | 4.50        | AV    | Horizontal |

**Remark:**

1. Level = Reading + Factor(Antenna Factor + Cable Loss – Preamplifier Factor).

|                      |                             |                       |                            |
|----------------------|-----------------------------|-----------------------|----------------------------|
| <b>Product Name:</b> | Multi Protocol Host Gateway | <b>Product Model:</b> | DSGW-291-X (X:1~18)        |
| <b>Test By:</b>      | June                        | <b>Test mode:</b>     | BLE Tx (LE Coded PHY, S=2) |
| <b>Test Channel:</b> | Lowest channel              | <b>Polarization:</b>  | Vertical                   |
| <b>Test Voltage:</b> | DC 12V                      |                       |                            |

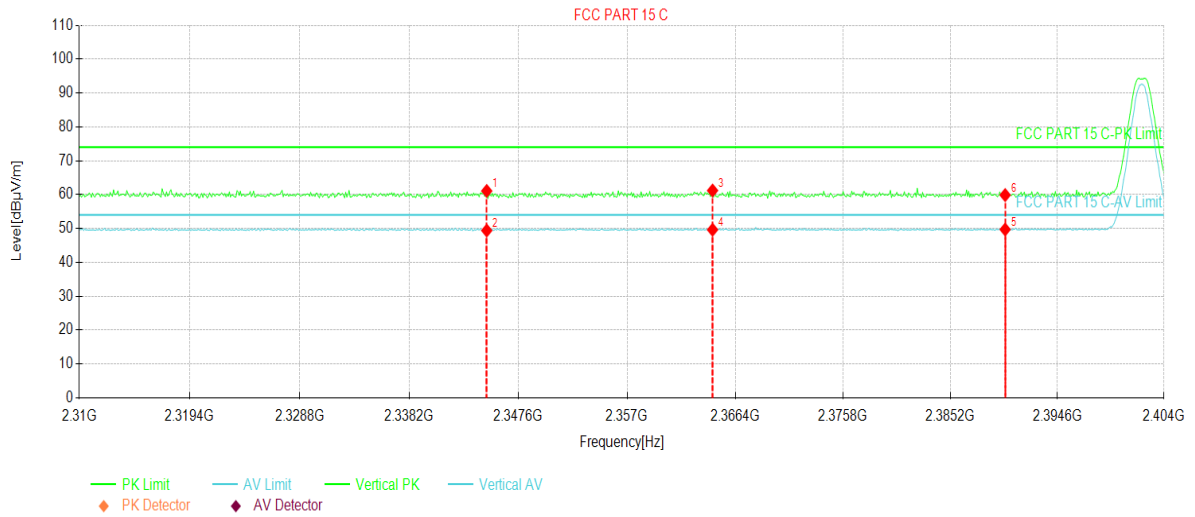

| Suspected Data List |             |                  |             |                |                |             |       |          |
|---------------------|-------------|------------------|-------------|----------------|----------------|-------------|-------|----------|
| NO.                 | Freq. [MHz] | Reading [dBµV/m] | Factor [dB] | Level [dBµV/m] | Limit [dBµV/m] | Margin [dB] | Trace | Polarity |
| 1                   | 2344.87     | 25.84            | 35.26       | 61.10          | 74.00          | 12.90       | PK    | Vertical |
| 2                   | 2344.87     | 14.14            | 35.26       | 49.40          | 54.00          | 4.60        | AV    | Vertical |
| 3                   | 2364.42     | 25.81            | 35.40       | 61.21          | 74.00          | 12.79       | PK    | Vertical |
| 4                   | 2364.42     | 14.23            | 35.40       | 49.63          | 54.00          | 4.37        | AV    | Vertical |
| 5                   | 2390.00     | 14.11            | 35.60       | 49.71          | 54.00          | 4.29        | AV    | Vertical |
| 6                   | 2390.00     | 24.27            | 35.60       | 59.87          | 74.00          | 14.13       | PK    | Vertical |

**Remark:**

1. Level = Reading + Factor(Antenna Factor + Cable Loss – Preamplifier Factor).

|                      |                             |                       |                            |
|----------------------|-----------------------------|-----------------------|----------------------------|
| <b>Product Name:</b> | Multi Protocol Host Gateway | <b>Product Model:</b> | DSGW-291-X (X:1~18)        |
| <b>Test By:</b>      | June                        | <b>Test mode:</b>     | BLE Tx (LE Coded PHY, S=2) |
| <b>Test Channel:</b> | Lowest channel              | <b>Polarization:</b>  | Horizontal                 |
| <b>Test Voltage:</b> | DC 12V                      |                       |                            |

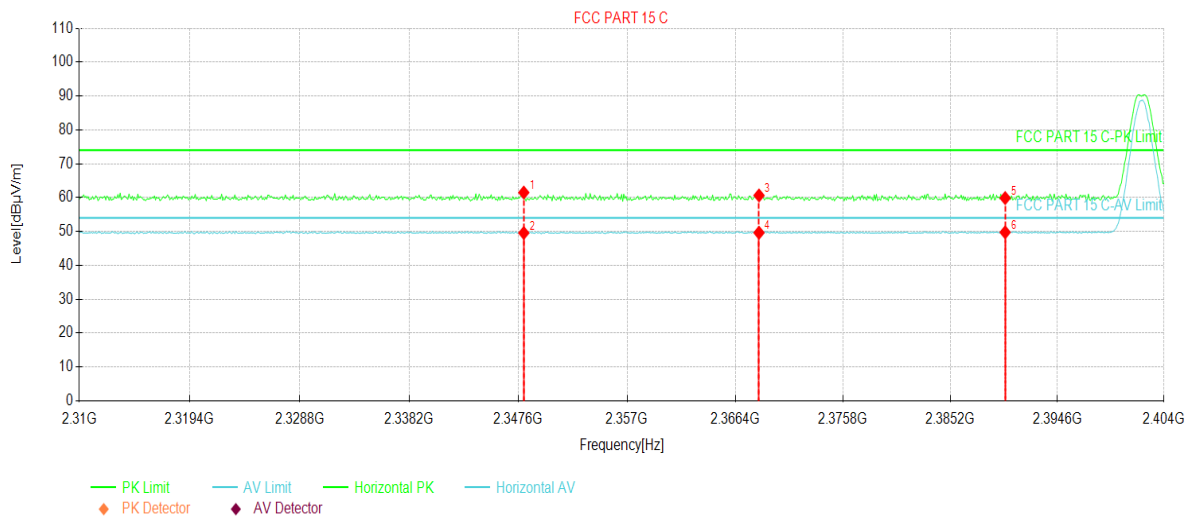

| Suspected Data List |             |                  |             |                |                |             |       |            |
|---------------------|-------------|------------------|-------------|----------------|----------------|-------------|-------|------------|
| NO.                 | Freq. [MHz] | Reading [dBµV/m] | Factor [dB] | Level [dBµV/m] | Limit [dBµV/m] | Margin [dB] | Trace | Polarity   |
| 1                   | 2348.07     | 26.22            | 35.28       | 61.50          | 74.00          | 12.50       | PK    | Horizontal |
| 2                   | 2348.07     | 14.28            | 35.28       | 49.56          | 54.00          | 4.44        | AV    | Horizontal |
| 3                   | 2368.46     | 25.22            | 35.43       | 60.65          | 74.00          | 13.35       | PK    | Horizontal |
| 4                   | 2368.46     | 14.21            | 35.43       | 49.64          | 54.00          | 4.36        | AV    | Horizontal |
| 5                   | 2390.00     | 24.27            | 35.60       | 59.87          | 74.00          | 14.13       | PK    | Horizontal |
| 6                   | 2390.00     | 14.16            | 35.60       | 49.76          | 54.00          | 4.24        | AV    | Horizontal |

**Remark:**

1. Level = Reading + Factor(Antenna Factor + Cable Loss – Preamplifier Factor).



|                      |                             |                       |                            |
|----------------------|-----------------------------|-----------------------|----------------------------|
| <b>Product Name:</b> | Multi Protocol Host Gateway | <b>Product Model:</b> | DSGW-291-X (X:1~18)        |
| <b>Test By:</b>      | June                        | <b>Test mode:</b>     | BLE Tx (LE Coded PHY, S=2) |
| <b>Test Channel:</b> | Highest channel             | <b>Polarization:</b>  | Vertical                   |
| <b>Test Voltage:</b> | DC 12V                      |                       |                            |

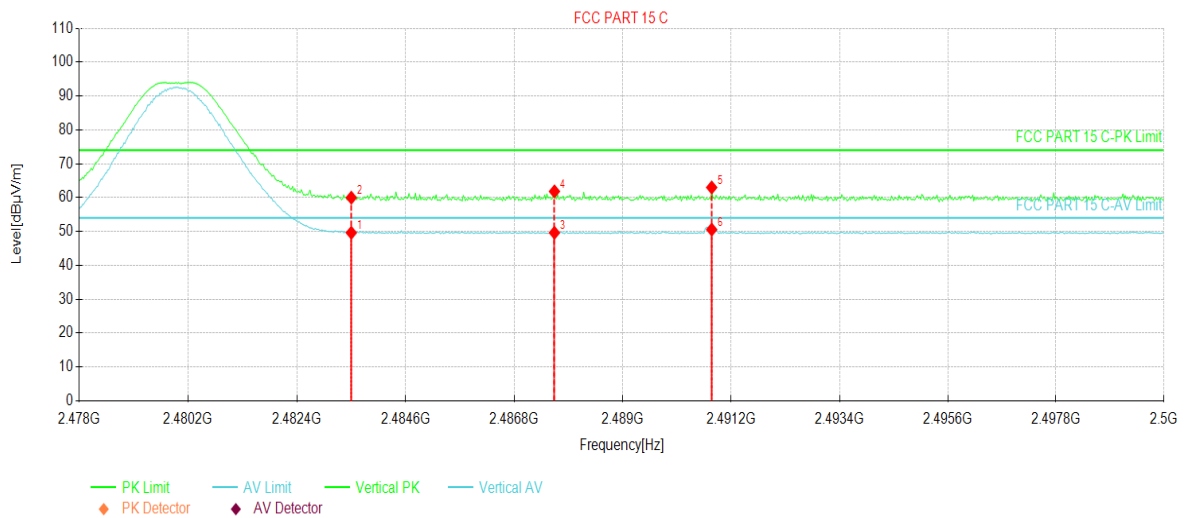

**Suspected Data List**

| NO. | Freq. [MHz] | Reading [dBµV/m] | Factor [dB] | Level [dBµV/m] | Limit [dBµV/m] | Margin [dB] | Trace | Polarity |
|-----|-------------|------------------|-------------|----------------|----------------|-------------|-------|----------|
| 1   | 2483.50     | 14.12            | 35.51       | 49.63          | 54.00          | 4.37        | AV    | Vertical |
| 2   | 2483.50     | 24.48            | 35.51       | 59.99          | 74.00          | 14.01       | PK    | Vertical |
| 3   | 2487.61     | 14.13            | 35.50       | 49.63          | 54.00          | 4.37        | AV    | Vertical |
| 4   | 2487.61     | 26.34            | 35.50       | 61.84          | 74.00          | 12.16       | PK    | Vertical |
| 5   | 2490.80     | 27.50            | 35.50       | 63.00          | 74.00          | 11.00       | PK    | Vertical |
| 6   | 2490.80     | 15.07            | 35.50       | 50.57          | 54.00          | 3.43        | AV    | Vertical |

**Remark:**

1. Level = Reading + Factor(Antenna Factor + Cable Loss – Pre-amplifier Factor).

|                      |                             |                       |                            |
|----------------------|-----------------------------|-----------------------|----------------------------|
| <b>Product Name:</b> | Multi Protocol Host Gateway | <b>Product Model:</b> | DSGW-291-X (X:1~18)        |
| <b>Test By:</b>      | June                        | <b>Test mode:</b>     | BLE Tx (LE Coded PHY, S=2) |
| <b>Test Channel:</b> | Highest channel             | <b>Polarization:</b>  | Horizontal                 |
| <b>Test Voltage:</b> | DC 12V                      |                       |                            |

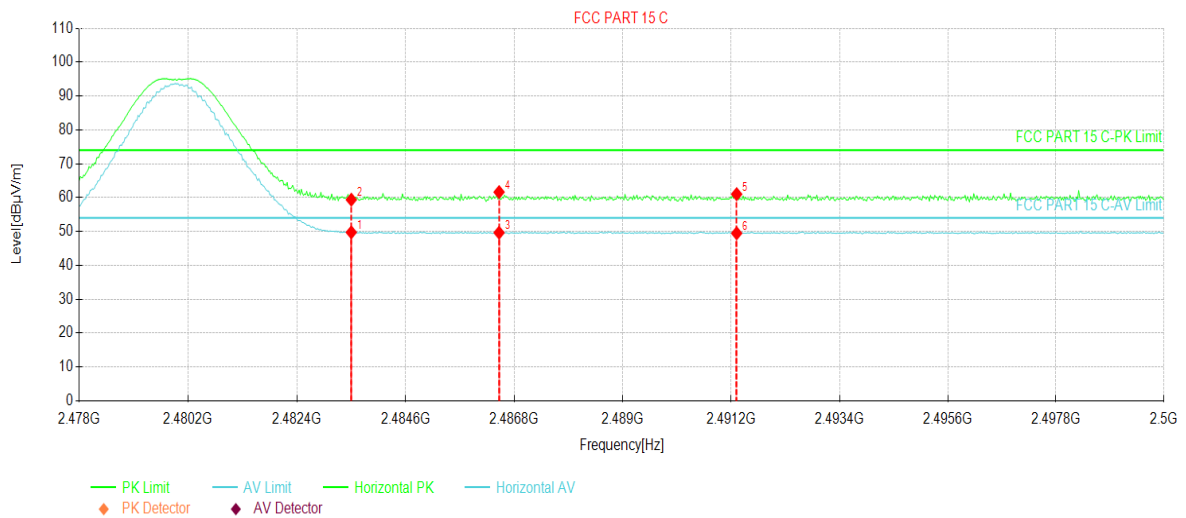

| Suspected Data List |             |                  |             |                |                |             |       |            |
|---------------------|-------------|------------------|-------------|----------------|----------------|-------------|-------|------------|
| NO.                 | Freq. [MHz] | Reading [dBµV/m] | Factor [dB] | Level [dBµV/m] | Limit [dBµV/m] | Margin [dB] | Trace | Polarity   |
| 1                   | 2483.50     | 14.25            | 35.51       | 49.76          | 54.00          | 4.24        | AV    | Horizontal |
| 2                   | 2483.50     | 23.89            | 35.51       | 59.40          | 74.00          | 14.60       | PK    | Horizontal |
| 3                   | 2486.49     | 14.14            | 35.51       | 49.65          | 54.00          | 4.35        | AV    | Horizontal |
| 4                   | 2486.49     | 26.13            | 35.51       | 61.64          | 74.00          | 12.36       | PK    | Horizontal |
| 5                   | 2491.31     | 25.52            | 35.50       | 61.02          | 74.00          | 12.98       | PK    | Horizontal |
| 6                   | 2491.31     | 13.98            | 35.50       | 49.48          | 54.00          | 4.52        | AV    | Horizontal |

**Remark:**

1. Level = Reading + Factor(Antenna Factor + Cable Loss – Pre-amplifier Factor).

|                      |                             |                       |                            |
|----------------------|-----------------------------|-----------------------|----------------------------|
| <b>Product Name:</b> | Multi Protocol Host Gateway | <b>Product Model:</b> | DSGW-291-X (X:1~18)        |
| <b>Test By:</b>      | June                        | <b>Test mode:</b>     | BLE Tx (LE Coded PHY, S=8) |
| <b>Test Channel:</b> | Lowest channel              | <b>Polarization:</b>  | Vertical                   |
| <b>Test Voltage:</b> | DC 12V                      |                       |                            |

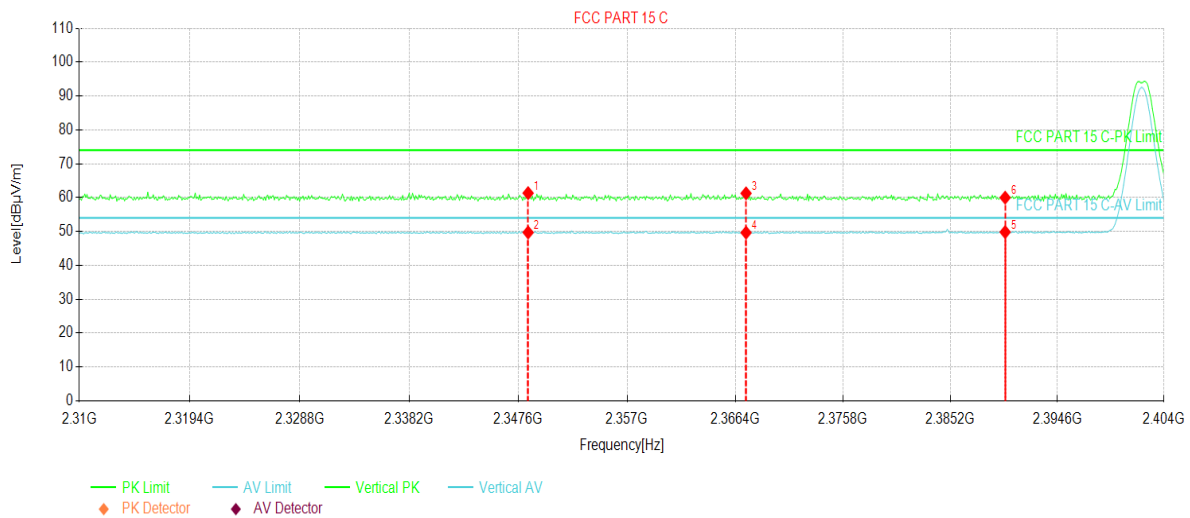

| Suspected Data List |             |                  |             |                |                |             |       |          |
|---------------------|-------------|------------------|-------------|----------------|----------------|-------------|-------|----------|
| NO.                 | Freq. [MHz] | Reading [dBµV/m] | Factor [dB] | Level [dBµV/m] | Limit [dBµV/m] | Margin [dB] | Trace | Polarity |
| 1                   | 2348.44     | 26.05            | 35.28       | 61.33          | 74.00          | 12.67       | PK    | Vertical |
| 2                   | 2348.44     | 14.44            | 35.28       | 49.72          | 54.00          | 4.28        | AV    | Vertical |
| 3                   | 2367.34     | 25.85            | 35.43       | 61.28          | 74.00          | 12.72       | PK    | Vertical |
| 4                   | 2367.34     | 14.22            | 35.43       | 49.65          | 54.00          | 4.35        | AV    | Vertical |
| 5                   | 2390.00     | 14.24            | 35.60       | 49.84          | 54.00          | 4.16        | AV    | Vertical |
| 6                   | 2390.00     | 24.40            | 35.60       | 60.00          | 74.00          | 14.00       | PK    | Vertical |

**Remark:**

1. Level = Reading + Factor(Antenna Factor + Cable Loss – Preamplifier Factor).

|                      |                             |                       |                            |
|----------------------|-----------------------------|-----------------------|----------------------------|
| <b>Product Name:</b> | Multi Protocol Host Gateway | <b>Product Model:</b> | DSGW-291-X (X:1~18)        |
| <b>Test By:</b>      | June                        | <b>Test mode:</b>     | BLE Tx (LE Coded PHY, S=8) |
| <b>Test Channel:</b> | Lowest channel              | <b>Polarization:</b>  | Horizontal                 |
| <b>Test Voltage:</b> | DC 12V                      |                       |                            |

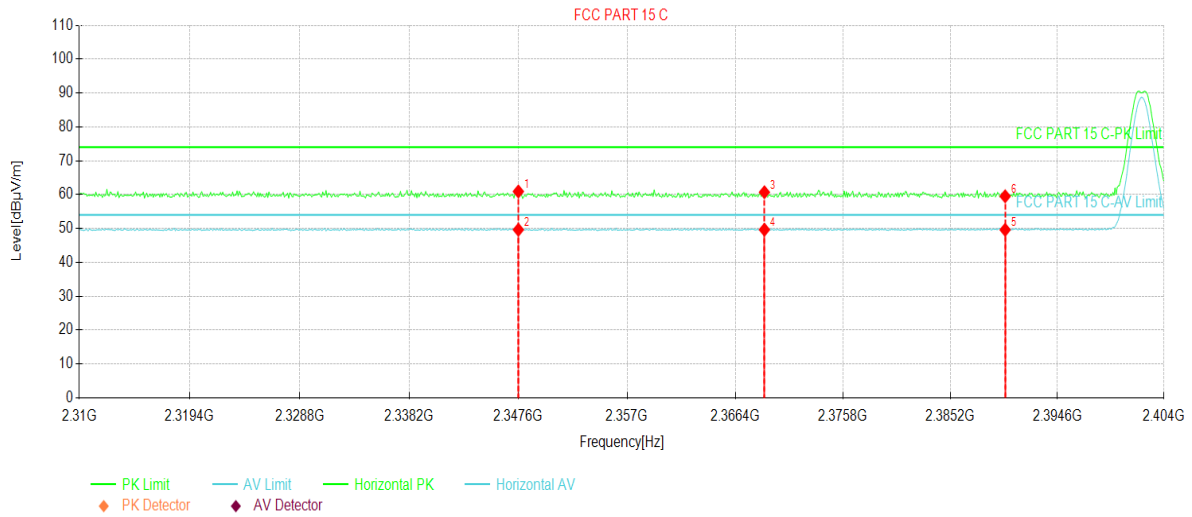

| Suspected Data List |             |                  |             |                |                |             |       |            |
|---------------------|-------------|------------------|-------------|----------------|----------------|-------------|-------|------------|
| NO.                 | Freq. [MHz] | Reading [dBµV/m] | Factor [dB] | Level [dBµV/m] | Limit [dBµV/m] | Margin [dB] | Trace | Polarity   |
| 1                   | 2347.60     | 25.65            | 35.28       | 60.93          | 74.00          | 13.07       | PK    | Horizontal |
| 2                   | 2347.60     | 14.36            | 35.28       | 49.64          | 54.00          | 4.36        | AV    | Horizontal |
| 3                   | 2368.93     | 25.27            | 35.44       | 60.71          | 74.00          | 13.29       | PK    | Horizontal |
| 4                   | 2368.93     | 14.22            | 35.44       | 49.66          | 54.00          | 4.34        | AV    | Horizontal |
| 5                   | 2390.00     | 14.02            | 35.60       | 49.62          | 54.00          | 4.38        | AV    | Horizontal |
| 6                   | 2390.00     | 23.91            | 35.60       | 59.51          | 74.00          | 14.49       | PK    | Horizontal |

**Remark:**

1. Level = Reading + Factor(Antenna Factor + Cable Loss – Pre-amplifier Factor).

|                      |                             |                       |                            |
|----------------------|-----------------------------|-----------------------|----------------------------|
| <b>Product Name:</b> | Multi Protocol Host Gateway | <b>Product Model:</b> | DSGW-291-X (X:1~18)        |
| <b>Test By:</b>      | June                        | <b>Test mode:</b>     | BLE Tx (LE Coded PHY, S=8) |
| <b>Test Channel:</b> | Highest channel             | <b>Polarization:</b>  | Vertical                   |
| <b>Test Voltage:</b> | DC 12V                      |                       |                            |

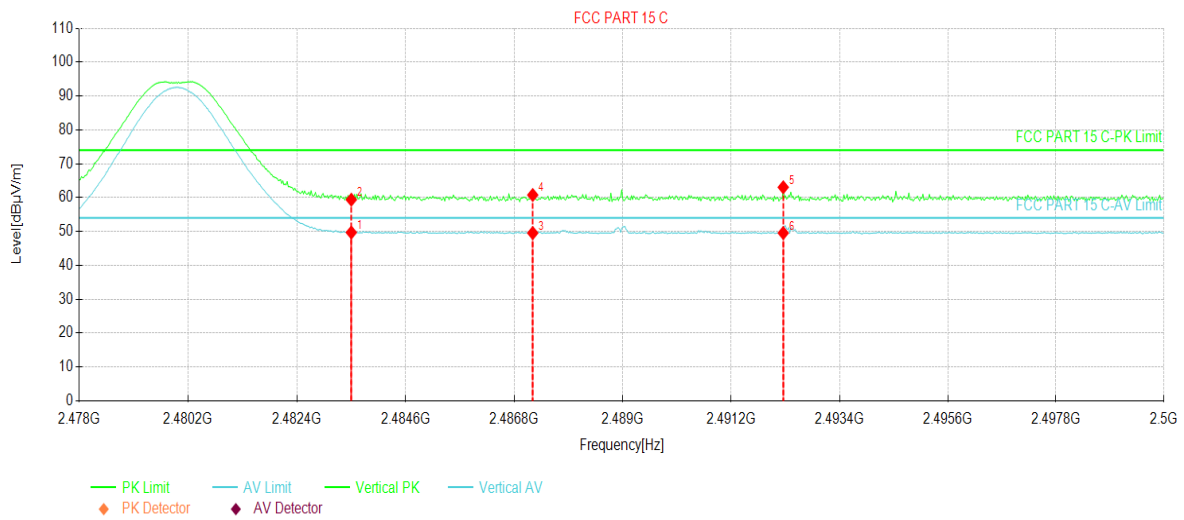

| Suspected Data List |             |                  |             |                |                |             |       |          |
|---------------------|-------------|------------------|-------------|----------------|----------------|-------------|-------|----------|
| NO.                 | Freq. [MHz] | Reading [dBµV/m] | Factor [dB] | Level [dBµV/m] | Limit [dBµV/m] | Margin [dB] | Trace | Polarity |
| 1                   | 2483.50     | 14.20            | 35.51       | 49.71          | 54.00          | 4.29        | AV    | Vertical |
| 2                   | 2483.50     | 23.89            | 35.51       | 59.40          | 74.00          | 14.60       | PK    | Vertical |
| 3                   | 2487.17     | 14.05            | 35.50       | 49.55          | 54.00          | 4.45        | AV    | Vertical |
| 4                   | 2487.17     | 25.29            | 35.50       | 60.79          | 74.00          | 13.21       | PK    | Vertical |
| 5                   | 2492.25     | 27.57            | 35.49       | 63.06          | 74.00          | 10.94       | PK    | Vertical |
| 6                   | 2492.25     | 14.07            | 35.49       | 49.56          | 54.00          | 4.44        | AV    | Vertical |

**Remark:**

1. Level = Reading + Factor(Antenna Factor + Cable Loss – Pre-amplifier Factor).

|                      |                             |                       |                            |
|----------------------|-----------------------------|-----------------------|----------------------------|
| <b>Product Name:</b> | Multi Protocol Host Gateway | <b>Product Model:</b> | DSGW-291-X (X:1~18)        |
| <b>Test By:</b>      | June                        | <b>Test mode:</b>     | BLE Tx (LE Coded PHY, S=8) |
| <b>Test Channel:</b> | Highest channel             | <b>Polarization:</b>  | Horizontal                 |
| <b>Test Voltage:</b> | DC 12V                      |                       |                            |

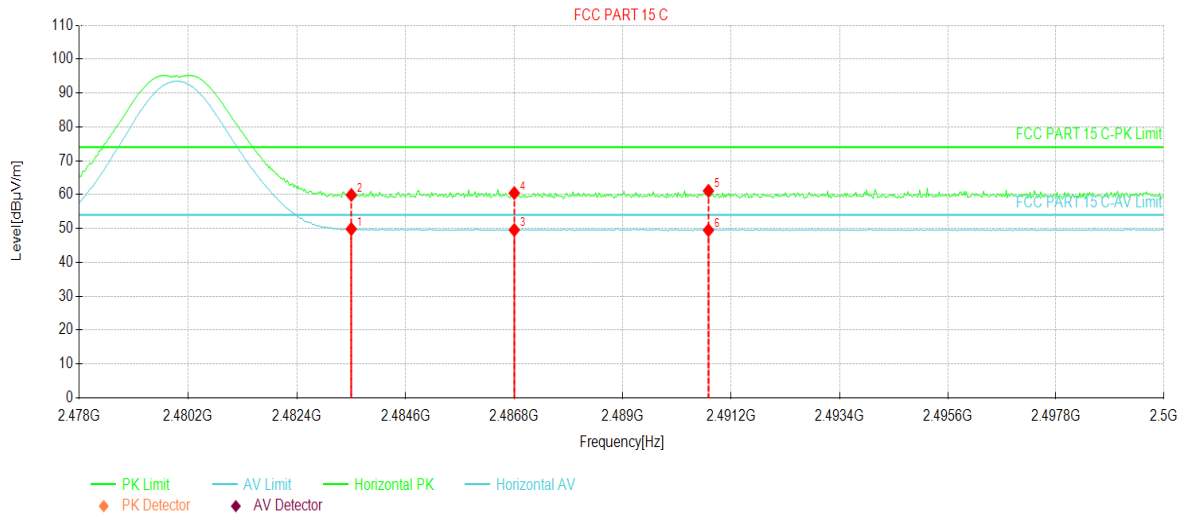

| Suspected Data List |             |                  |             |                |                |             |       |            |
|---------------------|-------------|------------------|-------------|----------------|----------------|-------------|-------|------------|
| NO.                 | Freq. [MHz] | Reading [dBµV/m] | Factor [dB] | Level [dBµV/m] | Limit [dBµV/m] | Margin [dB] | Trace | Polarity   |
| 1                   | 2483.50     | 14.33            | 35.51       | 49.84          | 54.00          | 4.16        | AV    | Horizontal |
| 2                   | 2483.50     | 24.39            | 35.51       | 59.90          | 74.00          | 14.10       | PK    | Horizontal |
| 3                   | 2486.80     | 14.06            | 35.51       | 49.57          | 54.00          | 4.43        | AV    | Horizontal |
| 4                   | 2486.80     | 24.96            | 35.51       | 60.47          | 74.00          | 13.53       | PK    | Horizontal |
| 5                   | 2490.73     | 25.62            | 35.50       | 61.12          | 74.00          | 12.88       | PK    | Horizontal |
| 6                   | 2490.73     | 13.99            | 35.50       | 49.49          | 54.00          | 4.51        | AV    | Horizontal |

**Remark:**

1. Level = Reading + Factor(Antenna Factor + Cable Loss – Preamplifier Factor).

## 5.5 Emissions in Non-restricted Frequency Bands

Below 1GHz:

|                        |                             |                       |                     |
|------------------------|-----------------------------|-----------------------|---------------------|
| <b>Product Name:</b>   | Multi Protocol Host Gateway | <b>Product Model:</b> | DSGW-291-X (X:1~18) |
| <b>Test By:</b>        | June                        | <b>Test mode:</b>     | BLE Tx (LE 1M PHY)  |
| <b>Test Frequency:</b> | 30 MHz ~ 1 GHz              | <b>Polarization:</b>  | Vertical            |
| <b>Test Voltage:</b>   | DC 12V                      |                       |                     |

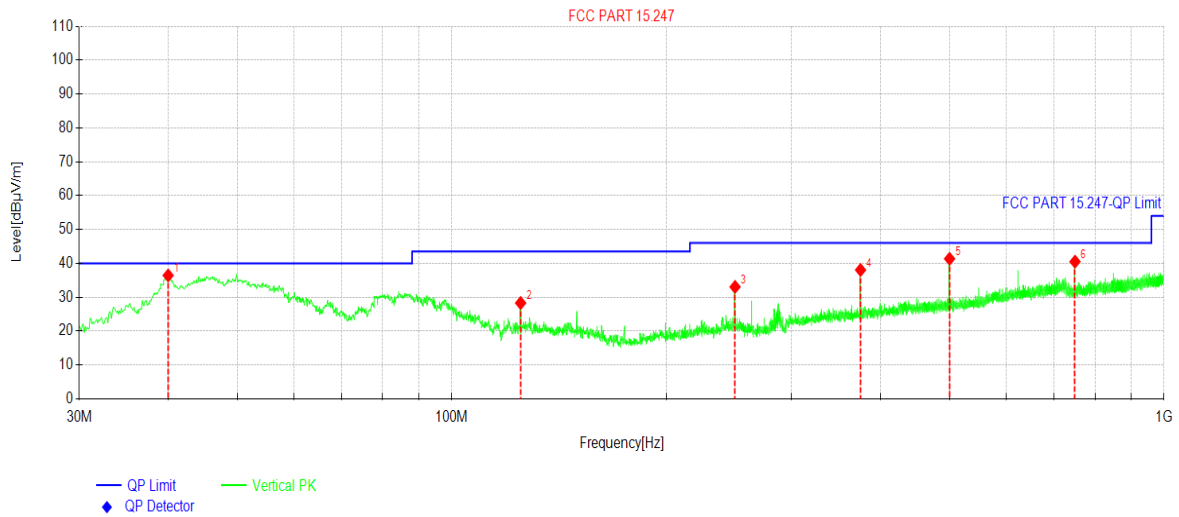

| Suspected Data List |             |                  |                |             |                |             |       |          |
|---------------------|-------------|------------------|----------------|-------------|----------------|-------------|-------|----------|
| NO.                 | Freq. [MHz] | Reading [dBµV/m] | Level [dBµV/m] | Factor [dB] | Limit [dBµV/m] | Margin [dB] | Trace | Polarity |
| 1                   | 39.9920     | 50.11            | 36.45          | -13.66      | 40.00          | 3.55        | PK    | Vertical |
| 2                   | 124.972     | 45.86            | 28.30          | -17.56      | 43.50          | 15.20       | PK    | Vertical |
| 3                   | 249.921     | 46.55            | 33.06          | -13.49      | 46.00          | 12.94       | PK    | Vertical |
| 4                   | 374.966     | 48.83            | 38.05          | -10.78      | 46.00          | 7.95        | PK    | Vertical |
| 5                   | 500.012     | 50.32            | 41.36          | -8.96       | 46.00          | 4.64        | PK    | Vertical |
| 6                   | 750.006     | 44.45            | 40.51          | -3.94       | 46.00          | 5.49        | PK    | Vertical |

**Remark:**

1. Level = Reading + Factor(Antenna Factor + Cable Loss – Preamplifier Factor).

|                        |                             |                       |                     |
|------------------------|-----------------------------|-----------------------|---------------------|
| <b>Product Name:</b>   | Multi Protocol Host Gateway | <b>Product Model:</b> | DSGW-291-X (X:1~18) |
| <b>Test By:</b>        | June                        | <b>Test mode:</b>     | BLE Tx (LE 1M PHY)  |
| <b>Test Frequency:</b> | 30 MHz ~ 1 GHz              | <b>Polarization:</b>  | Horizontal          |
| <b>Test Voltage:</b>   | DC 12V                      |                       |                     |

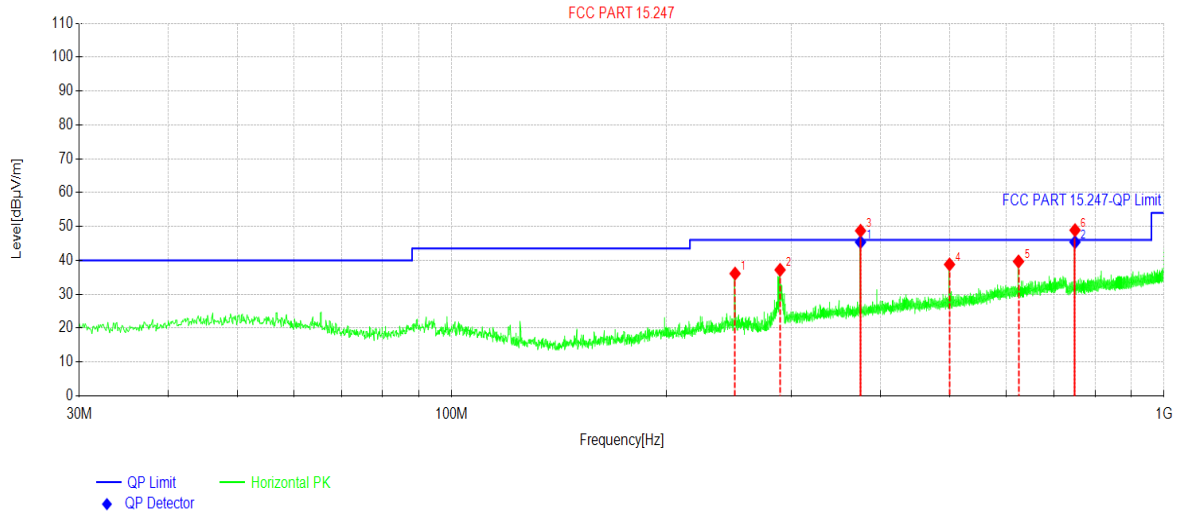

| Suspected Data List |             |                  |                |             |                |             |       |            |
|---------------------|-------------|------------------|----------------|-------------|----------------|-------------|-------|------------|
| NO.                 | Freq. [MHz] | Reading [dBμV/m] | Level [dBμV/m] | Factor [dB] | Limit [dBμV/m] | Margin [dB] | Trace | Polarity   |
| 1                   | 249.921     | 49.59            | 36.10          | -13.49      | 46.00          | 9.90        | PK    | Horizontal |
| 2                   | 289.112     | 50.21            | 37.20          | -13.01      | 46.00          | 8.80        | PK    | Horizontal |
| 3                   | 374.966     | 59.52            | 48.74          | -10.78      | 46.00          | -2.74       | PK    | Horizontal |
| 4                   | 500.012     | 47.76            | 38.80          | -8.96       | 46.00          | 7.20        | PK    | Horizontal |
| 5                   | 624.960     | 45.90            | 39.68          | -6.22       | 46.00          | 6.32        | PK    | Horizontal |
| 6                   | 750.006     | 52.86            | 48.92          | -3.94       | 46.00          | -2.92       | PK    | Horizontal |

| Final Data List |             |             |                   |                   |                |                     |           |         |
|-----------------|-------------|-------------|-------------------|-------------------|----------------|---------------------|-----------|---------|
| NO.             | Freq. [MHz] | Factor [dB] | QP Value [dBμV/m] | QP Limit [dBμV/m] | QP Margin [dB] | QP Reading [dBμV/m] | Angle [°] | Verdict |
| 1               | 374.966     | -10.78      | 45.38             | 46.00             | 0.62           | 56.16               | 48        | PASS    |
| 2               | 750.006     | -3.94       | 45.38             | 46.00             | 0.62           | 49.32               | 217       | PASS    |

**Remark:**

1. Level = Reading + Factor(Antenna Factor + Cable Loss – Preamplifier Factor).



**Above 1GHz:**

| BLE Tx (LE 1M PHY)  |                   |             |                |                |             |              |
|---|-------------------|-------------|----------------|----------------|-------------|--------------|
| Test channel: Lowest channel  |                   |             |                |                |             |              |
| Detector: Peak Value  |                   |             |                |                |             |              |
| Frequency (MHz)   | Read Level (dBμV) | Factor (dB) | Level (dBμV/m) | Limit (dBμV/m) | Margin (dB) | Polarization |
| 4804.00   | 57.14             | -9.08       | 48.06          | 74.00          | 25.94       | Vertical     |
| 4804.00   | 55.73             | -9.08       | 46.65          | 74.00          | 27.35       | Horizontal   |
| Detector: Average Value   |                   |             |                |                |             |              |
| Frequency (MHz)   | Read Level (dBμV) | Factor (dB) | Level (dBμV/m) | Limit (dBμV/m) | Margin (dB) | Polarization |
| 4804.00   | 51.07             | -9.08       | 41.99          | 54.00          | 12.01       | Vertical     |
| 4804.00   | 48.72             | -9.08       | 39.64          | 54.00          | 14.36       | Horizontal   |
| Test channel: Middle channel  |                   |             |                |                |             |              |
| Detector: Peak Value  |                   |             |                |                |             |              |
| Frequency (MHz)   | Read Level (dBμV) | Factor (dB) | Level (dBμV/m) | Limit (dBμV/m) | Margin (dB) | Polarization |
| 4884.00   | 57.37             | -8.59       | 48.78          | 74.00          | 25.22       | Vertical     |
| 4884.00   | 56.01             | -8.59       | 47.42          | 74.00          | 26.58       | Horizontal   |
| Detector: Average Value   |                   |             |                |                |             |              |
| Frequency (MHz)   | Read Level (dBμV) | Factor (dB) | Level (dBμV/m) | Limit (dBμV/m) | Margin (dB) | Polarization |
| 4884.00   | 50.70             | -8.59       | 42.11          | 54.00          | 11.89       | Vertical     |
| 4884.00   | 48.63             | -8.59       | 40.04          | 54.00          | 13.96       | Horizontal   |
| Test channel: Highest channel   |                   |             |                |                |             |              |
| Detector: Peak Value  |                   |             |                |                |             |              |
| Frequency (MHz)   | Read Level (dBμV) | Factor (dB) | Level (dBμV/m) | Limit (dBμV/m) | Margin (dB) | Polarization |
| 4960.00   | 57.50             | -8.03       | 49.47          | 74.00          | 24.53       | Vertical     |
| 4960.00   | 55.79             | -8.03       | 47.76          | 74.00          | 26.24       | Horizontal   |
| Detector: Average Value   |                   |             |                |                |             |              |
| Frequency (MHz)   | Read Level (dBμV) | Factor (dB) | Level (dBμV/m) | Limit (dBμV/m) | Margin (dB) | Polarization |
| 4960.00   | 51.07             | -8.03       | 43.04          | 54.00          | 10.96       | Vertical     |
| 4960.00   | 48.13             | -8.03       | 40.10          | 54.00          | 13.90       | Horizontal   |
| <b>Remark:</b>  |                   |             |                |                |             |              |
| 1. Level = Reading + Factor.  |                   |             |                |                |             |              |
| 2. Test Frequency up to 25GHz, and the emission levels of other frequencies are lower than the limit 20dB, not show in test report. |                   |             |                |                |             |              |

| BLE Tx (LE 2M PHY)   |                   |             |                |                |             |              |
|--|-------------------|-------------|----------------|----------------|-------------|--------------|
| Test channel: Lowest channel   |                   |             |                |                |             |              |
| Detector: Peak Value   |                   |             |                |                |             |              |
| Frequency (MHz)  | Read Level (dBμV) | Factor (dB) | Level (dBμV/m) | Limit (dBμV/m) | Margin (dB) | Polarization |
| 4804.00  | 57.89             | -9.08       | 48.81          | 74.00          | 25.19       | Vertical     |
| 4804.00  | 56.27             | -9.08       | 47.19          | 74.00          | 26.81       | Horizontal   |
| Detector: Average Value  |                   |             |                |                |             |              |
| Frequency (MHz)  | Read Level (dBμV) | Factor (dB) | Level (dBμV/m) | Limit (dBμV/m) | Margin (dB) | Polarization |
| 4804.00  | 51.09             | -9.08       | 42.01          | 54.00          | 11.99       | Vertical     |
| 4804.00  | 48.09             | -9.08       | 39.01          | 54.00          | 14.99       | Horizontal   |
| Test channel: Middle channel   |                   |             |                |                |             |              |
| Detector: Peak Value   |                   |             |                |                |             |              |
| Frequency (MHz)  | Read Level (dBμV) | Factor (dB) | Level (dBμV/m) | Limit (dBμV/m) | Margin (dB) | Polarization |
| 4884.00  | 57.75             | -8.59       | 49.16          | 74.00          | 24.84       | Vertical     |
| 4884.00  | 56.14             | -8.59       | 47.55          | 74.00          | 26.45       | Horizontal   |
| Detector: Average Value  |                   |             |                |                |             |              |
| Frequency (MHz)  | Read Level (dBμV) | Factor (dB) | Level (dBμV/m) | Limit (dBμV/m) | Margin (dB) | Polarization |
| 4884.00  | 50.98             | -8.59       | 42.39          | 54.00          | 11.61       | Vertical     |
| 4884.00  | 48.26             | -8.59       | 39.67          | 54.00          | 14.33       | Horizontal   |
| Test channel: Highest channel  |                   |             |                |                |             |              |
| Detector: Peak Value   |                   |             |                |                |             |              |
| Frequency (MHz)  | Read Level (dBμV) | Factor (dB) | Level (dBμV/m) | Limit (dBμV/m) | Margin (dB) | Polarization |
| 4960.00  | 57.62             | -8.03       | 49.59          | 74.00          | 24.41       | Vertical     |
| 4960.00  | 55.67             | -8.03       | 47.64          | 74.00          | 26.36       | Horizontal   |
| Detector: Average Value  |                   |             |                |                |             |              |
| Frequency (MHz)  | Read Level (dBμV) | Factor (dB) | Level (dBμV/m) | Limit (dBμV/m) | Margin (dB) | Polarization |
| 4960.00  | 51.29             | -8.03       | 43.26          | 54.00          | 10.74       | Vertical     |
| 4960.00  | 48.25             | -8.03       | 40.22          | 54.00          | 13.78       | Horizontal   |
| <b>Remark:</b>   |                   |             |                |                |             |              |
| 1. <i>Level = Reading + Factor.</i>  |                   |             |                |                |             |              |
| 2. <i>Test Frequency up to 25GHz, and the emission levels of other frequencies are lower than the limit 20dB, not show in test report.</i> |                   |             |                |                |             |              |

| BEL Tx (LE Coded PHY, S=2)  |                   |             |                |                |             |              |
|---|-------------------|-------------|----------------|----------------|-------------|--------------|
| Test channel: Lowest channel  |                   |             |                |                |             |              |
| Detector: Peak Value  |                   |             |                |                |             |              |
| Frequency (MHz)   | Read Level (dBμV) | Factor (dB) | Level (dBμV/m) | Limit (dBμV/m) | Margin (dB) | Polarization |
| 4804.00   | 57.40             | -9.08       | 48.32          | 74.00          | 25.68       | Vertical     |
| 4804.00   | 55.57             | -9.08       | 46.49          | 74.00          | 27.51       | Horizontal   |
| Detector: Average Value   |                   |             |                |                |             |              |
| Frequency (MHz)   | Read Level (dBμV) | Factor (dB) | Level (dBμV/m) | Limit (dBμV/m) | Margin (dB) | Polarization |
| 4804.00   | 51.73             | -9.08       | 42.65          | 54.00          | 11.35       | Vertical     |
| 4804.00   | 48.16             | -9.08       | 39.08          | 54.00          | 14.92       | Horizontal   |
| Test channel: Middle channel  |                   |             |                |                |             |              |
| Detector: Peak Value  |                   |             |                |                |             |              |
| Frequency (MHz)   | Read Level (dBμV) | Factor (dB) | Level (dBμV/m) | Limit (dBμV/m) | Margin (dB) | Polarization |
| 4884.00   | 57.14             | -8.59       | 48.55          | 74.00          | 25.45       | Vertical     |
| 4884.00   | 55.83             | -8.59       | 47.24          | 74.00          | 26.76       | Horizontal   |
| Detector: Average Value   |                   |             |                |                |             |              |
| Frequency (MHz)   | Read Level (dBμV) | Factor (dB) | Level (dBμV/m) | Limit (dBμV/m) | Margin (dB) | Polarization |
| 4884.00   | 51.76             | -8.59       | 43.17          | 54.00          | 10.83       | Vertical     |
| 4884.00   | 47.93             | -8.59       | 39.34          | 54.00          | 14.66       | Horizontal   |
| Test channel: Highest channel   |                   |             |                |                |             |              |
| Detector: Peak Value  |                   |             |                |                |             |              |
| Frequency (MHz)   | Read Level (dBμV) | Factor (dB) | Level (dBμV/m) | Limit (dBμV/m) | Margin (dB) | Polarization |
| 4960.00   | 57.16             | -8.03       | 49.13          | 74.00          | 24.87       | Vertical     |
| 4960.00   | 55.81             | -8.03       | 47.78          | 74.00          | 26.22       | Horizontal   |
| Detector: Average Value   |                   |             |                |                |             |              |
| Frequency (MHz)   | Read Level (dBμV) | Factor (dB) | Level (dBμV/m) | Limit (dBμV/m) | Margin (dB) | Polarization |
| 4960.00   | 51.26             | -8.03       | 43.23          | 54.00          | 10.77       | Vertical     |
| 4960.00   | 47.71             | -8.03       | 39.68          | 54.00          | 14.32       | Horizontal   |
| <b>Remark:</b>  |                   |             |                |                |             |              |
| 1. Level = Reading + Factor.  |                   |             |                |                |             |              |
| 2. Test Frequency up to 25GHz, and the emission levels of other frequencies are lower than the limit 20dB, not show in test report. |                   |             |                |                |             |              |

| BEL Tx (LE Coded PHY, S=8)  |                   |             |                |                |             |              |
|---|-------------------|-------------|----------------|----------------|-------------|--------------|
| Test channel: Lowest channel  |                   |             |                |                |             |              |
| Detector: Peak Value  |                   |             |                |                |             |              |
| Frequency (MHz)   | Read Level (dBμV) | Factor (dB) | Level (dBμV/m) | Limit (dBμV/m) | Margin (dB) | Polarization |
| 4804.00   | 57.30             | -9.08       | 48.22          | 74.00          | 25.78       | Vertical     |
| 4804.00   | 55.56             | -9.08       | 46.48          | 74.00          | 27.52       | Horizontal   |
| Detector: Average Value   |                   |             |                |                |             |              |
| Frequency (MHz)   | Read Level (dBμV) | Factor (dB) | Level (dBμV/m) | Limit (dBμV/m) | Margin (dB) | Polarization |
| 4804.00   | 51.74             | -9.08       | 42.66          | 54.00          | 11.34       | Vertical     |
| 4804.00   | 48.04             | -9.08       | 38.96          | 54.00          | 15.04       | Horizontal   |
| Test channel: Middle channel  |                   |             |                |                |             |              |
| Detector: Peak Value  |                   |             |                |                |             |              |
| Frequency (MHz)   | Read Level (dBμV) | Factor (dB) | Level (dBμV/m) | Limit (dBμV/m) | Margin (dB) | Polarization |
| 4884.00   | 57.31             | -8.59       | 48.72          | 74.00          | 25.28       | Vertical     |
| 4884.00   | 55.33             | -8.59       | 46.74          | 74.00          | 27.26       | Horizontal   |
| Detector: Average Value   |                   |             |                |                |             |              |
| Frequency (MHz)   | Read Level (dBμV) | Factor (dB) | Level (dBμV/m) | Limit (dBμV/m) | Margin (dB) | Polarization |
| 4884.00   | 51.75             | -8.59       | 43.16          | 54.00          | 10.84       | Vertical     |
| 4884.00   | 48.19             | -8.59       | 39.60          | 54.00          | 14.40       | Horizontal   |
| Test channel: Highest channel   |                   |             |                |                |             |              |
| Detector: Peak Value  |                   |             |                |                |             |              |
| Frequency (MHz)   | Read Level (dBμV) | Factor (dB) | Level (dBμV/m) | Limit (dBμV/m) | Margin (dB) | Polarization |
| 4960.00   | 57.19             | -8.03       | 49.16          | 74.00          | 24.84       | Vertical     |
| 4960.00   | 54.90             | -8.03       | 46.87          | 74.00          | 27.13       | Horizontal   |
| Detector: Average Value   |                   |             |                |                |             |              |
| Frequency (MHz)   | Read Level (dBμV) | Factor (dB) | Level (dBμV/m) | Limit (dBμV/m) | Margin (dB) | Polarization |
| 4960.00   | 51.29             | -8.03       | 43.26          | 54.00          | 10.74       | Vertical     |
| 4960.00   | 48.16             | -8.03       | 40.13          | 54.00          | 13.87       | Horizontal   |
| <b>Remark:</b>  |                   |             |                |                |             |              |
| 1. Level = Reading + Factor.  |                   |             |                |                |             |              |
| 2. Test Frequency up to 25GHz, and the emission levels of other frequencies are lower than the limit 20dB, not show in test report. |                   |             |                |                |             |              |

-----End of report-----