



# RF TEST REPORT

**Applicant**      Quectel Wireless Solutions Co., Ltd  
**FCC ID**          XMR201909EG91NAX  
**Product**        LTE Module  
**Brand**            Quectel  
**Model**            EG91-NAX  
**Report No.**      R1907A0406-R5V1  
**Issue Date**      November 29, 2019

TA Technology (Shanghai) Co., Ltd. tested the above equipment in accordance with the requirements in **FCC CFR47 Part 2 (2017)/ FCC CFR47 Part 27C (2017)**. The test results show that the equipment tested is capable of demonstrating compliance with the requirements as documented in this report.

*Performed by: Peng Tao*

*Approved by: Kai Xu*

---

## TA Technology (Shanghai) Co., Ltd.

*No.145, Jintang Rd, Tangzhen Industry Park, Pudong Shanghai, China*

*TEL: +86-021-50791141/2/3*

*FAX: +86-021-50791141/2/3-8000*

## Table of Contents

1	Test Laboratory.....	4
1.1	Notes of the Test Report.....	4
1.2	Testing Location.....	4
2	General Description of Equipment under Test.....	5
3	Applied Standards.....	6
4	Test Configuration.....	7
5	Test Case Results.....	9
5.1	RF Power Output.....	9
5.2	Effective Isotropic Radiated Power.....	15
5.3	Occupied Bandwidth.....	21
5.4	Band Edge Compliance.....	38
5.5	Peak-to-Average Power Ratio (PAPR).....	55
5.6	Frequency Stability.....	59
5.7	Spurious Emissions at Antenna Terminals.....	64
5.8	Radiates Spurious Emission.....	83
6	Main Test Instruments.....	100

## Summary of Measurement Results

Number	Test Case	Clause in FCC rules	Verdict
1	RF power output	2.1046	PASS
2	Effective Isotropic Radiated power	27.50(d)(4)/27.50(b)(10)/27.50(c)(10)	PASS
3	Occupied Bandwidth	2.1049	PASS
4	Band Edge Compliance	27.53(h)/27.53(g)/27.53(f) /27.53(c)	PASS
5	Peak-to-Average Power Ratio	27.50(d)/KDB971168 D01(5.7)	PASS
6	Frequency Stability	2.1055 / 27.54	PASS
7	Spurious Emissions at Antenna Terminals	2.1051/27.53(h)/27.53(g)/27.53(f)	PASS
8	Radiates Spurious Emission	2.1051/27.53(h) /27.53(g) /27.53(f)	PASS
Date of Testing: May 25, 2018 ~ June 27, 2018 and November 28, 2019			
Note: PASS: The EUT complies with the essential requirements in the standard. FAIL: The EUT does not comply with the essential requirements in the standard.			

**EG91-NAX (Report No.: R1907A0406-R5) is a variant of the EG91-NA (Report No.: R1805A0250-R3). Test values duplicated from Original for variant. There is no test for variant in this report.**

# 1 Test Laboratory

## 1.1 Notes of the Test Report

This report shall not be reproduced in full or partial, without the written approval of **TA technology (shanghai) co., Ltd.** The results documented in this report apply only to the tested sample, under the conditions and modes of operation as described herein .Measurement Uncertainties were not taken into account and are published for informational purposes only. This report is written to support regulatory compliance of the applicable standards stated above.

## 1.2 Testing Location

Company: TA Technology (Shanghai) Co., Ltd.  
Address: No.145, Jintang Rd, Tangzhen Industry Park, Pudong Shanghai, China  
City: Shanghai  
Post code: 201201  
Country: P. R. China  
Contact: Xu Kai  
Telephone: +86-021-50791141/2/3  
Fax: +86-021-50791141/2/3-8000  
Website: <http://www.ta-shanghai.com>  
E-mail: [xukai@ta-shanghai.com](mailto:xukai@ta-shanghai.com)

## 2 General Description of Equipment under Test

### Client Information

<b>Applicant</b>	Quectel Wireless Solutions Co., Ltd
<b>Applicant address</b>	Building 5, Shanghai Business Park Phase III (Area B), No.1016 Tianlin Road, Minhang District, Shanghai, China 200233
<b>Manufacturer</b>	Quectel Wireless Solutions Co., Ltd
<b>Manufacturer address</b>	Building 5, Shanghai Business Park Phase III (Area B), No.1016 Tianlin Road, Minhang District, Shanghai, China 200233

### General information

EUT Description			
Model	EG91-NAX		
IMEI	868050040003283		
Hardware Version	R1.0		
Software Version	EG91NAXGAR07A01M1G		
Power Supply	External Power Supply		
Antenna Type	The EUT don't have standard Antenna, The Antenna used for testing in this report is the after-market accessory (Dipole Antenna)		
Test Mode(s)	WCDMA Band IV; LTE Band 4; LTE Band 12, LTE Band 13;		
Test Modulation	(WCDMA)QPSK; (LTE)QPSK 16QAM;		
HSDPA UE Category	24		
HSUPA UE Category	6		
DC-HSDPA UE Category	24		
LTE Category	1		
Maximum E.I.R.P./ E.R.P.	WCDMA Band IV:	24.11dBm	
	LTE Band 4:	25.23dBm	
	LTE Band 12:	19.44dBm	
	LTE Band 13:	22.55Bm	
Rated Power Supply Voltage:	3.8V		
Extreme Voltage	Minimum: 3.3V    Maximum: 4.3V		
Extreme Temperature	Lowest: -40°C    Highest: +85°C		
Operating Frequency Range(s)	Mode	Tx (MHz)	Rx (MHz)
	WCDMA Band IV	1710 ~ 1755	2110 ~ 2155
	LTE Band 4	1710 ~ 1755	2110 ~ 2155
	LTE Band 12	699 ~ 716	729 ~ 746
	LTE Band 13	777 ~ 787	746 ~ 756
Note: 1. The information of the EUT is declared by the manufacturer. 2. For LTE, 16QAM only supports 25%RB.			

### 3 Applied Standards

According to the specifications of the manufacturer, it must comply with the requirements of the following standards:

#### Test standards

**FCC CFR47 Part 2 (2017)**

**FCC CFR47 Part 27C (2017)**

**ANSI/TIA-603-E (2016)**

**KDB 971168 D01 Power Meas License Digital Systems v03r01**

## 4 Test Configuration

Radiated measurements are performed by rotating the EUT in three different orthogonal test planes. EUT stand-up position (Z axis), lie-down position (X, Y axis). Receiver antenna polarization (horizontal and vertical), the worst emission was found in position (Z axis, horizontal position) and the worst case was recorded.

All mode and data rates and positions and RB size and modulations were investigated. Subsequently, only the worst case emissions are reported.

The following testing in WCDMA/LTE is set based on the maximum RF Output Power.

The following testing in different Bandwidth is set to detail in the following table:

Test modes are chosen to be reported as the worst case configuration below for WCDMA Band IV:

	Test items	Modes/Modulation
		WCDMA Band IV
Conducted Test cases	RF power output	RMC HSDPA/HSUPA DC-HSDPA
	Occupied Bandwidth	RMC
	Band Edge Compliance	RMC
	Peak-to-Average Power Ratio	RMC
	Frequency Stability	RMC
	Spurious Emissions at Antenna Terminals	RMC
Radiated Test cases	Effective Isotropic Radiated power	RMC
	Radiates Spurious Emission	RMC

Test modes are chosen to be reported as the worst case configuration below for LTE Band 4/12/13:

Test items	Modes	Bandwidth (MHz)						Modulation		RB			Test Channel		
		1.4	3	5	10	15	20	QPSK	16QAM	1	50%	100%	L	M	H
RF power output	LTE 4	O	O	O	O	O	O	O	O	O	O	O	O	O	O
	LTE 12	O	O	O	O	-	-	O	O	O	O	O	O	O	O
	LTE 13	-	-	O	O	-	-	O	O	O	O	O	O	O	O
Effective Isotropic Radiated power	LTE 4	O	O	O	O	O	O	O	O	O	O	O	O	O	O
	LTE 12	O	O	O	O	-	-	O	O	O	O	O	O	O	O
	LTE 13	-	-	O	O	-	-	O	O	O	O	O	O	O	O
Occupied Bandwidth	LTE 4	O	O	O	O	O	O	O	O	O	-	O	O	O	O
	LTE 12	O	O	O	O	-	-	O	O	O	-	O	O	O	O
	LTE 13	-	-	O	O	-	-	O	O	O	-	O	O	O	O
Band Edge Compliance	LTE 4	O	O	O	O	O	O	O	O	O	-	O	O	-	O
	LTE 12	O	O	O	O	-	-	O	O	O	-	O	O	-	O
	LTE 13	-	-	O	O	-	-	O	O	O	-	O	O	-	O
Peak-to-Average Power Ratio	LTE 4	O	O	O	O	O	O	O	O	O	-	O	O	O	O
	LTE 12	O	O	O	O	-	-	O	O	O	-	O	O	O	O
	LTE 13	-	-	O	O	-	-	O	O	O	-	O	O	O	O
Frequency Stability	LTE 4	O	O	O	O	O	O	O	O	O	-	O	O	-	O
	LTE 12	O	O	O	O	-	-	O	O	O	-	O	O	-	O
	LTE 13	-	-	O	O	-	-	O	O	O	-	O	O	-	O
Spurious Emissions at Antenna Terminals	LTE 4	O	O	O	O	O	O	O	-	O	-	-	O	O	O
	LTE 12	O	O	O	O	-	-	O	-	O	-	-	O	O	O
	LTE 13	-	-	O	O	-	-	O	-	O	-	-	O	O	O
Radiates Spurious Emission	LTE 4	O	-	O	-	-	O	O	-	O	-	-	O	O	O
	LTE 12	O	-	O	O	-	-	O	-	O	-	-	O	O	O
	LTE 13	-	-	O	O	-	-	O	-	O	-	-	O	O	O
Note	1. The mark "O" means that this configuration is chosen for testing. 2. The mark "-" means that this configuration is not testing. 3. For LTE, 16QAM only supports 25%RB.														



## 5 Test Case Results

### 5.1 RF Power Output

#### Ambient condition

Temperature	Relative humidity	Pressure
23°C ~25°C	45%~50%	101.5kPa

#### Methods of Measurement

During the process of the testing, The EUT is controlled by the Base Station Simulator to ensure max power transmission and proper modulation.

#### Test Setup

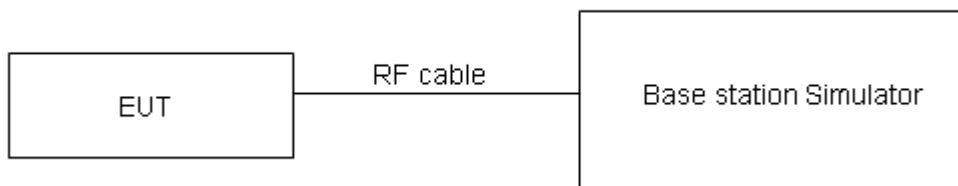

The loss between RF output port of the EUT and the input port of the tester has been taken into consideration.

#### Limits

No specific RF power output requirements in part 2.1046.

#### Measurement Uncertainty

The assessed measurement uncertainty to ensure 95% confidence level for the normal distribution is with the coverage factor  $k = 2$ ,  $U=0.4$  dB.

**Test Results**

WCDMA Band IV		AV Conducted Power(dBm)		
		Channel 1312	Channel 1413	Channel 1513
		1712.4 (MHz)	1732.6 (MHz)	1752.6(MHz)
<b>RMC</b>	12.2k	23.57	23.56	23.51
	64k	23.43	23.50	23.38
	144k	23.42	23.40	23.37
	384k	23.41	23.39	23.36
<b>HSDPA</b>	Sub - Test 1	23.27	23.25	23.26
	Sub - Test 2	23.25	23.28	23.32
	Sub - Test 3	22.89	22.79	22.86
	Sub - Test 4	22.83	22.74	22.80
<b>HSUPA</b>	Sub - Test 1	23.32	23.25	23.30
	Sub - Test 2	22.84	22.81	22.80
	Sub - Test 3	23.32	23.31	23.27
	Sub - Test 4	23.31	23.29	23.36
	Sub - Test 5	23.26	23.16	23.25
<b>DC-HSDPA</b>	Sub - Test 1	23.44	23.43	23.38
	Sub - Test 2	23.42	23.42	23.37
	Sub - Test 3	22.91	22.91	22.86
	Sub - Test 4	22.90	22.90	22.85

LTE Band 4				AV Conducted Power(dBm)		
Bandwidth	Modulation	RB size	RB offset	Channel/Frequency (MHz)		
				19957/1710.7	20175/1732.5	20393/1754.3
1.4MHz	QPSK	1	0	23.94	24.08	23.88
		1	2	24.02	24.12	24.05
		1	5	24.13	24.25	23.87
		3	0	24.07	23.93	23.92
		3	2	23.93	23.86	23.96
		3	3	24.03	23.83	24.02
	16QAM	1	0	23.06	22.95	22.98
		1	0	23.39	23.01	22.93
		1	2	23.48	23.49	23.12
		1	5	23.51	22.67	23.05
Bandwidth	Modulation	RB size	RB offset	Channel/Frequency (MHz)		
				19965/1711.5	20175/1732.5	20385/1753.5
3MHz	QPSK	1	0	24.02	24.03	24.03
		1	7	24.05	24.30	24.21
		1	14	23.91	24.06	23.81
		8	0	22.88	22.94	23.03
		8	4	22.85	22.87	22.96
		8	7	22.70	22.98	22.89
	16QAM	15	0	22.79	23.06	22.93
		1	0	22.89	22.67	23.60
		1	7	22.85	23.00	23.73
		1	14	22.69	22.94	23.49
Bandwidth	Modulation	RB size	RB offset	Channel/Frequency (MHz)		
				19975/1712.5	20175/1732.5	20375/1752.5
5MHz	QPSK	1	0	23.99	24.01	23.99
		1	13	24.03	24.26	24.18
		1	24	23.88	24.01	23.77
		12	0	22.85	22.89	22.99
		12	6	22.83	22.83	22.91
		12	13	22.68	22.96	22.85
	16QAM	25	0	22.77	23.05	22.91
		1	0	22.86	22.63	23.57
		1	13	22.82	22.98	23.70
		1	24	22.66	22.92	23.45
Bandwidth	Modulation	RB size	RB offset	Channel/Frequency (MHz)		
				20000/1715	20175/1732.5	20350/1750
10MHz	QPSK	1	0	24.01	24.02	24.02
		1	25	24.06	24.31	24.22
		1	49	23.90	24.05	23.80
		25	0	22.88	22.94	23.03



Bandwidth	Modulation	RB size	RB offset	Channel/Frequency (MHz)		
				20025/1717.5	20175/1732.5	20325/1747.5
15MHz	QPSK	1	0	24.00	23.98	24.00
		1	38	24.04	24.30	24.19
		1	74	23.87	24.00	23.76
		36	0	22.86	22.90	23.00
		36	18	22.83	22.83	22.91
		36	39	22.67	22.97	22.86
16QAM	16QAM	1	0	22.83	22.64	23.57
		1	38	22.83	22.99	23.71
		1	74	22.66	22.90	23.45

Bandwidth	Modulation	RB size	RB offset	Channel/Frequency (MHz)			
				20050/1720	20175/1732.5	20300/1745	
20MHz	QPSK	1	0	23.97	23.94	23.97	
		1	50	24.03	24.26	24.17	
		1	99	23.85	23.99	23.73	
		50	0	22.83	22.85	22.96	
		50	25	22.81	22.79	22.88	
		50	50	22.64	22.92	22.82	
	16QAM	16QAM	100	0	22.80	22.98	22.86
			1	0	22.81	22.60	23.52
			1	50	22.79	22.97	23.67
		1	99	22.64	22.87	23.43	

LTE Band 12				AV Conducted Power(dBm)		
Bandwidth	Modulation	RB size	RB offset	Channel/Frequency (MHz)		
				23017/699.7	23095/707.5	23173/715.3
1.4MHz	QPSK	1	0	23.76	23.95	23.57
		1	2	23.67	23.83	23.68
		1	5	23.81	23.91	23.53
		3	0	23.74	23.76	23.78
		3	2	23.58	23.71	23.69
		3	3	23.69	23.81	23.64
		6	0	22.70	22.78	22.83



Bandwidth	Modulation	RB size	RB offset	Channel/Frequency (MHz)			
				23025/700.5	23095/707.5	23165/714.5	
3MHz	16QAM	1	0	23.53	23.16	22.71	
		1	2	23.83	23.07	22.68	
		1	5	23.63	22.90	22.60	
	3MHz	QPSK	1	0	23.92	23.75	23.64
			1	7	24.23	23.94	23.82
			1	14	23.51	23.73	23.65
			8	0	22.86	22.98	22.87
			8	4	22.99	23.03	22.68
			8	7	22.85	22.89	22.97
16QAM		15	0	22.85	22.93	22.99	
		1	0	22.59	23.27	22.84	
		1	7	22.55	23.73	23.28	
5MHz	QPSK	1	14	22.58	23.36	22.68	
		1	0	22.91	23.71	23.62	
		1	13	24.21	23.93	23.79	
		1	24	23.48	23.68	23.61	
		12	0	22.84	22.94	22.84	
		12	6	22.96	22.98	22.64	
	16QAM	12	13	22.82	22.86	22.93	
		25	0	22.83	22.89	22.94	
		1	0	22.54	23.25	22.82	
10MHz	QPSK	1	13	22.53	23.70	23.26	
		1	24	22.55	23.32	22.65	
		1	0	23.88	23.67	23.59	
		1	25	24.20	23.89	23.77	
		1	49	23.46	23.67	23.58	
		25	0	22.81	22.89	22.80	
	16QAM	25	13	22.94	22.94	22.61	
		25	25	22.79	22.81	22.89	
		50	0	22.80	22.84	22.90	
10MHz	16QAM	1	0	22.52	23.21	22.77	
		1	25	22.49	23.68	23.22	
		1	49	22.53	23.29	22.63	

LTE Band 13				Conducted Power(dBm)		
Bandwidth	Modulation	RB size	RB offset	Channel/Frequency (MHz)		
				23205/779.5	23230/782	23255/784.5
5MHz	QPSK	1	0	23.73	23.60	23.61
		1	13	23.64	23.75	23.95
		1	24	23.58	23.74	23.82
		12	0	22.81	22.69	22.81
		12	6	22.65	22.71	22.83
		12	13	22.74	22.76	22.96
	25	0	22.76	22.78	22.89	
	16QAM	1	0	22.88	22.86	22.46
		1	13	22.49	22.81	22.64
1		24	23.12	22.65	22.56	
Bandwidth	Modulation	RB size	RB offset	Channel/Frequency (MHz)		
				/	23230/782	/
10MHz	QPSK	1	0	/	23.61	/
		1	25	/	23.77	/
		1	49	/	23.73	/
		25	0	/	22.71	/
		25	13	/	22.73	/
		25	25	/	22.82	/
	50	0	/	22.74	/	
	16QAM	1	0	/	22.98	/
		1	25	/	23.23	/
1		49	/	23.01	/	

## 5.2 Effective Isotropic Radiated Power

### Ambient condition

Temperature	Relative humidity	Pressure
23°C ~25°C	45%~50%	101.5kPa

### Methods of Measurement

1. The testing follows FCC KDB 971168 D01 v03r01 Section 5.8 and ANSI/TIA-603-E (2016).

a) Connect the equipment as illustrated. Mount the equipment with the manufacturer specified antenna in a vertical orientation on a manufacturer specified mounting surface located on a non-conducting rotating platform of a RF anechoic chamber (preferred) or a standard radiation site.

b) Key the transmitter, then rotate the EUT 360° azimuthally and record spectrum analyzer power level (LVL) measurements at angular increments that are sufficiently small to permit resolution of all peaks. If a standard radiation test site is used, raise and lower the test antenna to obtain a maximum reading at each angular increment. (Note: several batteries may be needed to offset the effect of battery voltage droop, which should not exceed 5% of the manufactured specified battery voltage during transmission).

c) Replace the transmitter under test with a vertically polarized half-wave dipole (or an antenna whose gain is known relative to an ideal half-wave dipole). The center of the antenna should be at the same location as the center of the antenna under test.

d) Connect the antenna to a signal generator with a known output power and record the path loss (in dB) as LOSS. If a standard radiation test site is used, raise and lower the test antenna to obtain a maximum reading.  $LOSS = \text{Generator Output Power (dBm)} - \text{Analyzer reading (dBm)}$

e) Determine the effective radiated output power at each angular position from the readings in steps b) and d) using the following equation:  $ERP \text{ (dBm)} = LVL \text{ (dBm)} + LOSS \text{ (dB)}$

f) The maximum ERP is the maximum value determined in the preceding step.

g) When calculating ERP, in addition to knowing the antenna radiation and matching characteristics, it is necessary to know the loss values of all elements (e.g. transmission line attenuation, mismatches, filters, combiners) interposed between the point where transmitter output power is measured, and the point where power is applied to the antenna. ERP can then be calculated as follows:

$$ERP \text{ (dBm)} = \text{Output Power (dBm)} - \text{Losses (dB)} + \text{Antenna Gain (dBd)}$$

where: dBd refers to gain relative to an ideal dipole.

$$EIRP \text{ (dBm)} = ERP \text{ (dBm)} + 2.15 \text{ (dB.)}$$

The RB allocation refers to section 5.1, using the maximum output power configuration.

**Test setup**

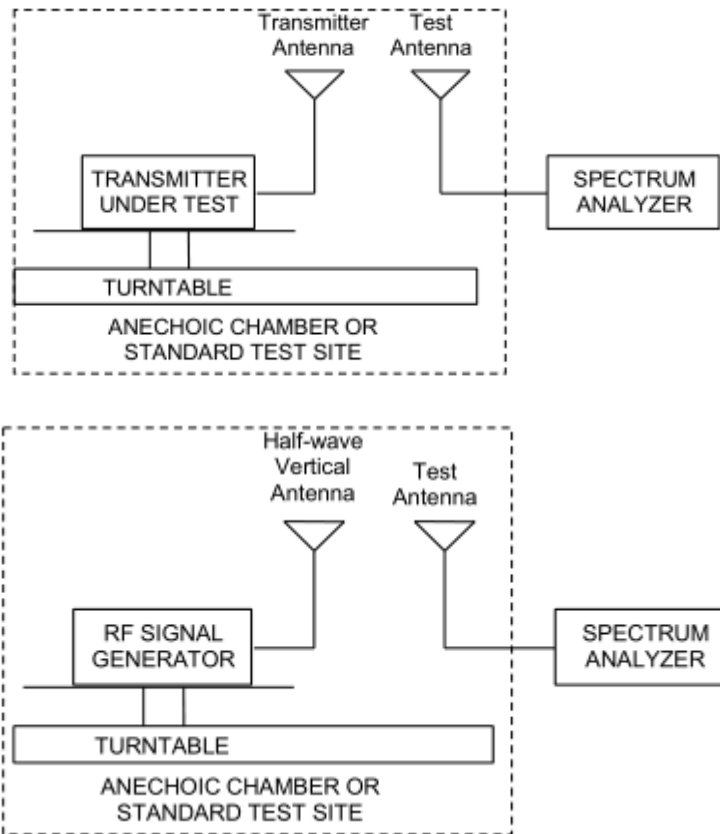

Note: Area side:2.4mX3.6m

The radiated emission was measured in the following position: EUT stand-up position (Z axis), lie-down position (X, Y axis). The worst emission was found in stand-up position (Z axis) and the worst case was recorded.



**Limits**

Rule Part 27.50(b) (10) specifies that “Portable stations (hand-held devices) transmitting in the 746-757 MHz, 776-788 MHz, and 805-806 MHz bands are limited to 3 watts ERP”

Rule Part 27.50(c) (10) specifies that “Portable stations (hand-held devices) in the 600 MHz uplink band and the 698-746 MHz band, and fixed and mobile stations in the 600 MHz uplink band are limited to 3 watts ERP”

Rule Part 27.50(d) (4) specifies that “Fixed, mobile and portable (hand-held) stations operating in the 1710–1755 MHz band are limited to 1 watt EIRP”

Part 27.50(b)(10)Limit	≤ 3 W (34.77 dBm)
Part 27.50(c)(10)Limit	≤ 3 W (34.77 dBm)
Part 27.50(d)(4)Limit	≤ 1 W (30 dBm)

**Measurement Uncertainty**

The assessed measurement uncertainty to ensure 95% confidence level for the normal distribution is with the coverage factor  $k = 2$ ,  $U = 1.19$  dB

**Test Results**

The measurement is performed for both of horizontal and vertical antenna Polarization, and only the data of worst mode is recorded in this report.

Mode	Channel	Frequency (MHz)	Polarization	EIRP (dBm)	Limit (dBm)	Conclusion
<b>WCDMA Band IV</b>	Low	1712.4	Horizontal	23.69	30	Pass
	Mid	1732.6	Horizontal	24.00	30	Pass
	High	1752.6	Horizontal	24.11	30	Pass

<b>LTE Band 4</b>						
Bandwidth	Channel	Frequency (MHz)	Polarization	EIRP (dBm)	Limit (dBm)	Conclusion
<b>1.4 MHz (QPSK)</b>	Low	1710.7	Horizontal	25.13	30	Pass
	Mid	1732.5	Horizontal	24.61	30	Pass
	High	1754.3	Horizontal	24.64	30	Pass
<b>3 MHz (QPSK)</b>	Low	1711.5	Horizontal	25.08	30	Pass
	Mid	1732.5	Horizontal	24.49	30	Pass
	High	1753.5	Horizontal	24.48	30	Pass
<b>5 MHz (QPSK)</b>	Low	1712.5	Horizontal	25.22	30	Pass
	Mid	1732.5	Horizontal	24.61	30	Pass
	High	1752.5	Horizontal	24.70	30	Pass
<b>10 MHz (QPSK)</b>	Low	1715	Horizontal	25.12	30	Pass
	Mid	1732.5	Horizontal	24.50	30	Pass
	High	1750	Horizontal	24.51	30	Pass
<b>15 MHz (QPSK)</b>	Low	1717.5	Horizontal	25.19	30	Pass
	Mid	1732.5	Horizontal	24.63	30	Pass
	High	1747.5	Horizontal	24.73	30	Pass
<b>20 MHz (QPSK)</b>	Low	1720	Horizontal	25.23	30	Pass
	Mid	1732.5	Horizontal	24.79	30	Pass
	High	1745	Horizontal	24.66	30	Pass
<b>1.4 MHz (16QAM)</b>	Low	1710.7	Horizontal	25.01	30	Pass
	Mid	1732.5	Horizontal	24.13	30	Pass
	High	1754.3	Horizontal	24.21	30	Pass
<b>3 MHz (16QAM)</b>	Low	1711.5	Horizontal	24.83	30	Pass
	Mid	1732.5	Horizontal	24.21	30	Pass
	High	1753.5	Horizontal	24.31	30	Pass
<b>5 MHz (16QAM)</b>	Low	1712.5	Horizontal	24.94	30	Pass
	Mid	1732.5	Horizontal	24.32	30	Pass
	High	1752.5	Horizontal	24.55	30	Pass
<b>10 MHz (16QAM)</b>	Low	1715	Horizontal	24.76	30	Pass
	Mid	1732.5	Horizontal	24.31	30	Pass
	High	1750	Horizontal	24.08	30	Pass



<b>15 MHz (16QAM)</b>	Low	1717.5	Horizontal	25.02	30	Pass
	Mid	1732.5	Horizontal	24.31	30	Pass
	High	1747.5	Horizontal	24.48	30	Pass
<b>20 MHz (16QAM)</b>	Low	1720	Horizontal	24.78	30	Pass
	Mid	1732.5	Horizontal	24.35	30	Pass
	High	1745	Horizontal	24.29	30	Pass

<b>LTE Band 12</b>						
<b>Bandwidth</b>	<b>Channel</b>	<b>Frequency (MHz)</b>	<b>Polarization</b>	<b>ERP (dBm)</b>	<b>Limit (dBm)</b>	<b>Conclusion</b>
<b>1.4 MHz (QPSK)</b>	Low	699.7	Horizontal	18.88	34.77	Pass
	Mid	707.5	Horizontal	19.23	34.77	Pass
	High	715.3	Horizontal	19.26	34.77	Pass
<b>3 MHz (QPSK)</b>	Low	700.5	Horizontal	19.04	34.77	Pass
	Mid	707.5	Horizontal	19.39	34.77	Pass
	High	714.5	Horizontal	19.44	34.77	Pass
<b>5 MHz (QPSK)</b>	Low	701.5	Horizontal	18.79	34.77	Pass
	Mid	707.5	Horizontal	19.22	34.77	Pass
	High	713.5	Horizontal	18.99	34.77	Pass
<b>10 MHz (QPSK)</b>	Low	704	Horizontal	18.69	34.77	Pass
	Mid	707.5	Horizontal	19.11	34.77	Pass
	High	711	Horizontal	19.08	34.77	Pass
<b>1.4 MHz (16QAM)</b>	Low	699.7	Horizontal	18.53	34.77	Pass
	Mid	707.5	Horizontal	18.82	34.77	Pass
	High	715.3	Horizontal	19.03	34.77	Pass
<b>3 MHz (16QAM)</b>	Low	700.5	Horizontal	18.62	34.77	Pass
	Mid	707.5	Horizontal	18.90	34.77	Pass
	High	714.5	Horizontal	18.88	34.77	Pass
<b>5 MHz (16QAM)</b>	Low	701.5	Horizontal	18.64	34.77	Pass
	Mid	707.5	Horizontal	18.90	34.77	Pass
	High	713.5	Horizontal	18.74	34.77	Pass
<b>10 MHz (16QAM)</b>	Low	704	Horizontal	18.49	34.77	Pass
	Mid	707.5	Horizontal	18.77	34.77	Pass
	High	711	Horizontal	18.84	34.77	Pass



LTE Band 13						
Bandwidth	Channel	Frequency (MHz)	Polarization	ERP (dBm)	Limit (dBm)	Conclusion
5MHz (QPSK)	Low	779.5	Horizontal	22.11	34.77	Pass
	Mid	782	Horizontal	22.03	34.77	Pass
	High	784.5	Horizontal	22.36	34.77	Pass
10MHz (QPSK)	Mid	782	Horizontal	22.55	34.77	Pass
5MHz (16QAM)	Low	779.5	Horizontal	21.86	34.77	Pass
	Mid	782	Horizontal	21.72	34.77	Pass
	High	784.5	Horizontal	21.94	34.77	Pass
10MHz (16QAM)	Mid	782	Horizontal	22.47	34.77	Pass

### 5.3 Occupied Bandwidth

#### Ambient condition

Temperature	Relative humidity	Pressure
23°C ~25°C	45%~50%	101.5kPa

#### Method of Measurement

The EUT was connected to Spectrum Analyzer and Base Station Simulator via power Splitter. The occupied bandwidth is measured using spectrum analyzer.

RBW is set to 51 kHz, VBW is set to 160 kHz for WCDMA Band IV.

RBW is set to 51 kHz, VBW is set to 160 kHz for LTE Band 4/12 (1.4MHz).

RBW is set to 100 kHz, VBW is set to 300 kHz for LTE Band 4/12 (3MHz).

RBW is set to 100 kHz, VBW is set to 300 kHz for LTE Band 4/12/13 (5MHz).

RBW is set to 300 kHz, VBW is set to 1MHz for LTE Band 4/12/13 (10MHz).

RBW is set to 300 kHz, VBW is set to 1MHz for LTE Band 4 (15MHz/20MHz).

99% power and -26dBc occupied bandwidths are recorded. Spectrum analyzer plots are included on the following pages.

#### Test Setup

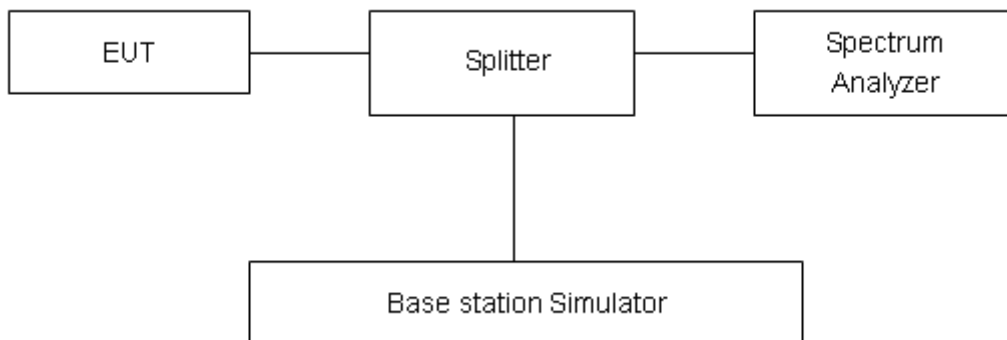

#### Limits

No specific occupied bandwidth requirements in part 2.1049.

#### Measurement Uncertainty

The assessed measurement uncertainty to ensure 95% confidence level for the normal distribution is with the coverage factor  $k = 2$ ,  $U=624\text{Hz}$ .

**Test Result**

Mode	Channel	Frequency (MHz)	99% Power Bandwidth(MHz)	-26dBc Bandwidth(MHz)
WCDMA Band IV (RMC)	1312	1712.4	4.1211	4.659
	1413	1732.6	4.1166	4.670
	1513	1752.6	4.1172	4.682

LTE Band 4						
RB	Modulation	Bandwidth (MHz)	Channel	Frequency (MHz)	99% Power Bandwidth(MHz)	-26dBc Bandwidth(MHz)
100%	QPSK	1.4	19957	1710.7	1.1274	1.3370
			20175	1732.5	1.1077	1.3150
			20393	1754.3	1.1108	1.3350
		3	19965	1711.5	2.7345	3.0400
			20175	1732.5	2.7353	3.0640
			20385	1753.5	2.7424	3.0340
		5	19975	1712.5	4.5308	5.0300
			20175	1732.5	4.5140	4.9760
			20375	1752.5	4.5177	5.0220
		10	20000	1715	9.0214	10.0400
			20175	1732.5	9.0081	10.0200
			20350	1750	9.0092	10.0800
		15	20025	1717.5	13.4740	14.7000
			20175	1732.5	13.4380	14.5600
			20325	1747.5	13.4310	14.6100
		20	20050	1720	17.8960	19.2100
			20175	1732.5	17.9110	19.0400
			20300	1745	17.8610	19.3600
	16QAM	1.4	19957	1710.7	0.3272	0.4604
			20175	1732.5	0.3229	0.4644
			20393	1754.3	0.3144	0.4702
		3	19965	1711.5	0.4026	0.5520
			20175	1732.5	0.4055	0.5578
			20385	1753.5	0.4075	0.5416
		5	19975	1712.5	0.4913	0.6869
			20175	1732.5	0.4934	0.6827
			20375	1752.5	0.4789	0.6779
		10	20000	1715	0.8854	1.2250
			20175	1732.5	0.8542	1.1550



		15	20350	1750	0.8818	1.1890
			20025	1717.5	1.1618	1.5790
			20175	1732.5	1.1293	1.5530
			20325	1747.5	1.1097	1.5420
		20	20050	1720	1.2408	1.7520
			20175	1732.5	1.2067	1.6770
			20300	1745	1.2187	1.7130

LTE Band 12						
RB	Modulation	Bandwidth (MHz)	Channel	Frequency (MHz)	99% Power Bandwidth(MHz)	-26dBc Bandwidth(MHz)
100%	QPSK	1.4	23017	699.7	1.1165	1.3150
			23095	707.5	1.1136	1.3350
			23173	715.3	1.1154	1.3190
		3	23025	700.5	2.7422	3.0590
			23095	707.5	2.7444	3.0520
			23165	714.5	2.7392	3.0720
		5	23035	701.5	4.5137	5.0130
			23095	707.5	4.5160	4.9720
			23155	713.5	4.5174	5.0130
		10	23060	704	9.0155	10.1000
			23095	707.5	9.0102	10.0300
			23130	711	9.0204	9.9670
	16QAM	1.4	23017	699.7	0.3314	0.4775
			23095	707.5	0.3212	0.4597
			23173	715.3	0.3138	0.4574
		3	23025	700.5	0.4025	0.5570
			23095	707.5	0.4097	0.5657
			23165	714.5	0.4048	0.5427
		5	23035	701.5	0.4960	0.7097
			23095	707.5	0.4936	0.7157
			23155	713.5	0.4699	0.6754
		10	23060	704	0.8933	1.2160
			23095	707.5	0.8720	1.2100
			23130	711	0.8918	1.2210



LTE Band 13							
RB	Modulation	Bandwidth (MHz)	Channel	Frequency (MHz)	99% Power Bandwidth(MHz)	-26dBc Bandwidth(MHz)	
100%	QPSK	5	23205	779.5	4.4928	4.9500	
			23230	782	4.5330	5.0620	
			23255	784.5	4.5082	4.9480	
		10	23230	782	9.0350	10.0500	
	16QAM	5	5	23205	779.5	0.4991	0.7263
				23230	782	0.4698	0.6870
				23255	784.5	0.4875	0.6893
		10	23230	782	0.9025	1.2680	



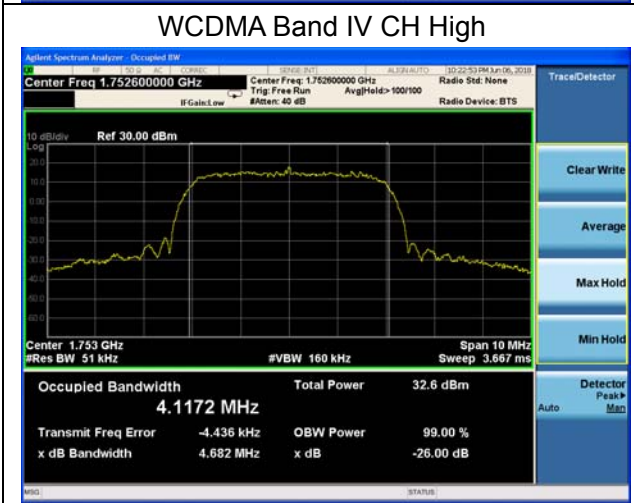
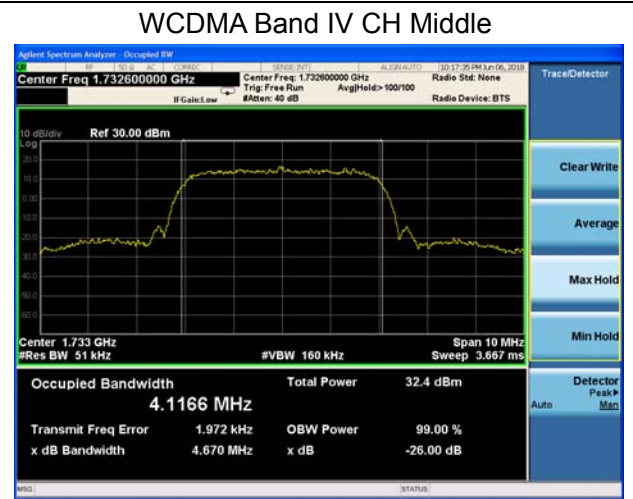
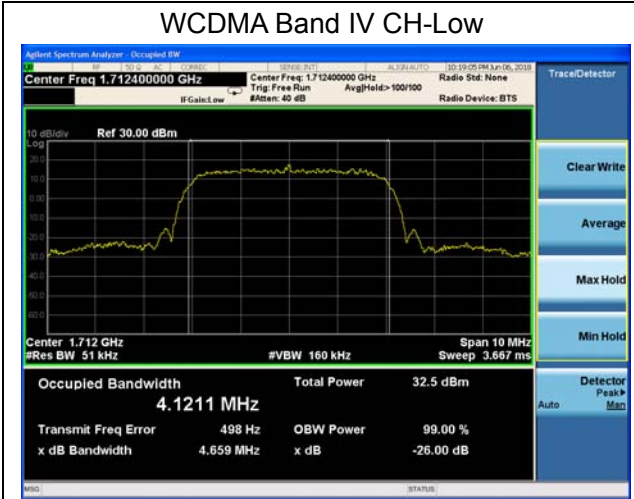

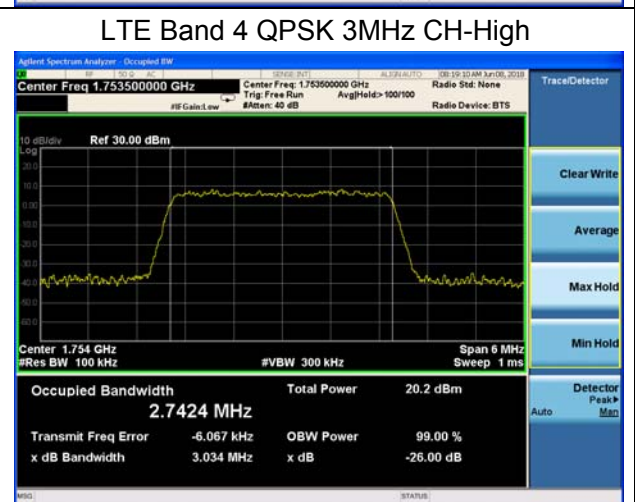
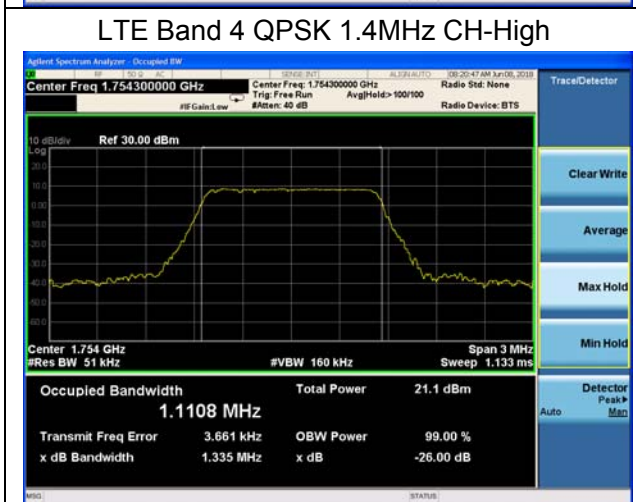
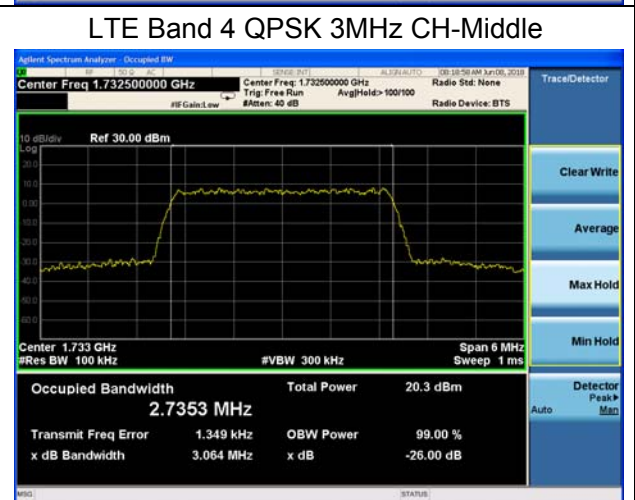
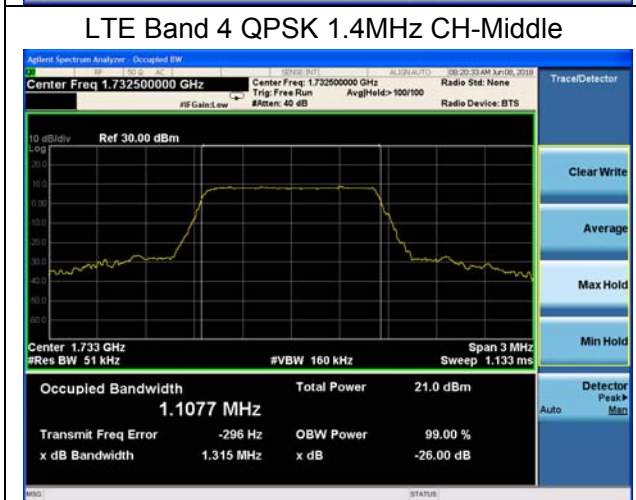
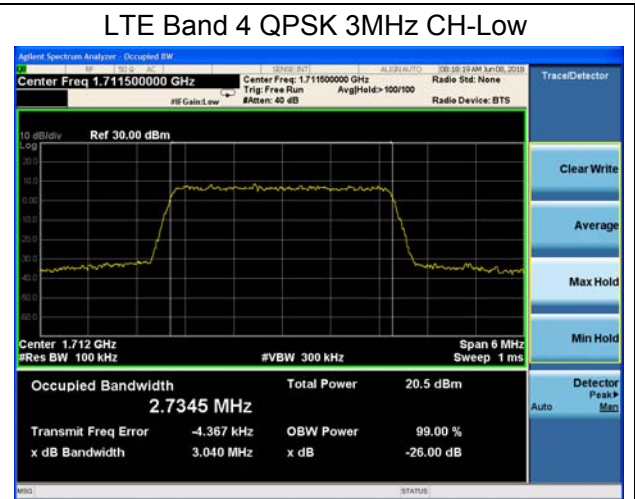
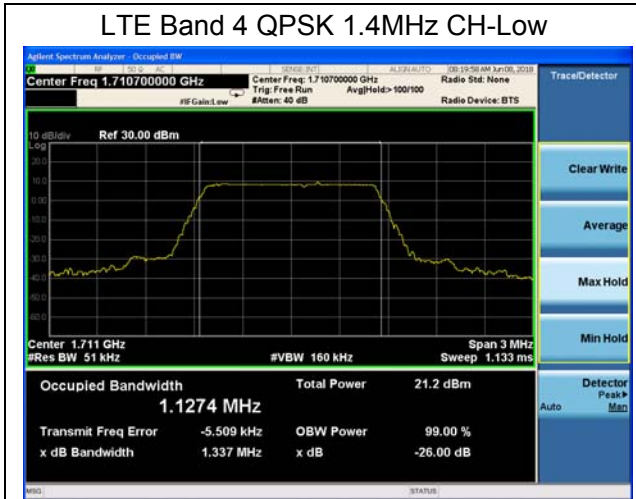

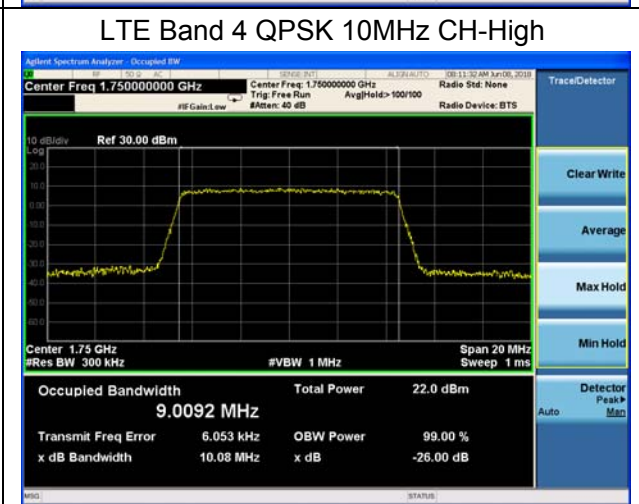
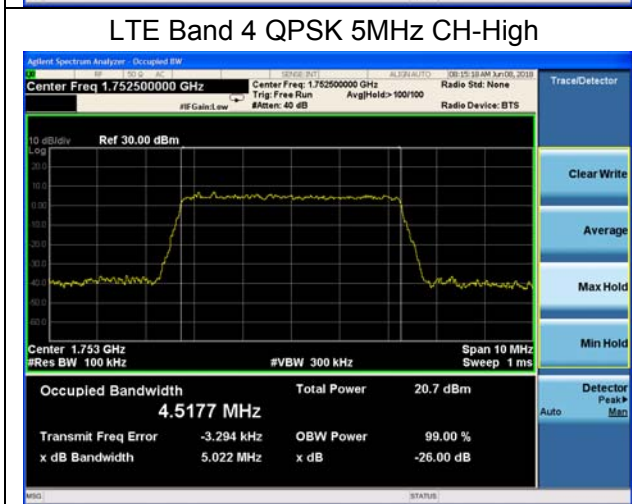
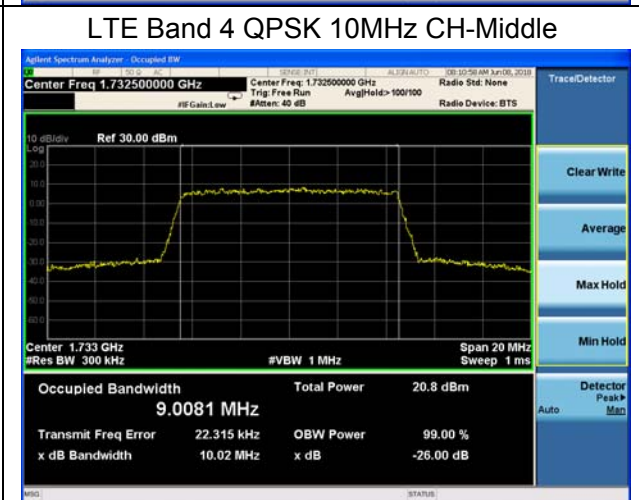
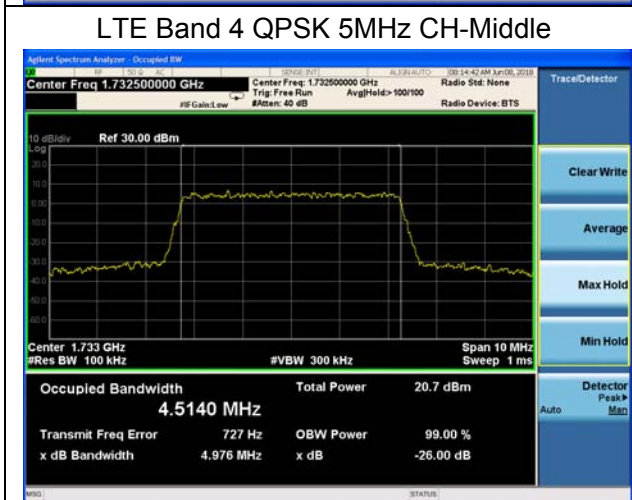
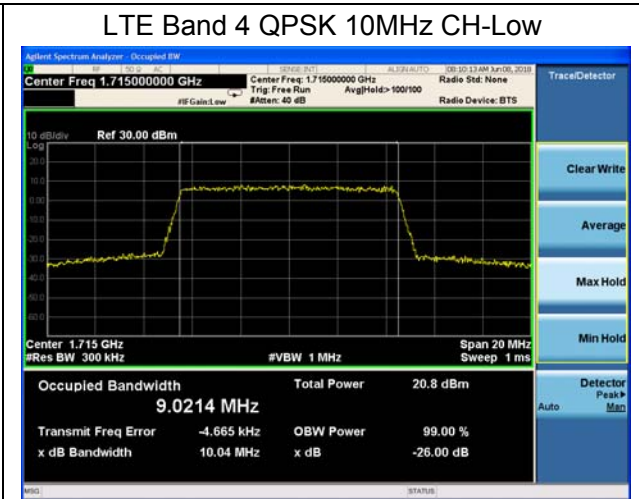
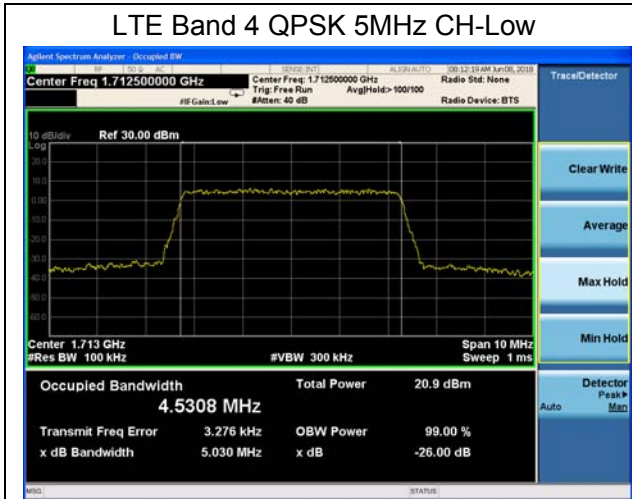

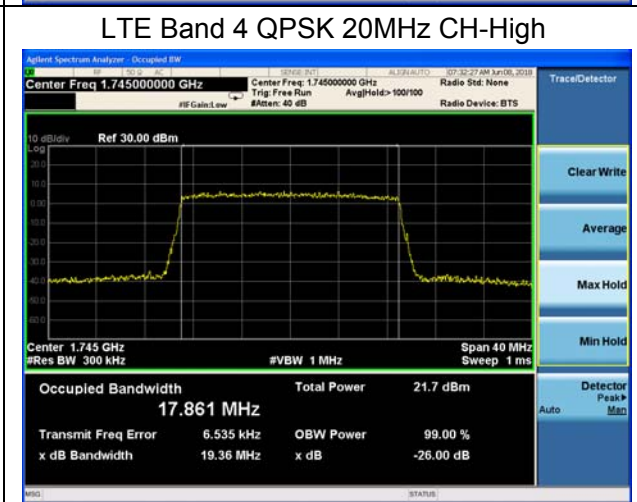
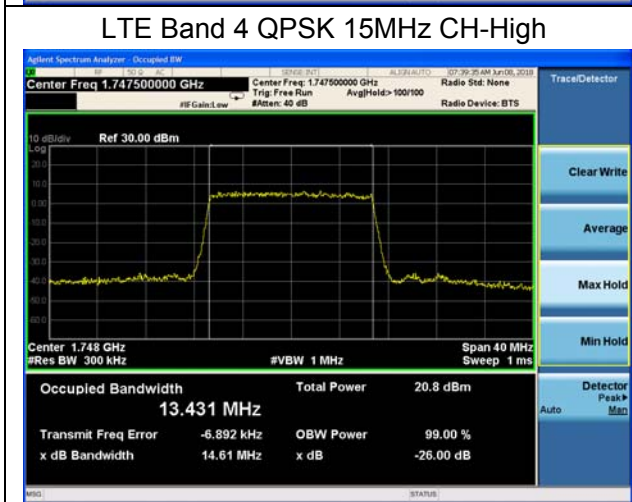
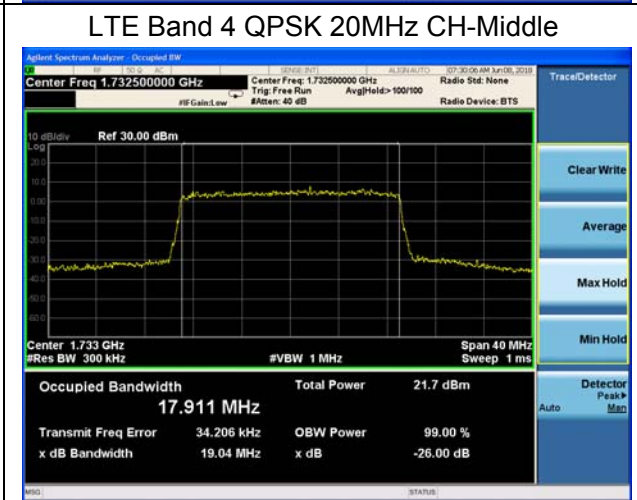
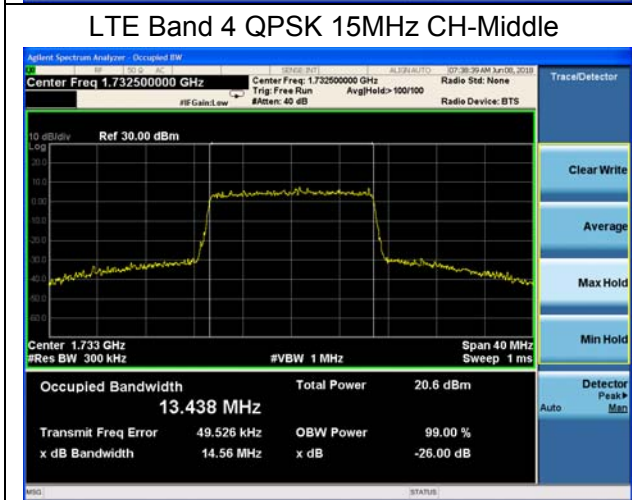
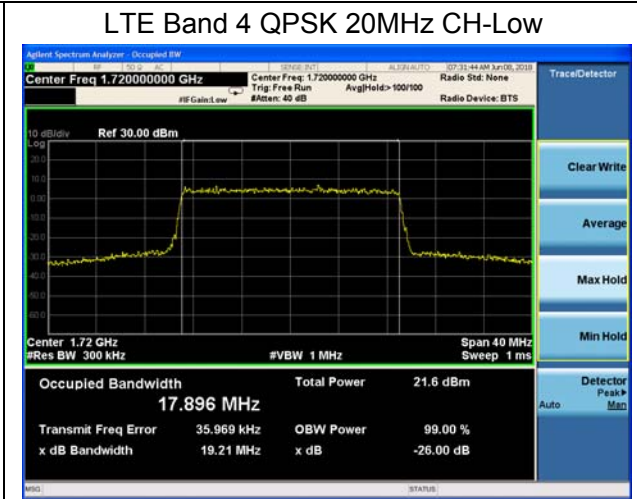
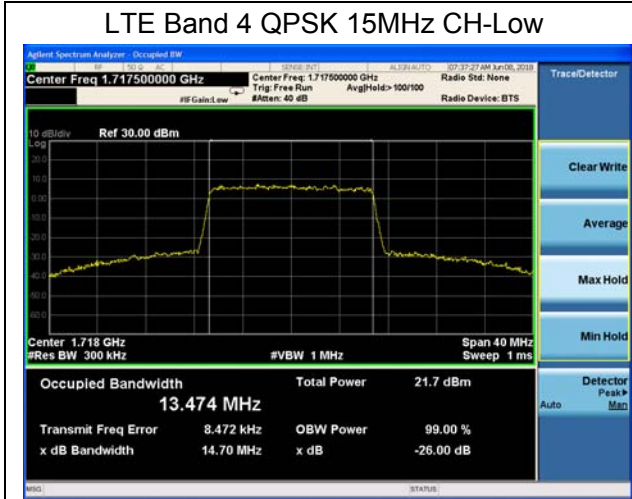

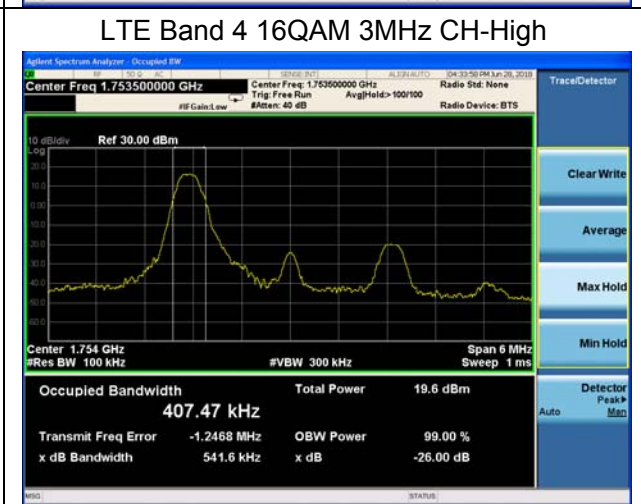
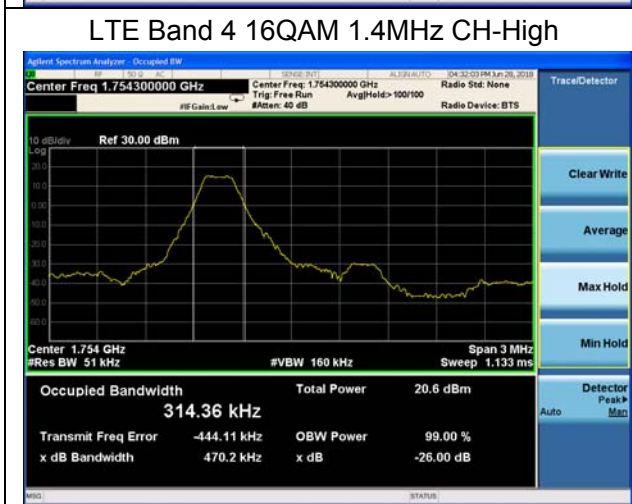
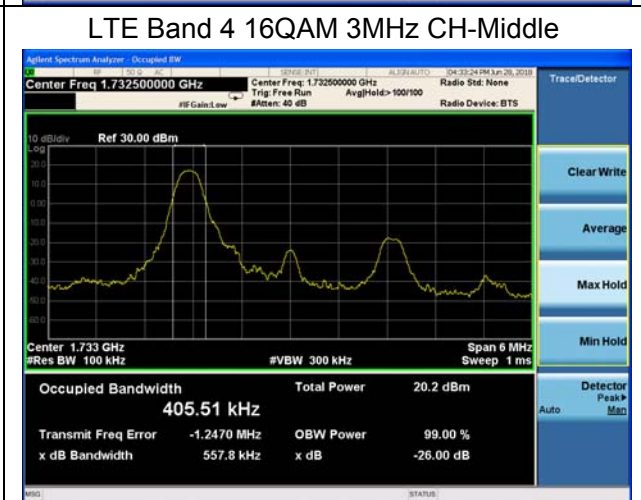
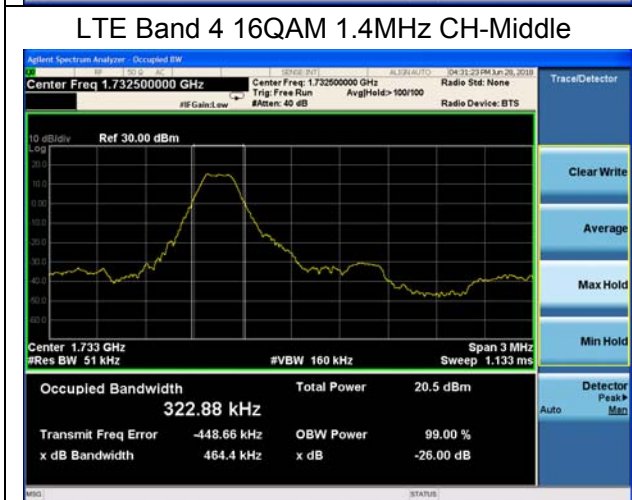
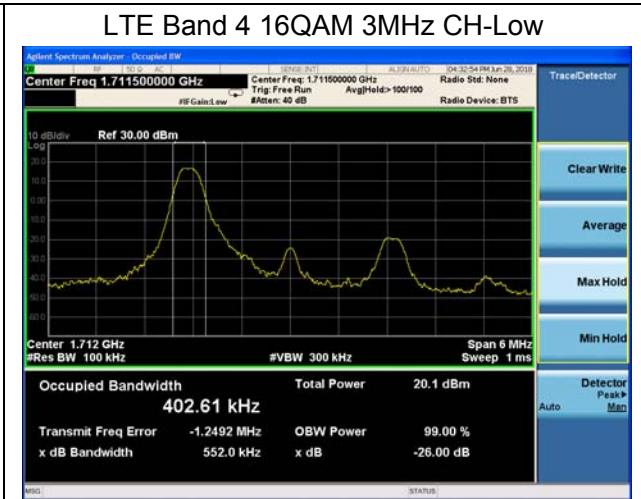
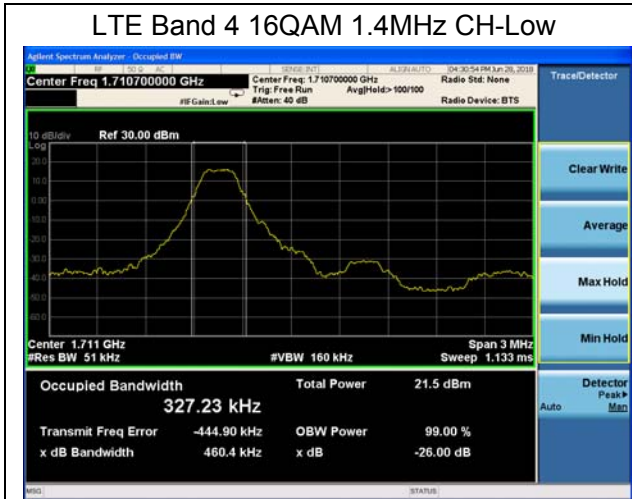

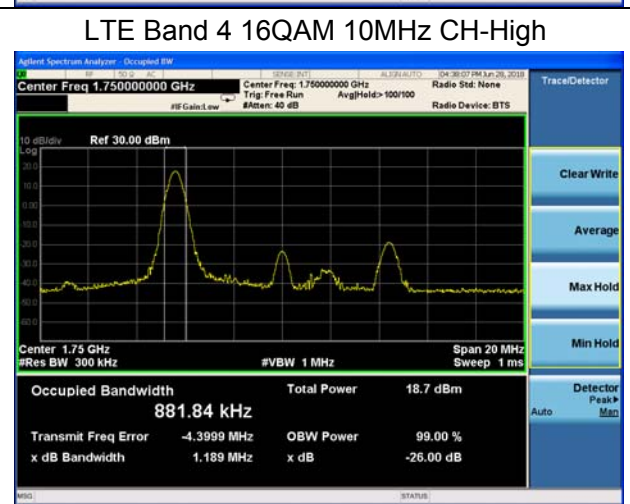
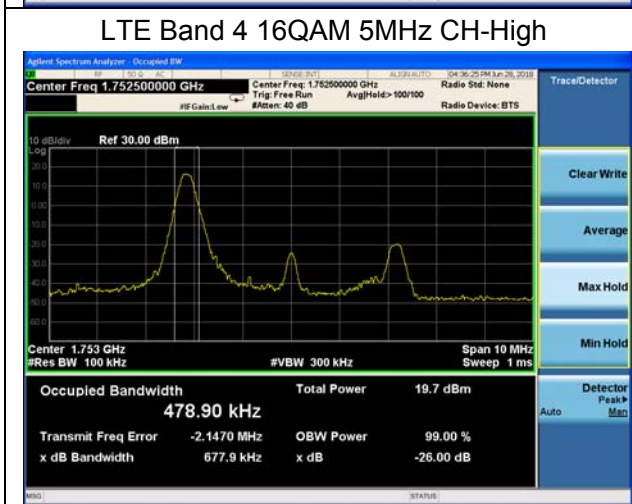
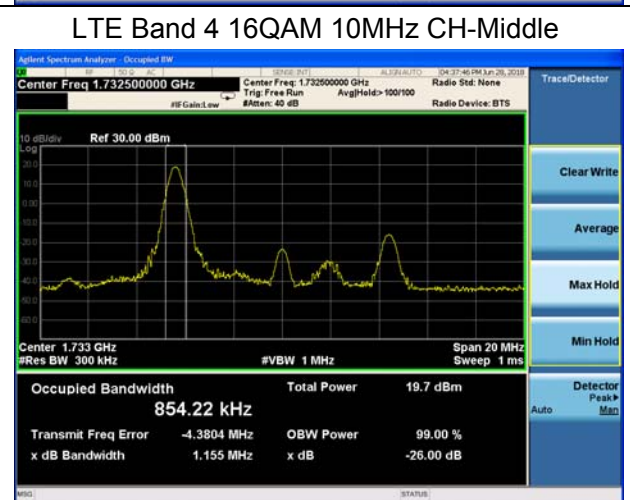
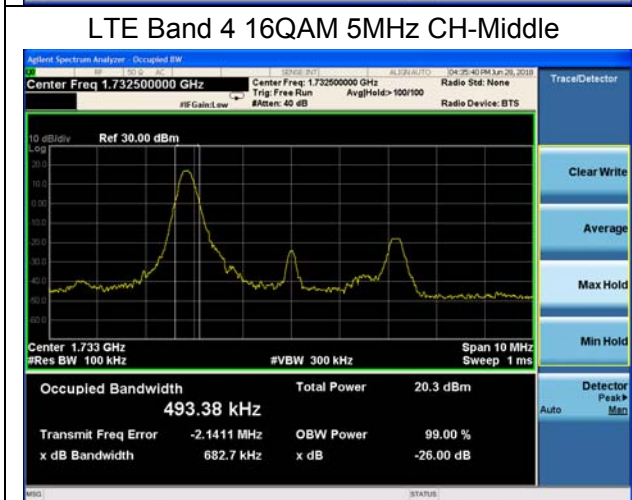
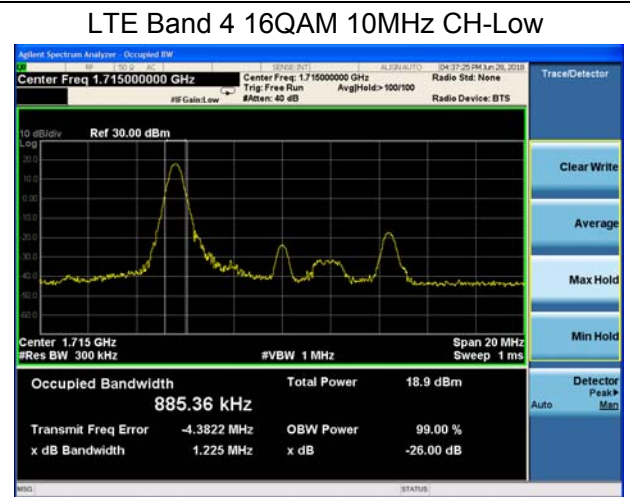
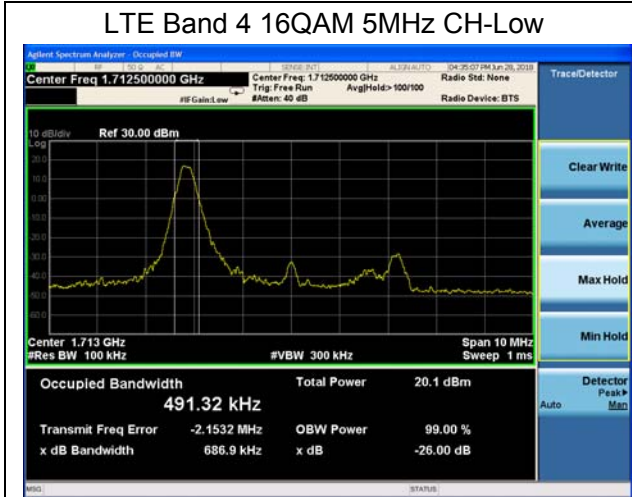

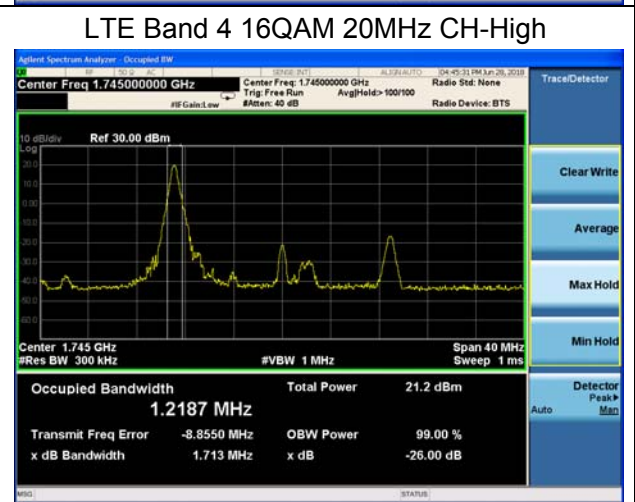
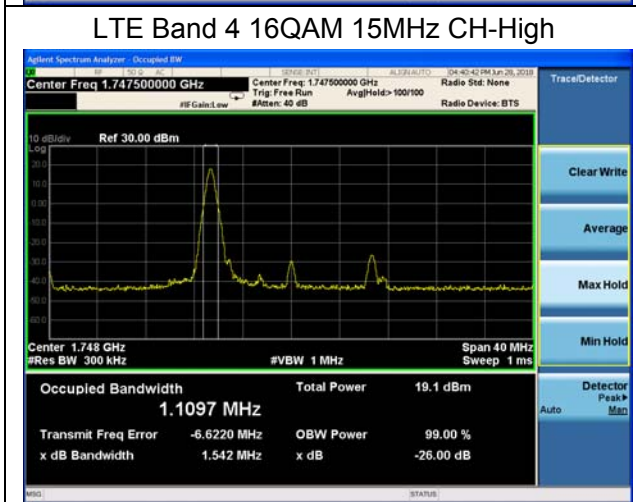
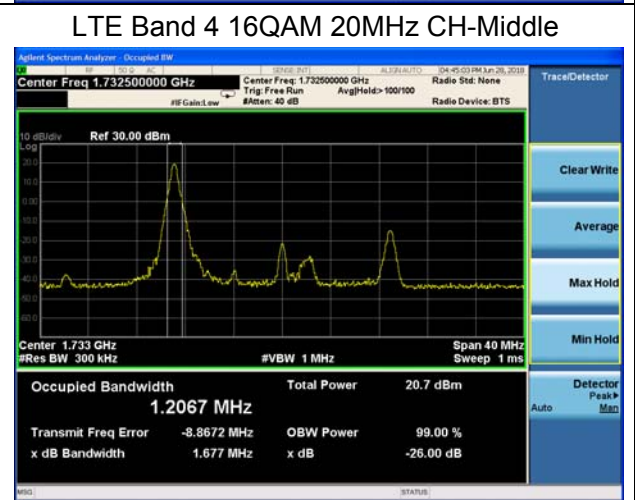
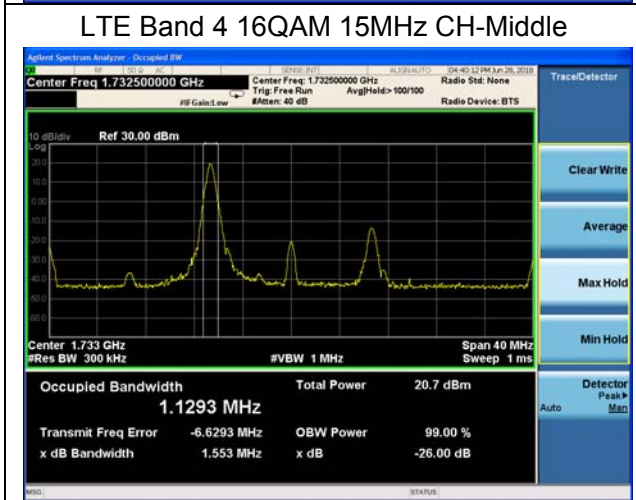
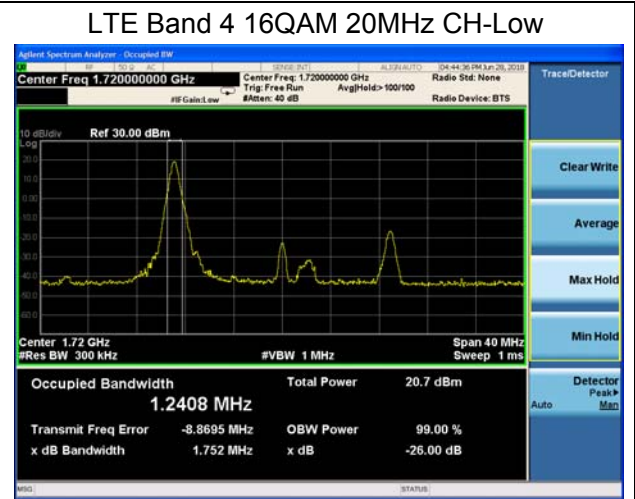
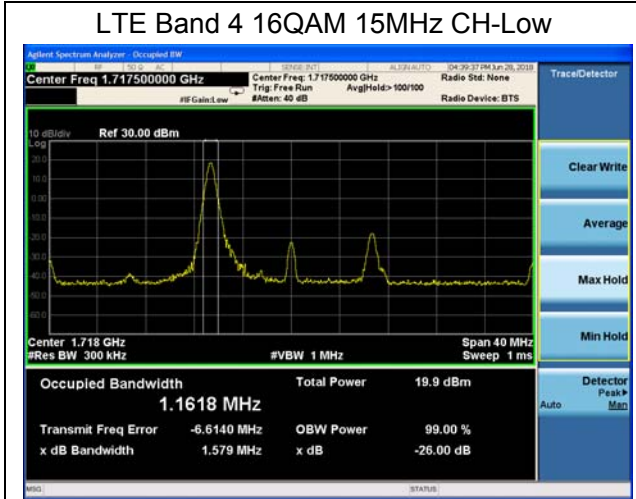

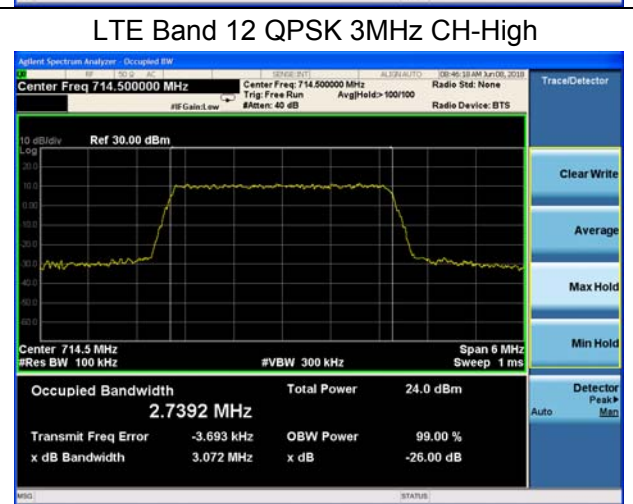
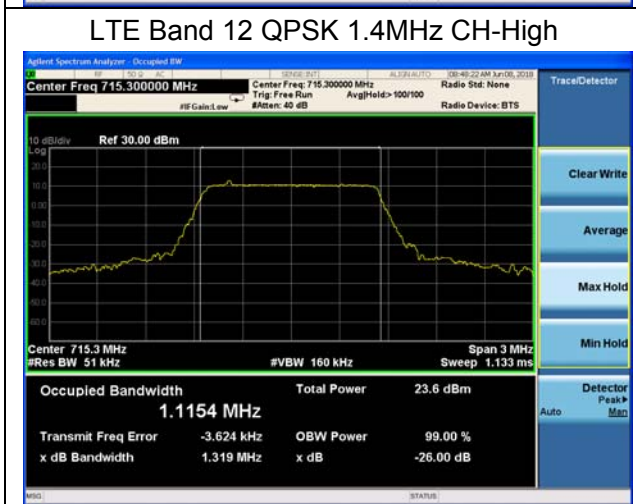
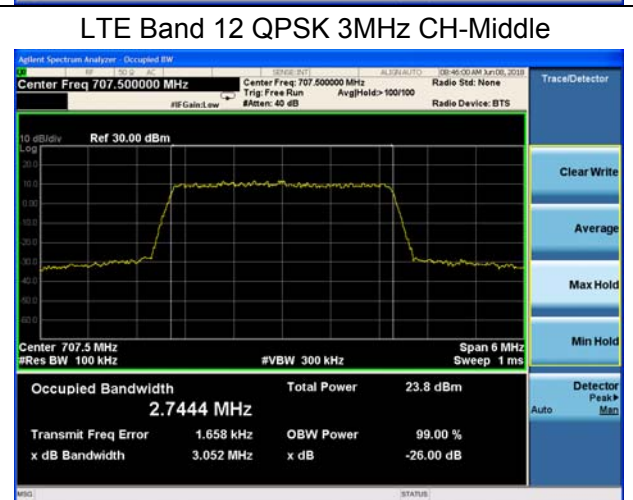
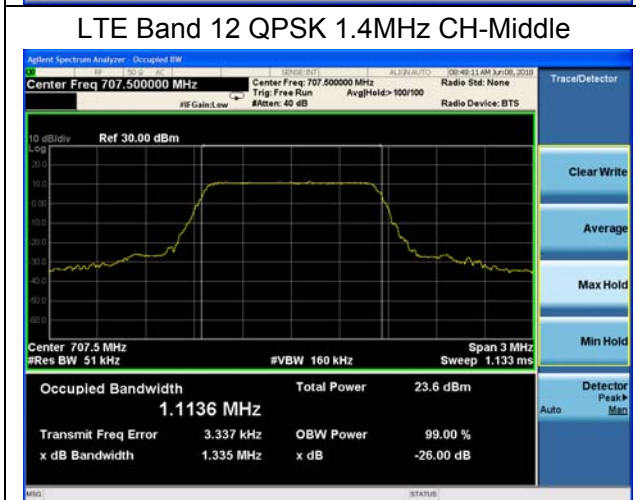
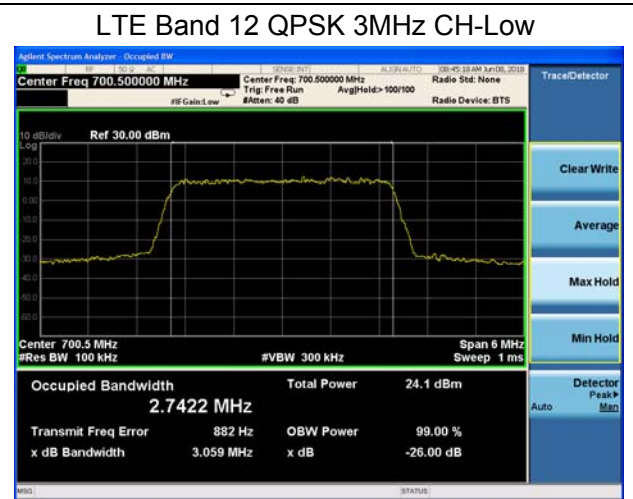
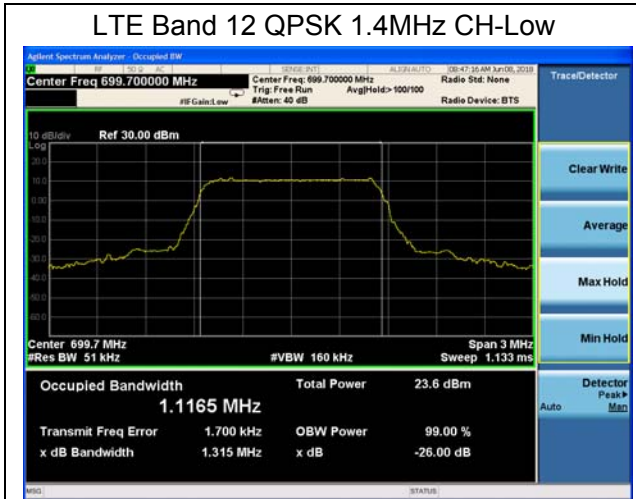



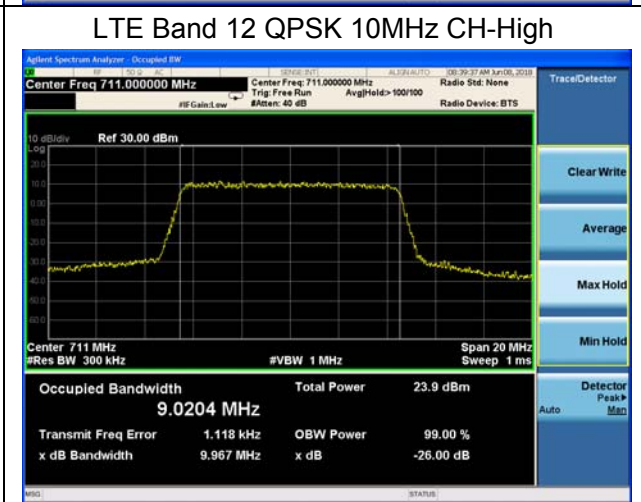
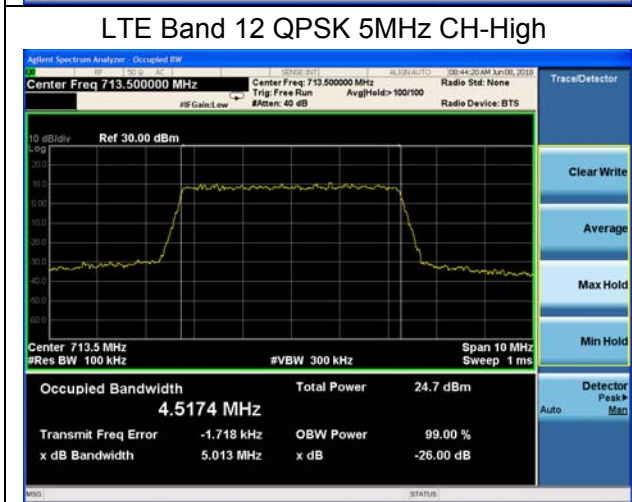
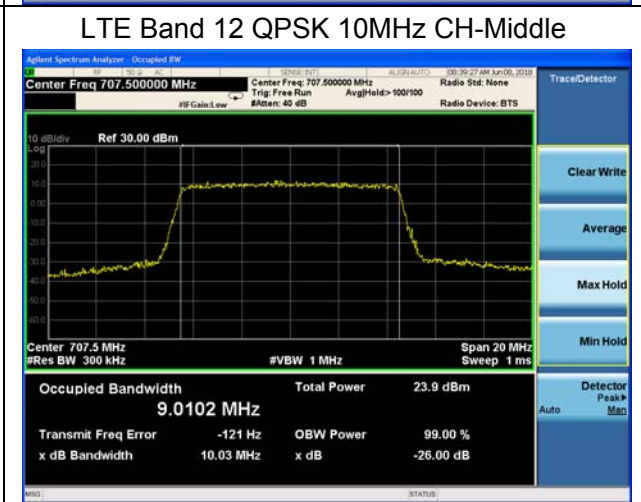
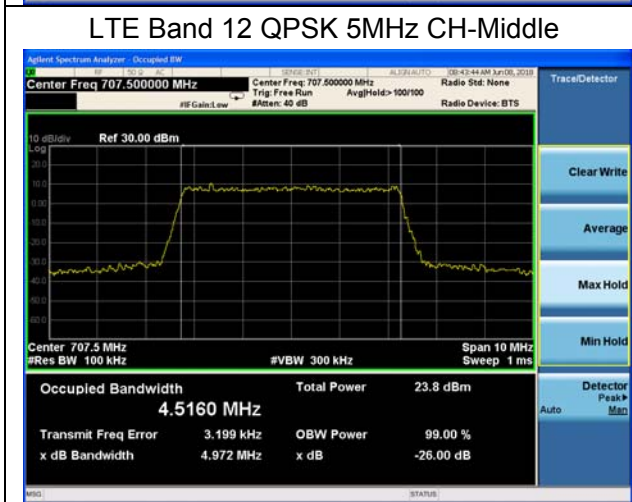
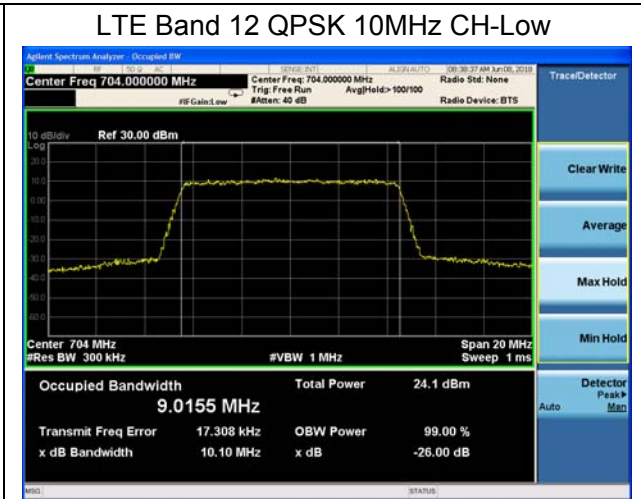
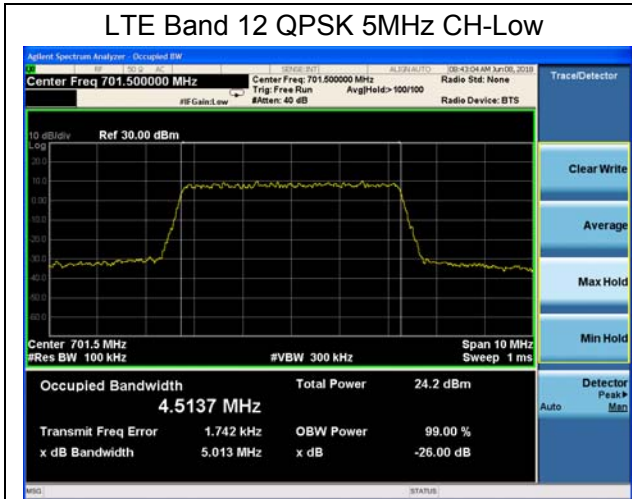

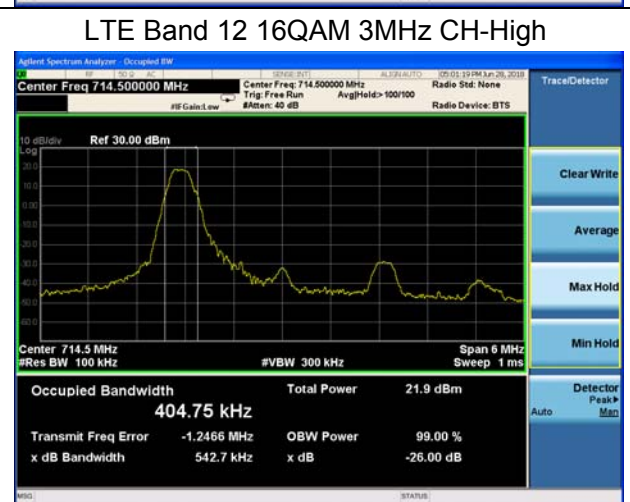
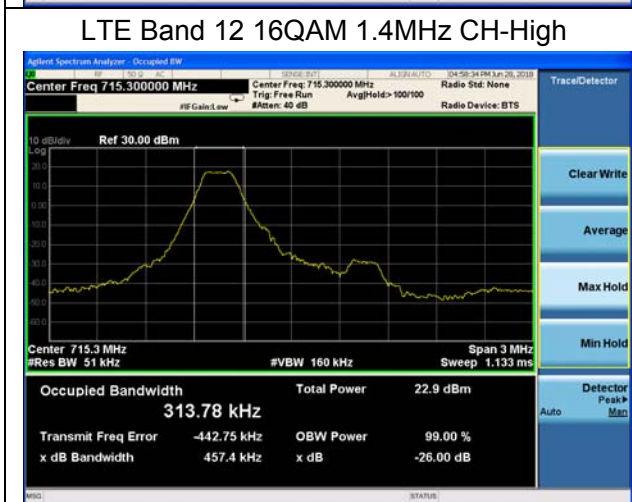
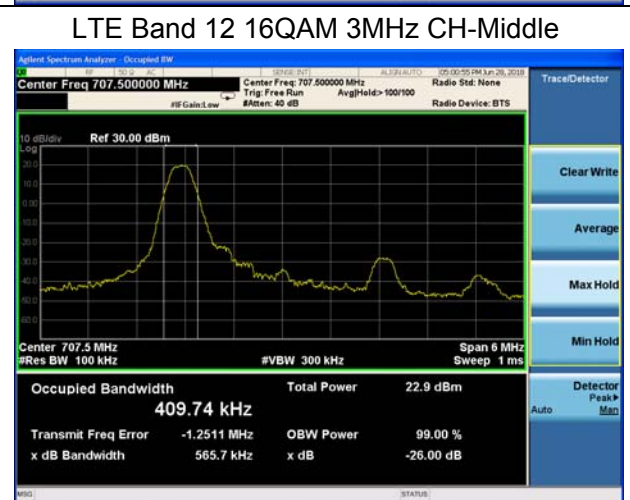
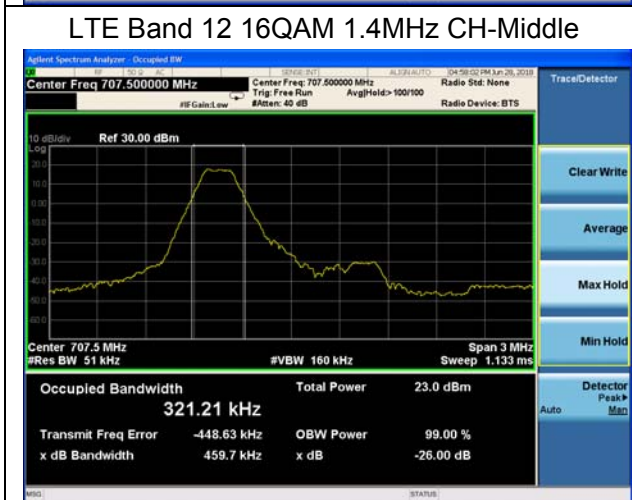
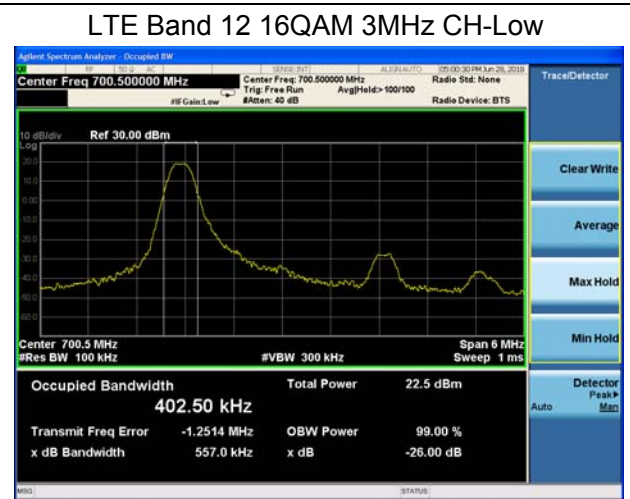
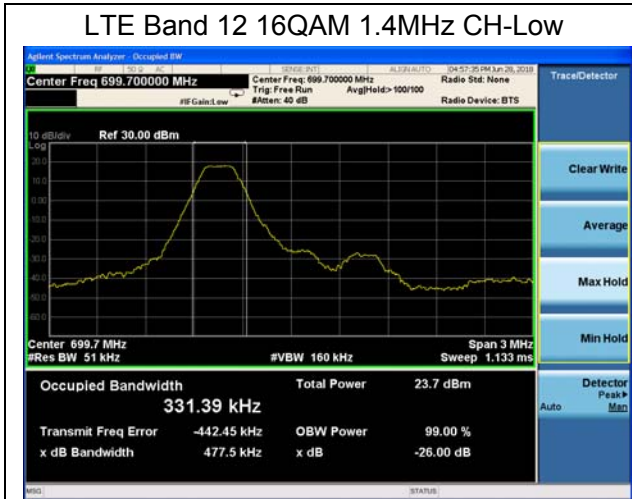

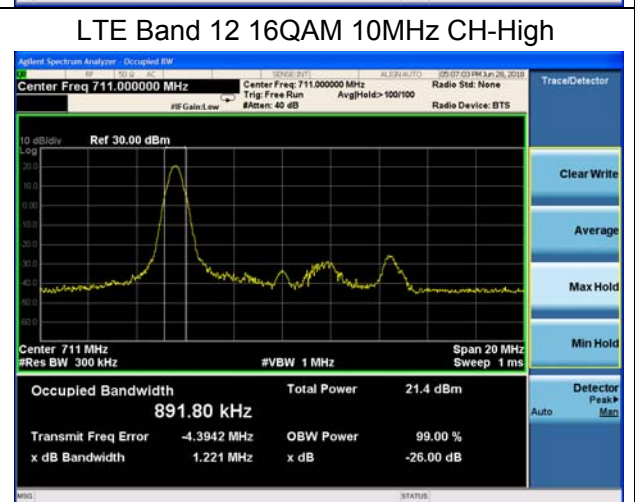
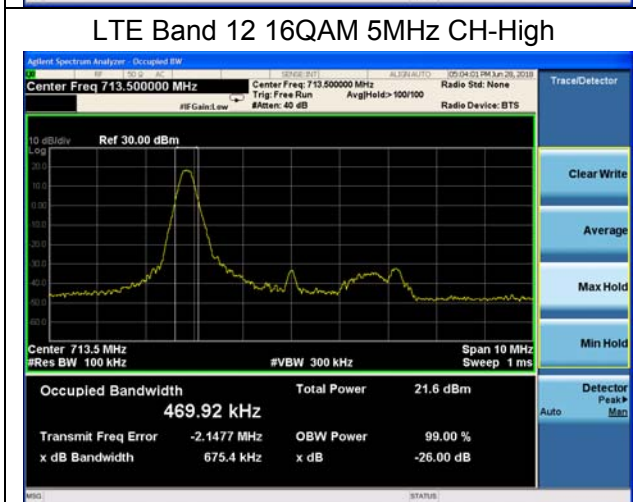
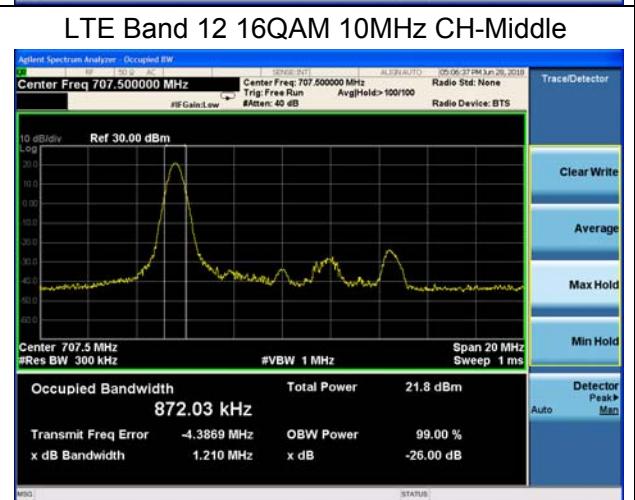
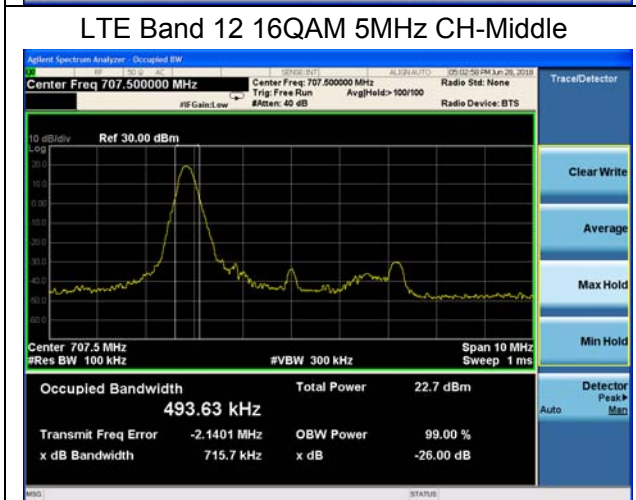
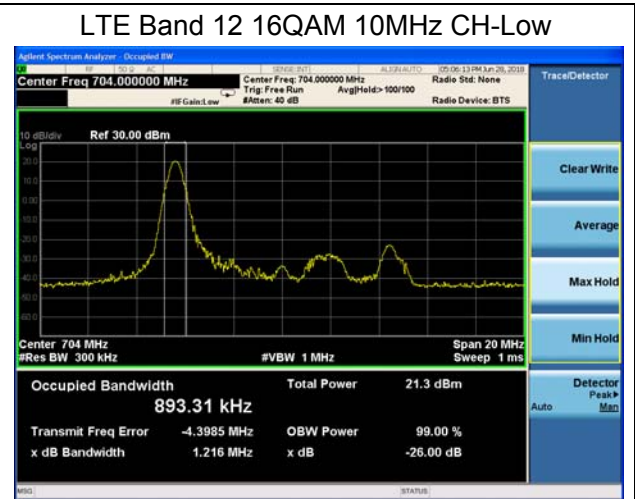
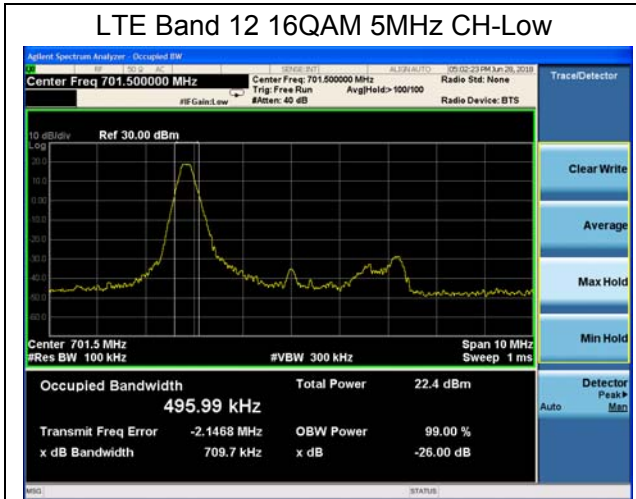



LTE Band 13 QPSK 5MHz CH-Low

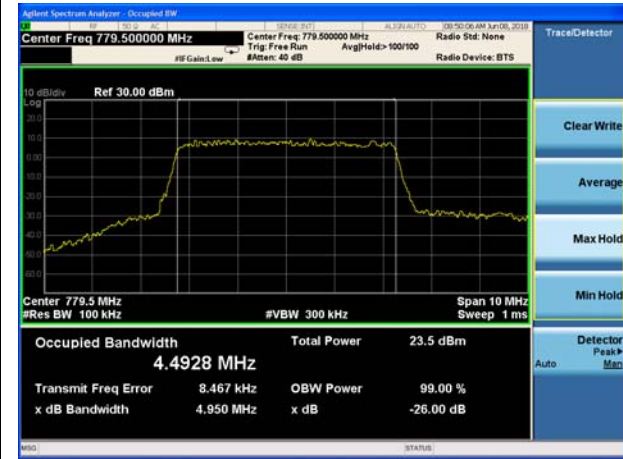

LTE Band 13 16QAM 5MHz CH-Low

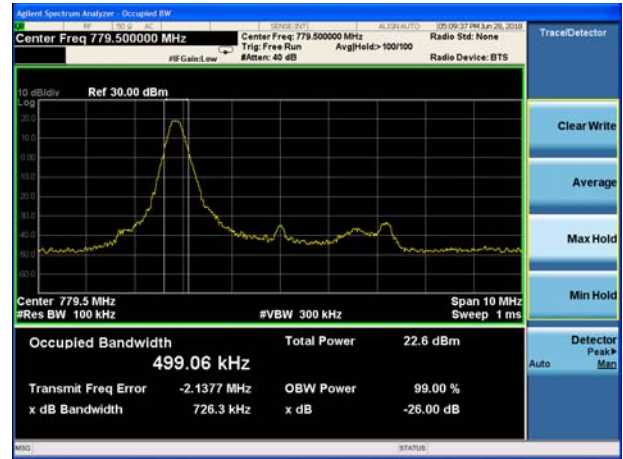

LTE Band 13 QPSK 5MHz CH-Middle

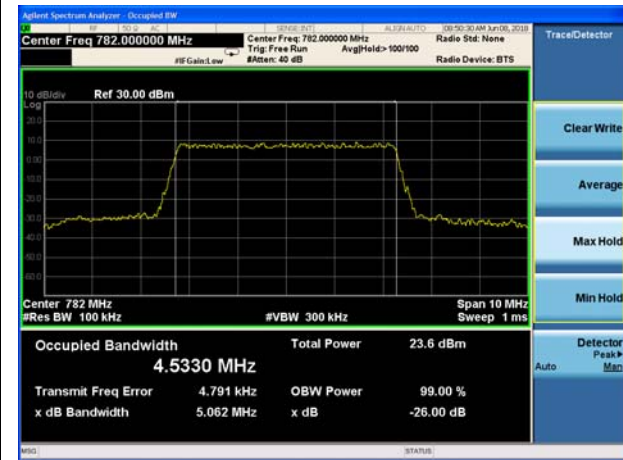

LTE Band 13 16QAM 5MHz CH-Middle

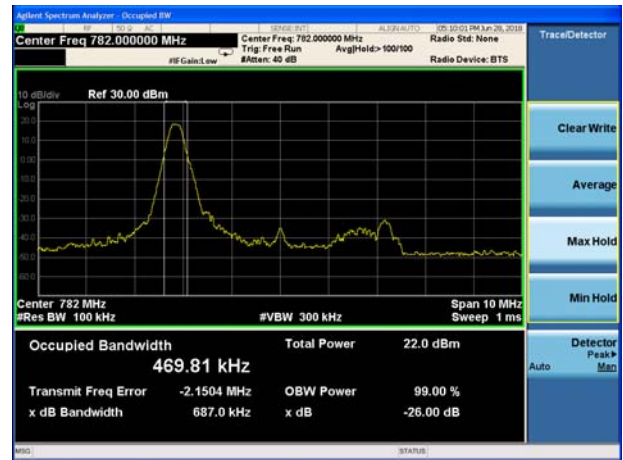

LTE Band 13 QPSK 5MHz CH-High

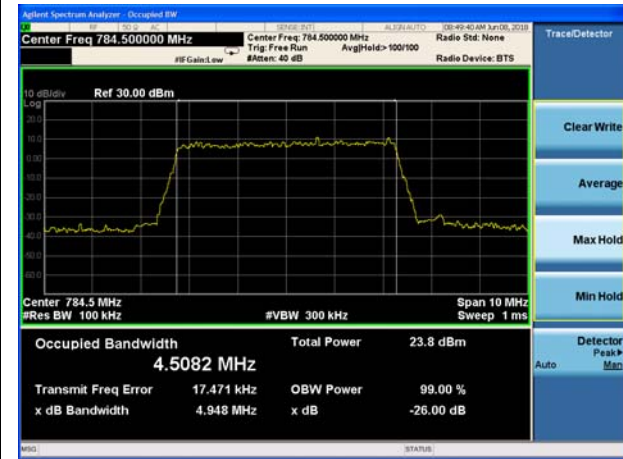

LTE Band 13 16QAM 5MHz CH-High

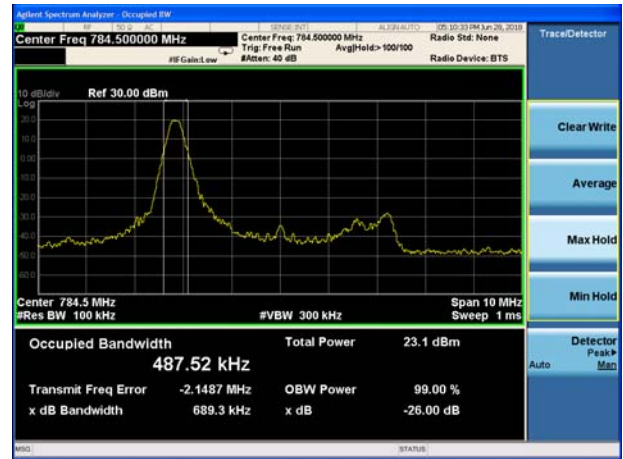

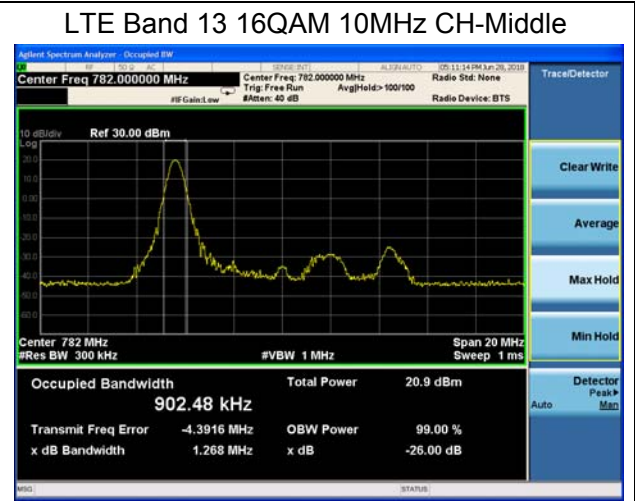
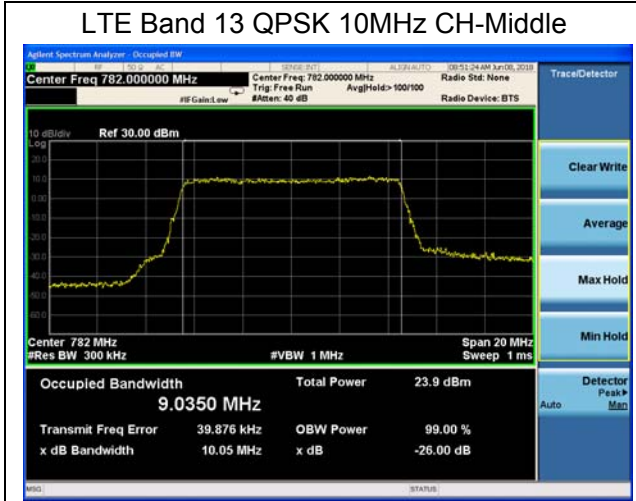

### 5.4 Band Edge Compliance

#### Ambient condition

Temperature	Relative humidity	Pressure
23°C ~25°C	45%~50%	101.5kPa

#### Method of Measurement

The EUT was connected to Spectrum Analyzer and Base Station Simulator via power Splitter. The band edge of the lowest and highest channels were measured.

The testing follows KDB 971168 D01 v03r01 Section 6.0

- 1.The EUT was connected to spectrum analyzer and system simulator via a power divider.
2. The band edges of low and high channels for the highest RF powers were measured.
3. RBW is set to 51 kHz, VBW is set to 160 kHz for WCDMA Band IV.  
RBW is set to 30 kHz, VBW is set to 100 kHz for LTE Band 4 (1.4MHz/ 3MHz).  
RBW is set to 51 kHz, VBW is set to 160 kHz for LTE Band 4 (5MHz).  
RBW is set to 100 kHz, VBW is set to 300kHz for LTE Band 4 (10MHz).  
RBW is set to 150 kHz, VBW is set to 510 kHz for LTE Band 4(15MHz).  
RBW is set to 200 kHz, VBW is set to 620 kHz for LTE Band 4(20MHz)  
RBW is set to 100 kHz, VBW is set to 300kHz for LTE Band 12(1.4MHz/3MHz/5MHz/10MHz).  
on spectrum analyzer.
4. Set spectrum analyzer with RMS detector.
5. The RF fundamental frequency should be excluded against the limit line in the operating frequency band.
6. Checked that all the results comply with the emission limit line.

#### Test Setup

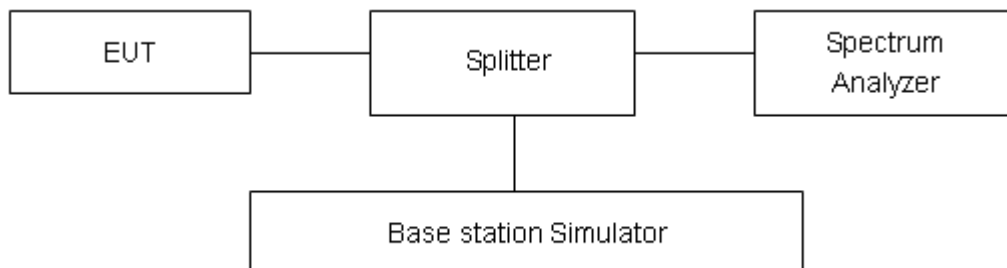

#### Limits

Rule Part 27.53(h)/ specifies that “ for operations in the 1695-1710 MHz, 1710-1755 MHz, 1755-1780 MHz, 1915-1920 MHz, 1995-2000 MHz, 2000-2020 MHz, 2110-2155 MHz, 2155-2180 MHz, and 2180-2200 bands, the power of any emission outside a licensee's frequency block shall be

attenuated below the transmitter power (P) in watts by at least  $43 + 10 \log_{10} (P)$  dB”

Part 27.53(g) For operations in the 600 MHz band and the 698-746 MHz band, the power of any emission outside a licensee's frequency band(s) of operation shall be attenuated below the transmitter power (P) within the licensed band(s) of operation, measured in watts, by at least  $43 + 10 \log (P)$  dB. Compliance with this provision is based on the use of measurement instrumentation employing a resolution bandwidth of 100 kilohertz or greater. However, in the 100 kilohertz bands immediately outside and adjacent to a licensee's frequency block, a resolution bandwidth of at least 30 kHz may be employed.

Rule Part 27.53(f) For operations in the 746-758 MHz, 775-788 MHz, and 805-806 MHz bands, emissions in the band 1559-1610 MHz shall be limited to  $-70$  dBW/MHz equivalent isotropically radiated power (EIRP) for wideband signals, and  $-80$  dBW EIRP for discrete emissions of less than 700 Hz bandwidth. For the purpose of equipment authorization, a transmitter shall be tested with an antenna that is representative of the type that will be used with the equipment in normal operation.

Part 27.53 (c) For operations in the 746-758 MHz band and the 776-788 MHz band, the power of any emission outside the licensee's frequency band(s) of operation shall be attenuated below the transmitter power (P) within the licensed band(s) of operation, measured in watts, in accordance with the following:

- (1) On any frequency outside the 746-758 MHz band, the power of any emission shall be attenuated outside the band below the transmitter power (P) by at least  $43 + 10 \log (P)$  dB;
- (2) On any frequency outside the 776-788 MHz band, the power of any emission shall be attenuated outside the band below the transmitter power (P) by at least  $43 + 10 \log (P)$  dB;
- (3) On all frequencies between 763-775 MHz and 793-805 MHz, by a factor not less than  $76 + 10 \log (P)$  dB in a 6.25 kHz band segment, for base and fixed stations;
- (4) On all frequencies between 763-775 MHz and 793-805 MHz, by a factor not less than  $65 + 10 \log (P)$  dB in a 6.25 kHz band segment, for mobile and portable stations;
- (5) Compliance with the provisions of paragraphs (c)(1) and (c)(2) of this section is based on the use of measurement instrumentation employing a resolution bandwidth of 100 kHz or greater. However, in the 100 kHz bands immediately outside and adjacent to the frequency block, a resolution bandwidth of at least 30 kHz may be employed;

### Measurement Uncertainty

The assessed measurement uncertainty to ensure 95% confidence level for the normal distribution is with the coverage factor  $k = 1.96$ ,  $U=0.684$ dB.

**Test Result**

All the test traces in the plots shows the test results clearly.





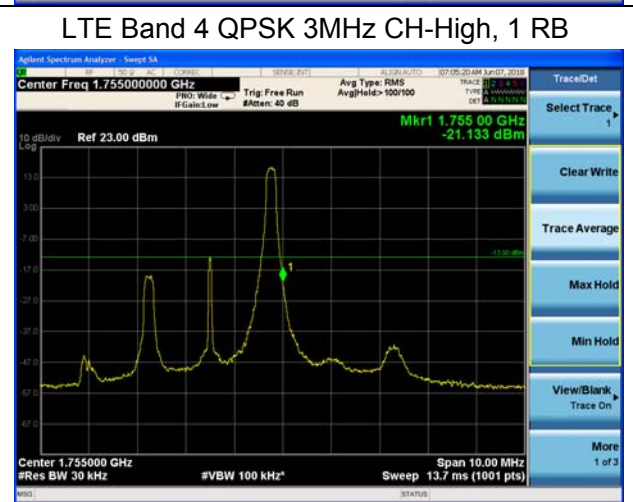
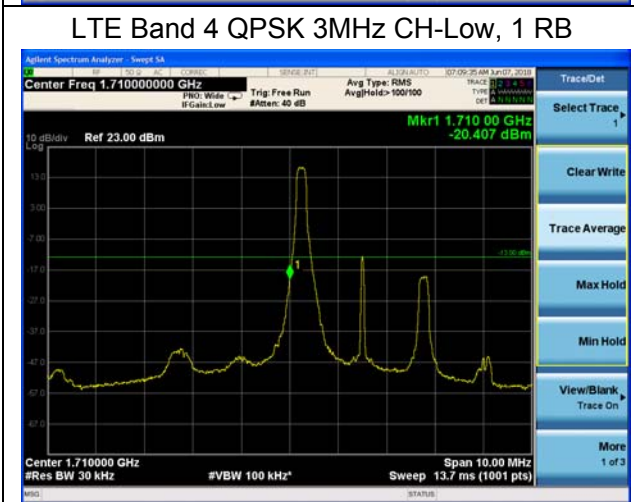
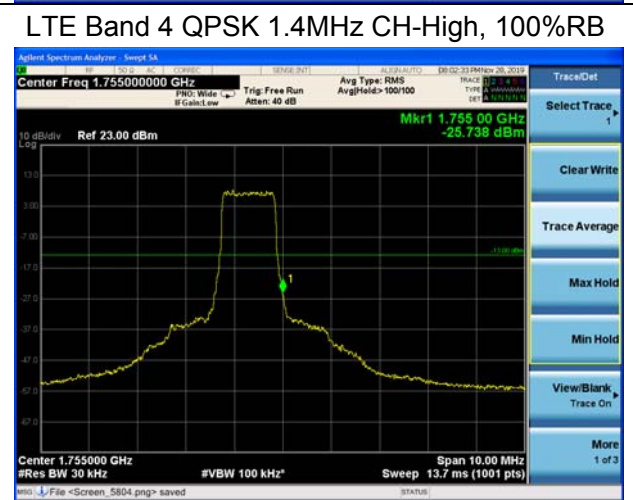
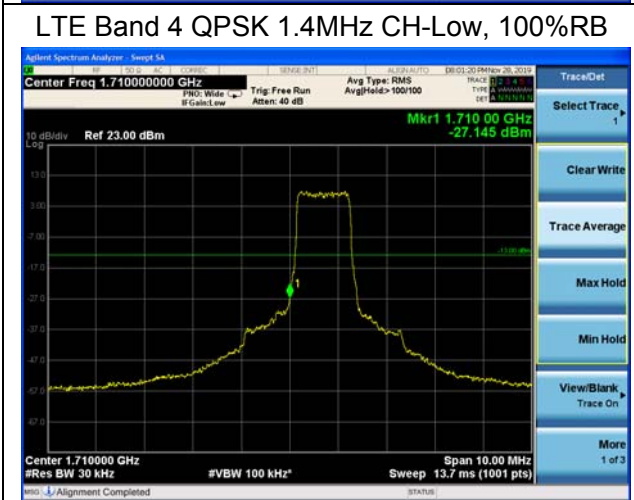
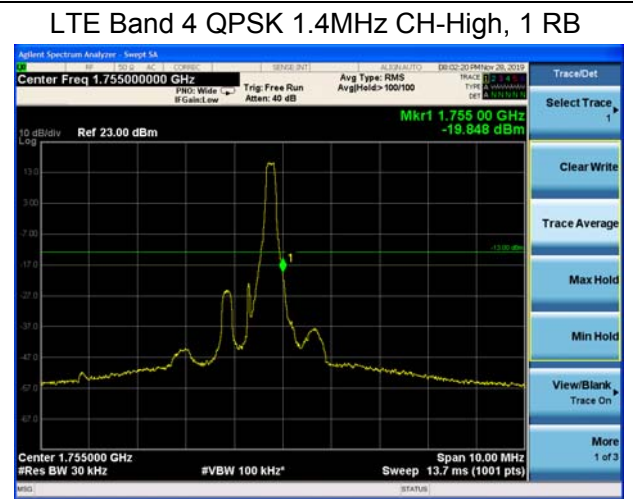
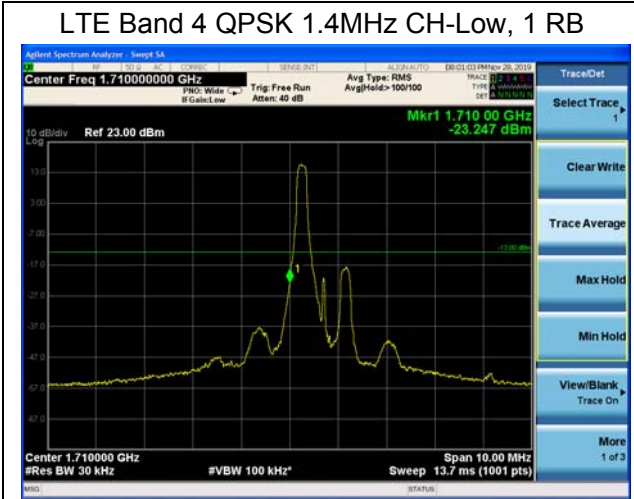

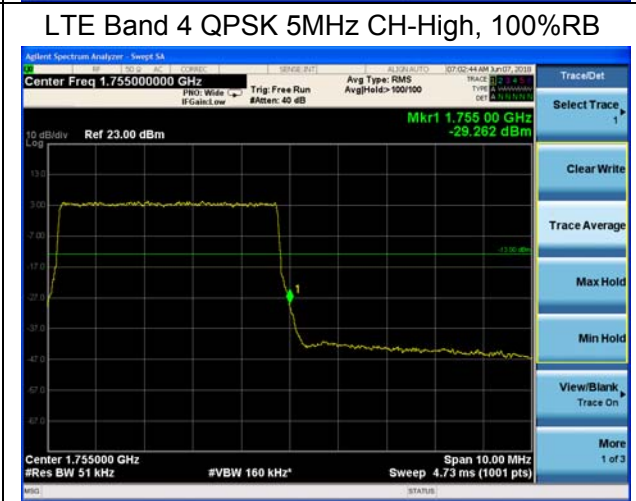
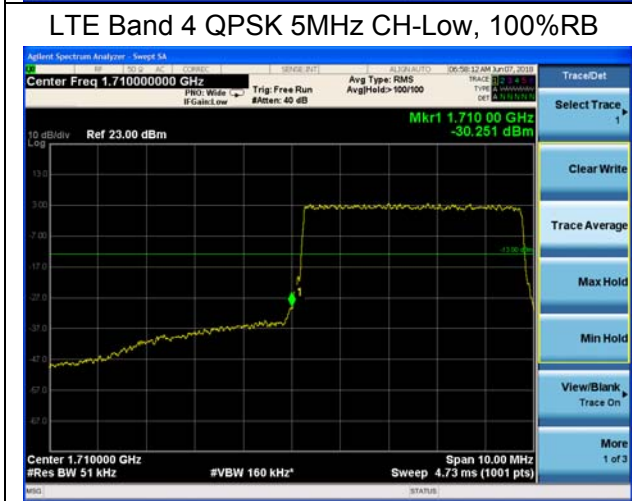
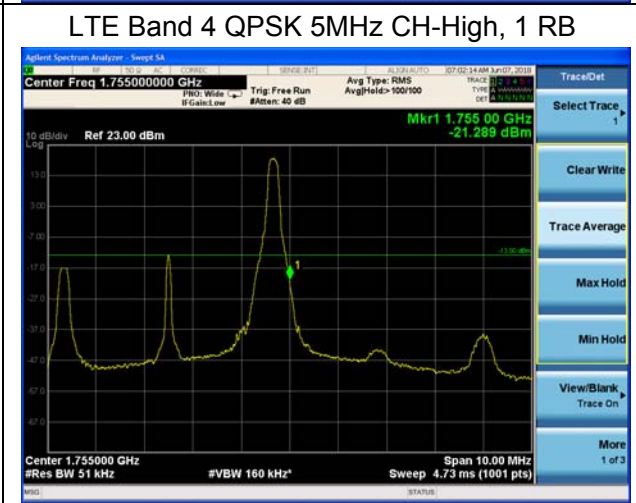
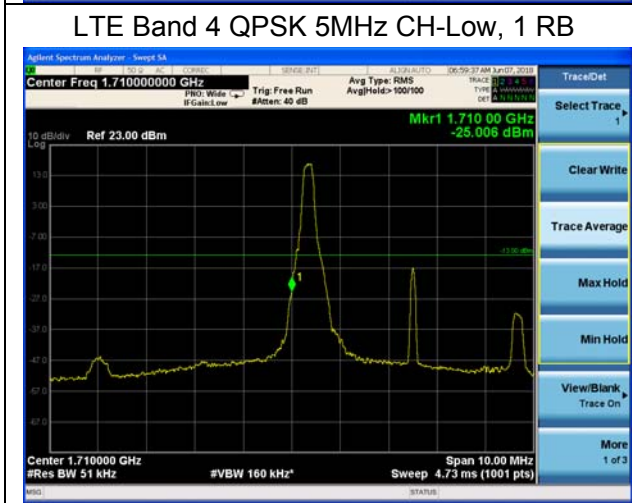
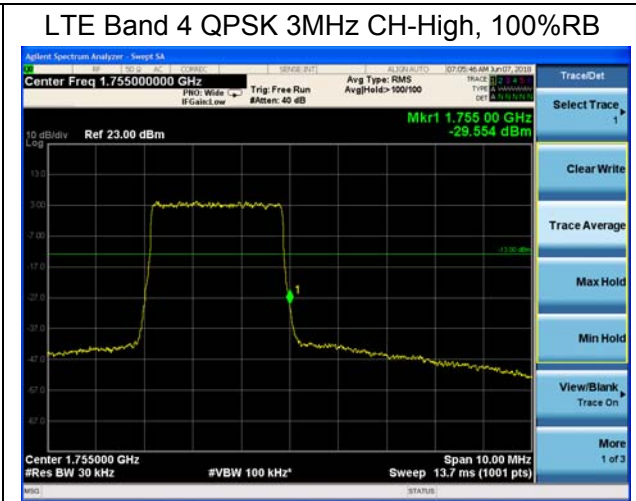
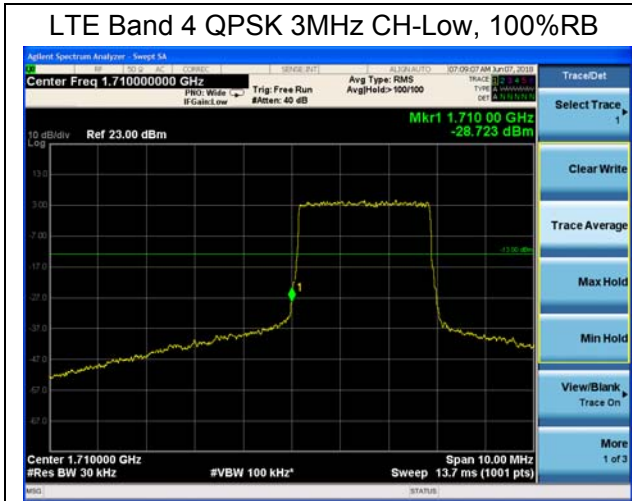

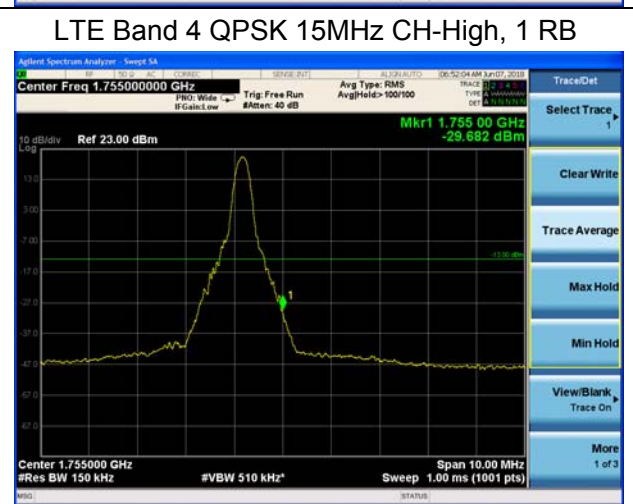
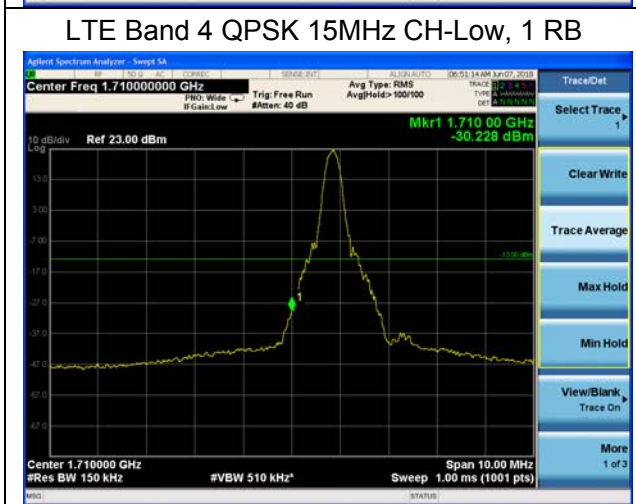
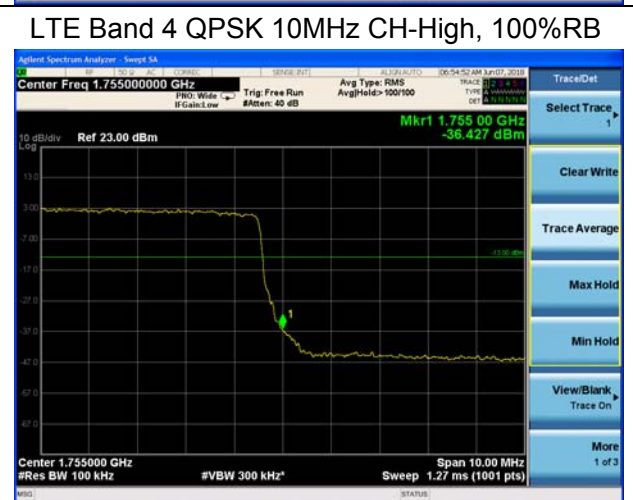
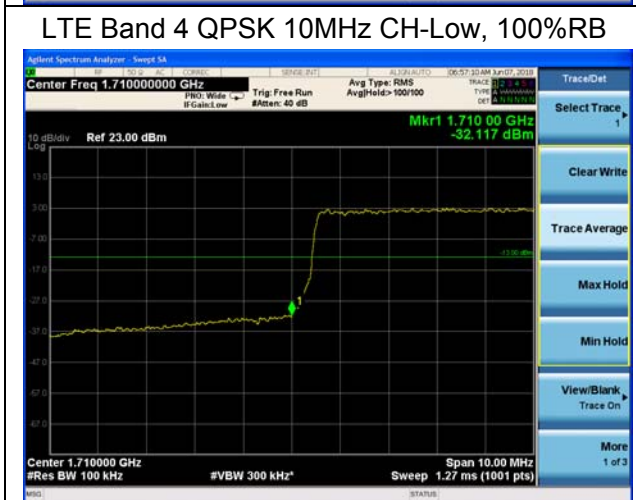
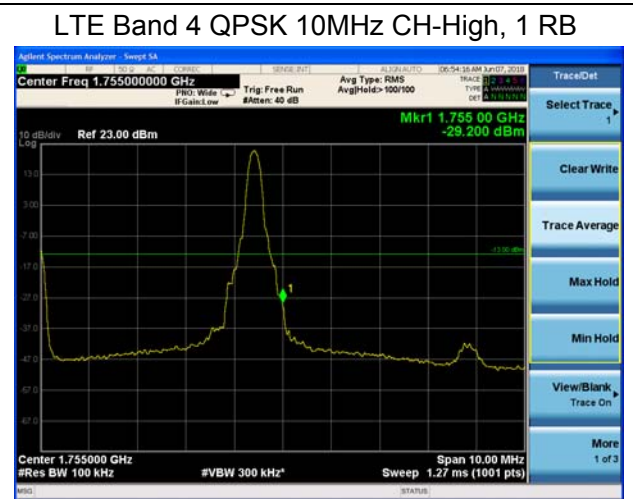
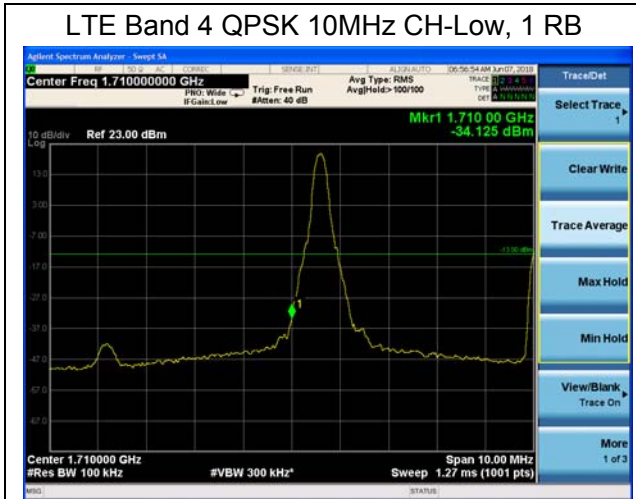



LTE Band 4 QPSK 15MHz CH-Low, 100%RB

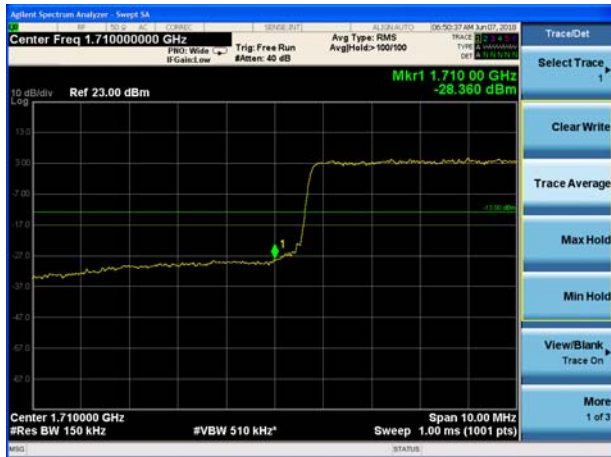

LTE Band 4 QPSK 15MHz CH-High, 100%RB



LTE Band 4 QPSK 20MHz CH-Low, 1 RB

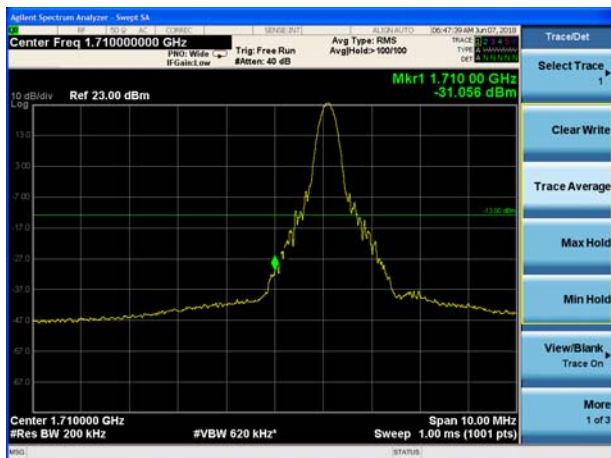

LTE Band 4 QPSK 20MHz CH-High, 1 RB

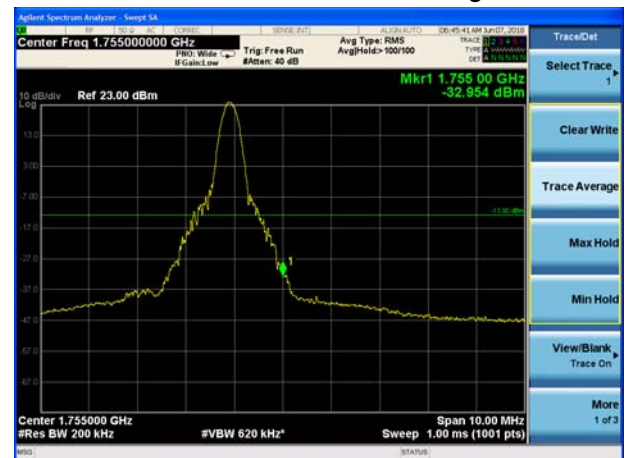

LTE Band 4 QPSK 20MHz CH-Low, 100%RB

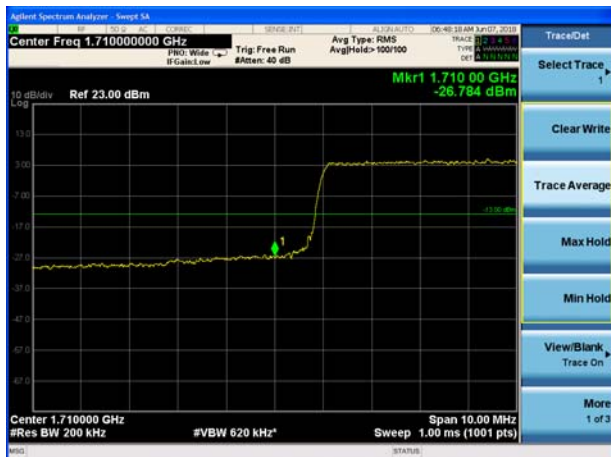

LTE Band 4 QPSK 20MHz CH-High, 100%RB



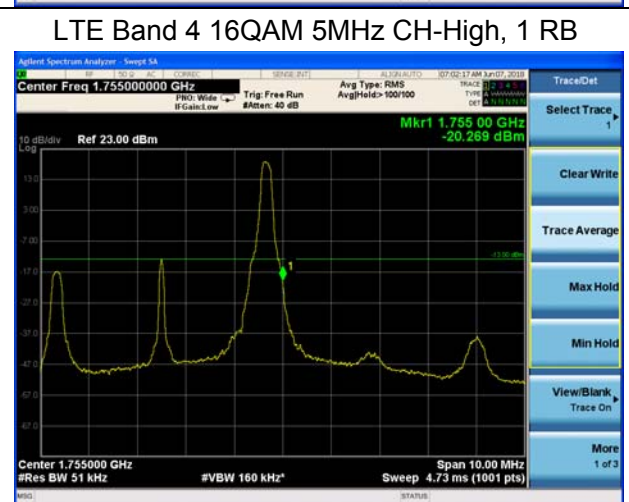
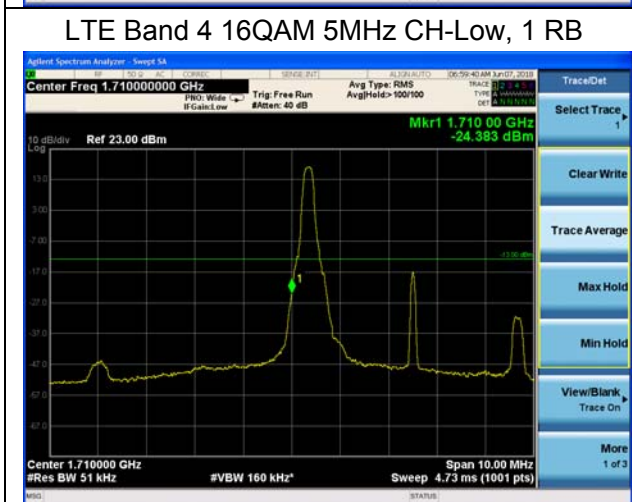
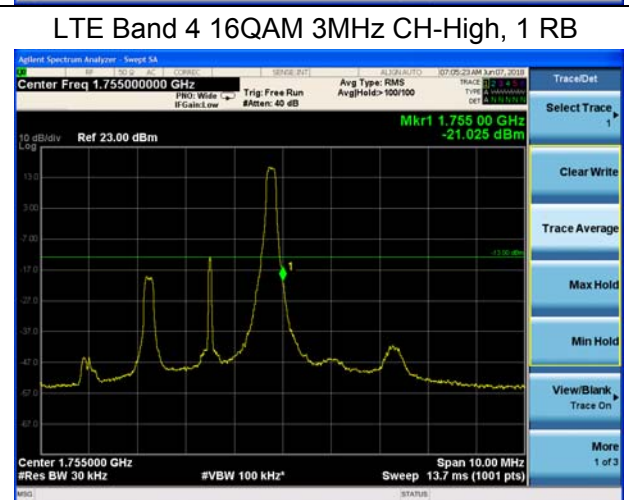
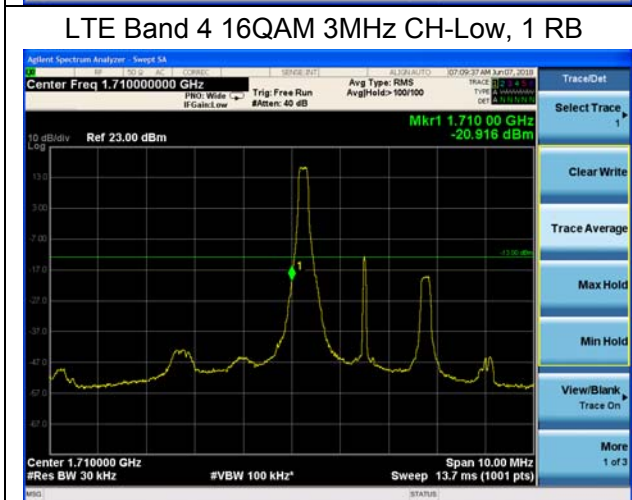
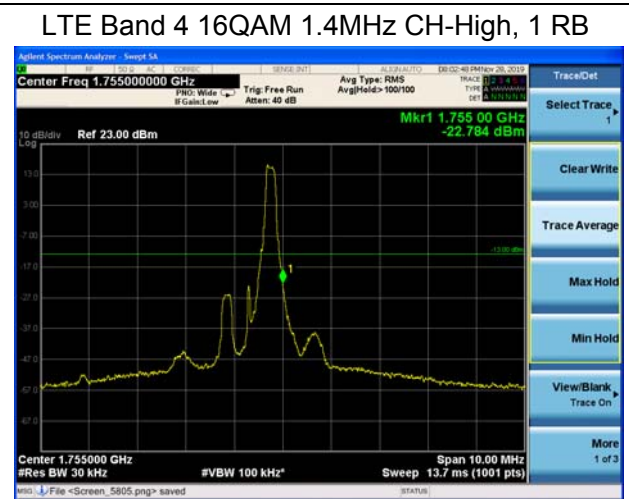
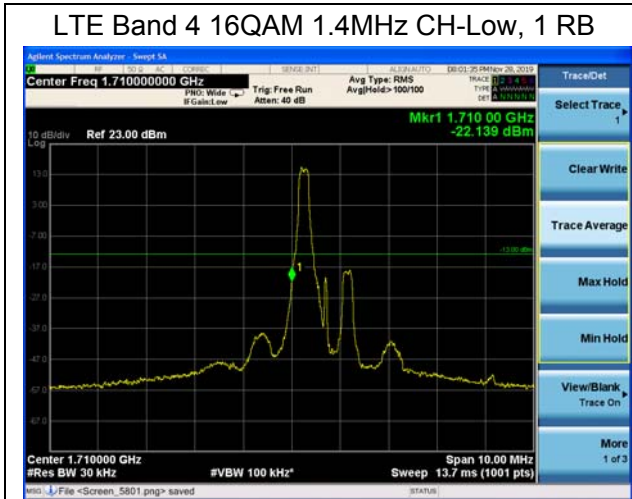

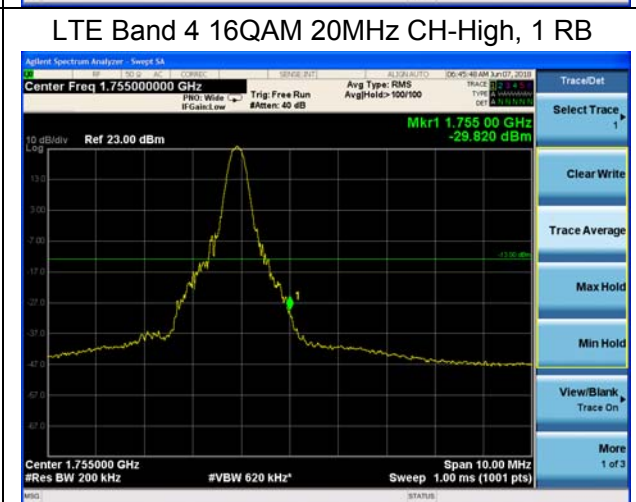
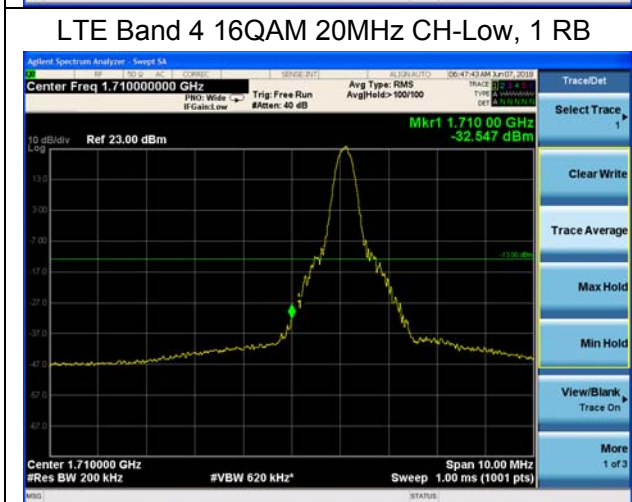
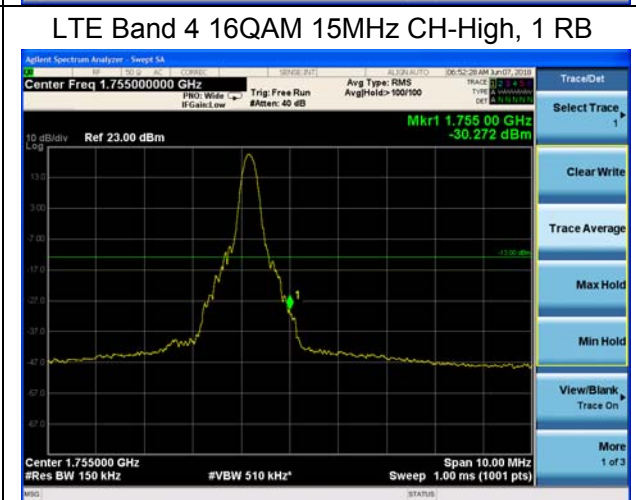
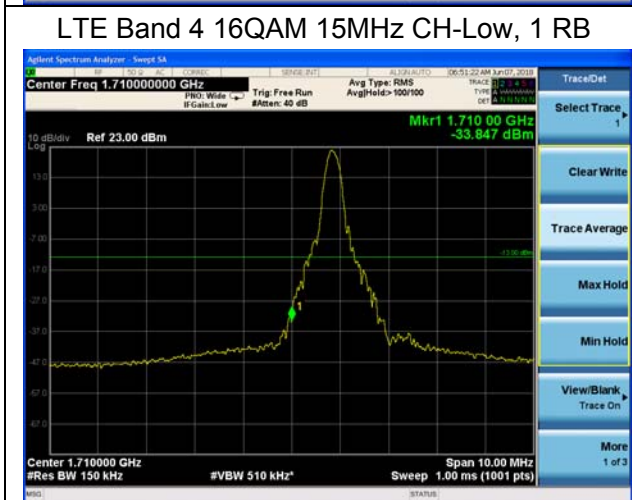
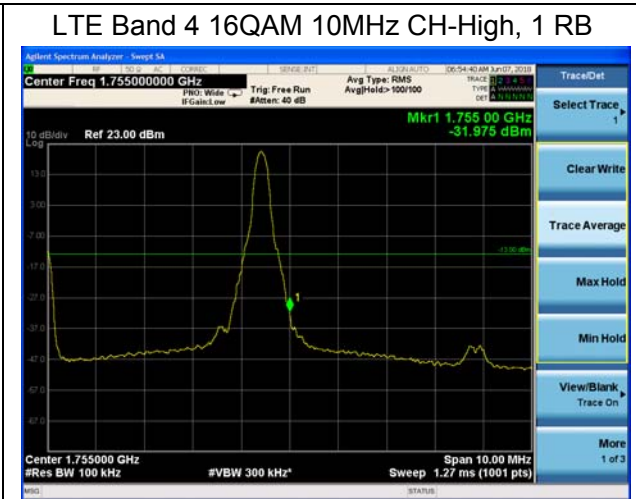
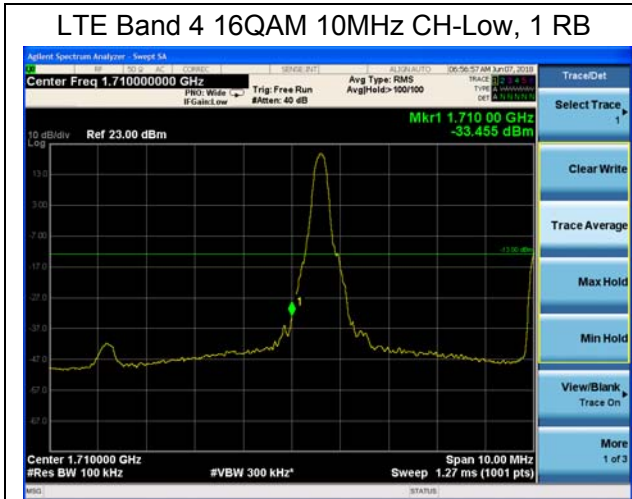

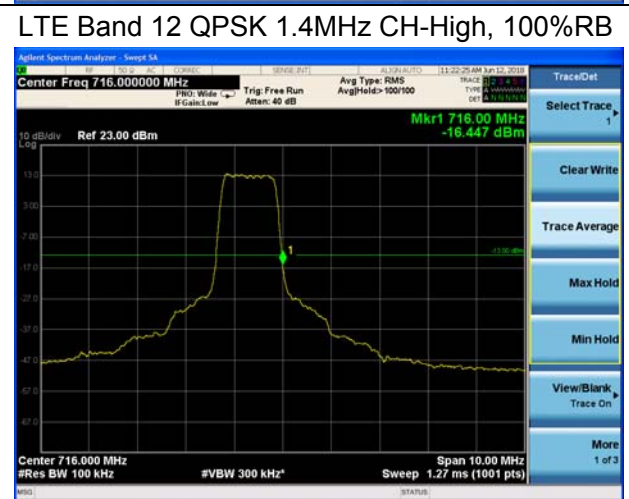
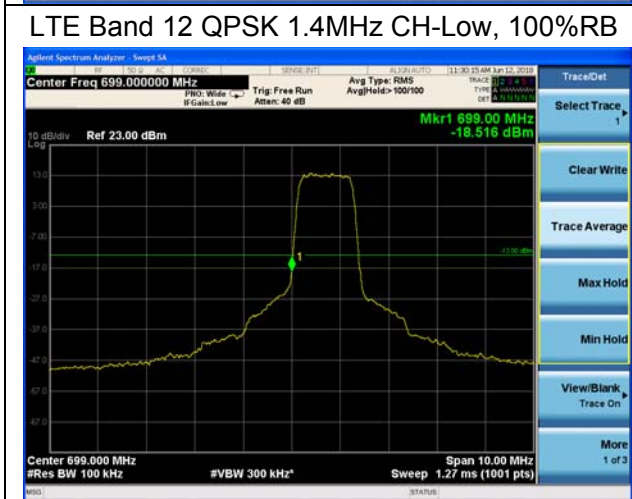
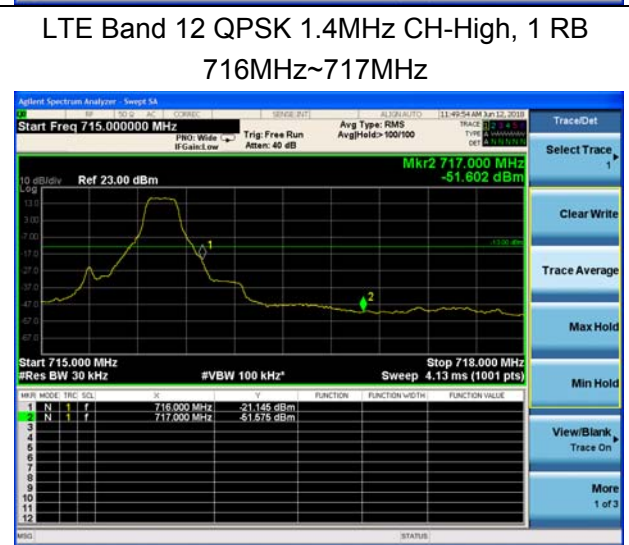
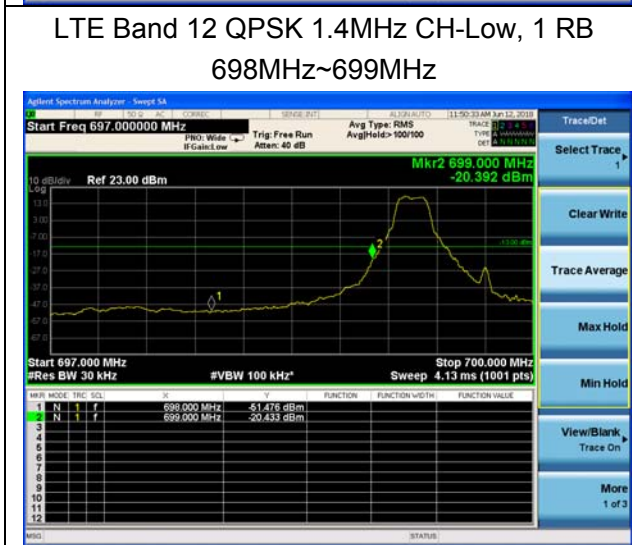
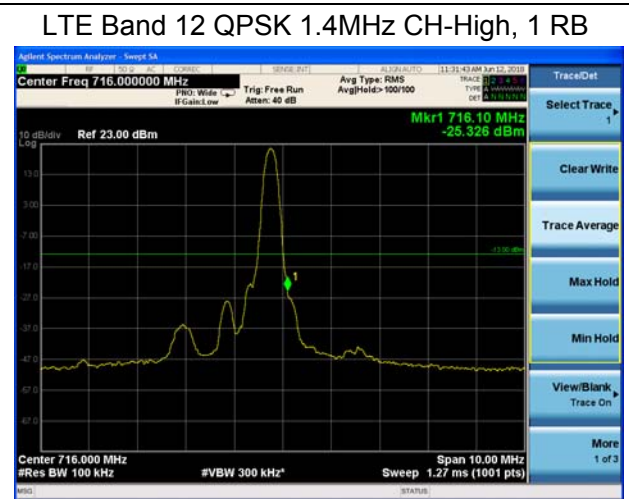
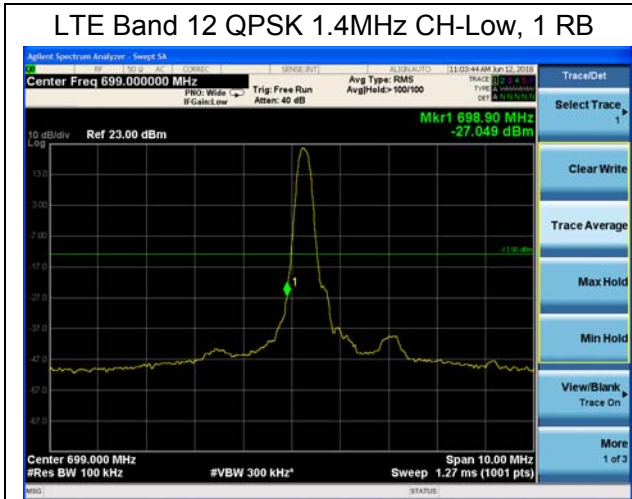



LTE Band 12 QPSK 3MHz CH-Low, 1 RB

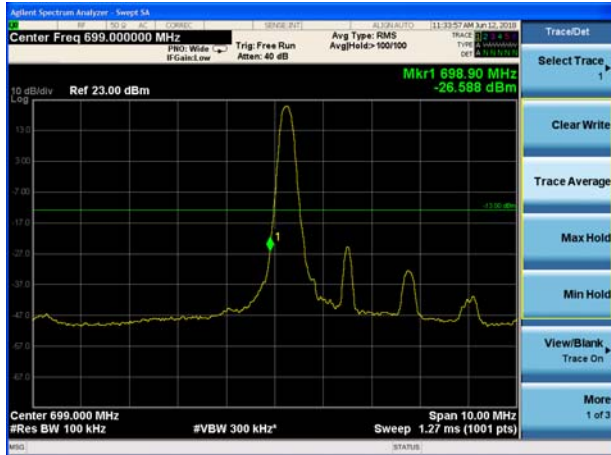

LTE Band 12 QPSK 3MHz CH-High, 1 RB

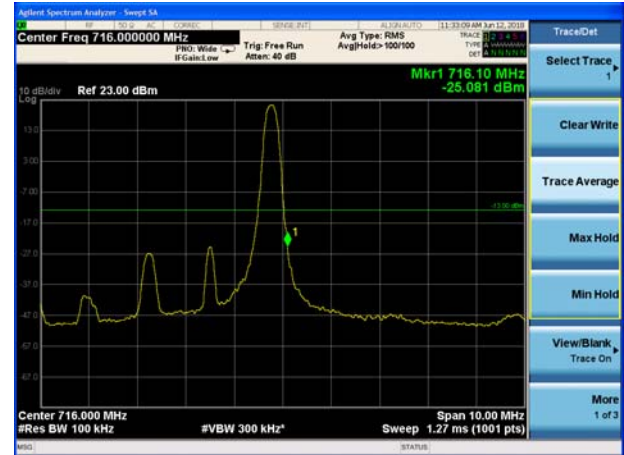

LTE Band 12 QPSK 3MHz CH-Low, 1RB  
698MHz~699MHz



LTE Band 12 QPSK 3MHz CH-High, 1RB  
698MHz~699MHz



LTE Band 12 QPSK 3MHz CH-Low, 100%RB



LTE Band 12 QPSK 3MHz CH-High, 100%RB





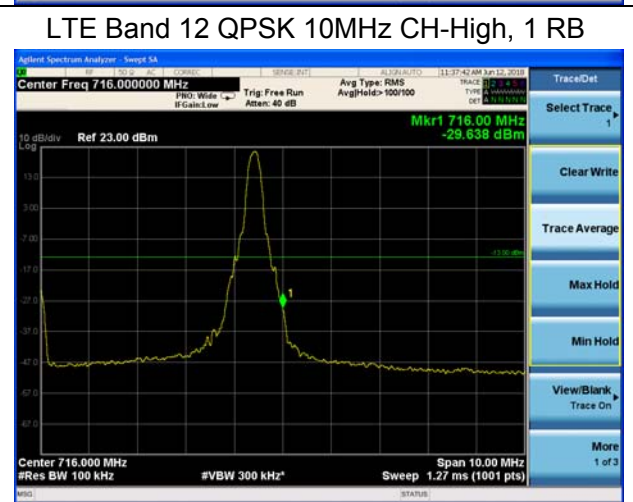
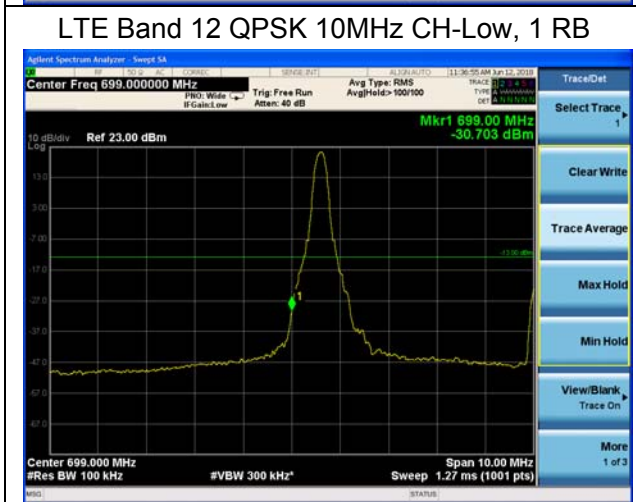
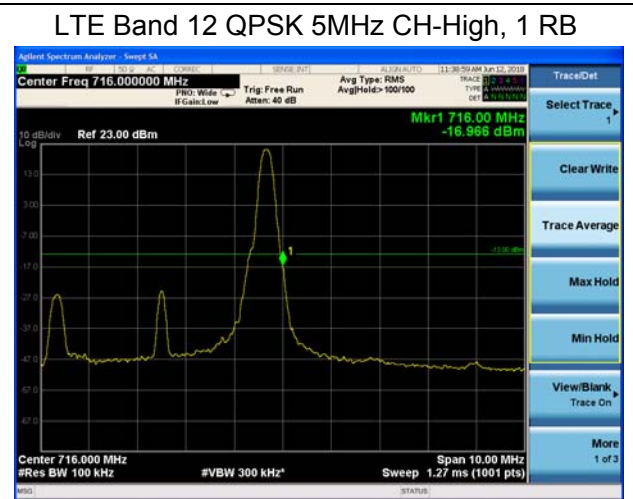
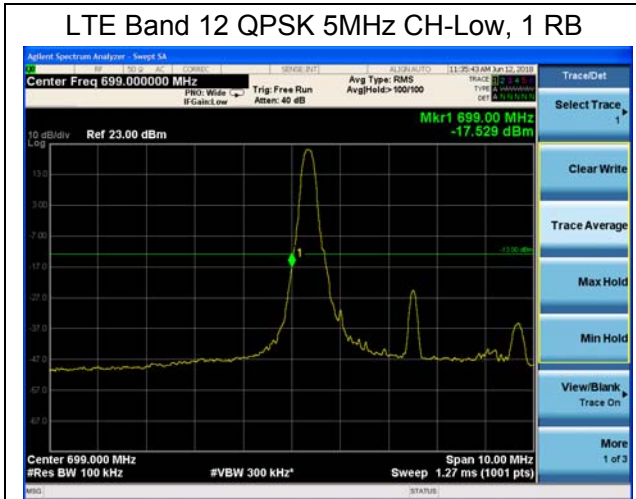



LTE Band 12 QPSK 10MHz CH-Low, 100%RB



LTE Band 12 QPSK 10MHz CH-High, 100%RB



LTE Band 12 16QAM 1.4MHz CH-Low, 1 RB

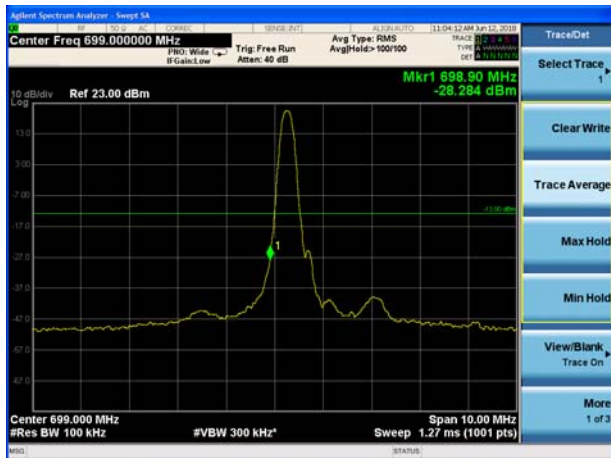

LTE Band 12 16QAM 1.4MHz CH-High, 1 RB

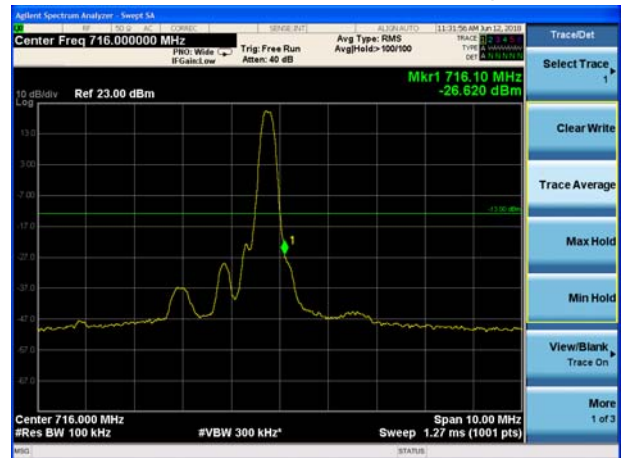

LTE Band 12 16QAM 1.4MHz CH-Low, 1 RB  
698MHz~699MHz



LTE Band 12 16QAM 1.4MHz CH-High, 1 RB  
716MHz~717MHz





LTE Band 12 16QAM 3MHz CH-Low, 1 RB

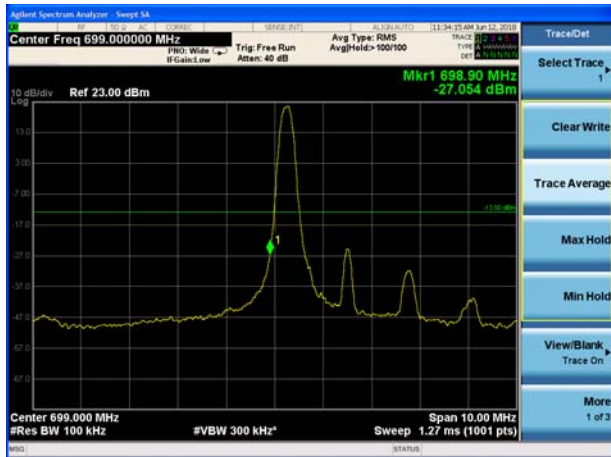

LTE Band 12 16QAM 3MHz CH-High, 1 RB

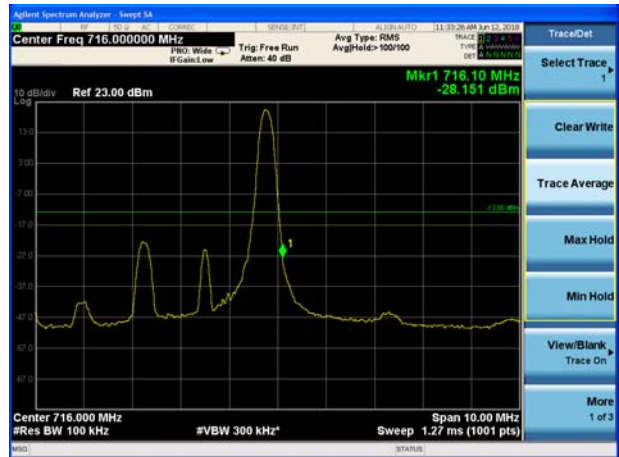

LTE Band 12 16QAM 3MHz CH-Low, 1 RB  
698MHz~699MHz

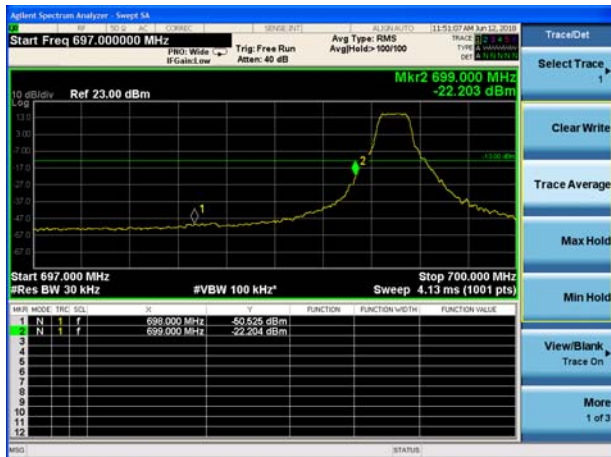

LTE Band 12 16QAM 3MHz CH-High, 1 RB  
716MHz~717MHz

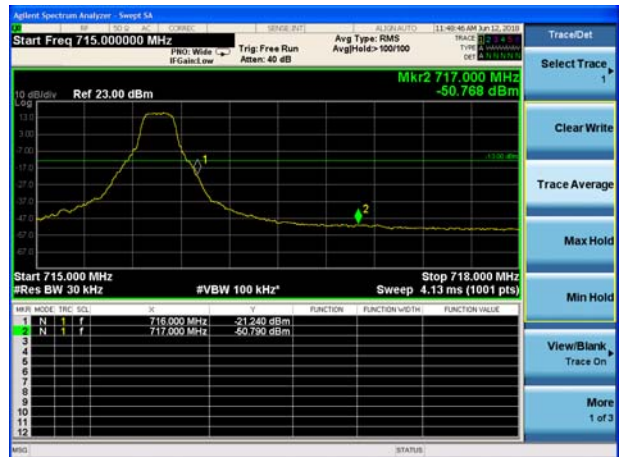

LTE Band 12 16QAM 5MHz CH-Low, 1 RB

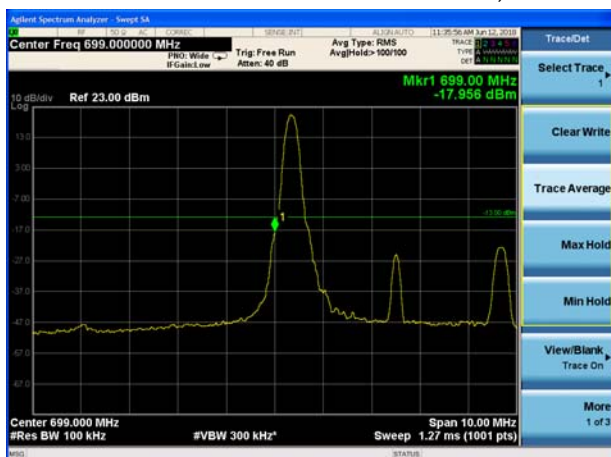

LTE Band 12 16QAM 5MHz CH-High, 1 RB

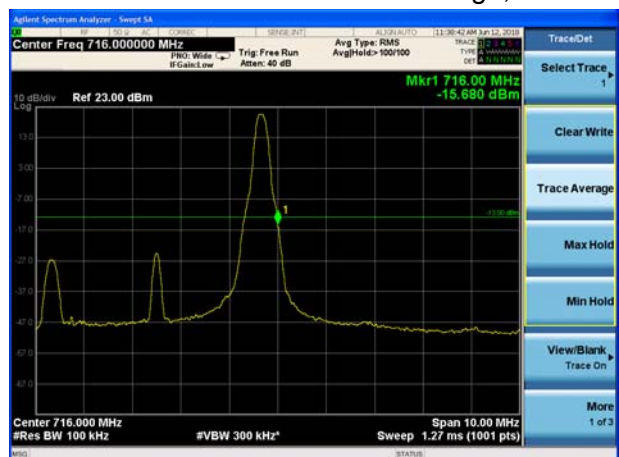

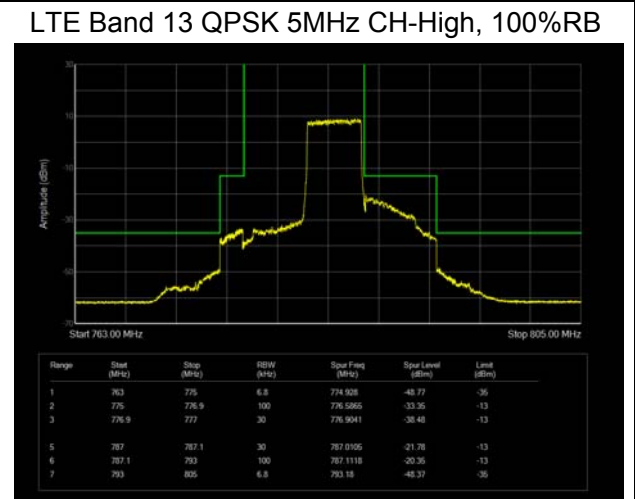
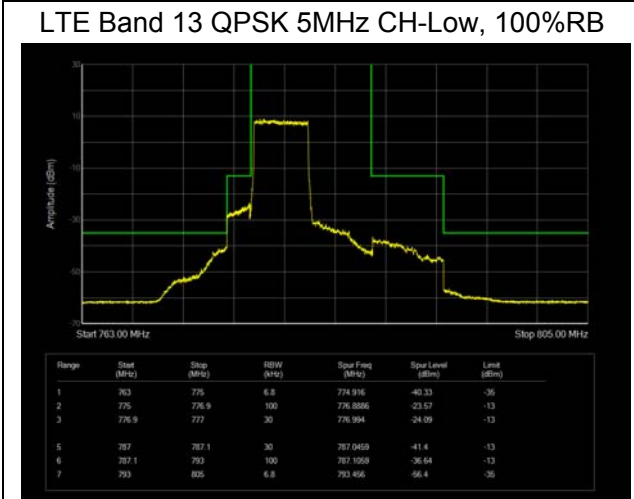
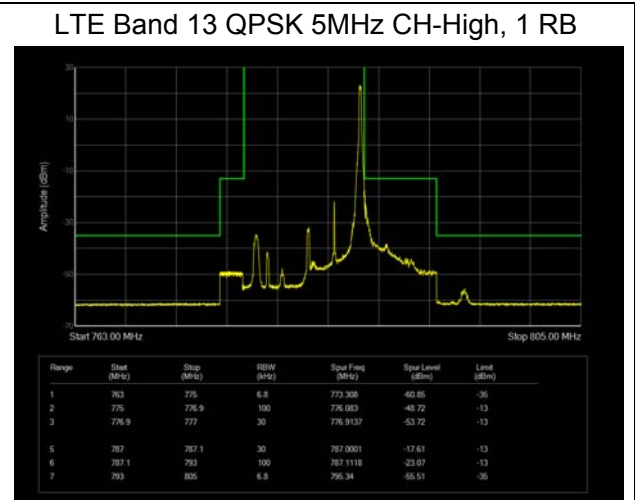
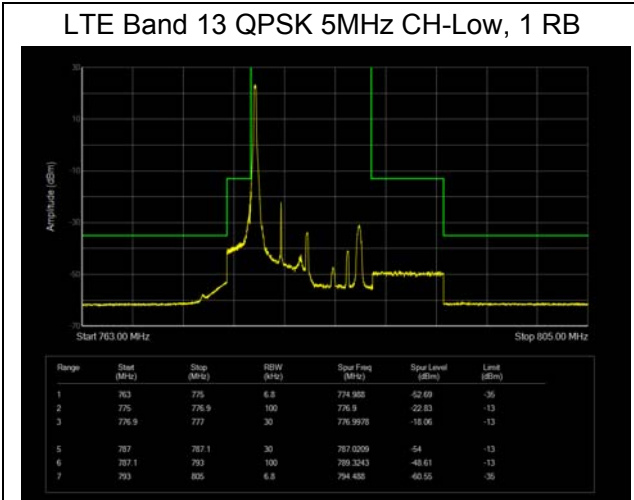
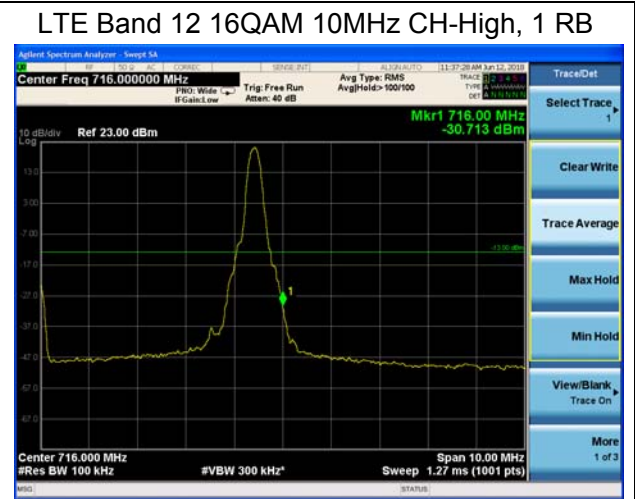
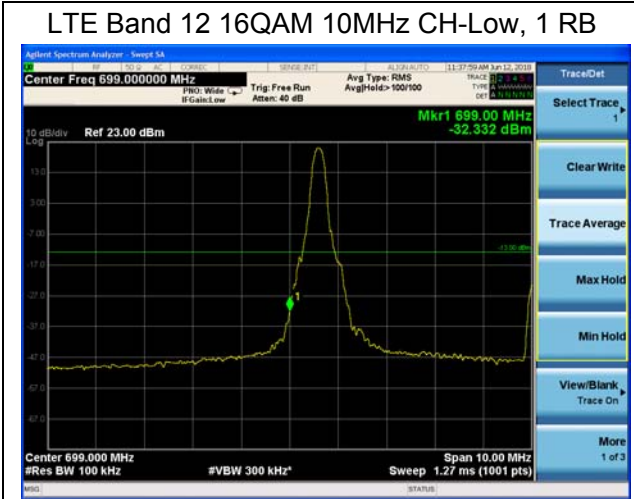

LTE Band 13 QPSK 10MHz CH-Low, 1 RB

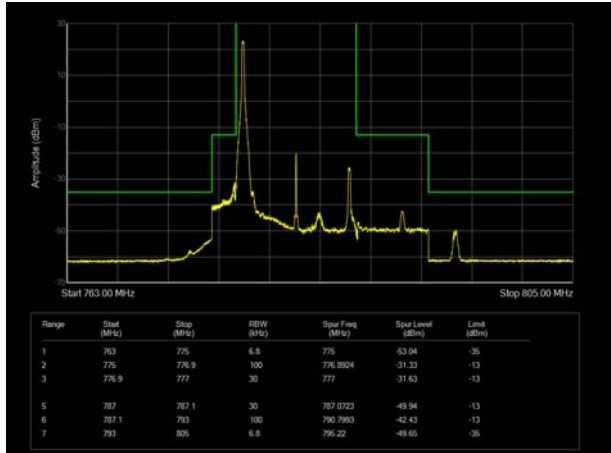

LTE Band 13 QPSK 10MHz CH-High, 1 RB

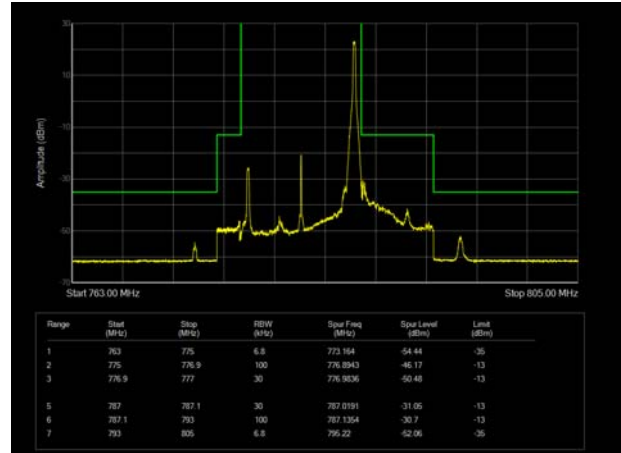

LTE Band 13 QPSK 10MHz CH-Middle, 1 RB

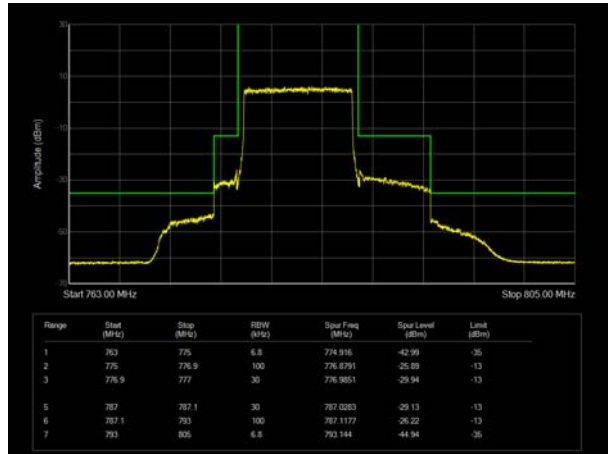



LTE Band 13 16QAM 5MHz CH-Low, 1 RB

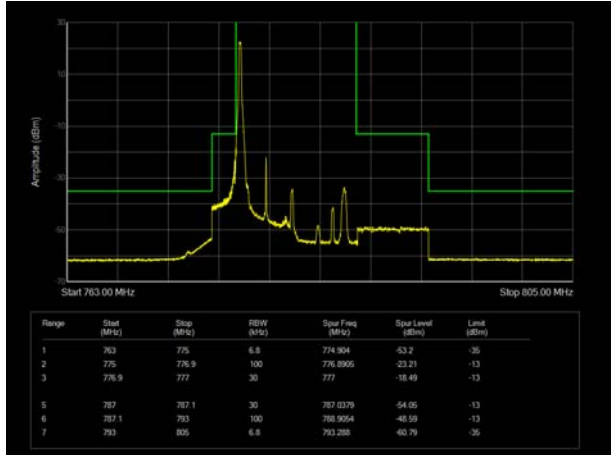

LTE Band 13 16QAM 5MHz CH-High, 1 RB

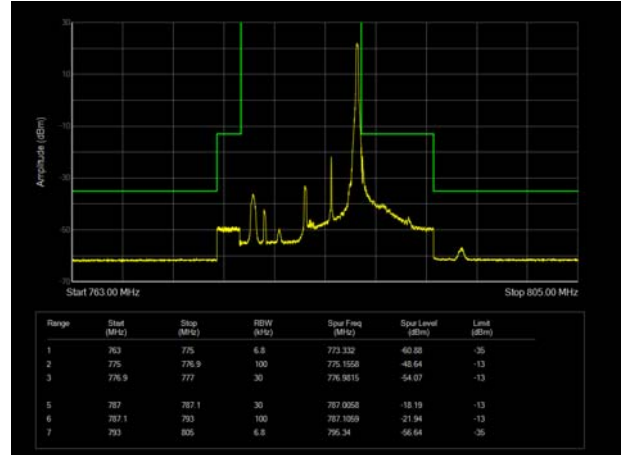

LTE Band 13 16QAM 5MHz CH-Low, 100% RB

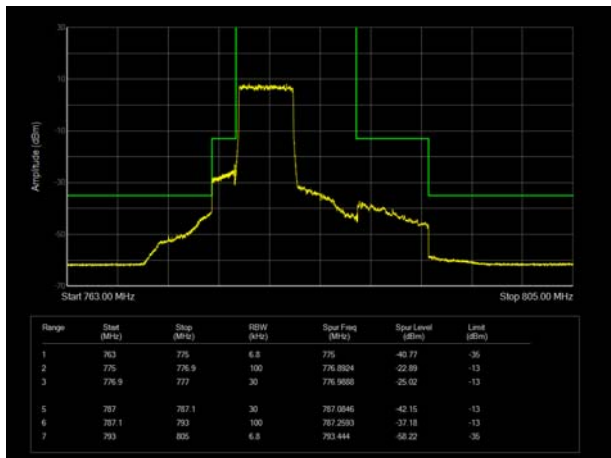

LTE Band 13 16QAM 5MHz CH-High, 100% RB

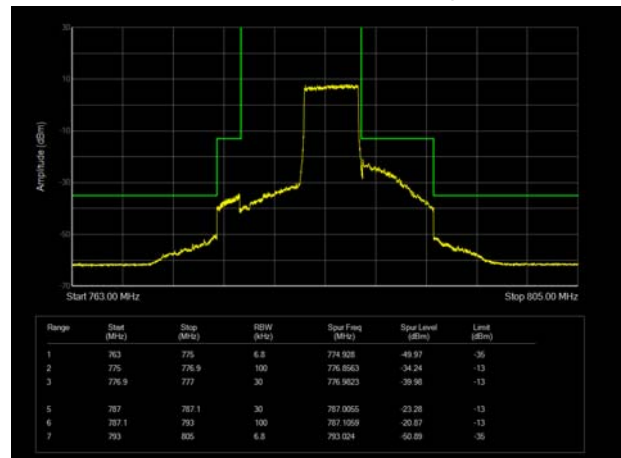

LTE Band 13 16QAM 10MHz CH-Low, 1 RB

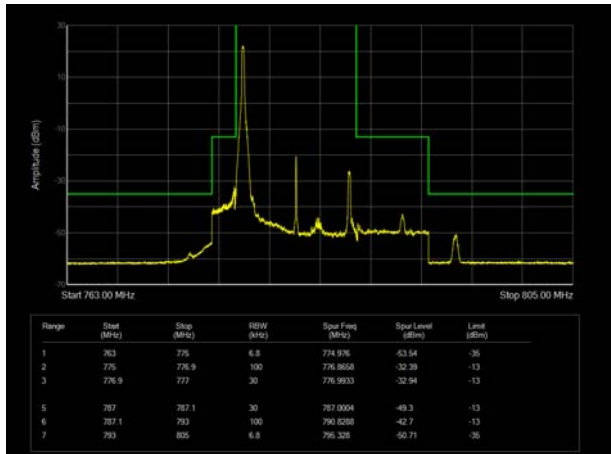

LTE Band 13 16QAM 10MHz CH-High, 1 RB

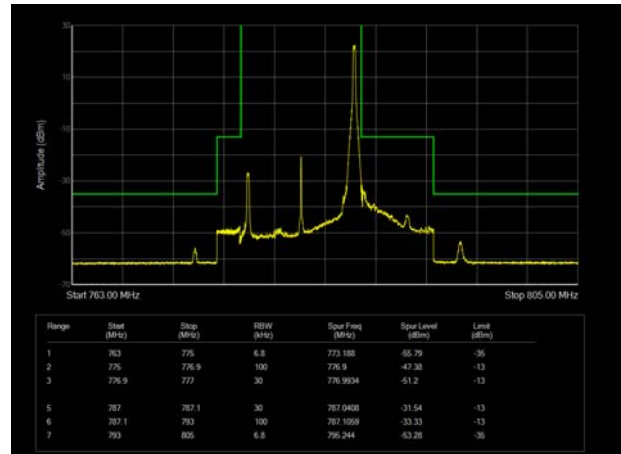

### 5.5 Peak-to-Average Power Ratio (PAPR)

#### Ambient condition

Temperature	Relative humidity	Pressure
23°C ~25°C	45%~50%	101.5kPa

#### Methods of Measurement

Measure the total peak power and record as PPk. And measure the total average power and record as PAvg. Both the peak and average power levels must be expressed in the same logarithmic units (e.g., dBm). Determine the PAPR from:

$$PAPR (dB) = PPk (dBm) - PAvg (dBm).$$

#### Test Setup

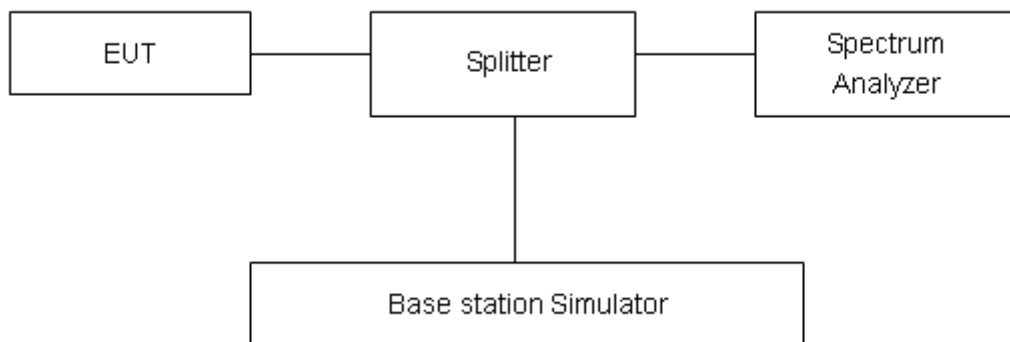

#### Limits

Rule Part 27.50(d)(5) Equipment employed must be authorized in accordance with the provisions of 24.51. Power measurements for transmissions by stations authorized under this section may be made either in accordance with a Commission-approved average power technique or in compliance with paragraph (d)(6) of this section. In measuring transmissions in this band using an average power technique, the peak-to-average ratio (PAR) of the transmission may not exceed 13 dB.

#### Measurement Uncertainty

The assessed measurement uncertainty to ensure 95% confidence level for the normal distribution is with the coverage factor k = 2, U= 0.4 dB.

**Test Results**

WCDMA Band IV	Channel	Frequency (MHz)	Peak (dBm)	Avg (dBm)	PAPR (dB)	Limit (dB)	Conclusion
<b>RMC</b>	1312	1712.4	26.69	23.57	3.12	≤13	PASS
	1413	1732.6	26.78	23.56	3.22	≤13	PASS
	1513	1752.6	26.33	23.51	2.82	≤13	PASS

LTE Band 4								
Modulation	Bandwidth (MHz)	Channel	Frequency (MHz)	Peak (dBm)	Avg (dBm)	PAPR (dB)	Limit (dB)	Conclusion
<b>QPSK</b>	1.4	19957	1710.7	28.43	23.06	5.37	≤13	PASS
		20175	1732.5	28.31	22.95	5.36	≤13	PASS
		20393	1754.3	28.39	22.98	5.41	≤13	PASS
	3	19965	1711.5	27.92	22.79	5.13	≤13	PASS
		20175	1732.5	28.21	23.06	5.15	≤13	PASS
		20385	1753.5	28.13	22.93	5.20	≤13	PASS
	5	19975	1712.5	28.31	22.77	5.54	≤13	PASS
		20175	1732.5	28.54	23.05	5.49	≤13	PASS
		20375	1752.5	28.51	22.91	5.60	≤13	PASS
	10	20000	1715	28.02	22.85	5.17	≤13	PASS
		20175	1732.5	28.18	23.07	5.11	≤13	PASS
		20350	1750	28.17	22.95	5.22	≤13	PASS
	15	20025	1717.5	29.16	22.83	6.33	≤13	PASS
		20175	1732.5	29.36	23.03	6.33	≤13	PASS
		20325	1747.5	29.30	22.90	6.40	≤13	PASS
	20	20050	1720	28.99	22.80	6.19	≤13	PASS
		20175	1732.5	29.18	22.98	6.20	≤13	PASS
		20300	1745	29.17	22.86	6.31	≤13	PASS
<b>16QAM</b>	1.4	19957	1710.7	29.81	23.39	6.42	≤13	PASS
		20175	1732.5	29.39	23.01	6.38	≤13	PASS
		20393	1754.3	29.41	22.93	6.48	≤13	PASS
	3	19965	1711.5	29.11	22.89	6.22	≤13	PASS
		20175	1732.5	28.83	22.67	6.16	≤13	PASS
		20385	1753.5	29.90	23.60	6.30	≤13	PASS
	5	19975	1712.5	28.13	22.66	5.47	≤13	PASS
		20175	1732.5	28.84	22.92	5.92	≤13	PASS
		20375	1752.5	28.50	23.45	5.05	≤13	PASS
	10	20000	1715	29.16	22.88	6.28	≤13	PASS
		20175	1732.5	28.06	22.66	5.40	≤13	PASS
		20350	1750	28.68	23.59	5.09	≤13	PASS



	15	20025	1717.5	28.11	22.83	5.28	≤13	PASS
		20175	1732.5	28.46	22.64	5.82	≤13	PASS
		20325	1747.5	29.47	23.57	5.90	≤13	PASS
	20	20050	1720	29.53	22.81	6.72	≤13	PASS
		20175	1732.5	29.58	22.60	6.98	≤13	PASS
		20300	1745	29.42	23.52	5.90	≤13	PASS

LTE Band 12								
Modulation	Bandwidth (MHz)	Channel	Frequency (MHz)	Peak (dBm)	Avg (dBm)	PAPR (dB)	Limit (dB)	Conclusion
QPSK	1.4	23017	699.7	28.93	22.70	6.23	≤13	PASS
		23095	707.5	29.11	22.78	6.33	≤13	PASS
		23173	715.3	29.61	22.83	6.78	≤13	PASS
	3	23025	700.5	29.81	22.85	6.96	≤13	PASS
		23095	707.5	29.14	22.93	6.21	≤13	PASS
		23165	714.5	29.37	22.99	6.38	≤13	PASS
	5	23035	701.5	29.98	22.83	7.15	≤13	PASS
		23095	707.5	29.62	22.89	6.73	≤13	PASS
		23155	713.5	29.69	22.94	6.75	≤13	PASS
	10	23060	704	30.81	22.80	8.01	≤13	PASS
		23095	707.5	29.19	22.84	6.35	≤13	PASS
		23130	711	29.24	22.90	6.34	≤13	PASS
16QAM	1.4	23017	699.7	30.96	23.53	7.43	≤13	PASS
		23095	707.5	30.33	23.16	7.17	≤13	PASS
		23173	715.3	30.29	22.71	7.58	≤13	PASS
	3	23025	700.5	30.01	22.59	7.42	≤13	PASS
		23095	707.5	30.71	23.27	7.44	≤13	PASS
		23165	714.5	29.94	22.84	7.10	≤13	PASS
	5	23035	701.5	29.53	22.54	6.99	≤13	PASS
		23095	707.5	30.74	23.25	7.49	≤13	PASS
		23155	713.5	30.27	22.82	7.45	≤13	PASS
	10	23060	704	30.27	22.52	7.75	≤13	PASS
		23095	707.5	30.30	23.21	7.09	≤13	PASS
		23130	711	30.28	22.77	7.51	≤13	PASS

LTE Band 13								
Modulation	Bandwidth (MHz)	Channel	Frequency (MHz)	Peak (dBm)	Avg (dBm)	PAPR (dB)	Limit (dB)	Conclusion
QPSK	5	23205	779.5	29.31	22.76	6.55	≤13	PASS
		23230	782	30.14	22.78	7.36	≤13	PASS
		23255	784.5	29.72	22.89	6.83	≤13	PASS
	10	23230	782	28.43	22.74	5.69	≤13	PASS
16QAM	5	23205	779.5	29.04	22.88	6.16	≤13	PASS
		23230	782	28.95	22.86	6.09	≤13	PASS
		23255	784.5	29.33	22.46	6.87	≤13	PASS
	10	23230	782	29.64	22.98	6.66	≤13	PASS

## 5.6 Frequency Stability

### Ambient condition

Temperature	Relative humidity	Pressure
23°C ~25°C	45%~50%	101.5kPa

### Method of Measurement

#### Frequency Stability (Temperature Variation)

The temperature inside the climate chamber is varied from -40°C to +85°C in 10°C step size.

(1) With all power removed, the temperature was decreased to -10°C and permitted to stabilize for three hours.

(2) Measure the carrier frequency with the test equipment in a “call mode”. These measurements should be made within 1 minute of powering up the mobile station, to prevent significant self warming.

(3) Repeat the above measurements at 10°C increments from -40°C to +85°C. Allow at least 1.5 hours at each temperature, un-powered, before making measurements.

#### Frequency Stability (Voltage Variation)

The frequency stability shall be measured with variation of primary supply voltage as follows:

(1) Vary primary supply voltage from 85 to 115 percent of the nominal value for other than hand carried battery equipment.

(2) For hand carried, battery powered equipment, reduce primary supply voltage to the battery-operating end point which shall be specified by the manufacturer.

This transceiver is specified to operate with an input voltage of between 3.3 V and 4.3 V, with a nominal voltage of 3.8V.

### Test setup

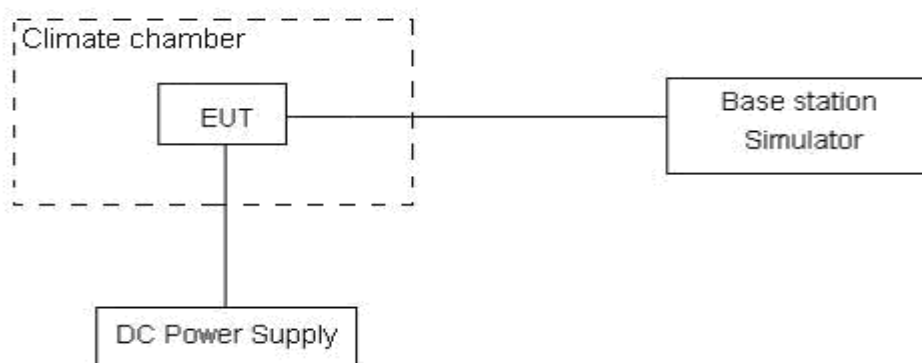

### Limits

No specific frequency stability requirements in part 27.54

### Measurement Uncertainty

The assessed measurement uncertainty to ensure 99.75% confidence level for the normal distribution is with the coverage factor  $k = 3, U=0.01\text{ppm}$ .

**Test Result**

WCDMA Band IV					
(QPSK, 20MHz BANDWIDTH)					
Condition		1710	1755	Delta (Hz)	Frequency Stability(ppm)
Temperature	Voltage	F low@-13dBm(MHz)	F high@-13dBm(MHz)		
Normal (25°C)	Normal	1710.0287	1754.9121	-1.38	-0.00073
Extreme (85°C)		1710.0289	1754.9120	2.15	0.00115
Extreme (80°C)		1710.0284	1754.9124	1.05	0.00056
Extreme (70°C)		1710.0299	1754.9109	1.39	0.00074
Extreme (60°C)		1710.0280	1754.9130	0.82	0.00043
Extreme (50°C)		1710.0277	1754.9131	-1.40	-0.00074
Extreme (40°C)		1710.0292	1754.9116	-1.42	-0.00076
Extreme (30°C)		1710.0281	1754.9127	-1.45	-0.00077
Extreme (20°C)		1710.0279	1754.9130	-2.26	-0.00120
Extreme (10°C)		1710.0294	1754.9114	0.17	0.00009
Extreme (0°C)		1710.0285	1754.9123	-2.53	-0.00135
Extreme (-10°C)		1710.0299	1754.9130	-1.15	-0.00061
Extreme (-20°C)		1710.0331	1754.9161	2.38	0.00127
Extreme (-30°C)		1710.0347	1754.9183	1.28	0.00068
Extreme (-40°C)		1710.0353	1754.9195	1.62	0.00086
25°C	LV	1710.0324	1754.9155	-1.17	-0.00062
	HV	1710.0311	1754.9164	-1.19	-0.00063

LTE Band 4					
(QPSK, 20MHz BANDWIDTH)					
Condition		1710	1755	Delta (Hz)	Frequency Stability(ppm)
Temperature	Voltage	F low@-13dBm(MHz)	F high@-13dBm(MHz)		
Normal (25°C)	Normal	1710.6556	1754.4320	3.01	0.00174
Extreme (85°C)		1710.6567	1754.4332	-1.78	-0.00103
Extreme (80°C)		1710.6534	1754.4293	-0.43	-0.00025
Extreme (70°C)		1710.6547	1754.4312	2.52	0.00145
Extreme (60°C)		1710.6533	1754.4303	-2.60	-0.00150
Extreme (50°C)		1710.6539	1754.4304	-0.33	-0.00019
Extreme (40°C)		1710.6552	1754.4317	2.18	0.00126
Extreme (30°C)		1710.6559	1754.4324	0.55	0.00032
Extreme (20°C)		1710.6541	1754.4303	4.58	0.00264
Extreme (10°C)		1710.6550	1754.4315	3.12	0.00180
Extreme (0°C)		1710.6537	1754.4302	0.49	0.00028
Extreme (-10°C)		1710.6532	1754.4297	-0.43	-0.00025

Extreme (-20°C)		1710.6543	1754.4309	-2.60	-0.00150
Extreme (-30°C)		1710.6576	1754.4341	-0.33	-0.00019
Extreme (-40°C)		1710.6594	1754.4353	4.58	0.00264
25°C	LV	1710.6540	1754.4305	-1.28	-0.00074
	HV	1710.6546	1754.4311	-0.27	-0.00016
<b>(16QAM,20MHz BANDWIDTH)</b>					
Condition		1710	1755	Delta (Hz)	Frequency Stability(ppm)
Temperature	Voltage	F low@-13dBm(MHz)	F high@-13dBm(MHz)		
Normal (25°C)	Normal	1710.6405	1754.5123	5.32	0.00307
Extreme (85°C)		1710.6387	1754.5112	1.28	0.00074
Extreme (80°C)		1710.6426	1754.5151	-0.41	-0.00024
Extreme (70°C)		1710.6407	1754.5132	3.52	0.00203
Extreme (60°C)		1710.6421	1754.5146	1.62	0.00094
Extreme (50°C)		1710.6415	1754.5140	1.15	0.00066
Extreme (40°C)		1710.6402	1754.5127	-0.27	-0.00016
Extreme (30°C)		1710.6395	1754.5120	-3.42	-0.00197
Extreme (20°C)		1710.6416	1754.5141	3.35	0.00193
Extreme (10°C)		1710.6404	1754.5129	0.76	0.00044
Extreme (0°C)		1710.6417	1754.5142	-0.25	-0.00015
Extreme (-10°C)		1710.6422	1754.5147	1.28	0.00074
Extreme (-20°C)		1710.6411	1754.5136	-0.41	-0.00024
Extreme (-30°C)		1710.6381	1754.5103	1.62	0.00094
Extreme (-40°C)		1710.6366	1754.5091	-0.27	-0.00016
25°C	LV	1710.6414	1754.5139	2.66	0.00153
	HV	1710.6409	1754.5133	4.17	0.00241

LTE Band 12					
(QPSK, 20MHz BANDWIDTH)					
Condition		699	716	Delta (Hz)	Frequency Stability(ppm)
Temperature	Voltage	F low@-13dBm(MHz)	F high@-13dBm(MHz)		
Normal (25°C)	Normal	699.2578	715.7329	3.48	0.00416
Extreme (85°C)		699.2589	715.7317	2.84	0.00339
Extreme (80°C)		699.2550	715.7278	1.86	0.00222
Extreme (70°C)		699.2569	715.7297	2.81	0.00336
Extreme (60°C)		699.2555	715.7283	-0.98	-0.00117
Extreme (50°C)		699.2561	715.7289	0.75	0.00089
Extreme (40°C)		699.2574	715.7302	1.74	0.00208
Extreme (30°C)		699.2581	715.7309	1.49	0.00178
Extreme (20°C)		699.2560	715.7288	-0.94	-0.00113

Extreme (10°C)		699.2572	715.7300	-0.10	-0.00012
Extreme (0°C)		699.2559	715.7287	-1.85	-0.00221
Extreme (-10°C)		699.2554	715.7282	-2.80	-0.00335
Extreme (-20°C)		699.2565	715.7293	-2.72	-0.00325
Extreme (-30°C)		699.2598	715.7330	0.13	0.00016
Extreme (-40°C)		699.2610	715.7338	1.19	0.00142
25°C	LV	699.2562	715.7290	3.32	0.00397
	HV	699.2568	715.7301	1.79	0.00214
(16QAM,20MHz BANDWIDTH)					
Condition		699	716	Delta (Hz)	Frequency Stability(ppm)
Temperature	Voltage	F low@-13dBm(MHz)	F high@-13dBm(MHz)		
Normal (25°C)	Normal	699.3124	715.6811	0.69	0.00082
Extreme (85°C)		699.3113	715.6800	1.13	0.00135
Extreme (80°C)		699.3152	715.6839	1.35	0.00161
Extreme (70°C)		699.3133	715.6820	-1.74	-0.00208
Extreme (60°C)		699.3147	715.6834	2.05	0.00245
Extreme (50°C)		699.3141	715.6828	2.81	0.00336
Extreme (40°C)		699.3128	715.6815	0.45	0.00054
Extreme (30°C)		699.3121	715.6808	6.34	0.00758
Extreme (20°C)		699.3142	715.6829	1.74	0.00208
Extreme (10°C)		699.3130	715.6817	0.02	0.00002
Extreme (0°C)		699.3143	715.6830	0.09	0.00011
Extreme (-10°C)		699.3148	715.6835	-2.79	-0.00334
Extreme (-20°C)		699.3137	715.6824	-3.89	-0.00465
Extreme (-30°C)		699.3104	715.6791	0.89	0.00106
Extreme (-40°C)	699.3092	715.6779	1.05	0.00126	
25°C	LV	699.3140	715.6827	3.59	0.00430
	HV	699.3134	715.6821	2.14	0.00256

LTE Band13					
(QPSK, 20MHz BANDWIDTH)					
Condition		777	787	Delta (Hz)	Frequency Stability(ppm)
Temperature	Voltage	F low@-13dBm(MHz)	F high@-13dBm(MHz)		
Normal (25°C)	Normal	777.4400	786.5793	8.49	0.01015
Extreme (85°C)		777.4401	786.5792	6.61	0.00790
Extreme (80°C)		777.4397	786.5796	-7.31	-0.00874
Extreme (70°C)		777.4412	786.5781	2.87	0.00343
Extreme (60°C)		777.4393	786.5800	7.57	0.00905
Extreme (50°C)		777.4390	786.5803	0.81	0.00097
Extreme (40°C)		777.4405	786.5788	2.90	0.00347

Extreme (30°C)		777.4394	786.5799	-2.02	-0.00241
Extreme (20°C)		777.4391	786.5802	-4.06	-0.00485
Extreme (10°C)		777.4407	786.5786	2.22	0.00265
Extreme (0°C)		777.4398	786.5795	8.48	0.01014
Extreme (-10°C)		777.4393	786.5788	-2.19	-0.00262
Extreme (-20°C)		777.4399	786.5802	-0.42	-0.00050
Extreme (-30°C)		777.4393	786.5800	-0.61	-0.00073
Extreme (-40°C)		777.4399	786.5794	1.43	0.00171
25°C	LV	777.4393	786.5792	1.56	0.00186
	HV	777.4399	786.5781	-5.37	-0.00642
<b>(16QAM,20MHz BANDWIDTH)</b>					
Condition		777	787	Delta (Hz)	Frequency Stability(ppm)
Temperature	Voltage	F low@-13dBm(MHz)	F high@-13dBm(MHz)		
Normal (25°C)	Normal	777.5216	786.5049	3.01	0.00360
Extreme (85°C)		777.5217	786.5048	-1.03	-0.00123
Extreme (80°C)		777.5213	786.5052	0.23	0.00027
Extreme (70°C)		777.5228	786.5168	-0.40	-0.00048
Extreme (60°C)		777.5209	786.5056	-4.43	-0.00530
Extreme (50°C)		777.5206	786.5059	1.84	0.00220
Extreme (40°C)		777.5221	786.5044	4.73	0.00565
Extreme (30°C)		777.5210	786.5055	-5.95	-0.00711
Extreme (20°C)		777.5207	786.5058	8.12	0.00971
Extreme (10°C)		777.5223	786.5042	9.14	0.01093
Extreme (0°C)		777.5214	786.5051	-7.45	-0.00891
Extreme (-10°C)		777.5213	786.5048	2.75	0.00329
Extreme (-20°C)		777.5206	786.5168	-3.12	-0.00373
Extreme (-30°C)		777.5210	786.5055	-2.52	-0.00301
Extreme (-40°C)		777.5223	786.5042	1.75	0.00209
25°C	LV	777.5209	786.5056	-9.79	-0.01170
	HV	777.5215	786.5050	-2.67	-0.00319

## 5.7 Spurious Emissions at Antenna Terminals

### Ambient condition

Temperature	Relative humidity	Pressure
23°C ~25°C	45%~50%	101.5kPa

### Method of Measurement

The EUT was connected to Spectrum Analyzer and Base Station Simulator via power Splitter. The measurement is carried out using a spectrum analyzer. The spectrum analyzer scans from 9kHz to the 10th harmonic of the carrier. The peak detector is used.

RBW is set to 100kHz, VBW is set to 300kHz for 30MHz~1GHz

RBW is set to 1MHz, VBW is set to 3MHz for above 1GHz, Sweep is set to ATUO.

Of those disturbances below (limit – 20 dB), the mark is not required for the EUT.

The modulation mode and RB allocation refer to section 5.1, using the maximum output power configuration.

### Test setup

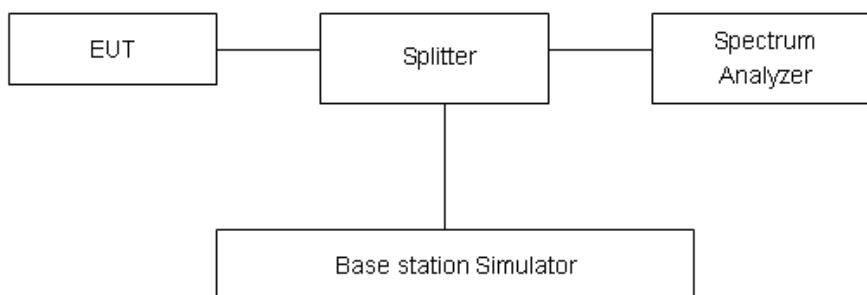

### Limits

Rule Part 27.53(h) specifies that “for operations in the 1695-1710 MHz, 1710-1755 MHz, 1755-1780 MHz, 1915-1920 MHz, 1995-2000 MHz, 2000-2020 MHz, 2110-2155 MHz, 2155-2180 MHz, and 2180-2200 bands, the power of any emission outside a licensee's frequency block shall be attenuated below the transmitter power (P) in watts by at least  $43 + 10 \log_{10}(P)$  dB..”

Rule Part 27.53 (g) For operations in the 600 MHz band and the 698-746 MHz band, the power of any emission outside a licensee's frequency band(s) of operation shall be attenuated below the transmitter power (P) within the licensed band(s) of operation, measured in watts, by at least  $43 + 10 \log(P)$  dB. Compliance with this provision is based on the use of measurement instrumentation employing a resolution bandwidth of 100 kilohertz or greater. However, in the 100 kilohertz bands immediately outside and adjacent to a licensee's frequency block, a resolution bandwidth of at least 30 kHz may be employed.

Rule Part 27.53(f) For operations in the 746-758 MHz, 775-788 MHz, and 805-806 MHz bands, emissions in the band 1559-1610 MHz shall be limited to  $-70$  dBW/MHz equivalent isotropically





radiated power (EIRP) for wideband signals, and -80 dBW EIRP for discrete emissions of less than 700 Hz bandwidth. For the purpose of equipment authorization, a transmitter shall be tested with an antenna that is representative of the type that will be used with the equipment in normal operation.

Part 27.53(h)/(g) Limit		-13 dBm
Part 27.53(f) Limit	Limit out of the band 1559-1610 MHz	-13 dBm
	Limit in the band 1559-1610 MHz	-40 dBm

### Measurement Uncertainty

The assessed measurement uncertainty to ensure 99.75% confidence level for the normal distribution is with the coverage factor  $k = 1.96$ .

Frequency	Uncertainty
9kHz-1GHz	0.684 dB
1GHz-18GHz	1.407 dB

**Test Result**

Sweep the whole frequency band through the range from 9kHz to the 10th harmonic of the carrier, the emissions more than 20 dB below the limit are not reported.

The signal beyond the limit is carrier.

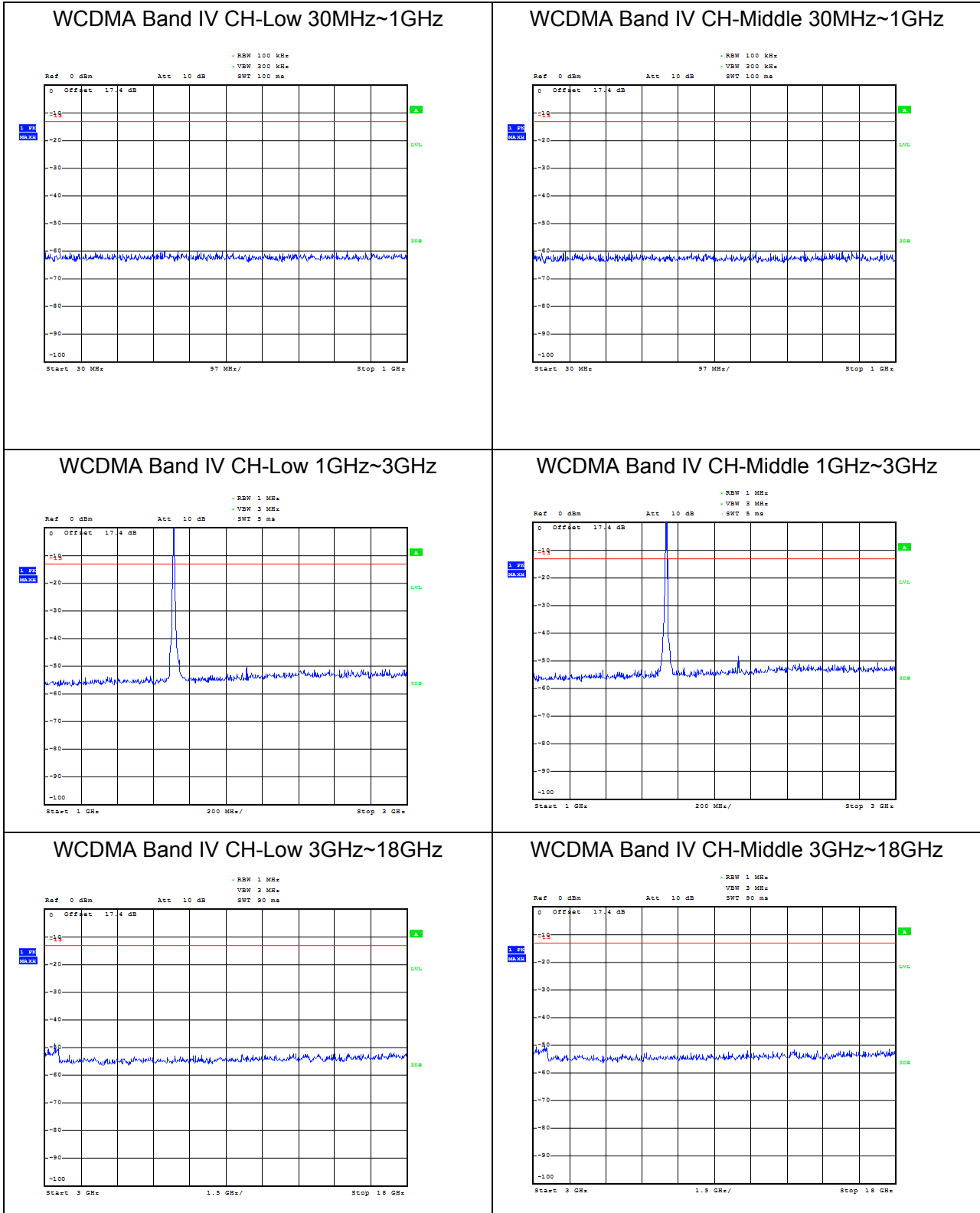



### WCDMA Band IV CH-High 30MHz~1GHz

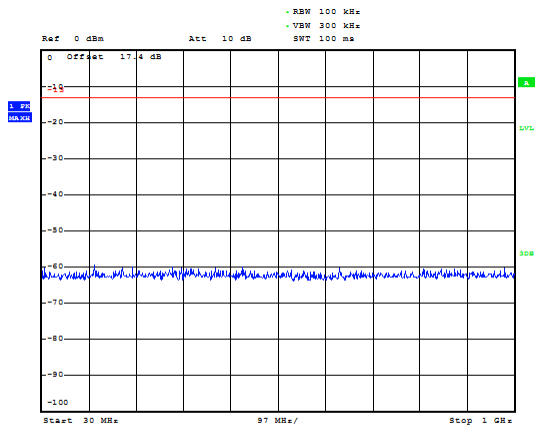

### WCDMA Band IV CH-High 1GHz~3GHz

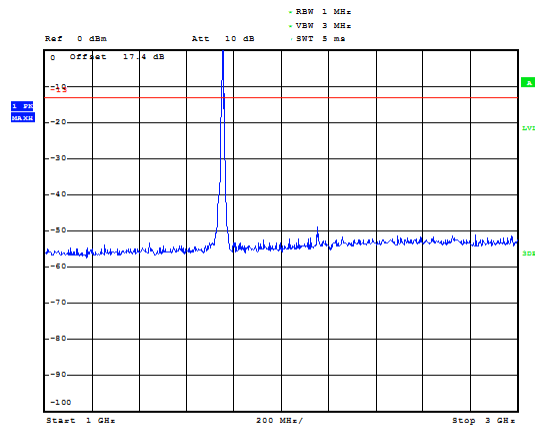

### WCDMA Band IV CH-High 3GHz~18GHz

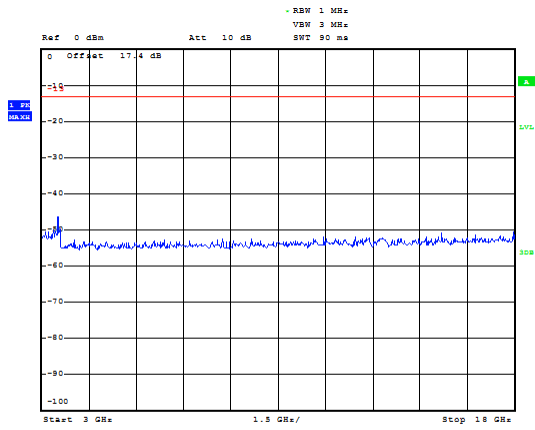



LTE Band 4 1.4MHz CH-Low 30MHz~1GHz

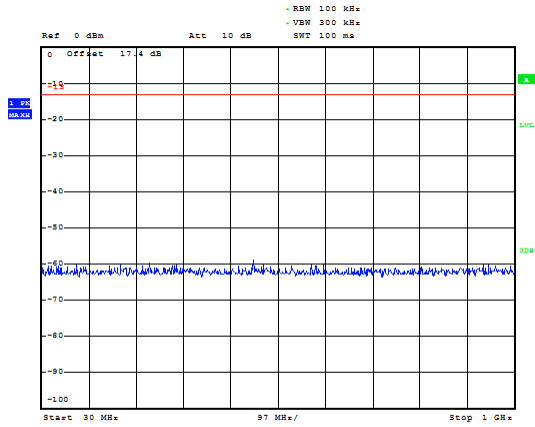

LTE Band 4 1.4MHz CH-Middle 30MHz~1GHz

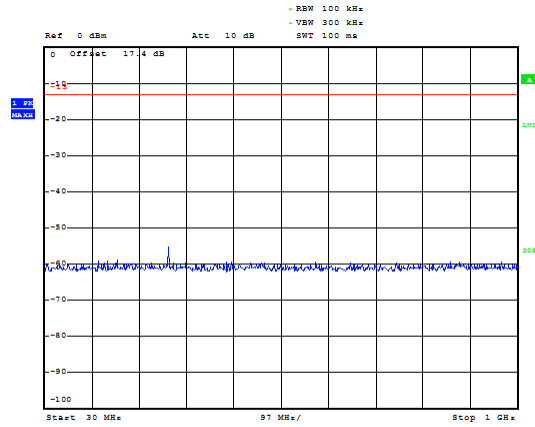

LTE Band 4 1.4MHz CH-Low 1GHz~3GHz

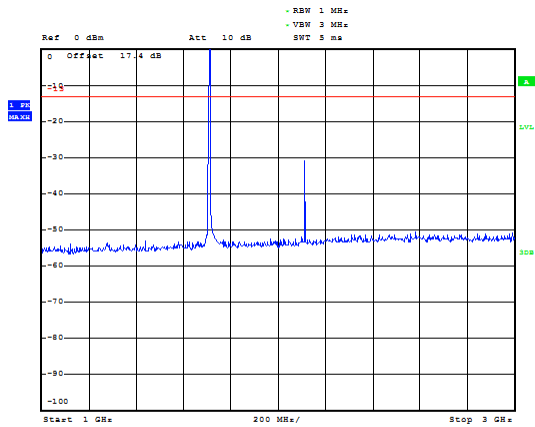

LTE Band 4 1.4MHz CH-Middle 1GHz~3GHz

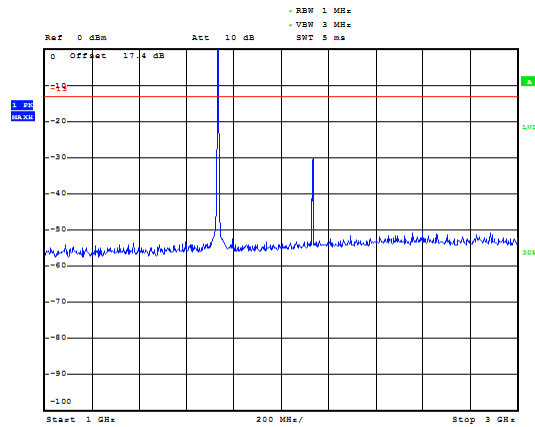

LTE Band 4 1.4MHz CH-Low 3GHz~18GHz

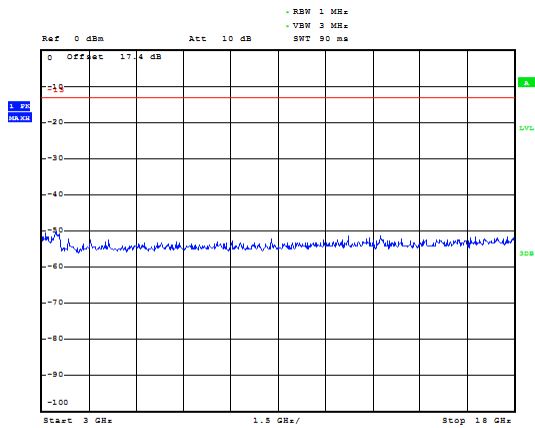

LTE Band 4 1.4MHz CH-Middle 3GHz~18GHz

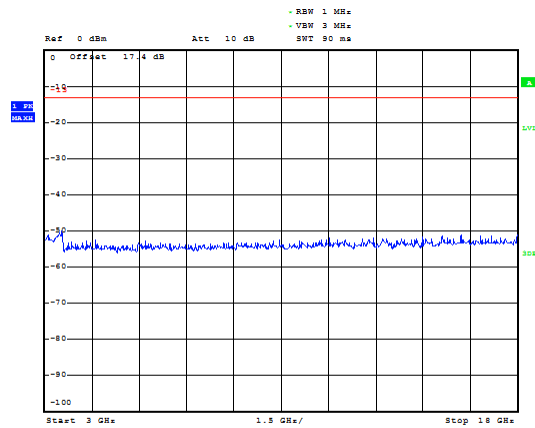



### LTE Band 4 1.4MHz CH-High 30MHz~1GHz

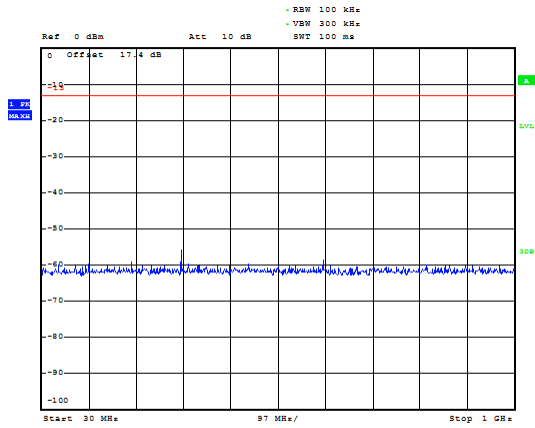

### LTE Band 4 3MHz CH-Low 30MHz~1GHz

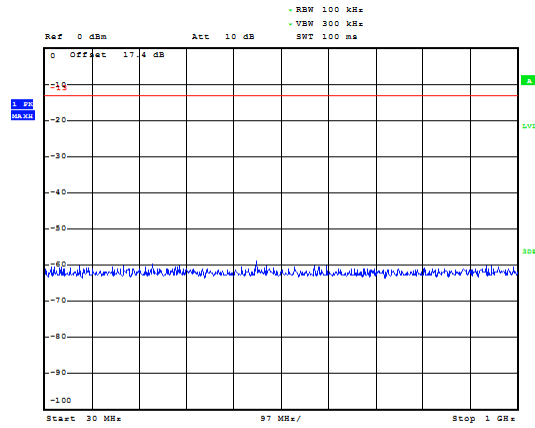

### LTE Band 4 1.4MHz CH-High 1GHz~3GHz

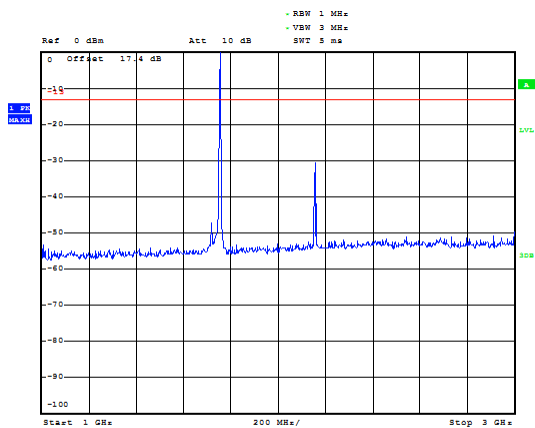

### LTE Band 4 3MHz CH-Low 1GHz~3GHz

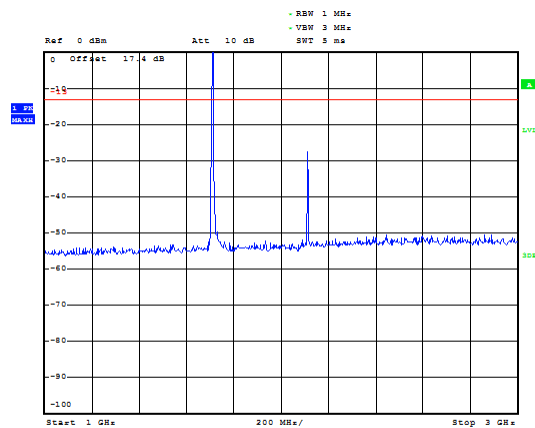

### LTE Band 4 1.4MHz CH-High 3GHz~18GHz

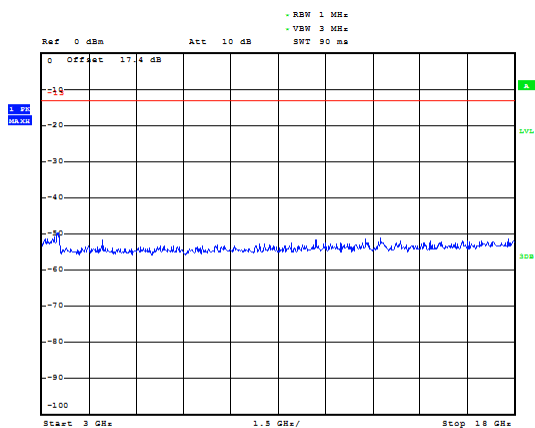

### LTE Band 4 3MHz CH-Low 3GHz~18GHz

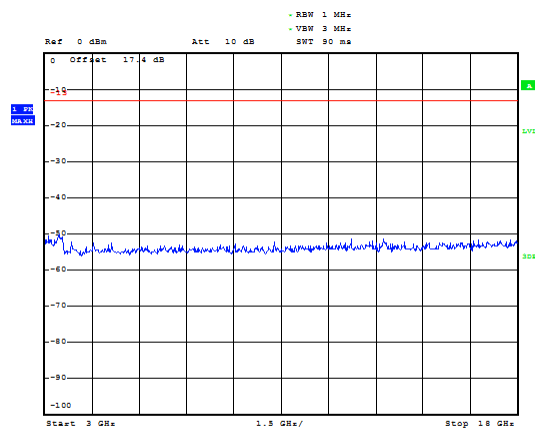



LTE Band 4 3MHz CH-Middle 30MHz~1GHz

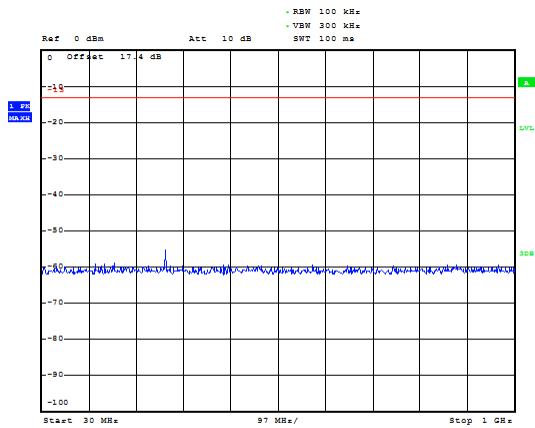

LTE Band 4 3MHz CH-High 30MHz~1GHz

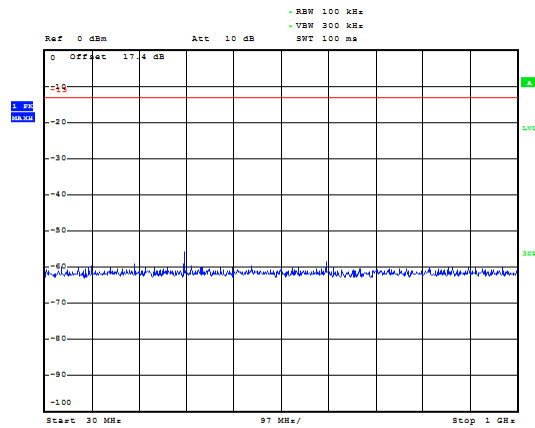

LTE Band 4 3MHz CH-Middle 1GHz~3GHz

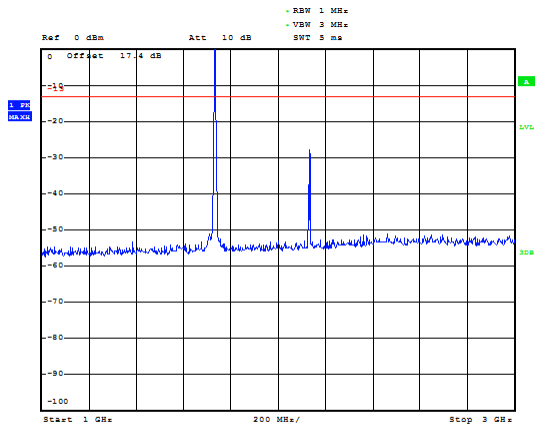

LTE Band 4 3MHz CH-High 1GHz~3GHz

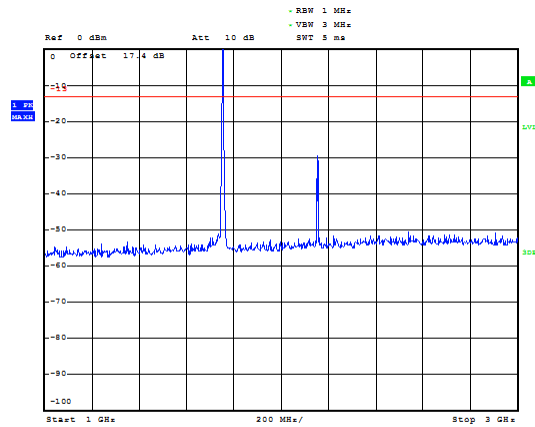

LTE Band 4 3MHz CH-Middle 3GHz~18GHz

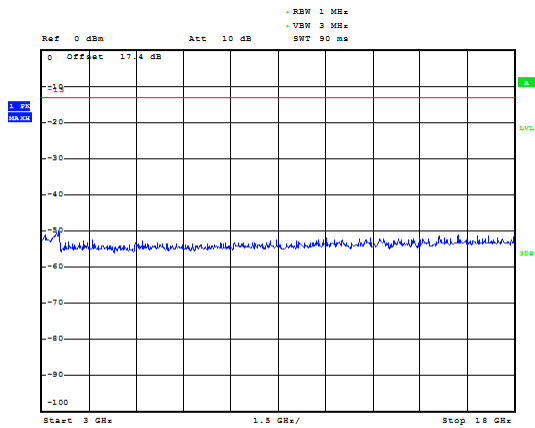

LTE Band 4 3MHz CH-High 3GHz~18GHz

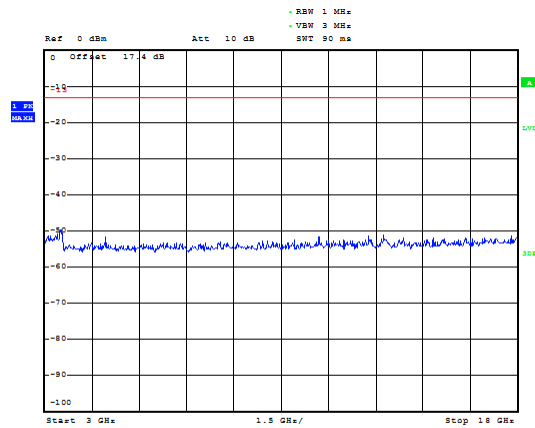



### LTE Band 4 5MHz CH-Low 30MHz~1GHz

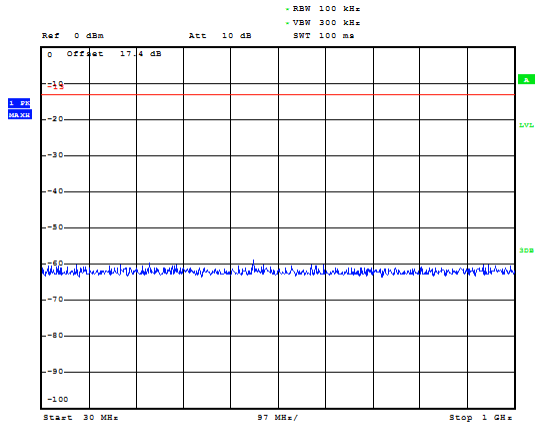

### LTE Band 4 5MHz CH-Middle 30MHz~1GHz

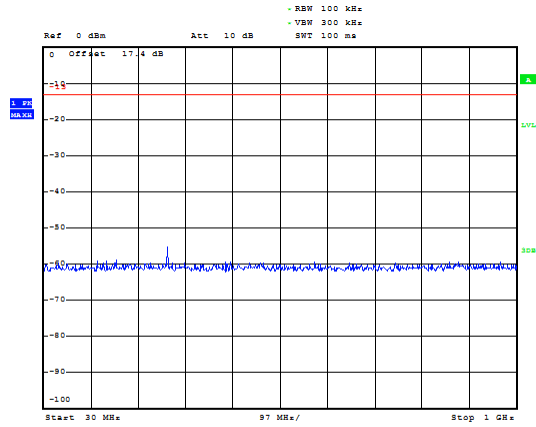

### LTE Band 4 5MHz CH-Low 1GHz~3GHz

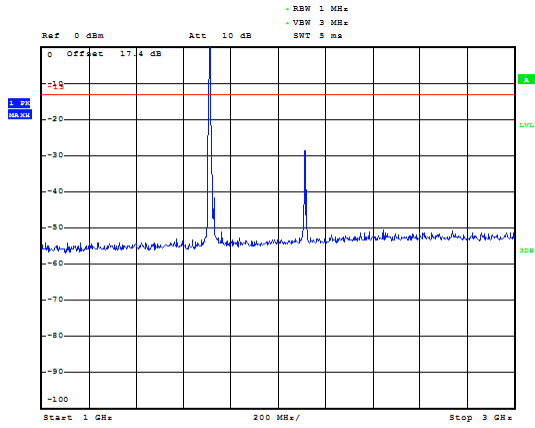

### LTE Band 4 5MHz CH-Middle 1GHz~3GHz

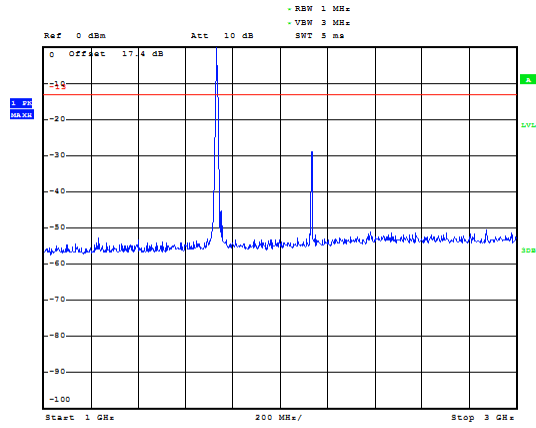

### LTE Band 4 5MHz CH-Low 3GHz~18GHz

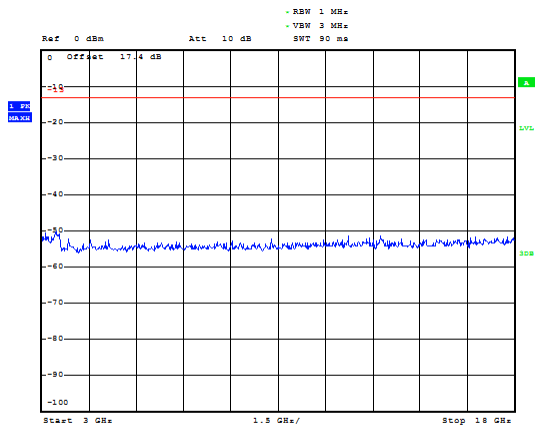

### LTE Band 4 5MHz CH-Middle 3GHz~18GHz

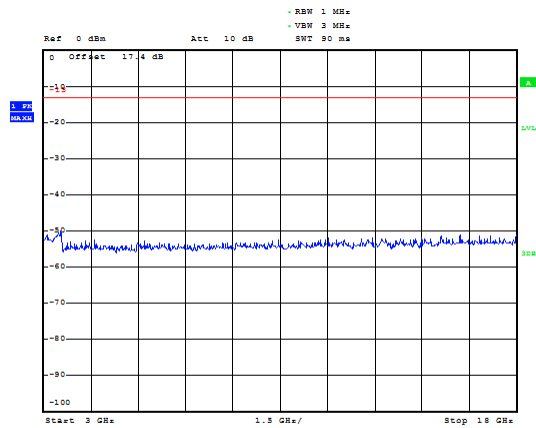



### LTE Band 4 5MHz CH-High 30MHz~1GHz

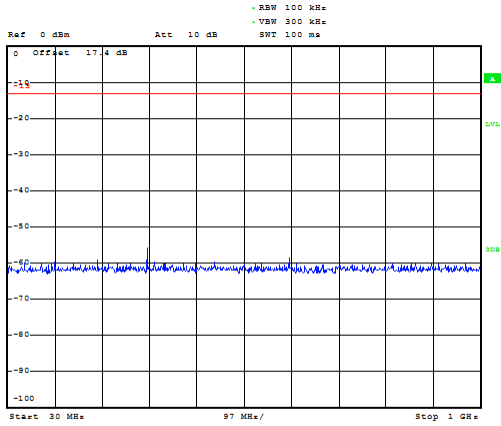

### LTE Band 4 10MHz CH-Low 30MHz~1GHz

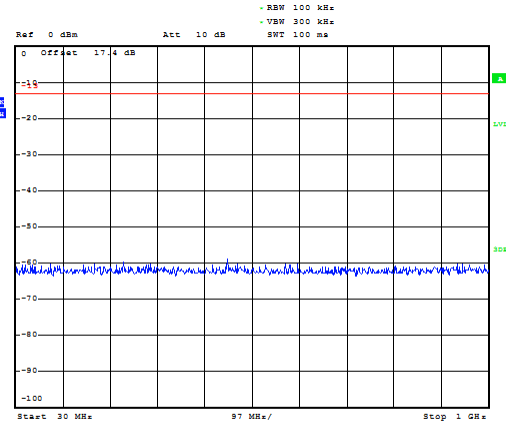

### LTE Band 4 5MHz CH-High 1GHz~3GHz

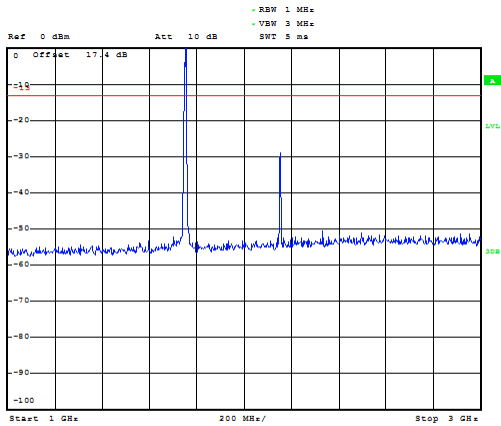

### LTE Band 4 10MHz CH-Low 1GHz~3GHz

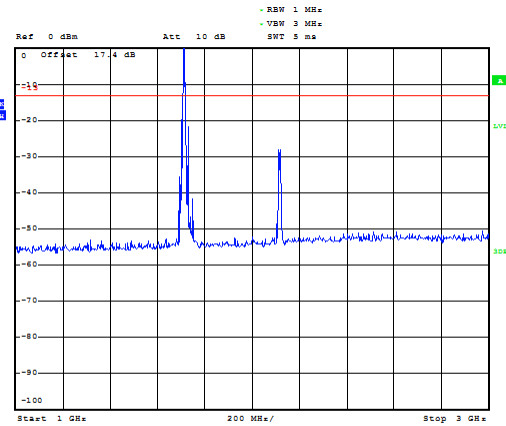

### LTE Band 4 5MHz CH-High 3GHz~18GHz

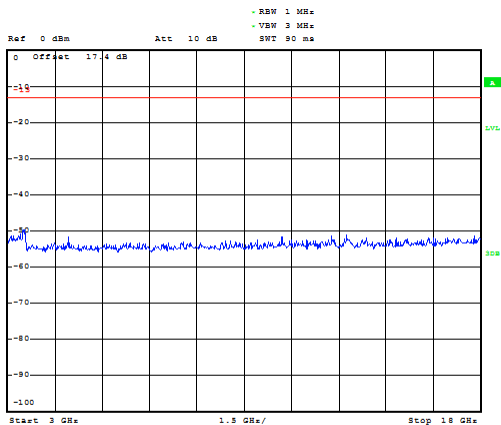

### LTE Band 4 10MHz CH-Low 3GHz~18GHz

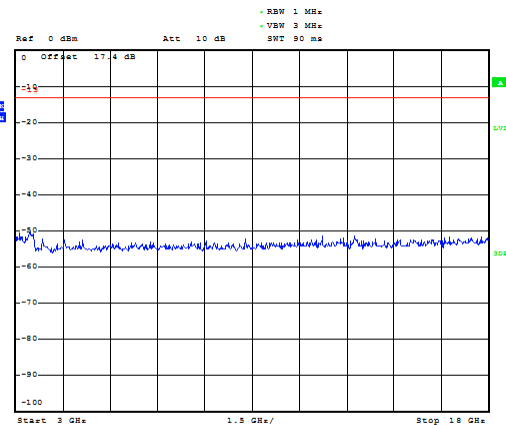





LTE Band 4 10MHz CH-Middle 30MHz~1GHz

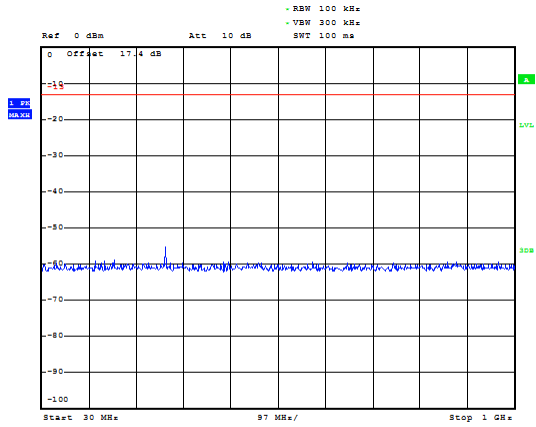

LTE Band 4 10MHz CH-High 30MHz~1GHz

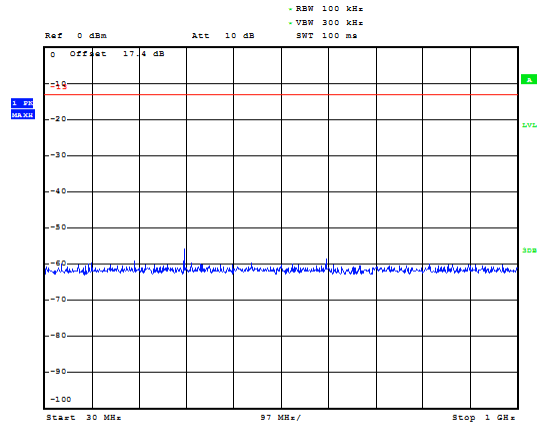

LTE Band 4 10MHz CH-Middle 1GHz~3GHz

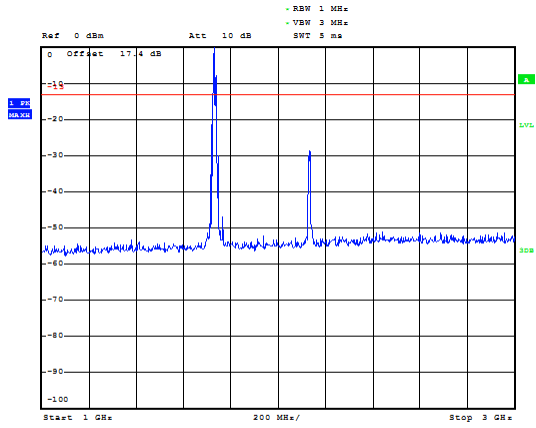

LTE Band 4 10MHz CH-High 1GHz~3GHz

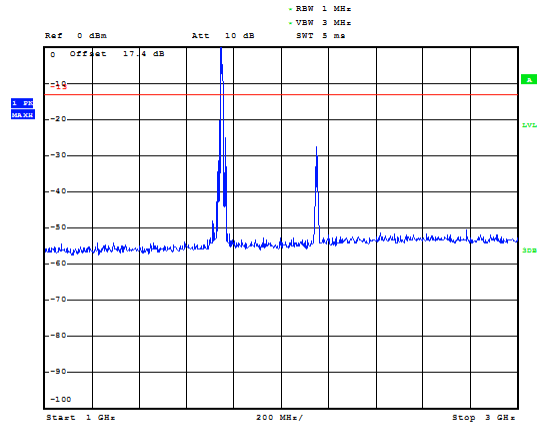

LTE Band 4 10MHz CH-Middle 3GHz~18GHz

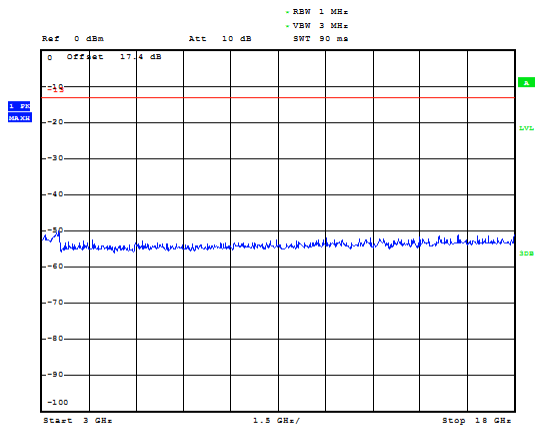

LTE Band 4 10MHz CH-High 3GHz~18GHz

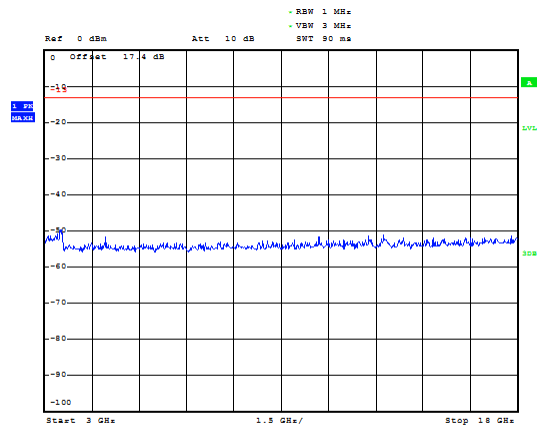



### LTE Band 4 15MHz CH-Low 30MHz~1GHz

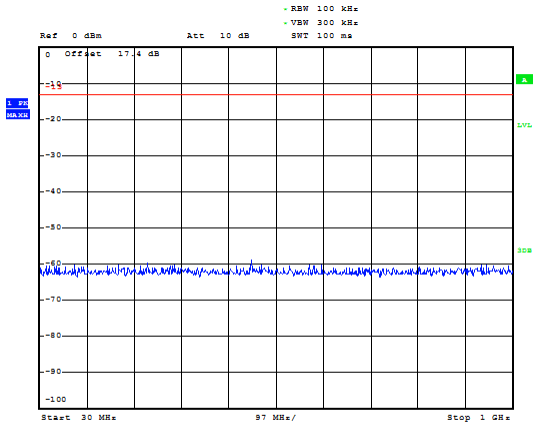

### LTE Band 4 15MHz CH-Middle 30MHz~1GHz

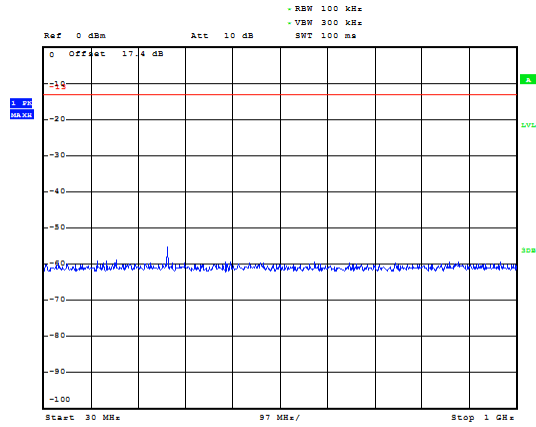

### LTE Band 4 15MHz CH-Low 1GHz~3GHz

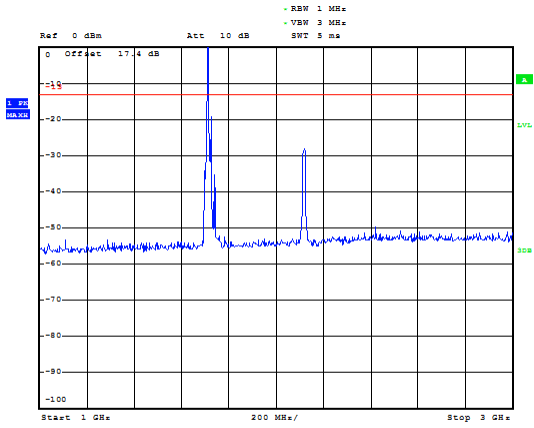

### LTE Band 4 15MHz CH-Middle 1GHz~3GHz

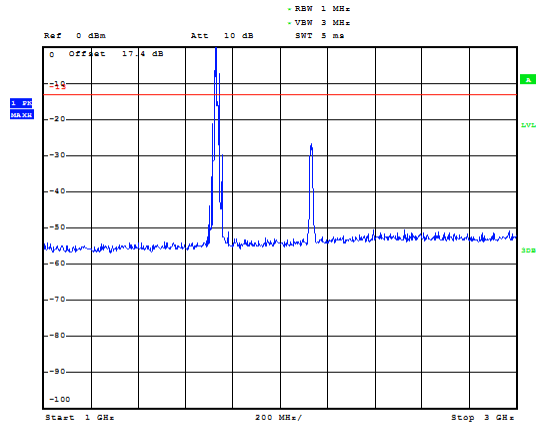

### LTE Band 4 15MHz CH-Low 3GHz~18GHz

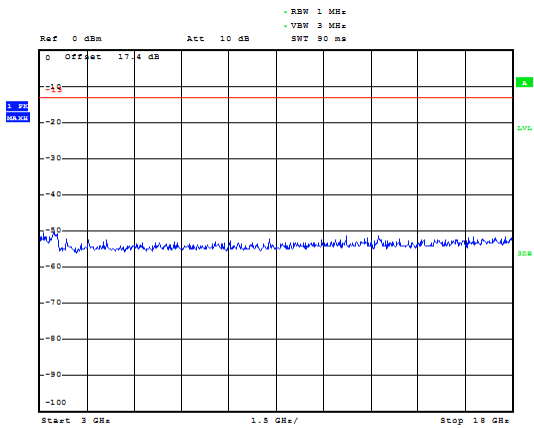

### LTE Band 4 15MHz CH-Middle 3GHz~18GHz

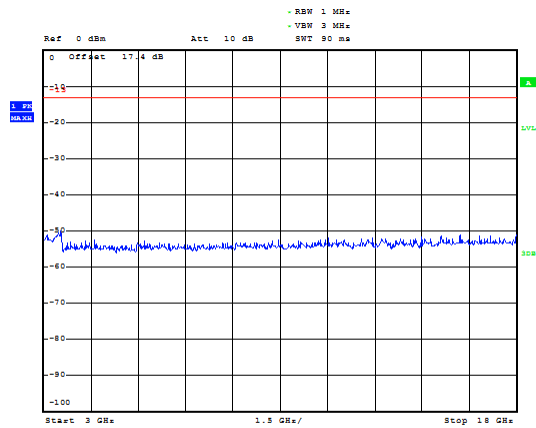



### LTE Band 4 15MHz CH-High 30MHz~1GHz

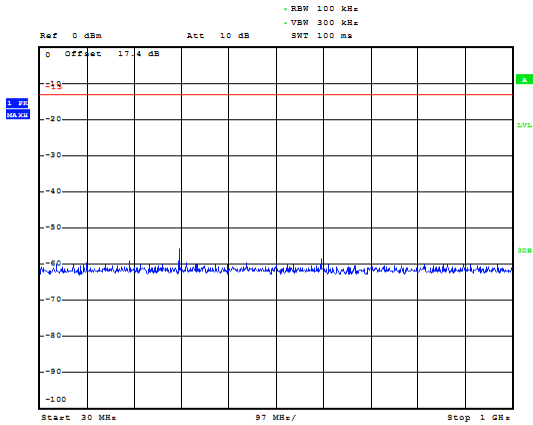

### LTE Band 4 20MHz CH-Low 30MHz~1GHz

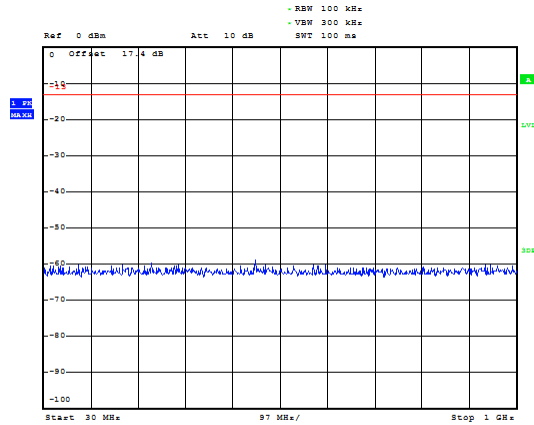

### LTE Band 4 15MHz CH-High 1GHz~3GHz

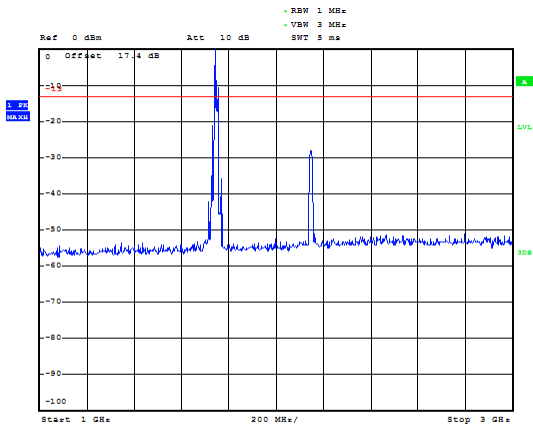

### LTE Band 4 20MHz CH-Low 1GHz~3GHz

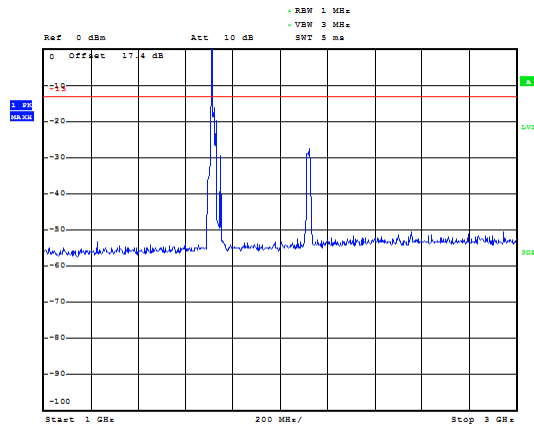

### LTE Band 4 15MHz CH-High 3GHz~18GHz

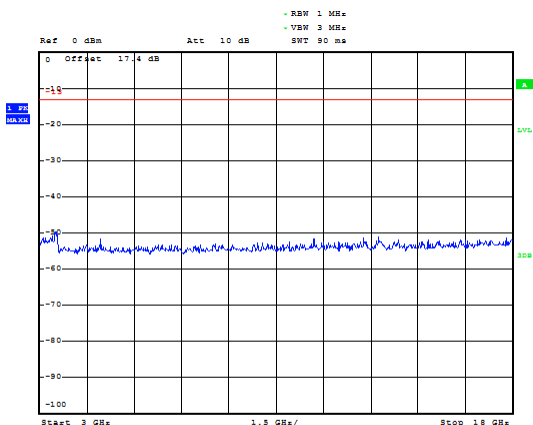

### LTE Band 4 20MHz CH-Low 3GHz~18GHz

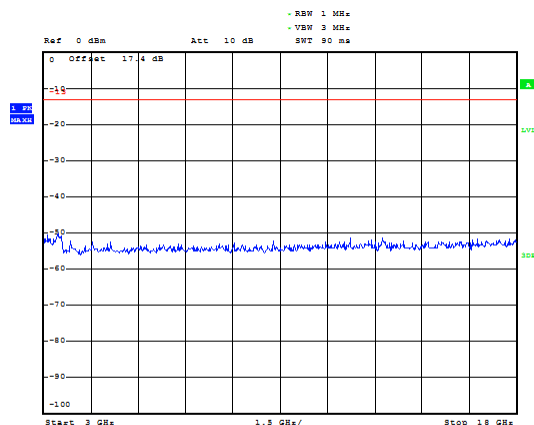



LTE Band 4 20MHz CH-Middle 30MHz~1GHz

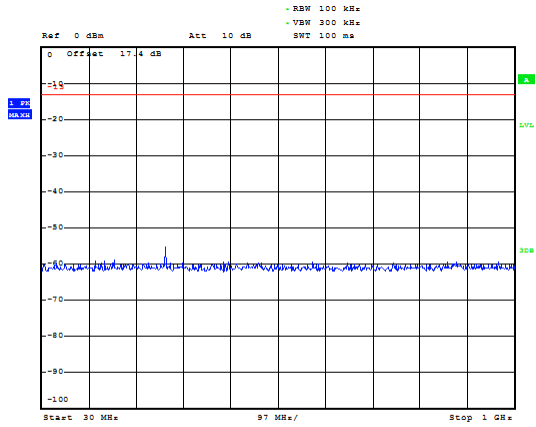

LTE Band 4 20MHz CH-High 30MHz~1GHz

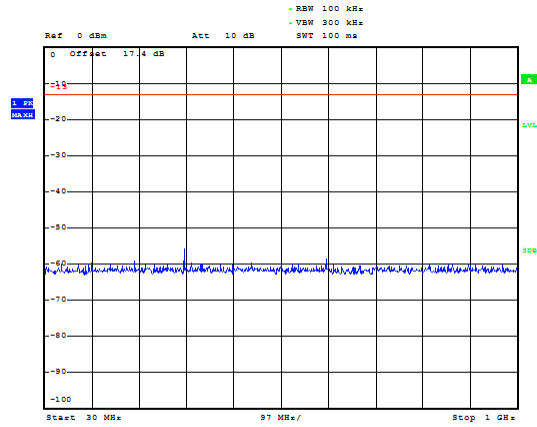

LTE Band 4 20MHz CH-Middle 1GHz~3GHz

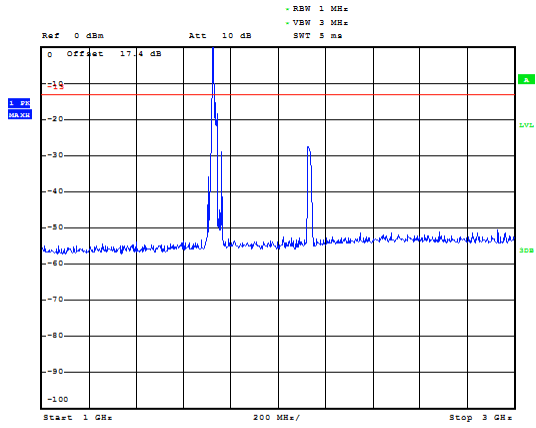

LTE Band 4 20MHz CH-High 1GHz~3GHz

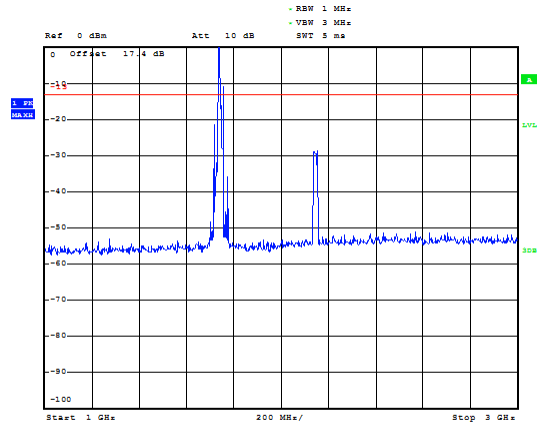

LTE Band 4 20MHz CH-Middle 3GHz~18GHz

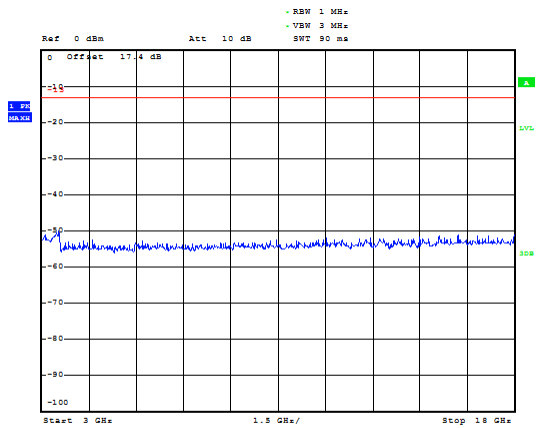

LTE Band 4 20MHz CH-High 3GHz~18GHz

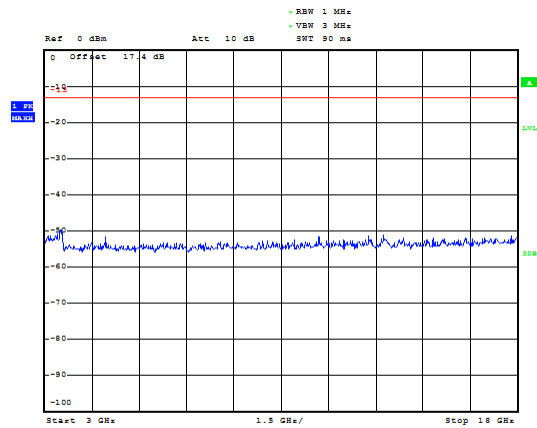



### LTE Band 12 1.4MHz CH-Low 30MHz~1GHz

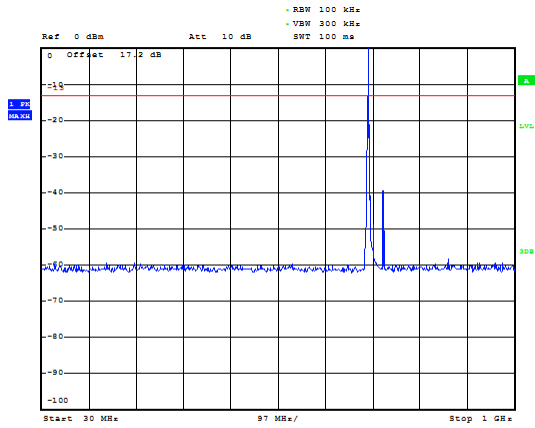

### LTE Band 12 1.4MHz CH-Low 1GHz~9GHz

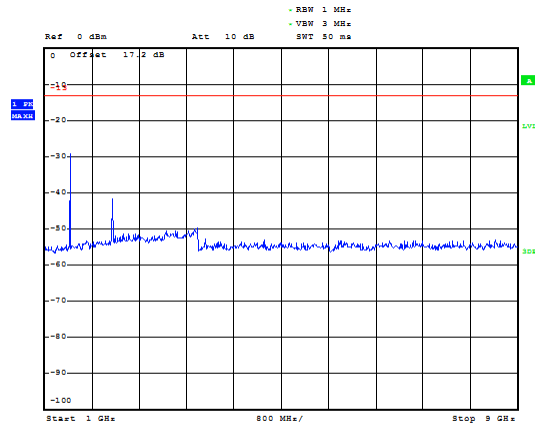

### LTE Band 12 1.4MHz CH- Middle 30MHz~1GHz

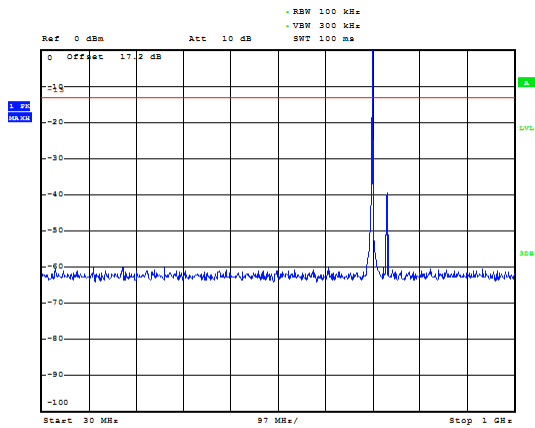

### LTE Band 12 1.4MHz CH- Middle 1GHz~9GHz

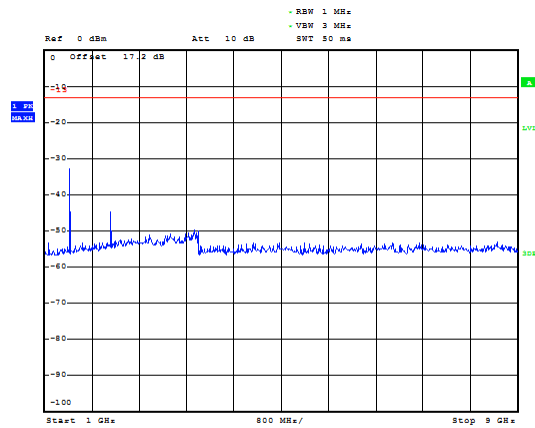

### LTE Band 12 1.4MHz CH-High 30MHz~1GHz

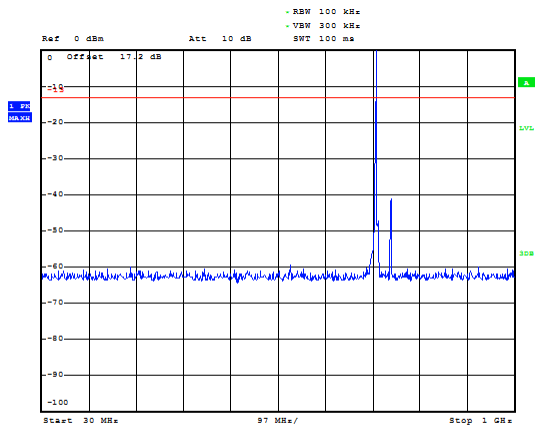

### LTE Band 12 1.4MHz CH-High 1GHz~9GHz

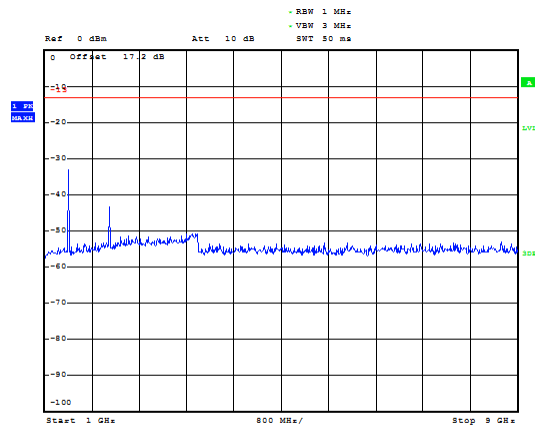



### LTE Band 12 3MHz CH-Low 30MHz~1GHz

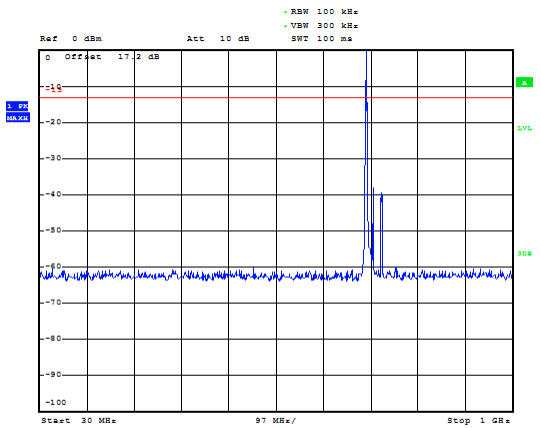

### LTE Band 12 3MHz CH-Low 1GHz~9GHz

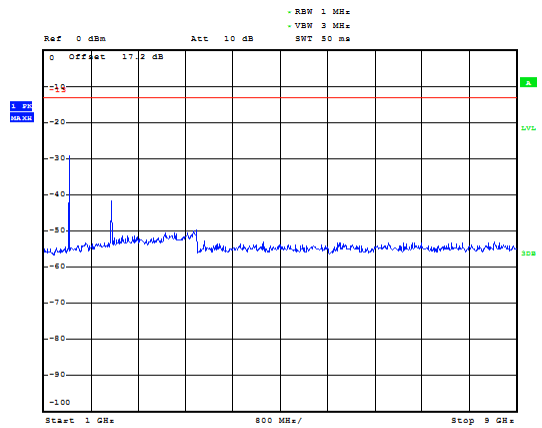

### LTE Band 12 3MHz CH- Middle 30MHz~1GHz

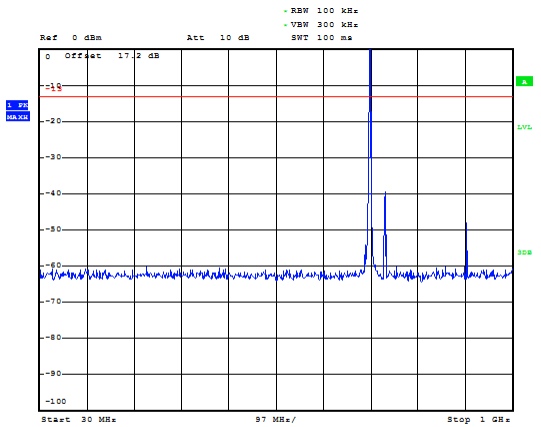

### LTE Band 12 3MHz CH- Middle 1GHz~9GHz

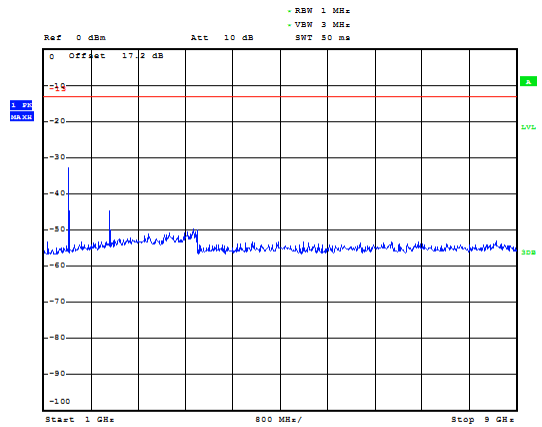

### LTE Band 12 3MHz CH-High 30MHz~1GHz

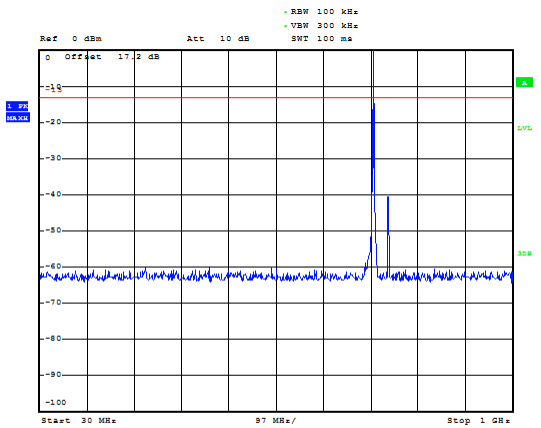

### LTE Band 12 3MHz CH-High 1GHz~9GHz

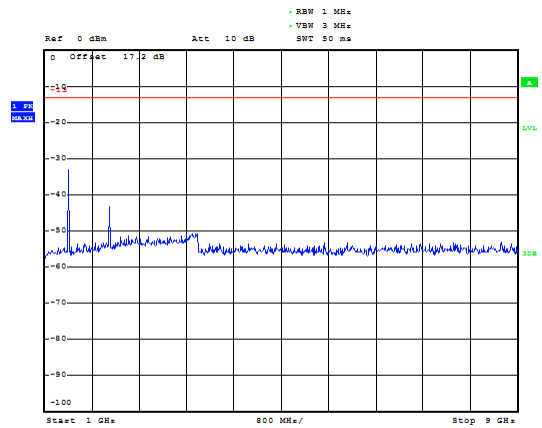



### LTE Band 12 5MHz CH-Low 30MHz~1GHz

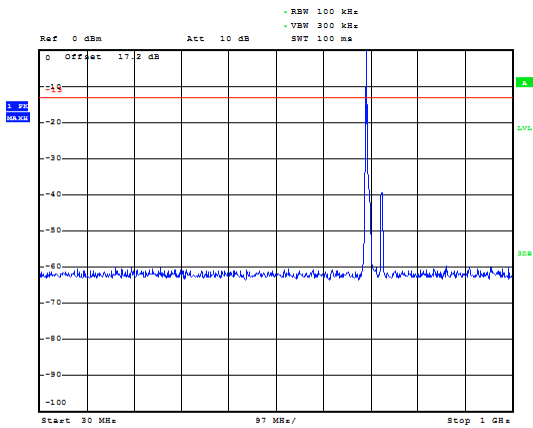

### LTE Band 12 5MHz CH-Low 1GHz~9GHz

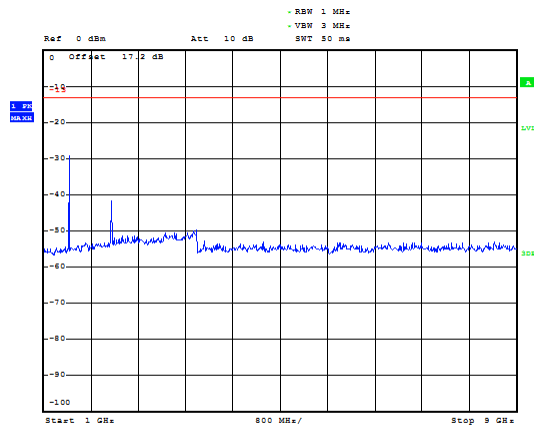

### LTE Band 12 5MHz CH- Middle 30MHz~1GHz

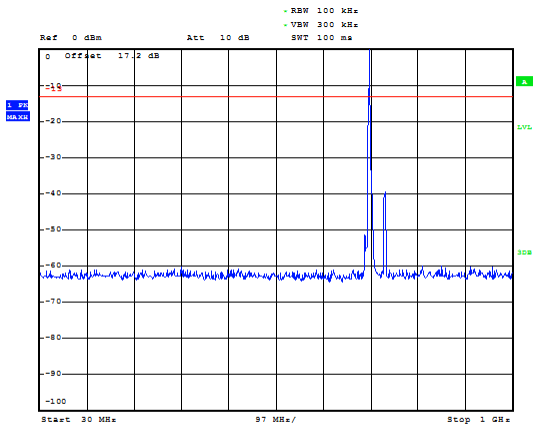

### LTE Band 12 5MHz CH- Middle 1GHz~9GHz

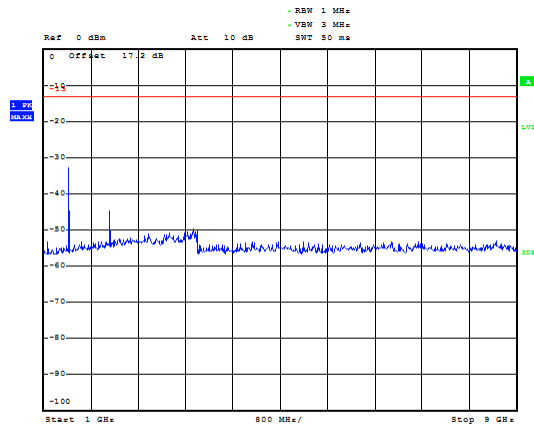

### LTE Band 12 5MHz CH-High 30MHz~1GHz

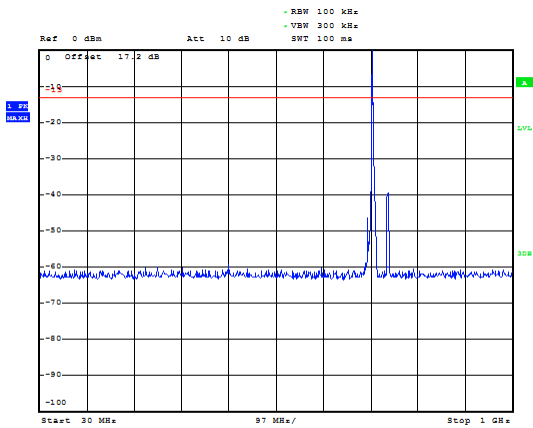

### LTE Band 12 5MHz CH-High 1GHz~9GHz

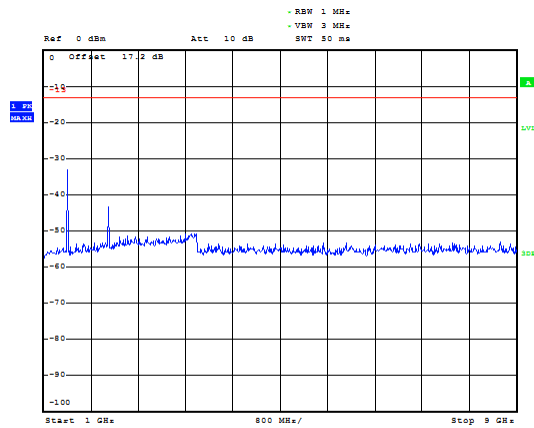



### LTE Band 12 10MHz CH-Low 30MHz~1GHz

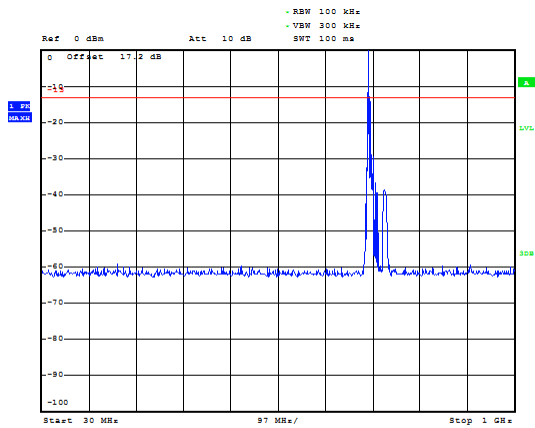

### LTE Band 12 10MHz CH-Low 1GHz~9GHz

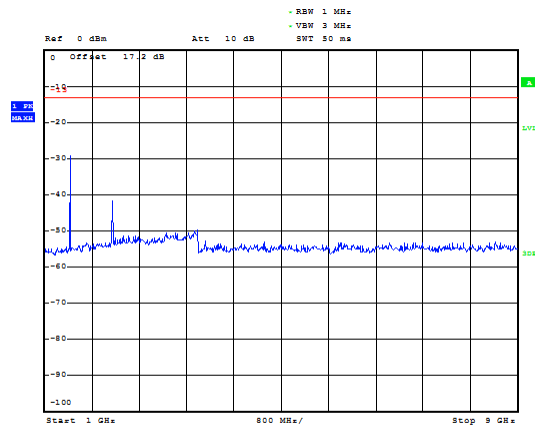

### LTE Band 12 10MHz CH- Middle 30MHz~1GHz

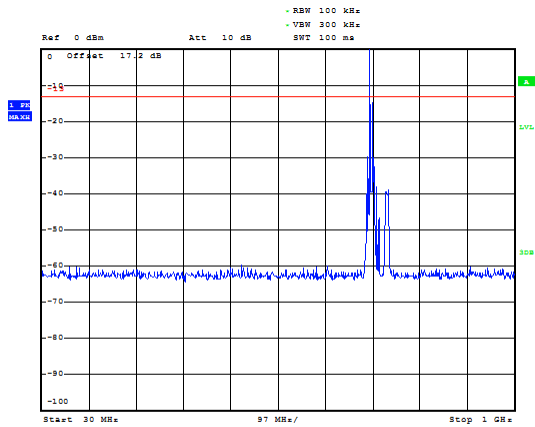

### LTE Band 12 10MHz CH- Middle 1GHz~9GHz

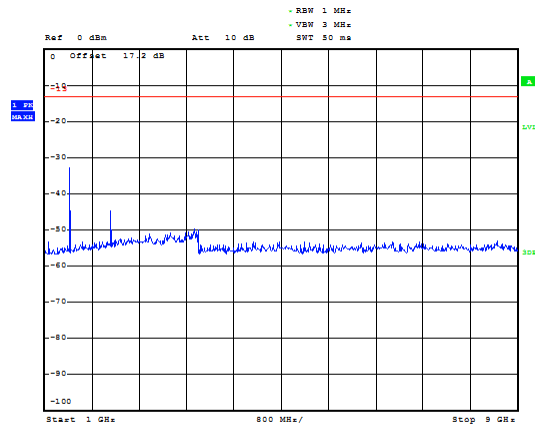

### LTE Band 12 10MHz CH-High 30MHz~1GHz

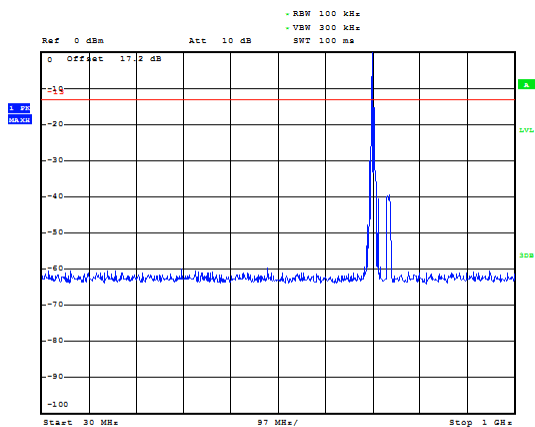

### LTE Band 12 10MHz CH-High 1GHz~9GHz

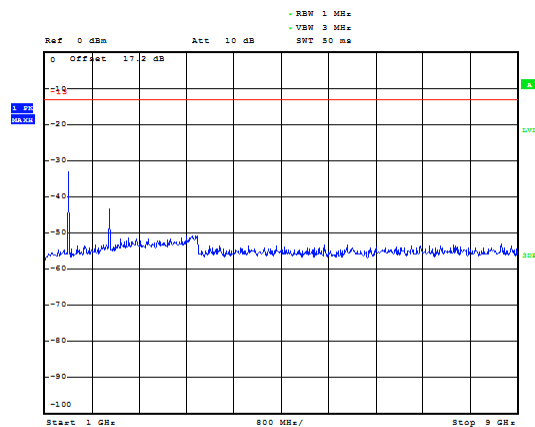





### LTE Band 13 5MHz CH-Low 30MHz~1GHz

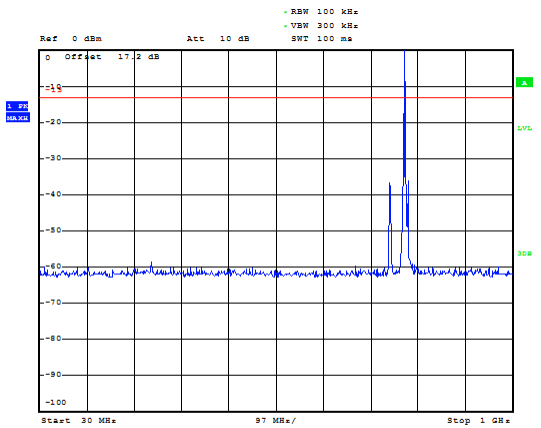

### LTE Band 13 5MHz CH-Low 1GHz~9GHz

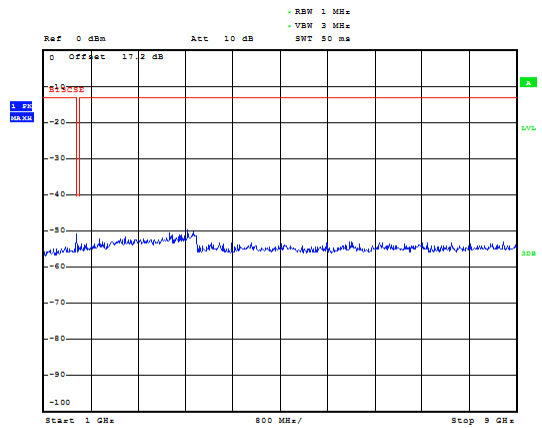

### LTE Band 13 5MHz CH-Middle 30MHz~1GHz

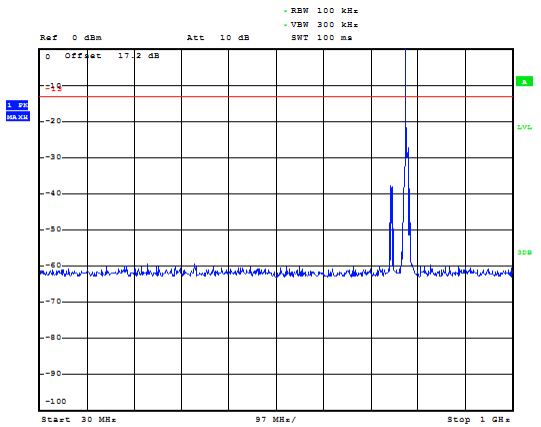

### LTE Band 13 5MHz CH-Middle 1GHz~9GHz

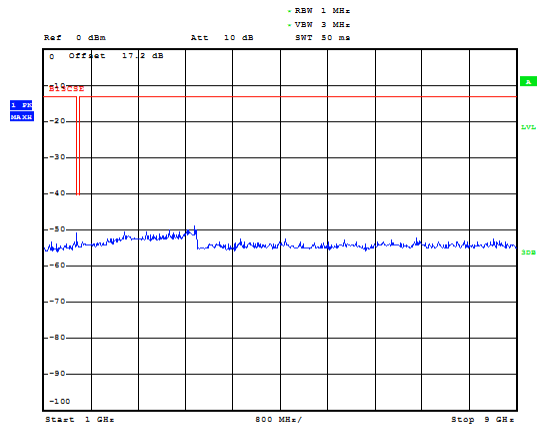

### LTE Band 13 5MHz CH-High 30MHz~1GHz

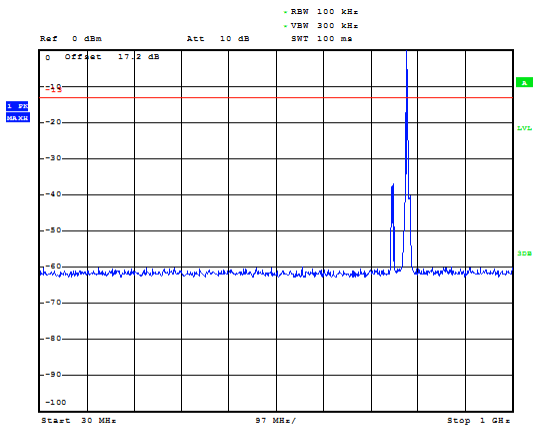

### LTE Band 13 5MHz CH-High 1GHz~9GHz

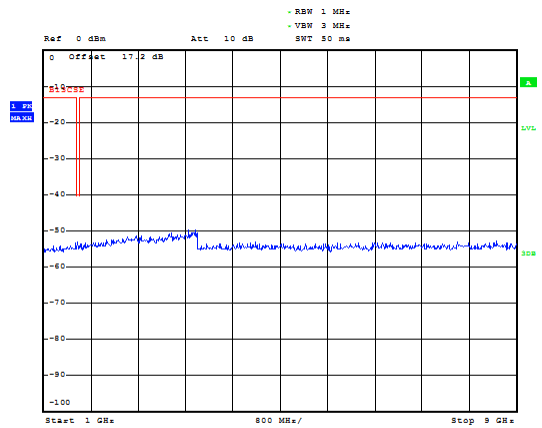

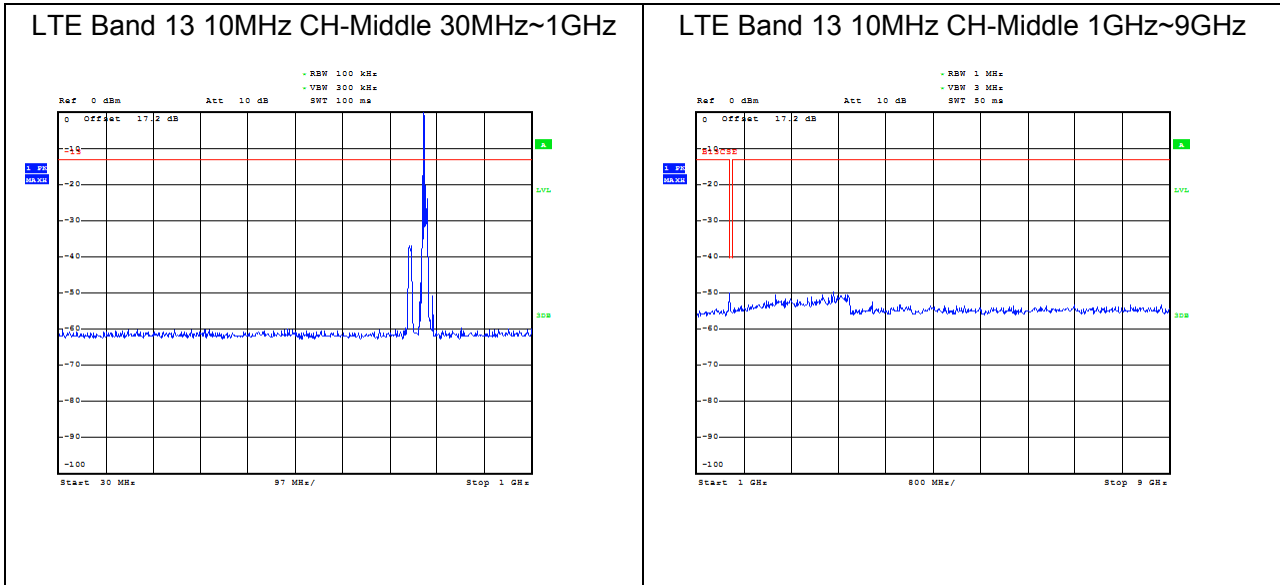

If disturbances were found more than 20dB below limit line, the mark is not required for the EUT. The signal beyond the limit is carrier in the following plots.

Test Data File Name	Frequency (MHz)	Level (dBm)	Limit (dBm)	Margin (dB)
B12_CHLOW_1.4M_RB1_1-9GHz	1354.05	-29.354	-13	16.354
B12_CHMID_1.4M_RB1_1-9GHz	1363.76	-32.162	-13	19.162
B12_CHLOW_3M_RB1_1-9GHz	1359.87	-29.333	-13	16.333
B12_CHMID_3M_RB1_1-9GHz	1365.74	-32.001	-13	19.001
B12_CHHIGH_3M_RB1_1-9GHz	1384.85	-32.764	-13	19.764
B12_CHLOW_5M_RB1_1-9GHz	1366.47	-28.969	-13	15.969
B12_CHMID_5M_RB1_1-9GHz	1376.10	-31.862	-13	18.862
B12_CHHIGH_5M_RB1_1-9GHz	1388.19	-32.753	-13	19.753
B12_CHLOW_10M_RB1_1-9GHz	1372.20	-29.043	-13	16.043
B12_CHMID_10M_RB1_1-9GHz	1378.11	-31.717	-13	18.717
B12_CHHIGH_10M_RB1_1-9GHz	1397.18	-32.472	-13	19.472

## 5.8 Radiates Spurious Emission

### Ambient condition

Temperature	Relative humidity	Pressure
23°C ~25°C	45%~50%	101.5kPa

### Method of Measurement

1. The testing follows FCC KDB 971168 D01 v03r01 Section 5.8 and ANSI/TIA-603-E (2016).
  2. The EUT is placed on a turntable 0.8 meters above the ground in the chamber, 3 meter away from the antenna. The maximal emission value is acquired by adjusting the antenna height, polarisation and turntable azimuth. Normally, the height range of antenna is 1 m to 4 m, the azimuth range of turntable is 0° to 360°, and the receive antenna has two polarizations Vertical (V) and Horizontal (H).
  3. A log-periodic antenna or double-ridged waveguide horn antenna shall be substituted in place of the EUT. The log-periodic antenna will be driven by a signal generator and the level will be adjusted till the same power value on the spectrum analyzer or receiver. The level of the spurious emissions can be calculated through the level of the signal generator, cable loss, the gain of the substitution antenna and the reading of the spectrum analyzer or receiver.
  4. The EUT is then put into continuously transmitting mode at its maximum power level during the test. Set Test Receiver or Spectrum RBW=1MHz, VBW=3MHz, And the maximum value of the receiver should be recorded as (Pr).
  5. The EUT shall be replaced by a substitution antenna. In the chamber, an substitution antenna for the frequency band of interest is placed at the reference point of the chamber. An RF Signal source for the frequency band of interest is connected to the substitution antenna with a cable that has been constructed to not interfere with the radiation pattern of the antenna. A power (PMea) is applied to the input of the substitution antenna, and adjust the level of the signal generator output until the value of the receiver reach the previously recorded (Pr). The power of signal source (PMea) is recorded. The test should be performed by rotating the test item and adjusting the receiving antenna polarization.
  6. A amplifier should be connected to the Signal Source output port. And the cable should be connect between the Amplifier and the Substitution Antenna. The cable loss (Pcl) ,the Substitution Antenna Gain (Ga) and the Amplifier Gain (PAg) should be recorded after test.
  7. The measurement results are obtained as described below:  

$$\text{Power(EIRP)} = \text{PMea} - \text{PAg} - \text{Pcl} + \text{Ga}$$
 The measurement results are amend as described below:  

$$\text{Power(EIRP)} = \text{PMea} - \text{Pcl} + \text{Ga}$$
  8. This value is EIRP since the measurement is calibrated using an antenna of known gain (2.15 dBi) and known input power. ERP can be calculated from EIRP by subtracting the gain of the dipole,  $\text{ERP} = \text{EIRP} - 2.15\text{dBi}$ .
- The modulation mode and RB allocation refer to section 5.1, using the maximum output power configuration.

**Test setup**

**30MHz~~~ 1GHz**

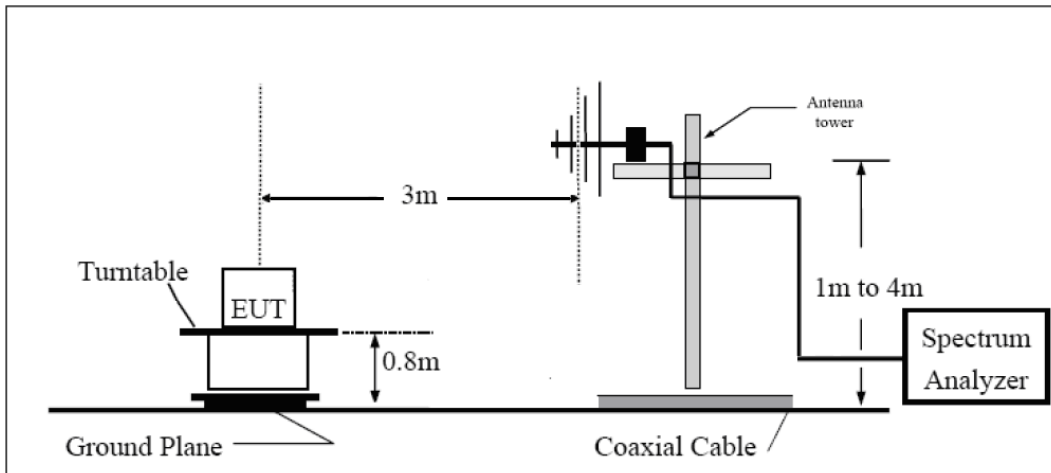

**Above 1GHz**

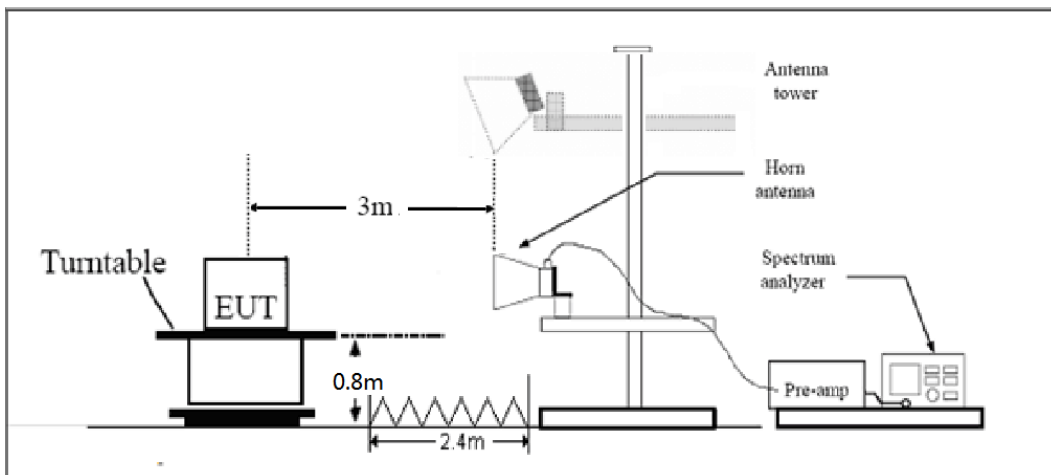

Note: Area side:2.4mX3.6m

The radiated emission was measured in the following position: EUT stand-up position (Z axis), lie-down position (X, Y axis). The worst emission was found in lie-down position (X axis) and the worst case was recorded.

**Limits**

Rule Part 27.53(h) specifies that “for operations in the 1695-1710 MHz, 1710-1755 MHz, 1755-1780 MHz, 1915-1920 MHz, 1995-2000 MHz, 2000-2020 MHz, 2110-2155 MHz, 2155-2180 MHz, and 2180-2200 bands, the power of any emission outside a licensee's frequency block shall be attenuated below the transmitter power (P) in watts by at least  $43 + 10 \log_{10} (P)$  dB..”

Rule Part 27.53 (g) For operations in the 600 MHz band and the 698-746 MHz band, the power of any emission outside a licensee's frequency band(s) of operation shall be attenuated below the transmitter power (P) within the licensed band(s) of operation, measured in watts, by at least  $43 + 10 \log (P)$  dB. Compliance with this provision is based on the use of measurement instrumentation employing a resolution bandwidth of 100 kilohertz or greater. However, in the 100 kilohertz bands



immediately outside and adjacent to a licensee's frequency block, a resolution bandwidth of at least 30 kHz may be employed.

Rule Part 27.53(f) For operations in the 746-758 MHz, 775-788 MHz, and 805-806 MHz bands, emissions in the band 1559-1610 MHz shall be limited to -70 dBW/MHz equivalent isotropically radiated power (EIRP) for wideband signals, and -80 dBW EIRP for discrete emissions of less than 700 Hz bandwidth. For the purpose of equipment authorization, a transmitter shall be tested with an antenna that is representative of the type that will be used with the equipment in normal operation.

Part 27.53(h)(g) Limit		-13 dBm
Part 27.53(f) Limit	Limit out of the band 1559-1610 MHz	-13 dBm
	Limit in the band 1559-1610 MHz	-40 dBm

**Measurement Uncertainty**

The assessed measurement uncertainty to ensure 95% confidence level for the normal distribution is with the coverage factor  $k = \pm 1.96$ ,  $U = \pm 3.55$  dB.

**Test Result**

Sweep the whole frequency band through the range from 30MHz to the 10th harmonic of the carrier, the emissions below the noise floor will not be recorded in the report.

**WCDMA Band IV CH-Low**

Harmonic	Frequency (MHz)	SG (dBm)	Cable Loss (dB)	Gain (dBi)	Antenna Polarization	EIRP Level (dBm)	Limit (dBm)	Margin (dB)	Azimuth (deg)
2	3424.8	-52.55	2.6	10.15	Horizontal	-45.00	-13.00	32.00	0
3	5137.2	-50.15	2.4	11.35	Horizontal	-41.20	-13.00	28.20	45
4	6849.6	-54.35	4.5	10.85	Horizontal	-48.00	-13.00	35.00	90
5	8562.0	-54.05	5.1	11.35	Horizontal	-47.80	-13.00	34.80	0
6	10274.4	-48.95	5.3	11.95	Horizontal	-42.30	-13.00	29.30	225
7	11986.8	-51.95	5.5	13.55	Horizontal	-43.90	-13.00	30.90	135
8	13699.2	-47.95	6.3	13.75	Horizontal	-40.50	-13.00	27.50	90
9	15411.6	-49.95	6.7	13.85	Horizontal	-42.80	-13.00	29.80	0
10	17124.0	-48.05	6.8	14.25	Horizontal	-40.60	-13.00	27.60	45

Note: 1. The other Spurious RF Radiated emissions level is no more than noise floor.

2. The worst emission was found in the antenna is Horizontal position.

**WCDMA Band IV CH-Middle**

Harmonic	Frequency (MHz)	SG (dBm)	Cable Loss (dB)	Gain (dBi)	Antenna Polarization	EIRP Level (dBm)	Limit (dBm)	Margin (dB)	Azimuth (deg)
2	3465.2	-52.15	2.6	10.75	Horizontal	-44.00	-13.00	31.00	45
3	5197.8	-50.95	2.4	11.05	Horizontal	-42.30	-13.00	29.30	0
4	6930.4	-55.85	4.5	11.15	Horizontal	-49.20	-13.00	36.20	225
5	8663.0	-53.95	5.1	11.35	Horizontal	-47.70	-13.00	34.70	135
6	10395.6	-49.25	5.3	11.95	Horizontal	-42.60	-13.00	29.60	180
7	12128.2	-52.95	5.5	13.55	Horizontal	-44.90	-13.00	31.90	315
8	13860.8	-47.45	6.3	13.75	Horizontal	-40.00	-13.00	27.00	0
9	15593.4	-50.15	6.7	13.85	Horizontal	-43.00	-13.00	30.00	0
10	17326.0	-48.25	6.8	14.25	Horizontal	-40.80	-13.00	27.80	90

Note: 1. The other Spurious RF Radiated emissions level is no more than noise floor.

2. The worst emission was found in the antenna is Horizontal position.

**WCDMA Band IV CH-High**

Harmonic	Frequency (MHz)	SG (dBm)	Cable Loss (dB)	Gain (dBi)	Antenna Polarization	EIRP Level (dBm)	Limit (dBm)	Margin (dB)	Azimuth (deg)
2	3505.2	-56.25	2.6	10.15	Horizontal	-48.70	-13.00	35.70	135
3	5254.1	-55.85	2.4	11.05	Horizontal	-47.20	-13.00	34.20	225
4	7010.4	-53.65	4.5	11.15	Horizontal	-47.00	-13.00	34.00	270
5	8763.0	-53.05	5.1	11.35	Horizontal	-46.80	-13.00	33.80	135
6	10515.6	-48.95	5.3	11.95	Horizontal	-42.30	-13.00	29.30	45
7	12268.2	-51.55	5.5	13.55	Horizontal	-43.50	-13.00	30.50	315
8	14020.8	-47.25	6.3	13.75	Horizontal	-39.80	-13.00	26.80	90
9	15773.4	-49.25	6.7	13.85	Horizontal	-42.10	-13.00	29.10	0
10	17526.0	-48.05	6.8	14.25	Horizontal	-40.60	-13.00	27.60	45

Note: 1. The other Spurious RF Radiated emissions level is no more than noise floor.  
 2. The worst emission was found in the antenna is Horizontal position.

**LTE Band 4 QPSK 1.4MHz CH-Low, RB 1**

Harmonic	Frequency (MHz)	SG (dBm)	Cable Loss (dB)	Gain (dBi)	Antenna Polarization	EIRP Level (dBm)	Limit (dBm)	Margin (dB)	Azimuth (deg)
2	3421.4	-49.15	2.6	10.15	Horizontal	-41.60	-13.00	28.60	0
3	5131.1	-44.85	2.4	11.35	Horizontal	-35.90	-13.00	22.90	0
4	6842.8	-52.95	4.5	10.85	Horizontal	-46.60	-13.00	33.60	45
5	8553.5	-53.05	5.1	11.35	Horizontal	-46.80	-13.00	33.80	315
6	10264.2	-51.15	5.3	11.95	Horizontal	-44.50	-13.00	31.50	315
7	11974.9	-51.15	5.5	13.55	Horizontal	-43.10	-13.00	30.10	315
8	13685.6	-48.95	6.3	13.75	Horizontal	-41.50	-13.00	28.50	270
9	15396.3	-47.65	6.7	13.85	Horizontal	-40.50	-13.00	27.50	90
10	17107.0	-47.25	6.8	14.25	Horizontal	-39.80	-13.00	26.80	45

Note: 1. The other Spurious RF Radiated emissions level is no more than noise floor.  
 2. The worst emission was found in the antenna is Horizontal position.

**LTE Band 4 QPSK 1.4MHz CH-Middle, RB 1**

Harmonic	Frequency (MHz)	SG (dBm)	Cable Loss (dB)	Gain (dBi)	Antenna Polarization	EIRP Level (dBm)	Limit (dBm)	Margin (dB)	Azimuth (deg)
2	3464.3	-51.85	2.6	10.75	Horizontal	-43.70	-13.00	30.70	135
3	5197.5	-44.75	2.4	11.05	Horizontal	-36.10	-13.00	23.10	180
4	6930.0	-53.95	4.5	11.15	Horizontal	-47.30	-13.00	34.30	180
5	8662.5	-52.75	5.1	11.35	Horizontal	-46.50	-13.00	33.50	180
6	10395.0	-50.85	5.3	11.95	Horizontal	-44.20	-13.00	31.20	45
7	12127.5	-51.65	5.5	13.55	Horizontal	-43.60	-13.00	30.60	315
8	13860.0	-49.15	6.3	13.75	Horizontal	-41.70	-13.00	28.70	45
9	15592.5	-47.65	6.7	13.85	Horizontal	-40.50	-13.00	27.50	135
10	17325.0	-46.05	6.8	14.25	Horizontal	-38.60	-13.00	25.60	45

Note: 1. The other Spurious RF Radiated emissions level is no more than noise floor.  
2. The worst emission was found in the antenna is Horizontal position.

**LTE Band 4 QPSK 1.4MHz CH-High, RB 1**

Harmonic	Frequency (MHz)	SG (dBm)	Cable Loss (dB)	Gain (dBi)	Antenna Polarization	EIRP Level (dBm)	Limit (dBm)	Margin (dB)	Azimuth (deg)
2	3507.8	-44.65	2.6	10.15	Horizontal	-37.10	-13.00	24.10	135
3	5261.6	-46.75	2.4	11.05	Horizontal	-38.10	-13.00	25.10	180
4	7017.2	-50.65	4.5	11.15	Horizontal	-44.00	-13.00	31.00	180
5	8771.5	-50.05	5.1	11.35	Horizontal	-43.80	-13.00	30.80	45
6	10525.8	-50.45	5.3	11.95	Horizontal	-43.80	-13.00	30.80	0
7	12280.1	-50.55	5.5	13.55	Horizontal	-42.50	-13.00	29.50	0
8	14034.4	-48.65	6.3	13.75	Horizontal	-41.20	-13.00	28.20	135
9	15788.7	-46.85	6.7	13.85	Horizontal	-39.70	-13.00	26.70	90
10	17543.0	-45.65	6.8	14.25	Horizontal	-38.20	-13.00	25.20	270

Note: 1. The other Spurious RF Radiated emissions level is no more than noise floor.  
2. The worst emission was found in the antenna is Horizontal position.



**LTE Band 4 QPSK 5MHz CH-Low, RB 1**

Harmonic	Frequency (MHz)	SG (dBm)	Cable Loss (dB)	Gain (dBi)	Antenna Polarization	EIRP Level (dBm)	Limit (dBm)	Margin (dB)	Azimuth (deg)
2	3425.0	-49.45	2.6	10.15	Horizontal	-41.90	-13.00	28.90	0
3	5131.1	-45.05	2.4	11.35	Horizontal	-36.10	-13.00	23.10	90
4	6850.0	-53.35	4.5	10.85	Horizontal	-47.00	-13.00	34.00	180
5	8562.5	-53.45	5.1	11.35	Horizontal	-47.20	-13.00	34.20	270
6	10275.0	-50.15	5.3	11.95	Horizontal	-43.50	-13.00	30.50	315
7	11987.5	-50.75	5.5	13.55	Horizontal	-42.70	-13.00	29.70	135
8	13700.0	-47.15	6.3	13.75	Horizontal	-39.70	-13.00	26.70	180
9	15412.5	-49.15	6.7	13.85	Horizontal	-42.00	-13.00	29.00	45
10	17125.0	-46.65	6.8	14.25	Horizontal	-39.20	-13.00	26.20	90

Note: 1.The other Spurious RF Radiated emissions level is no more than noise floor.  
2. The worst emission was found in the antenna is Horizontal position.

**LTE Band 4 QPSK 5MHz CH-Middle, RB 1**

Harmonic	Frequency (MHz)	SG (dBm)	Cable Loss (dB)	Gain (dBi)	Antenna Polarization	EIRP Level (dBm)	Limit (dBm)	Margin (dB)	Azimuth (deg)
2	3460.5	-53.25	2.6	10.75	Horizontal	-45.10	-13.00	32.10	0
3	5191.5	-44.85	2.4	11.05	Horizontal	-36.20	-13.00	23.20	0
4	6930.0	-53.85	4.5	11.15	Horizontal	-47.20	-13.00	34.20	0
5	8662.5	-52.65	5.1	11.35	Horizontal	-46.40	-13.00	33.40	90
6	10395.0	-50.45	5.3	11.95	Horizontal	-43.80	-13.00	30.80	315
7	12127.5	-50.55	5.5	13.55	Horizontal	-42.50	-13.00	29.50	45
8	13860.0	-46.85	6.3	13.75	Horizontal	-39.40	-13.00	26.40	45
9	15592.5	-49.05	6.7	13.85	Horizontal	-41.90	-13.00	28.90	90
10	17325.0	-46.25	6.8	14.25	Horizontal	-38.80	-13.00	25.80	135

Note: 1.The other Spurious RF Radiated emissions level is no more than noise floor.  
2. The worst emission was found in the antenna is Horizontal position.

**LTE Band 4 QPSK 5MHz CH-High, RB 1**

Harmonic	Frequency (MHz)	SG (dBm)	Cable Loss (dB)	Gain (dBi)	Antenna Polarization	EIRP Level (dBm)	Limit (dBm)	Margin (dB)	Azimuth (deg)
2	3500.6	-44.75	2.6	10.15	Horizontal	-37.20	-13.00	24.20	0
3	5251.1	-47.95	2.4	11.05	Horizontal	-39.30	-13.00	26.30	90
4	7010.0	-52.75	4.5	11.15	Horizontal	-46.10	-13.00	33.10	180
5	8762.5	-52.05	5.1	11.35	Horizontal	-45.80	-13.00	32.80	315
6	10515.0	-50.15	5.3	11.95	Horizontal	-43.50	-13.00	30.50	135
7	12267.5	-50.15	5.5	13.55	Horizontal	-42.10	-13.00	29.10	180
8	14020.0	-46.35	6.3	13.75	Horizontal	-38.90	-13.00	25.90	45
9	15772.5	-46.65	6.7	13.85	Horizontal	-39.50	-13.00	26.50	90
10	17525.0	-45.05	6.8	14.25	Horizontal	-37.60	-13.00	24.60	0

Note: 1.The other Spurious RF Radiated emissions level is no more than noise floor.  
 2. The worst emission was found in the antenna is Horizontal position.

**LTE Band 4 QPSK 20MHz CH-Low, RB 1**

Harmonic	Frequency (MHz)	SG (dBm)	Cable Loss (dB)	Gain (dBi)	Antenna Polarization	EIRP Level (dBm)	Limit (dBm)	Margin (dB)	Azimuth (deg)
2	3440.0	-49.75	2.6	10.15	Horizontal	-42.20	-13.00	29.20	90
3	5133.4	-44.55	2.4	11.35	Horizontal	-35.60	-13.00	22.60	45
4	6880.0	-53.25	4.5	10.85	Horizontal	-46.90	-13.00	33.90	180
5	8600.0	-51.95	5.1	11.35	Horizontal	-45.70	-13.00	32.70	315
6	10320.0	-49.15	5.3	11.95	Horizontal	-42.50	-13.00	29.50	45
7	12040.0	-51.75	5.5	13.55	Horizontal	-43.70	-13.00	30.70	0
8	13760.0	-49.55	6.3	13.75	Horizontal	-42.10	-13.00	29.10	45
9	15480.0	-48.35	6.7	13.85	Horizontal	-41.20	-13.00	28.20	90
10	17200.0	-46.15	6.8	14.25	Horizontal	-38.70	-13.00	25.70	315

Note: 1.The other Spurious RF Radiated emissions level is no more than noise floor.  
 2. The worst emission was found in the antenna is Horizontal position.

**LTE Band 4 QPSK 20MHz CH-Middle, RB 1**

Harmonic	Frequency (MHz)	SG (dBm)	Cable Loss (dB)	Gain (dBi)	Antenna Polarization	EIRP Level (dBm)	Limit (dBm)	Margin (dB)	Azimuth (deg)
2	3465.0	-56.25	2.6	10.75	Horizontal	-48.10	-13.00	35.10	135
3	5170.9	-47.65	2.4	11.05	Horizontal	-39.00	-13.00	26.00	180
4	6930.0	-54.05	4.5	11.15	Horizontal	-47.40	-13.00	34.40	45
5	8662.5	-51.75	5.1	11.35	Horizontal	-45.50	-13.00	32.50	90
6	10395.0	-49.45	5.3	11.95	Horizontal	-42.80	-13.00	29.80	0
7	12127.5	-50.15	5.5	13.55	Horizontal	-42.10	-13.00	29.10	90
8	13860.0	-48.65	6.3	13.75	Horizontal	-41.20	-13.00	28.20	45
9	15592.5	-48.55	6.7	13.85	Horizontal	-41.40	-13.00	28.40	180
10	17325.0	-45.65	6.8	14.25	Horizontal	-38.20	-13.00	25.20	315

Note: 1.The other Spurious RF Radiated emissions level is no more than noise floor.  
2. The worst emission was found in the antenna is Horizontal position.

**LTE Band 4 QPSK 20MHz CH-High, RB 1**

Harmonic	Frequency (MHz)	SG (dBm)	Cable Loss (dB)	Gain (dBi)	Antenna Polarization	EIRP Level (dBm)	Limit (dBm)	Margin (dB)	Azimuth (deg)
2	3490.0	-48.45	2.6	10.15	Horizontal	-40.90	-13.00	27.9	45
3	5208.4	-45.45	2.4	11.05	Horizontal	-36.80	-13.00	23.8	180
4	6980.0	-53.45	4.5	11.15	Horizontal	-46.80	-13.00	33.8	315
5	8725.0	-50.85	5.1	11.35	Horizontal	-44.60	-13.00	31.6	45
6	10470.0	-48.75	5.3	11.95	Horizontal	-42.10	-13.00	29.1	0
7	12215.0	-49.85	5.5	13.55	Horizontal	-41.80	-13.00	28.8	45
8	13960.0	-48.95	6.3	13.75	Horizontal	-41.50	-13.00	28.5	90
9	15705.0	-46.65	6.7	13.85	Horizontal	-39.50	-13.00	26.5	315
10	17450.0	-45.55	6.8	14.25	Horizontal	-38.10	-13.00	25.1	135

Note: 1.The other Spurious RF Radiated emissions level is no more than noise floor.  
2. The worst emission was found in the antenna is Horizontal position.

**LTE Band 12 QPSK 1.4MHz CH-Low, RB 1**

Harmonic	Frequency (MHz)	SG (dBm)	Cable Loss (dB)	Gain (dBi)	Antenna Polarization	ERP Level (dBm)	Limit (dBm)	Margin (dB)	Azimuth (deg)
2	1399.4	-55.90	2.00	10.15	Horizontal	-49.90	-13.00	36.90	180
3	2099.1	-58.90	2.50	11.35	Horizontal	-52.20	-13.00	39.20	315
4	2798.8	-59.40	4.20	10.85	Horizontal	-54.90	-13.00	36.90	45
5	3498.5	-58.60	5.20	11.35	Horizontal	-54.60	-13.00	41.60	180
6	4198.2	-58.50	5.50	11.95	Horizontal	-54.20	-13.00	41.20	315
7	4897.9	-59.10	5.70	13.55	Horizontal	-53.40	-13.00	40.40	45
8	5597.6	-56.50	6.30	13.75	Horizontal	-51.20	-13.00	38.20	0
9	6297.3	-55.50	6.80	13.85	Horizontal	-50.60	-13.00	37.60	45
10	6997.0	-53.00	6.90	14.25	Horizontal	-47.80	-13.00	34.80	90

Note: 1.The other Spurious RF Radiated emissions level is no more than noise floor.  
2. The worst emission was found in the antenna is Horizontal position.

**LTE Band 12 QPSK 1.4MHz CH-Middle, RB 1**

Harmonic	Frequency (MHz)	SG (dBm)	Cable Loss (dB)	Gain (dBi)	Antenna Polarization	ERP Level (dBm)	Limit (dBm)	Margin (dB)	Azimuth (deg)
2	1415.0	-58.50	2.00	10.75	Horizontal	-51.90	-13.00	38.90	45
3	2122.5	-58.09	2.51	11.05	Horizontal	-51.70	-13.00	38.70	0
4	2830.0	-58.60	4.20	11.15	Horizontal	-53.80	-13.00	40.80	315
5	3537.5	-58.60	5.20	11.15	Horizontal	-54.80	-13.00	41.80	315
6	4245.0	-58.90	5.50	11.95	Horizontal	-54.60	-13.00	41.60	135
7	4952.5	-59.10	5.70	13.55	Horizontal	-53.40	-13.00	40.40	45
8	5660.0	-56.70	6.30	13.75	Horizontal	-51.40	-13.00	38.40	0
9	6367.5	-55.10	6.80	13.85	Horizontal	-50.20	-13.00	37.20	315
10	7075.0	-52.70	6.90	14.25	Horizontal	-47.50	-13.00	34.50	135

Note: 1.The other Spurious RF Radiated emissions level is no more than noise floor.  
2. The worst emission was found in the antenna is Horizontal position.

**LTE Band 12 QPSK 1.4MHz CH-High, RB 1**

Harmonic	Frequency (MHz)	SG (dBm)	Cable Loss (dB)	Gain (dBi)	Antenna Polarization	ERP Level (dBm)	Limit (dBm)	Margin (dB)	Azimuth (deg)
2	1430.6	-60.50	2.00	10.15	Horizontal	-54.50	-13.00	41.50	0
3	2145.9	-58.19	2.51	11.05	Horizontal	-51.80	-13.00	38.80	135
4	2861.2	-59.50	4.20	11.15	Horizontal	-54.70	-13.00	41.70	45
5	3576.5	-58.10	5.20	11.15	Horizontal	-54.30	-13.00	41.30	180
6	4291.8	-58.00	5.50	11.95	Horizontal	-53.70	-13.00	40.70	45
7	5007.1	-59.10	5.70	13.55	Horizontal	-53.40	-13.00	40.40	90
8	5722.4	-56.30	6.30	13.75	Horizontal	-51.00	-13.00	38.00	45
9	6437.7	-54.10	6.80	13.85	Horizontal	-49.20	-13.00	36.20	90
10	7153.0	-52.10	6.90	14.25	Horizontal	-46.90	-13.00	33.90	315

Note: 1.The other Spurious RF Radiated emissions level is no more than noise floor.  
2. The worst emission was found in the antenna is Horizontal position.

**LTE Band 12 QPSK 5MHz CH-Low, RB 1**

Harmonic	Frequency (MHz)	SG (dBm)	Cable Loss (dB)	Gain (dBi)	Antenna Polarization	ERP Level (dBm)	Limit (dBm)	Margin (dB)	Azimuth (deg)
2	1403.0	-54.10	2.00	10.15	Horizontal	-48.10	-13.00	35.10	180
3	2104.5	-59.70	2.50	11.35	Horizontal	-53.00	-13.00	40.00	45
4	2806.0	-59.10	4.20	10.85	Horizontal	-54.60	-13.00	41.60	90
5	3507.5	-58.70	5.20	11.35	Horizontal	-54.70	-13.00	41.70	90
6	4209.0	-58.90	5.50	11.95	Horizontal	-54.60	-13.00	41.60	315
7	4910.5	-59.90	5.70	13.55	Horizontal	-54.20	-13.00	41.20	135
8	5612.0	-57.60	6.30	13.75	Horizontal	-52.30	-13.00	39.30	45
9	6313.5	-55.70	6.80	13.85	Horizontal	-50.80	-13.00	37.80	0
10	7015.0	-53.20	6.90	14.25	Horizontal	-48.00	-13.00	35.00	315

Note: 1.The other Spurious RF Radiated emissions level is no more than noise floor.  
2. The worst emission was found in the antenna is Horizontal position.

**LTE Band 12 QPSK 5MHz CH-Middle, RB 1**

Harmonic	Frequency (MHz)	SG (dBm)	Cable Loss (dB)	Gain (dBi)	Antenna Polarization	ERP Level (dBm)	Limit (dBm)	Margin (dB)	Azimuth (deg)
2	1415.0	-59.60	2.00	10.75	Horizontal	-53.00	-13.00	40.00	45
3	2122.5	-59.99	2.51	11.05	Horizontal	-53.60	-13.00	40.60	90
4	2830.0	-59.00	4.20	11.15	Horizontal	-54.20	-13.00	41.20	315
5	3537.5	-58.70	5.20	11.15	Horizontal	-54.90	-13.00	41.90	45
6	4245.0	-58.90	5.50	11.95	Horizontal	-54.60	-13.00	41.60	0
7	4952.5	-59.10	5.70	13.55	Horizontal	-53.40	-13.00	40.40	315
8	5660.0	-57.40	6.30	13.75	Horizontal	-52.10	-13.00	39.10	135
9	6367.5	-55.40	6.80	13.85	Horizontal	-50.50	-13.00	37.50	180
10	7075.0	-52.80	6.90	14.25	Horizontal	-47.60	-13.00	34.60	45

Note: 1.The other Spurious RF Radiated emissions level is no more than noise floor.  
 2. The worst emission was found in the antenna is Horizontal position.

**LTE Band 12 QPSK 5MHz CH-High, RB 1**

Harmonic	Frequency (MHz)	SG (dBm)	Cable Loss (dB)	Gain (dBi)	Antenna Polarization	ERP Level (dBm)	Limit (dBm)	Margin (dB)	Azimuth (deg)
2	1427.0	-56.60	2.00	10.15	Horizontal	-50.60	-13.00	37.60	135
3	2140.5	-59.09	2.51	11.05	Horizontal	-52.70	-13.00	39.70	45
4	2854.0	-59.10	4.20	11.15	Horizontal	-54.30	-13.00	41.30	0
5	3567.5	-58.40	5.20	11.15	Horizontal	-54.60	-13.00	41.60	90
6	4281.0	-57.80	5.50	11.95	Horizontal	-53.50	-13.00	40.50	45
7	4994.5	-58.30	5.70	13.55	Horizontal	-52.60	-13.00	39.60	90
8	5708.0	-57.30	6.30	13.75	Horizontal	-52.00	-13.00	39.00	315
9	6421.5	-55.10	6.80	13.85	Horizontal	-50.20	-13.00	37.20	135
10	7135.0	-52.60	6.90	14.25	Horizontal	-47.40	-13.00	34.40	45

Note: 1.The other Spurious RF Radiated emissions level is no more than noise floor.  
 2. The worst emission was found in the antenna is Horizontal position.

**LTE Band 12 QPSK 10MHz CH-Low, RB 1**

Harmonic	Frequency (MHz)	SG (dBm)	Cable Loss (dB)	Gain (dBi)	Antenna Polarization	ERP Level (dBm)	Limit (dBm)	Margin (dB)	Azimuth (deg)
2	1408.0	-56.40	2.00	10.15	Horizontal	-50.40	-13.00	37.40	90
3	2112.0	-59.89	2.51	11.35	Horizontal	-53.20	-13.00	40.20	315
4	2816.0	-59.60	4.20	10.85	Horizontal	-55.10	-13.00	42.10	180
5	3520.0	-60.40	5.20	11.35	Horizontal	-56.40	-13.00	43.40	135
6	4224.0	-60.20	5.50	11.95	Horizontal	-55.90	-13.00	42.90	180
7	4928.0	-60.10	5.70	13.55	Horizontal	-54.40	-13.00	41.40	45
8	5632.0	-57.10	6.30	13.75	Horizontal	-51.80	-13.00	38.80	90
9	6336.0	-55.40	6.80	13.85	Horizontal	-50.50	-13.00	37.50	45
10	7040.0	-53.50	6.90	14.25	Horizontal	-48.30	-13.00	35.30	225

Note: 1.The other Spurious RF Radiated emissions level is no more than noise floor.  
2. The worst emission was found in the antenna is Horizontal position.

**LTE Band 12 QPSK 10MHz CH-Middle, RB 1**

Harmonic	Frequency (MHz)	SG (dBm)	Cable Loss (dB)	Gain (dBi)	Antenna Polarization	ERP Level (dBm)	Limit (dBm)	Margin (dB)	Azimuth (deg)
2	1415.0	-61.40	2.00	10.75	Horizontal	-54.80	-13.00	41.80	135
3	2122.5	-59.49	2.51	11.05	Horizontal	-53.10	-13.00	40.10	225
4	2830.0	-60.40	4.20	11.15	Horizontal	-55.60	-13.00	42.60	45
5	3537.5	-60.00	5.20	11.15	Horizontal	-56.20	-13.00	43.20	45
6	4245.0	-59.50	5.50	11.95	Horizontal	-55.20	-13.00	42.20	90
7	4952.5	-59.60	5.70	13.55	Horizontal	-53.90	-13.00	40.90	315
8	5660.0	-58.80	6.30	13.75	Horizontal	-53.50	-13.00	40.50	90
9	6367.5	-55.50	6.80	13.85	Horizontal	-50.60	-13.00	37.60	315
10	7075.0	-52.20	6.90	14.25	Horizontal	-47.00	-13.00	34.00	135

Note: 1.The other Spurious RF Radiated emissions level is no more than noise floor.  
2. The worst emission was found in the antenna is Horizontal position.

**LTE Band 12 QPSK 10MHz CH-High, RB 1**

Harmonic	Frequency (MHz)	SG (dBm)	Cable Loss (dB)	Gain (dBi)	Antenna Polarization	ERP Level (dBm)	Limit (dBm)	Margin (dB)	Azimuth (deg)
2	1422.0	-58.1	2.00	10.15	Horizontal	-52.10	-13.00	39.10	0
3	2133.0	-58.59	2.51	11.05	Horizontal	-52.20	-13.00	39.20	315
4	2844.0	-60.1	4.20	11.15	Horizontal	-55.30	-13.00	42.30	225
5	3555.0	-59.7	5.20	11.15	Horizontal	-55.90	-13.00	42.90	45
6	4266.0	-59.3	5.50	11.95	Horizontal	-55.00	-13.00	42.00	45
7	4977.0	-59.9	5.70	13.55	Horizontal	-54.20	-13.00	41.20	135
8	5688.0	-57.3	6.30	13.75	Horizontal	-52.00	-13.00	39.00	180
9	6399.0	-55.7	6.80	13.85	Horizontal	-50.80	-13.00	37.80	45
10	7110.0	-51.6	6.90	14.25	Horizontal	-46.40	-13.00	33.40	90

Note: 1.The other Spurious RF Radiated emissions level is no more than noise floor.  
 2. The worst emission was found in the antenna is Horizontal position.

**LTE Band 13 QPSK 5MHz CH-Low, RB 1**

Harmonic	Frequency (MHz)	SG (dBm)	Cable Loss (dB)	Gain (dBi)	Antenna Polarization	ERP Level (dBm)	Limit (dBm)	Margin (dB)	Azimuth (deg)
2	1555.8	-56.40	2.00	10.15	Horizontal	-50.40	-40.00	10.40	45
3	2338.5	-54.50	2.50	11.35	Horizontal	-47.80	-13.00	34.80	90
4	3118.0	-61.40	4.20	10.85	Horizontal	-56.90	-13.00	43.90	45
5	3897.5	-58.50	5.20	11.35	Horizontal	-54.50	-13.00	41.50	135
6	4677.0	-58.00	5.50	11.95	Horizontal	-53.70	-13.00	40.70	180
7	5456.5	-56.60	5.70	13.55	Horizontal	-50.90	-13.00	37.90	45
8	6236.0	-56.10	6.30	13.75	Horizontal	-50.80	-13.00	37.80	90
9	7015.5	-52.90	6.80	13.85	Horizontal	-48.00	-13.00	35.00	45
10	7795.0	-53.70	6.90	14.25	Horizontal	-48.50	-13.00	35.50	0

Note: 1.The other Spurious RF Radiated emissions level is no more than noise floor.  
 2. The worst emission was found in the antenna is Horizontal position.



**LTE Band 13 QPSK 5MHz CH-Middle, RB 1**

Harmonic	Frequency (MHz)	SG (dBm)	Cable Loss (dB)	Gain (dBi)	Antenna Polarization	ERP Level (dBm)	Limit (dBm)	Margin (dB)	Azimuth (deg)
2	1564.0	-58.10	2.00	10.75	Horizontal	-51.50	-40.00	11.50	315
3	2346.0	-53.49	2.51	11.05	Horizontal	-47.10	-13.00	34.10	135
4	3128.0	-61.40	4.20	11.15	Horizontal	-56.60	-13.00	43.60	90
5	3910.0	-60.50	5.20	11.15	Horizontal	-56.70	-13.00	43.70	45
6	4692.0	-57.80	5.50	11.95	Horizontal	-53.50	-13.00	40.50	225
7	5474.0	-58.90	5.70	13.55	Horizontal	-53.20	-13.00	40.20	45
8	6256.0	-56.20	6.30	13.75	Horizontal	-50.90	-13.00	37.90	90
9	7038.0	-52.80	6.80	13.85	Horizontal	-47.90	-13.00	34.90	315
10	7820.0	-52.40	6.90	14.25	Horizontal	-47.20	-13.00	34.20	90

Note: 1.The other Spurious RF Radiated emissions level is no more than noise floor.  
2. The worst emission was found in the antenna is Horizontal position.

**LTE Band 13 QPSK 5MHz CH-High, RB 1**

Harmonic	Frequency (MHz)	SG (dBm)	Cable Loss (dB)	Gain (dBi)	Antenna Polarization	ERP Level (dBm)	Limit (dBm)	Margin (dB)	Azimuth (deg)
2	1569.0	-56.80	2.00	10.15	Horizontal	-50.80	-40.00	10.80	45
3	2353.5	-54.89	2.51	11.05	Horizontal	-48.50	-13.00	35.50	135
4	3138.0	-61.80	4.20	11.15	Horizontal	-57.00	-13.00	44.00	45
5	3922.5	-58.60	5.20	11.15	Horizontal	-54.80	-13.00	41.80	90
6	4707.0	-58.20	5.50	11.95	Horizontal	-53.90	-13.00	40.90	45
7	5491.5	-58.10	5.70	13.55	Horizontal	-52.40	-13.00	39.40	225
8	6276.0	-56.00	6.30	13.75	Horizontal	-50.70	-13.00	37.70	45
9	7060.5	-53.10	6.80	13.85	Horizontal	-48.20	-13.00	35.20	90
10	7845.0	-52.80	6.90	14.25	Horizontal	-47.60	-13.00	34.60	315

Note: 1.The other Spurious RF Radiated emissions level is no more than noise floor.  
2. The worst emission was found in the antenna is Horizontal position.

**LTE Band 13 QPSK 10MHz CH-Low, RB 1**

Harmonic	Frequency (MHz)	SG (dBm)	Cable Loss (dB)	Gain (dBi)	Antenna Polarization	ERP Level (dBm)	Limit (dBm)	Margin (dB)	Azimuth (deg)
2	1556.5	-56.20	2.00	10.15	Horizontal	-50.20	-40.00	10.20	180
3	2346.0	-55.99	2.51	11.35	Horizontal	-49.30	-13.00	36.30	45
4	3128.0	-61.30	4.20	10.85	Horizontal	-56.80	-13.00	43.80	135
5	3910.0	-59.40	5.20	11.35	Horizontal	-55.40	-13.00	42.40	45
6	4692.0	-57.20	5.50	11.95	Horizontal	-52.90	-13.00	39.90	135
7	5474.0	-58.80	5.70	13.55	Horizontal	-53.10	-13.00	40.10	180
8	6256.0	-56.20	6.30	13.75	Horizontal	-50.90	-13.00	37.90	45
9	7038.0	-52.60	6.80	13.85	Horizontal	-47.70	-13.00	34.70	90
10	7820.0	-53.10	6.90	14.25	Horizontal	-47.90	-13.00	34.90	45

Note: 1.The other Spurious RF Radiated emissions level is no more than noise floor.  
2. The worst emission was found in the antenna is Horizontal position.

**LTE Band 13 QPSK 10MHz CH-Middle, RB 1**

Harmonic	Frequency (MHz)	SG (dBm)	Cable Loss (dB)	Gain (dBi)	Antenna Polarization	ERP Level (dBm)	Limit (dBm)	Margin (dB)	Azimuth (deg)
2	1555.3	-57.10	2.00	10.75	Horizontal	-50.50	-40.00	10.50	90
3	2346.0	-55.89	2.51	11.05	Horizontal	-49.50	-13.00	36.50	45
4	3128.0	-61.80	4.20	11.15	Horizontal	-57.00	-13.00	44.00	90
5	3910.0	-58.30	5.20	11.15	Horizontal	-54.50	-13.00	41.50	315
6	4692.0	-57.50	5.50	11.95	Horizontal	-53.20	-13.00	40.20	90
7	5474.0	-58.00	5.70	13.55	Horizontal	-52.30	-13.00	39.30	45
8	6256.0	-56.50	6.30	13.75	Horizontal	-51.20	-13.00	38.20	90
9	7038.0	-52.30	6.80	13.85	Horizontal	-47.40	-13.00	34.40	45
10	7820.0	-52.80	6.90	14.25	Horizontal	-47.60	-13.00	34.60	0

Note: 1.The other Spurious RF Radiated emissions level is no more than noise floor.  
2. The worst emission was found in the antenna is Horizontal position.



## LTE Band 13 QPSK 10MHz CH-High, RB 1

Harmonic	Frequency (MHz)	SG (dBm)	Cable Loss (dB)	Gain (dBi)	Antenna Polarization	ERP Level (dBm)	Limit (dBm)	Margin (dB)	Azimuth (deg)
2	1564.0	-56.70	2.00	10.15	Horizontal	-50.70	-40.00	10.70	225
3	2346.0	-55.49	2.51	11.05	Horizontal	-49.10	-13.00	36.10	0
4	3128.0	-62.00	4.20	11.15	Horizontal	-57.20	-13.00	44.20	90
5	3910.0	-58.80	5.20	11.15	Horizontal	-55.00	-13.00	42.00	315
6	4692.0	-57.70	5.50	11.95	Horizontal	-53.40	-13.00	40.40	135
7	5474.0	-58.80	5.70	13.55	Horizontal	-53.10	-13.00	40.10	45
8	6256.0	-56.50	6.30	13.75	Horizontal	-51.20	-13.00	38.20	0
9	7038.0	-52.70	6.80	13.85	Horizontal	-47.80	-13.00	34.80	315
10	7820.0	-53.20	6.90	14.25	Horizontal	-48.00	-13.00	35.00	45

Note: 1. The other Spurious RF Radiated emissions level is no more than noise floor.

2. The worst emission was found in the antenna is Horizontal position.

## 6 Main Test Instruments

Name	Manufacturer	Type	Serial Number	Calibration Date	Expiration Date
Base Station Simulator	R&S	CMW500	113645	2018-05-20	2019-05-19
Power Splitter	Hua Xiang	SHX-GF2-2-13	10120101	2018-05-20	2019-05-19
Spectrum Analyzer	Key sight	N9010A	MY50210259	2018-05-20	2019-05-19
Signal Analyzer	R&S	FSV30	100815	2017-12-17	2018-12-16
Signal generator	R&S	SMB 100A	102594	2018-05-20	2019-05-19
EMI Test Receiver	R&S	ESCI	100948	2018-05-20	2019-05-19
Loop Antenna	SCHWARZBECK	FMZB1519	1519-047	2014-12-06	2019-12-05
Trilog Antenna	SCHWARZBECK	VUBL 9163	9163-201	2017-11-18	2020-11-17
Horn Antenna	R&S	HF907	100126	2014-12-06	2019-12-05
Horn Antenna	ETS-Lindgren	3160-09	00102643	2015-01-30	2020-01-29
Climatic Chamber	Re Ce	PT-30B	20101891	2015-07-18	2018-07-17
RF Cable	Agilent	SMA 15cm	0001	NA	NA
Preamplifier	R&S	SCU18	102327	2018-05-20	2019-05-19
MOB COMMS DC SUPPLY	Keysight	66319D	MY43004105	2018-05-20	2019-05-19
Software	R&S	EMC32	V 8.52.0	NA	NA

\*\*\*\*\*END OF REPORT \*\*\*\*\*