



RF TEST REPORT

Applicant Quectel Wireless Solutions Co., Ltd
FCC ID XMR201909EG91NAX
Product LTE Module
Brand Quectel
Model EG91-NAX
Report No. R1907A0406-R2
Issue Date November 21, 2019

TA Technology (Shanghai) Co., Ltd. tested the above equipment in accordance with the requirements in **FCC CFR47 Part 2 (2018)/ FCC CFR 47 Part 24E (2018)**. The test results show that the equipment tested is capable of demonstrating compliance with the requirements as documented in this report.

Performed by: Peng Tao

Approved by: Kai Xu

TA Technology (Shanghai) Co., Ltd.

No.145, Jintang Rd, Tangzhen Industry Park, Pudong Shanghai, China

TEL: +86-021-50791141/2/3

FAX: +86-021-50791141/2/3-8000



TABLE OF CONTENT

1. Test Laboratory	4
1.1. Notes of the test report.....	4
1.2. Testing Location	4
2. General Description of Equipment under Test.....	5
2.1. Applicant and Manufacturer Information	5
2.2. General information	5
3. Applied Standards.....	6
4. Test Configuration.....	7
5. Test Case Results.....	8
5.1. RF Power Output and Effective Radiated Power	8
5.2. Occupied Bandwidth	16
5.3. Band Edge Compliance.....	25
5.4. Peak-to-Average Power Ratio (PAPR)	32
5.5. Frequency Stability	34
5.6. Spurious Emissions at Antenna Terminals	37
5.7. Radiates Spurious Emission	44
6. Main Test Instruments	49

Summary of measurement results

No.	Test Case	Clause in FCC rules	Verdict
1	RF power output and Effective Radiated Power	2.1046 24.232(c)	PASS
2	Occupied Bandwidth	2.1049	PASS
3	Band Edge Compliance	2.1051 /24.238(a)	PASS
4	Peak-to-Average Power Ratio	24.232/KDB 971168 D01(5.7)	PASS
5	Frequency Stability	2.1055 / 24.235	PASS
6	Spurious Emissions at Antenna Terminals	2.1051 / 24.238(a)	PASS
7	Radiates Spurious Emission	2.1053 / 24.238(a)	PASS
Note: PASS: The EUT complies with the essential requirements in the standard. FAIL: The EUT does not comply with the essential requirements in the standard.			
Date of Testing: October 22, 2019 ~ November 9, 2019			



1. Test Laboratory

1.1. Notes of the test report

This report shall not be reproduced in full or partial, without the written approval of **TA technology (shanghai) co., Ltd.** The results documented in this report apply only to the tested sample, under the conditions and modes of operation as described herein. Measurement Uncertainties were not taken into account and are published for informational purposes only. This report is written to support regulatory compliance of the applicable standards stated above.

1.2. Testing Location

Company: TA Technology (Shanghai) Co., Ltd.
Address: No.145, Jintang Rd, Tangzhen Industry Park, Pudong
City: Shanghai
Post code: 201201
Country: P. R. China
Contact: Xu Kai
Telephone: +86-021-50791141/2/3
Fax: +86-021-50791141/2/3-8000
Website: <http://www.ta-shanghai.com>
E-mail: xukai@ta-shanghai.com

2. General Description of Equipment under Test

2.1. Applicant and Manufacturer Information

Applicant	Quectel Wireless Solutions Co., Ltd
Applicant address	Building 5, Shanghai Business Park Phase III (Area B), No.1016 Tianlin Road, Minhang District, Shanghai, China 200233
Manufacturer	Quectel Wireless Solutions Co., Ltd
Manufacturer address	Building 5, Shanghai Business Park Phase III (Area B), No.1016 Tianlin Road, Minhang District, Shanghai, China 200233

2.2. General information

EUT Description			
Model	EG91-NAX		
IMEI	868050040003283		
Hardware Version	R1.0		
Software Version	EG91NAXGAR07A01M1G		
Power Supply	External Power Supply		
Antenna Type	The EUT don't have standard Antenna, The Antenna used for testing in this report is the after-market accessory (Dipole Antenna)		
Antenna Gain	4dBi		
Test Mode(s)	LTE Band 25;		
Test Modulation	(LTE)QPSK,16QAM		
LTE Category	1		
Maximum E.I.R.P	LTE Band 25:	25.47dBm	
Rated Power Supply Voltage	3.8V		
Extreme Voltage	Minimum: 3.3V Maximum: 4.3V		
Extreme Temperature	Lowest: -40°C Highest: +85°C		
Operating Frequency Range(s)	Band	Tx (MHz)	Rx (MHz)
	LTE Band 25	1850 ~ 1915	1930 ~ 1995
Note: 1. The information of the EUT is declared by the manufacturer. 2. For LTE, 16QAM only supports 25%RB.			

3. Applied Standards

According to the specifications of the manufacturer, it must comply with the requirements of the following standards:

Test standards:

FCC CFR 47 Part 24E (2018)

ANSI C63.26 (2015)

Reference standard:

FCC CFR47 Part 2 (2018)

KDB 971168 D01 Power Meas License Digital Systems v03r01

4. Test Configuration

Radiated measurements are performed by rotating the EUT in three different orthogonal test planes. EUT stand-up position (Z axis), lie-down position (X, Y axis). Receiver antenna polarization (horizontal and vertical), the worst emission was found in position (X axis, vertical polarization) and the worst case was recorded.

All mode and data rates and positions and RB size and modulations were investigated.

Subsequently, only the worst case emissions are reported.

The following testing in LTE is set based on the maximum RF Output Power.

Test modes are chosen to be reported as the worst case configuration below for LTE Band 25:

Test items	Bandwidth (MHz)						Modulation		RB			Test Channel		
	1.4	3	5	10	15	20	QPSK	16QAM	1	50%	100%	L	M	H
RF power output and Effective Isotropic Radiated power	O	O	O	O	O	O	O	O	O	O	O	O	O	O
Occupied Bandwidth	O	O	O	O	O	O	O	O	-	-	O	O	O	O
Band Edge Compliance	O	O	O	O	O	O	O	O	O	-	O	O	-	O
Peak-to-Average Power Ratio	O	O	O	O	O	O	O	O	-	-	O	O	O	O
Frequency Stability	-	-	-	-	O	O	O	O	-	-	O	-	O	-
Conducted Spurious Emissions	O	O	O	O	O	O	O	-	O	-	-	O	O	O
Radiates Spurious Emission	O	-	O	-	-	O	O	-	O	-	-	-	O	-
Note	1. The mark "O" means that this configuration is chosen for testing. 2. The mark "-" means that this configuration is not testing. 3. For LTE, 16QAM only supports 25%RB.													

5. Test Case Results

5.1.RF Power Output and Effective Radiated Power

Ambient condition

Temperature	Relative humidity	Pressure
23°C ~25°C	45%~50%	101.5kPa

Methods of Measurement

The testing follows FCC KDB 971168 v03r01 Section 5.8 and ANSI C63.26 (2015).

- a) Connect the equipment as illustrated. Mount the equipment with the manufacturer specified antenna in a vertical orientation on a manufacturer specified mounting surface located on a non-conducting rotating platform of a RF anechoic chamber (preferred) or a standard radiation site.
- b) Key the transmitter, then rotate the EUT 360° azimuthally and record spectrum analyzer power level (LVL) measurements at angular increments that are sufficiently small to permit resolution of all peaks. If a standard radiation test site is used, raise and lower the test antenna to obtain a maximum reading at each angular increment. (Note: several batteries may be needed to offset the effect of battery voltage droop, which should not exceed 5% of the manufactured specified battery voltage during transmission).
- c) Replace the transmitter under test with a vertically polarized half-wave dipole (or an antenna whose gain is known relative to an ideal half-wave dipole). The center of the antenna should be at the same location as the center of the antenna under test.
- d) Connect the antenna to a signal generator with a known output power and record the path loss (in dB) as LOSS. If a standard radiation test site is used, raise and lower the test antenna to obtain a maximum reading. $LOSS = \text{Generator Output Power (dBm)} - \text{Analyzer reading (dBm)}$
- e) Determine the effective radiated output power at each angular position from the readings in steps b) and d) using the following equation: $ERP \text{ (dBm)} = \text{LVL (dBm)} + \text{LOSS (dB)}$
- f) The maximum ERP is the maximum value determined in the preceding step.
- g) When calculating ERP, in addition to knowing the antenna radiation and matching characteristics, it is necessary to know the loss values of all elements (e.g.transmission line attenuation, mismatches, filters, combiners) interposed between the point where transmitter output power is measured, and the point where power is applied to the antenna. ERP can then be calculated as follows:
 $EIRP \text{ (dBm)} = \text{Output Power (dBm)} - \text{Losses (dB)} + \text{Antenna Gain (dBi)}$
where:dBd refers to gain relative to an ideal dipole.
 $EIRP \text{ (dBm)} = ERP \text{ (dBm)} + 2.15 \text{ (dB.)}$

The RB allocation refers to section 5.1, using the maximum output power configuration.

Test Setup

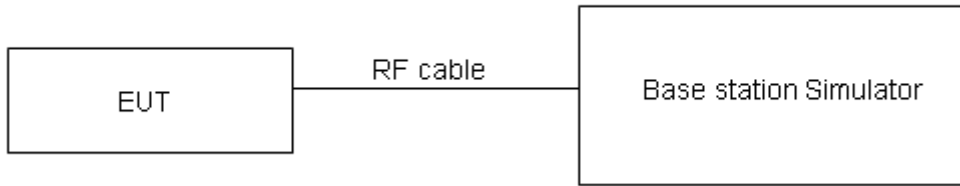

The loss between RF output port of the EUT and the input port of the tester has been taken into consideration.

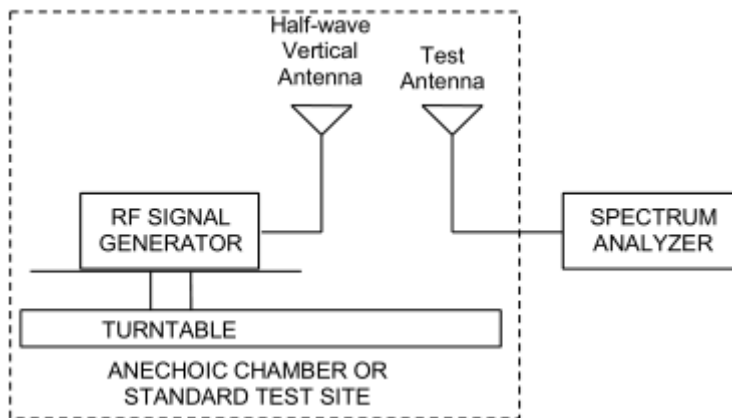
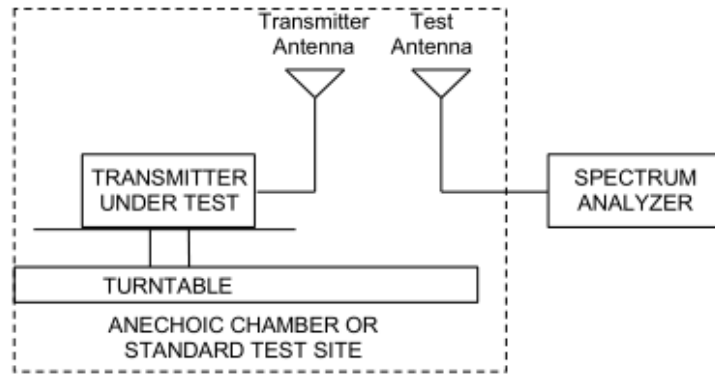

Limits

No specific RF power output requirements in part 2.1046.

Rule Part 24.232(c) Mobile and portable stations are limited to 2 watts EIRP.

Rule Part 24.232(e) Peak transmit power must be measured over any interval of continuous transmission using instrumentation calibrated in terms of an rms-equivalent voltage.

Limit	$\leq 2\text{ W}$ (33 dBm)
-------	----------------------------

Measurement Uncertainty

The assessed measurement uncertainty to ensure 95% confidence level for the normal distribution is with the coverage factor $k = 2$, $U = 0.4$ dB for RF power output, $k = 2$, $U = 1.19$ dB for EIRP.

**Test Results**

Band	Bandwidth	Modulation	Channel	RB Configuration	Conducted Power(dBm)	EIRP(dBm)
LTE Band 25	1.4M	QPSK	26047	1RB#0	23.44	24.69
LTE Band 25	1.4M	QPSK	26047	1RB#2	23.45	24.70
LTE Band 25	1.4M	QPSK	26047	1RB#5	23.40	24.65
LTE Band 25	1.4M	QPSK	26047	3RB#0	22.46	23.71
LTE Band 25	1.4M	QPSK	26047	3RB#2	22.44	23.69
LTE Band 25	1.4M	QPSK	26047	3RB#3	22.49	23.74
LTE Band 25	1.4M	QPSK	26047	6RB#0	22.42	23.67
LTE Band 25	1.4M	QPSK	26365	1RB#0	23.59	24.97
LTE Band 25	1.4M	QPSK	26365	1RB#2	23.50	24.88
LTE Band 25	1.4M	QPSK	26365	1RB#5	23.54	24.92
LTE Band 25	1.4M	QPSK	26365	3RB#0	22.58	23.96
LTE Band 25	1.4M	QPSK	26365	3RB#2	22.60	23.98
LTE Band 25	1.4M	QPSK	26365	3RB#3	22.59	23.97
LTE Band 25	1.4M	QPSK	26365	6RB#0	22.64	24.02
LTE Band 25	1.4M	QPSK	26683	1RB#0	23.30	24.66
LTE Band 25	1.4M	QPSK	26683	1RB#2	23.49	24.85
LTE Band 25	1.4M	QPSK	26683	1RB#5	23.55	24.91
LTE Band 25	1.4M	QPSK	26683	3RB#0	22.38	23.74
LTE Band 25	1.4M	QPSK	26683	3RB#2	22.43	23.79
LTE Band 25	1.4M	QPSK	26683	3RB#3	22.49	23.85
LTE Band 25	1.4M	QPSK	26683	6RB#0	22.37	23.73
LTE Band 25	1.4M	16QAM	26047	1RB#0	22.26	23.51
LTE Band 25	1.4M	16QAM	26047	1RB#2	22.41	23.66
LTE Band 25	1.4M	16QAM	26047	1RB#5	22.31	23.56
LTE Band 25	1.4M	16QAM	26047	3RB#0	21.23	22.48
LTE Band 25	1.4M	16QAM	26047	3RB#2	21.29	22.54
LTE Band 25	1.4M	16QAM	26047	3RB#3	21.36	22.61
LTE Band 25	1.4M	16QAM	26047	6RB#0	21.39	22.64
LTE Band 25	1.4M	16QAM	26365	1RB#0	21.98	23.36
LTE Band 25	1.4M	16QAM	26365	1RB#2	21.96	23.34
LTE Band 25	1.4M	16QAM	26365	1RB#5	21.90	23.28
LTE Band 25	1.4M	16QAM	26365	3RB#0	21.17	22.55
LTE Band 25	1.4M	16QAM	26365	3RB#2	21.30	22.68
LTE Band 25	1.4M	16QAM	26365	3RB#3	21.46	22.84
LTE Band 25	1.4M	16QAM	26365	6RB#0	21.56	22.94
LTE Band 25	1.4M	16QAM	26683	1RB#0	22.21	23.57
LTE Band 25	1.4M	16QAM	26683	1RB#2	22.54	23.90
LTE Band 25	1.4M	16QAM	26683	1RB#5	22.89	24.25
LTE Band 25	1.4M	16QAM	26683	3RB#0	21.16	22.52



LTE Band 25	1.4M	16QAM	26683	3RB#2	21.18	22.54
LTE Band 25	1.4M	16QAM	26683	3RB#3	21.15	22.51
LTE Band 25	1.4M	16QAM	26683	6RB#0	21.25	22.61
LTE Band 25	3M	QPSK	26055	1RB#0	23.46	24.71
LTE Band 25	3M	QPSK	26055	1RB#7	23.48	24.73
LTE Band 25	3M	QPSK	26055	1RB#14	23.43	24.68
LTE Band 25	3M	QPSK	26055	8RB#0	22.54	23.79
LTE Band 25	3M	QPSK	26055	8RB#4	22.54	23.79
LTE Band 25	3M	QPSK	26055	8RB#7	22.57	23.82
LTE Band 25	3M	QPSK	26055	15RB#0	22.45	23.70
LTE Band 25	3M	QPSK	26365	1RB#0	23.63	25.01
LTE Band 25	3M	QPSK	26365	1RB#7	23.55	24.93
LTE Band 25	3M	QPSK	26365	1RB#14	23.59	24.97
LTE Band 25	3M	QPSK	26365	8RB#0	22.68	24.06
LTE Band 25	3M	QPSK	26365	8RB#4	22.68	24.06
LTE Band 25	3M	QPSK	26365	8RB#7	22.68	24.06
LTE Band 25	3M	QPSK	26365	15RB#0	22.68	24.06
LTE Band 25	3M	QPSK	26675	1RB#0	23.33	24.69
LTE Band 25	3M	QPSK	26675	1RB#7	23.53	24.89
LTE Band 25	3M	QPSK	26675	1RB#14	23.59	24.95
LTE Band 25	3M	QPSK	26675	8RB#0	22.49	23.85
LTE Band 25	3M	QPSK	26675	8RB#4	22.53	23.89
LTE Band 25	3M	QPSK	26675	8RB#7	22.57	23.93
LTE Band 25	3M	QPSK	26675	15RB#0	22.40	23.76
LTE Band 25	3M	16QAM	26055	1RB#0	22.29	23.54
LTE Band 25	3M	16QAM	26055	1RB#7	22.44	23.69
LTE Band 25	3M	16QAM	26055	1RB#14	22.33	23.58
LTE Band 25	3M	16QAM	26055	8RB#0	21.32	22.57
LTE Band 25	3M	16QAM	26055	8RB#4	21.38	22.63
LTE Band 25	3M	16QAM	26055	8RB#7	21.44	22.69
LTE Band 25	3M	16QAM	26055	15RB#0	21.42	22.67
LTE Band 25	3M	16QAM	26365	1RB#0	22.00	23.38
LTE Band 25	3M	16QAM	26365	1RB#7	22.01	23.39
LTE Band 25	3M	16QAM	26365	1RB#14	21.94	23.32
LTE Band 25	3M	16QAM	26365	8RB#0	21.28	22.66
LTE Band 25	3M	16QAM	26365	8RB#4	21.41	22.79
LTE Band 25	3M	16QAM	26365	8RB#7	21.56	22.94
LTE Band 25	3M	16QAM	26365	15RB#0	21.60	22.98
LTE Band 25	3M	16QAM	26675	1RB#0	22.24	23.60
LTE Band 25	3M	16QAM	26675	1RB#7	22.58	23.94
LTE Band 25	3M	16QAM	26675	1RB#14	22.92	24.28
LTE Band 25	3M	16QAM	26675	8RB#0	21.26	22.62
LTE Band 25	3M	16QAM	26675	8RB#4	21.28	22.64



LTE Band 25	3M	16QAM	26675	8RB#7	21.26	22.62
LTE Band 25	3M	16QAM	26675	15RB#0	21.28	22.64
LTE Band 25	5M	QPSK	26065	1RB#0	23.41	24.66
LTE Band 25	5M	QPSK	26065	1RB#13	23.46	24.71
LTE Band 25	5M	QPSK	26065	1RB#24	23.37	24.62
LTE Band 25	5M	QPSK	26065	12RB#0	22.49	23.74
LTE Band 25	5M	QPSK	26065	12RB#6	22.50	23.75
LTE Band 25	5M	QPSK	26065	12RB#13	22.51	23.76
LTE Band 25	5M	QPSK	26065	25RB#0	22.46	23.71
LTE Band 25	5M	QPSK	26365	1RB#0	23.54	24.92
LTE Band 25	5M	QPSK	26365	1RB#13	23.51	24.89
LTE Band 25	5M	QPSK	26365	1RB#24	23.52	24.90
LTE Band 25	5M	QPSK	26365	12RB#0	22.59	23.97
LTE Band 25	5M	QPSK	26365	12RB#6	22.60	23.98
LTE Band 25	5M	QPSK	26365	12RB#13	22.62	24.00
LTE Band 25	5M	QPSK	26365	25RB#0	22.60	23.98
LTE Band 25	5M	QPSK	26665	1RB#0	23.27	24.63
LTE Band 25	5M	QPSK	26665	1RB#13	23.49	24.85
LTE Band 25	5M	QPSK	26665	1RB#24	23.51	24.87
LTE Band 25	5M	QPSK	26665	12RB#0	22.42	23.78
LTE Band 25	5M	QPSK	26665	12RB#6	22.45	23.81
LTE Band 25	5M	QPSK	26665	12RB#13	22.50	23.86
LTE Band 25	5M	QPSK	26665	25RB#0	22.33	23.69
LTE Band 25	5M	16QAM	26065	1RB#0	22.21	23.46
LTE Band 25	5M	16QAM	26065	1RB#13	22.38	23.63
LTE Band 25	5M	16QAM	26065	1RB#24	22.28	23.53
LTE Band 25	5M	16QAM	26065	12RB#0	21.27	22.52
LTE Band 25	5M	16QAM	26065	12RB#6	21.31	22.56
LTE Band 25	5M	16QAM	26065	12RB#13	21.39	22.64
LTE Band 25	5M	16QAM	26065	25RB#0	21.38	22.63
LTE Band 25	5M	16QAM	26365	1RB#0	21.93	23.31
LTE Band 25	5M	16QAM	26365	1RB#13	21.98	23.36
LTE Band 25	5M	16QAM	26365	1RB#24	21.87	23.25
LTE Band 25	5M	16QAM	26365	12RB#0	21.23	22.61
LTE Band 25	5M	16QAM	26365	12RB#6	21.33	22.71
LTE Band 25	5M	16QAM	26365	12RB#13	21.47	22.85
LTE Band 25	5M	16QAM	26365	25RB#0	21.52	22.90
LTE Band 25	5M	16QAM	26665	1RB#0	22.16	23.52
LTE Band 25	5M	16QAM	26665	1RB#13	22.52	23.88
LTE Band 25	5M	16QAM	26665	1RB#24	22.86	24.22
LTE Band 25	5M	16QAM	26665	12RB#0	21.21	22.57
LTE Band 25	5M	16QAM	26665	12RB#6	21.20	22.56
LTE Band 25	5M	16QAM	26665	12RB#13	21.19	22.55



LTE Band 25	5M	16QAM	26665	25RB#0	21.20	22.56
LTE Band 25	10M	QPSK	26090	1RB#0	23.61	24.86
LTE Band 25	10M	QPSK	26090	1RB#25	23.62	24.87
LTE Band 25	10M	QPSK	26090	1RB#49	23.75	25.00
LTE Band 25	10M	QPSK	26090	25RB#0	22.54	23.79
LTE Band 25	10M	QPSK	26090	25RB#13	22.50	23.75
LTE Band 25	10M	QPSK	26090	25RB#25	22.55	23.80
LTE Band 25	10M	QPSK	26090	50RB#0	22.61	23.86
LTE Band 25	10M	QPSK	26365	1RB#0	23.55	24.93
LTE Band 25	10M	QPSK	26365	1RB#25	23.72	25.10
LTE Band 25	10M	QPSK	26365	1RB#49	23.47	24.85
LTE Band 25	10M	QPSK	26365	25RB#0	22.64	24.02
LTE Band 25	10M	QPSK	26365	25RB#13	22.66	24.04
LTE Band 25	10M	QPSK	26365	25RB#25	22.67	24.05
LTE Band 25	10M	QPSK	26365	50RB#0	22.67	24.05
LTE Band 25	10M	QPSK	26640	1RB#0	23.65	25.01
LTE Band 25	10M	QPSK	26640	1RB#25	23.69	25.05
LTE Band 25	10M	QPSK	26640	1RB#49	23.70	25.06
LTE Band 25	10M	QPSK	26640	25RB#0	22.66	24.02
LTE Band 25	10M	QPSK	26640	25RB#13	22.51	23.87
LTE Band 25	10M	QPSK	26640	25RB#25	22.38	23.74
LTE Band 25	10M	QPSK	26640	50RB#0	22.52	23.88
LTE Band 25	10M	16QAM	26090	1RB#0	22.83	24.08
LTE Band 25	10M	16QAM	26090	1RB#25	23.35	24.60
LTE Band 25	10M	16QAM	26090	1RB#49	22.91	24.16
LTE Band 25	10M	16QAM	26090	25RB#0	21.47	22.72
LTE Band 25	10M	16QAM	26090	25RB#13	21.52	22.77
LTE Band 25	10M	16QAM	26090	25RB#25	21.59	22.84
LTE Band 25	10M	16QAM	26365	1RB#0	22.93	24.31
LTE Band 25	10M	16QAM	26365	1RB#25	23.02	24.40
LTE Band 25	10M	16QAM	26365	1RB#49	22.38	23.76
LTE Band 25	10M	16QAM	26365	25RB#0	21.57	22.95
LTE Band 25	10M	16QAM	26365	25RB#13	21.58	22.96
LTE Band 25	10M	16QAM	26365	25RB#25	21.60	22.98
LTE Band 25	10M	16QAM	26640	1RB#0	22.88	24.24
LTE Band 25	10M	16QAM	26640	1RB#25	23.22	24.58
LTE Band 25	10M	16QAM	26640	1RB#49	22.40	23.76
LTE Band 25	10M	16QAM	26640	25RB#0	21.55	22.91
LTE Band 25	10M	16QAM	26640	25RB#13	21.43	22.79
LTE Band 25	10M	16QAM	26640	25RB#25	21.37	22.73
LTE Band 25	15M	QPSK	26115	1RB#0	23.50	24.75
LTE Band 25	15M	QPSK	26115	1RB#38	23.57	24.82
LTE Band 25	15M	QPSK	26115	1RB#74	23.45	24.70



LTE Band 25	15M	QPSK	26115	36RB#0	22.60	23.85
LTE Band 25	15M	QPSK	26115	36RB#18	22.60	23.85
LTE Band 25	15M	QPSK	26115	36RB#39	22.58	23.83
LTE Band 25	15M	QPSK	26115	75RB#0	22.61	23.86
LTE Band 25	15M	QPSK	26365	1RB#0	23.55	24.93
LTE Band 25	15M	QPSK	26365	1RB#38	23.50	24.88
LTE Band 25	15M	QPSK	26365	1RB#74	23.41	24.79
LTE Band 25	15M	QPSK	26365	36RB#0	22.63	24.01
LTE Band 25	15M	QPSK	26365	36RB#18	22.60	23.98
LTE Band 25	15M	QPSK	26365	36RB#39	22.58	23.96
LTE Band 25	15M	QPSK	26365	75RB#0	22.61	23.99
LTE Band 25	15M	QPSK	26615	1RB#0	23.46	25.05
LTE Band 25	15M	QPSK	26615	1RB#38	23.78	25.37
LTE Band 25	15M	QPSK	26615	1RB#74	23.45	25.04
LTE Band 25	15M	QPSK	26615	36RB#0	22.58	24.17
LTE Band 25	15M	QPSK	26615	36RB#18	22.41	24.00
LTE Band 25	15M	QPSK	26615	36RB#39	22.34	23.93
LTE Band 25	15M	QPSK	26615	75RB#0	22.53	24.12
LTE Band 25	15M	16QAM	26115	1RB#0	23.09	24.34
LTE Band 25	15M	16QAM	26115	1RB#38	23.13	24.38
LTE Band 25	15M	16QAM	26115	1RB#74	22.98	24.23
LTE Band 25	15M	16QAM	26365	1RB#0	23.19	24.57
LTE Band 25	15M	16QAM	26365	1RB#38	23.13	24.51
LTE Band 25	15M	16QAM	26365	1RB#74	23.06	24.44
LTE Band 25	15M	16QAM	26615	1RB#0	23.11	24.70
LTE Band 25	15M	16QAM	26615	1RB#38	23.07	24.66
LTE Band 25	15M	16QAM	26615	1RB#74	22.89	24.48
LTE Band 25	20M	QPSK	26140	1RB#0	23.28	24.53
LTE Band 25	20M	QPSK	26140	1RB#50	23.89	25.14
LTE Band 25	20M	QPSK	26140	1RB#99	23.32	24.57
LTE Band 25	20M	QPSK	26140	50RB#0	22.68	23.93
LTE Band 25	20M	QPSK	26140	50RB#25	22.60	23.85
LTE Band 25	20M	QPSK	26140	50RB#50	22.55	23.80
LTE Band 25	20M	QPSK	26140	100RB#0	22.51	23.76
LTE Band 25	20M	QPSK	26365	1RB#0	23.18	24.56
LTE Band 25	20M	QPSK	26365	1RB#50	24.00	25.38
LTE Band 25	20M	QPSK	26365	1RB#99	23.31	24.69
LTE Band 25	20M	QPSK	26365	50RB#0	22.74	24.12
LTE Band 25	20M	QPSK	26365	50RB#25	22.70	24.08
LTE Band 25	20M	QPSK	26365	50RB#50	22.67	24.05
LTE Band 25	20M	QPSK	26365	100RB#0	22.63	24.01
LTE Band 25	20M	QPSK	26590	1RB#0	23.82	25.41
LTE Band 25	20M	QPSK	26590	1RB#50	23.88	25.47



LTE Band 25	20M	QPSK	26590	1RB#99	23.50	25.09
LTE Band 25	20M	QPSK	26590	50RB#0	22.49	24.08
LTE Band 25	20M	QPSK	26590	50RB#25	22.41	24.00
LTE Band 25	20M	QPSK	26590	50RB#50	22.34	23.93
LTE Band 25	20M	QPSK	26590	100RB#0	22.43	24.02
LTE Band 25	20M	16QAM	26140	1RB#0	22.50	23.75
LTE Band 25	20M	16QAM	26140	1RB#50	23.21	24.46
LTE Band 25	20M	16QAM	26140	1RB#99	22.57	23.82
LTE Band 25	20M	16QAM	26365	1RB#0	22.74	24.12
LTE Band 25	20M	16QAM	26365	1RB#50	23.26	24.64
LTE Band 25	20M	16QAM	26365	1RB#99	22.82	24.20
LTE Band 25	20M	16QAM	26590	1RB#0	21.82	23.41
LTE Band 25	20M	16QAM	26590	1RB#50	22.49	24.08
LTE Band 25	20M	16QAM	26590	1RB#99	21.91	23.50

5.2.Occupied Bandwidth

Ambient condition

Temperature	Relative humidity	Pressure
23°C ~25°C	45%~50%	101.5kPa

Method of Measurement

The EUT was connected to Spectrum Analyzer and Base Station Simulator via power Splitter. The occupied bandwidth is measured using spectrum analyzer.

RBW is set to 30kHz, VBW is set to 91kHz for LTE Band 25(1.4MHz),

RBW is set to 62kHz,VBW is set to 180kHz for LTE Band 25 (3MHz),

RBW is set to 100kHz,VBW is set to 300kHz for LTE Band 25 (5MHz),

RBW is set to 200kHz,VBW is set to 620kHz for LTE Band 25(10MHz),

RBW is set to 300kHz,VBW is set to 910kHz for LTE Band 25(15MHz),

RBW is set to 430kHz,VBW is set to 1.2MHz for LTE Band 25(20MHz).

99% power and -26dBc occupied bandwidths are recorded. Spectrum analyzer plots are included on the following pages.

Test Setup

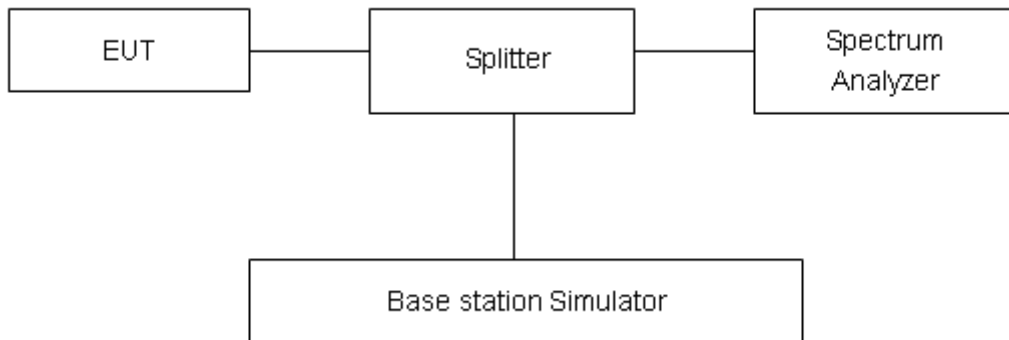

Limits

No specific occupied bandwidth requirements in part 2.1049.

Measurement Uncertainty

The assessed measurement uncertainty to ensure 95% confidence level for the normal distribution is with the coverage factor $k = 2$, $U = 624\text{Hz}$.

Test Result

LTE Band 25					
Modulation	Bandwidth (MHz)	Channel	Frequency (MHz)	99% Power Bandwidth(MHz)	-26dBc Bandwidth(MHz)
QPSK	1.4	26047	1850.7	1.0928	1.291
		26365	1882.5	1.0956	1.315
		26683	1914.3	1.1042	1.285
	3	26055	1851.5	2.7112	2.996
		26365	1882.5	2.7173	2.970
		26675	1913.5	2.7005	2.972
	5	26065	1852.5	4.5131	4.958
		26365	1882.5	4.5188	4.992
		26665	1912.5	4.5178	4.963
	10	26090	1855	8.9891	9.940
		26365	1882.5	8.9579	9.768
		26640	1910	8.9657	9.806
	15	26115	1857.5	13.4440	14.420
		26365	1882.5	13.4360	14.610
		26615	1907.5	13.3930	14.830
	20	26140	1860	17.8610	19.260
		26365	1882.5	17.8810	19.310
		26590	1905	17.8840	19.320
16QAM	1.4	26047	1850.7	1.0996	1.295
		26365	1882.5	1.0948	1.283
		26683	1914.3	1.0983	1.304
	3	26055	1851.5	2.7014	3.003
		26365	1882.5	2.7000	2.983
		26675	1913.5	2.6956	2.992
	5	26065	1852.5	4.5123	5.001
		26365	1882.5	4.5311	5.006
		26665	1912.5	4.5172	4.902
	10	26090	1855	4.7303	5.683
		26365	1882.5	4.7499	5.657
		26640	1910	4.7315	5.643



	15	26115	1857.5	1.1412	1.508
		26365	1882.5	1.0952	1.520
		26615	1907.5	1.1093	1.580
	20	26140	1860	1.2285	1.682
		26365	1882.5	1.1691	1.736
		26590	1905	1.1983	1.696

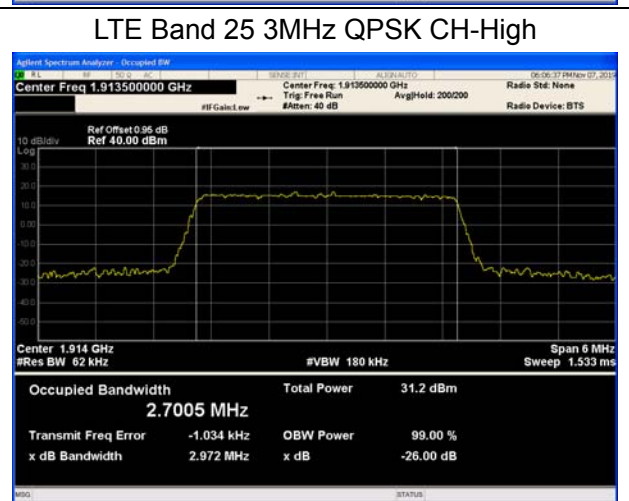
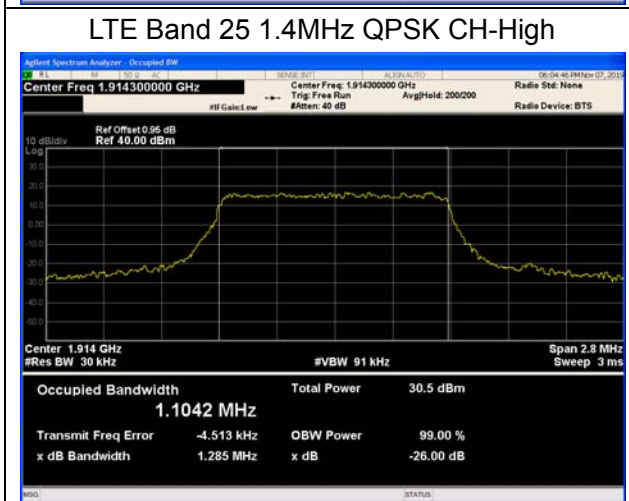
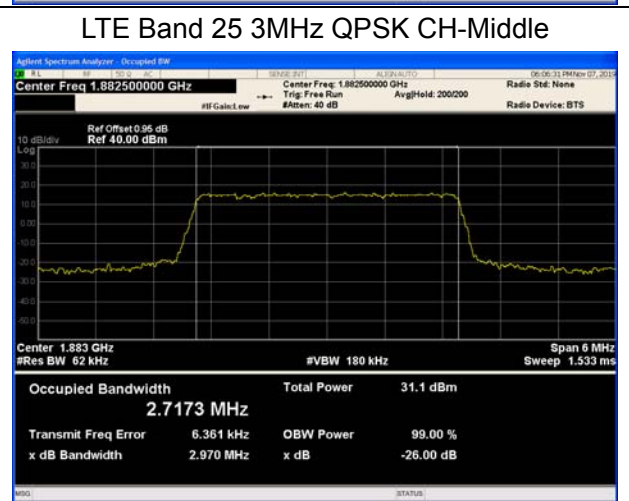
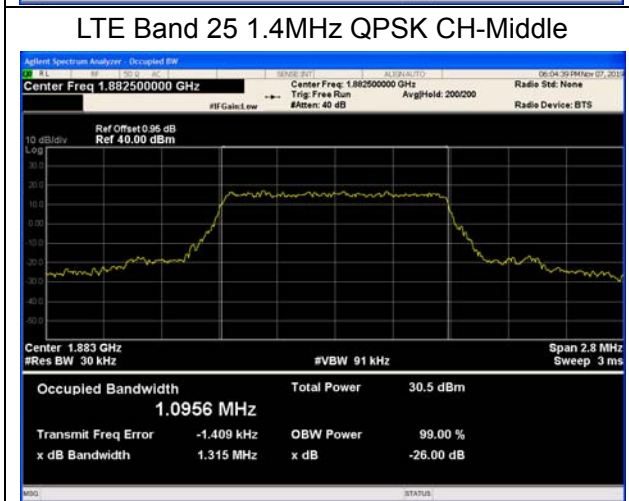
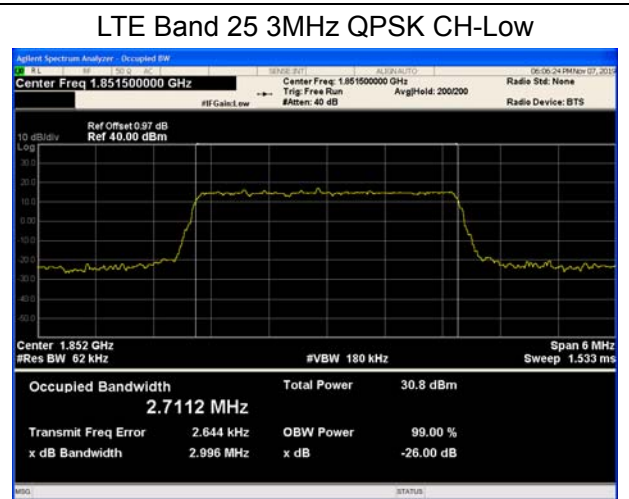
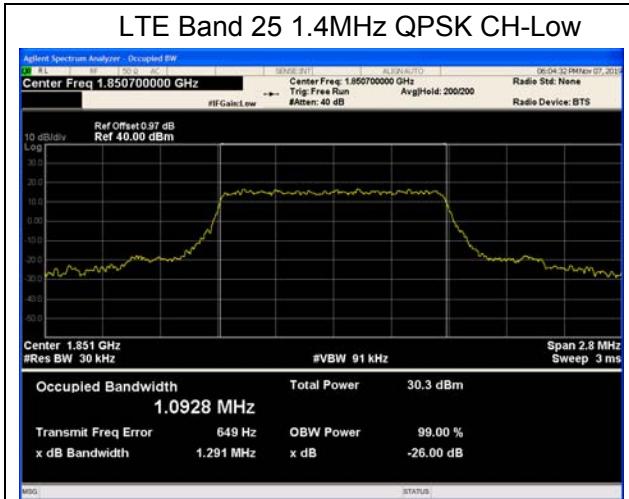

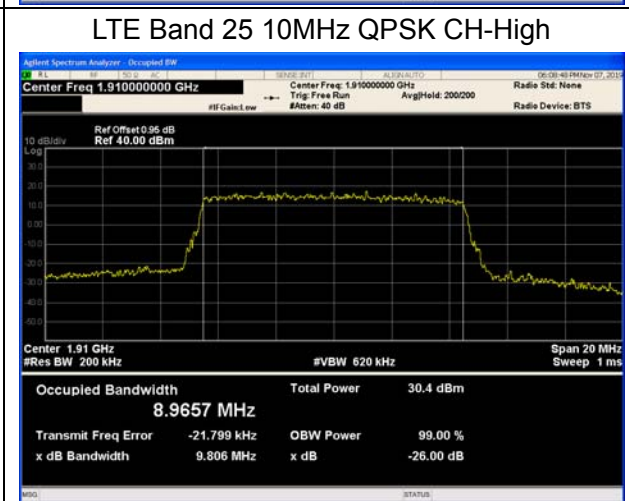
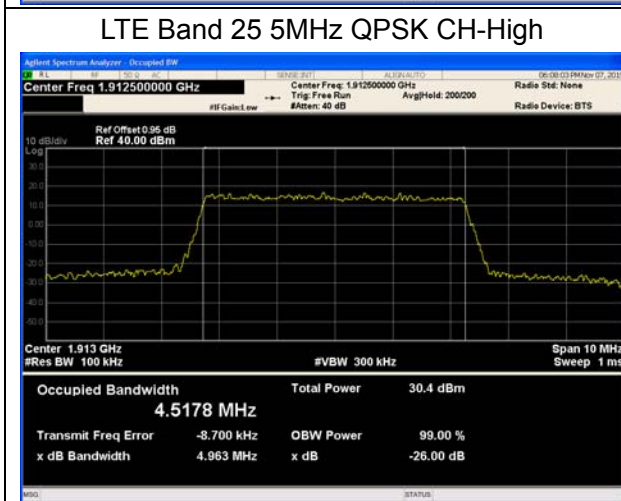
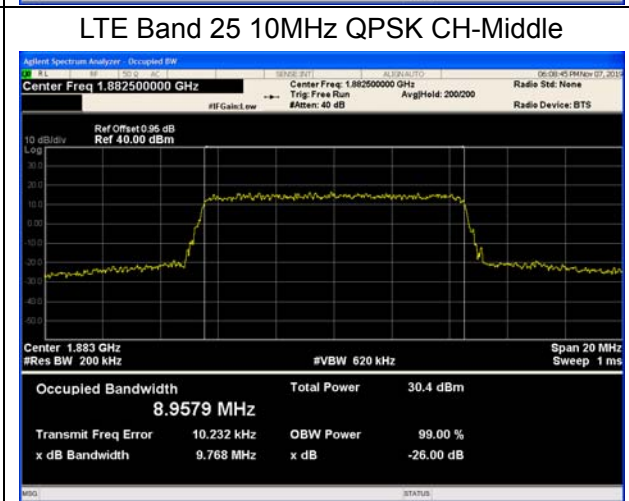
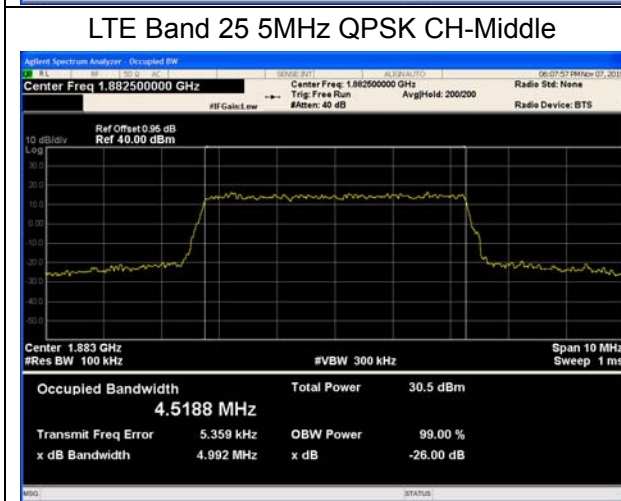
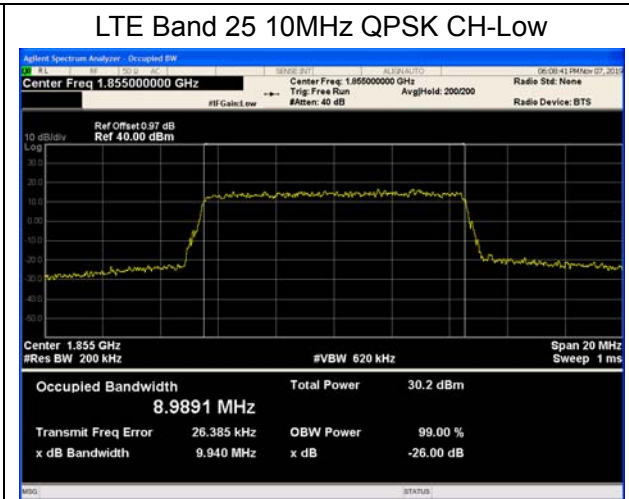
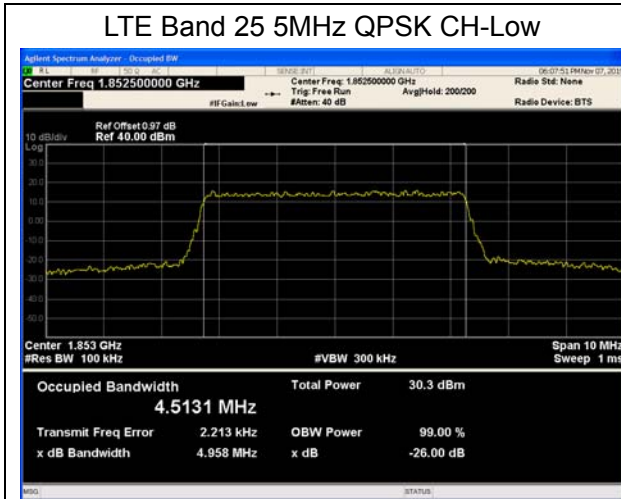



LTE Band 25 15MHz QPSK CH-Low

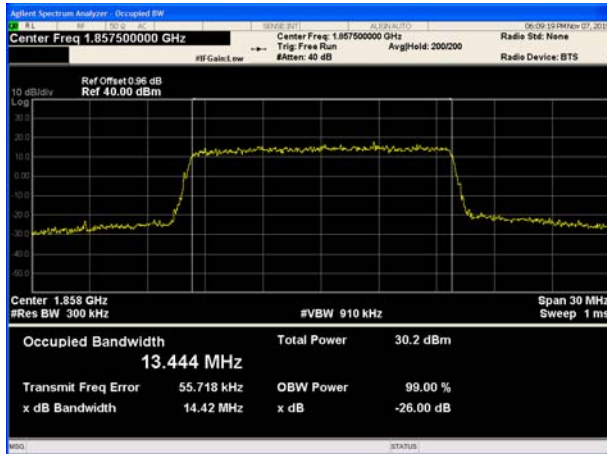

LTE Band 25 20MHz QPSK CH-Low

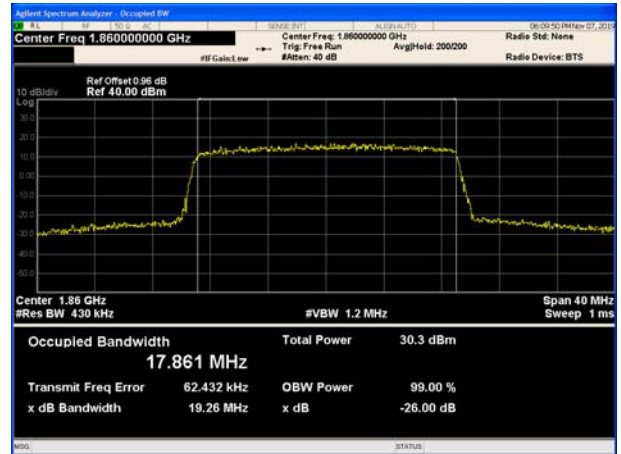

LTE Band 25 15MHz QPSK CH-Middle

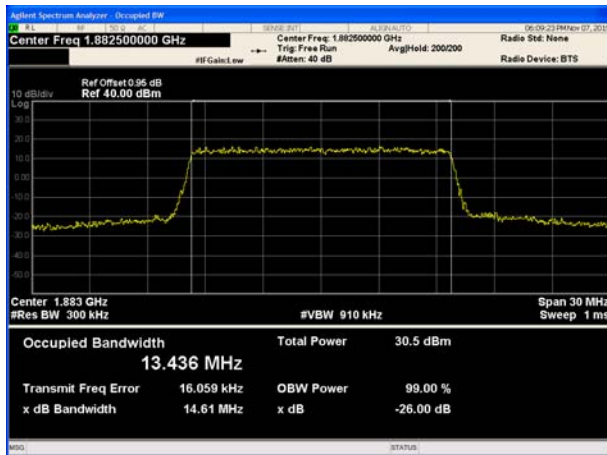

LTE Band 25 20MHz QPSK CH-Middle

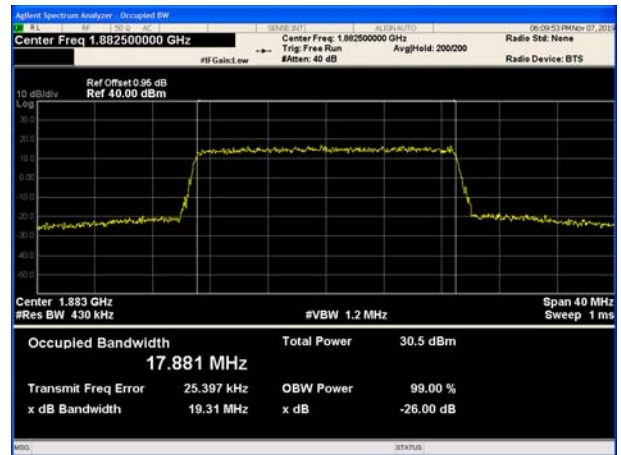

LTE Band 25 15MHz QPSK CH-High

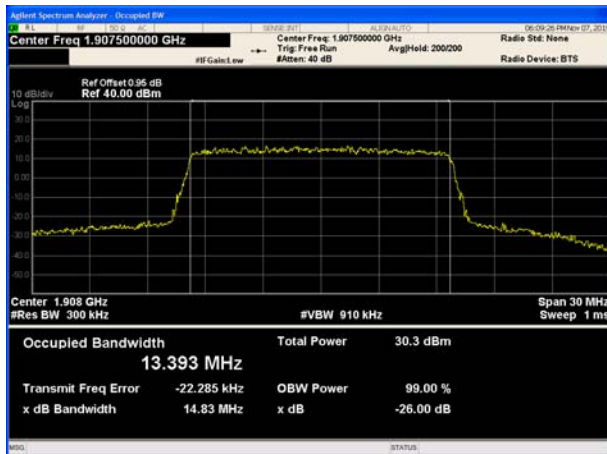

LTE Band 25 20MHz QPSK CH-High

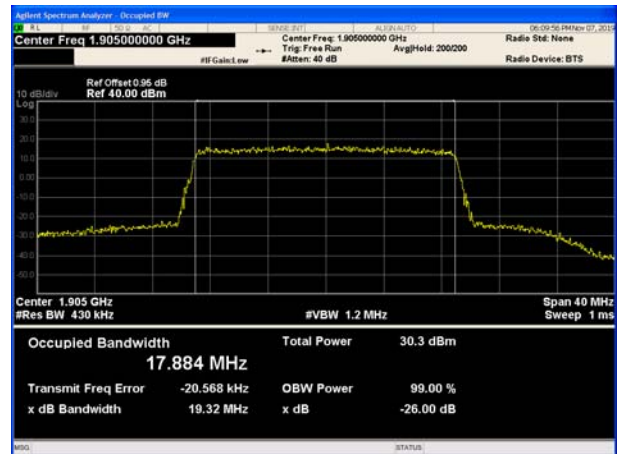



LTE Band 25 1.4MHz 16QAM CH-Low



LTE Band 25 3MHz 16QAM CH-Low

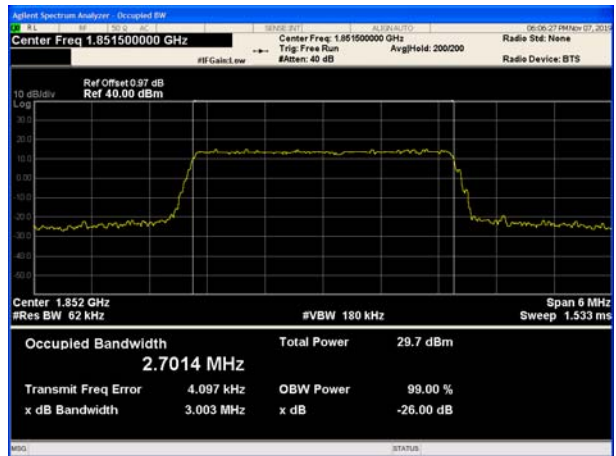

LTE Band 25 1.4MHz 16QAM CH-Middle

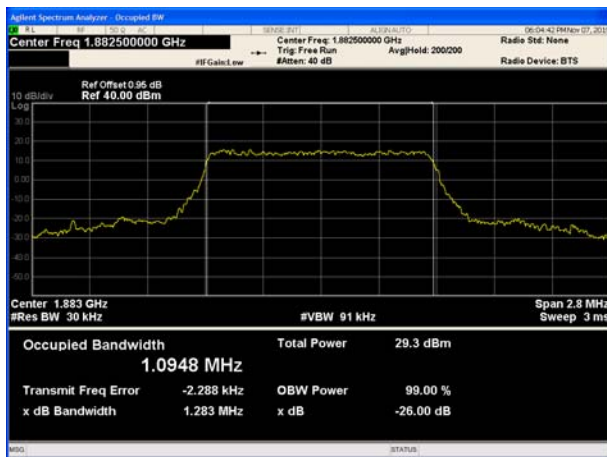

LTE Band 25 3MHz 16QAM CH-Middle

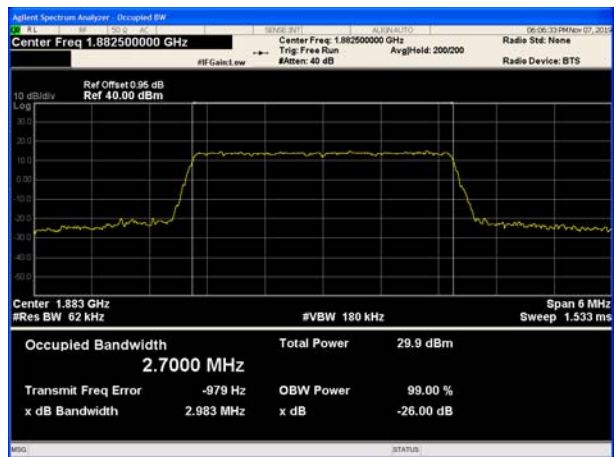

LTE Band 25 1.4MHz 16QAM CH-High

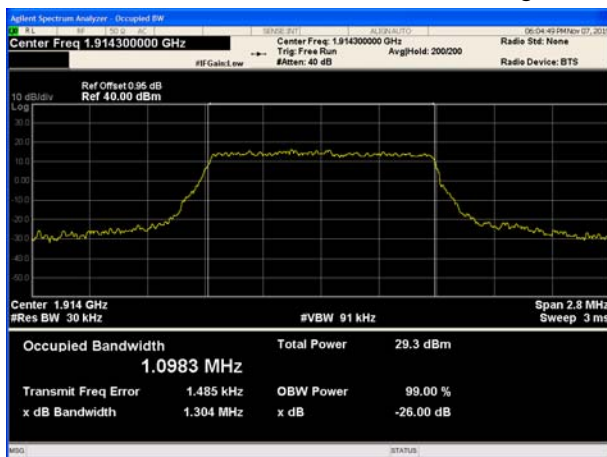

LTE Band 25 3MHz 16QAM CH-High

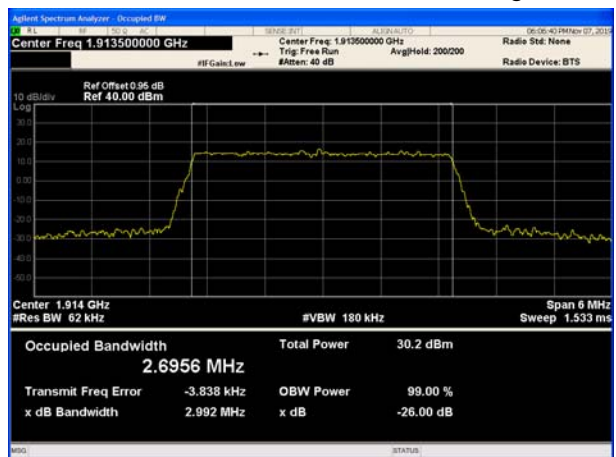

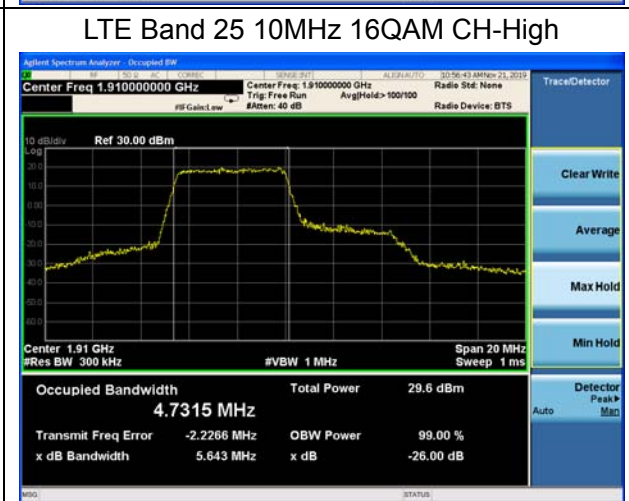
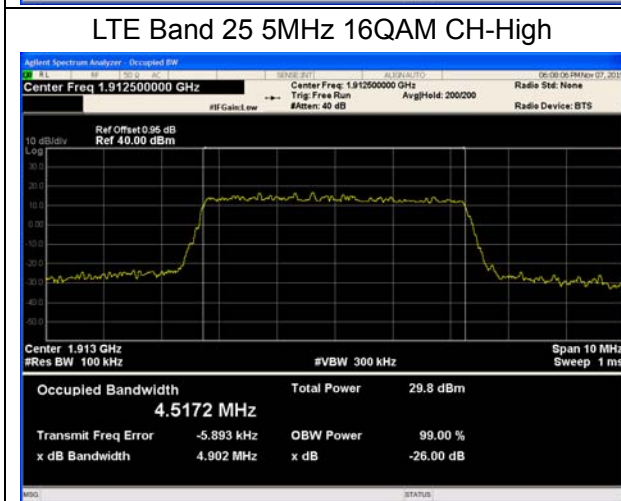
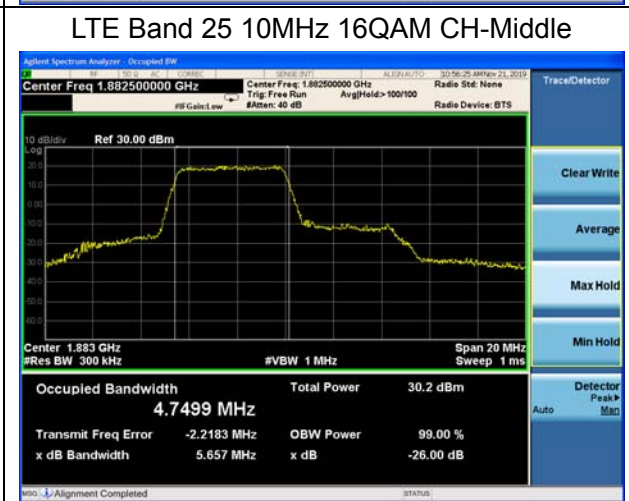
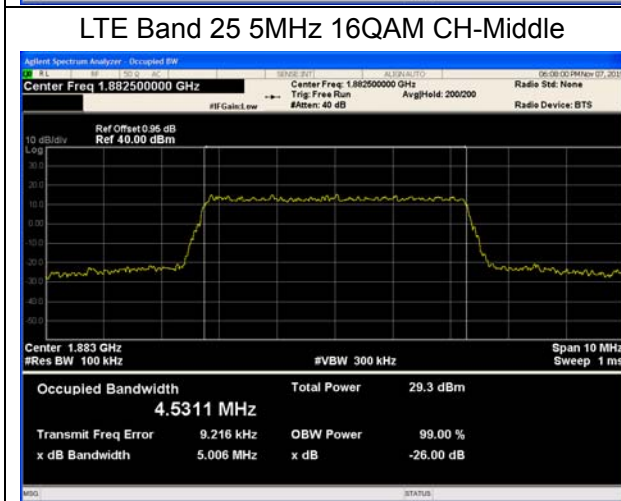
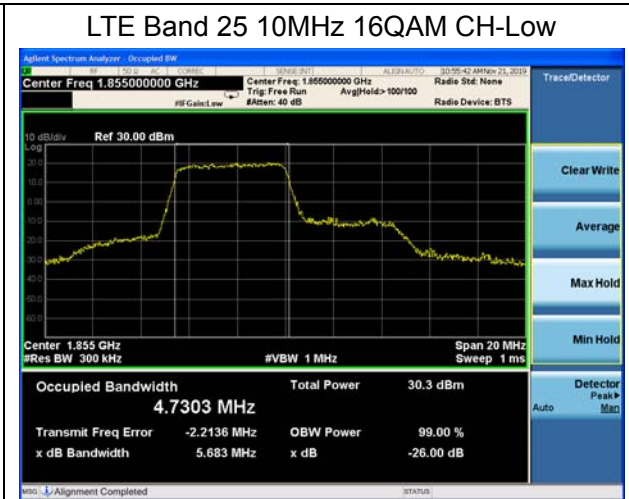
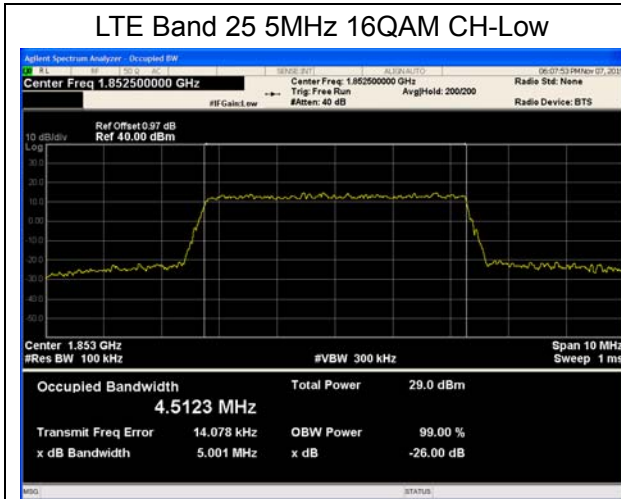

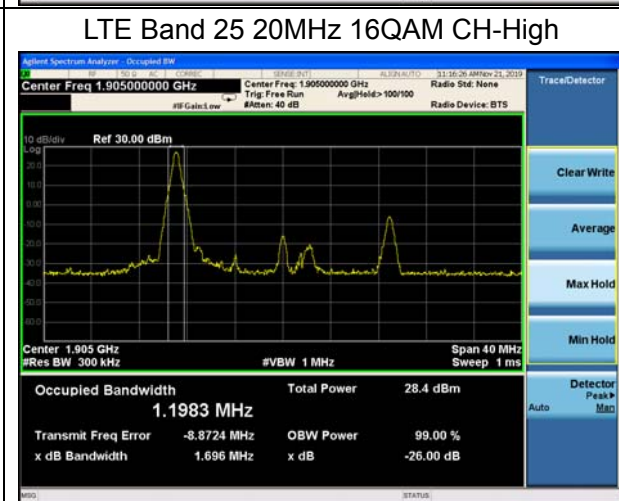
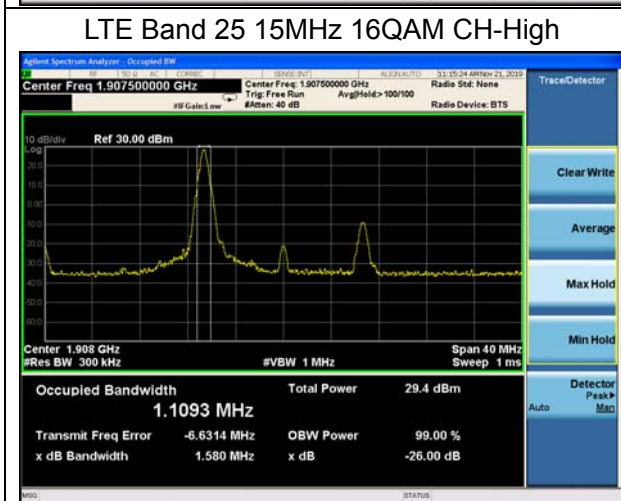
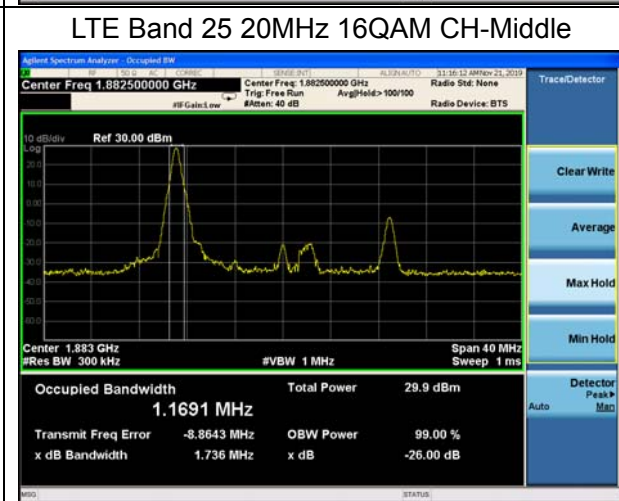
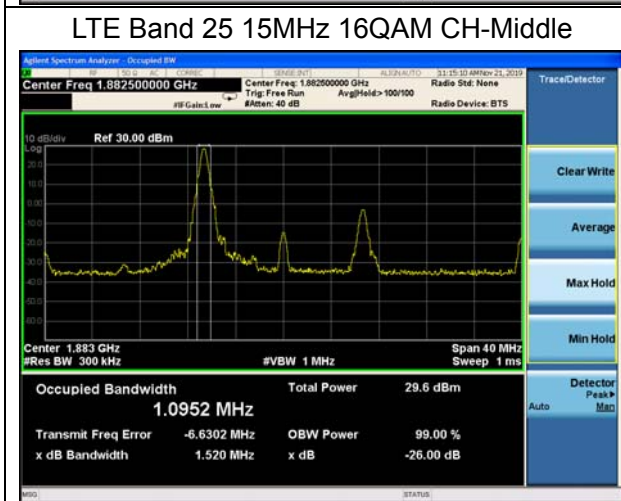
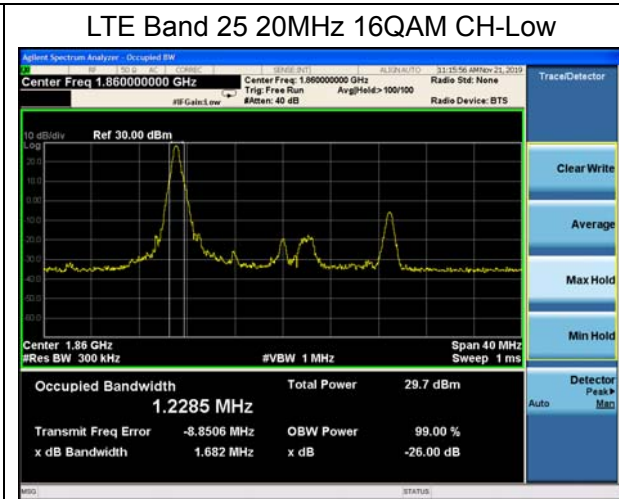
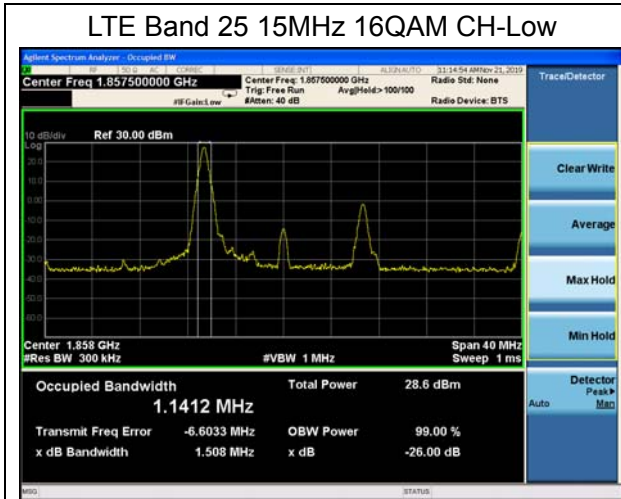

5.3. Band Edge Compliance

Ambient condition

Temperature	Relative humidity	Pressure
23°C ~25°C	45%~50%	101.5kPa

Method of Measurement

The EUT was connected to Spectrum Analyzer and Base Station Simulator via power Splitter. The band edge of the lowest and highest channels were measured. The Average detector is used and RBW is set to 15kHz, VBW is set to 43kHz for LTE Band 25(1.4MHz), RBW is set to 30kHz, VBW is set to 91kHz for LTE Band 25 (3MHz), RBW is set to 51kHz, VBW is set to 150kHz for LTE Band 25 (5MHz), RBW is set to 100kHz, VBW is set to 300kHz for LTE Band 25(10MHz), RBW is set to 150kHz, VBW is set to 470kHz for LTE Band 25(15MHz), RBW is set to 200kHz, VBW is set to 620kHz for LTE Band 25(20MHz). Spectrum analyzer plots are included on the following pages.

Test Setup

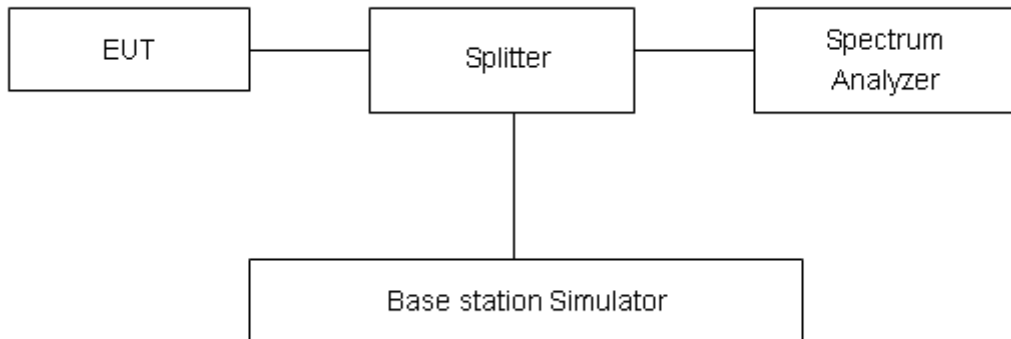

Limits

Rule Part 24.238(a) specifies that “on any frequency outside a licensee’s frequency block, the power of any emission shall be attenuated below the transmitter power (P) by at least 43 + 10 log10 (P) dB.”

Limit	-13 dBm
-------	---------

Measurement Uncertainty

The assessed measurement uncertainty to ensure 95% confidence level for the normal distribution is with the coverage factor $k = 1.96$, $U=0.684$ dB.



Test Result:

LTE Band 25 1.4MHz QPSK 1RB CH-Low



LTE Band 25 1.4MHz QPSK 1RB CH-High

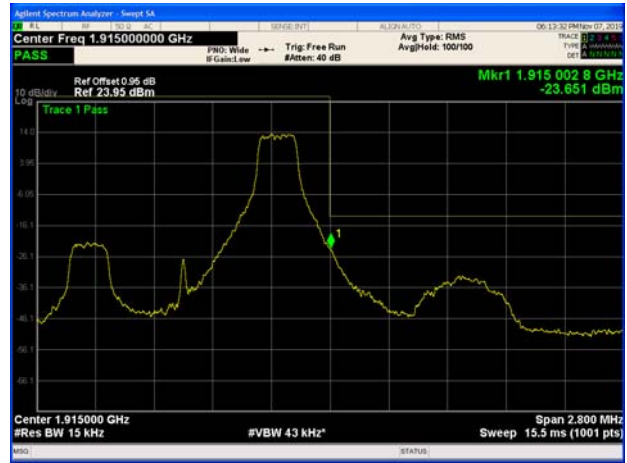

LTE Band 25 1.4MHz QPSK 100%RB CH-Low



LTE Band 25 1.4MHz QPSK 100%RB CH-High



LTE Band 25 3MHz QPSK 1RB CH-Low

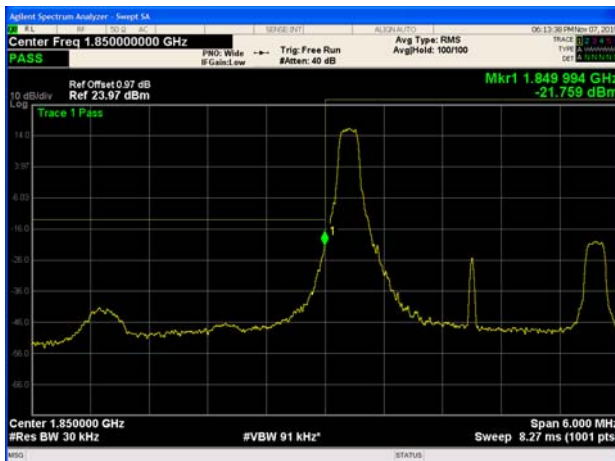

LTE Band 25 3MHz QPSK 1RB CH-High

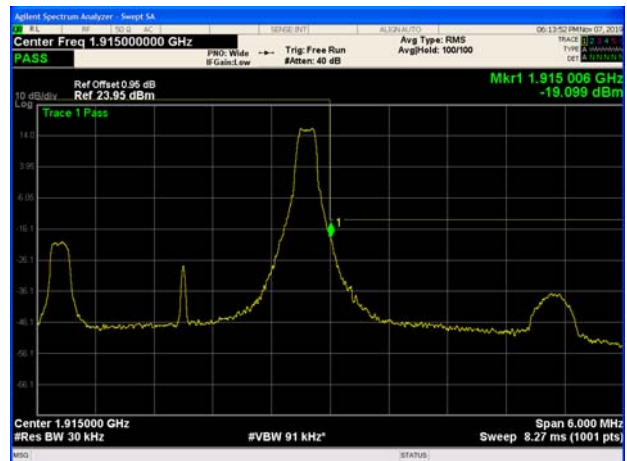



LTE Band 25 3MHz QPSK 100%RB CH-Low



LTE Band 25 3MHz QPSK 100%RB CH-High



LTE Band 25 5MHz QPSK 1RB CH-Low

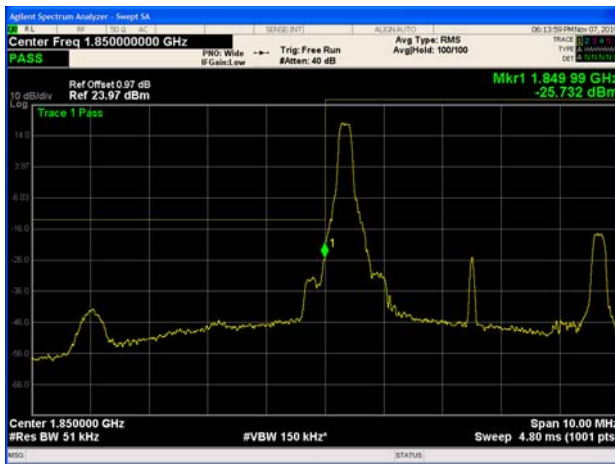

LTE Band 25 5MHz QPSK 1RB CH-High

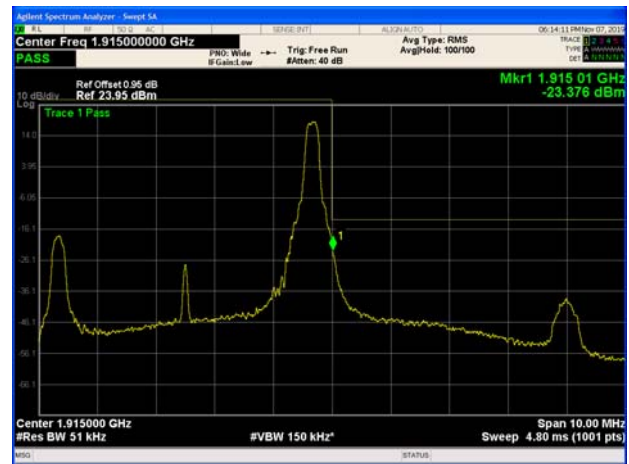

LTE Band 25 5MHz QPSK 100%RB CH-Low



LTE Band 25 5MHz QPSK 100%RB CH-High





LTE Band 25 10MHz QPSK 1RB CH-Low

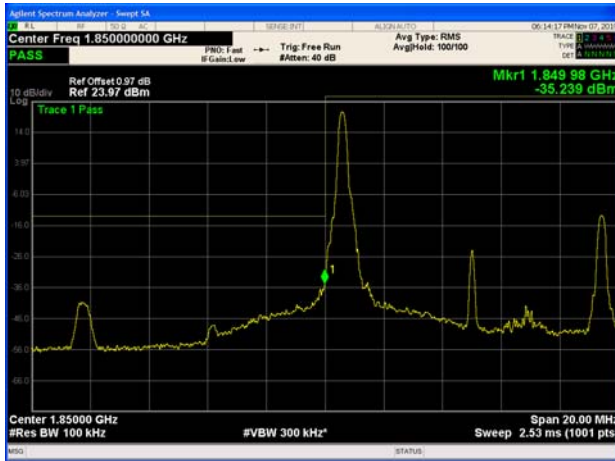

LTE Band 25 10MHz QPSK 1RB CH-High

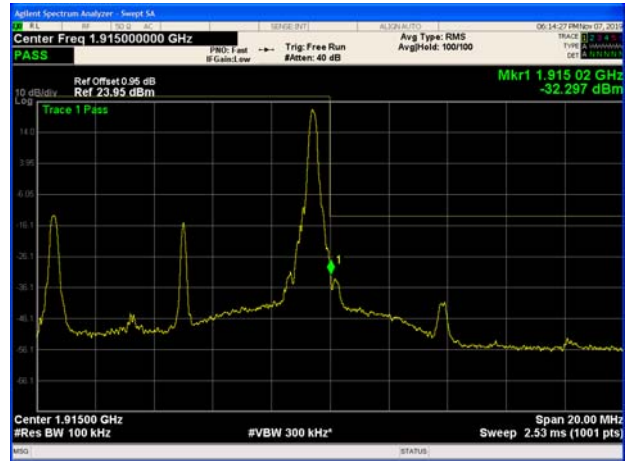

LTE Band 25 10MHz QPSK 100%RB CH-Low



LTE Band 25 10MHz QPSK 100%RB CH-High



LTE Band 25 15MHz QPSK 1RB CH-Low

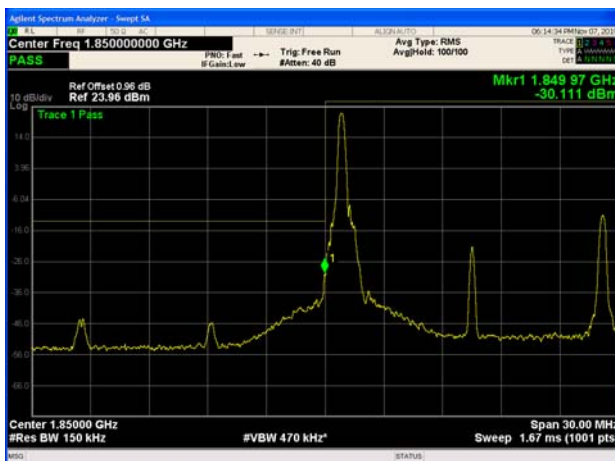

LTE Band 25 15MHz QPSK 1RB CH-High

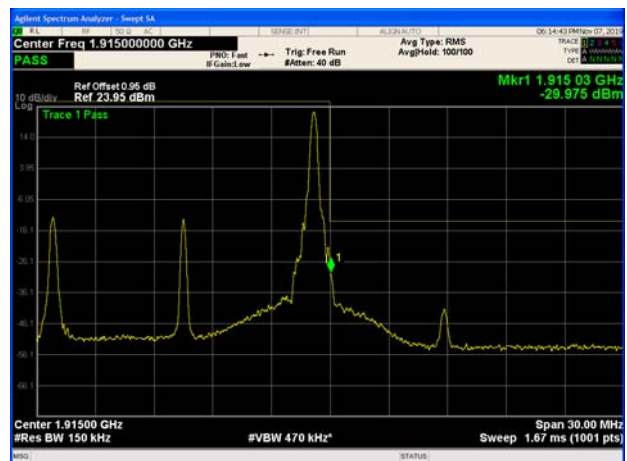



LTE Band 25 15MHz QPSK 100%RB CH-Low



LTE Band 25 15MHz QPSK 100%RB CH-High



LTE Band 25 20MHz QPSK 1RB CH-Low

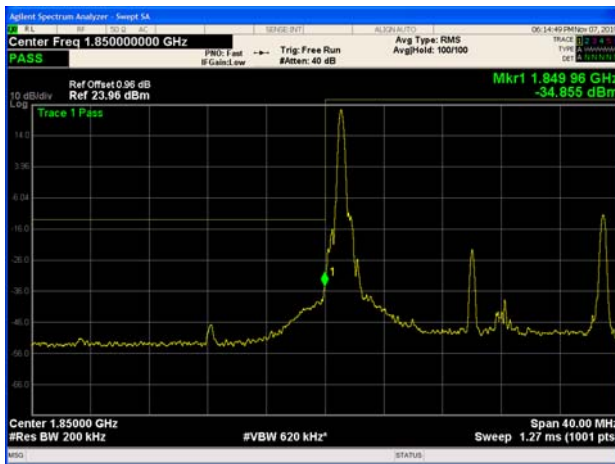

LTE Band 25 20MHz QPSK 1RB CH-High

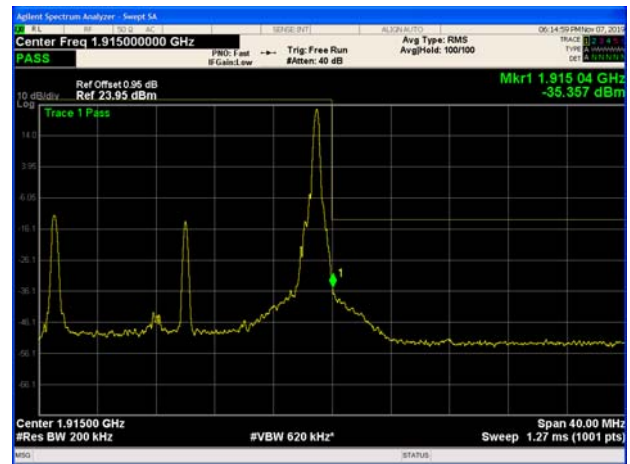

LTE Band 25 20MHz QPSK 100%RB CH-Low

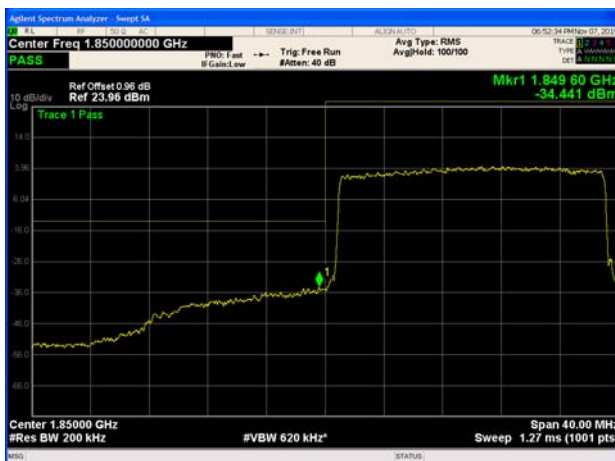

LTE Band 25 20MHz QPSK 100%RB CH-High





LTE Band 25 1.4MHz 16QAM 1RB CH-Low



LTE Band 25 1.4MHz 16QAM 1RB CH-High

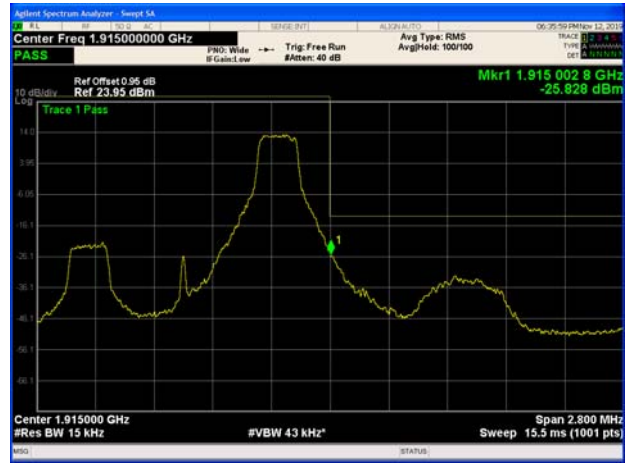

LTE Band 25 1.4MHz 16QAM 100%RB CH-Low



LTE Band 25 1.4MHz 16QAM 100%RB CH-High



LTE Band 25 3MHz 16QAM 1RB CH-Low

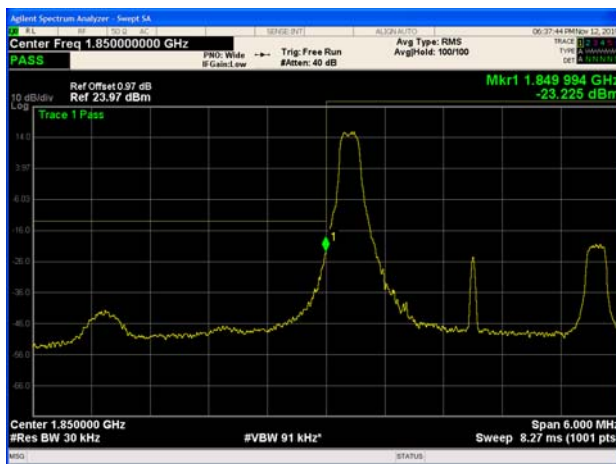

LTE Band 25 3MHz 16QAM 1RB CH-High

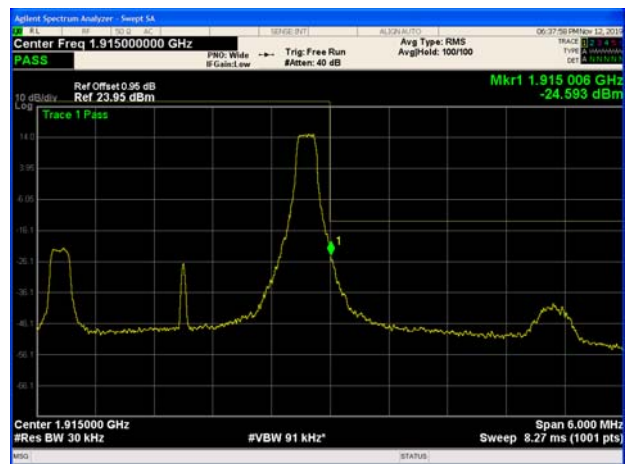



LTE Band 25 3MHz 16QAM 100%RB CH-Low



LTE Band 25 3MHz 16QAM 100%RB CH-High



LTE Band 25 5MHz 16QAM 1RB CH-Low

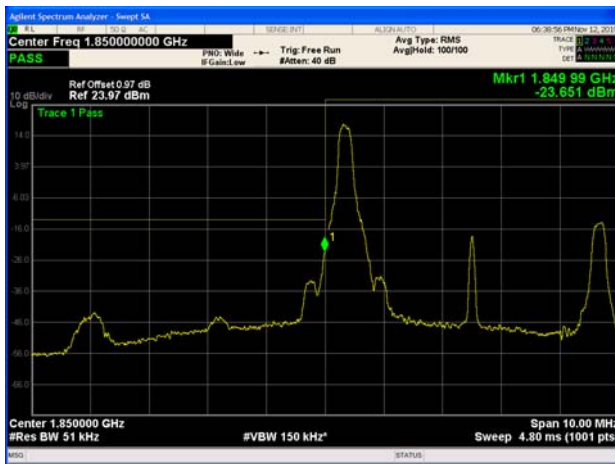

LTE Band 25 5MHz 16QAM 1RB CH-High

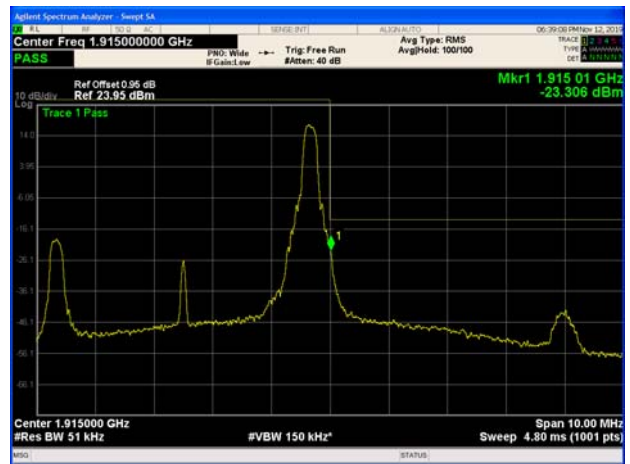

LTE Band 25 5MHz 16QAM 100%RB CH-Low



LTE Band 25 5MHz 16QAM 100%RB CH-High



5.4. Peak-to-Average Power Ratio (PAPR)

Ambient condition

Temperature	Relative humidity	Pressure
23°C ~25°C	45%~50%	101.5kPa

Methods of Measurement

Measure the total peak power and record as PPk. And measure the total average power and record as PAvg. Both the peak and average power levels must be expressed in the same logarithmic units (e.g., dBm). Determine the PAPR from:

$$PAPR (dB) = PPk (dBm) - PAvg (dBm).$$

Test Setup

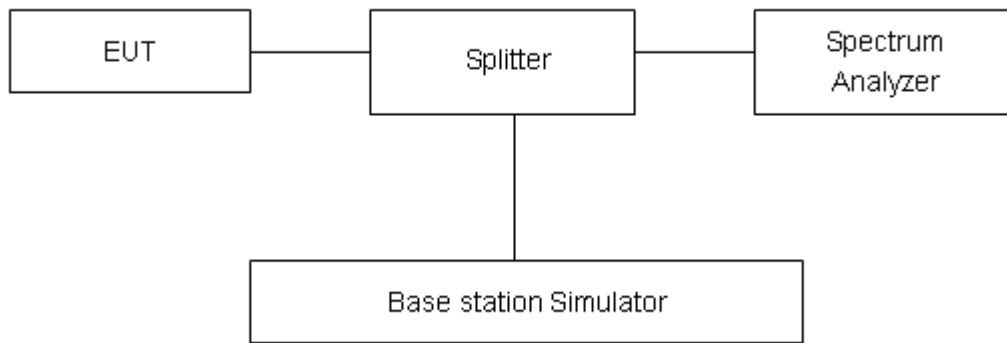

Limits

In measuring transmissions in this band using an average power technique, the peak-to-average ratio (PAR) of the transmission may not exceed 13 dB in 24.232(d).

Measurement Uncertainty

The assessed measurement uncertainty to ensure 95% confidence level for the normal distribution is with the coverage factor $k = 2$, $U = 0.4$ dB.



Test Results

LTE Band 25								
Modulation	Bandwidth (MHz)	Channel	Frequency (MHz)	Peak (dBm)	Avg (dBm)	PAPR (dB)	Limit (dB)	Conclusion
QPSK	1.4	26047	1850.7	27.76	22.18	5.58	≤13	PASS
		26365	1882.5	28.06	22.38	5.68	≤13	PASS
		26683	1914.3	27.05	22.19	4.86	≤13	PASS
	3	26055	1851.5	27.87	22.18	5.69	≤13	PASS
		26365	1882.5	28.16	22.40	5.76	≤13	PASS
		26675	1913.5	27.21	22.39	4.82	≤13	PASS
	5	26065	1852.5	27.92	22.24	5.68	≤13	PASS
		26365	1882.5	28.11	22.42	5.69	≤13	PASS
		26665	1912.5	27.22	22.31	4.91	≤13	PASS
	10	26090	1855	27.99	22.41	5.58	≤13	PASS
		26365	1882.5	28.31	22.63	5.68	≤13	PASS
		26640	1910	27.59	22.58	5.01	≤13	PASS
	15	26115	1857.5	28.02	22.43	5.59	≤13	PASS
		26365	1882.5	28.31	22.56	5.75	≤13	PASS
		26615	1907.5	27.84	22.55	5.29	≤13	PASS
20	26140	1860	27.64	22.41	5.23	≤13	PASS	
	26365	1882.5	28.05	22.57	5.48	≤13	PASS	
	26590	1905	27.72	22.49	5.23	≤13	PASS	
16QAM	1.4	26047	1850.7	27.55	21.20	6.35	≤13	PASS
		26365	1882.5	27.79	21.32	6.47	≤13	PASS
		26683	1914.3	27.00	21.17	5.83	≤13	PASS
	3	26055	1851.5	27.63	21.10	6.53	≤13	PASS
		26365	1882.5	27.89	21.28	6.61	≤13	PASS
		26675	1913.5	27.16	21.49	5.67	≤13	PASS
	5	26065	1852.5	27.66	21.17	6.49	≤13	PASS
		26365	1882.5	27.87	21.37	6.50	≤13	PASS
		26665	1912.5	27.14	21.38	5.76	≤13	PASS

5.5.Frequency Stability

Ambient condition

Temperature	Relative humidity	Pressure
23°C ~25°C	45%~50%	101.5kPa

Method of Measurement

Frequency Stability (Temperature Variation)

The temperature inside the climate chamber is varied from -40°C to +85°C in 10°C step size,

(1) With all power removed, the temperature was decreased to 0°C and permitted to stabilize for three hours.

(2) Measure the carrier frequency with the test equipment in a “call mode”. These measurements should be made within 1 minute of powering up the mobile station, to prevent significant self warming.

(3) Repeat the above measurements at 10°C increments from -40°C to +85°C. Allow at least 1.5 hours at each temperature, un-powered, before making measurements.

Frequency Stability (Voltage Variation)

The frequency stability shall be measured with variation of primary supply voltage as follows:

(1) Vary primary supply voltage from 85 to 115 percent of the nominal value for other than hand carried battery equipment.

(2) For hand carried, battery powered equipment, reduce primary supply voltage to the battery-operating end point which shall be specified by the manufacturer.

This transceiver is specified to operate with an input voltage of between 3.3 V and 4.3 V, with a nominal voltage of 3.8V.

Test setup

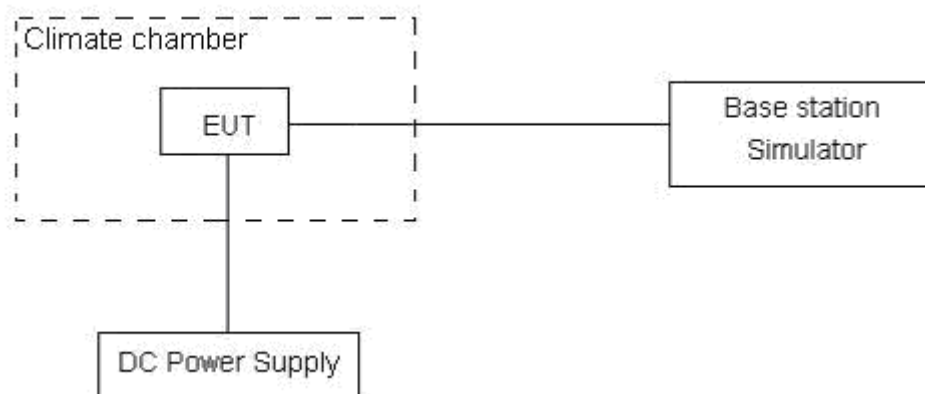

Limits

The frequency stability shall be sufficient to ensure that the fundamental emission stays within the authorized frequency block

Measurement Uncertainty

The assessed measurement uncertainty to ensure 99.75% confidence level for the normal distribution is with the coverage factor $k = 3$, $U = 0.01\text{ppm}$.

Test Result

LTE Band 25						
Condition		Freq.Error (Hz)	Freq.Error (Hz)	Frequency Stability (ppm)	Frequency Stability (ppm)	Verdict
BANDWIDTH	20MHz	16QAM	QPSK	16QAM	QPSK	
Temperature	Voltage					
Normal (25°C)	Normal	15.51	2.15	0.00825	0.00114	PASS
Extreme (55°C)		3.68	3.57	0.00196	0.00190	PASS
Extreme (80°C)		6.41	3.88	0.00341	0.00206	PASS
Extreme (70°C)		12.08	11.79	0.00642	0.00627	PASS
Extreme (60°C)		11.57	8.31	0.00615	0.00442	PASS
Extreme (50°C)		2.44	13.20	0.00130	0.00702	PASS
Extreme (40°C)		9.91	5.56	0.00527	0.00295	PASS
Extreme (30°C)		10.98	11.76	0.00584	0.00625	PASS
Extreme (20°C)		9.69	14.42	0.00515	0.00767	PASS
Extreme (10°C)		5.30	9.57	0.00282	0.00509	PASS
Extreme (0°C)		3.91	13.58	0.00208	0.00722	PASS
Extreme (-10°C)		14.87	10.84	0.00791	0.00577	PASS
Extreme (-20°C)		5.32	15.57	0.00283	0.00828	PASS
Extreme (-30°C)		9.70	3.69	0.00516	0.00196	PASS
Extreme (-40°C)		3.72	2.58	0.00198	0.00137	PASS
25°C		LV	3.48	8.42	0.00185	0.00448
	HV	12.24	10.55	0.00651	0.00561	PASS

5.6. Spurious Emissions at Antenna Terminals

Ambient condition

Temperature	Relative humidity	Pressure
23°C ~25°C	45%~50%	101.5kPa

Method of Measurement

The EUT was connected to Spectrum Analyzer and Base Station Simulator via power Splitter. The measurement is carried out using a spectrum analyzer. The spectrum analyzer scans from 9kHz to the 10th harmonic of the carrier. The peak detector is used.

RBW is set to 100kHz, VBW is set to 300kHz for 30MHz~1GHz

RBW is set to 1MHz, VBW is set to 3MHz for above 1GHz, Sweep is set to ATUO.

The modulation mode and RB allocation refer to section 5.1, using the maximum output power configuration.

Test setup

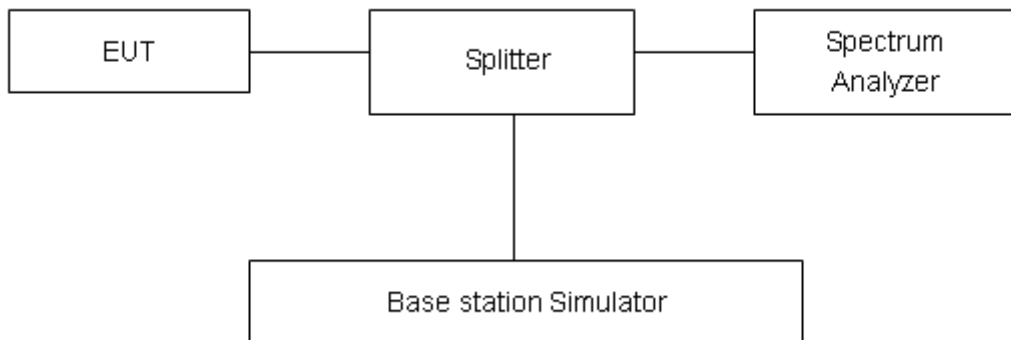

Limits

Rule Part 24.238(a) specifies that “on any frequency outside a licensee's frequency block, the power of any emission shall be attenuated below the transmitter power (P) by at least 43 + 10 log₁₀ (P) dB.”

Limit	-13 dBm
-------	---------

Measurement Uncertainty

The assessed measurement uncertainty to ensure 99.75% confidence level for the normal distribution is with the coverage factor $k = 1.96$.

Frequency	Uncertainty
9kHz-1GHz	0.684 dB
1GHz-20GHz	1.407 dB

Test Result

Sweep the whole frequency band through the range from 9kHz to the 10th harmonic of the carrier, the emissions more than 20 dB below the limit are not reported.

The signal beyond the limit is carrier.

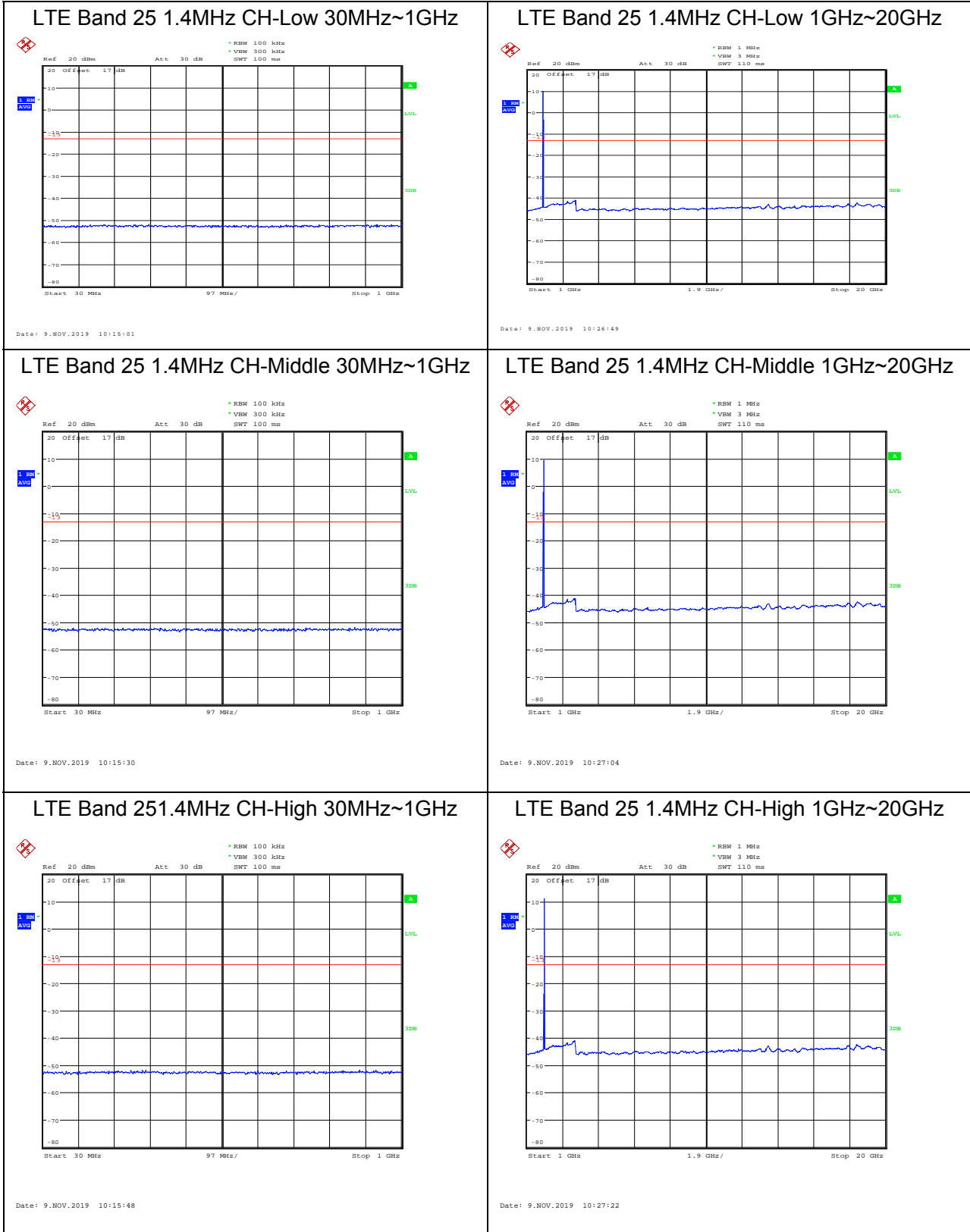



LTE Band 25 3MHz CH-Low 30MHz~1GHz

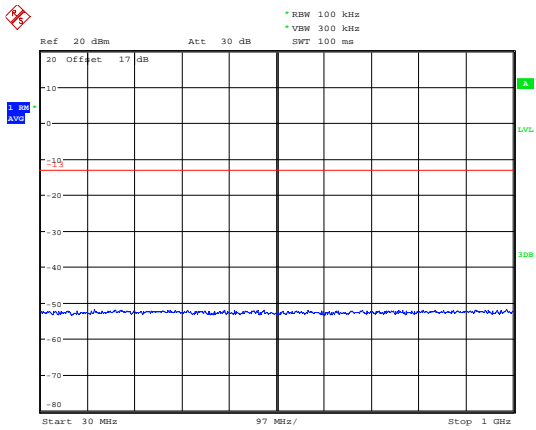

Date: 9.NOV.2019 10:18:22

LTE Band 25 3MHz CH-Low 1GHz~20GHz

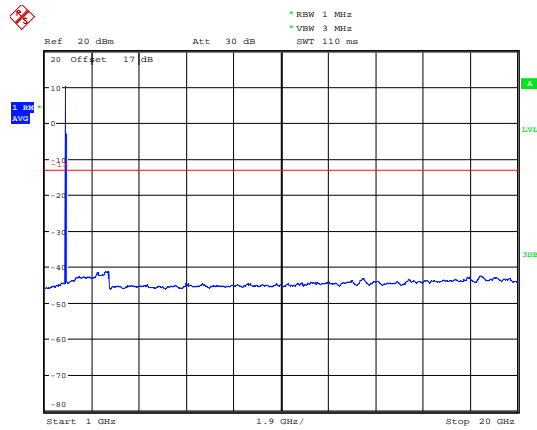

Date: 9.NOV.2019 10:28:31

LTE Band 25 3MHz CH-Middle 30MHz~1GHz

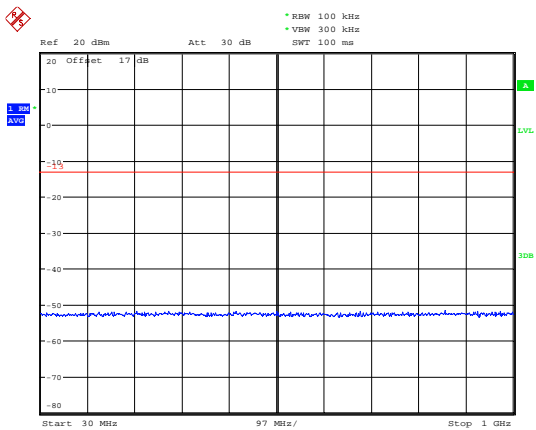

Date: 9.NOV.2019 10:18:39

LTE Band 25 3MHz CH-Middle 1GHz~20GHz

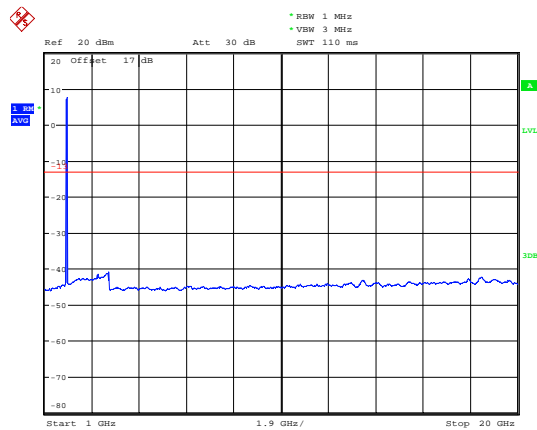

Date: 9.NOV.2019 10:28:47

LTE Band 25 3MHz CH-High 30MHz~1GHz

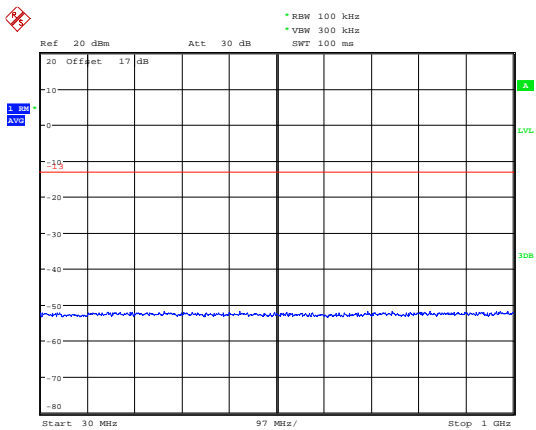

Date: 9.NOV.2019 10:18:58

LTE Band 25 3MHz CH-High 1GHz~20GHz

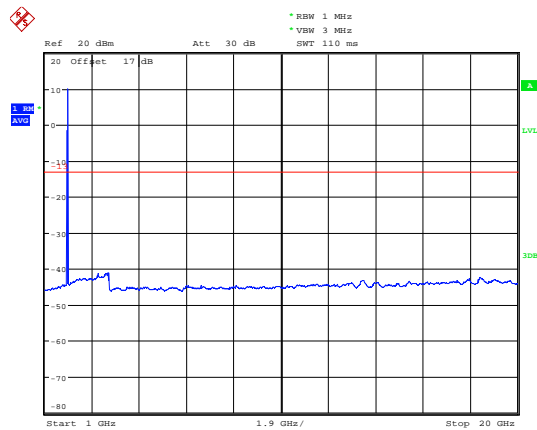

Date: 9.NOV.2019 10:29:04



LTE Band 25 5MHz CH-Low 30MHz~1GHz

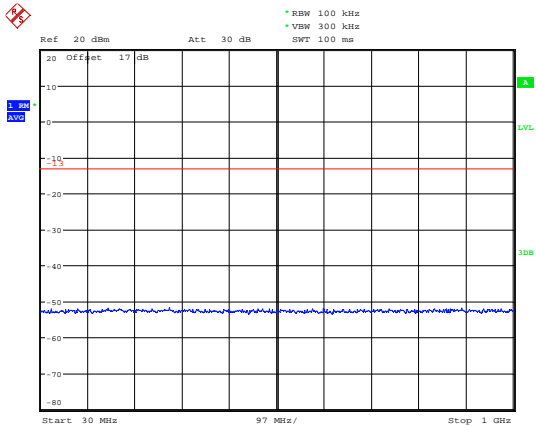

Date: 9.NOV.2019 10:20:29

LTE Band 25 5MHz CH-Low 1GHz~20GHz

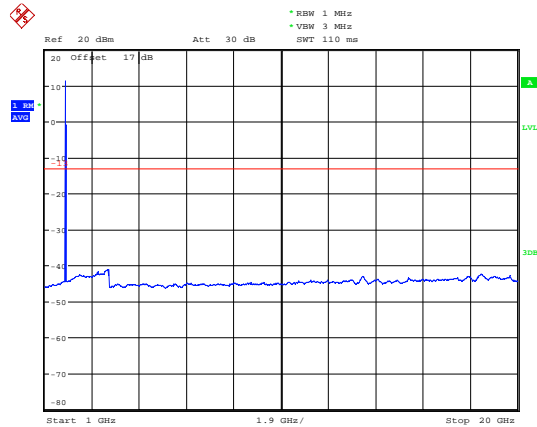

Date: 9.NOV.2019 10:29:32

LTE Band 25 5MHz CH-Middle 30MHz~1GHz

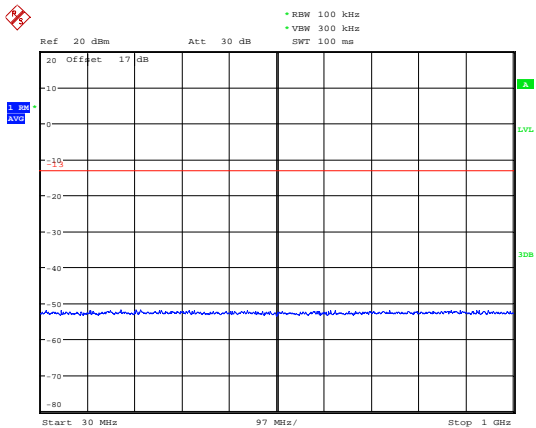

Date: 9.NOV.2019 10:20:48

LTE Band 25 5MHz CH-Middle 1GHz~20GHz

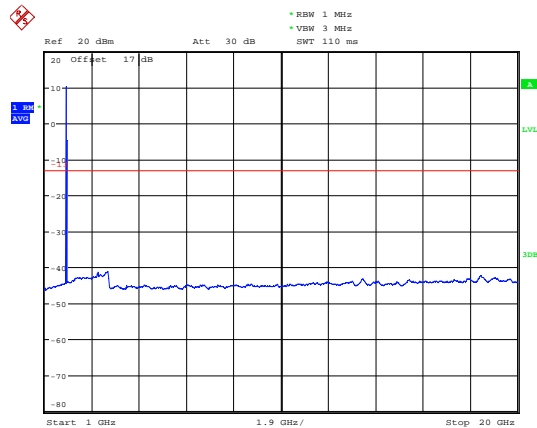

Date: 9.NOV.2019 10:29:47

LTE Band 25 5MHz CH-High 30MHz~1GHz

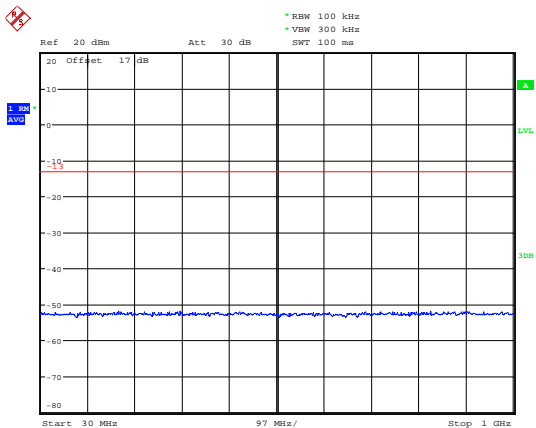

Date: 9.NOV.2019 10:21:06

LTE Band 25 5MHz CH-High 1GHz~20GHz

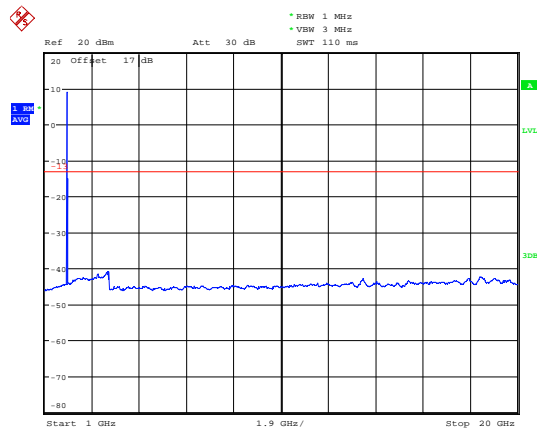

Date: 9.NOV.2019 10:30:05



LTE Band 25 10MHz CH-Low 30MHz~1GHz

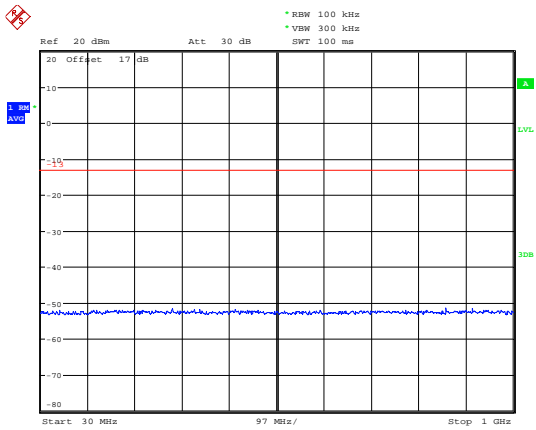

Date: 9.NOV.2019 10:21:43

LTE Band 25 10MHz CH-Low 1GHz~20GHz

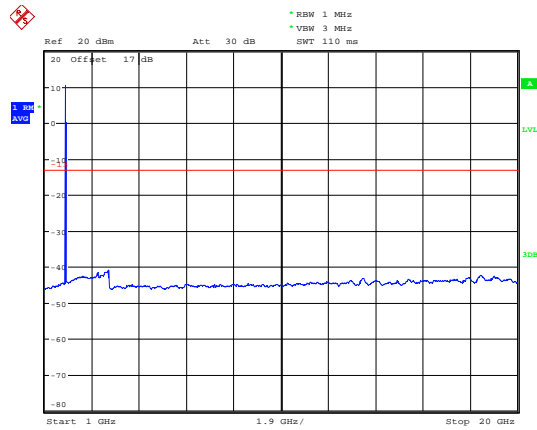

Date: 9.NOV.2019 10:30:30

LTE Band 25 10MHz CH-Middle 30MHz~1GHz

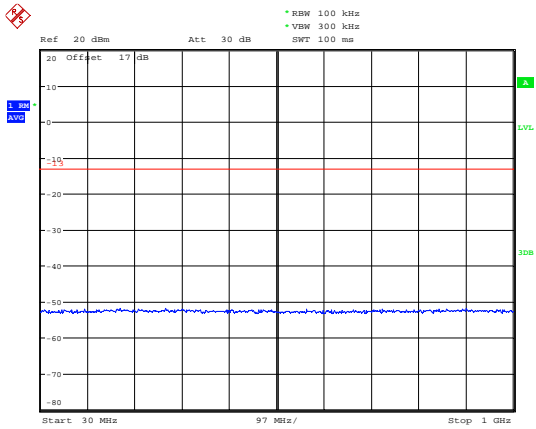

Date: 9.NOV.2019 10:22:01

LTE Band 25 10MHz CH-Middle 1GHz~20GHz

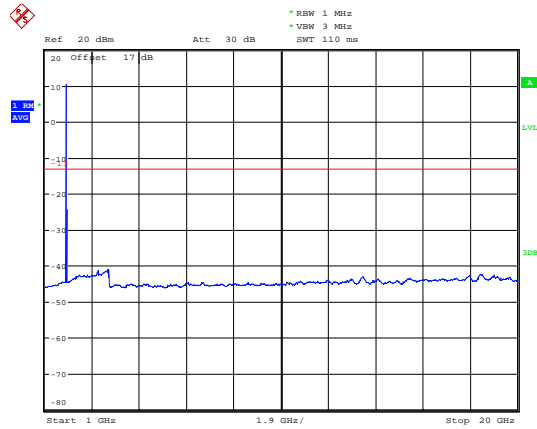

Date: 9.NOV.2019 10:30:43

LTE Band 25 10MHz CH-High 30MHz~1GHz

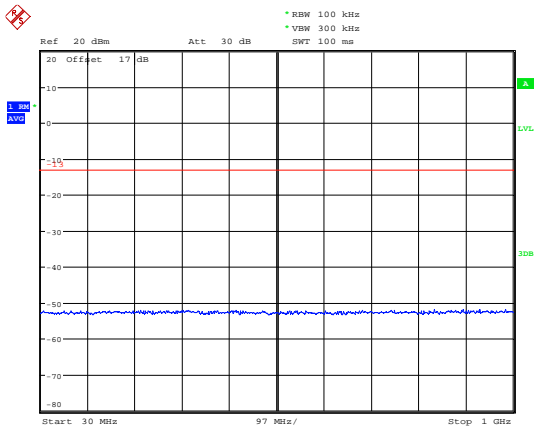

Date: 9.NOV.2019 10:22:52

LTE Band 25 10MHz CH-High 1GHz~20GHz

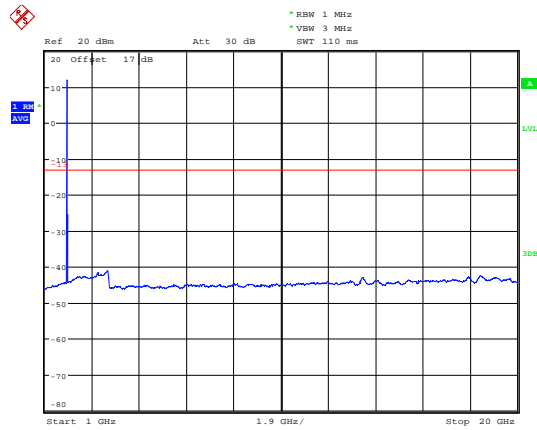

Date: 9.NOV.2019 10:30:59



LTE Band 25 15MHz CH-Low 30MHz~1GHz

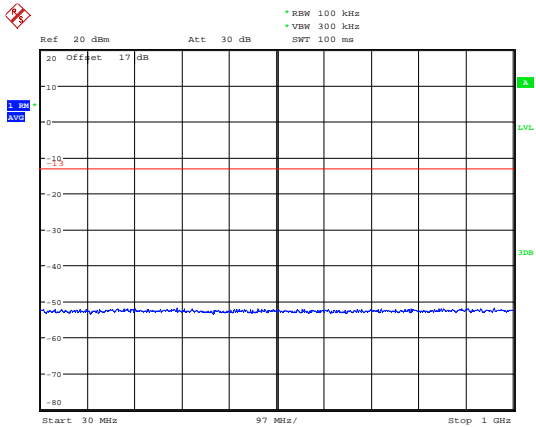

Date: 9.NOV.2019 10:23:45

LTE Band 25 15MHz CH-Low 1GHz~20GHz

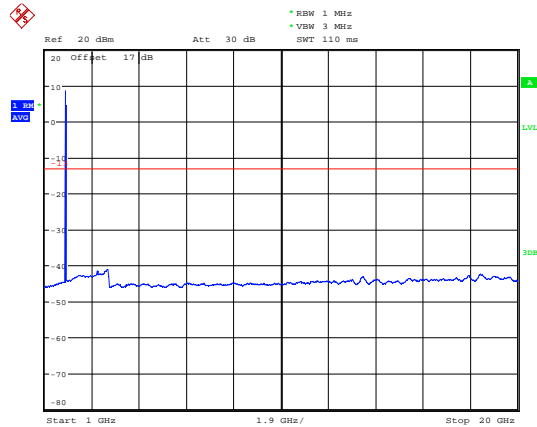

Date: 9.NOV.2019 10:31:26

LTE Band 25 15MHz CH-Middle 30MHz~1GHz

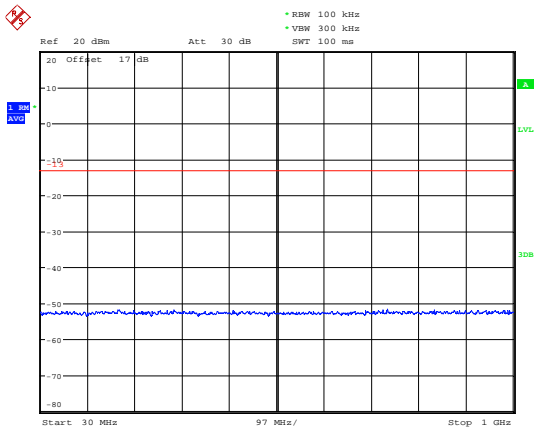

Date: 9.NOV.2019 10:24:00

LTE Band 25 15MHz CH-Middle 1GHz~20GHz

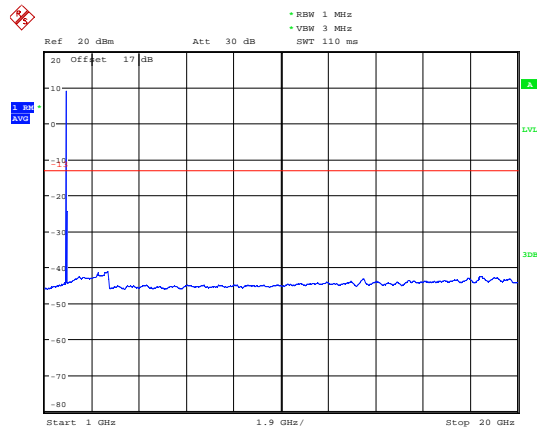

Date: 9.NOV.2019 10:31:51

LTE Band 25 15MHz CH-High 30MHz~1GHz

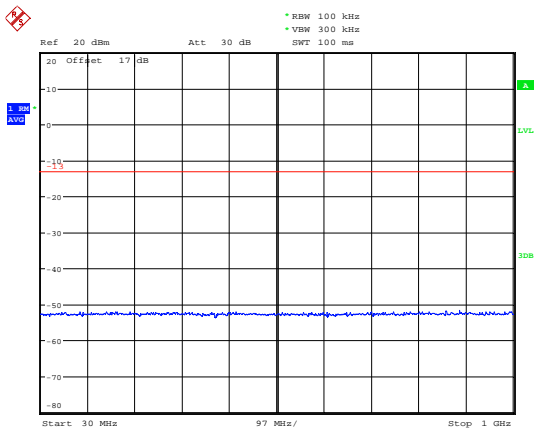

Date: 9.NOV.2019 10:24:18

LTE Band 25 15MHz CH-High 1GHz~20GHz

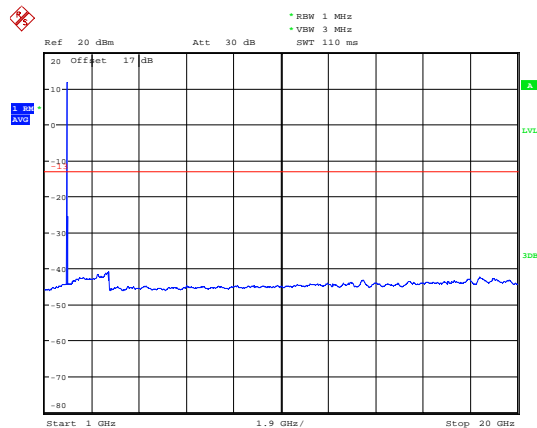

Date: 9.NOV.2019 10:32:08

LTE Band 25 20MHz CH-Low 30MHz~1GHz

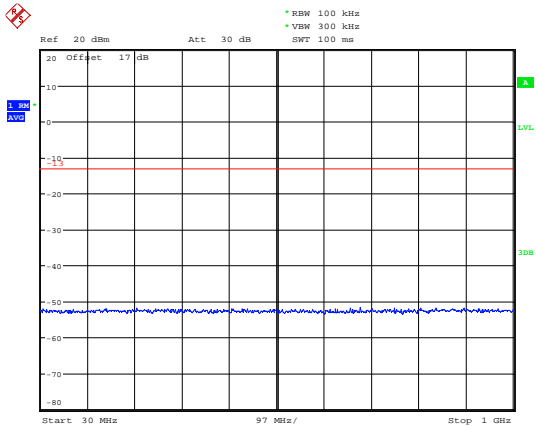

Date: 9.NOV.2019 10:24:59

LTE Band 25 20MHz CH-Low 1GHz~20GHz

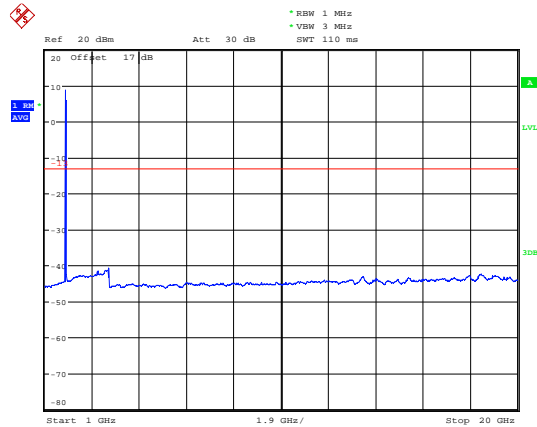

Date: 9.NOV.2019 10:32:32

LTE Band 25 20MHz CH-Middle 30MHz~1GHz

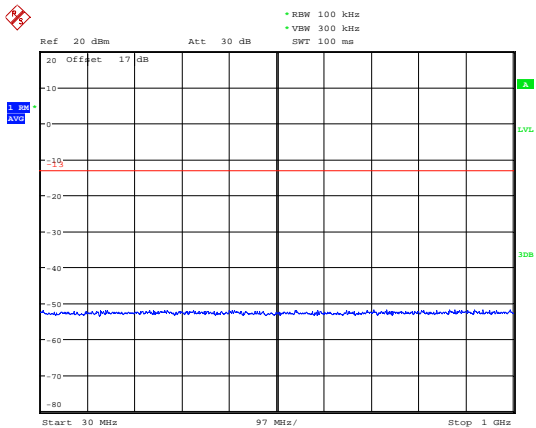

Date: 9.NOV.2019 10:25:15

LTE Band 25 20MHz CH-Middle 1GHz~20GHz

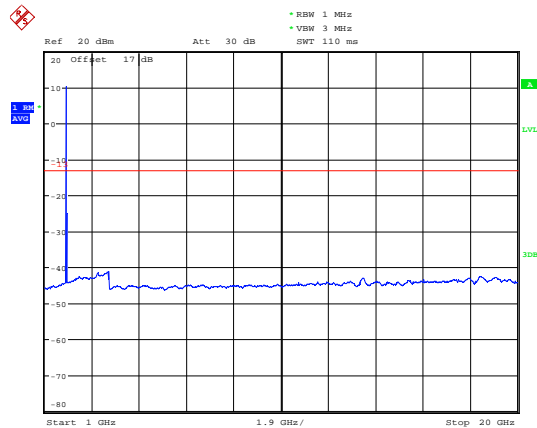

Date: 9.NOV.2019 10:32:45

LTE Band 25 20MHz CH-High 30MHz~1GHz

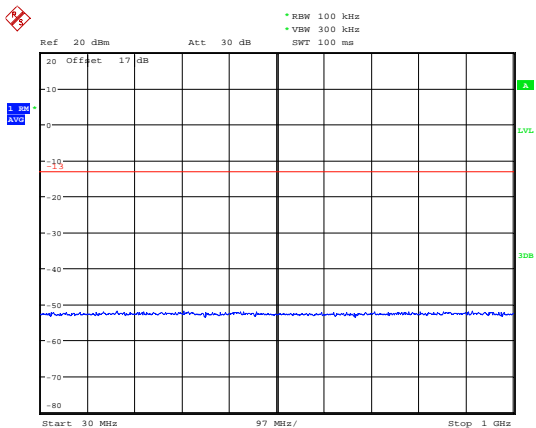

Date: 9.NOV.2019 10:25:58

LTE Band 25 20MHz CH-High 1GHz~20GHz

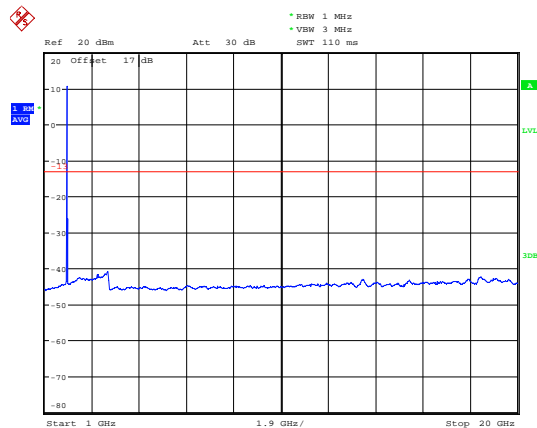

Date: 9.NOV.2019 10:33:01

5.7. Radiates Spurious Emission

Ambient condition

Temperature	Relative humidity	Pressure
23°C ~25°C	45%~50%	101.5kPa

Method of Measurement

1. The testing follows FCC KDB 971168 v03r01 Section 5.8 and ANSI C63.26 (2015).
2. Below 1GHz: The EUT is placed on a turntable 0.8 meters above the ground in the chamber, 3 meter away from the antenna. The maximal emission value is acquired by adjusting the antenna height, polarisation and turntable azimuth. Normally, the height range of antenna is 1 m to 4 m, the azimuth range of turntable is 0° to 360°, and the receive antenna has two polarizations Vertical (V) and Horizontal (H). Above 1GHz: (Note: the FCC’s permission to use 1.5m as an alternative per TCBC Conf call of Dec. 2, 2014.) The EUT is placed on a turntable 1.5 meters above the ground in the chamber, 3 meter away from the antenna. The maximal emission value is acquired by adjusting the antenna height, polarisation and turntable azimuth. Normally, the height range of antenna is 1 m to 4 m, the azimuth range of turntable is 0° to 360°, and the receive antenna has two polarizations Vertical (V) and Horizontal (H).
3. A loop antenna, A log-periodic antenna or horn antenna shall be substituted in place of the EUT. The log-periodic antenna will be driven by a signal generator and the level will be adjusted till the same power value on the spectrum analyzer or receiver. The level of the spurious emissions can be calculated through the level of the signal generator, cable loss, the gain of the substitution antenna and the reading of the spectrum analyzer or receiver.
4. The EUT is then put into continuously transmitting mode at its maximum power level during the test. Set Test Receiver or Spectrum RBW=200Hz,VBW=600Hz for 9kHz150kHz , RBW=10kHz, VBW=30kHz 150kHz-30MHz , RBW=100kHz,VBW=300kHz for 30MHz to 1GHz and RBW=1MHz, VBW=3MHz for above 1GHz, And the maximum value of the receiver should be recorded as (Pr).
5. The EUT shall be replaced by a substitution antenna. In the chamber, an substitution antenna for the frequency band of interest is placed at the reference point of the chamber. An RF Signal source for the frequency band of interest is connected to the substitution antenna with a cable that has been constructed to not interfere with the radiation pattern of the antenna. A power (PMea) is applied to the input of the substitution antenna, and adjust the level of the signal generator output until the value of the receiver reach the previously recorded (Pr). The power of signal source (PMea) is recorded. The test should be performed by rotating the test item and adjusting the receiving antenna polarization.
6. A amplifier should be connected to the Signal Source output port. And the cable should be connect between the Amplifier and the Substitution Antenna. The cable loss (Pcl) ,the Substitution Antenna Gain (Ga) and the Amplifier Gain (PAg) should be recorded after test.
7. The measurement results are obtained as described below:
 $Power(EIRP)=PMea- PAg - Pcl + Ga$
 The measurement results are amend as described below:
 $Power(EIRP)=PMea- Pcl + Ga$
8. This value is EIRP since the measurement is calibrated using an antenna of known gain (2.15 dBi)

and known input power. ERP can be calculated from EIRP by subtracting the gain of the dipole, $ERP = EIRP - 2.15\text{dBi}$.

The modulation mode and RB allocation refer to section 5.1, using the maximum output power configuration.

Test setup

9KHz ~ 30MHz

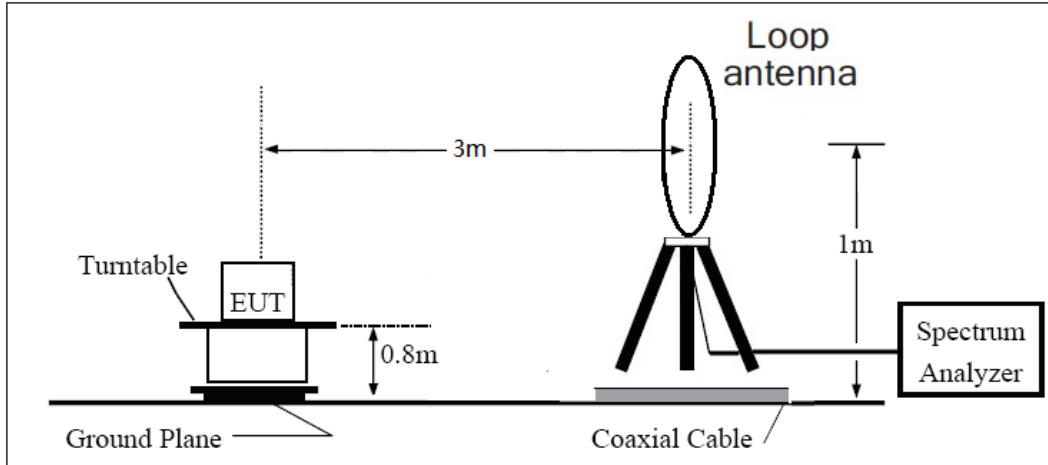

30MHz ~ 1GHz

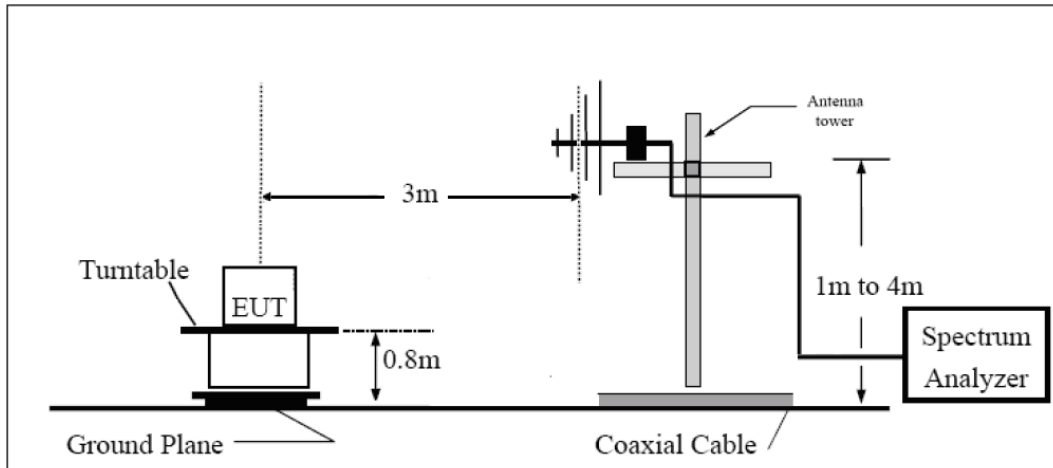

Above 1GHz

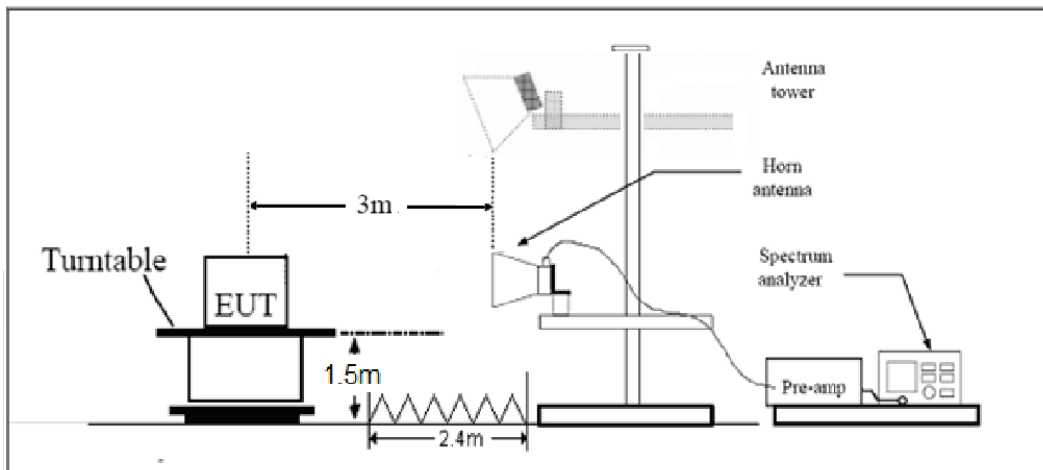



Note: Area side: 2.4mX3.6m

Limits

Rule Part 24.238(a) specifies that “on any frequency outside a licensee's frequency block, the power of any emission shall be attenuated below the transmitter power (P) by at least $43 + 10 \log_{10} (P)$ dB.”

Limit	-13 dBm
-------	---------

Measurement Uncertainty

The assessed measurement uncertainty to ensure 95% confidence level for the normal distribution is with the coverage factor $k = 1.96$, $U = 3.55$ dB.

Test Result

Sweep the whole frequency band through the range from 9kHz to the 10th harmonic of the carrier, the emissions below the noise floor will not be recorded in the report.

LTE Band 25 1.4MHz CH-Middle

Harmonic	Frequency (MHz)	SG (dBm)	Cable Loss (dB)	Gain (dBi)	Antenna Polarization	EIRP Level (dBm)	Limit (dBm)	Margin (dB)	Azimuth (deg)
2	3765.0	-45.00	5.10	11.05	Horizontal	-39.05	-13.00	26.05	135
3	5647.5	-48.91	5.42	12.65	Horizontal	-41.68	-13.00	28.68	315
4	7530.0	-58.71	6.70	13.85	Horizontal	-51.56	-13.00	38.56	135
5	9412.5	-56.72	7.01	14.75	Horizontal	-48.98	-13.00	35.98	270
6	11295.0	-55.02	7.48	15.95	Horizontal	-46.55	-13.00	33.55	225
7	13177.5	-55.18	7.51	16.55	Horizontal	-46.14	-13.00	33.14	45
8	15060.0	-52.94	8.24	15.35	Horizontal	-45.83	-13.00	32.83	0
9	16942.5	-53.14	8.41	14.95	Horizontal	-46.60	-13.00	33.60	315
10	18825.0	--	--	--	--	--	--	--	--

Note: 1.The other Spurious RF Radiated emissions level is no more than noise floor.
 2. The worst emission was found in the antenna is Horizontal position.

LTE Band 25 5MHz CH-Middle

Harmonic	Frequency (MHz)	SG (dBm)	Cable Loss (dB)	Gain (dBi)	Antenna Polarization	EIRP Level (dBm)	Limit (dBm)	Margin (dB)	Azimuth (deg)
2	3765.0	-54.86	5.10	11.05	Horizontal	-48.91	-13.00	35.91	90
3	5647.5	-47.62	5.42	12.65	Horizontal	-40.39	-13.00	27.39	45
4	7530.0	-58.09	6.70	13.85	Horizontal	-50.94	-13.00	37.94	225
5	9412.5	-56.11	7.01	14.75	Horizontal	-48.37	-13.00	35.37	270
6	11295.0	-55.88	7.48	15.95	Horizontal	-47.41	-13.00	34.41	315
7	13177.5	-54.92	7.51	16.55	Horizontal	-45.88	-13.00	32.88	180
8	15060.0	-53.74	8.24	15.35	Horizontal	-46.63	-13.00	33.63	225
9	16942.5	-48.92	8.41	14.95	Horizontal	-42.38	-13.00	29.38	135
10	18825.0	--	--	--	--	--	--	--	--

Note: 1.The other Spurious RF Radiated emissions level is no more than noise floor.
 2. The worst emission was found in the antenna is Horizontal position.



LTE Band 25 10MHz CH-Middle

Harmonic	Frequency (MHz)	SG (dBm)	Cable Loss (dB)	Gain (dBi)	Antenna Polarization	EIRP Level (dBm)	Limit (dBm)	Margin (dB)	Azimuth (deg)
2	3765.0	-48.09	5.10	11.05	Horizontal	-42.14	-13.00	29.14	90
3	5647.5	-49.84	5.42	12.65	Horizontal	-42.61	-13.00	29.61	45
4	7530.0	-57.48	6.70	13.85	Horizontal	-50.33	-13.00	37.33	0
5	9412.5	-57.62	7.01	14.75	Horizontal	-49.88	-13.00	36.88	0
6	11295.0	-56.17	7.48	15.95	Horizontal	-47.70	-13.00	34.70	90
7	13177.5	-56.31	7.51	16.55	Horizontal	-47.27	-13.00	34.27	135
8	15060.0	-53.22	8.24	15.35	Horizontal	-46.11	-13.00	33.11	270
9	16942.5	-52.14	8.41	14.95	Horizontal	-45.60	-13.00	32.60	315
10	18825.0	--	--	--	--	--	--	--	--

Note: 1. The other Spurious RF Radiated emissions level is no more than noise floor.

2. The worst emission was found in the antenna is Horizontal position.

6. Main Test Instruments

Name	Manufacturer	Type	Serial Number	Calibration Date	Expiration Date
Base Station Simulator	R&S	CMU200	118133	2019-05-19	2020-05-18
Base Station Simulator	R&S	CMW500	113824	2019-05-19	2020-05-18
Power Splitter	Hua Xiang	SHX-GF2-2-13	10120101	/	/
Spectrum Analyzer	Key sight	N9010A	MY50210259	2019-05-19	2020-05-18
Universal Radio Communication Tester	Key sight	E5515C	MY48367192	2019-05-19	2020-05-18
Signal Analyzer	R&S	FSV30	100815	2018-12-16	2019-12-15
Loop Antenna	SCHWARZBECK	FMZB1519	1519-047	2017-09-26	2020-09-25
Trilog Antenna	SCHWARZBECK	VUBL 9163	9163-201	2017-11-18	2020-11-17
Horn Antenna	R&S	HF907	100126	2018-07-07	2020-07-06
Horn Antenna	ETS-Lindgren	3160-09	00102643	2018-06-20	2020-06-19
Signal generator	R&S	SMB 100A	102594	2019-05-19	2020-05-18
Climatic Chamber	ESPEC	SU-242	93000506	2017-12-17	2020-12-16
Preamplifier	R&S	SCU18	102327	2019-05-19	2020-05-18
MOB COMMS DC SUPPLY	Keysight	66319D	MY43004105	2019-05-19	2020-05-18
RF Cable	Agilent	SMA 15cm	0001	2019-06-14	2019-12-13
Software	R&S	EMC32	9.26.0	/	/

*****END OF REPORT *****