

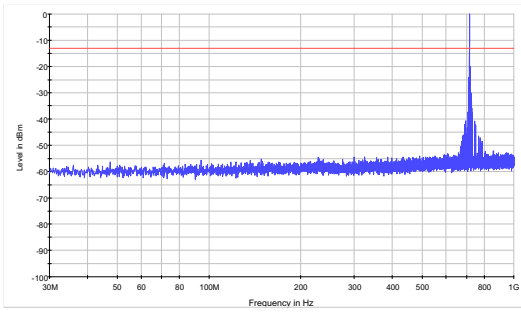

LTE Band 12 1.4MHz CH-High30MHz~1GHz

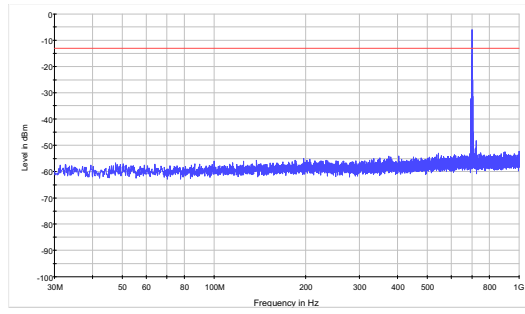

LTE Band 12 3MHz CH-Low30MHz~1GHz



LTE Band 12 1.4MHz CH-High1GHz~3GHz

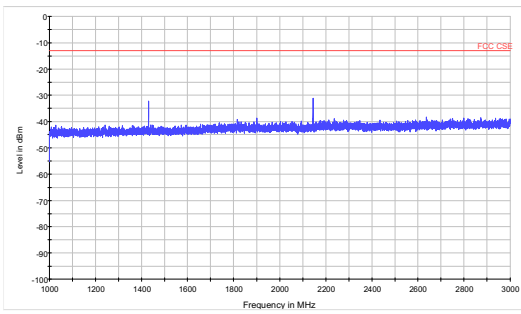

LTE Band 12 3MHz CH-Low1GHz~3GHz

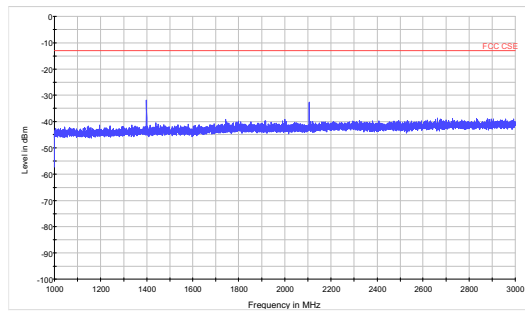

LTE Band 12 1.4MHz CH-High3GHz~8GHz

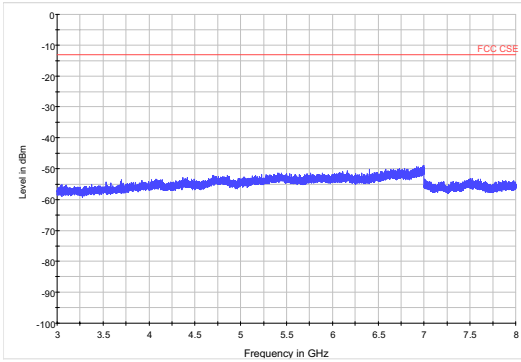

LTE Band 12 3MHz CH-Low3GHz~8GHz

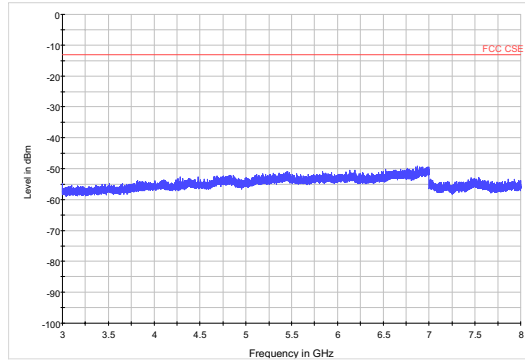

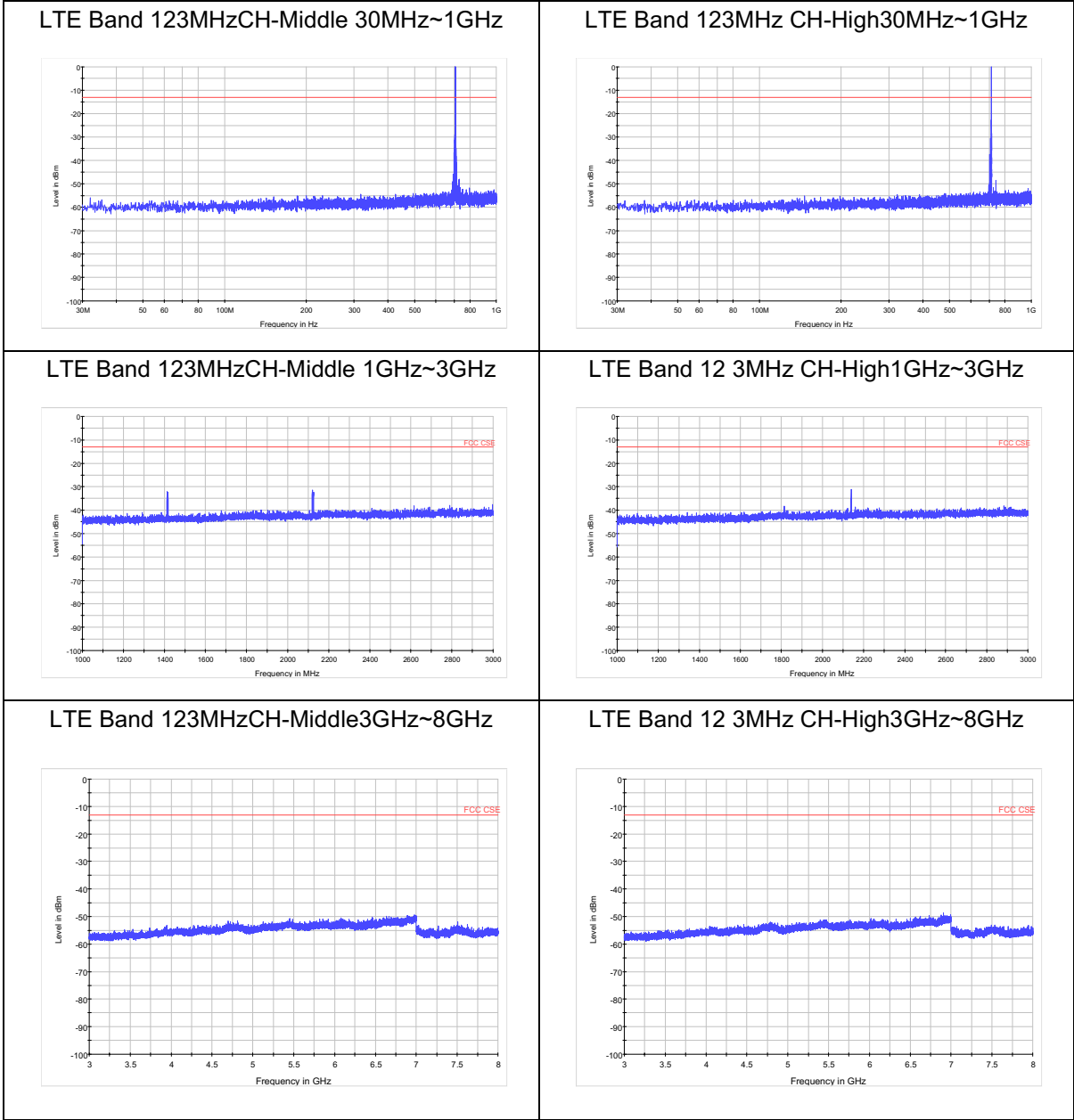

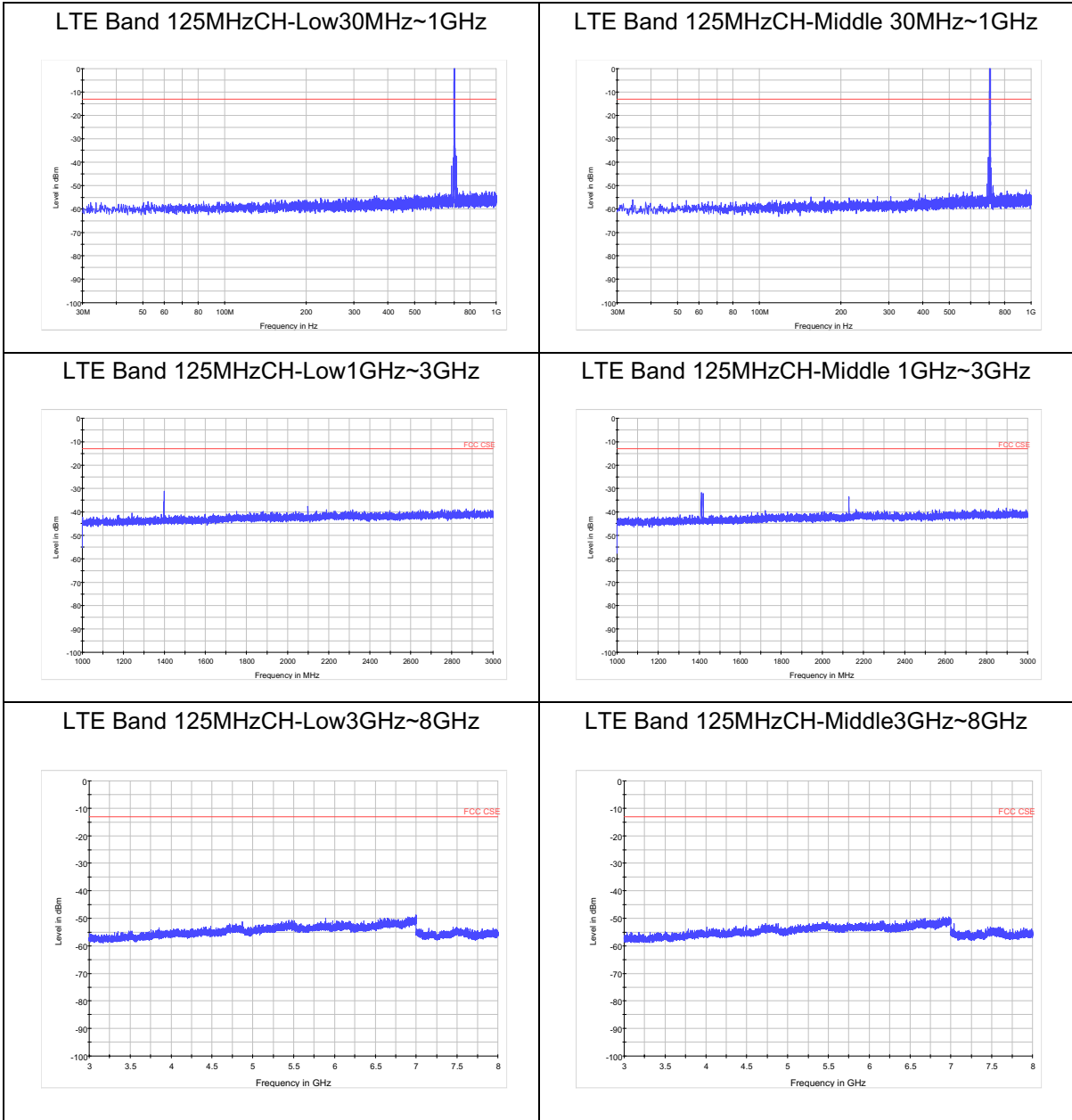



LTE Band 125MHzCH-High30MHz~1GHz

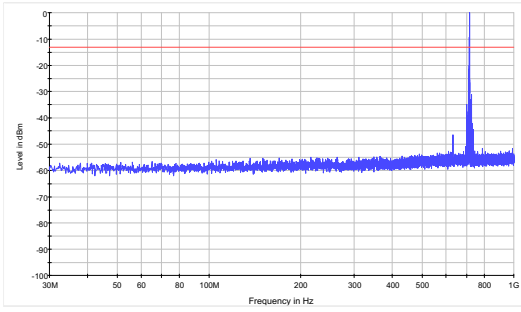

LTE Band 1210MHzCH-Low 30MHz~1GHz

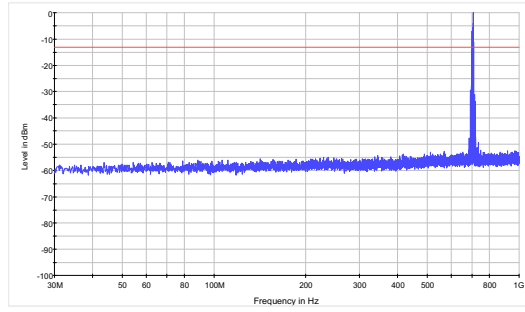

LTE Band 125MHzCH-High 1GHz~3GHz

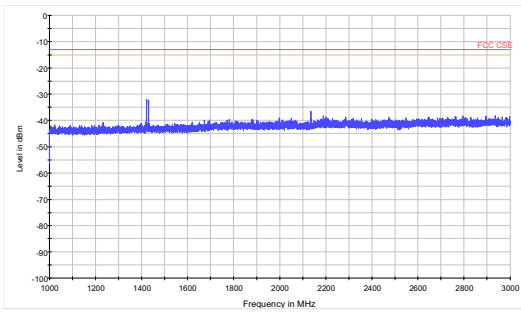

LTE Band 1210MHzCH-Low 1GHz~3GHz

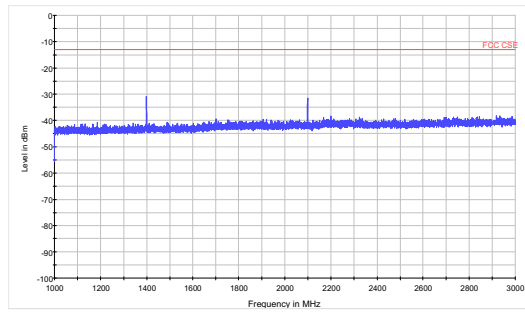

LTE Band 125MHzCH-High3GHz~8GHz

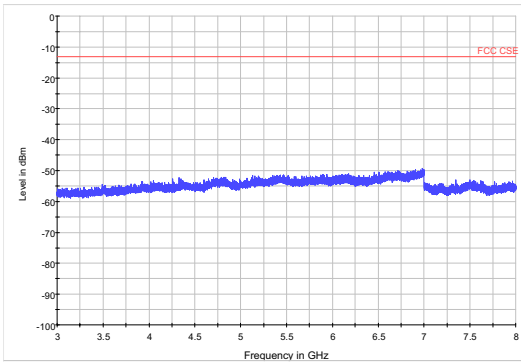

LTE Band 1210MHzCH-Low3GHz~8GHz

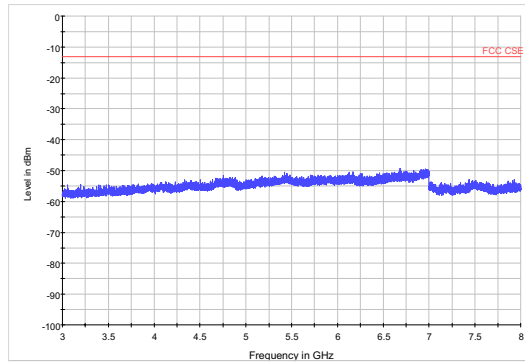



LTE Band 1210MHzCH-Middle 30MHz~1GHz

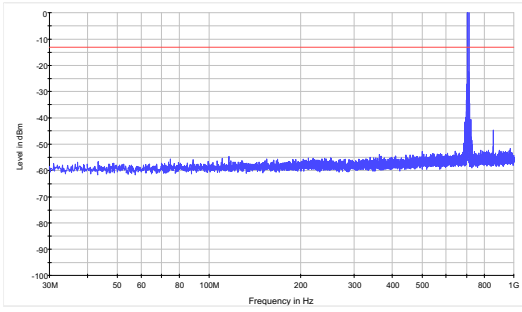

LTE Band 1210MHzCH-High 30MHz~1GHz

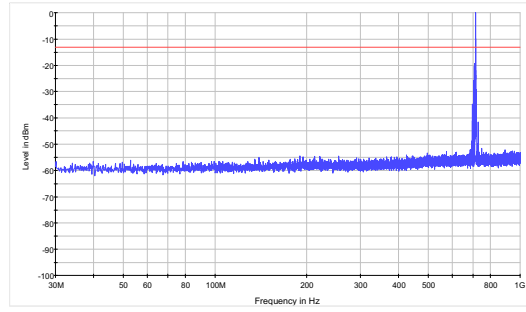

LTE Band 1210MHzCH-Middle 1GHz~3GHz

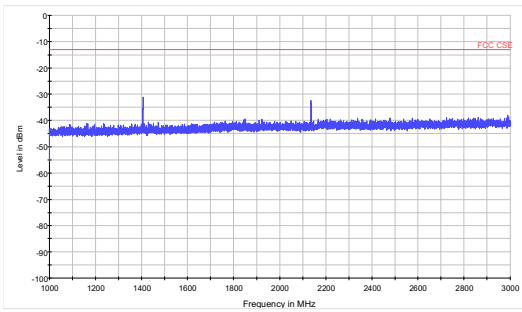

LTE Band 1210MHzCH-High 1GHz~3GHz

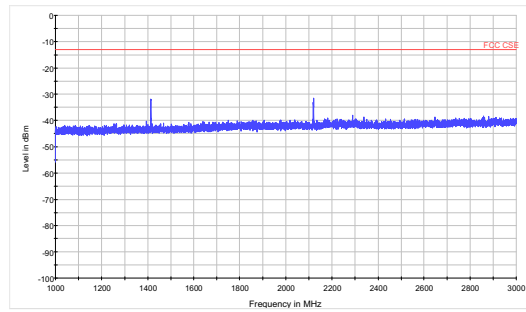

LTE Band 1210MHzCH-Middle 3GHz~8GHz

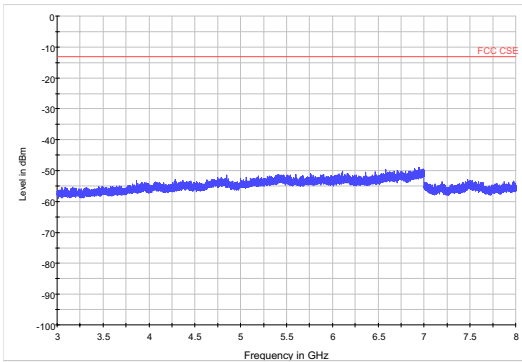

LTE Band 1210MHzCH-High 3GHz~8GHz

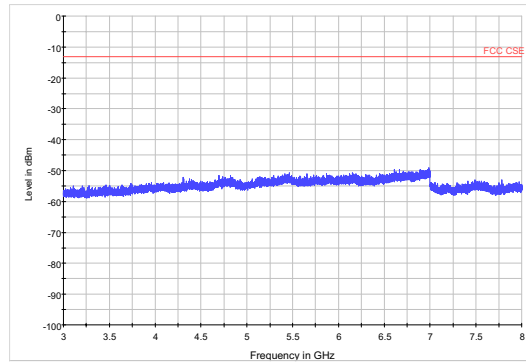



LTE Band 135MHz CH-Low 30MHz~3GHz

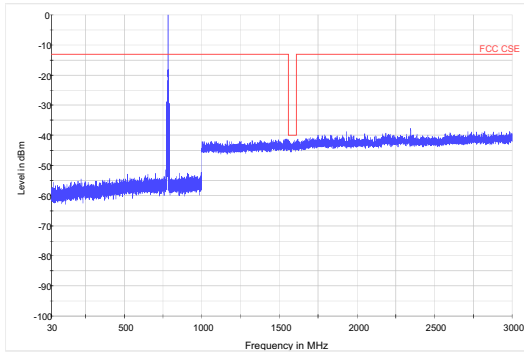

LTE Band 135MHz CH-Low 3GHz~8GHz

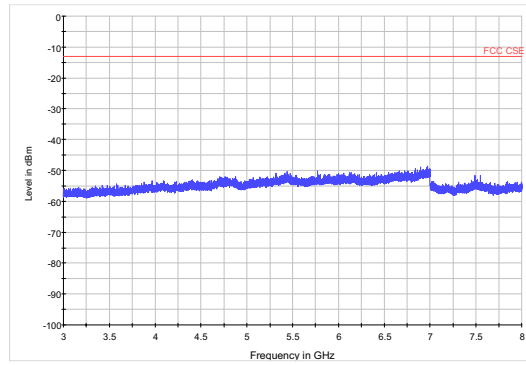

LTE Band 135MHz CH-Middle 30MHz~3GHz

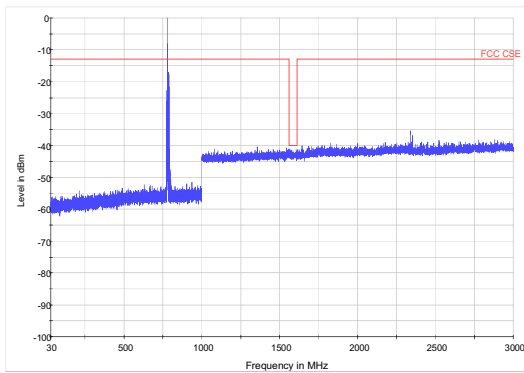

LTE Band 135MHz CH-Middle 3GHz~8GHz

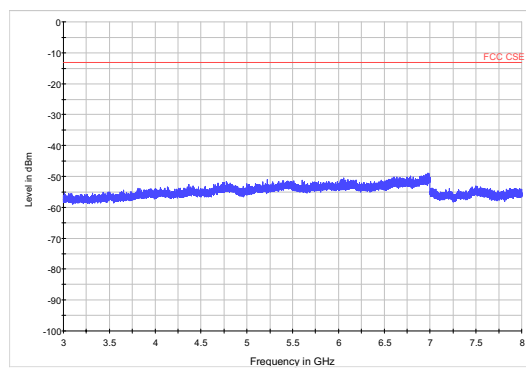

LTE Band 135MHzCH-High 30MHz~3GHz

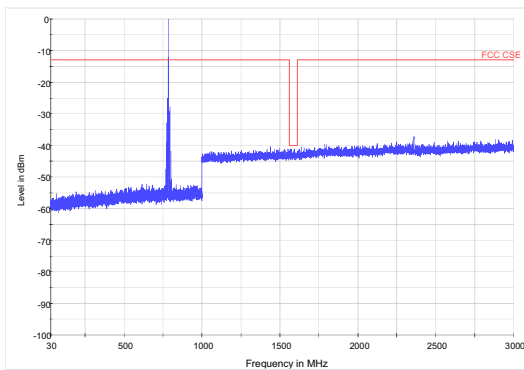

LTE Band 135MHzCH-High3GHz~8GHz

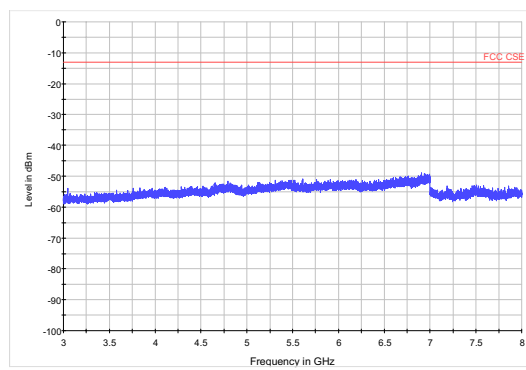



LTE Band 1310MHz CH-Low 30MHz~3GHz

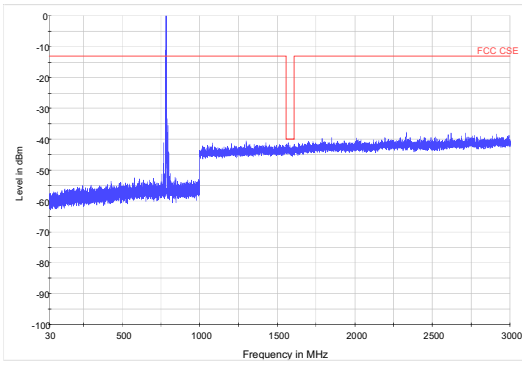

LTE Band 1310MHz CH-Low 3GHz~8GHz

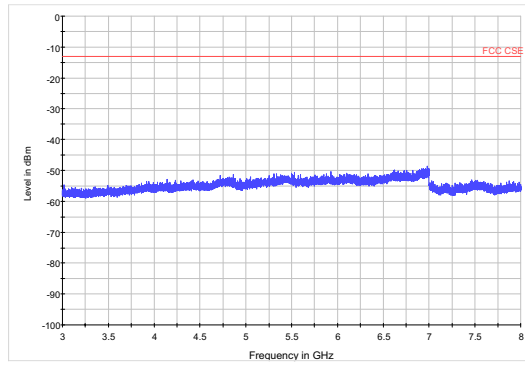

LTE Band 1310MHz CH-Middle 30MHz~3GHz

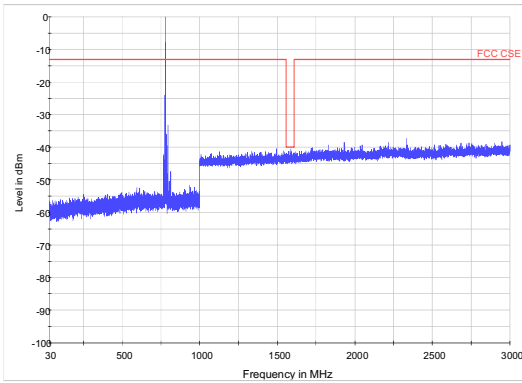

LTE Band 1310MHz CH-Middle 3GHz~8GHz

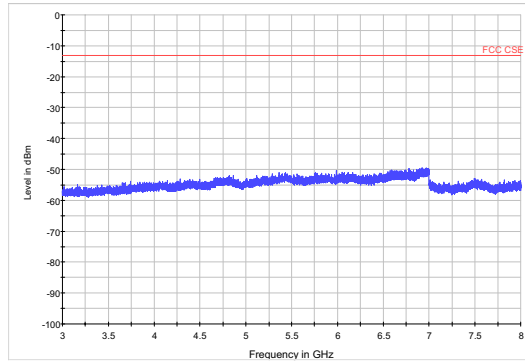

LTE Band 1310MHz CH-High 30MHz~3GHz

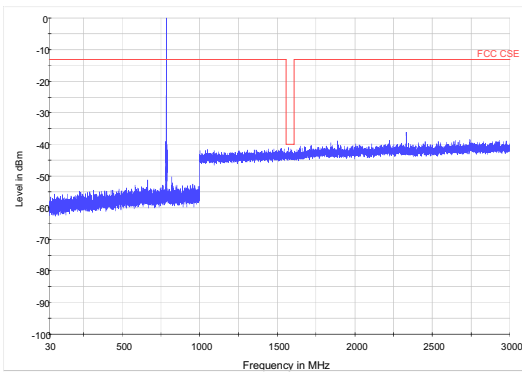

LTE Band 1310MHz CH-High 3GHz~8GHz

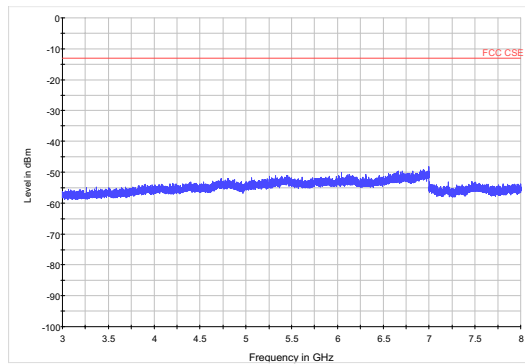



## 5.8 Radiates Spurious Emission

### Ambient condition

Temperature	Relative humidity	Pressure
23°C ~25°C	45%~50%	101.5kPa

### Method of Measurement

1. The testing follows FCC KDB 971168 D01 v03r01 Section 5.8 and ANSI C63.26 (2015).
2. Below 1GHz: The EUT is placed on a turntable 0.8 meters above the ground in the chamber, 3 meter away from the antenna. The maximal emission value is acquired by adjusting the antenna height, polarisation and turntable azimuth. Normally, the height range of antenna is 1 m to 4 m, the azimuth range of turntable is 0° to 360°, and the receive antenna has two polarizations Vertical (V) and Horizontal (H). Above 1GHz: (Note: the FCC's permission to use 1.5m as an alternative per TCBC Conf call of Dec. 2, 2014.) The EUT is placed on a turntable 1.5 meters above the ground in the chamber, 3 meter away from the antenna. The maximal emission value is acquired by adjusting the antenna height, polarisation and turntable azimuth. Normally, the height range of antenna is 1 m to 4 m, the azimuth range of turntable is 0° to 360°, and the receive antenna has two polarizations Vertical (V) and Horizontal (H).
3. A loop antenna, A log-periodic antenna or horn antenna shall be substituted in place of the EUT. The log-periodic antenna will be driven by a signal generator and the level will be adjusted till the same power value on the spectrum analyzer or receiver. The level of the spurious emissions can be calculated through the level of the signal generator, cable loss, the gain of the substitution antenna and the reading of the spectrum analyzer or receiver.
4. The EUT is then put into continuously transmitting mode at its maximum power level during the test. Set Test Receiver or Spectrum RBW=200Hz, VBW=600Hz for 9kHz-150kHz, RBW=10kHz, VBW=30kHz-150kHz-30MHz, RBW=100kHz, VBW=300kHz for 30MHz to 1GHz and RBW=1MHz, VBW=3MHz for above 1GHz. And the maximum value of the receiver should be recorded as (Pr).
5. The EUT shall be replaced by a substitution antenna. In the chamber, a substitution antenna for the frequency band of interest is placed at the reference point of the chamber. An RF Signal source for the frequency band of interest is connected to the substitution antenna with a cable that has been constructed to not interfere with the radiation pattern of the antenna. A power (P<sub>Mea</sub>) is applied to the input of the substitution antenna, and adjust the level of the signal generator output until the value of the receiver reach the previously recorded (Pr). The power of signal source (P<sub>Mea</sub>) is recorded. The test should be performed by rotating the test item and adjusting the receiving antenna polarization.
6. An amplifier should be connected to the Signal Source output port. And the cable should be connect between the Amplifier and the Substitution Antenna. The cable loss (P<sub>cl</sub>), the Substitution Antenna Gain (G<sub>a</sub>) and the Amplifier Gain (P<sub>Ag</sub>) should be recorded after test.
7. The measurement results are obtained as described below:

$$\text{Power(EIRP)} = P_{Mea} - P_{Ag} - P_{cl} + G_a$$

The measurement results are amend as described below:

$$\text{Power(EIRP)} = P_{Mea} - P_{cl} + G_a$$

8. This value is EIRP since the measurement is calibrated using an antenna of known gain (2.15 dBi)

and known input power. ERP can be calculated from EIRP by subtracting the gain of the dipole,  $ERP = EIRP - 2.15\text{dBi}$ .

The modulation mode and RB allocation refer to section 5.1, using the maximum output power configuration.

**Test setup**

**9KHz~ 30MHz**

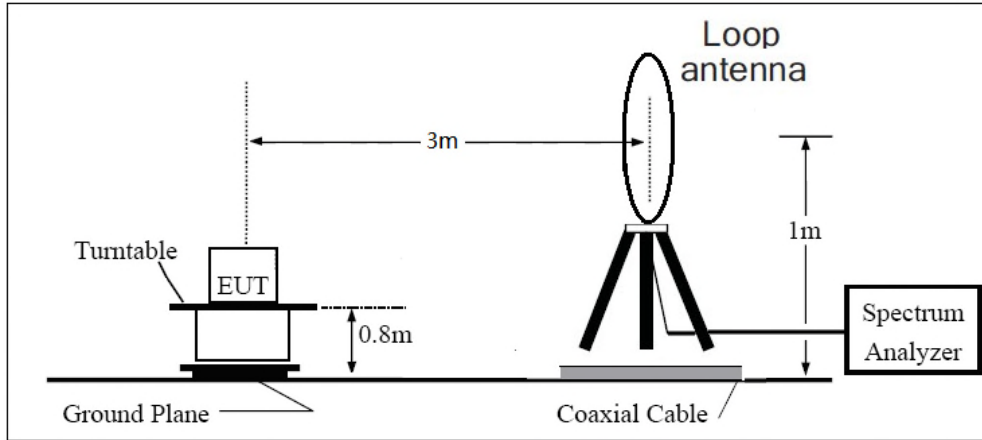

**30MHz~ 1GHz**

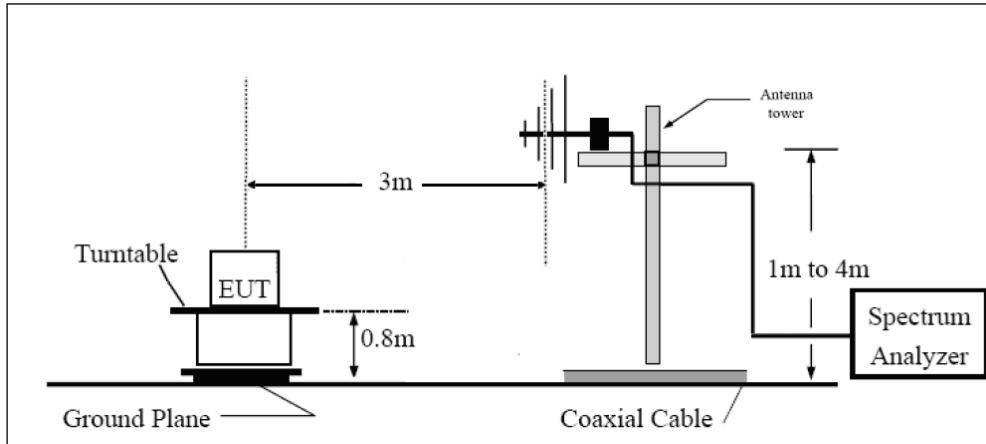

**Above 1GHz**

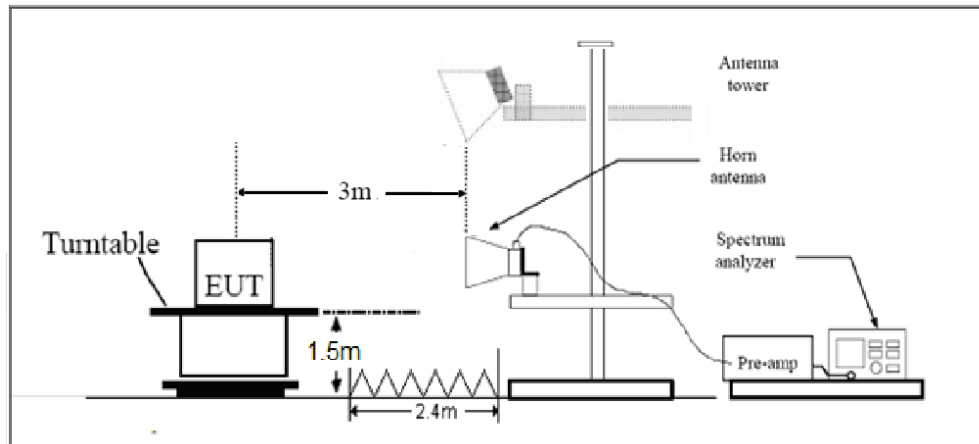

Note: Area side:2.4mX3.6m

### Limits

LTE -4 Rule Part 27.53(h) specifies that “for operations in the 1695-1710 MHz, 1710-1755 MHz, 1755-1780 MHz, 1915-1920 MHz, 1995-2000 MHz, 2000-2020 MHz, 2110-2155 MHz, 2155-2180 MHz, and 2180-2200 bands, the power of any emission outside a licensee's frequency block shall be attenuated below the transmitter power (P) in watts by at least  $43 + 10 \log_{10} (P)$  dB.”

LTE -12 Rule Part 27.53 (g) For operations in the 600 MHz band and the 698-746 MHz band, the power of any emission outside a licensee's frequency band(s) of operation shall be attenuated below the transmitter power (P) within the licensed band(s) of operation, measured in watts, by at least  $43 + 10 \log (P)$  dB. Compliance with this provision is based on the use of measurement instrumentation employing a resolution bandwidth of 100 kilohertz or greater. However, in the 100 kilohertz bands immediately outside and adjacent to a licensee's frequency block, a resolution bandwidth of at least 30 kHz may be employed.

LTE -13 Rule Part 27.53(f) For operations in the 746-758 MHz, 775-788 MHz, and 805-806 MHz bands, emissions in the band 1559-1610 MHz shall be limited to  $-70$  dBW/MHz equivalent isotropically radiated power (EIRP) for wideband signals, and  $-80$  dBW EIRP for discrete emissions of less than 700 Hz bandwidth. For the purpose of equipment authorization, a transmitter shall be tested with an antenna that is representative of the type that will be used with the equipment in normal operation.

Part 27.53/(h)/(g)Limit		-13 dBm
Part 27.53(f) Limit	Limit out of the band 1559-1610 MHz	-13 dBm
	Limit in the band 1559-1610 MHz	-40 dBm

### Measurement Uncertainty

The assessed measurement uncertainty to ensure 95% confidence level for the normal distribution is with the coverage factor  $k = \pm 1.96$ ,  $U = \pm 3.55$  dB.

**Test Result**

LTE Band 4 QPSK 1.4MHz CH-Low, RB 1

Harmonic	Frequency (MHz)	SG (dBm)	Cable Loss (dB)	Gain (dBi)	Antenna Polarization	ERP Level (dBm)	Limit (dBm)	Margin (dB)	Azimuth (deg)
2	3421.4	-56.35	2.6	10.15	Vertical	-48.8	-13	35.8	45
3	5132.1	-51.85	2.4	11.35	Vertical	-42.9	-13	29.9	0
4	6842.8	-49.65	4.5	10.85	Vertical	-43.3	-13	30.3	135
5	8553.5	-47.15	5.1	11.35	Vertical	-40.9	-13	27.9	225
6	10264.2	-45.55	5.3	11.95	Vertical	-38.9	-13	25.9	135
7	11974.9	-45.85	5.5	13.55	Vertical	-37.8	-13	24.8	45
8	13685.6	-42.85	6.3	13.75	Vertical	-35.4	-13	22.4	90
9	15396.3	-43.35	6.7	13.85	Vertical	-36.2	-13	23.2	225
10	17107.0	-43.05	6.8	14.25	Vertical	-35.6	-13	22.6	45

Note: 1.The other Spurious RF Radiated emissions level is no more than noise floor.

2. The worst emission was found in the antenna is vertical position.

LTE Band 4 QPSK 1.4MHz CH-Middle, RB 1

Harmonic	Frequency (MHz)	SG (dBm)	Cable Loss (dB)	Gain (dBi)	Antenna Polarization	ERP Level (dBm)	Limit (dBm)	Margin (dB)	Azimuth (deg)
2	3465.0	-54.85	2.6	10.75	Vertical	-46.7	-13	33.7	135
3	5197.5	-49.65	2.4	11.05	Vertical	-41.0	-13	28.0	45
4	6930.0	-49.45	4.5	11.15	Vertical	-42.8	-13	29.8	90
5	8662.5	-48.55	5.1	11.35	Vertical	-42.3	-13	29.3	225
6	10395.0	-44.35	5.3	11.95	Vertical	-37.7	-13	24.7	45
7	12127.5	-45.95	5.5	13.55	Vertical	-37.9	-13	24.9	90
8	13860.0	-41.75	6.3	13.75	Vertical	-34.3	-13	21.3	135
9	15592.5	-45.65	6.7	13.85	Vertical	-38.5	-13	25.5	135
10	17325.0	-41.95	6.8	14.25	Vertical	-34.5	-13	21.5	90

Note: 1.The other Spurious RF Radiated emissions level is no more than noise floor.

2. The worst emission was found in the antenna is vertical position.



## LTE Band 4 QPSK 1.4MHz CH-High, RB 1

Harmonic	Frequency (MHz)	SG (dBm)	Cable Loss (dB)	Gain (dBi)	Antenna Polarization	ERP Level (dBm)	Limit (dBm)	Margin (dB)	Azimuth (deg)
2	3508.6	-53.15	2.6	10.15	Vertical	-45.6	-13	32.6	45
3	5262.9	-56.65	2.4	11.05	Vertical	-48.0	-13	35.0	45
4	7017.2	-49.75	4.5	11.15	Vertical	-43.1	-13	30.1	135
5	8771.5	-47.05	5.1	11.35	Vertical	-40.8	-13	27.8	45
6	10525.8	-45.05	5.3	11.95	Vertical	-38.4	-13	25.4	90
7	12280.1	-45.25	5.5	13.55	Vertical	-37.2	-13	24.2	135
8	14034.4	-42.15	6.3	13.75	Vertical	-34.7	-13	21.7	45
9	15788.7	-44.55	6.7	13.85	Vertical	-37.4	-13	24.4	90
10	17543.0	-42.45	6.8	14.25	Vertical	-35.0	-13	22.0	225

Note: 1. The other Spurious RF Radiated emissions level is no more than noise floor.

2. The worst emission was found in the antenna is vertical position.

## LTE Band 4 QPSK 3MHz CH-Low, RB 1

Harmonic	Frequency (MHz)	SG (dBm)	Cable Loss (dB)	Gain (dBi)	Antenna Polarization	ERP Level (dBm)	Limit (dBm)	Margin (dB)	Azimuth (deg)
2	3423.0	-59.35	2.6	10.15	Vertical	-51.8	-13	38.8	180
3	5134.5	-47.45	2.4	11.35	Vertical	-38.5	-13	25.5	225
4	6846.0	-50.65	4.5	10.85	Vertical	-44.3	-13	31.3	135
5	8557.5	-48.45	5.1	11.35	Vertical	-42.2	-13	29.2	225
6	10269.0	-45.35	5.3	11.95	Vertical	-38.7	-13	25.7	90
7	11980.5	-46.15	5.5	13.55	Vertical	-38.1	-13	25.1	90
8	13692.0	-42.65	6.3	13.75	Vertical	-35.2	-13	22.2	45
9	15403.5	-45.35	6.7	13.85	Vertical	-38.2	-13	25.2	180
10	17115.0	-43.05	6.8	14.25	Vertical	-35.6	-13	22.6	45

Note: 1. The other Spurious RF Radiated emissions level is no more than noise floor.

2. The worst emission was found in the antenna is vertical position.



## LTE Band 4 QPSK 3MHz CH-Middle, RB 1

Harmonic	Frequency (MHz)	SG (dBm)	Cable Loss (dB)	Gain (dBi)	Antenna Polarization	ERP Level (dBm)	Limit (dBm)	Margin (dB)	Azimuth (deg)
2	3465.0	-54.25	2.6	10.75	Vertical	-46.1	-13	33.1	0
3	5197.5	-48.95	2.4	11.05	Vertical	-40.3	-13	27.3	135
4	6930.0	-48.75	4.5	11.15	Vertical	-42.1	-13	29.1	225
5	8662.5	-46.55	5.1	11.35	Vertical	-40.3	-13	27.3	315
6	10395.0	-45.25	5.3	11.95	Vertical	-38.6	-13	25.6	270
7	12127.5	-44.75	5.5	13.55	Vertical	-36.7	-13	23.7	225
8	13860.0	-41.95	6.3	13.75	Vertical	-34.5	-13	21.5	135
9	15592.5	-44.95	6.7	13.85	Vertical	-37.8	-13	24.8	225
10	17325.0	-41.65	6.8	14.25	Vertical	-34.2	-13	21.2	0

Note: 1. The other Spurious RF Radiated emissions level is no more than noise floor.

2. The worst emission was found in the antenna is vertical position.

## LTE Band 4 QPSK 3MHz CH-High, RB 1

Harmonic	Frequency (MHz)	SG (dBm)	Cable Loss (dB)	Gain (dBi)	Antenna Polarization	ERP Level (dBm)	Limit (dBm)	Margin (dB)	Azimuth (deg)
2	3507.0	-54.85	2.6	10.15	Vertical	-47.3	-13	34.3	135
3	5260.5	-47.15	2.4	11.05	Vertical	-38.5	-13	25.5	225
4	7014.0	-50.25	4.5	11.15	Vertical	-43.6	-13	30.6	315
5	8767.5	-45.95	5.1	11.35	Vertical	-39.7	-13	26.7	270
6	10521.0	-44.35	5.3	11.95	Vertical	-37.7	-13	24.7	225
7	12274.5	-46.55	5.5	13.55	Vertical	-38.5	-13	25.5	135
8	14028.0	-42.35	6.3	13.75	Vertical	-34.9	-13	21.9	225
9	15781.5	-44.75	6.7	13.85	Vertical	-37.6	-13	24.6	90
10	17535.0	-42.15	6.8	14.25	Vertical	-34.7	-13	21.7	90

Note: 1. The other Spurious RF Radiated emissions level is no more than noise floor.

2. The worst emission was found in the antenna is vertical position.



## LTE Band 4 QPSK 5MHz CH-Low, RB 1

Harmonic	Frequency (MHz)	SG (dBm)	Cable Loss (dB)	Gain (dBi)	Antenna Polarization	ERP Level (dBm)	Limit (dBm)	Margin (dB)	Azimuth (deg)
2	3425.0	-57.85	2.6	10.15	Vertical	-50.3	-13	37.3	45
3	5137.5	-57.75	2.4	11.35	Vertical	-48.8	-13	35.8	180
4	6850.0	-47.95	4.5	10.85	Vertical	-41.6	-13	28.6	225
5	8562.5	-47.05	5.1	11.35	Vertical	-40.8	-13	27.8	135
6	10275.0	-45.15	5.3	11.95	Vertical	-38.5	-13	25.5	225
7	11987.5	-45.65	5.5	13.55	Vertical	-37.6	-13	24.6	90
8	13700.0	-44.75	6.3	13.75	Vertical	-37.3	-13	24.3	90
9	15412.5	-45.25	6.7	13.85	Vertical	-38.1	-13	25.1	45
10	17125.0	-42.75	6.8	14.25	Vertical	-35.3	-13	22.3	180

Note: 1. The other Spurious RF Radiated emissions level is no more than noise floor.

2. The worst emission was found in the antenna is vertical position.

## LTE Band 4 QPSK 5MHz CH-Middle, RB 1

Harmonic	Frequency (MHz)	SG (dBm)	Cable Loss (dB)	Gain (dBi)	Antenna Polarization	ERP Level (dBm)	Limit (dBm)	Margin (dB)	Azimuth (deg)
2	3465.0	-55.05	2.6	10.75	Vertical	-46.9	-13	33.9	45
3	5197.5	-57.45	2.4	11.05	Vertical	-48.8	-13	35.8	0
4	6930.0	-49.45	4.5	11.15	Vertical	-42.8	-13	29.8	135
5	8662.5	-48.65	5.1	11.35	Vertical	-42.4	-13	29.4	225
6	10395.0	-44.75	5.3	11.95	Vertical	-38.1	-13	25.1	315
7	12127.5	-47.25	5.5	13.55	Vertical	-39.2	-13	26.2	270
8	13860.0	-41.65	6.3	13.75	Vertical	-34.2	-13	21.2	225
9	15592.5	-44.35	6.7	13.85	Vertical	-37.2	-13	24.2	135
10	17325.0	-41.35	6.8	14.25	Vertical	-33.9	-13	20.9	225

Note: 1. The other Spurious RF Radiated emissions level is no more than noise floor.

2. The worst emission was found in the antenna is vertical position.



## LTE Band 4 QPSK 5MHz CH-High, RB 1

Harmonic	Frequency (MHz)	SG (dBm)	Cable Loss (dB)	Gain (dBi)	Antenna Polarization	ERP Level (dBm)	Limit (dBm)	Margin (dB)	Azimuth (deg)
2	3505.0	-53.65	2.6	10.15	Vertical	-46.1	-13	33.1	0
3	5257.5	-56.95	2.4	11.05	Vertical	-48.3	-13	35.3	135
4	7010.0	-49.75	4.5	11.15	Vertical	-43.1	-13	30.1	225
5	8762.5	-46.85	5.1	11.35	Vertical	-40.6	-13	27.6	315
6	10515.0	-44.75	5.3	11.95	Vertical	-38.1	-13	25.1	270
7	12267.5	-46.55	5.5	13.55	Vertical	-38.5	-13	25.5	225
8	14020.0	-41.35	6.3	13.75	Vertical	-33.9	-13	20.9	135
9	15772.5	-44.15	6.7	13.85	Vertical	-37.0	-13	24.0	225
10	17525.0	-43.85	6.8	14.25	Vertical	-36.4	-13	23.4	90

Note: 1. The other Spurious RF Radiated emissions level is no more than noise floor.

2. The worst emission was found in the antenna is vertical position.

## LTE Band 4 QPSK 10MHz CH-Low, RB 1

Harmonic	Frequency (MHz)	SG (dBm)	Cable Loss (dB)	Gain (dBi)	Antenna Polarization	ERP Level (dBm)	Limit (dBm)	Margin (dB)	Azimuth (deg)
2	3430.0	-56.15	2.6	10.15	Vertical	-48.6	-13	35.6	90
3	5145.0	-51.65	2.4	11.35	Vertical	-42.7	-13	29.7	45
4	6860.0	-49.25	4.5	10.85	Vertical	-42.9	-13	29.9	180
5	8575.0	-46.95	5.1	11.35	Vertical	-40.7	-13	27.7	225
6	10290.0	-44.55	5.3	11.95	Vertical	-37.9	-13	24.9	135
7	12005.0	-44.45	5.5	13.55	Vertical	-36.4	-13	23.4	225
8	13720.0	-43.15	6.3	13.75	Vertical	-35.7	-13	22.7	90
9	15435.0	-44.65	6.7	13.85	Vertical	-37.5	-13	24.5	90
10	17150.0	-42.65	6.8	14.25	Vertical	-35.2	-13	22.2	45

Note: 1. The other Spurious RF Radiated emissions level is no more than noise floor.

2. The worst emission was found in the antenna is vertical position.





## LTE Band 4 QPSK 10MHz CH-Middle, RB 1

Harmonic	Frequency (MHz)	SG (dBm)	Cable Loss (dB)	Gain (dBi)	Antenna Polarization	ERP Level (dBm)	Limit (dBm)	Margin (dB)	Azimuth (deg)
2	3465.0	-54.95	2.6	10.75	Vertical	-46.8	-13	33.8	180
3	5197.5	-57.25	2.4	11.05	Vertical	-48.6	-13	35.6	45
4	6930.0	-50.05	4.5	11.15	Vertical	-43.4	-13	30.4	0
5	8662.5	-46.35	5.1	11.35	Vertical	-40.1	-13	27.1	135
6	10395.0	-44.85	5.3	11.95	Vertical	-38.2	-13	25.2	225
7	12127.5	-45.55	5.5	13.55	Vertical	-37.5	-13	24.5	315
8	13860.0	-42.45	6.3	13.75	Vertical	-35.0	-13	22.0	270
9	15592.5	-43.85	6.7	13.85	Vertical	-36.7	-13	23.7	225
10	17325.0	-41.45	6.8	14.25	Vertical	-34.0	-13	21.0	135

Note: 1. The other Spurious RF Radiated emissions level is no more than noise floor.

2. The worst emission was found in the antenna is vertical position.

## LTE Band 4 QPSK 10MHz CH-High, RB 1

Harmonic	Frequency (MHz)	SG (dBm)	Cable Loss (dB)	Gain (dBi)	Antenna Polarization	ERP Level (dBm)	Limit (dBm)	Margin (dB)	Azimuth (deg)
2	3500.0	-53.65	2.6	10.15	Vertical	-46.1	-13	33.1	225
3	5250.0	-57.35	2.4	11.05	Vertical	-48.7	-13	35.7	315
4	7000.0	-49.95	4.5	11.15	Vertical	-43.3	-13	30.3	270
5	8750.0	-47.15	5.1	11.35	Vertical	-40.9	-13	27.9	225
6	10500.0	-44.35	5.3	11.95	Vertical	-37.7	-13	24.7	135
7	12250.0	-45.65	5.5	13.55	Vertical	-37.6	-13	24.6	225
8	14000.0	-42.15	6.3	13.75	Vertical	-34.7	-13	21.7	315
9	15750.0	-44.75	6.7	13.85	Vertical	-37.6	-13	24.6	270
10	17500.0	-42.45	6.8	14.25	Vertical	-35.0	-13	22.0	225

Note: 1. The other Spurious RF Radiated emissions level is no more than noise floor.

2. The worst emission was found in the antenna is vertical position.



## LTE Band 4 QPSK 15MHz CH Low, RB 1

Harmonic	Frequency (MHz)	SG (dBm)	Cable Loss (dB)	Gain (dBi)	Antenna Polarization	ERP Level (dBm)	Limit (dBm)	Margin (dB)	Azimuth (deg)
2	3435.0	-58.45	2.6	10.15	Vertical	-50.9	-13	37.9	135
3	5152.5	-51.15	2.4	11.35	Vertical	-42.2	-13	29.2	225
4	6870.0	-49.45	4.5	10.85	Vertical	-43.1	-13	30.1	90
5	8587.5	-46.45	5.1	11.35	Vertical	-40.2	-13	27.2	90
6	10305.0	-46.95	5.3	11.95	Vertical	-40.3	-13	27.3	45
7	12022.5	-45.65	5.5	13.55	Vertical	-37.6	-13	24.6	180
8	13740.0	-43.75	6.3	13.75	Vertical	-36.3	-13	23.3	225
9	15457.5	-44.65	6.7	13.85	Vertical	-37.5	-13	24.5	135
10	17175.0	-41.65	6.8	14.25	Vertical	-34.2	-13	21.2	225

Note: 1. The other Spurious RF Radiated emissions level is no more than noise floor.

2. The worst emission was found in the antenna is vertical position.

## LTE Band 4 QPSK 15MHz CH-Middle, RB 1

Harmonic	Frequency (MHz)	SG (dBm)	Cable Loss (dB)	Gain (dBi)	Antenna Polarization	ERP Level (dBm)	Limit (dBm)	Margin (dB)	Azimuth (deg)
2	3465.0	-55.85	2.6	10.75	Vertical	-47.7	-13	34.7	90
3	5197.5	-57.45	2.4	11.05	Vertical	-48.8	-13	35.8	90
4	6930.0	-50.45	4.5	11.15	Vertical	-43.8	-13	30.8	45
5	8662.5	-47.85	5.1	11.35	Vertical	-41.6	-13	28.6	180
6	10395.0	-43.95	5.3	11.95	Vertical	-37.3	-13	24.3	270
7	12127.5	-45.75	5.5	13.55	Vertical	-37.7	-13	24.7	225
8	13860.0	-41.75	6.3	13.75	Vertical	-34.3	-13	21.3	135
9	15592.5	-45.65	6.7	13.85	Vertical	-38.5	-13	25.5	225
10	17325.0	-42.05	6.8	14.25	Vertical	-34.6	-13	21.6	315

Note: 1. The other Spurious RF Radiated emissions level is no more than noise floor.

2. The worst emission was found in the antenna is vertical position.



## LTE Band 4 QPSK 15MHz CH-High, RB 1

Harmonic	Frequency (MHz)	SG (dBm)	Cable Loss (dB)	Gain (dBi)	Antenna Polarization	ERP Level (dBm)	Limit (dBm)	Margin (dB)	Azimuth (deg)
2	3495.0	-53.55	2.6	10.15	Vertical	-46.0	-13	33.0	270
3	5242.5	-57.65	2.4	11.05	Vertical	-49.0	-13	36.0	225
4	6990.0	-49.85	4.5	11.15	Vertical	-43.2	-13	30.2	135
5	8737.5	-47.05	5.1	11.35	Vertical	-40.8	-13	27.8	225
6	10485.0	-44.25	5.3	11.95	Vertical	-37.6	-13	24.6	90
7	12232.5	-45.25	5.5	13.55	Vertical	-37.2	-13	24.2	45
8	13980.0	-41.05	6.3	13.75	Vertical	-33.6	-13	20.6	180
9	15727.5	-46.15	6.7	13.85	Vertical	-39.0	-13	26.0	45
10	17475.0	-42.65	6.8	14.25	Vertical	-35.2	-13	22.2	0

Note: 1. The other Spurious RF Radiated emissions level is no more than noise floor.

2. The worst emission was found in the antenna is vertical position.

## LTE Band 4 QPSK 20MHz CH-Low, RB 1

Harmonic	Frequency (MHz)	SG (dBm)	Cable Loss (dB)	Gain (dBi)	Antenna Polarization	ERP Level (dBm)	Limit (dBm)	Margin (dB)	Azimuth (deg)
2	3440.0	-59.05	2.6	10.15	Vertical	-51.5	-13	38.5	135
3	5160.0	-58.15	2.4	11.35	Vertical	-49.2	-13	36.2	225
4	6880.0	-51.25	4.5	10.85	Vertical	-44.9	-13	31.9	315
5	8600.0	-47.05	5.1	11.35	Vertical	-40.8	-13	27.8	270
6	10320.0	-45.95	5.3	11.95	Vertical	-39.3	-13	26.3	225
7	12040.0	-47.75	5.5	13.55	Vertical	-39.7	-13	26.7	135
8	13760.0	-41.95	6.3	13.75	Vertical	-34.5	-13	21.5	225
9	15480.0	-47.05	6.7	13.85	Vertical	-39.9	-13	26.9	135
10	17200.0	-44.75	6.8	14.25	Vertical	-37.3	-13	24.3	225

Note: 1. The other Spurious RF Radiated emissions level is no more than noise floor.

2. The worst emission was found in the antenna is vertical position.



## LTE Band 4 QPSK 20MHz CH-Middle, RB 1

Harmonic	Frequency (MHz)	SG (dBm)	Cable Loss (dB)	Gain (dBi)	Antenna Polarization	ERP Level (dBm)	Limit (dBm)	Margin (dB)	Azimuth (deg)
2	3465.0	-58.95	2.6	10.75	Vertical	-50.8	-13	37.8	315
3	5197.5	-52.75	2.4	11.05	Vertical	-44.1	-13	31.1	270
4	6930.0	-50.15	4.5	11.15	Vertical	-43.5	-13	30.5	225
5	8662.5	-46.55	5.1	11.35	Vertical	-40.3	-13	27.3	135
6	10395.0	-45.25	5.3	11.95	Vertical	-38.6	-13	25.6	225
7	12127.5	-44.95	5.5	13.55	Vertical	-36.9	-13	23.9	90
8	13860.0	-42.45	6.3	13.75	Vertical	-35.0	-13	22.0	90
9	15592.5	-44.95	6.7	13.85	Vertical	-37.8	-13	24.8	45
10	17325.0	-42.85	6.8	14.25	Vertical	-35.4	-13	22.4	180

Note: 1. The other Spurious RF Radiated emissions level is no more than noise floor.

2. The worst emission was found in the antenna is vertical position.

## LTE Band 4 QPSK 20MHz CH-High, RB 1

Harmonic	Frequency (MHz)	SG (dBm)	Cable Loss (dB)	Gain (dBi)	Antenna Polarization	ERP Level (dBm)	Limit (dBm)	Margin (dB)	Azimuth (deg)
2	3490.0	-54.35	2.6	10.15	Vertical	-46.8	-13	33.8	225
3	5235.0	-48.85	2.4	11.05	Vertical	-40.2	-13	27.2	135
4	6980.0	-49.55	4.5	11.15	Vertical	-42.9	-13	29.9	225
5	8725.0	-47.05	5.1	11.35	Vertical	-40.8	-13	27.8	90
6	10470.0	-45.35	5.3	11.95	Vertical	-38.7	-13	25.7	90
7	12215.0	-45.65	5.5	13.55	Vertical	-37.6	-13	24.6	45
8	13960.0	-44.45	6.3	13.75	Vertical	-37.0	-13	24.0	180
9	15705.0	-45.25	6.7	13.85	Vertical	-38.1	-13	25.1	45
10	17450.0	-43.65	6.8	14.25	Vertical	-36.2	-13	23.2	45

Note: 1. The other Spurious RF Radiated emissions level is no more than noise floor.

2. The worst emission was found in the antenna is vertical position.



## LTE Band 12 QPSK 1.4MHz CH-Low, RB 1

Harmonic	Frequency (MHz)	SG (dBm)	Cable Loss (dB)	Gain (dBi)	Antenna Polarization	ERP Level (dBm)	Limit (dBm)	Margin (dB)	Azimuth (deg)
2	1399.40	-52.45	2.00	10.15	Vertical	-44.3	-13	31.3	225
3	2099.10	-58.65	2.50	11.35	Vertical	-49.8	-13	36.8	315
4	2798.80	-56.15	4.20	10.85	Vertical	-49.5	-13	36.5	135
5	3498.50	-56.05	5.20	11.35	Vertical	-49.9	-13	36.9	225
6	4198.20	-54.55	5.50	11.95	Vertical	-48.1	-13	35.1	90
7	4897.90	-52.95	5.70	13.55	Vertical	-45.1	-13	32.1	135
8	5597.60	-52.05	6.30	13.75	Vertical	-44.6	-13	31.6	45
9	6297.30	-50.55	6.80	13.85	Vertical	-43.5	-13	30.5	225
10	6997.00	-49.05	6.90	14.25	Vertical	-41.7	-13	28.7	135

Note: 1.The other Spurious RF Radiated emissions level is no more than noise floor.

2. The worst emission was found in the antenna is vertical position.

## LTE Band 12 QPSK 1.4MHz CH-Middle, RB 1

Harmonic	Frequency (MHz)	SG (dBm)	Cable Loss (dB)	Gain (dBi)	Antenna Polarization	ERP Level (dBm)	Limit (dBm)	Margin (dB)	Azimuth (deg)
2	1415.00	-57.75	2.00	10.75	Vertical	-49.0	-13	36.0	45
3	2122.50	-59.04	2.51	11.05	Vertical	-50.5	-13	37.5	90
4	2830.00	-56.45	4.20	11.15	Vertical	-49.5	-13	36.5	225
5	3537.50	-56.45	5.20	11.15	Vertical	-50.5	-13	37.5	45
6	4245.00	-54.55	5.50	11.95	Vertical	-48.1	-13	35.1	135
7	4952.50	-52.15	5.70	13.55	Vertical	-44.3	-13	31.3	135
8	5660.00	-52.65	6.30	13.75	Vertical	-45.2	-13	32.2	225
9	6367.50	-50.25	6.80	13.85	Vertical	-43.2	-13	30.2	90
10	7075.00	-49.35	6.90	14.25	Vertical	-42.0	-13	29.0	90

Note: 1.The other Spurious RF Radiated emissions level is no more than noise floor.

2. The worst emission was found in the antenna is vertical position.

**LTE Band 12 QPSK 1.4MHz CH-High, RB 1**

Harmonic	Frequency (MHz)	SG (dBm)	Cable Loss (dB)	Gain (dBi)	Antenna Polarization	ERP Level (dBm)	Limit (dBm)	Margin (dB)	Azimuth (deg)
2	1430.60	-60.65	2.00	10.15	Vertical	-52.5	-13	39.5	225
3	2145.90	-56.14	2.51	11.05	Vertical	-47.6	-13	34.6	45
4	2861.20	-57.25	4.20	11.15	Vertical	-50.3	-13	37.3	90
5	3576.50	-56.05	5.20	11.15	Vertical	-50.1	-13	37.1	135
6	4291.80	-54.85	5.50	11.95	Vertical	-48.4	-13	35.4	135
7	5007.10	-52.15	5.70	13.55	Vertical	-44.3	-13	31.3	90
8	5722.40	-52.35	6.30	13.75	Vertical	-44.9	-13	31.9	135
9	6437.70	-50.55	6.80	13.85	Vertical	-43.5	-13	30.5	90
10	7153.00	-49.45	6.90	14.25	Vertical	-42.1	-13	29.1	45

Note: 1.The other Spurious RF Radiated emissions level is no more than noise floor.

2. The worst emission was found in the antenna is vertical position.

**LTE Band 12 QPSK 3MHz CH-Low, RB 1**

Harmonic	Frequency (MHz)	SG (dBm)	Cable Loss (dB)	Gain (dBi)	Antenna Polarization	ERP Level (dBm)	Limit (dBm)	Margin (dB)	Azimuth (deg)
2	1401.00	-55.95	2.00	10.15	Vertical	-47.8	-13	34.8	135
3	2101.50	-58.34	2.51	11.35	Vertical	-49.5	-13	36.5	225
4	2802.00	-56.25	4.20	10.85	Vertical	-49.6	-13	36.6	90
5	3502.50	-56.55	5.20	11.35	Vertical	-50.4	-13	37.4	90
6	4203.00	-54.85	5.50	11.95	Vertical	-48.4	-13	35.4	45
7	4903.50	-52.95	5.70	13.55	Vertical	-45.1	-13	32.1	180
8	5604.00	-52.85	6.30	13.75	Vertical	-45.4	-13	32.4	225
9	6304.50	-50.35	6.80	13.85	Vertical	-43.3	-13	30.3	135
10	7005.00	-49.15	6.90	14.25	Vertical	-41.8	-13	28.8	225

Note: 1.The other Spurious RF Radiated emissions level is no more than noise floor.

2. The worst emission was found in the antenna is vertical position.

**LTE Band 12 QPSK 3MHz CH-Middle, RB 1**

Harmonic	Frequency (MHz)	SG (dBm)	Cable Loss (dB)	Gain (dBi)	Antenna Polarization	ERP Level (dBm)	Limit (dBm)	Margin (dB)	Azimuth (deg)
2	1415.00	-57.85	2.00	10.75	Vertical	-49.1	-13	36.1	90
3	2122.50	-58.64	2.51	11.05	Vertical	-50.1	-13	37.1	90
4	2830.00	-57.35	4.20	11.15	Vertical	-50.4	-13	37.4	45
5	3537.50	-56.35	5.20	11.15	Vertical	-50.4	-13	37.4	180
6	4245.00	-55.15	5.50	11.95	Vertical	-48.7	-13	35.7	45
7	4952.50	-52.35	5.70	13.55	Vertical	-44.5	-13	31.5	0
8	5660.00	-52.55	6.30	13.75	Vertical	-45.1	-13	32.1	135
9	6367.50	-50.95	6.80	13.85	Vertical	-43.9	-13	30.9	225
10	7075.00	-48.75	6.90	14.25	Vertical	-41.4	-13	28.4	90

- Note: 1.The other Spurious RF Radiated emissions level is no more than noise floor.  
 2. The worst emission was found in the antenna is vertical position.

**LTE Band 12 QPSK 3MHz CH-High, RB 1**

Harmonic	Frequency (MHz)	SG (dBm)	Cable Loss (dB)	Gain (dBi)	Antenna Polarization	ERP Level (dBm)	Limit (dBm)	Margin (dB)	Azimuth (deg)
2	1429.00	-59.25	2.00	10.15	Vertical	-51.1	-13	38.1	45
3	2143.50	-57.24	2.51	11.05	Vertical	-48.7	-13	35.7	180
4	2858.00	-57.05	4.20	11.15	Vertical	-50.1	-13	37.1	225
5	3572.50	-55.85	5.20	11.15	Vertical	-49.9	-13	36.9	135
6	4287.00	-54.75	5.50	11.95	Vertical	-48.3	-13	35.3	225
7	5001.50	-52.55	5.70	13.55	Vertical	-44.7	-13	31.7	90
8	5716.00	-51.95	6.30	13.75	Vertical	-44.5	-13	31.5	90
9	6430.50	-50.45	6.80	13.85	Vertical	-43.4	-13	30.4	45
10	7145.00	-49.05	6.90	14.25	Vertical	-41.7	-13	28.7	180

- Note: 1.The other Spurious RF Radiated emissions level is no more than noise floor.  
 2. The worst emission was found in the antenna is vertical position.



## LTE Band 12 QPSK 5MHz CH-Low, RB 1

Harmonic	Frequency (MHz)	SG (dBm)	Cable Loss (dB)	Gain (dBi)	Antenna Polarization	ERP Level (dBm)	Limit (dBm)	Margin (dB)	Azimuth (deg)
2	1403.00	-51.85	2.00	10.15	Vertical	-43.7	-13	30.7	45
3	2104.50	-59.15	2.50	11.35	Vertical	-50.3	-13	37.3	0
4	2806.00	-56.85	4.20	10.85	Vertical	-50.2	-13	37.2	135
5	3507.50	-56.45	5.20	11.35	Vertical	-50.3	-13	37.3	45
6	4209.00	-55.35	5.50	11.95	Vertical	-48.9	-13	35.9	90
7	4910.50	-52.15	5.70	13.55	Vertical	-44.3	-13	31.3	45
8	5612.00	-52.55	6.30	13.75	Vertical	-45.1	-13	32.1	180
9	6313.50	-50.65	6.80	13.85	Vertical	-43.6	-13	30.6	315
10	7015.00	-49.05	6.90	14.25	Vertical	-41.7	-13	28.7	135

Note: 1.The other Spurious RF Radiated emissions level is no more than noise floor.

2. The worst emission was found in the antenna is vertical position.

## LTE Band 12 QPSK 5MHz CH-Middle, RB 1

Harmonic	Frequency (MHz)	SG (dBm)	Cable Loss (dB)	Gain (dBi)	Antenna Polarization	ERP Level (dBm)	Limit (dBm)	Margin (dB)	Azimuth (deg)
2	1415.00	-57.15	2.00	10.75	Vertical	-48.4	-13	35.4	225
3	2122.50	-58.24	2.51	11.05	Vertical	-49.7	-13	36.7	90
4	2830.00	-56.25	4.20	11.15	Vertical	-49.3	-13	36.3	180
5	3537.50	-55.75	5.20	11.15	Vertical	-49.8	-13	36.8	45
6	4245.00	-55.35	5.50	11.95	Vertical	-48.9	-13	35.9	180
7	4952.50	-52.25	5.70	13.55	Vertical	-44.4	-13	31.4	45
8	5660.00	-52.65	6.30	13.75	Vertical	-45.2	-13	32.2	0
9	6367.50	-50.25	6.80	13.85	Vertical	-43.2	-13	30.2	135
10	7075.00	-49.05	6.90	14.25	Vertical	-41.7	-13	28.7	225

Note: 1.The other Spurious RF Radiated emissions level is no more than noise floor.

2. The worst emission was found in the antenna is vertical position.



**LTE Band 12 QPSK 5MHz CH-High, RB 1**

Harmonic	Frequency (MHz)	SG (dBm)	Cable Loss (dB)	Gain (dBi)	Antenna Polarization	ERP Level (dBm)	Limit (dBm)	Margin (dB)	Azimuth (deg)
2	1427.00	-57.85	2.00	10.15	Vertical	-49.7	-13	36.7	90
3	2140.50	-57.34	2.51	11.05	Vertical	-48.8	-13	35.8	225
4	2854.00	-55.65	4.20	11.15	Vertical	-48.7	-13	35.7	180
5	3567.50	-56.15	5.20	11.15	Vertical	-50.2	-13	37.2	270
6	4281.00	-54.55	5.50	11.95	Vertical	-48.1	-13	35.1	135
7	4994.50	-52.95	5.70	13.55	Vertical	-45.1	-13	32.1	225
8	5708.00	-52.35	6.30	13.75	Vertical	-44.9	-13	31.9	135
9	6421.50	-50.65	6.80	13.85	Vertical	-43.6	-13	30.6	90
10	7135.00	-49.15	6.90	14.25	Vertical	-41.8	-13	28.8	45

Note: 1.The other Spurious RF Radiated emissions level is no more than noise floor.

2. The worst emission was found in the antenna is vertical position.

**LTE Band 12 QPSK 10MHz CH-Low, RB 1**

Harmonic	Frequency (MHz)	SG (dBm)	Cable Loss (dB)	Gain (dBi)	Antenna Polarization	ERP Level (dBm)	Limit (dBm)	Margin (dB)	Azimuth (deg)
2	1408.00	-52.25	2.00	10.15	Vertical	-44.1	-13	31.1	180
3	2112.00	-58.94	2.51	11.35	Vertical	-50.1	-13	37.1	45
4	2816.00	-57.05	4.20	10.85	Vertical	-50.4	-13	37.4	0
5	3520.00	-55.75	5.20	11.35	Vertical	-49.6	-13	36.6	135
6	4224.00	-54.35	5.50	11.95	Vertical	-47.9	-13	34.9	225
7	4928.00	-53.95	5.70	13.55	Vertical	-46.1	-13	33.1	90
8	5632.00	-52.55	6.30	13.75	Vertical	-45.1	-13	32.1	45
9	6336.00	-51.55	6.80	13.85	Vertical	-44.5	-13	31.5	180
10	7040.00	-48.55	6.90	14.25	Vertical	-41.2	-13	28.2	225

Note: 1.The other Spurious RF Radiated emissions level is no more than noise floor.

2. The worst emission was found in the antenna is vertical position.



## LTE Band 12 QPSK 10MHz CH-Middle, RB 1

Harmonic	Frequency (MHz)	SG (dBm)	Cable Loss (dB)	Gain (dBi)	Antenna Polarization	ERP Level (dBm)	Limit (dBm)	Margin (dB)	Azimuth (deg)
2	1415.00	-56.35	2.00	10.75	Vertical	-47.6	-13	34.6	135
3	2122.50	-57.84	2.51	11.05	Vertical	-49.3	-13	36.3	225
4	2830.00	-57.65	4.20	11.15	Vertical	-50.7	-13	37.7	90
5	3537.50	-55.25	5.20	11.15	Vertical	-49.3	-13	36.3	90
6	4245.00	-53.35	5.50	11.95	Vertical	-46.9	-13	33.9	45
7	4952.50	-54.25	5.70	13.55	Vertical	-46.4	-13	33.4	180
8	5660.00	-52.95	6.30	13.75	Vertical	-45.5	-13	32.5	45
9	6367.50	-50.55	6.80	13.85	Vertical	-43.5	-13	30.5	0
10	7075.00	-49.15	6.90	14.25	Vertical	-41.8	-13	28.8	135

Note: 1.The other Spurious RF Radiated emissions level is no more than noise floor.

2. The worst emission was found in the antenna is vertical position.

## LTE Band 12 QPSK 10MHz CH-High, RB 1

Harmonic	Frequency (MHz)	SG (dBm)	Cable Loss (dB)	Gain (dBi)	Antenna Polarization	ERP Level (dBm)	Limit (dBm)	Margin (dB)	Azimuth (deg)
2	1422.00	-57.15	2.00	10.15	Vertical	-49.0	-13	36.0	225
3	2133.00	-58.04	2.51	11.05	Vertical	-49.5	-13	36.5	90
4	2844.00	-58.55	4.20	11.15	Vertical	-51.6	-13	38.6	45
5	3555.00	-55.05	5.20	11.15	Vertical	-49.1	-13	36.1	180
6	4266.00	-53.05	5.50	11.95	Vertical	-46.6	-13	33.6	225
7	4977.00	-53.95	5.70	13.55	Vertical	-46.1	-13	33.1	135
8	5688.00	-52.55	6.30	13.75	Vertical	-45.1	-13	32.1	225
9	6399.00	-50.35	6.80	13.85	Vertical	-43.3	-13	30.3	90
10	7110.00	-48.85	6.90	14.25	Vertical	-41.5	-13	28.5	90

Note: 1.The other Spurious RF Radiated emissions level is no more than noise floor.

2. The worst emission was found in the antenna is vertical position.



## LTE Band 13 QPSK 5MHz CH-Low, RB 1

Harmonic	Frequency (MHz)	SG (dBm)	Cable Loss (dB)	Gain (dBi)	Antenna Polarization	ERP Level (dBm)	Limit (dBm)	Margin (dB)	Azimuth (deg)
2	1559.0	-61.25	2.00	10.15	Vertical	-53.1	-40	13.1	180
3	2338.5	-52.75	2.50	11.35	Vertical	-43.9	-13	30.9	270
4	3118.0	-57.45	4.20	10.85	Vertical	-50.8	-13	37.8	135
5	3897.5	-55.05	5.20	11.35	Vertical	-48.9	-13	35.9	225
6	4677.0	-53.35	5.50	11.95	Vertical	-46.9	-13	33.9	135
7	5456.5	-52.85	5.70	13.55	Vertical	-45.0	-13	32.0	90
8	6236.0	-52.35	6.30	13.75	Vertical	-44.9	-13	31.9	45
9	7015.5	-50.75	6.80	13.85	Vertical	-43.7	-13	30.7	180
10	7795.0	-48.25	6.90	14.25	Vertical	-40.9	-13	27.9	45

Note: 1. The other Spurious RF Radiated emissions level is no more than noise floor.

2. The worst emission was found in the antenna is vertical position.

## LTE Band 13 QPSK 5MHz CH-Middle, RB 1

Harmonic	Frequency (MHz)	SG (dBm)	Cable Loss (dB)	Gain (dBi)	Antenna Polarization	ERP Level (dBm)	Limit (dBm)	Margin (dB)	Azimuth (deg)
2	1564.0	-61.45	2.00	10.75	Vertical	-52.7	-40	12.7	0
3	2346.0	-52.14	2.51	11.05	Vertical	-43.6	-13	30.6	135
4	3128.0	-56.75	4.20	11.15	Vertical	-49.8	-13	36.8	225
5	3910.0	-54.35	5.20	11.15	Vertical	-48.4	-13	35.4	90
6	4692.0	-53.45	5.50	11.95	Vertical	-47.0	-13	34.0	45
7	5474.0	-52.75	5.70	13.55	Vertical	-44.9	-13	31.9	180
8	6256.0	-52.15	6.30	13.75	Vertical	-44.7	-13	31.7	45
9	7038.0	-50.45	6.80	13.85	Vertical	-43.4	-13	30.4	0
10	7820.0	-47.25	6.90	14.25	Vertical	-39.9	-13	26.9	135

Note: 1. The other Spurious RF Radiated emissions level is no more than noise floor.

2. The worst emission was found in the antenna is vertical position.



## LTE Band 13 QPSK 5MHz CH-High, RB 1

Harmonic	Frequency (MHz)	SG (dBm)	Cable Loss (dB)	Gain (dBi)	Antenna Polarization	ERP Level (dBm)	Limit (dBm)	Margin (dB)	Azimuth (deg)
2	1569.0	-62.45	2.00	10.15	Vertical	-54.3	-40	14.3	225
3	2353.5	-52.14	2.51	11.05	Vertical	-43.6	-13	30.6	315
4	3138.0	-56.15	4.20	11.15	Vertical	-49.2	-13	36.2	270
5	3922.5	-53.95	5.20	11.15	Vertical	-48.0	-13	35.0	225
6	4707.0	-53.35	5.50	11.95	Vertical	-46.9	-13	33.9	135
7	5491.5	-52.75	5.70	13.55	Vertical	-44.9	-13	31.9	225
8	6276.0	-51.85	6.30	13.75	Vertical	-44.4	-13	31.4	90
9	7060.5	-50.15	6.80	13.85	Vertical	-43.1	-13	30.1	90
10	7845.0	-47.05	6.90	14.25	Vertical	-39.7	-13	26.7	45

Note: 1.The other Spurious RF Radiated emissions level is no more than noise floor.

2. The worst emission was found in the antenna is vertical position.

## LTE Band 13 QPSK 10MHz CH-Low, RB 1

Harmonic	Frequency (MHz)	SG (dBm)	Cable Loss (dB)	Gain (dBi)	Antenna Polarization	ERP Level (dBm)	Limit (dBm)	Margin (dB)	Azimuth (deg)
2	1564.0	-62.25	2.00	10.15	Vertical	-54.1	-40	14.1	180
3	2346.0	-52.94	2.51	11.35	Vertical	-44.1	-13	31.1	225
4	3128.0	-56.15	4.20	10.85	Vertical	-49.5	-13	36.5	135
5	3910.0	-54.65	5.20	11.35	Vertical	-48.5	-13	35.5	225
6	4692.0	-54.25	5.50	11.95	Vertical	-47.8	-13	34.8	90
7	5474.0	-53.55	5.70	13.55	Vertical	-45.7	-13	32.7	90
8	6256.0	-52.25	6.30	13.75	Vertical	-44.8	-13	31.8	45
9	7038.0	-49.45	6.80	13.85	Vertical	-42.4	-13	29.4	180
10	7820.0	-48.05	6.90	14.25	Vertical	-40.7	-13	27.7	45

Note: 1.The other Spurious RF Radiated emissions level is no more than noise floor.

2. The worst emission was found in the antenna is vertical position.



## LTE Band 13 QPSK 10MHz CH-Middle, RB 1

Harmonic	Frequency (MHz)	SG (dBm)	Cable Loss (dB)	Gain (dBi)	Antenna Polarization	ERP Level (dBm)	Limit (dBm)	Margin (dB)	Azimuth (deg)
2	1564.0	-63.05	2.00	10.75	Vertical	-54.3	-40	14.3	0
3	2346.0	-52.64	2.51	11.05	Vertical	-44.1	-13	31.1	135
4	3128.0	-56.25	4.20	11.15	Vertical	-49.3	-13	36.3	225
5	3910.0	-54.75	5.20	11.15	Vertical	-48.8	-13	35.8	315
6	4692.0	-54.05	5.50	11.95	Vertical	-47.6	-13	34.6	270
7	5474.0	-53.25	5.70	13.55	Vertical	-45.4	-13	32.4	90
8	6256.0	-52.25	6.30	13.75	Vertical	-44.8	-13	31.8	45
9	7038.0	-49.75	6.80	13.85	Vertical	-42.7	-13	29.7	180
10	7820.0	-47.75	6.90	14.25	Vertical	-40.4	-13	27.4	45

Note: 1. The other Spurious RF Radiated emissions level is no more than noise floor.

2. The worst emission was found in the antenna is vertical position.

## LTE Band 13 QPSK 10MHz CH-High, RB 1

Harmonic	Frequency (MHz)	SG (dBm)	Cable Loss (dB)	Gain (dBi)	Antenna Polarization	ERP Level (dBm)	Limit (dBm)	Margin (dB)	Azimuth (deg)
2	1564.0	-62.45	2.00	10.15	Vertical	-54.3	-40	14.3	0
3	2346.0	-52.44	2.51	11.05	Vertical	-43.9	-13	30.9	135
4	3128.0	-56.65	4.20	11.15	Vertical	-49.7	-13	36.7	225
5	3910.0	-54.25	5.20	11.15	Vertical	-48.3	-13	35.3	315
6	4692.0	-53.95	5.50	11.95	Vertical	-47.5	-13	34.5	270
7	5474.0	-53.55	5.70	13.55	Vertical	-45.7	-13	32.7	225
8	6256.0	-52.05	6.30	13.75	Vertical	-44.6	-13	31.6	135
9	7038.0	-49.25	6.80	13.85	Vertical	-42.2	-13	29.2	225
10	7820.0	-48.15	6.90	14.25	Vertical	-40.8	-13	27.8	90

Note: 1. The other Spurious RF Radiated emissions level is no more than noise floor.

2. The worst emission was found in the antenna is vertical position.



## 6 Main Test Instruments

Date of Testing: June 24, 2017~ July 3, 2017

Name	Manufacturer	Type	Serial Number	Calibration Date	Expiration Time
Base Station Simulator	R&S	CMW500	150415	2017-05-14	2018-05-13
Power Splitter	Hua Xiang	SHX-GF2-2-13	10120101	2017-05-14	2018-05-13
Universal Radio Communication Tester	Agilent	E5515C	MY48367192	2017-05-14	2018-05-13
Spectrum Analyzer	Agilent	N9010A	MY47191109	2017-05-14	2018-05-13
Signal Analyzer	R&S	FSV30	100815	2016-12-16	2017-12-15
Signal generator	R&S	SMB 100A	102594	2017-05-14	2018-05-13
EMI Test Receiver	R&S	ESCI	100948	2017-05-20	2018-05-19
Trilog Antenna	SCHWARZBECK	VUBL 9163	9163-201	2014-12-06	2017-12-05
Horn Antenna	R&S	HF907	100126	2014-12-06	2017-12-05
Horn Antenna	ETS-Lindgren	3160-09	00102643	2015-01-30	2018-01-29
Climatic Chamber	Re Ce	PT-30B	20101891	2015-07-18	2018-07-17
RF Cable	Agilent	SMA 15cm	0001	2017-02-06	2017-08-05
Preampfier	R&S	SCU18	102327	2017-06-18	2018-06-17



Date of Testing: August10, 2020 ~ August12, 2020

Name	Manufacturer	Type	Serial Number	Calibration Date	Expiration Date
Base Station Simulator	R&S	CMW500	113824	2020-05-18	2021-05-17
Power Splitter	Hua Xiang	SHX-GF2-2-13	10120101	/	/
Spectrum Analyzer	Key sight	N9010A	MY50210259	2020-05-18	2021-05-17
Signal Analyzer	R&S	FSV30	100815	2019-12-15	2020-12-14
Loop Antenna	SCHWARZBECK	FMZB1519	1519-047	2017-09-26	2020-09-25
Trilog Antenna	SCHWARZBECK	VUBL 9163	9163-201	2017-11-18	2020-11-17
Horn Antenna	R&S	HF907	102723	2018-08-11	2021-08-10
Horn Antenna	ETS-Lindgren	3160-09	00102643	2018-06-20	2021-06-19
Signal generator	R&S	SMB 100A	102594	2020-05-18	2021-05-17
Climatic Chamber	ESPEC	SU-242	93000506	2017-12-17	2020-12-16
Preamplifier	R&S	SCU18	102327	2020-05-18	2021-05-17
MOB COMMS DC SUPPLY	Keysight	66319D	MY43004105	2020-05-18	2021-05-17
RF Cable	Agilent	SMA 15cm	0001	2020-06-12	2020-12-11
Software	R&S	EMC32	9.26.0	/	/



## ANNEX A: Product Change Description



# BG96 R1.1 & BG96 R1.2 Differences Statement

LTE Module Series

PCB Rev.: R1.2

Date: 2018-10-08



[www.quectel.com](http://www.quectel.com)



Build a Smarter World



Based on BG96 R1.1, BG96 R1.2 has enabled VDD\_QFPROM\_PRG hardware interface, which is connected to ground directly in BG96 R1.1, so as to support secure boot feature.

Some points are highlighted as below:

- BG96 R1.1 and R1.2 versions share the same hardware architecture and key components.
- BG96 R1.1 and R1.2 versions share the same pinout placements.
- Secure boot is enabled through a set of hardware fuses in BG96 R1.2. For the code to be executed, it must be signed by the trusted entity identified in the hardware fuses, so we have to enable VDD\_QFPROM\_PRG hardware interface.
- The new hardware will be used with the new software baseline TX3.0, and the software version is R04Axx.

The details are illustrated as below:

### 1. What's Secure Boot

Secure boot refers to the bootup sequence that establishes a trusted platform for secure applications. It starts as an immutable sequence that validates the origin of the code using cryptographic authentication so only authorized software can be executed. The bootup sequence places the device in a known security state and protects against binary manipulation of software and reflashing attacks.

A secure boot system adds cryptographic checks to each stage of the boot up process. This process asserts the authenticity of all secure software images that are executed by the device. This additional check prevents any unauthorized or maliciously modified software from running on the device. Secure boot is enabled through a set of hardware fuses. For the code to be executed, it must be signed by the trusted entity identified in the hardware fuses.

In simple terms, secure boot ensures running of signed/authorized software on the module, and unsigned/unauthorized software will not be allowed to run.

### 2. Enabled VDD\_QFPROM\_PRG Hardware Interface

A. BG96 R1.1 does not support secure boot function

The VDD\_QFPROM\_PRG (N19) pin of baseband chip is for secure boot function. In BG96 R1.1, this pin is connected to ground directly, which means secure boot function is disabled.

B. BG96 R1.2 supports secure boot function

According to Qualcomm's suggestion and our customers' requirements, the VDD\_QFPROM\_PRG pin is connected to VREG\_L3\_1P8(1.8V) in BG96 R1.2 so as to enable secure boot function.

The following pictures show the schematic and PCB designs of BG96 R1.1 and R1.2.

Build a Smarter World

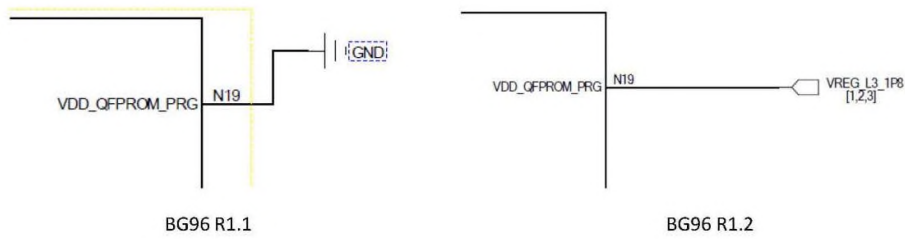

Figure 1: Schematic Designs of BG96 R1.1 and R1.2

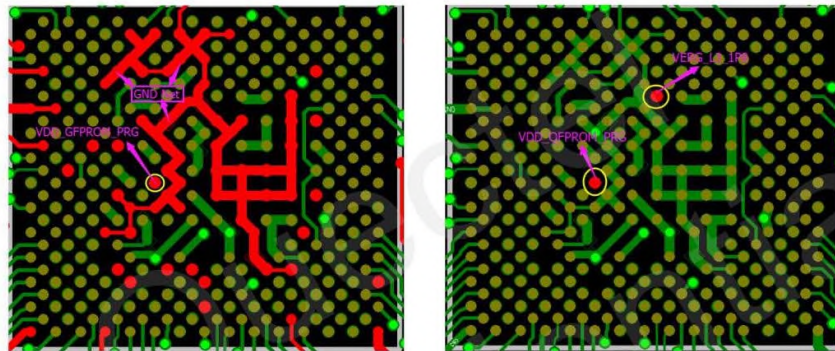

Figure 2: PCB Designs of BG96 R1.1 and R1.2

### 3. TX2.0 vs TX3.0

The biggest difference of TX3.0 as compared with TX2.0 lies in the adding of VoLTE and handover features. Since VoLTE environment has not been built so maturely yet, the main concern of customers is the handover function.

For TX2.0, re-selection is supported, while handover is not supported.

BG96 supports re-selection mechanism, which means when disconnection happens during cell handover, the module will reconnect automatically. This process lasts for about 1 (or 2) seconds, and the data transmitted (may happen by coincidence) will be buffered and resent once the reconnection established. So, the disconnection is generally imperceptible to customers.

- If the data transmission occurs at the moment that cell handover occurs coincidentally, the connection is kept with handover function; the connection is broken and re-connection established in about 1 (or 2) seconds with re-selection. This causes nearly no difference for data telematics because users even cannot feel this disconnection, whereas VoLTE might be affected because of the short time disconnection.



Build a Smarter World



- If the data transmission occurs in the period that no cell alternates, then no any influence will be caused.

Quectel  
Confidential