



RF TEST REPORT

Applicant Quectel Wireless Solutions Co., Ltd.

FCC ID XMR201707BG96

Product LTE Cat M1 & Cat NB1 & EGPRS Module

Brand Quectel

Model BG96, BG96 MINIPCIE

Marketing Quectel BG96, Quectel BG96 MINIPCIE

Report No. R2007A0435-R1

Issue Date July 14, 2020

TA Technology (Shanghai) Co., Ltd. tested the above equipment in accordance with the requirements in **FCC CFR47 Part 2 (2019)/ FCC CFR 47 Part 22H (2019)**. The test results show that the equipment tested is capable of demonstrating compliance with the requirements as documented in this report.

Performed by: Peng Tao

Approved by: Kai Xu

TA Technology (Shanghai) Co., Ltd.

No.145, Jintang Rd, Tangzhen Industry Park, Pudong Shanghai, China

TEL: +86-021-50791141/2/3

FAX: +86-021-50791141/2/3-8000



TABLE OF CONTENT

- 1. Test Laboratory4
 - 1.1. Notes of the Test Report 4
 - 1.2. Test facility.....4
 - 1.3. Testing Location 5
- 2. General Description of Equipment under Test.....6
- 3. Applied Standards.....7
- 4. Test Configuration.....8
- 5. Test Case Results.....9
 - 5.1. RF Power Output and Effective Radiated Power 9
 - 5.2. Occupied Bandwidth 12
 - 5.3. Band Edge Compliance..... 17
 - 5.4. Peak-to-Average Power Ratio (PAPR) 20
 - 5.5. Frequency Stability..... 22
 - 5.6. Spurious Emissions at Antenna Terminals 26
 - 5.7. Radiates Spurious Emission 29
- 6. Main Test Instruments34
- ANNEX A: Product Change Description.....37

Summary of measurement results

No.	Test Case	Clause in FCC rules	Verdict
1	RF Power Output and Effective Radiated Power	2.1046 22.913(a)(5)	PASS
2	Occupied Bandwidth	2.1049	PASS
3	Band Edge Compliance	2.1051 / 22.917(a)	PASS
4	Peak-to-Average Power Ratio	22.913(d)/ KDB 971168 D01(5.7)	Refer to the Original
5	Frequency Stability	2.1055 / 22.355	PASS
6	Spurious Emissions at Antenna Terminals	2.1051 / 22.917(a)	PASS
7	Radiates Spurious Emission	2.1053 / 22.917 (a)	Refer to the Original
Date of Testing: August 4, 2017 ~ August 18, 2017 and April 2, 2020 ~ April 9, 2020 and July 13, 2020			
Note: All indications of Pass/Fail in this report are opinions expressed by TA Technology (Shanghai) Co., Ltd. based on interpretations and/or observations of test results. Measurement Uncertainties were not taken into account and are published for informational purposes only.			

BG96, BG96 MINIPCIE (Report No.: R2007A0435-R1) is a variant model of BG96, BG96 MINIPCIE (Report No.: R1811A0536-R4). Test values partial duplicated from original for variant. There is only tested RF power output, Effective Radiated Power, Occupied Bandwidth, Band Edge Compliance , Frequency Stability and Spurious Emissions at Antenna Terminals for variant in this report. The detailed product change description please refers to the Statement letter_BG96.

BG96, BG96 MINIPCIE (Report No: R1811A0536-R4) is a variant model of BG96 (Report No: RXA1706-0199RF05). Test values duplicated from Original for variant. There is no test for variant in this report. The detailed product change description please refers to the ANNEX A.



1. Test Laboratory

1.1. Notes of the Test Report

This report shall not be reproduced in full or partial, without the written approval of **TA technology (shanghai) co., Ltd.** The results documented in this report apply only to the tested sample, under the conditions and modes of operation as described herein .Measurement Uncertainties were not taken into account and are published for informational purposes only. This report is written to support regulatory compliance of the applicable standards stated above. This report must not be used by the client to claim product certification, approval, or endorsement by any government agencies.

1.2. Test facility

FCC (Designation number: CN1179, Test Firm Registration Number: 446626)

TA Technology (Shanghai) Co., Ltd. has been listed on the US Federal Communications Commission list of test facilities recognized to perform electromagnetic emissions measurements.

A2LA (Certificate Number: 3857.01)

TA Technology (Shanghai) Co., Ltd. has been listed by American Association for Laboratory Accreditation to perform electromagnetic emission measurement.



1.3. Testing Location

Company: TA Technology (Shanghai) Co., Ltd.
Address: No.145, Jintang Rd, Tangzhen Industry Park, Pudong
City: Shanghai
Post code: 201201
Country: P. R. China
Contact: Xu Kai
Telephone: +86-021-50791141/2/3
Fax: +86-021-50791141/2/3-8000
Website: <http://www.ta-shanghai.com>
E-mail: xukai@ta-shanghai.com

2. General Description of Equipment under Test

Client Information

Applicant	Quectel Wireless Solutions Co., Ltd.
Applicant address	7th Floor, Hongye Building, No. 1801 Hongmei Road, Xuhui District, Shanghai, China
Manufacturer	Quectel Wireless Solutions Co., Ltd.
Manufacturer address	7th Floor, Hongye Building, No. 1801 Hongmei Road, Xuhui District, Shanghai, China

General Information

EUT Description			
Model	BG96, BG96 MINIPCIE		
IMEI	866425038291656		
Hardware Version	R1.2		
Software Version	BG96MAR04A01M1G		
Power Supply	External power supply		
Antenna Type	The EUT don't have standard Antenna, The Antenna used for testing in this report is the after-market accessory (Dipole Antenna)		
Antenna Gain	Frequency(MHz)	Gain(dBi)	
	820	2.53	
	840	1.89	
	850	2.29	
Test Mode(s)	NB-IOT Band5;		
Test Modulation	BPSK, QPSK		
Category	NB1		
Deployment	stand-alone		
Sub-carrier spacing	3.75KHz, 15KHz		
Ntones	single-tone, multi-tone		
Maximum E.R.P.	NB-IOT Band 5:	23.11 dBm	
Rated Power Supply Voltage	3.8V		
Extreme Voltage	Minimum: 3.3V Maximum: 4.3V		
Extreme Temperature	Lowest: -40°C Highest: +85°C		
Frequency Range(s)	Band	Tx (MHz)	Rx (MHz)
	NB-IOT Band 5	824 ~ 849	869 ~ 894
Note: 1. The EUT is sent from the applicant to TA and the information of the EUT is declared by the applicant.			

The series model number is: BG96 MINIPCIE. The difference of these models are have different marketing requirement.



3. Applied Standards

According to the specifications of the manufacturer, it must comply with the requirements of the following standards:

Test standards:

FCC CFR 47 Part 22H (2019)

ANSI C63.26 (2015)

Reference standard:

FCC CFR47 Part 2 (2019)

KDB 971168 D01 Power Meas License Digital Systems v03r01

4. Test Configuration

Radiated measurements are performed by rotating the EUT in three different orthogonal test planes. EUT stand-up position (X, Y axis), lie-down position (Z axis). Receiver antenna polarization (horizontal and vertical), the worst emission was found in position (Z axis, vertical polarization) and the worst case was recorded.

All mode and data rates and positions were investigated. Subsequently, only the worst case emissions are reported.

The following testing in NB-IOT is set based on the maximum RF Output Power.

Test modes are chosen as the worst case configuration below for NB-IOT Band 5

Test items	Modes	Deployment mode	Subcarrier Spacing (kHz)		Modulation		Test Channel		
		Stand-alone	3	15	BPSK	QPSK	L	M	H
RF power output and Effective Radiated power	NB-IOT B5	O	O	O	O	O	O	O	O
Occupied Bandwidth	NB-IOT B5	O	O	O	O	O	O	O	O
Band Edge Compliance	NB-IOT B5	O	O	O	O	O	O	-	O
Peak-to-Average Power Ratio	NB-IOT B5	O	O	O	O	O	-	O	-
Frequency Stability	NB-IOT B5	O	O	O	O	O	O	O	O
Spurious Emissions at Antenna Terminals	NB-IOT B5	O	-	O	-	O	O	O	O
Radiates Spurious Emission	NB-IOT B5	O	-	O	-	O	O	O	O
Note 1. The mark "O" means that this configuration is chosen for testing. 2. The mark "-" means that this configuration is not testing.									

5. Test Case Results

5.1. RF Power Output and Effective Radiated Power

Ambient condition

Temperature	Relative humidity	Pressure
23°C ~25°C	45%~50%	101.5kPa

Methods of Measurement

During the process of the testing, The EUT is controlled by the Base Station Simulator to ensure max power transmission and proper modulation.

The testing follows FCC KDB 971168 v03r01 Section 5.8 and ANSI C63.26 (2015).

- a) Connect the equipment as illustrated. Mount the equipment with the manufacturer specified antenna in a vertical orientation on a manufacturer specified mounting surface located on a non-conducting rotating platform of a RF anechoic chamber (preferred) or a standard radiation site.
- b) Key the transmitter, then rotate the EUT 360° azimuthally and record spectrum analyzer power level (LVL) measurements at angular increments that are sufficiently small to permit resolution of all peaks. If a standard radiation test site is used, raise and lower the test antenna to obtain a maximum reading at each angular increment. (Note: several batteries may be needed to offset the effect of battery voltage droop, which should not exceed 5% of the manufactured specified battery voltage during transmission).
- c) Replace the transmitter under test with a vertically polarized half-wave dipole (or an antenna whose gain is known relative to an ideal half-wave dipole). The center of the antenna should be at the same location as the center of the antenna under test.
- d) Connect the antenna to a signal generator with a known output power and record the path loss (in dB) as LOSS. If a standard radiation test site is used, raise and lower the test antenna to obtain a maximum reading. $LOSS = \text{Generator Output Power (dBm)} - \text{Analyzer reading (dBm)}$
- e) Determine the effective radiated output power at each angular position from the readings in steps b) and d) using the following equation: $ERP \text{ (dBm)} = \text{LVL (dBm)} + \text{LOSS (dB)}$
- f) The maximum ERP is the maximum value determined in the preceding step.
- g) When calculating ERP, in addition to knowing the antenna radiation and matching characteristics, it is necessary to know the loss values of all elements (e.g. transmission line attenuation, mismatches, filters, combiners) interposed between the point where transmitter output power is measured, and the point where power is applied to the antenna. ERP can then be calculated as follows:
 $EIRP \text{ (dBm)} = \text{Output Power (dBm)} - \text{Losses (dB)} + \text{Antenna Gain (dBi)}$
where: dBd refers to gain relative to an ideal dipole.
 $EIRP \text{ (dBm)} = ERP \text{ (dBm)} + 2.15 \text{ (dB.)}$

The RB allocation refers to section 5.1, using the maximum output power configuration.

Test Setup

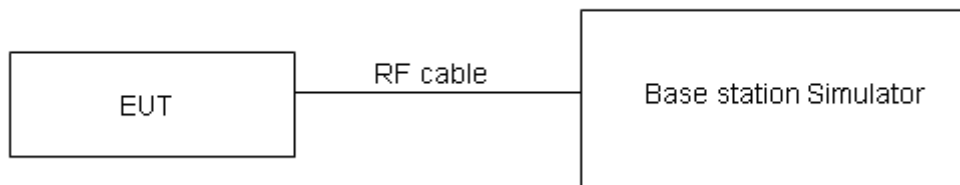

The loss between RF output port of the EUT and the input port of the tester has been taken into consideration.

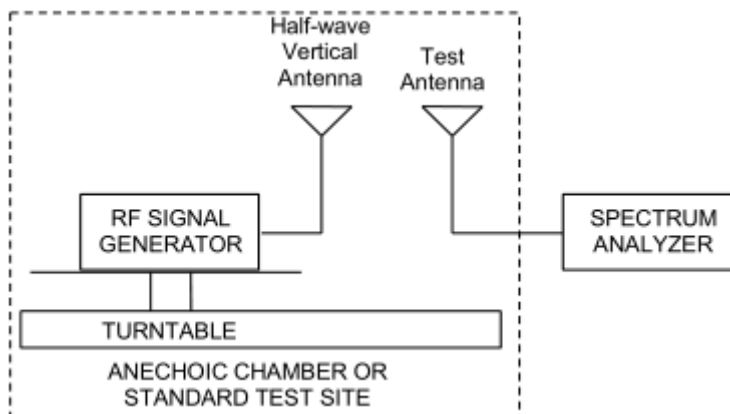
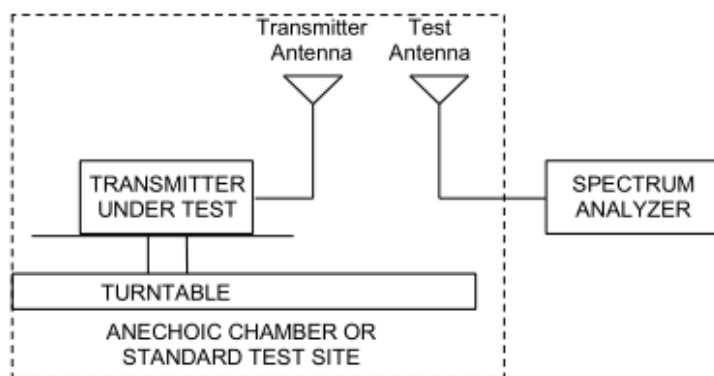

Limits

No specific RF power output requirements in part 2.1046.

Rule Part 22.913(a)(5) specifies that "Mobile/portable stations are limited to 7 watts ERP".

Limit	$\leq 7 \text{ W}$ (38.45 dBm)
-------	--------------------------------

Measurement Uncertainty

The assessed measurement uncertainty to ensure 95% confidence level for the normal distribution is with the coverage factor $k = 2$, $U = 0.4 \text{ dB}$ for RF power output, $k = 2$, $U = 1.19 \text{ dB}$ for ERP .

Test Results

Variant

Mode	Modulation	Sub-carrier spacing (kHz)	Ntones	Conducted Power (dBm) for low/mid/high channel			ERP (dBm)		
				20402/824.2MHz	20525/836.5MHz	20648/848.8MHz	20402/824.2MHz	20525/836.5MHz	20648/848.8MHz
NB-IOT Band 5 Standalone	BPSK	3.75	1@0	22.54	22.43	22.44	22.92	22.17	22.58
			1@47	22.57	22.37	22.39	22.95	22.11	22.53
		15	1@0	22.72	22.68	22.73	23.10	22.42	22.87
			1@11	22.73	22.72	22.72	23.11	22.46	22.86
	QPSK	3.75	1@0	22.47	22.37	22.50	22.85	22.11	22.64
			1@47	22.37	22.31	22.49	22.75	22.05	22.63
		15	1@0	22.72	22.69	22.70	23.10	22.43	22.84
			1@11	22.73	22.68	22.73	23.11	22.42	22.87
		15	12@0	22.70	22.71	22.69	23.08	22.45	22.83

5.2. Occupied Bandwidth

Ambient condition

Temperature	Relative humidity	Pressure
23°C ~25°C	45%~50%	101.5kPa

Method of Measurement

The EUT was connected to Spectrum Analyzer and Base Station Simulator via power Splitter. The occupied bandwidth is measured using spectrum analyzer.

RBW is set to 2kHz, VBW is set to 6.2kHz for NB-IOT Band 5, 99% power and -26dBc occupied bandwidths are recorded. Spectrum analyzer plots are included on the following pages.

Test Setup

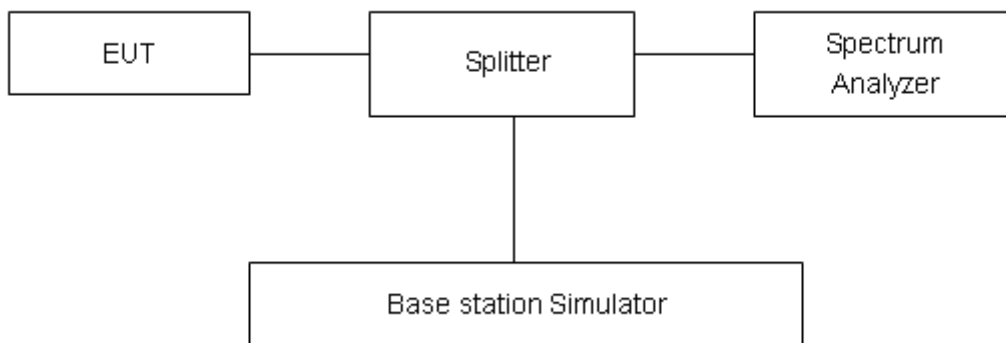

Limits

No specific occupied bandwidth requirements in part 2.1049.

Measurement Uncertainty

The assessed measurement uncertainty to ensure 95% confidence level for the normal distribution is with the coverage factor $k = 2$, $U = 624\text{Hz}$.

**Test Result****Variant**

Mode	Modulation	Sub-carrier spacing (kHz)	Ntones	Bandwidth(kHz) for low/mid/high channel					
				20402/824.2MHz		20525/836.5MHz		20648/848.8MHz	
				99% Power	-26dBc	99% Power	-26dBc	99% Power	-26dBc
NB-IOT Band 5 Standalone	BPSK	3.75	1@0	54.12	41.90	50.02	37.96	49.37	37.62
	QPSK	3.75	1@0	54.88	41.90	57.74	39.20	55.98	38.70
	BPSK	15	1@0	128.89	120.60	123.37	106.20	126.95	104.10
	QPSK	15	1@0	120.24	117.90	118.82	117.70	115.93	116.80
	QPSK	15	12@0	185.16	251.70	184.27	251.10	185.27	260.60

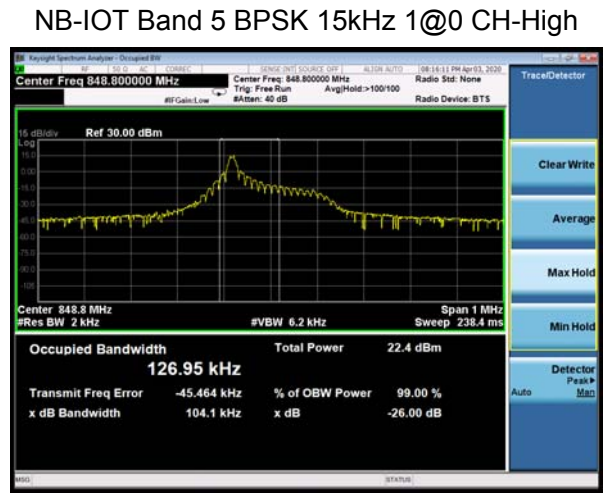
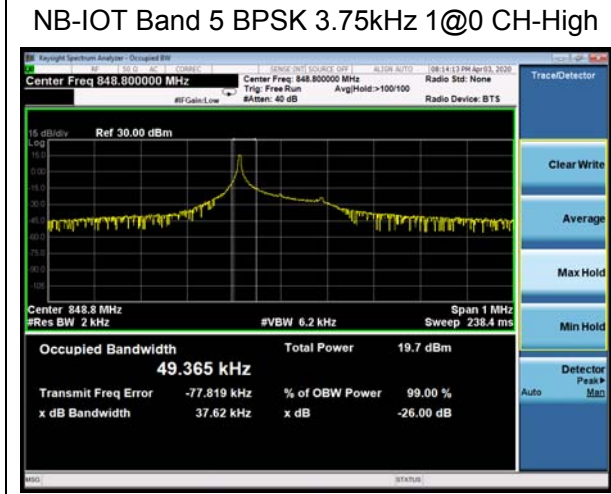
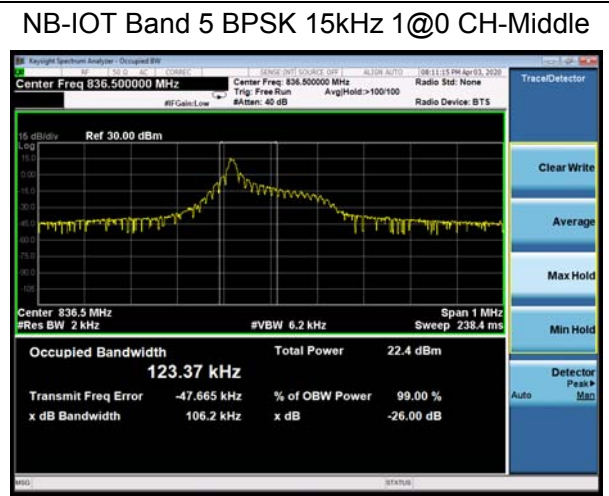
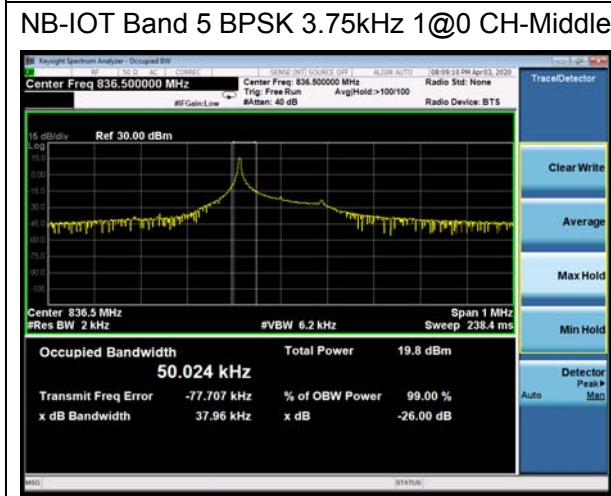
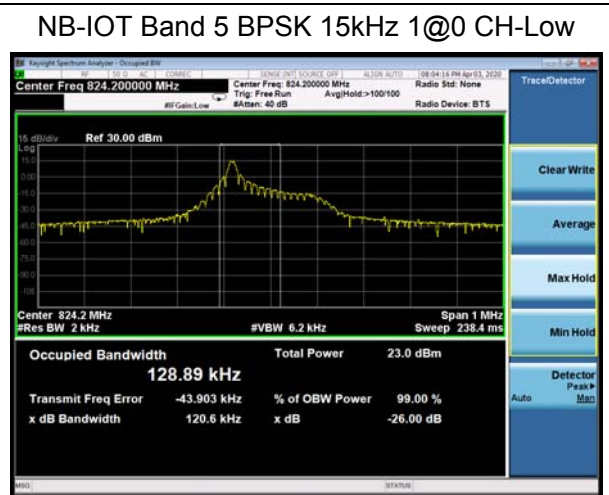
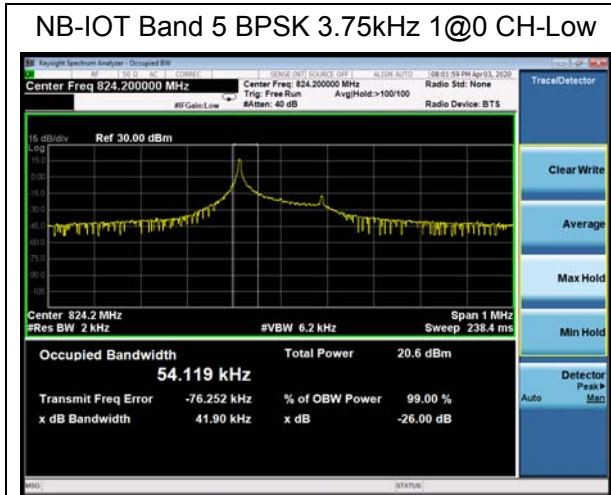

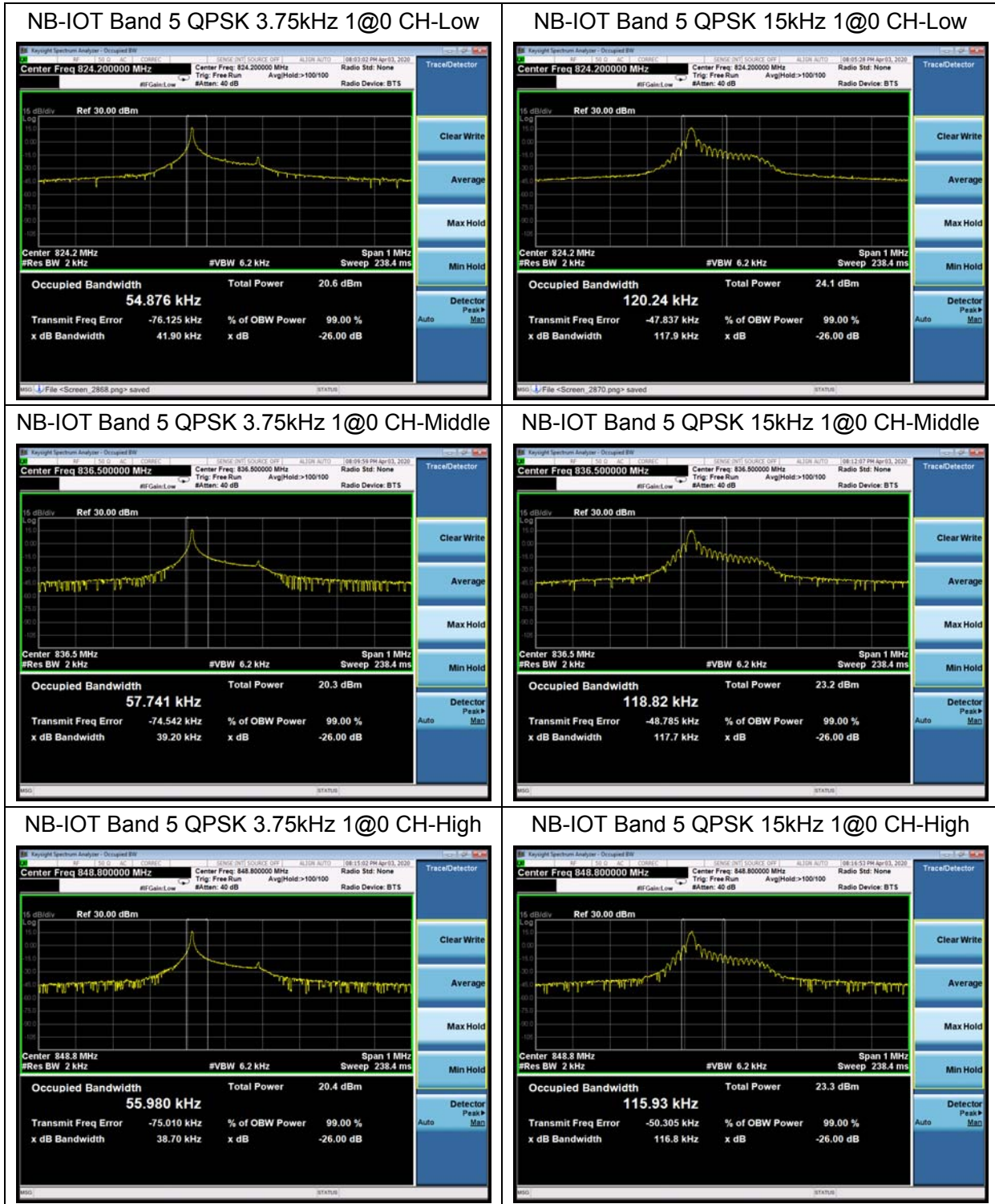

NB-IOT Band 5 QPSK 15kHz 12@0 CH-Low



NB-IOT Band 5 QPSK 15kHz 12@0 CH-Middle



NB-IOT Band 5 QPSK 15kHz 12@0 CH-High



5.3. Band Edge Compliance

Ambient condition

Temperature	Relative humidity	Pressure
23°C ~25°C	45%~50%	101.5kPa

Method of Measurement

The EUT was connected to Spectrum Analyzer and Base Station Simulator via power Splitter. The band edge of the lowest and highest channels were measured. The average detector is used.

RBW is set to $\geq 1\%EBW$, VBW is set to 3x RBW.

Spectrum analyzer plots are included on the following pages.

Test Setup

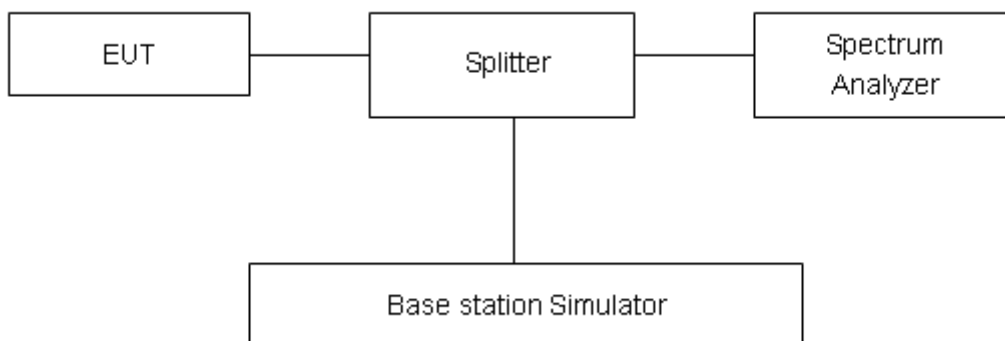

Limits

Rule Part 22.917(a) specifies that “The power of any emission outside of the authorized operating frequency ranges must be attenuated below the transmitting power (P) by a factor of at least 43 + 10 log(P) dB.”

Limit	-13 dBm
-------	---------

Measurement Uncertainty

The assessed measurement uncertainty to ensure 95% confidence level for the normal distribution is with the coverage factor $k = 1.96$, $U=0.684dB$.

Test Result:

Variant

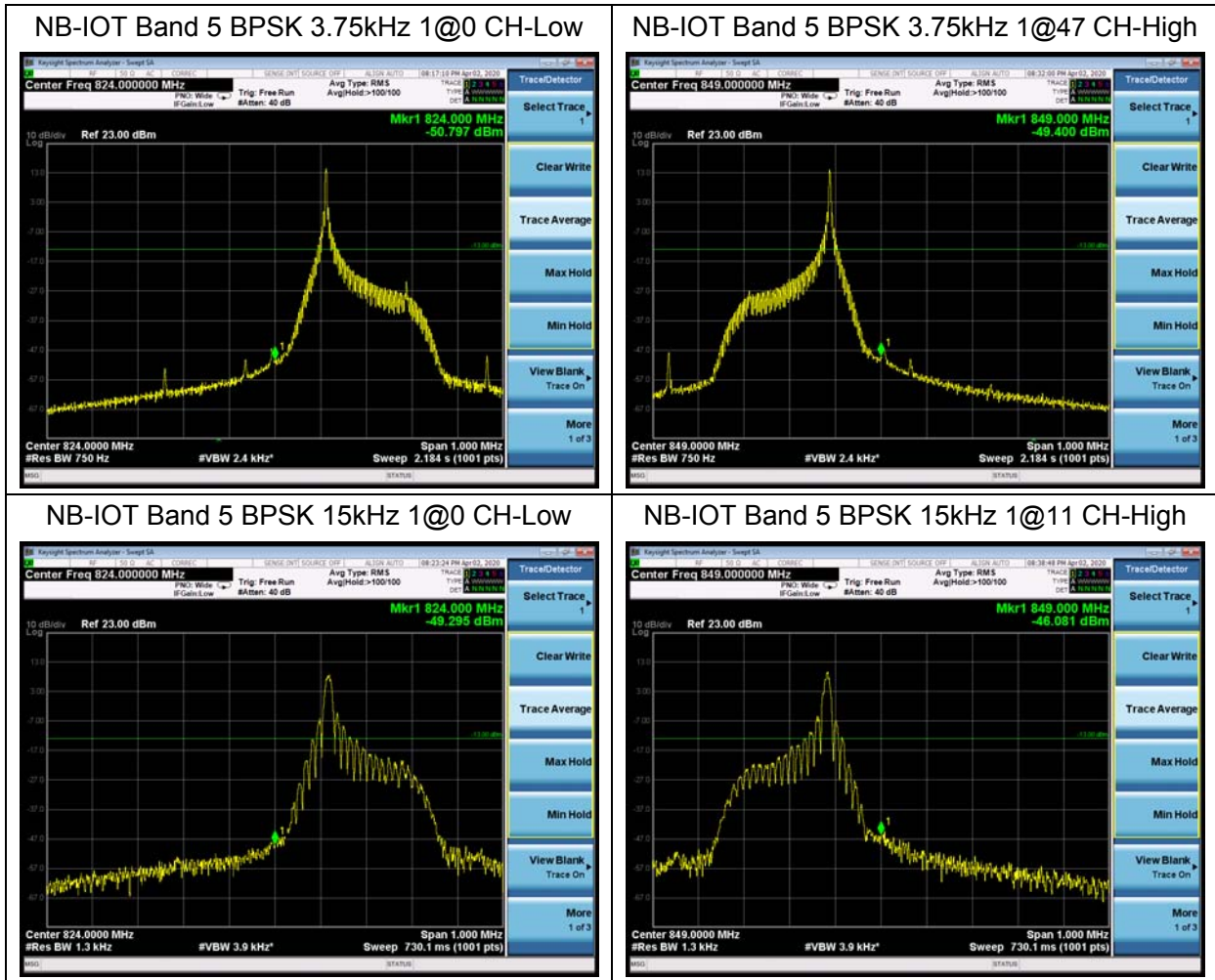

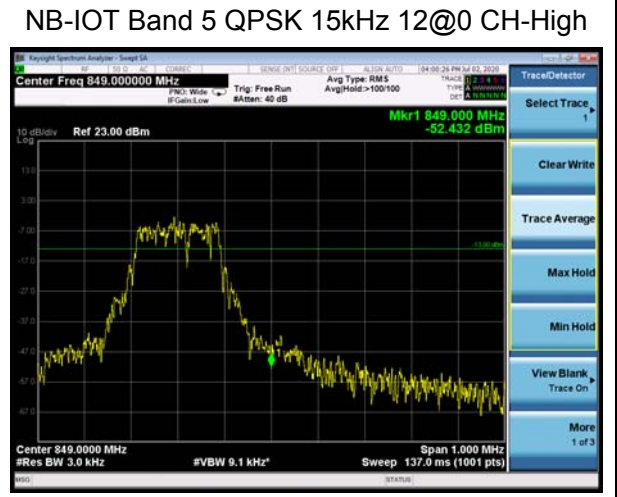
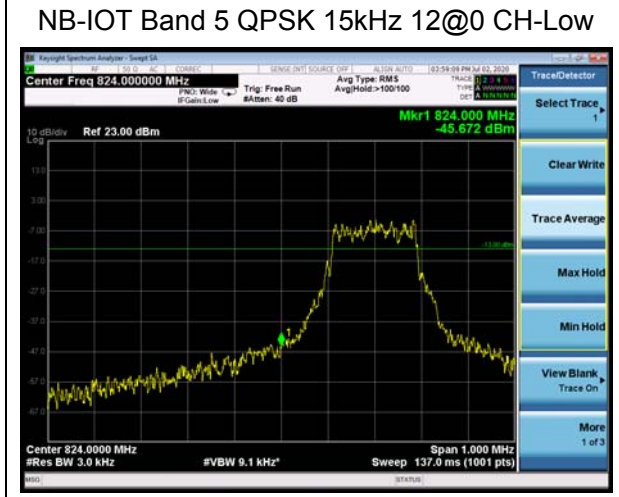
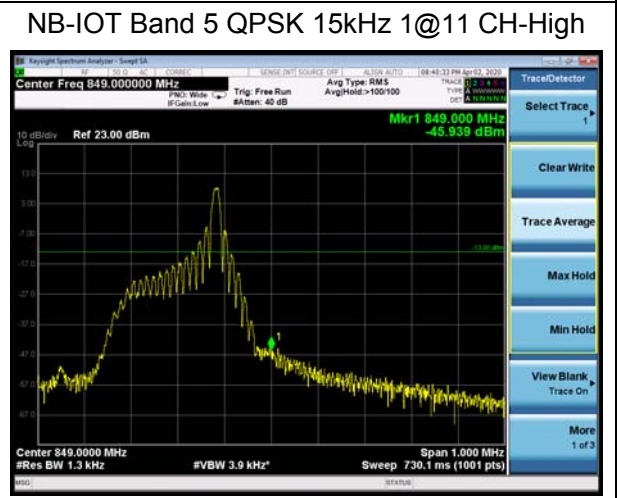
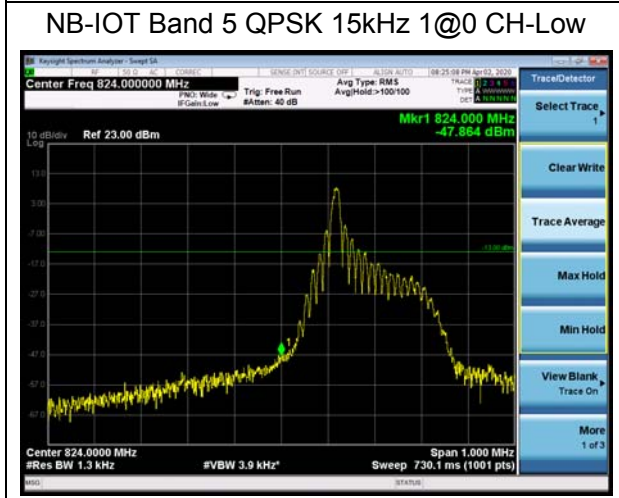
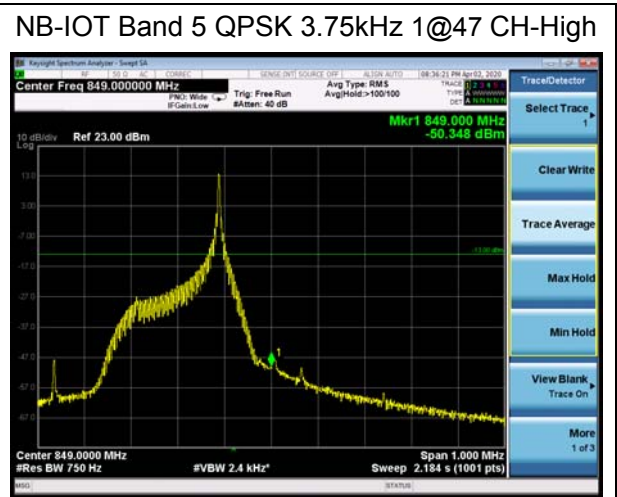
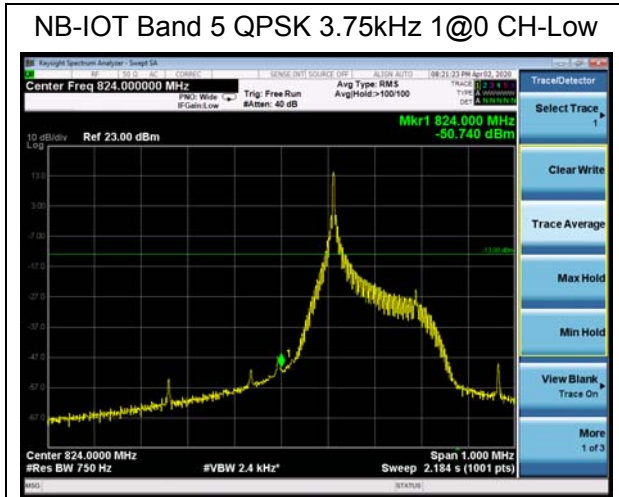

5.4. Peak-to-Average Power Ratio (PAPR)

Ambient condition

Temperature	Relative humidity	Pressure
23°C ~25°C	45%~50%	101.5kPa

Methods of Measurement

Measure the total peak power and record as P_{Pk} . And measure the total average power and record as P_{Avg} . Both the peak and average power levels must be expressed in the same logarithmic units (e.g., dBm). Determine the PAPR from:

$$PAPR (dB) = P_{Pk} (dBm) - P_{Avg} (dBm).$$

Test Setup

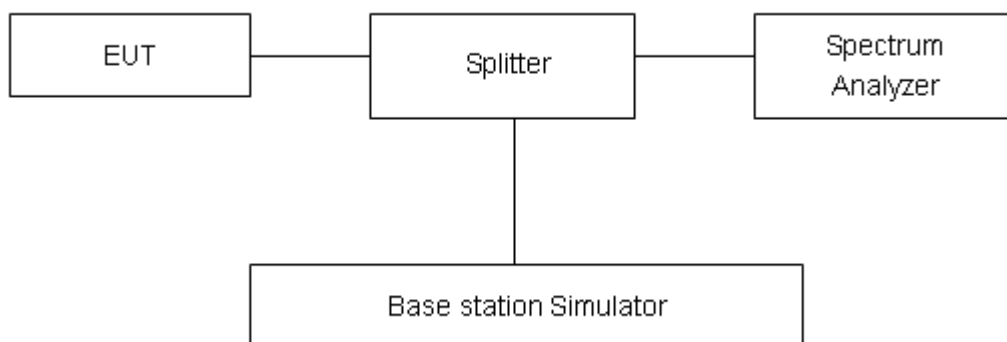

Limits

According to the Sec. 22.913(d), The peak-to-average ratio (PAR) of the transmission must not exceed 13 dB.

Measurement Uncertainty

The assessed measurement uncertainty to ensure 95% confidence level for the normal distribution is with the coverage factor $k = 2$, $U = 0.4$ dB.

**Test Results****Original**

NB-IOT Band 5 Standalone							
Modulation	Sub-carrier spacing (KHz)	Channel/Frequency (MHz)	Peak (dBm)	Avg (dBm)	PAPR (dB)	Limit (dB)	Conclusion
BPSK	3.75	20525/836.5	25.50	22.19	3.31	≤13	PASS
QPSK	3.75	20525/836.5	28.37	22.31	6.06	≤13	PASS
BPSK	15	20525/836.5	25.27	22.09	3.18	≤13	PASS
QPSK	15	20525/836.5	28.49	22.36	6.13	≤13	PASS

5.5. Frequency Stability

Ambient condition

Temperature	Relative humidity	Pressure
23°C ~25°C	45%~50%	101.5kPa

Method of Measurement

1. Frequency Stability (Temperature Variation)

The temperature inside the climate chamber is varied from -40°C to +85°C in 10°C step size,

(1) With all power removed, the temperature was decreased to 0°C and permitted to stabilize for three hours.

(2) Measure the carrier frequency with the test equipment in a “call mode”. These measurements should be made within 1 minute of powering up the mobile station, to prevent significant self warming.

(3) Repeat the above measurements at 10°C increments from -40°C to +85°C. Allow at least 1.5 hours at each temperature, un-powered, before making measurements. Frequency Stability (Voltage Variation)

The frequency stability shall be measured with variation of primary supply voltage as follows:

(1) Vary primary supply voltage from 85 to 115 percent of the nominal value for other than hand carried battery equipment.

(2) For hand carried, battery powered equipment, reduce primary supply voltage to the battery-operating end point which shall be specified by the manufacturer.

This transceiver is specified to operate with an input voltage of between 3.3 V and 4.3 V, with a nominal voltage of 3.8V.

Test setup

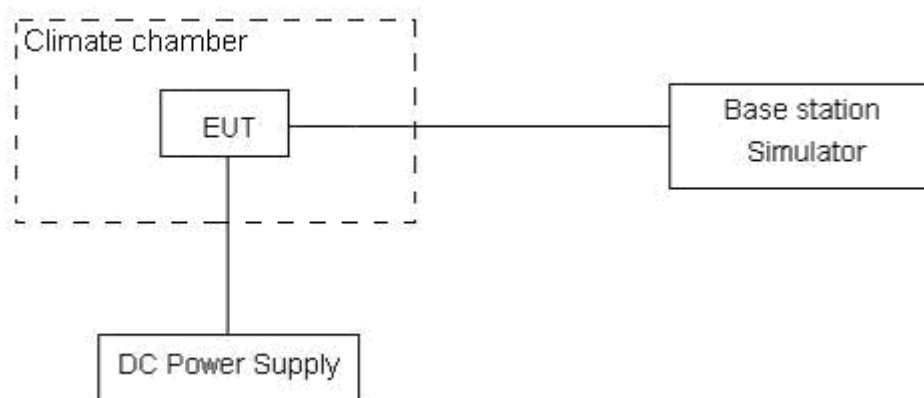

**Limits**

According to the Sec. 22.355, the frequency stability of the carrier shall be accurate to within 2.5 ppm of the received frequency for mobile stations.

Limits	≤ 2.5 ppm
--------	----------------

Measurement Uncertainty

The assessed measurement uncertainty to ensure 99.75% confidence level for the normal distribution is with the coverage factor $k = 3$, $U = 0.01$ ppm.



Test Result

Variant

NB-IOT Band 5						
Condition		Freq.Error (Hz)	Freq.Error (Hz)	Frequency Stability (ppm)	Frequency Stability (ppm)	Verdict
Sub-carrier spacing (KHz)	3.75					
Temperature	Voltage	BPSK	QPSK	BPSK	QPSK	
Normal (25°C)	Normal	6.66	17.72	0.00355	0.00942	PASS
Extreme (85°C)		17.14	6.83	0.00912	0.00364	PASS
Extreme (80°C)		1.01	16.59	0.00054	0.00882	PASS
Extreme (70°C)		7.22	13.34	0.00384	0.00710	PASS
Extreme (60°C)		2.71	15.28	0.00144	0.00813	PASS
Extreme (50°C)		4.95	14.91	0.00263	0.00793	PASS
Extreme (40°C)		14.54	16.83	0.00774	0.00895	PASS
Extreme (30°C)		1.14	10.91	0.00061	0.00580	PASS
Extreme (20°C)		13.05	3.55	0.00694	0.00189	PASS
Extreme (10°C)		2.17	1.76	0.00115	0.00094	PASS
Extreme (0°C)		15.62	15.69	0.00831	0.00834	PASS
Extreme (-10°C)		11.44	10.71	0.00609	0.00570	PASS
Extreme (-20°C)		15.67	14.17	0.00833	0.00754	PASS
Extreme (-30°C)		11.32	10.72	0.00602	0.00570	PASS
Extreme (-40°C)		4.33	15.13	0.00231	0.00805	PASS
25°C	LV	10.39	15.12	0.00553	0.00804	PASS
	HV	2.67	12.89	0.00142	0.00686	PASS
Condition		Freq.Error (Hz)	Freq.Error (Hz)	Frequency Stability (ppm)	Frequency Stability (ppm)	Verdict
Sub-carrier spacing (KHz)	15					
Temperature	Voltage	BPSK	QPSK	BPSK	QPSK	
Normal (25°C)	Normal	9.47	11.96	0.00504	0.00636	PASS
Extreme (85°C)		12.01	17.29	0.00639	0.00920	PASS
Extreme (80°C)		16.23	2.38	0.00863	0.00127	PASS
Extreme (70°C)		2.29	13.80	0.00122	0.00734	PASS
Extreme (60°C)		4.44	1.62	0.00236	0.00086	PASS
Extreme (50°C)		13.30	15.62	0.00707	0.00831	PASS
Extreme (40°C)		8.77	17.46	0.00467	0.00929	PASS
Extreme (30°C)		2.27	4.21	0.00121	0.00224	PASS
Extreme (20°C)		4.40	12.75	0.00234	0.00678	PASS
Extreme (10°C)		14.94	1.99	0.00795	0.00106	PASS
Extreme (0°C)		5.69	9.96	0.00302	0.00530	PASS



Extreme (-10°C)		13.07	10.01	0.00695	0.00533	PASS
Extreme (-20°C)		4.97	3.22	0.00264	0.00171	PASS
Extreme (-30°C)		10.07	2.06	0.00536	0.00110	PASS
Extreme (-40°C)		17.58	6.73	0.00935	0.00358	PASS
25°C	LV	7.62	11.36	0.00405	0.00604	PASS
	HV	17.19	11.56	0.00914	0.00615	PASS

5.6. Spurious Emissions at Antenna Terminals

Ambient condition

Temperature	Relative humidity	Pressure
23°C ~25°C	45%~50%	101.5kPa

Method of Measurement

The EUT was connected to Spectrum Analyzer and Base Station Simulator via power Splitter. The measurement is carried out using a spectrum analyzer. The spectrum analyzer scans from 9kHz to the 10th harmonic of the carrier.

The peak detector is used. RBW are set to 100 kHz and VBW are set to 300 kHz for below 1G, RBW are set to 1MHz and VBW are set to 3MHz for above 1G, Sweep is set to ATUO.

The modulation mode and RB allocation refer to section 5.1, using the maximum output power configuration.

Test setup

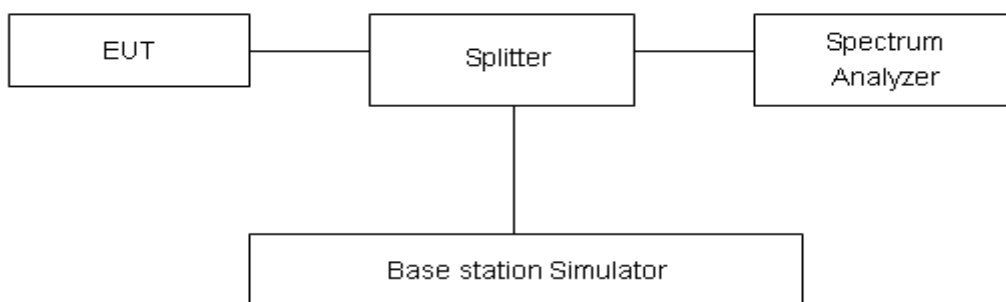

Limits

Rule Part 22.917(a) specifies that “The power of any emission outside of the authorized operating frequency ranges must be attenuated below the transmitting power (P) by a factor of at least $43 + 10 \log (P)$ dB.”

Limit	-13 dBm

Measurement Uncertainty

The assessed measurement uncertainty to ensure 99.75% confidence level for the normal distribution is with the coverage factor $k = 1.96$.

Frequency	Uncertainty
9kHz-1GHz	0.684 dB
1GHz-18GHz	1.407 dB

Test Result

Sweep the whole frequency band through the range from 9kHz to the 10th harmonic of the carrier, the emissions more than 20 dB below the limit are not reported.

The signal beyond the limit is carrier.

Variant

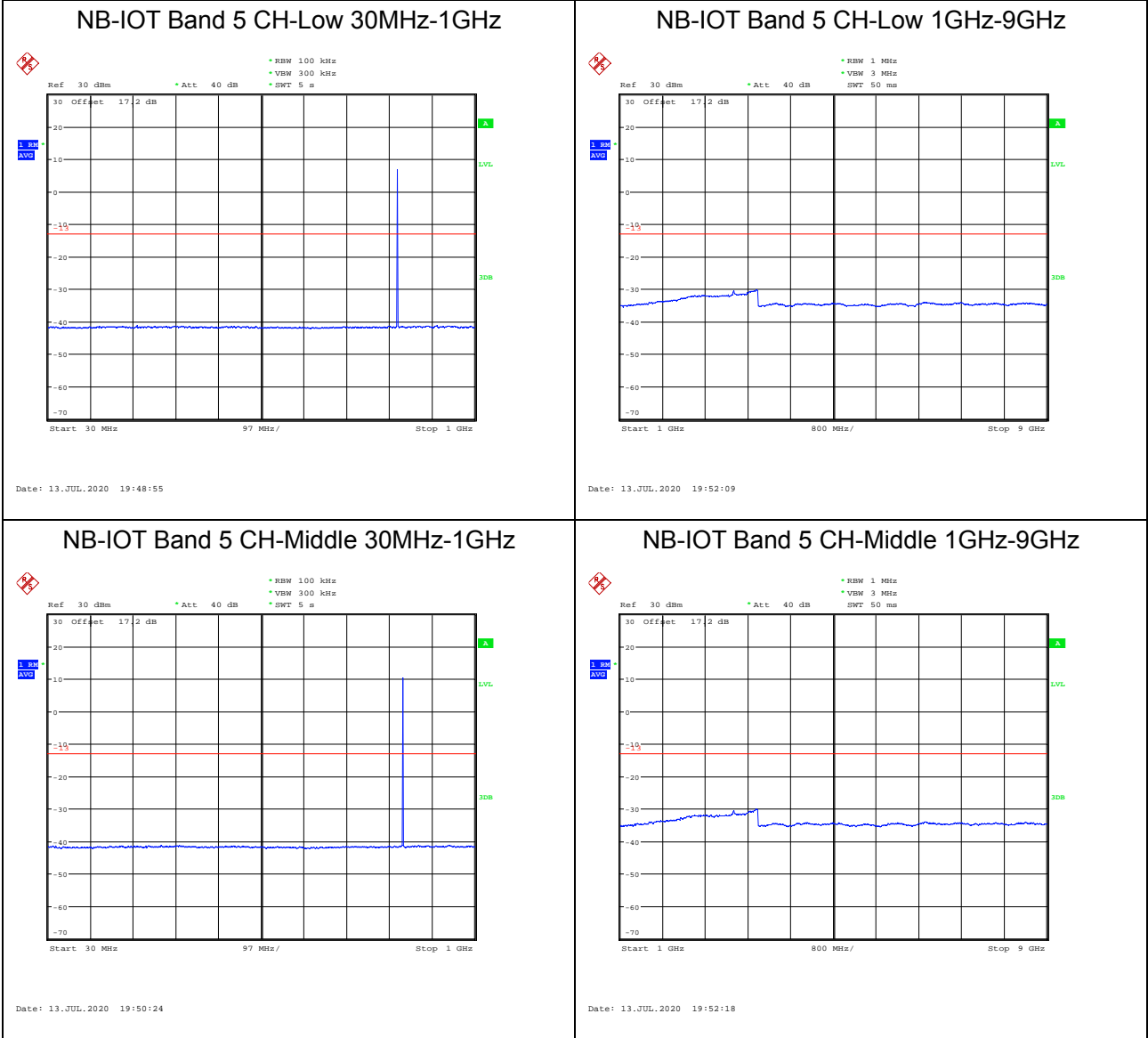



NB-IOT Band 5 CH-High 30MHz-1GHz

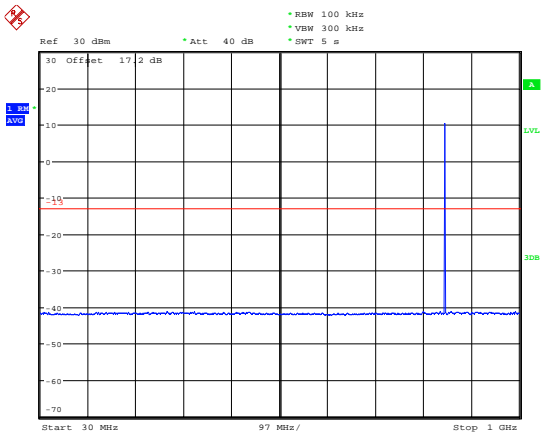

Date: 13.JUL.2020 19:51:22

NB-IOT Band 5 CH-High 1GHz-9GHz

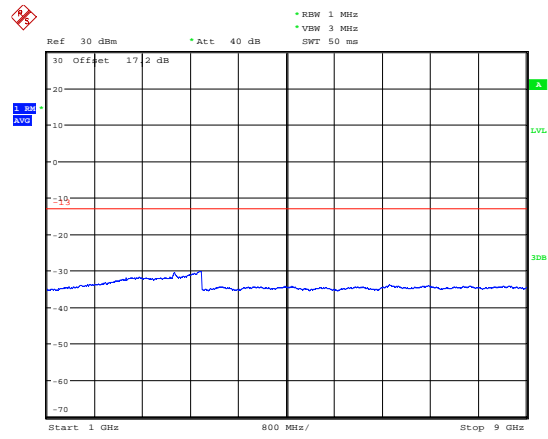

Date: 13.JUL.2020 19:52:27

5.7. Radiates Spurious Emission

Ambient condition

Temperature	Relative humidity	Pressure
23°C ~25°C	45%~50%	101.5kPa

Method of Measurement

1. The testing follows FCC KDB 971168 v02r02 Section 5.8 and ANSI / TIA-603-D-2010 Section 2.2.12.
2. Above 30MHz: The EUT is placed on a turntable 0.8 meters above the ground in the chamber, 3 meter away from the antenna. The maximal emission value is acquired by adjusting the antenna height, polarisation and turntable azimuth. Normally, the height range of antenna is 1 m to 4 m, the azimuth range of turntable is 0° to 360°, and the receive antenna has two polarizations Vertical (V) and Horizontal (H). Above 1GHz: (Note: the FCC's permission to use 1.5m as an alternative per TCBC Conf call of Dec. 2, 2014.) The EUT is placed on a turntable 1.5 meters above the ground in the chamber, 3 meter away from the antenna. The maximal emission value is acquired by adjusting the antenna height, polarisation and turntable azimuth. Normally, the height range of antenna is 1 m to 4 m, the azimuth range of turntable is 0° to 360°, and the receive antenna has two polarizations Vertical (V) and Horizontal (H).
3. A log-periodic antenna or double-ridged waveguide horn antenna shall be substituted in place of the EUT. The log-periodic antenna will be driven by a signal generator and the level will be adjusted till the same power value on the spectrum analyzer or receiver. The level of the spurious emissions can be calculated through the level of the signal generator, cable loss, the gain of the substitution antenna and the reading of the spectrum analyzer or receiver.
4. The EUT is then put into continuously transmitting mode at its maximum power level during the test. Set Test Receiver or Spectrum RBW=1MHz, VBW=3MHz for above 1GHz and RBW=100kHz, VBW=300kHz for 30MHz to 1GHz, And the maximum value of the receiver should be recorded as (Pr).
5. The EUT shall be replaced by a substitution antenna. In the chamber, an substitution antenna for the frequency band of interest is placed at the reference point of the chamber. An RF Signal source for the frequency band of interest is connected to the substitution antenna with a cable that has been constructed to not interfere with the radiation pattern of the antenna. A power (PMea) is applied to the input of the substitution antenna, and adjust the level of the signal generator output until the value of the receiver reach the previously recorded (Pr). The power of signal source (PMea) is recorded. The test should be performed by rotating the test item and adjusting the receiving antenna polarization.
6. A amplifier should be connected to the Signal Source output port. And the cable should be connect between the Amplifier and the Substitution Antenna. The cable loss (Pcl), the Substitution Antenna Gain (Ga) and the Amplifier Gain (PAG) should be recorded after test.
7. The measurement results are obtained as described below:
Power(EIRP)=PMea- PAG - Pcl + Ga
The measurement results are amend as described below:
Power(EIRP)=PMea- Pcl + Ga

8. This value is EIRP since the measurement is calibrated using an antenna of known gain (2.15 dBi) and known input power. ERP can be calculated from EIRP by subtracting the gain of the dipole, $ERP = EIRP - 2.15\text{dBi}$.

Test setup

30MHz~~~ 1GHz

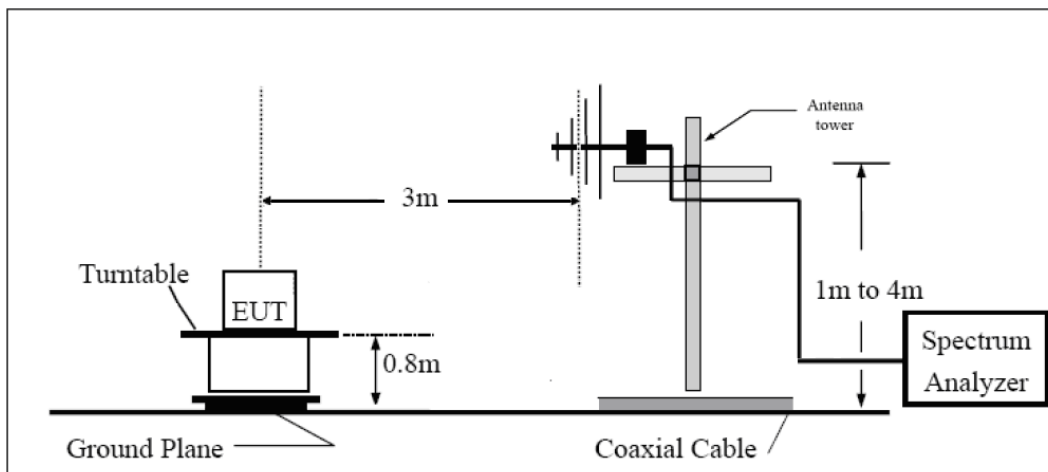

Above 1GHz

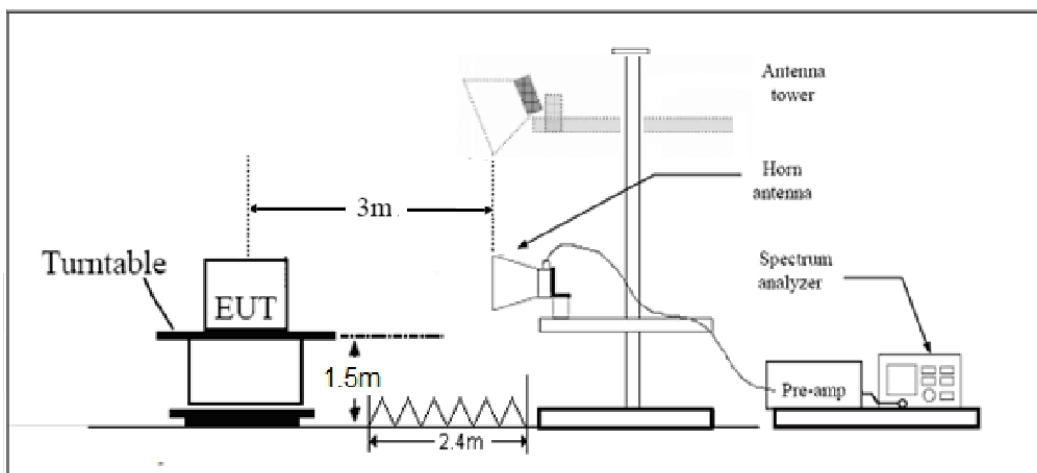

Note: Area side:2.4mX3.6m

The radiated emission was measured in the following position: EUT lie-down position (Z axis), stand-up position (X, Y axis). The worst emission was found in lie-down position (Z axis) and the worst case was recorded.

Limits

Rule Part 22.917(a) specifies that “The power of any emission outside of the authorized operating frequency ranges must be attenuated below the transmitting power (P) by a factor of at least $43 + 10 \log (P)$ dB.”

Limit	-13 dBm
-------	---------

Measurement Uncertainty

The assessed measurement uncertainty to ensure 95% confidence level for the normal distribution is with the coverage factor $k = 1.96$, $U = 3.55$ dB.

Test Result

The other Spurious RF Radiated emissions level is no more than noise floor.

The worst emission was found in the antenna is vertical position.

Standalone deployment with 15 KHz subcarrier spacing and QPSK mode for CAT NB1:

Original

NB-IOT Band 5 CH-Low

Harmonic	Frequency (MHz)	SG (dBm)	Cable Loss (dB)	Gain (dBi)	Antenna Polarization	ERP Level (dBm)	Limit (dBm)	Margin (dB)	Azimuth (deg)
2	1648.2	-51.43	2.00	10.75	vertical	-44.83	-13.0	31.83	45
3	2472.3	-50.19	2.51	11.05	vertical	-43.80	-13.0	30.80	180
4	3296.4	-54.02	4.20	11.15	vertical	-49.22	-13.0	36.22	225
5	4120.5	-52.28	5.20	11.15	vertical	-48.48	-13.0	35.48	135
6	4944.6	-51.49	5.50	11.95	vertical	-47.19	-13.0	34.19	225
7	5768.7	-53.53	5.70	13.55	vertical	-47.83	-13.0	34.83	90
8	6592.8	-49.00	6.30	13.75	vertical	-43.70	-13.0	30.70	90
9	7416.9	-45.85	6.80	13.85	vertical	-40.95	-13.0	27.95	45
10	8241.0	-46.71	6.90	14.25	vertical	-41.51	-13.0	28.51	180

Note: 1.The other Spurious RF Radiated emissions level is no more than noise floor.

2.The worst emission was found in the antenna is vertical position.

NB-IOT Band 5 CH-Middle

Harmonic	Frequency (MHz)	SG (dBm)	Cable Loss (dB)	Gain (dBi)	Antenna Polarization	ERP Level (dBm)	Limit (dBm)	Margin (dB)	Azimuth (deg)
2	1673.0	-50.41	2.00	10.75	vertical	-43.81	-13.0	30.81	45
3	2509.5	-54.13	2.51	11.05	vertical	-47.74	-13.0	34.74	45
4	3346.0	-54.15	4.20	11.15	vertical	-49.35	-13.0	36.35	180
5	4182.5	-52.83	5.20	11.15	vertical	-49.03	-13.0	36.03	315
6	5019.0	-52.27	5.50	11.95	vertical	-47.97	-13.0	34.97	135
7	5855.5	-51.23	5.70	13.55	vertical	-45.53	-13.0	32.53	225
8	6692.0	-51.64	6.30	13.75	vertical	-46.34	-13.0	33.34	90
9	7528.5	-46.57	6.80	13.85	vertical	-41.67	-13.0	28.67	180
10	8365.0	-48.16	6.90	14.25	vertical	-42.96	-13.0	29.96	45

Note: 1.The other Spurious RF Radiated emissions level is no more than noise floor.

2.The worst emission was found in the antenna is vertical position.

NB-IOT Band 5 CH-High

Harmonic	Frequency (MHz)	SG (dBm)	Cable Loss (dB)	Gain (dBi)	Antenna Polarization	ERP Level (dBm)	Limit (dBm)	Margin (dB)	Azimuth (deg)
2	1697.8	-46.04	2.00	10.75	vertical	-39.44	-13.0	26.4	180
3	2546.7	-55.09	2.51	11.05	vertical	-48.70	-13.0	35.7	45
4	3395.6	-54.79	4.20	11.15	vertical	-49.99	-13.0	37.0	0
5	4244.5	-53.50	5.20	11.15	vertical	-49.70	-13.0	36.7	135
6	5093.4	-48.96	5.50	11.95	vertical	-44.66	-13.0	31.7	225
7	5942.3	-52.54	5.70	13.55	vertical	-46.84	-13.0	33.8	90
8	6791.2	-50.53	6.30	13.75	vertical	-45.23	-13.0	32.2	225
9	7640.1	-44.95	6.80	13.85	vertical	-40.05	-13.0	27.1	180
10	8489.0	-47.16	6.90	14.25	vertical	-41.96	-13.0	29.0	270

Note: 1.The other Spurious RF Radiated emissions level is no more than noise floor.

2.The worst emission was found in the antenna is vertical position.

6. Main Test Instruments

Date of Testing: August 4, 2017 ~ August 18, 2017

Name	Manufacturer	Type	Serial Number	Calibration Date	Expiration Time
Base Station Simulator	R&S	CMW500	150415	2017-05-14	2018-05-13
Power Splitter	Hua Xiang	SHX-GF2-2-13	10120101	2017-05-14	2018-05-13
Spectrum Analyzer	Agilent	N9010A	MY47191109	2017-05-20	2018-05-19
Universal Radio Communication Tester	Agilent	E5515C	MY48367192	2017-05-20	2018-05-19
Signal Analyzer	R&S	FSV30	100815	2016-12-16	2017-12-15
EMI Test Receiver	R&S	ESCI	100948	2017-05-20	2018-05-19
Signal generator	R&S	SMB 100A	102594	2017-05-14	2018-05-13
Signal generator	R&S	SMR27	100365	2017-05-14	2018-05-13
Trilog Antenna	SCHWARZBECK	VUBL 9163	9163-201	2014-12-06	2017-12-05
Horn Antenna	R&S	HF907	100126	2014-12-06	2017-12-05
Horn Antenna	ETS-Lindgren	3160-09	00102644	2015-01-30	2018-01-29
Climatic Chamber	Re Ce	PT-30B	20101891	2015-07-18	2018-07-17
RF Cable	Agilent	SMA 15cm	0001	2017-02-06	2017-08-05
Preamplifier	R&S	SCU18	102327	2017-06-18	2018-06-17



Date of Testing: April 2, 2020 ~ April 9, 2020

Name	Manufacturer	Type	Serial Number	Calibration Date	Expiration Date
Base Station Simulator	R&S	CMW500	113824	2019-05-19	2020-05-18
Power Splitter	Hua Xiang	SHX-GF2-2-13	10120101	/	/
Spectrum Analyzer	Key sight	N9010A	MY50210259	2019-05-19	2020-05-18
Universal Radio Communication Tester	Key sight	E5515C	MY48367192	2019-05-19	2020-05-18
Signal Analyzer	R&S	FSV30	100815	2019-12-15	2020-12-14
Loop Antenna	SCHWARZBECK	FMZB1519	1519-047	2017-09-26	2020-09-25
Trilog Antenna	SCHWARZBECK	VUBL 9163	9163-201	2017-11-18	2020-11-17
Horn Antenna	R&S	HF907	100126	2018-07-07	2020-07-06
Horn Antenna	ETS-Lindgren	3160-09	00102643	2018-06-20	2020-06-19
Signal generator	R&S	SMB 100A	102594	2019-05-19	2020-05-18
Climatic Chamber	ESPEC	SU-242	93000506	2017-12-17	2020-12-16
Preamplifier	R&S	SCU18	102327	2019-05-19	2020-05-18
MOB COMMS DC SUPPLY	Keysight	66319D	MY43004105	2019-05-20	2020-05-21
RF Cable	Agilent	SMA 15cm	0001	2019-12-13	2020-6-12
Software	R&S	EMC32	9.26.0	/	/
Wireless Test Set	StarPoint	SP8315	SP8315-1202	2019-05-19	2020-05-18
Wireless Test Set	StarPoint	SP8315	SP8315-1203	2019-05-19	2020-05-18



Date of Testing: July 13, 2020

Name	Manufacturer	Type	Serial Number	Calibration Date	Expiration Date
Base Station Simulator	R&S	CMW500	113824	2020-05-18	2021-05-17
Power Splitter	Hua Xiang	SHX-GF2-2-13	10120101	/	/
Spectrum Analyzer	Key sight	N9010A	MY50210259	2020-05-18	2021-05-17
Universal Radio Communication Tester	Key sight	E5515C	MY48367192	2020-05-27	2021-05-26
Signal Analyzer	R&S	FSV30	100815	2019-12-15	2020-12-14
Loop Antenna	SCHWARZBECK	FMZB1519	1519-047	2017-09-26	2020-09-25
Trilog Antenna	SCHWARZBECK	VUBL 9163	9163-201	2017-11-18	2020-11-17
Horn Antenna	R&S	HF907	102723	2018-08-11	2021-08-10
Horn Antenna	ETS-Lindgren	3160-09	00102643	2018-06-20	2021-06-19
Signal generator	R&S	SMB 100A	102594	2020-05-18	2021-05-17
Climatic Chamber	ESPEC	SU-242	93000506	2017-12-17	2020-12-16
Preamplifier	R&S	SCU18	102327	2020-05-18	2021-05-17
MOB COMMS DC SUPPLY	Keysight	66319D	MY43004105	2020-05-18	2021-05-17
RF Cable	Agilent	SMA 15cm	0001	2020-06-12	2020-12-11
Software	R&S	EMC32	9.26.0	/	/
Wireless Test Set	StarPoint	SP8315	SP8315-1202	2020-05-18	2021-05-17
Wireless Test Set	StarPoint	SP8315	SP8315-1203	2020-05-18	2021-05-17

ANNEX A: Product Change Description



BG96 R1.1 & BG96 R1.2 Differences Statement

LTE Module Series

PCB Rev.: R1.2

Date: 2018-10-08



www.quectel.com

Build a Smarter World



Based on BG96 R1.1, BG96 R1.2 has enabled VDD_QFPROM_PRG hardware interface, which is connected to ground directly in BG96 R1.1, so as to support secure boot feature.

Some points are highlighted as below:

- BG96 R1.1 and R1.2 versions share the same hardware architecture and key components.
- BG96 R1.1 and R1.2 versions share the same pinout placements.
- Secure boot is enabled through a set of hardware fuses in BG96 R1.2. For the code to be executed, it must be signed by the trusted entity identified in the hardware fuses, so we have to enable VDD_QFPROM_PRG hardware interface.
- The new hardware will be used with the new software baseline TX3.0, and the software version is R04Axx.

The details are illustrated as below:

1. What's Secure Boot

Secure boot refers to the bootup sequence that establishes a trusted platform for secure applications. It starts as an immutable sequence that validates the origin of the code using cryptographic authentication so only authorized software can be executed. The bootup sequence places the device in a known security state and protects against binary manipulation of software and reflashing attacks.

A secure boot system adds cryptographic checks to each stage of the boot up process. This process asserts the authenticity of all secure software images that are executed by the device. This additional check prevents any unauthorized or maliciously modified software from running on the device. Secure boot is enabled through a set of hardware fuses. For the code to be executed, it must be signed by the trusted entity identified in the hardware fuses.

In simple terms, secure boot ensures running of signed/authorized software on the module, and unsigned/unauthorized software will not be allowed to run.

2. Enabled VDD_QFPROM_PRG Hardware Interface

A. BG96 R1.1 does not support secure boot function

The VDD_QFPROM_PRG (N19) pin of baseband chip is for secure boot function. In BG96 R1.1, this pin is connected to ground directly, which means secure boot function is disabled.

B. BG96 R1.2 supports secure boot function

According to Qualcomm's suggestion and our customers' requirements, the VDD_QFPROM_PRG pin is connected to VREG_L3_1P8(1.8V) in BG96 R1.2 so as to enable secure boot function.

The following pictures show the schematic and PCB designs of BG96 R1.1 and R1.2.

Build a Smarter World



Figure 1: Schematic Designs of BG96 R1.1 and R1.2

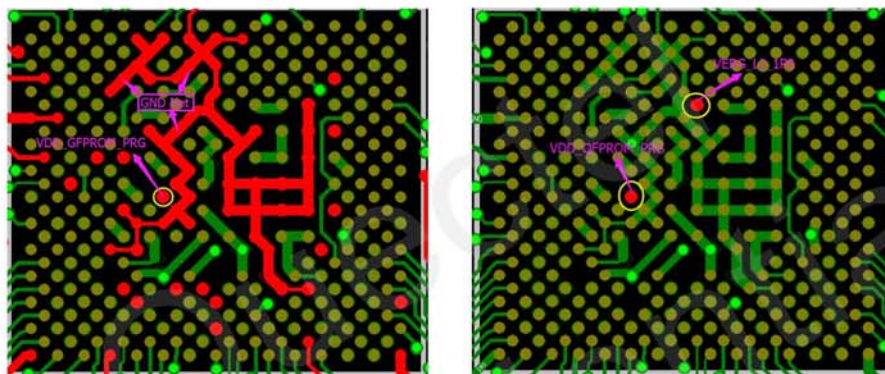

Figure 2: PCB Designs of BG96 R1.1 and R1.2

3. TX2.0 vs TX3.0

The biggest difference of TX3.0 as compared with TX2.0 lies in the adding of VoLTE and handover features. Since VoLTE environment has not been built so maturely yet, the main concern of customers is the handover function.

For TX2.0, re-selection is supported, while handover is not supported.

BG96 supports re-selection mechanism, which means when disconnection happens during cell handover, the module will reconnect automatically. This process lasts for about 1 (or 2) seconds, and the data transmitted (may happen by coincidence) will be buffered and resent once the reconnection established. So, the disconnection is generally imperceptible to customers.

- If the data transmission occurs at the moment that cell handover occurs coincidentally, the connection is kept with handover function; the connection is broken and re-connection established in about 1 (or 2) seconds with re-selection. This causes nearly no difference for data telematics because users even cannot feel this disconnection, whereas VoLTE might be affected because of the short time disconnection.



Build a Smarter World



- If the data transmission occurs in the period that no cell alternates, then no any influence will be caused.

Quectel
Confidential

*****END OF REPORT *****