

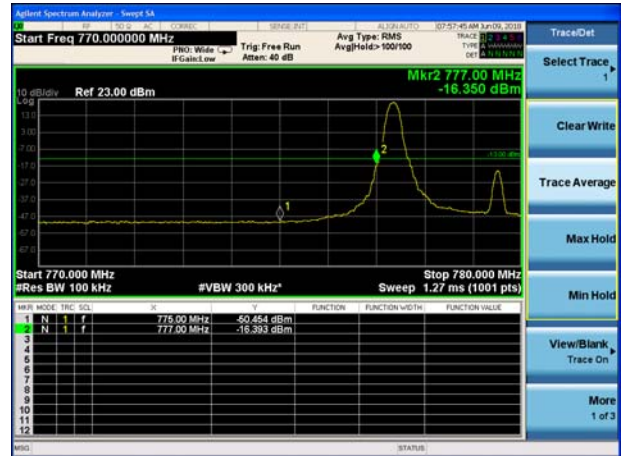

LTE Band 13 QPSK 5MHz CH-Low, 1 RB (763MHz ~775MHz)



LTE Band 13 QPSK 5MHz CH-Low, 1 RB (775MHz ~777MHz)



LTE Band 13 QPSK 5MHz CH-High, 1 RB (787MHz ~793MHz)

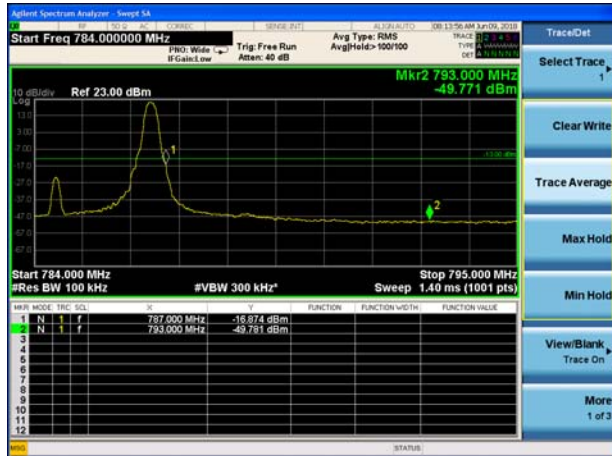

LTE Band 13 QPSK 5MHz CH-High, 1 RB (793MHz ~805MHz)





LTE Band 13 QPSK 5MHz CH-Low, 100%RB (763MHz ~775MHz)



LTE Band 13 QPSK 5MHz CH-Low, 100%RB (775MHz ~777MHz)



LTE Band 13 QPSK 5MHz CH-High, 100%RB (787MHz ~793MHz)



LTE Band 13 QPSK 5MHz CH-High, 100%RB (793MHz ~805MHz)





LTE Band 13 QPSK 10MHz CH-Low, 1 RB (763MHz ~775MHz)



LTE Band 13 QPSK 10MHz CH-Low, 1 RB (775MHz ~777MHz)



LTE Band 13 QPSK 10MHz CH-High, 1 RB (787MHz ~793MHz)

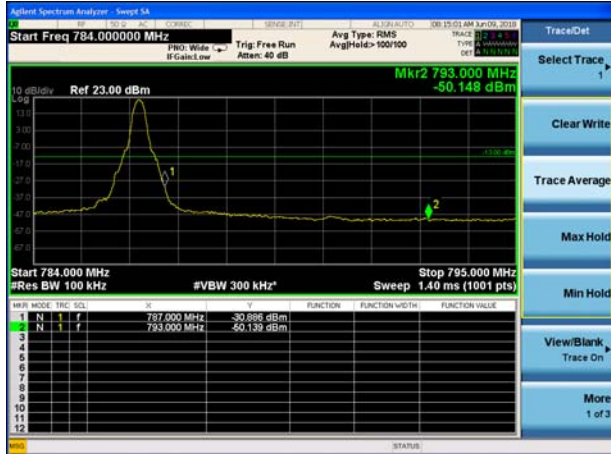

LTE Band 13 QPSK 10MHz CH-High, 1 RB (793MHz ~805MHz)



LTE Band 13 QPSK 10MHz CH-Low, 100%RB
(763MHz ~775MHz)



LTE Band 13 QPSK 10MHz CH-Low, 100%RB
(775MHz ~777MHz)



LTE Band 13 QPSK 10MHz CH-High, 100%RB
(787MHz ~793MHz)



LTE Band 13 QPSK 10MHz CH-High, 100%RB
(793MHz ~805MHz)



LTE Band 13 16QAM 5MHz CH-Low, 1 RB
(763MHz ~775MHz)



LTE Band 13 16QAM 5MHz CH-Low, 1 RB
(775MHz ~777MHz)

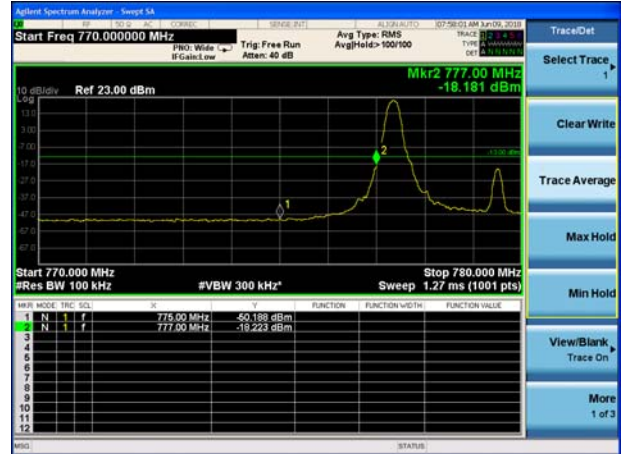

LTE Band 13 16QAM 5MHz CH-High, 1 RB
(787MHz ~793MHz)

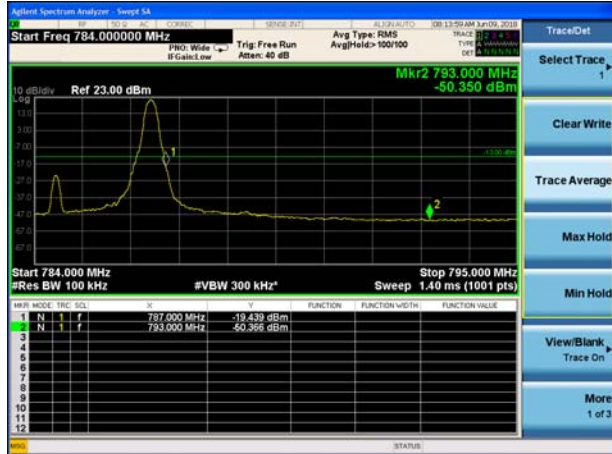

LTE Band 13 16QAM 5MHz CH-High, 1 RB
(793MHz ~805MHz)



LTE Band 13 16QAM 10MHz CH-Low, 1 RB
(763MHz ~775MHz)

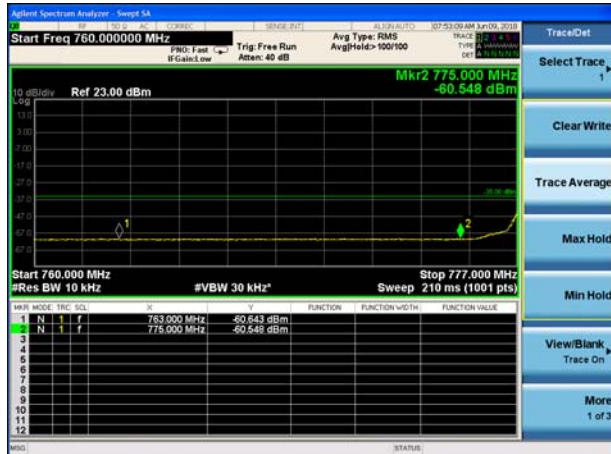

LTE Band 13 16QAM 10MHz CH-Low, 1 RB
(775MHz ~777MHz)

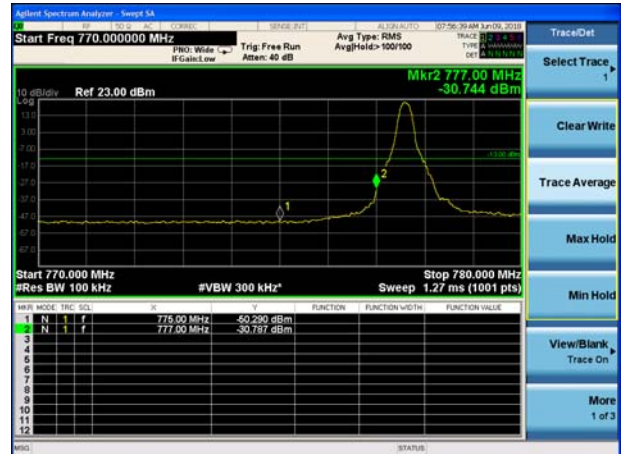

LTE Band 13 16QAM 10MHz CH-High, 1 RB
(787MHz ~793MHz)

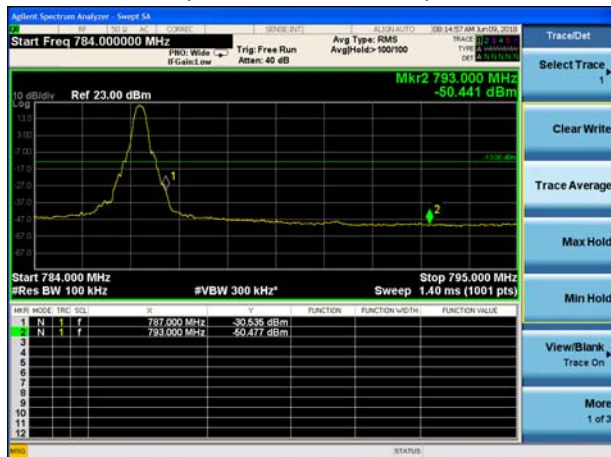

LTE Band 13 16QAM 10MHz CH-High, 1 RB
(793MHz ~805MHz)

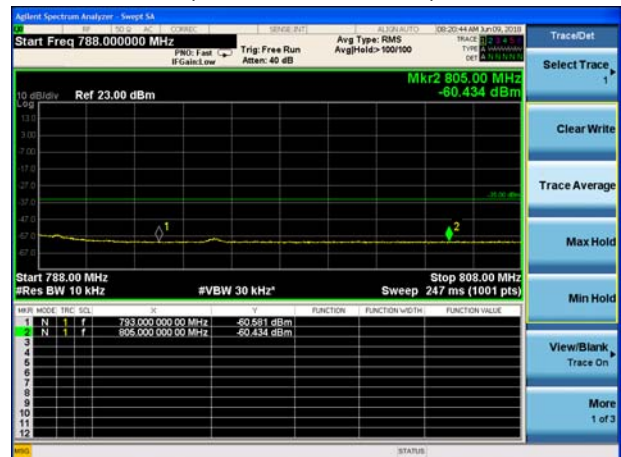

5.5 Peak-to-Average Power Ratio (PAPR)

Ambient condition

Temperature	Relative humidity	Pressure
23°C ~25°C	45%~50%	101.5kPa

Methods of Measurement

Measure the total peak power and record as PPk. And measure the total average power and record as PAvg. Both the peak and average power levels must be expressed in the same logarithmic units (e.g., dBm). Determine the PAPR from:

$$PAPR (dB) = PPk (dBm) - PAvg (dBm).$$

Test Setup

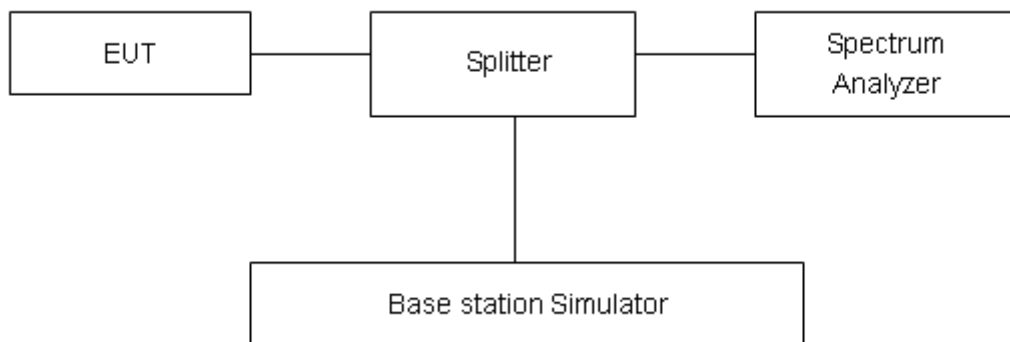

Limits

Rule Part 27.50(d)(5) Equipment employed must be authorized in accordance with the provisions of 24.51. Power measurements for transmissions by stations authorized under this section may be made either in accordance with a Commission-approved average power technique or in compliance with paragraph (d)(6) of this section. In measuring transmissions in this band using an average power technique, the peak-to-average ratio (PAR) of the transmission may not exceed 13 dB.

Measurement Uncertainty

The assessed measurement uncertainty to ensure 95% confidence level for the normal distribution is with the coverage factor k = 2, U= 0.4 dB.

Test Results

WCDMA Band IV	Channel	Frequency (MHz)	Peak (dBm)	Avg (dBm)	PAPR (dB)	Limit (dB)	Conclusion
RMC	1312	1712.4	26.69	23.57	3.12	≤13	PASS
	1413	1732.6	26.78	23.56	3.22	≤13	PASS
	1513	1752.6	26.33	23.51	2.82	≤13	PASS

LTE Band 4								
Modulation	Bandwidth (MHz)	Channel	Frequency (MHz)	Peak (dBm)	Avg (dBm)	PAPR (dB)	Limit (dB)	Conclusion
QPSK	1.4	19957	1710.7	28.43	23.06	5.37	≤13	PASS
		20175	1732.5	28.31	22.95	5.36	≤13	PASS
		20393	1754.3	28.39	22.98	5.41	≤13	PASS
	3	19965	1711.5	27.92	22.79	5.13	≤13	PASS
		20175	1732.5	28.21	23.06	5.15	≤13	PASS
		20385	1753.5	28.13	22.93	5.20	≤13	PASS
	5	19975	1712.5	28.31	22.77	5.54	≤13	PASS
		20175	1732.5	28.54	23.05	5.49	≤13	PASS
		20375	1752.5	28.51	22.91	5.60	≤13	PASS
	10	20000	1715	28.02	22.85	5.17	≤13	PASS
		20175	1732.5	28.18	23.07	5.11	≤13	PASS
		20350	1750	28.17	22.95	5.22	≤13	PASS
	15	20025	1717.5	29.16	22.83	6.33	≤13	PASS
		20175	1732.5	29.36	23.03	6.33	≤13	PASS
		20325	1747.5	29.30	22.90	6.40	≤13	PASS
20	20050	1720	28.99	22.80	6.19	≤13	PASS	
	20175	1732.5	29.18	22.98	6.20	≤13	PASS	
	20300	1745	29.17	22.86	6.31	≤13	PASS	
16QAM	1.4	19957	1710.7	29.81	23.39	6.42	≤13	PASS
		20175	1732.5	29.39	23.01	6.38	≤13	PASS
		20393	1754.3	29.41	22.93	6.48	≤13	PASS
	3	19965	1711.5	29.11	22.89	6.22	≤13	PASS
		20175	1732.5	28.83	22.67	6.16	≤13	PASS
		20385	1753.5	29.90	23.60	6.30	≤13	PASS
	5	19975	1712.5	28.13	22.66	5.47	≤13	PASS
		20175	1732.5	28.84	22.92	5.92	≤13	PASS
		20375	1752.5	28.50	23.45	5.05	≤13	PASS
	10	20000	1715	29.16	22.88	6.28	≤13	PASS
		20175	1732.5	28.06	22.66	5.40	≤13	PASS
		20350	1750	28.68	23.59	5.09	≤13	PASS

	15	20025	1717.5	28.11	22.83	5.28	≤13	PASS
		20175	1732.5	28.46	22.64	5.82	≤13	PASS
		20325	1747.5	29.47	23.57	5.90	≤13	PASS
	20	20050	1720	29.53	22.81	6.72	≤13	PASS
		20175	1732.5	29.58	22.60	6.98	≤13	PASS
		20300	1745	29.42	23.52	5.90	≤13	PASS

LTE Band 12								
Modulation	Bandwidth (MHz)	Channel	Frequency (MHz)	Peak (dBm)	Avg (dBm)	PAPR (dB)	Limit (dB)	Conclusion
QPSK	1.4	23017	699.7	28.93	22.70	6.23	≤13	PASS
		23095	707.5	29.11	22.78	6.33	≤13	PASS
		23173	715.3	29.61	22.83	6.78	≤13	PASS
	3	23025	700.5	29.81	22.85	6.96	≤13	PASS
		23095	707.5	29.14	22.93	6.21	≤13	PASS
		23165	714.5	29.37	22.99	6.38	≤13	PASS
	5	23035	701.5	29.98	22.83	7.15	≤13	PASS
		23095	707.5	29.62	22.89	6.73	≤13	PASS
		23155	713.5	29.69	22.94	6.75	≤13	PASS
	10	23060	704	30.81	22.80	8.01	≤13	PASS
		23095	707.5	29.19	22.84	6.35	≤13	PASS
		23130	711	29.24	22.90	6.34	≤13	PASS
16QAM	1.4	23017	699.7	30.96	23.53	7.43	≤13	PASS
		23095	707.5	30.33	23.16	7.17	≤13	PASS
		23173	715.3	30.29	22.71	7.58	≤13	PASS
	3	23025	700.5	30.01	22.59	7.42	≤13	PASS
		23095	707.5	30.71	23.27	7.44	≤13	PASS
		23165	714.5	29.94	22.84	7.10	≤13	PASS
	5	23035	701.5	29.53	22.54	6.99	≤13	PASS
		23095	707.5	30.74	23.25	7.49	≤13	PASS
		23155	713.5	30.27	22.82	7.45	≤13	PASS
	10	23060	704	30.27	22.52	7.75	≤13	PASS
		23095	707.5	30.30	23.21	7.09	≤13	PASS
		23130	711	30.28	22.77	7.51	≤13	PASS

LTE Band 13								
Modulation	Bandwidth (MHz)	Channel	Frequency (MHz)	Peak (dBm)	Avg (dBm)	PAPR (dB)	Limit (dB)	Conclusion
QPSK	5	23205	779.5	29.31	22.76	6.55	≤13	PASS
		23230	782	30.14	22.78	7.36	≤13	PASS
		23255	784.5	29.72	22.89	6.83	≤13	PASS
	10	23230	782	28.43	22.74	5.69	≤13	PASS
16QAM	5	23205	779.5	29.04	22.88	6.16	≤13	PASS
		23230	782	28.95	22.86	6.09	≤13	PASS
		23255	784.5	29.33	22.46	6.87	≤13	PASS
	10	23230	782	29.64	22.98	6.66	≤13	PASS

5.6 Frequency Stability

Ambient condition

Temperature	Relative humidity	Pressure
23°C ~25°C	45%~50%	101.5kPa

Method of Measurement

Frequency Stability (Temperature Variation)

The temperature inside the climate chamber is varied from -40°C to +85°C in 10°C step size.

(1) With all power removed, the temperature was decreased to -10°C and permitted to stabilize for three hours.

(2) Measure the carrier frequency with the test equipment in a “call mode”. These measurements should be made within 1 minute of powering up the mobile station, to prevent significant self warming.

(3) Repeat the above measurements at 10°C increments from -40°C to +85°C. Allow at least 1.5 hours at each temperature, un-powered, before making measurements.

Frequency Stability (Voltage Variation)

The frequency stability shall be measured with variation of primary supply voltage as follows:

(1) Vary primary supply voltage from 85 to 115 percent of the nominal value for other than hand carried battery equipment.

(2) For hand carried, battery powered equipment, reduce primary supply voltage to the battery-operating end point which shall be specified by the manufacturer.

This transceiver is specified to operate with an input voltage of between 3.3 V and 4.3 V, with a nominal voltage of 3.8V.

Test setup

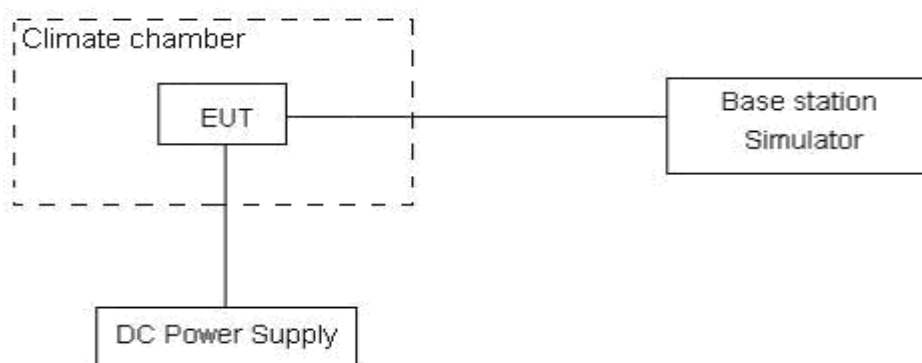

Limits

No specific frequency stability requirements in part 27.54

Measurement Uncertainty

The assessed measurement uncertainty to ensure 99.75% confidence level for the normal distribution is with the coverage factor $k = 3, U=0.01\text{ppm}$.

Test Result

WCDMA Band IV					
(QPSK, 20MHz BANDWIDTH)					
Condition		1710	1755	Delta (Hz)	Frequency Stability(ppm)
Temperature	Voltage	F low@-13dBm(MHz)	F high@-13dBm(MHz)		
Normal (25°C)	Normal	1710.0287	1754.9121	-1.38	-0.00073
Extreme (85°C)		1710.0289	1754.9120	2.15	0.00115
Extreme (80°C)		1710.0284	1754.9124	1.05	0.00056
Extreme (70°C)		1710.0299	1754.9109	1.39	0.00074
Extreme (60°C)		1710.0280	1754.9130	0.82	0.00043
Extreme (50°C)		1710.0277	1754.9131	-1.40	-0.00074
Extreme (40°C)		1710.0292	1754.9116	-1.42	-0.00076
Extreme (30°C)		1710.0281	1754.9127	-1.45	-0.00077
Extreme (20°C)		1710.0279	1754.9130	-2.26	-0.00120
Extreme (10°C)		1710.0294	1754.9114	0.17	0.00009
Extreme (0°C)		1710.0285	1754.9123	-2.53	-0.00135
Extreme (-10°C)		1710.0299	1754.9130	-1.15	-0.00061
Extreme (-20°C)		1710.0331	1754.9161	2.38	0.00127
Extreme (-30°C)		1710.0347	1754.9183	1.28	0.00068
Extreme (-40°C)		1710.0353	1754.9195	1.62	0.00086
25°C	LV	1710.0324	1754.9155	-1.17	-0.00062
	HV	1710.0311	1754.9164	-1.19	-0.00063

LTE Band 4					
(QPSK, 20MHz BANDWIDTH)					
Condition		1710	1755	Delta (Hz)	Frequency Stability(ppm)
Temperature	Voltage	F low@-13dBm(MHz)	F high@-13dBm(MHz)		
Normal (25°C)	Normal	1710.6556	1754.4320	3.01	0.00174
Extreme (85°C)		1710.6567	1754.4332	-1.78	-0.00103
Extreme (80°C)		1710.6534	1754.4293	-0.43	-0.00025
Extreme (70°C)		1710.6547	1754.4312	2.52	0.00145
Extreme (60°C)		1710.6533	1754.4303	-2.60	-0.00150
Extreme (50°C)		1710.6539	1754.4304	-0.33	-0.00019
Extreme (40°C)		1710.6552	1754.4317	2.18	0.00126
Extreme (30°C)		1710.6559	1754.4324	0.55	0.00032
Extreme (20°C)		1710.6541	1754.4303	4.58	0.00264
Extreme (10°C)		1710.6550	1754.4315	3.12	0.00180
Extreme (0°C)		1710.6537	1754.4302	0.49	0.00028
Extreme (-10°C)		1710.6532	1754.4297	-0.43	-0.00025



Extreme (-20°C)		1710.6543	1754.4309	-2.60	-0.00150
Extreme (-30°C)		1710.6576	1754.4341	-0.33	-0.00019
Extreme (-40°C)		1710.6594	1754.4353	4.58	0.00264
25°C	LV	1710.6540	1754.4305	-1.28	-0.00074
	HV	1710.6546	1754.4311	-0.27	-0.00016
(16QAM,20MHz BANDWIDTH)					
Condition		1710	1755	Delta (Hz)	Frequency Stability(ppm)
Temperature	Voltage	F low@-13dBm(MHz)	F high@-13dBm(MHz)		
Normal (25°C)	Normal	1710.6405	1754.5123	5.32	0.00307
Extreme (85°C)		1710.6387	1754.5112	1.28	0.00074
Extreme (80°C)		1710.6426	1754.5151	-0.41	-0.00024
Extreme (70°C)		1710.6407	1754.5132	3.52	0.00203
Extreme (60°C)		1710.6421	1754.5146	1.62	0.00094
Extreme (50°C)		1710.6415	1754.5140	1.15	0.00066
Extreme (40°C)		1710.6402	1754.5127	-0.27	-0.00016
Extreme (30°C)		1710.6395	1754.5120	-3.42	-0.00197
Extreme (20°C)		1710.6416	1754.5141	3.35	0.00193
Extreme (10°C)		1710.6404	1754.5129	0.76	0.00044
Extreme (0°C)		1710.6417	1754.5142	-0.25	-0.00015
Extreme (-10°C)		1710.6422	1754.5147	1.28	0.00074
Extreme (-20°C)		1710.6411	1754.5136	-0.41	-0.00024
Extreme (-30°C)		1710.6381	1754.5103	1.62	0.00094
Extreme (-40°C)		1710.6366	1754.5091	-0.27	-0.00016
25°C	LV	1710.6414	1754.5139	2.66	0.00153
	HV	1710.6409	1754.5133	4.17	0.00241

LTE Band 12					
(QPSK, 20MHz BANDWIDTH)					
Condition		699	716	Delta (Hz)	Frequency Stability(ppm)
Temperature	Voltage	F low@-13dBm(MHz)	F high@-13dBm(MHz)		
Normal (25°C)	Normal	699.2578	715.7329	3.48	0.00416
Extreme (85°C)		699.2589	715.7317	2.84	0.00339
Extreme (80°C)		699.2550	715.7278	1.86	0.00222
Extreme (70°C)		699.2569	715.7297	2.81	0.00336
Extreme (60°C)		699.2555	715.7283	-0.98	-0.00117
Extreme (50°C)		699.2561	715.7289	0.75	0.00089
Extreme (40°C)		699.2574	715.7302	1.74	0.00208
Extreme (30°C)		699.2581	715.7309	1.49	0.00178
Extreme (20°C)		699.2560	715.7288	-0.94	-0.00113

Extreme (10°C)		699.2572	715.7300	-0.10	-0.00012
Extreme (0°C)		699.2559	715.7287	-1.85	-0.00221
Extreme (-10°C)		699.2554	715.7282	-2.80	-0.00335
Extreme (-20°C)		699.2565	715.7293	-2.72	-0.00325
Extreme (-30°C)		699.2598	715.7330	0.13	0.00016
Extreme (-40°C)		699.2610	715.7338	1.19	0.00142
25°C	LV	699.2562	715.7290	3.32	0.00397
	HV	699.2568	715.7301	1.79	0.00214
(16QAM,20MHz BANDWIDTH)					
Condition		699	716	Delta (Hz)	Frequency Stability(ppm)
Temperature	Voltage	F low@-13dBm(MHz)	F high@-13dBm(MHz)		
Normal (25°C)	Normal	699.3124	715.6811	0.69	0.00082
Extreme (85°C)		699.3113	715.6800	1.13	0.00135
Extreme (80°C)		699.3152	715.6839	1.35	0.00161
Extreme (70°C)		699.3133	715.6820	-1.74	-0.00208
Extreme (60°C)		699.3147	715.6834	2.05	0.00245
Extreme (50°C)		699.3141	715.6828	2.81	0.00336
Extreme (40°C)		699.3128	715.6815	0.45	0.00054
Extreme (30°C)		699.3121	715.6808	6.34	0.00758
Extreme (20°C)		699.3142	715.6829	1.74	0.00208
Extreme (10°C)		699.3130	715.6817	0.02	0.00002
Extreme (0°C)		699.3143	715.6830	0.09	0.00011
Extreme (-10°C)		699.3148	715.6835	-2.79	-0.00334
Extreme (-20°C)		699.3137	715.6824	-3.89	-0.00465
Extreme (-30°C)		699.3104	715.6791	0.89	0.00106
Extreme (-40°C)		699.3092	715.6779	1.05	0.00126
25°C	LV	699.3140	715.6827	3.59	0.00430
	HV	699.3134	715.6821	2.14	0.00256

LTE Band13					
(QPSK, 20MHz BANDWIDTH)					
Condition		777	787	Delta (Hz)	Frequency Stability(ppm)
Temperature	Voltage	F low@-13dBm(MHz)	F high@-13dBm(MHz)		
Normal (25°C)	Normal	777.4400	786.5793	8.49	0.01015
Extreme (85°C)		777.4401	786.5792	6.61	0.00790
Extreme (80°C)		777.4397	786.5796	-7.31	-0.00874
Extreme (70°C)		777.4412	786.5781	2.87	0.00343
Extreme (60°C)		777.4393	786.5800	7.57	0.00905
Extreme (50°C)		777.4390	786.5803	0.81	0.00097
Extreme (40°C)		777.4405	786.5788	2.90	0.00347

Extreme (30°C)		777.4394	786.5799	-2.02	-0.00241
Extreme (20°C)		777.4391	786.5802	-4.06	-0.00485
Extreme (10°C)		777.4407	786.5786	2.22	0.00265
Extreme (0°C)		777.4398	786.5795	8.48	0.01014
Extreme (-10°C)		777.4393	786.5788	-2.19	-0.00262
Extreme (-20°C)		777.4399	786.5802	-0.42	-0.00050
Extreme (-30°C)		777.4393	786.5800	-0.61	-0.00073
Extreme (-40°C)		777.4399	786.5794	1.43	0.00171
25°C	LV	777.4393	786.5792	1.56	0.00186
	HV	777.4399	786.5781	-5.37	-0.00642
(16QAM,20MHz BANDWIDTH)					
Condition		777	787	Delta (Hz)	Frequency Stability(ppm)
Temperature	Voltage	F low@-13dBm(MHz)	F high@-13dBm(MHz)		
Normal (25°C)	Normal	777.5216	786.5049	3.01	0.00360
Extreme (85°C)		777.5217	786.5048	-1.03	-0.00123
Extreme (80°C)		777.5213	786.5052	0.23	0.00027
Extreme (70°C)		777.5228	786.5168	-0.40	-0.00048
Extreme (60°C)		777.5209	786.5056	-4.43	-0.00530
Extreme (50°C)		777.5206	786.5059	1.84	0.00220
Extreme (40°C)		777.5221	786.5044	4.73	0.00565
Extreme (30°C)		777.5210	786.5055	-5.95	-0.00711
Extreme (20°C)		777.5207	786.5058	8.12	0.00971
Extreme (10°C)		777.5223	786.5042	9.14	0.01093
Extreme (0°C)		777.5214	786.5051	-7.45	-0.00891
Extreme (-10°C)		777.5213	786.5048	2.75	0.00329
Extreme (-20°C)		777.5206	786.5168	-3.12	-0.00373
Extreme (-30°C)		777.5210	786.5055	-2.52	-0.00301
Extreme (-40°C)		777.5223	786.5042	1.75	0.00209
25°C	LV	777.5209	786.5056	-9.79	-0.01170
	HV	777.5215	786.5050	-2.67	-0.00319

5.7 Spurious Emissions at Antenna Terminals

Ambient condition

Temperature	Relative humidity	Pressure
23°C ~25°C	45%~50%	101.5kPa

Method of Measurement

The EUT was connected to Spectrum Analyzer and Base Station Simulator via power Splitter. The measurement is carried out using a spectrum analyzer. The spectrum analyzer scans from 9kHz to the 10th harmonic of the carrier. The peak detector is used.

RBW is set to 100kHz, VBW is set to 300kHz for 30MHz~1GHz

RBW is set to 1MHz, VBW is set to 3MHz for above 1GHz, Sweep is set to ATUO.

Of those disturbances below (limit – 20 dB), the mark is not required for the EUT.

The modulation mode and RB allocation refer to section 5.1, using the maximum output power configuration.

Test setup

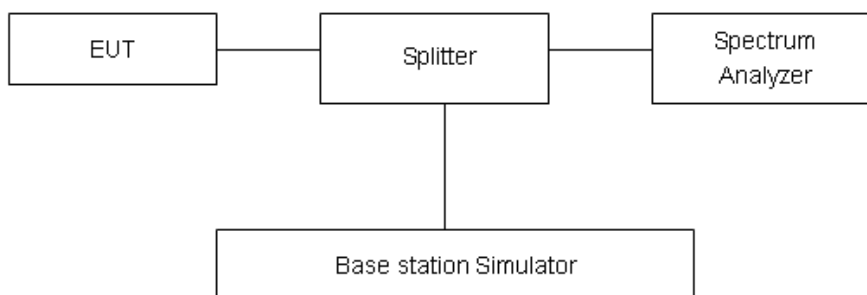

Limits

Rule Part 27.53(h) specifies that “for operations in the 1695-1710 MHz, 1710-1755 MHz, 1755-1780 MHz, 1915-1920 MHz, 1995-2000 MHz, 2000-2020 MHz, 2110-2155 MHz, 2155-2180 MHz, and 2180-2200 bands, the power of any emission outside a licensee's frequency block shall be attenuated below the transmitter power (P) in watts by at least $43 + 10 \log_{10}(P)$ dB..”

Rule Part 27.53 (g) For operations in the 600 MHz band and the 698-746 MHz band, the power of any emission outside a licensee's frequency band(s) of operation shall be attenuated below the transmitter power (P) within the licensed band(s) of operation, measured in watts, by at least $43 + 10 \log(P)$ dB. Compliance with this provision is based on the use of measurement instrumentation employing a resolution bandwidth of 100 kilohertz or greater. However, in the 100 kilohertz bands immediately outside and adjacent to a licensee's frequency block, a resolution bandwidth of at least 30 kHz may be employed.

Rule Part 27.53(f) For operations in the 746-758 MHz, 775-788 MHz, and 805-806 MHz bands, emissions in the band 1559-1610 MHz shall be limited to -70 dBW/MHz equivalent isotropically



radiated power (EIRP) for wideband signals, and -80 dBW EIRP for discrete emissions of less than 700 Hz bandwidth. For the purpose of equipment authorization, a transmitter shall be tested with an antenna that is representative of the type that will be used with the equipment in normal operation.

Part 27.53(h)/(g) Limit		-13 dBm
Part 27.53(f) Limit	Limit out of the band 1559-1610 MHz	-13 dBm
	Limit in the band 1559-1610 MHz	-40 dBm

Measurement Uncertainty

The assessed measurement uncertainty to ensure 99.75% confidence level for the normal distribution is with the coverage factor $k = 1.96$.

Frequency	Uncertainty
9kHz-1GHz	0.684 dB
1GHz-18GHz	1.407 dB

Test Result

Sweep the whole frequency band through the range from 9kHz to the 10th harmonic of the carrier, the emissions more than 20 dB below the limit are not reported.

The signal beyond the limit is carrier.

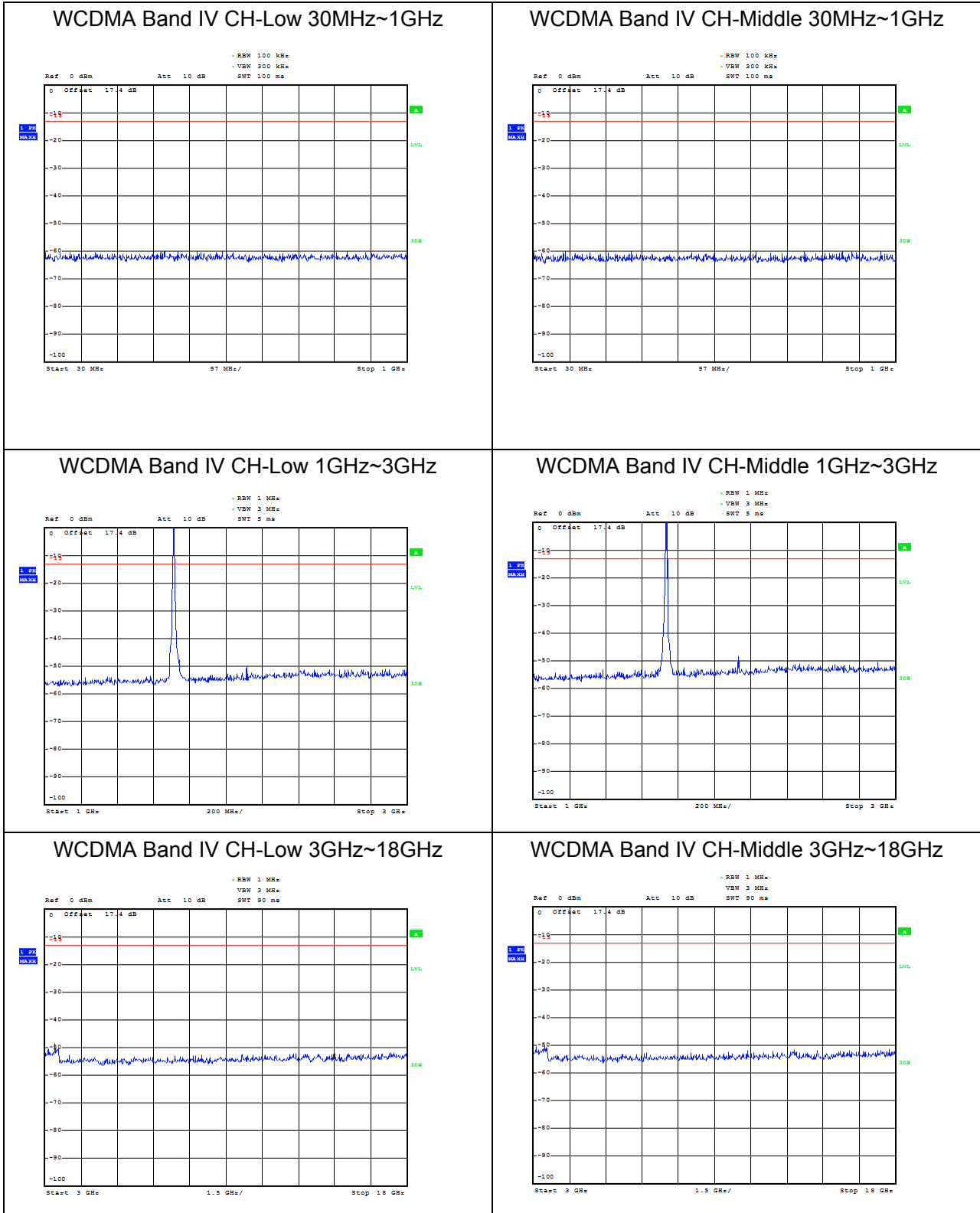



WCDMA Band IV CH-High 30MHz~1GHz

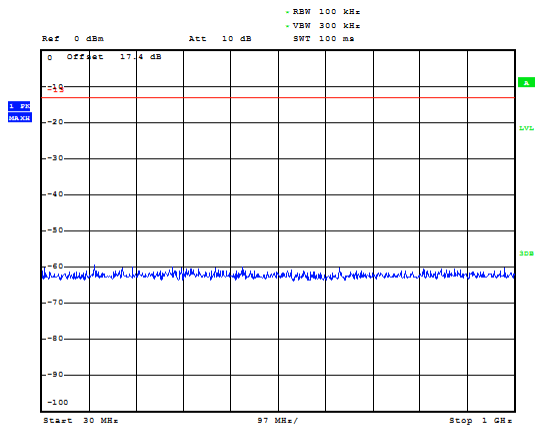

WCDMA Band IV CH-High 1GHz~3GHz

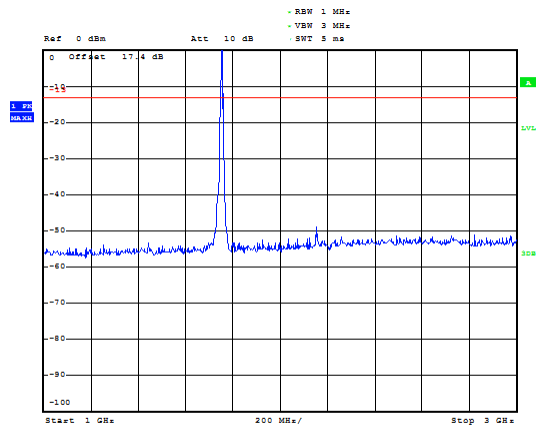

WCDMA Band IV CH-High 3GHz~18GHz

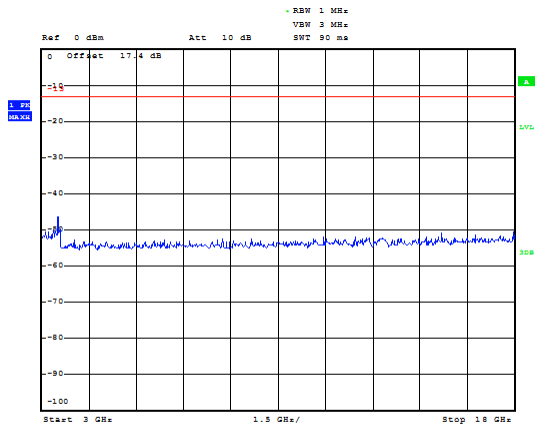



LTE Band 4 1.4MHz CH-Low 30MHz~1GHz

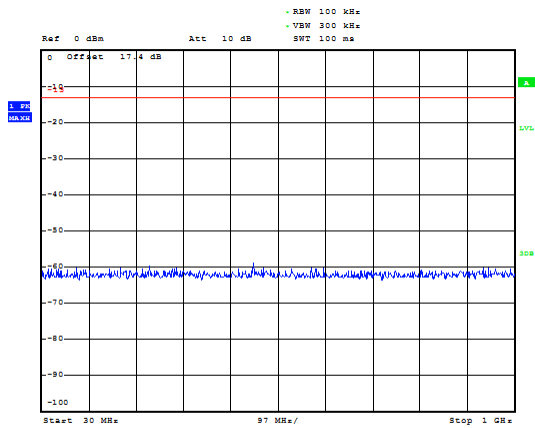

LTE Band 4 1.4MHz CH-Middle 30MHz~1GHz

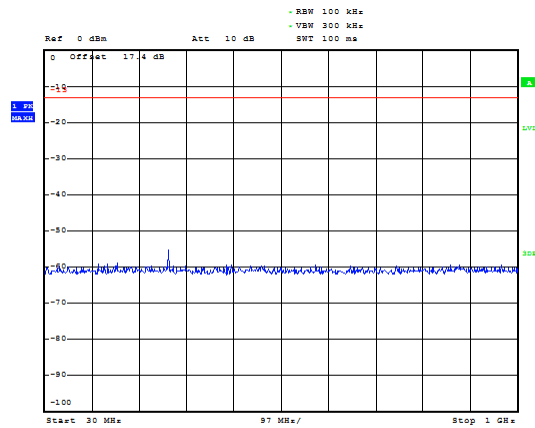

LTE Band 4 1.4MHz CH-Low 1GHz~3GHz

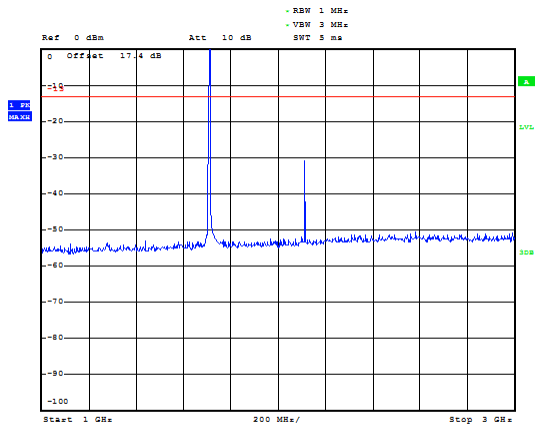

LTE Band 4 1.4MHz CH-Middle 1GHz~3GHz

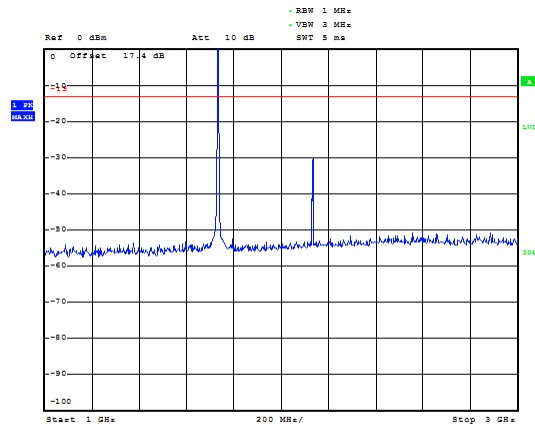

LTE Band 4 1.4MHz CH-Low 3GHz~18GHz

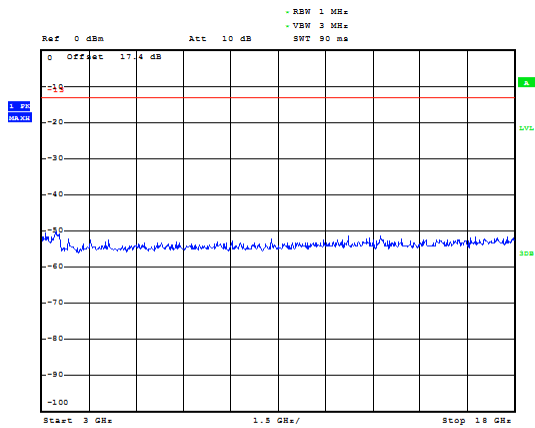

LTE Band 4 1.4MHz CH-Middle 3GHz~18GHz

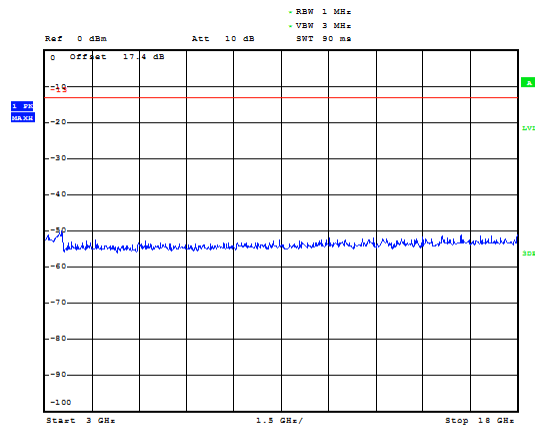



LTE Band 4 1.4MHz CH-High 30MHz~1GHz

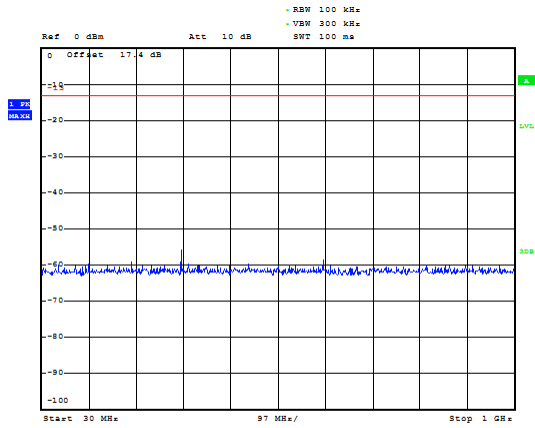

LTE Band 4 3MHz CH-Low 30MHz~1GHz

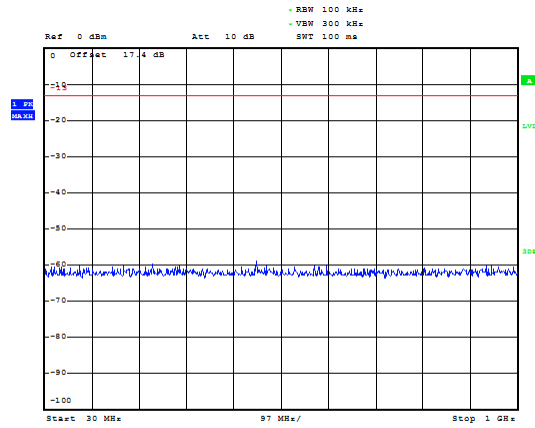

LTE Band 4 1.4MHz CH-High 1GHz~3GHz

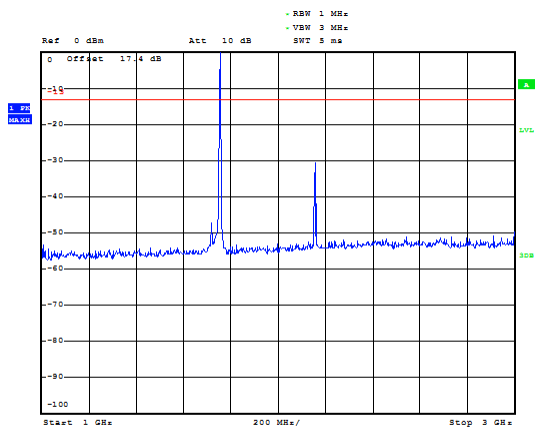

LTE Band 4 3MHz CH-Low 1GHz~3GHz

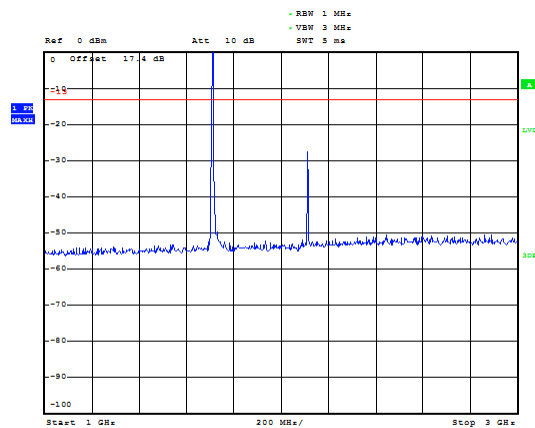

LTE Band 4 1.4MHz CH-High 3GHz~18GHz

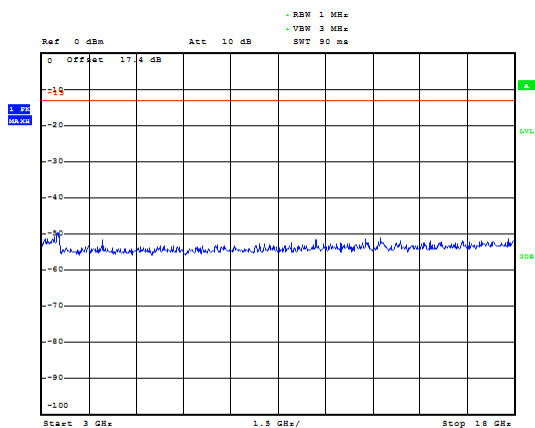

LTE Band 4 3MHz CH-Low 3GHz~18GHz

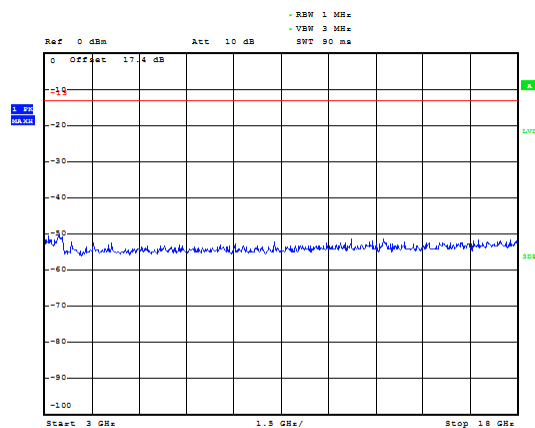



LTE Band 4 3MHz CH-Middle 30MHz~1GHz

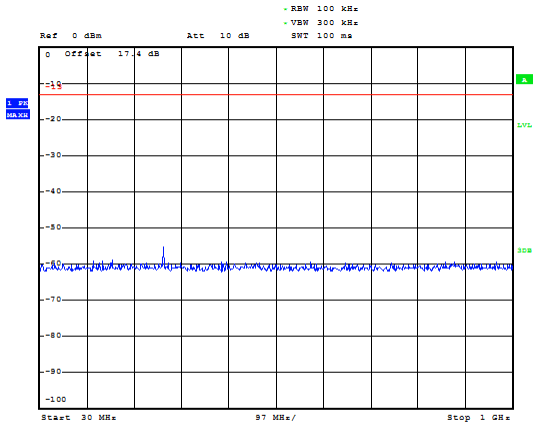

LTE Band 4 3MHz CH-High 30MHz~1GHz

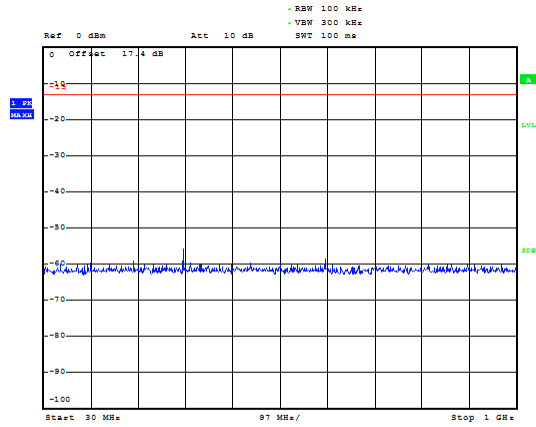

LTE Band 4 3MHz CH-Middle 1GHz~3GHz

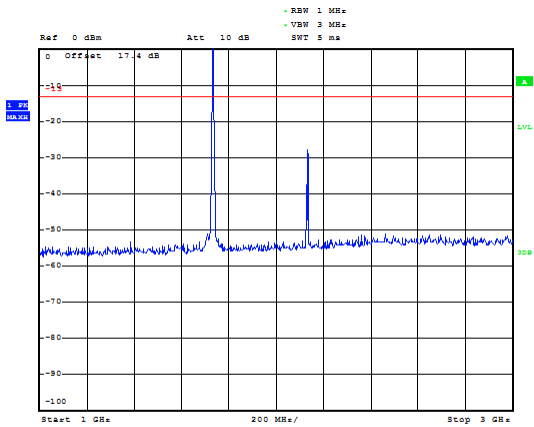

LTE Band 4 3MHz CH-High 1GHz~3GHz

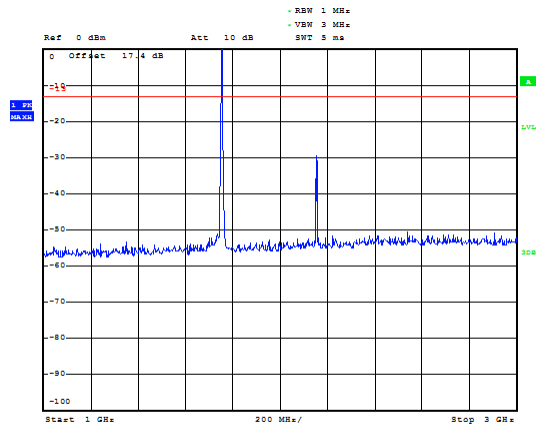

LTE Band 4 3MHz CH-Middle 3GHz~18GHz

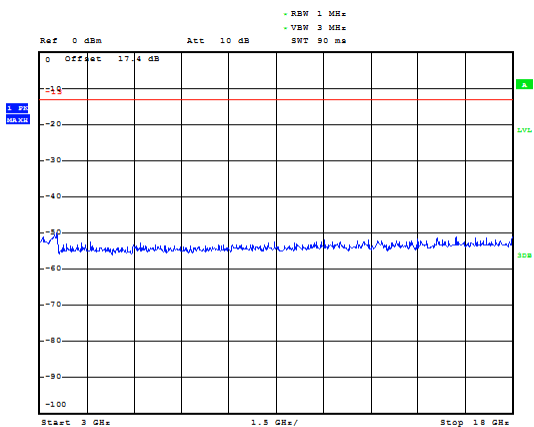

LTE Band 4 3MHz CH-High 3GHz~18GHz

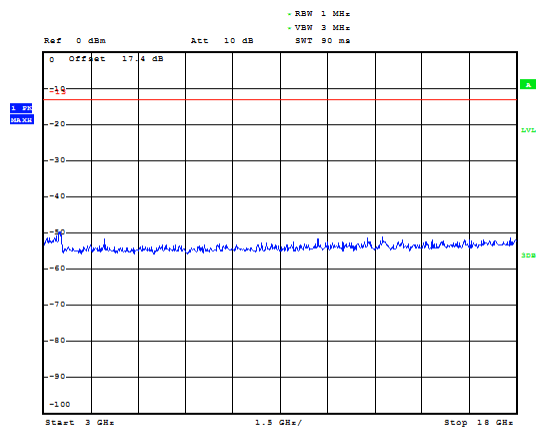



LTE Band 4 5MHz CH-Low 30MHz~1GHz

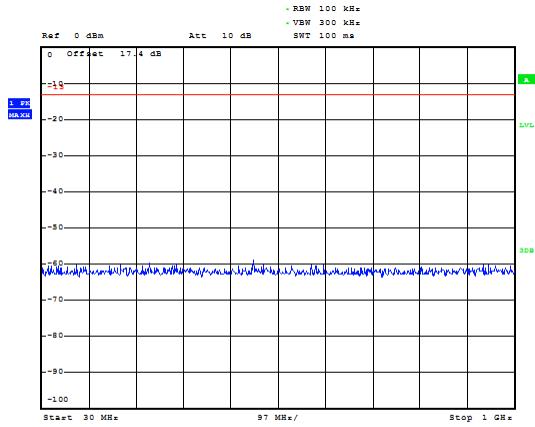

LTE Band 4 5MHz CH-Middle 30MHz~1GHz

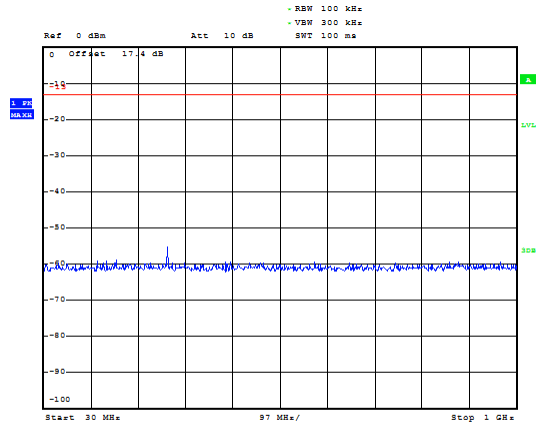

LTE Band 4 5MHz CH-Low 1GHz~3GHz

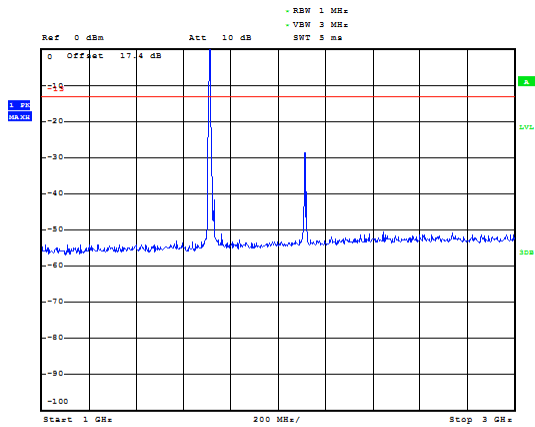

LTE Band 4 5MHz CH-Middle 1GHz~3GHz

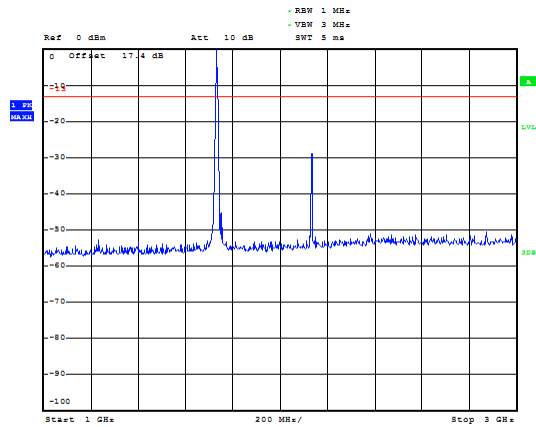

LTE Band 4 5MHz CH-Low 3GHz~18GHz

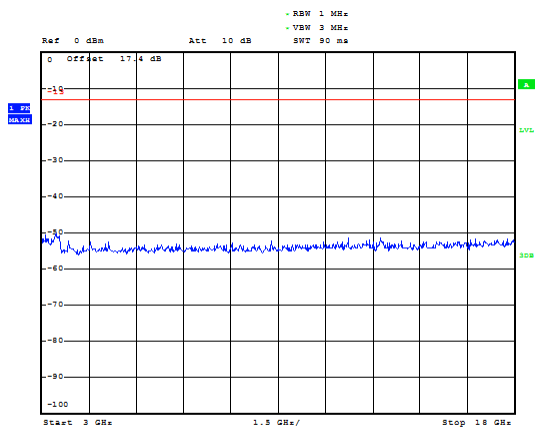

LTE Band 4 5MHz CH-Middle 3GHz~18GHz

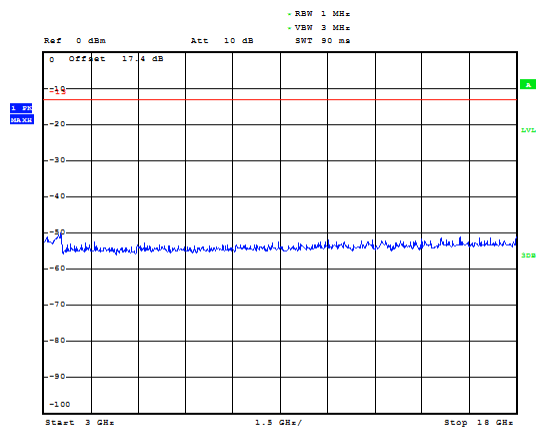



LTE Band 4 5MHz CH-High 30MHz~1GHz

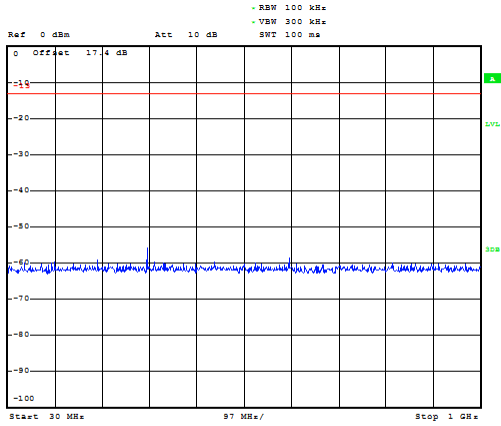

LTE Band 4 10MHz CH-Low 30MHz~1GHz

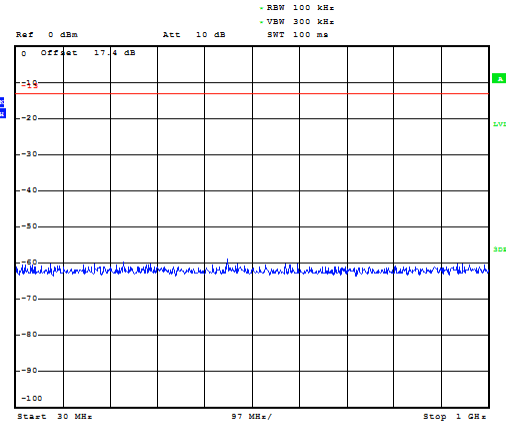

LTE Band 4 5MHz CH-High 1GHz~3GHz

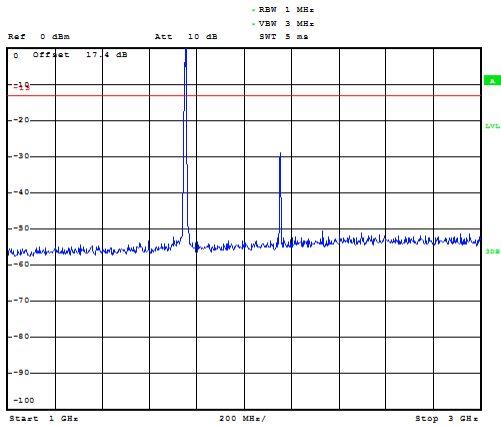

LTE Band 4 10MHz CH-Low 1GHz~3GHz

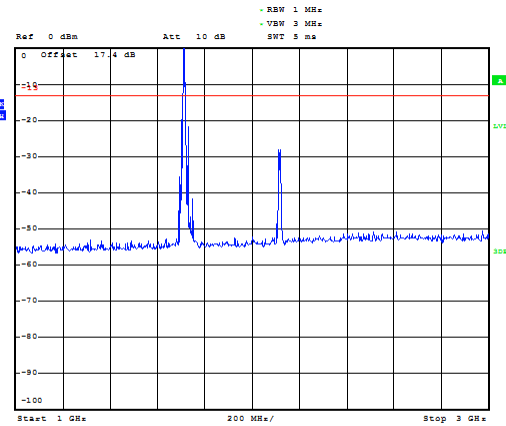

LTE Band 4 5MHz CH-High 3GHz~18GHz

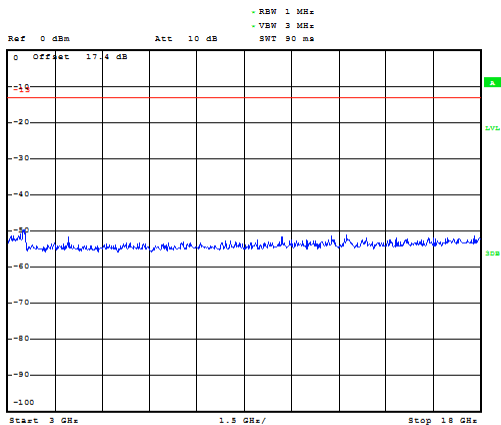

LTE Band 4 10MHz CH-Low 3GHz~18GHz

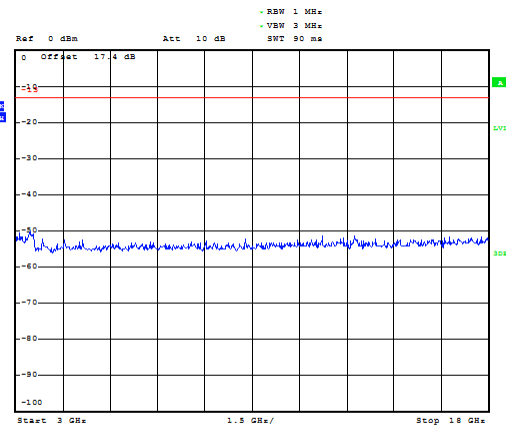



LTE Band 4 10MHz CH-Middle 30MHz~1GHz

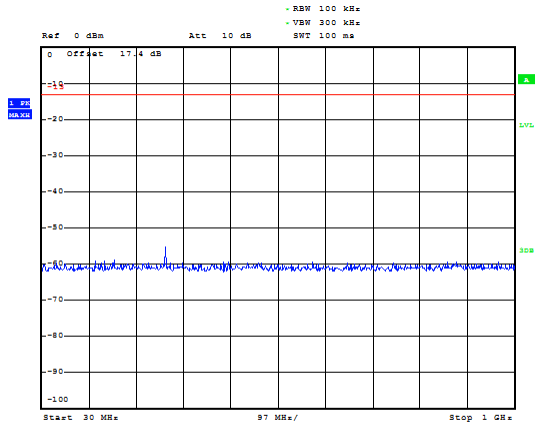

LTE Band 4 10MHz CH-High 30MHz~1GHz

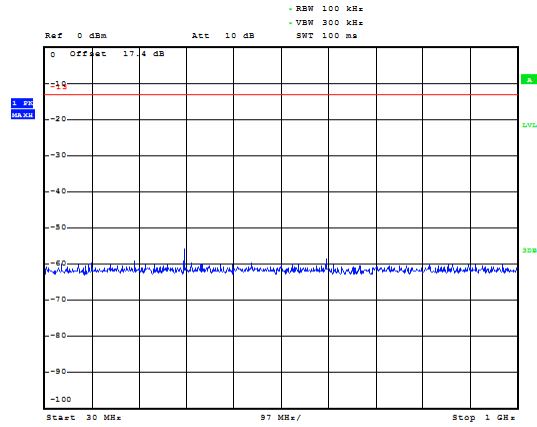

LTE Band 4 10MHz CH-Middle 1GHz~3GHz

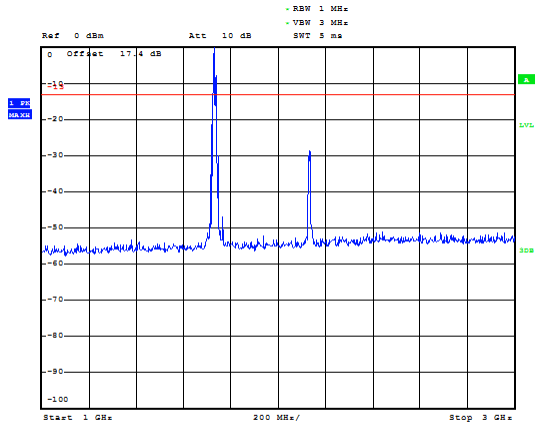

LTE Band 4 10MHz CH-High 1GHz~3GHz

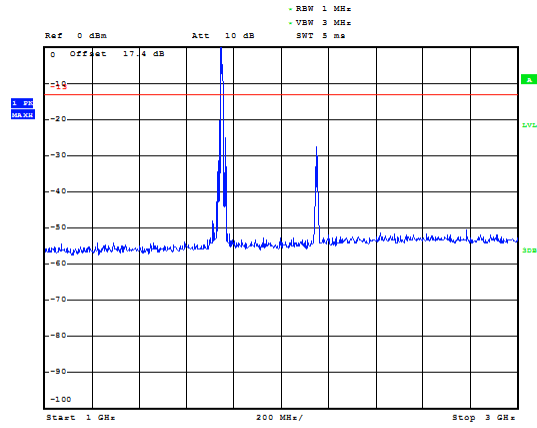

LTE Band 4 10MHz CH-Middle 3GHz~18GHz

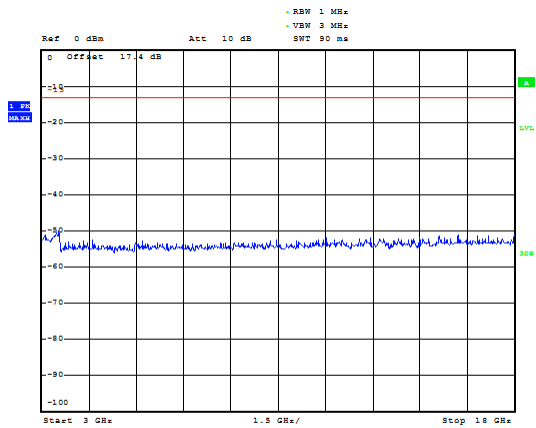

LTE Band 4 10MHz CH-High 3GHz~18GHz

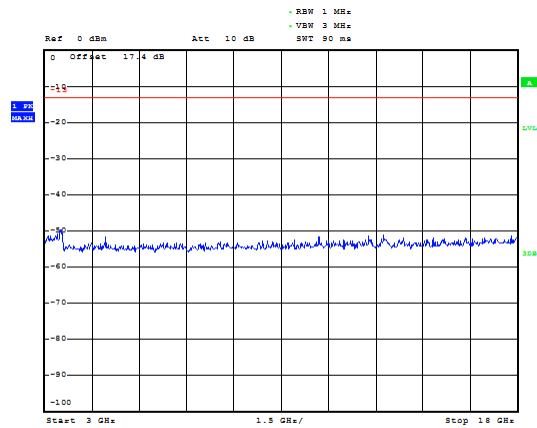



LTE Band 4 15MHz CH-Low 30MHz~1GHz

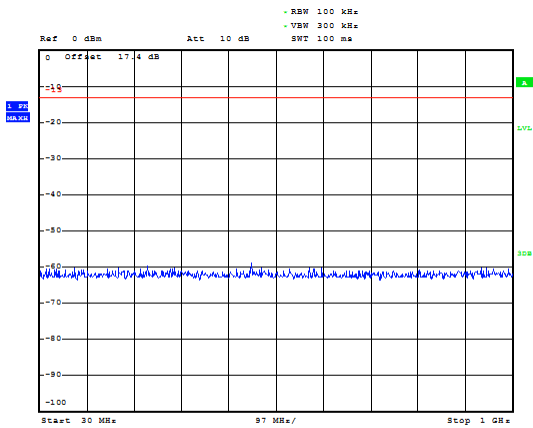

LTE Band 4 15MHz CH-Middle 30MHz~1GHz

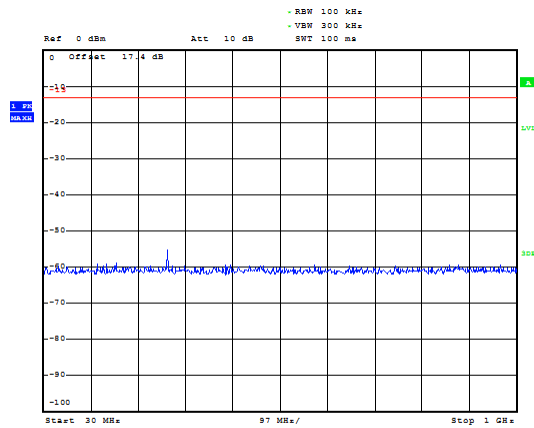

LTE Band 4 15MHz CH-Low 1GHz~3GHz

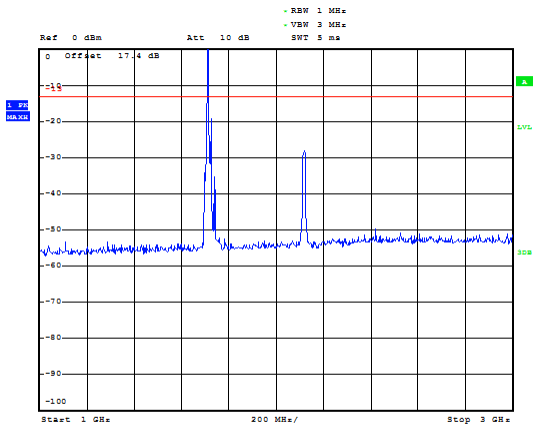

LTE Band 4 15MHz CH-Middle 1GHz~3GHz

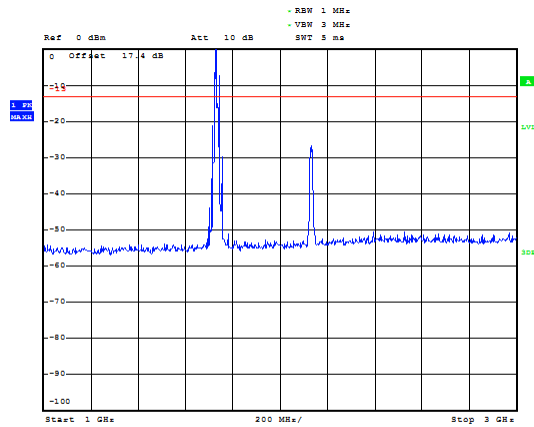

LTE Band 4 15MHz CH-Low 3GHz~18GHz

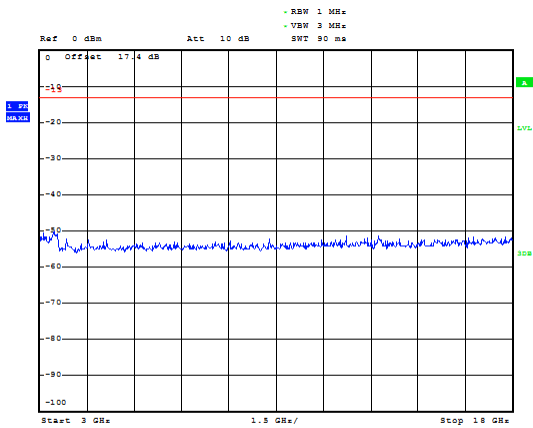

LTE Band 4 15MHz CH-Middle 3GHz~18GHz

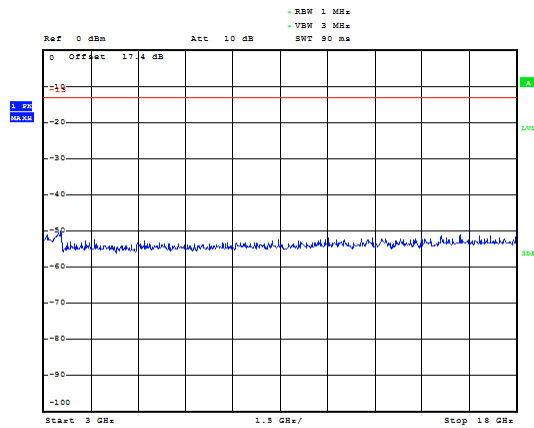



LTE Band 4 15MHz CH-High 30MHz~1GHz

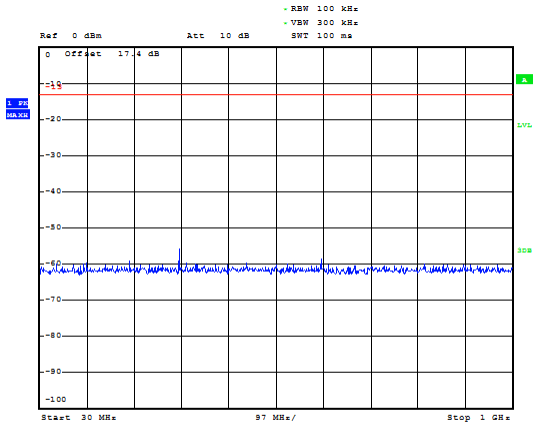

LTE Band 4 20MHz CH-Low 30MHz~1GHz

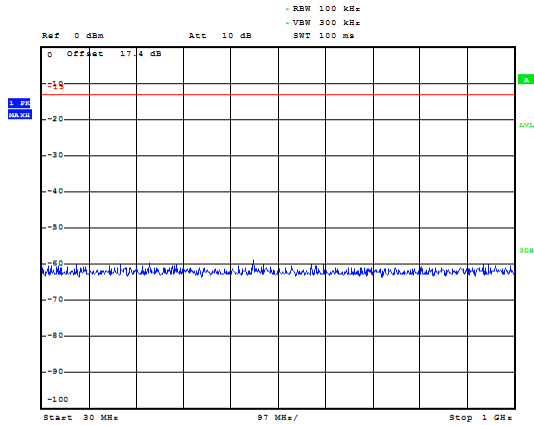

LTE Band 4 15MHz CH-High 1GHz~3GHz

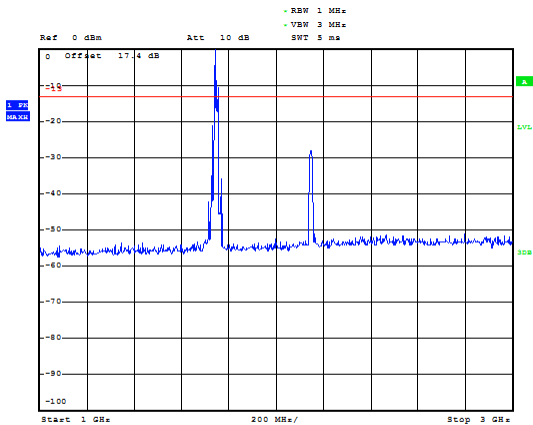

LTE Band 4 20MHz CH-Low 1GHz~3GHz

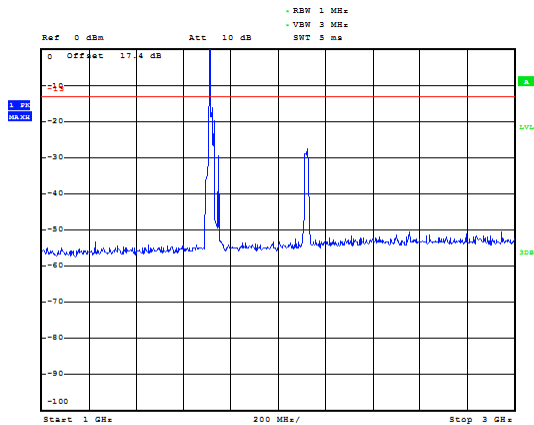

LTE Band 4 15MHz CH-High 3GHz~18GHz

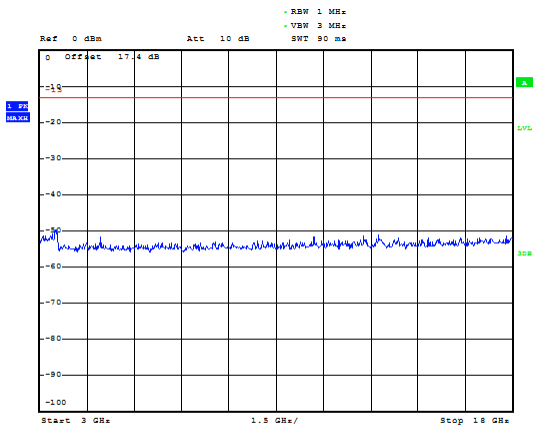

LTE Band 4 20MHz CH-Low 3GHz~18GHz

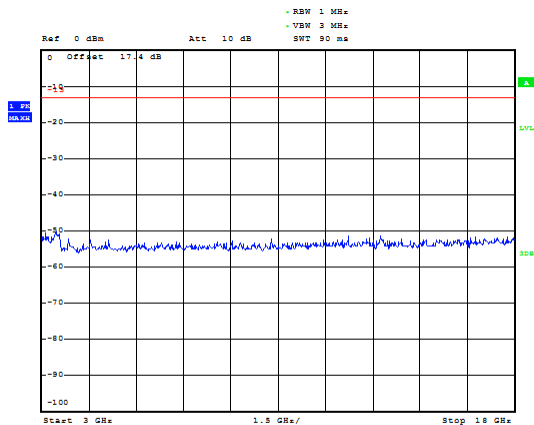



LTE Band 4 20MHz CH-Middle 30MHz~1GHz

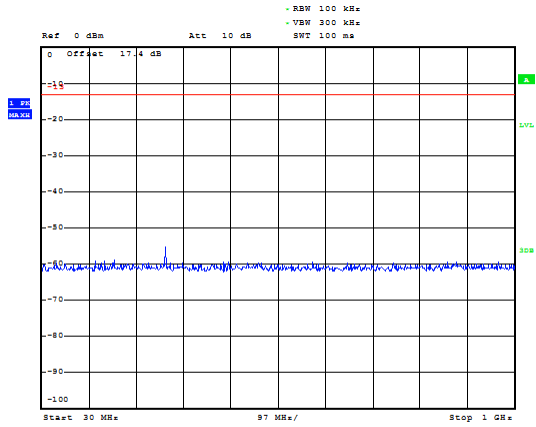

LTE Band 4 20MHz CH-High 30MHz~1GHz

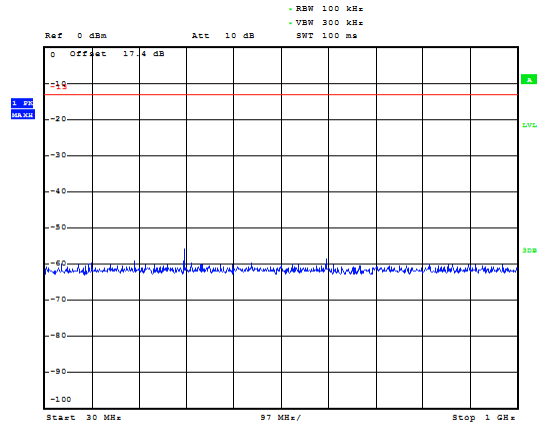

LTE Band 4 20MHz CH-Middle 1GHz~3GHz

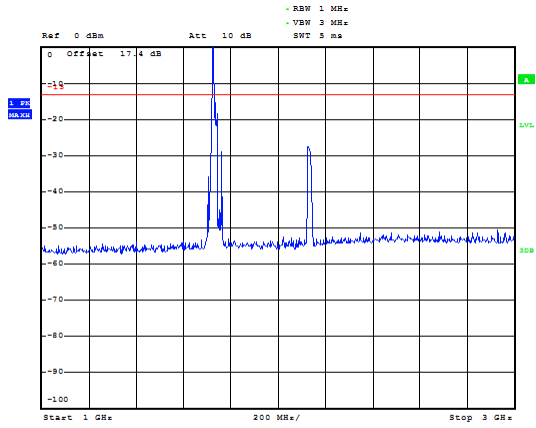

LTE Band 4 20MHz CH-High 1GHz~3GHz

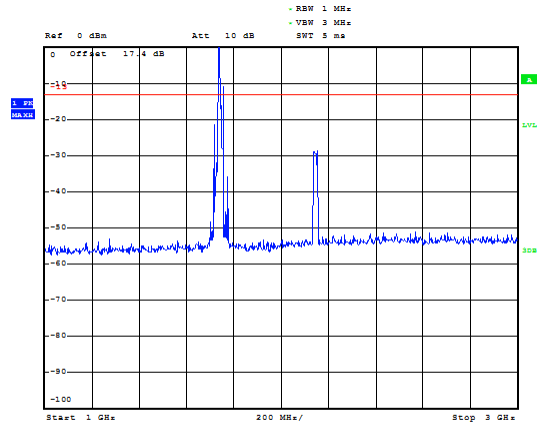

LTE Band 4 20MHz CH-Middle 3GHz~18GHz

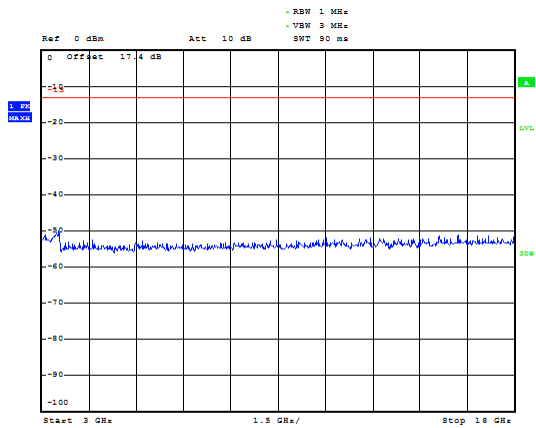

LTE Band 4 20MHz CH-High 3GHz~18GHz

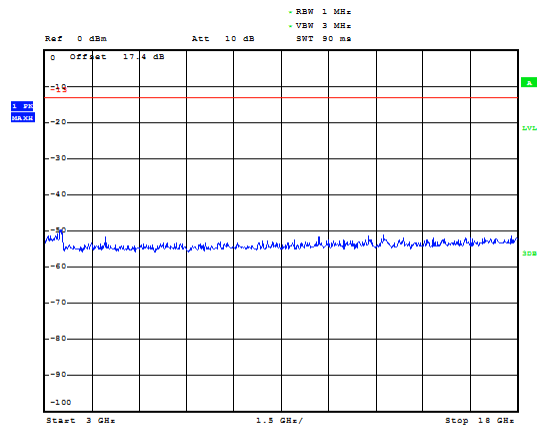



LTE Band 12 1.4MHz CH-Low 30MHz~1GHz

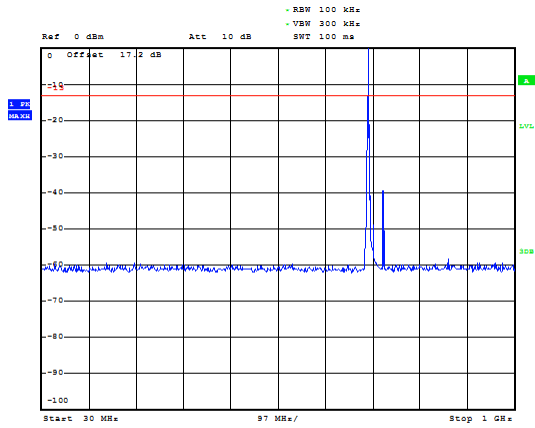

LTE Band 12 1.4MHz CH-Low 1GHz~9GHz

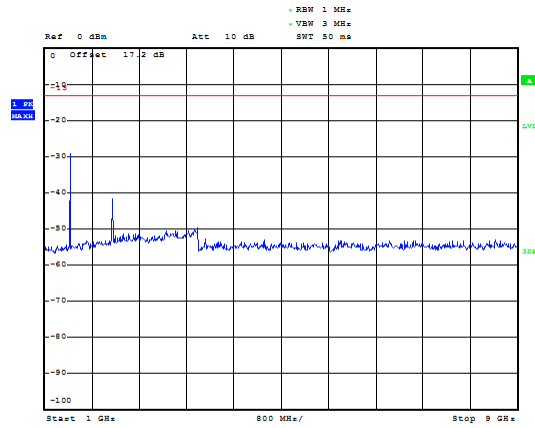

LTE Band 12 1.4MHz CH- Middle 30MHz~1GHz

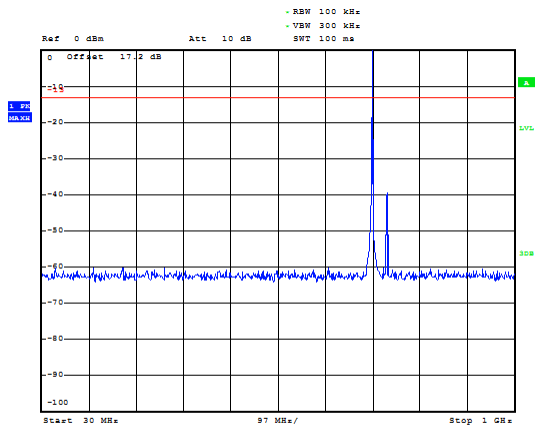

LTE Band 12 1.4MHz CH- Middle 1GHz~9GHz

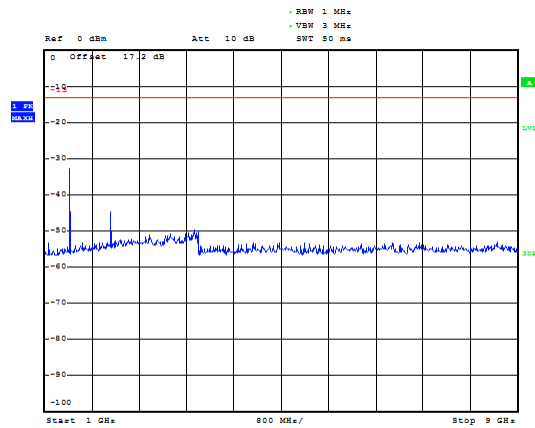

LTE Band 12 1.4MHz CH-High 30MHz~1GHz

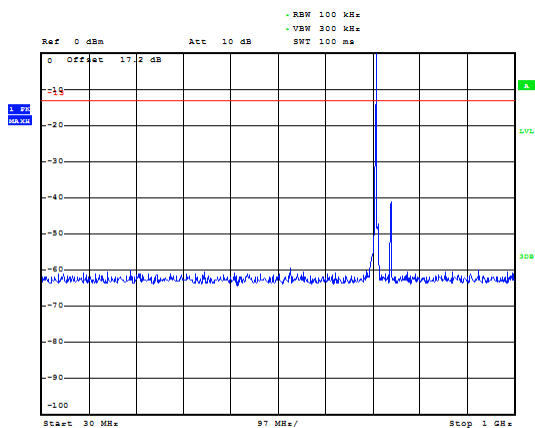

LTE Band 12 1.4MHz CH-High 1GHz~9GHz

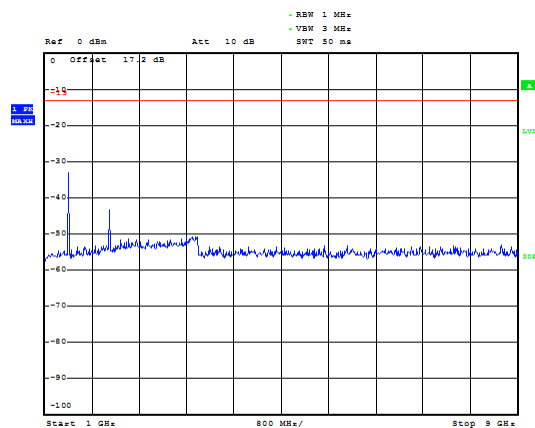



LTE Band 12 3MHz CH-Low 30MHz~1GHz

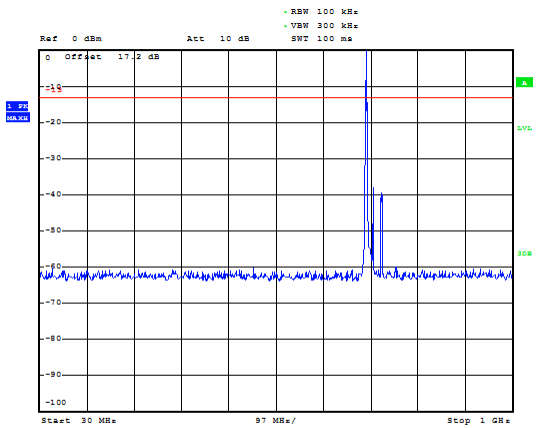

LTE Band 12 3MHz CH-Low 1GHz~9GHz

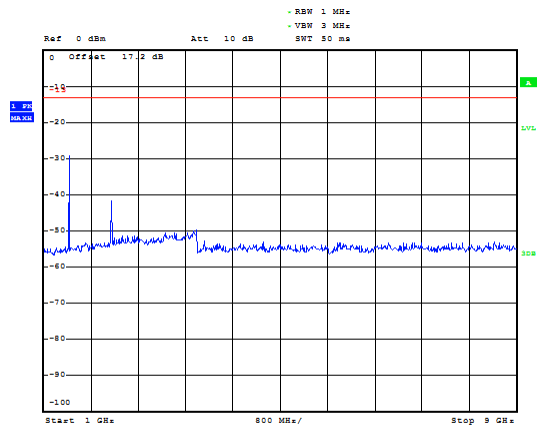

LTE Band 12 3MHz CH- Middle 30MHz~1GHz

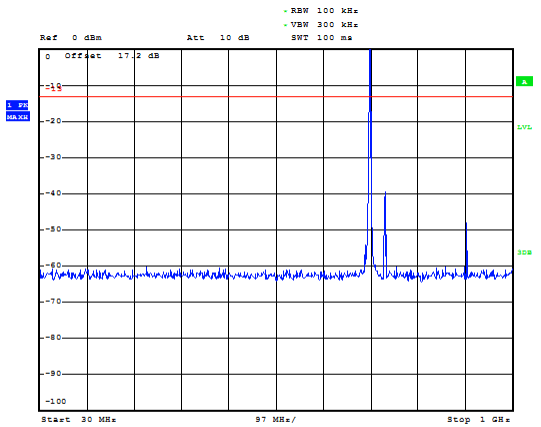

LTE Band 12 3MHz CH- Middle 1GHz~9GHz

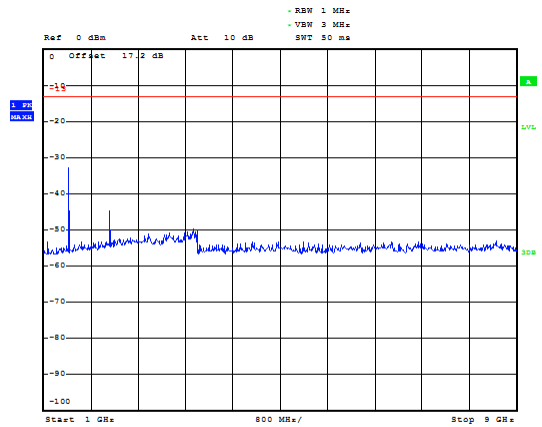

LTE Band 12 3MHz CH-High 30MHz~1GHz

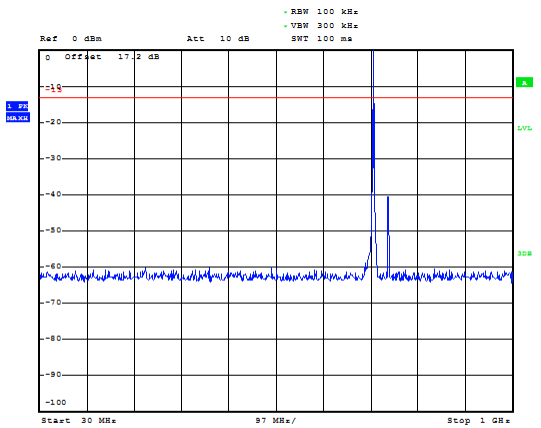

LTE Band 12 3MHz CH-High 1GHz~9GHz

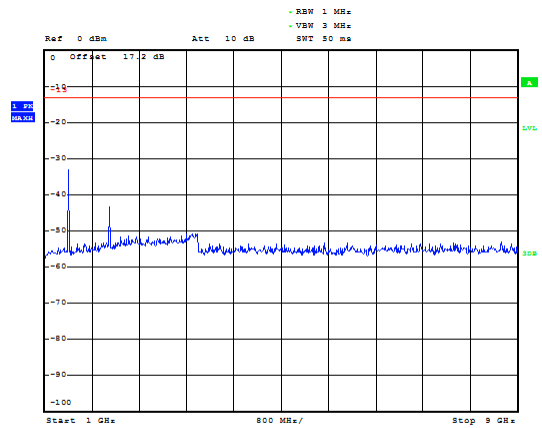



LTE Band 12 5MHz CH-Low 30MHz~1GHz

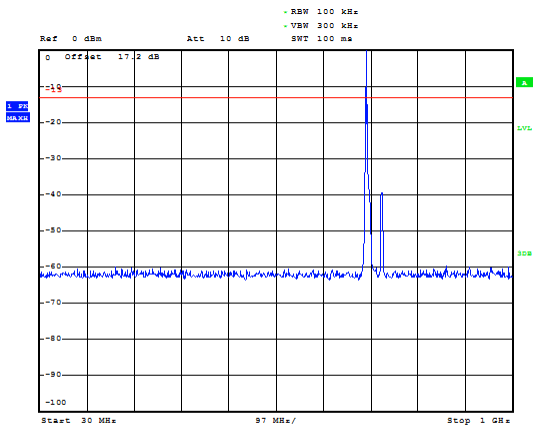

LTE Band 12 5MHz CH-Low 1GHz~9GHz

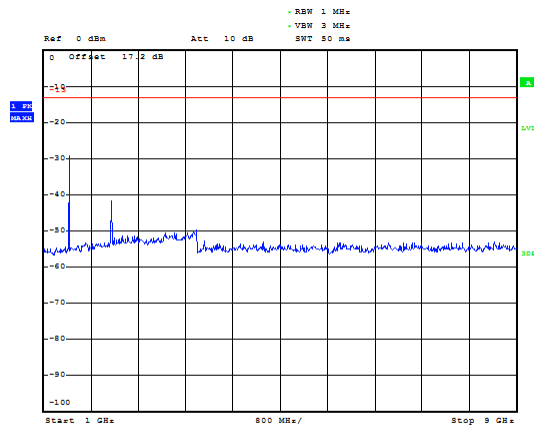

LTE Band 12 5MHz CH- Middle 30MHz~1GHz

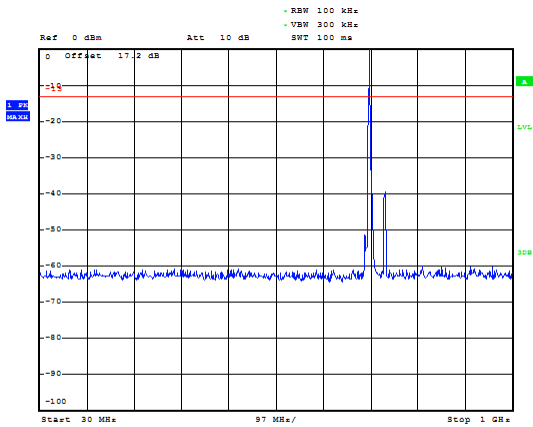

LTE Band 12 5MHz CH- Middle 1GHz~9GHz

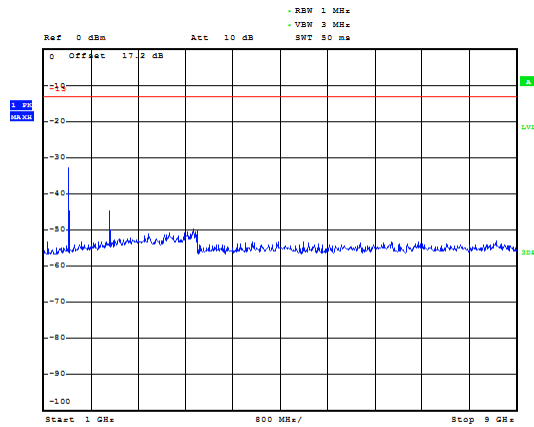

LTE Band 12 5MHz CH-High 30MHz~1GHz

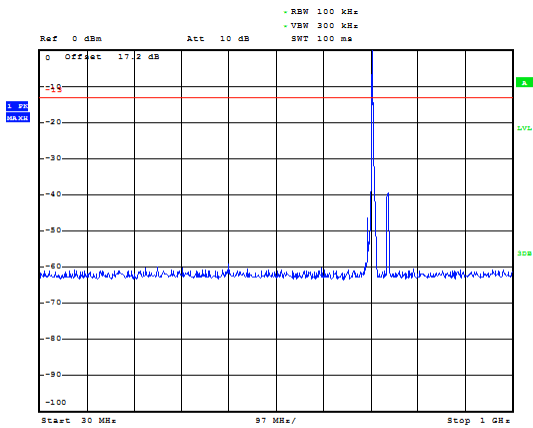

LTE Band 12 5MHz CH-High 1GHz~9GHz

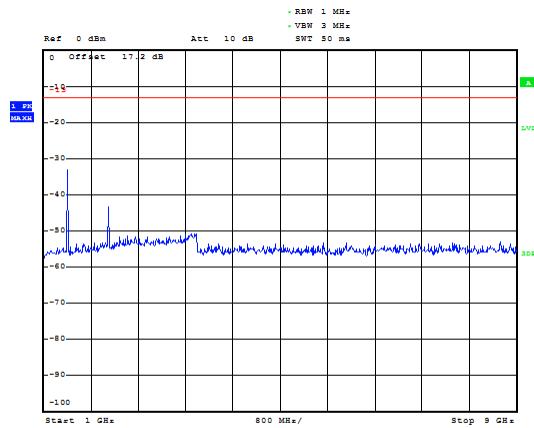



LTE Band 12 10MHz CH-Low 30MHz~1GHz

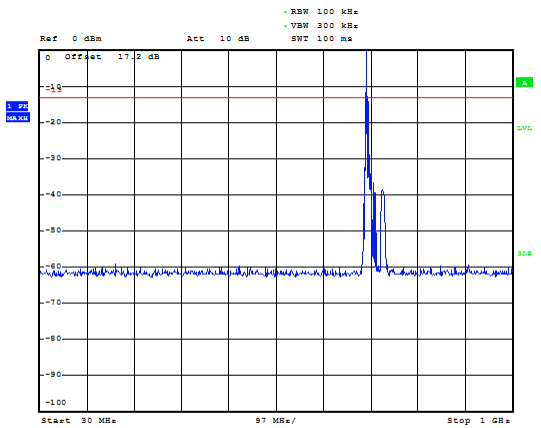

LTE Band 12 10MHz CH-Low 1GHz~9GHz

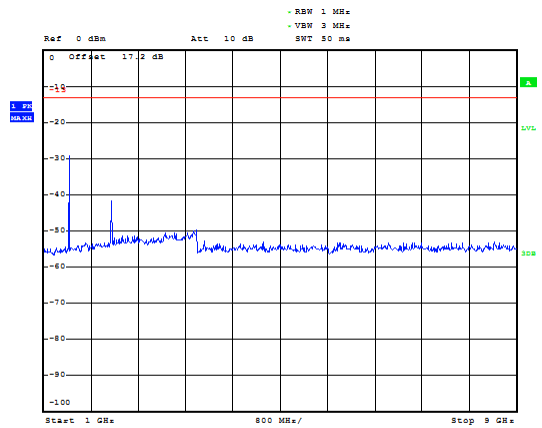

LTE Band 12 10MHz CH- Middle 30MHz~1GHz

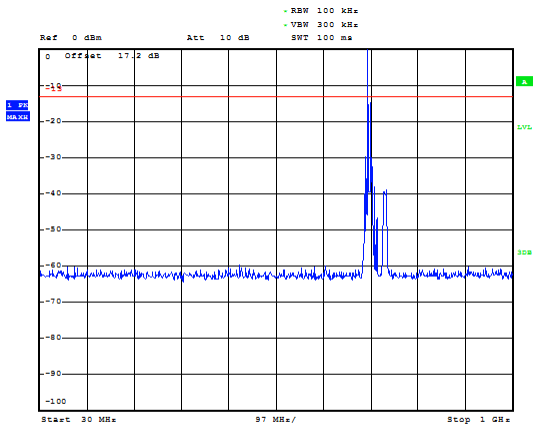

LTE Band 12 10MHz CH- Middle 1GHz~9GHz

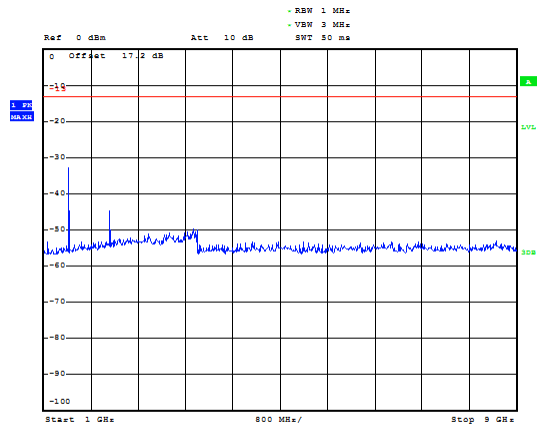

LTE Band 12 10MHz CH-High 30MHz~1GHz

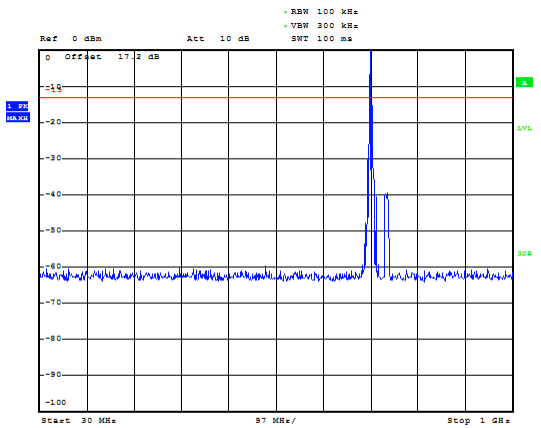

LTE Band 12 10MHz CH-High 1GHz~9GHz

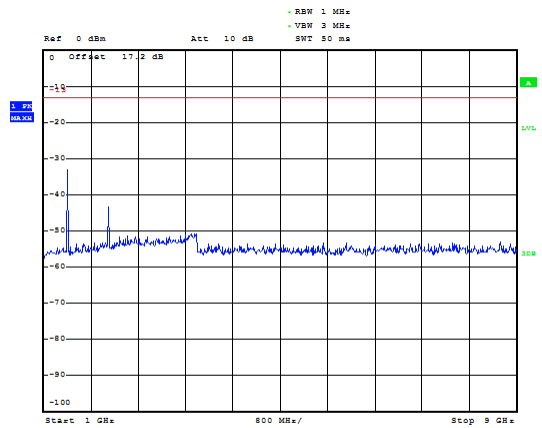



LTE Band 13 5MHz CH-Low 30MHz~1GHz

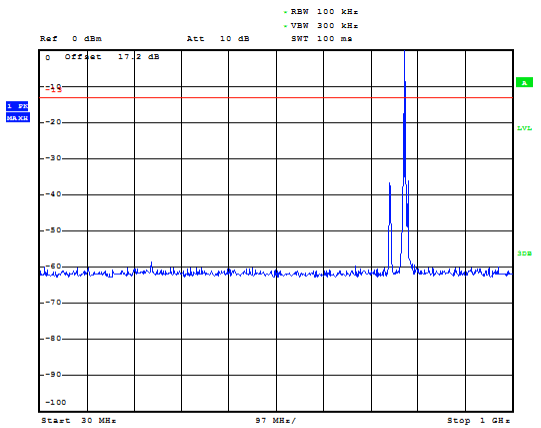

LTE Band 13 5MHz CH-Low 1GHz~9GHz

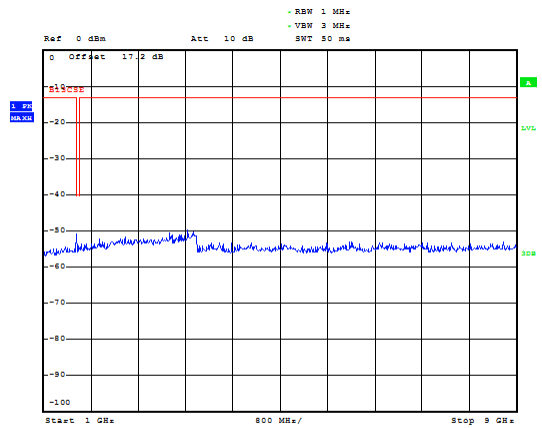

LTE Band 13 5MHz CH-Middle 30MHz~1GHz

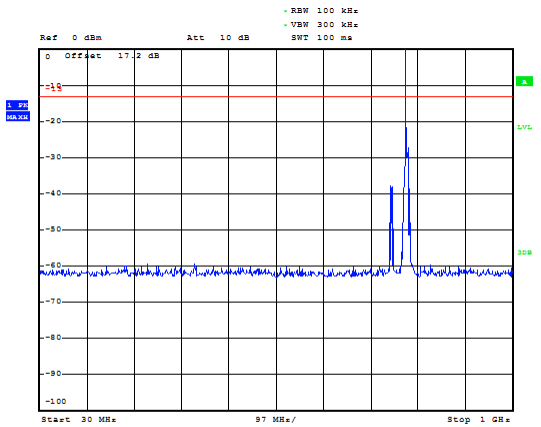

LTE Band 13 5MHz CH-Middle 1GHz~9GHz

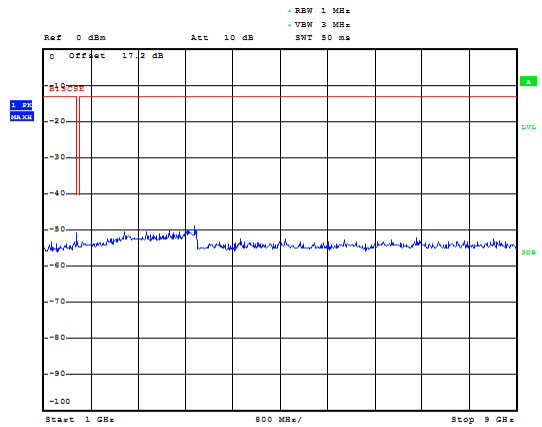

LTE Band 13 5MHz CH-High 30MHz~1GHz

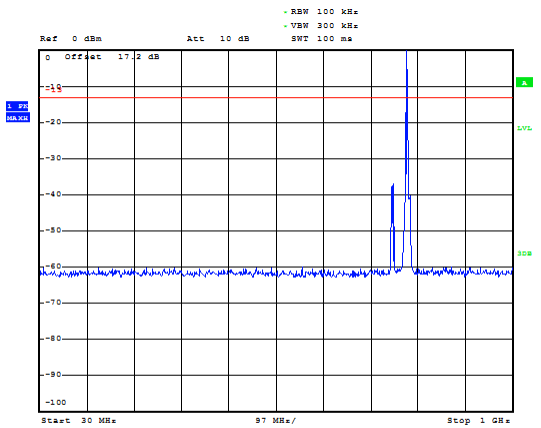

LTE Band 13 5MHz CH-High 1GHz~9GHz

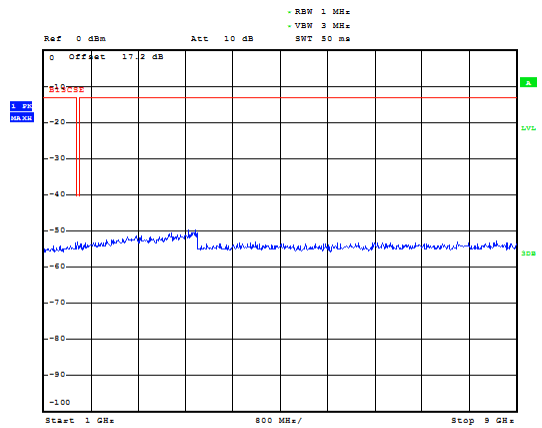

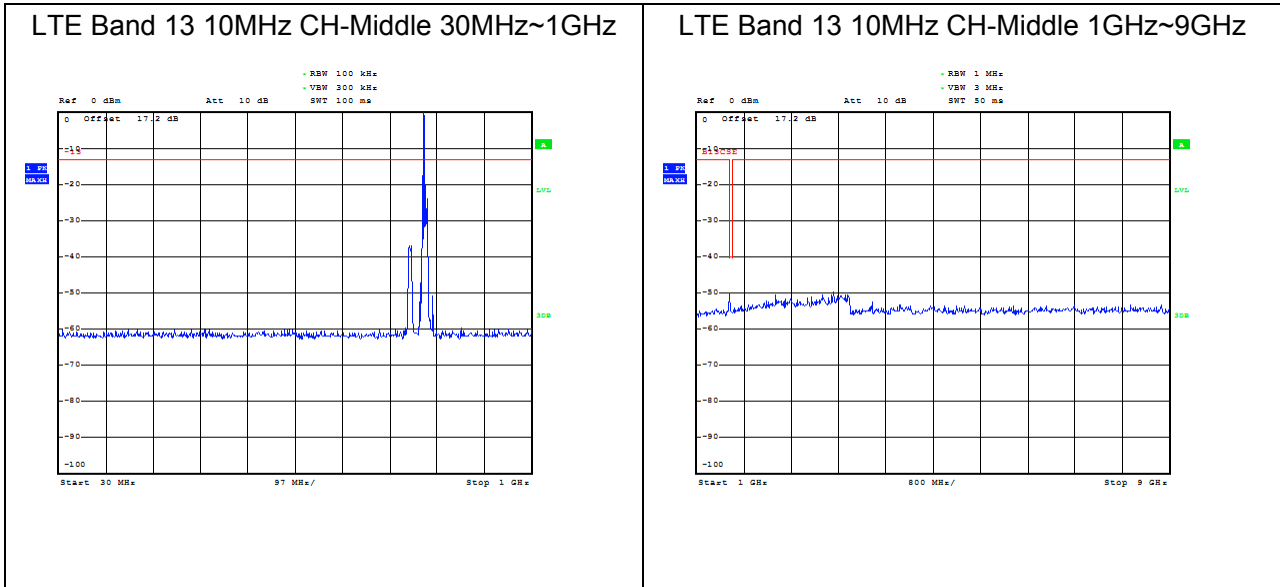

If disturbances were found more than 20dB below limit line, the mark is not required for the EUT. The signal beyond the limit is carrier in the following plots.

Test Data File Name	Frequency (MHz)	Level (dBm)	Limit (dBm)	Margin (dB)
B12_CHLOW_1.4M_RB1_1-9GHz	1354.05	-29.354	-13	16.354
B12_CHMID_1.4M_RB1_1-9GHz	1363.76	-32.162	-13	19.162
B12_CHLOW_3M_RB1_1-9GHz	1359.87	-29.333	-13	16.333
B12_CHMID_3M_RB1_1-9GHz	1365.74	-32.001	-13	19.001
B12_CHHIGH_3M_RB1_1-9GHz	1384.85	-32.764	-13	19.764
B12_CHLOW_5M_RB1_1-9GHz	1366.47	-28.969	-13	15.969
B12_CHMID_5M_RB1_1-9GHz	1376.10	-31.862	-13	18.862
B12_CHHIGH_5M_RB1_1-9GHz	1388.19	-32.753	-13	19.753
B12_CHLOW_10M_RB1_1-9GHz	1372.20	-29.043	-13	16.043
B12_CHMID_10M_RB1_1-9GHz	1378.11	-31.717	-13	18.717
B12_CHHIGH_10M_RB1_1-9GHz	1397.18	-32.472	-13	19.472

5.8 Radiates Spurious Emission

Ambient condition

Temperature	Relative humidity	Pressure
23°C ~25°C	45%~50%	101.5kPa

Method of Measurement

1. The testing follows FCC KDB 971168 D01 v03r01 Section 5.8 and ANSI/TIA-603-E (2016).
 2. The EUT is placed on a turntable 0.8 meters above the ground in the chamber, 3 meter away from the antenna. The maximal emission value is acquired by adjusting the antenna height, polarisation and turntable azimuth. Normally, the height range of antenna is 1 m to 4 m, the azimuth range of turntable is 0° to 360°, and the receive antenna has two polarizations Vertical (V) and Horizontal (H).
 3. A log-periodic antenna or double-ridged waveguide horn antenna shall be substituted in place of the EUT. The log-periodic antenna will be driven by a signal generator and the level will be adjusted till the same power value on the spectrum analyzer or receiver. The level of the spurious emissions can be calculated through the level of the signal generator, cable loss, the gain of the substitution antenna and the reading of the spectrum analyzer or receiver.
 4. The EUT is then put into continuously transmitting mode at its maximum power level during the test. Set Test Receiver or Spectrum RBW=1MHz, VBW=3MHz, And the maximum value of the receiver should be recorded as (Pr).
 5. The EUT shall be replaced by a substitution antenna. In the chamber, an substitution antenna for the frequency band of interest is placed at the reference point of the chamber. An RF Signal source for the frequency band of interest is connected to the substitution antenna with a cable that has been constructed to not interfere with the radiation pattern of the antenna. A power (PMea) is applied to the input of the substitution antenna, and adjust the level of the signal generator output until the value of the receiver reach the previously recorded (Pr). The power of signal source (PMea) is recorded. The test should be performed by rotating the test item and adjusting the receiving antenna polarization.
 6. A amplifier should be connected to the Signal Source output port. And the cable should be connect between the Amplifier and the Substitution Antenna. The cable loss (Pcl) ,the Substitution Antenna Gain (Ga) and the Amplifier Gain (PAg) should be recorded after test.
 7. The measurement results are obtained as described below:

$$\text{Power(EIRP)} = \text{PMea} - \text{PAg} - \text{Pcl} + \text{Ga}$$
 The measurement results are amend as described below:

$$\text{Power(EIRP)} = \text{PMea} - \text{Pcl} + \text{Ga}$$
 8. This value is EIRP since the measurement is calibrated using an antenna of known gain (2.15 dBi) and known input power. ERP can be calculated from EIRP by subtracting the gain of the dipole, $\text{ERP} = \text{EIRP} - 2.15\text{dBi}$.
- The modulation mode and RB allocation refer to section 5.1, using the maximum output power configuration.

Test setup

30MHz~~~ 1GHz

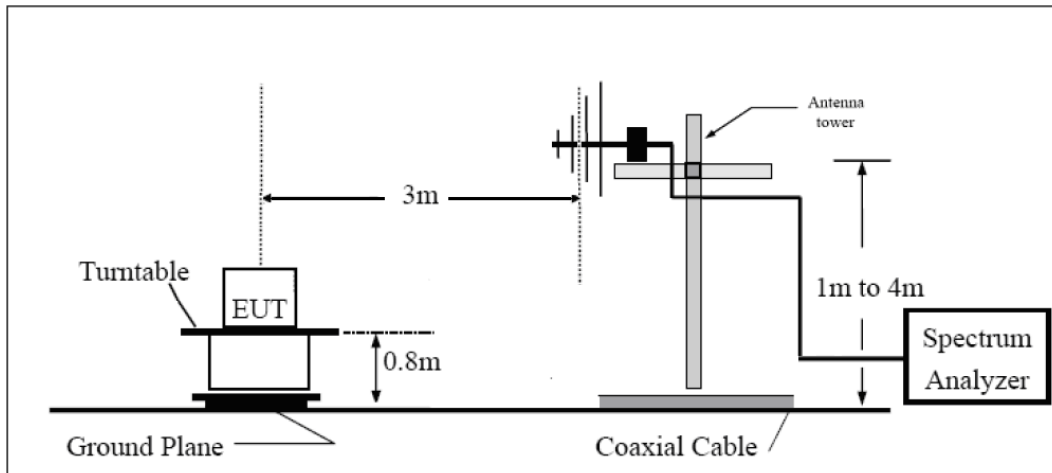

Above 1GHz

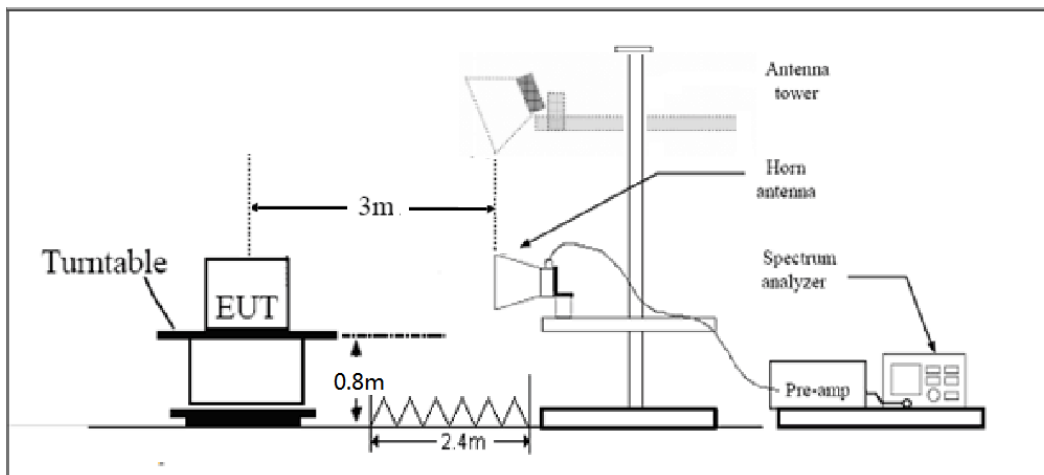

Note: Area side:2.4mX3.6m

The radiated emission was measured in the following position: EUT stand-up position (Z axis), lie-down position (X, Y axis). The worst emission was found in lie-down position (X axis) and the worst case was recorded.

Limits

Rule Part 27.53(h) specifies that “for operations in the 1695-1710 MHz, 1710-1755 MHz, 1755-1780 MHz, 1915-1920 MHz, 1995-2000 MHz, 2000-2020 MHz, 2110-2155 MHz, 2155-2180 MHz, and 2180-2200 bands, the power of any emission outside a licensee's frequency block shall be attenuated below the transmitter power (P) in watts by at least $43 + 10 \log_{10} (P)$ dB..”

Rule Part 27.53 (g) For operations in the 600 MHz band and the 698-746 MHz band, the power of any emission outside a licensee's frequency band(s) of operation shall be attenuated below the transmitter power (P) within the licensed band(s) of operation, measured in watts, by at least $43 + 10 \log (P)$ dB. Compliance with this provision is based on the use of measurement instrumentation employing a resolution bandwidth of 100 kilohertz or greater. However, in the 100 kilohertz bands



immediately outside and adjacent to a licensee's frequency block, a resolution bandwidth of at least 30 kHz may be employed.

Rule Part 27.53(f) For operations in the 746-758 MHz, 775-788 MHz, and 805-806 MHz bands, emissions in the band 1559-1610 MHz shall be limited to -70 dBW/MHz equivalent isotropically radiated power (EIRP) for wideband signals, and -80 dBW EIRP for discrete emissions of less than 700 Hz bandwidth. For the purpose of equipment authorization, a transmitter shall be tested with an antenna that is representative of the type that will be used with the equipment in normal operation.

Part 27.53(h)(g) Limit		-13 dBm
Part 27.53(f) Limit	Limit out of the band 1559-1610 MHz	-13 dBm
	Limit in the band 1559-1610 MHz	-40 dBm

Measurement Uncertainty

The assessed measurement uncertainty to ensure 95% confidence level for the normal distribution is with the coverage factor $k = \pm 1.96$, $U = \pm 3.55$ dB.

Test Result

Sweep the whole frequency band through the range from 30MHz to the 10th harmonic of the carrier, the emissions below the noise floor will not be recorded in the report.

WCDMA Band IV CH-Low

Harmonic	Frequency (MHz)	SG (dBm)	Cable Loss (dB)	Gain (dBi)	Antenna Polarization	EIRP Level (dBm)	Limit (dBm)	Margin (dB)	Azimuth (deg)
2	3424.8	-52.55	2.6	10.15	Horizontal	-45.00	-13.00	32.00	0
3	5137.2	-50.15	2.4	11.35	Horizontal	-41.20	-13.00	28.20	45
4	6849.6	-54.35	4.5	10.85	Horizontal	-48.00	-13.00	35.00	90
5	8562.0	-54.05	5.1	11.35	Horizontal	-47.80	-13.00	34.80	0
6	10274.4	-48.95	5.3	11.95	Horizontal	-42.30	-13.00	29.30	225
7	11986.8	-51.95	5.5	13.55	Horizontal	-43.90	-13.00	30.90	135
8	13699.2	-47.95	6.3	13.75	Horizontal	-40.50	-13.00	27.50	90
9	15411.6	-49.95	6.7	13.85	Horizontal	-42.80	-13.00	29.80	0
10	17124.0	-48.05	6.8	14.25	Horizontal	-40.60	-13.00	27.60	45

Note: 1. The other Spurious RF Radiated emissions level is no more than noise floor.

2. The worst emission was found in the antenna is Horizontal position.

WCDMA Band IV CH-Middle

Harmonic	Frequency (MHz)	SG (dBm)	Cable Loss (dB)	Gain (dBi)	Antenna Polarization	EIRP Level (dBm)	Limit (dBm)	Margin (dB)	Azimuth (deg)
2	3465.2	-52.15	2.6	10.75	Horizontal	-44.00	-13.00	31.00	45
3	5197.8	-50.95	2.4	11.05	Horizontal	-42.30	-13.00	29.30	0
4	6930.4	-55.85	4.5	11.15	Horizontal	-49.20	-13.00	36.20	225
5	8663.0	-53.95	5.1	11.35	Horizontal	-47.70	-13.00	34.70	135
6	10395.6	-49.25	5.3	11.95	Horizontal	-42.60	-13.00	29.60	180
7	12128.2	-52.95	5.5	13.55	Horizontal	-44.90	-13.00	31.90	315
8	13860.8	-47.45	6.3	13.75	Horizontal	-40.00	-13.00	27.00	0
9	15593.4	-50.15	6.7	13.85	Horizontal	-43.00	-13.00	30.00	0
10	17326.0	-48.25	6.8	14.25	Horizontal	-40.80	-13.00	27.80	90

Note: 1. The other Spurious RF Radiated emissions level is no more than noise floor.

2. The worst emission was found in the antenna is Horizontal position.

WCDMA Band IV CH-High

Harmonic	Frequency (MHz)	SG (dBm)	Cable Loss (dB)	Gain (dBi)	Antenna Polarization	EIRP Level (dBm)	Limit (dBm)	Margin (dB)	Azimuth (deg)
2	3505.2	-56.25	2.6	10.15	Horizontal	-48.70	-13.00	35.70	135
3	5254.1	-55.85	2.4	11.05	Horizontal	-47.20	-13.00	34.20	225
4	7010.4	-53.65	4.5	11.15	Horizontal	-47.00	-13.00	34.00	270
5	8763.0	-53.05	5.1	11.35	Horizontal	-46.80	-13.00	33.80	135
6	10515.6	-48.95	5.3	11.95	Horizontal	-42.30	-13.00	29.30	45
7	12268.2	-51.55	5.5	13.55	Horizontal	-43.50	-13.00	30.50	315
8	14020.8	-47.25	6.3	13.75	Horizontal	-39.80	-13.00	26.80	90
9	15773.4	-49.25	6.7	13.85	Horizontal	-42.10	-13.00	29.10	0
10	17526.0	-48.05	6.8	14.25	Horizontal	-40.60	-13.00	27.60	45

Note: 1. The other Spurious RF Radiated emissions level is no more than noise floor.

2. The worst emission was found in the antenna is Horizontal position.

LTE Band 4 QPSK 1.4MHz CH-Low, RB 1

Harmonic	Frequency (MHz)	SG (dBm)	Cable Loss (dB)	Gain (dBi)	Antenna Polarization	EIRP Level (dBm)	Limit (dBm)	Margin (dB)	Azimuth (deg)
2	3421.4	-49.15	2.6	10.15	Horizontal	-41.60	-13.00	28.60	0
3	5131.1	-44.85	2.4	11.35	Horizontal	-35.90	-13.00	22.90	0
4	6842.8	-52.95	4.5	10.85	Horizontal	-46.60	-13.00	33.60	45
5	8553.5	-53.05	5.1	11.35	Horizontal	-46.80	-13.00	33.80	315
6	10264.2	-51.15	5.3	11.95	Horizontal	-44.50	-13.00	31.50	315
7	11974.9	-51.15	5.5	13.55	Horizontal	-43.10	-13.00	30.10	315
8	13685.6	-48.95	6.3	13.75	Horizontal	-41.50	-13.00	28.50	270
9	15396.3	-47.65	6.7	13.85	Horizontal	-40.50	-13.00	27.50	90
10	17107.0	-47.25	6.8	14.25	Horizontal	-39.80	-13.00	26.80	45

Note: 1. The other Spurious RF Radiated emissions level is no more than noise floor.

2. The worst emission was found in the antenna is Horizontal position.

LTE Band 4 QPSK 1.4MHz CH-Middle, RB 1

Harmonic	Frequency (MHz)	SG (dBm)	Cable Loss (dB)	Gain (dBi)	Antenna Polarization	EIRP Level (dBm)	Limit (dBm)	Margin (dB)	Azimuth (deg)
2	3464.3	-51.85	2.6	10.75	Horizontal	-43.70	-13.00	30.70	135
3	5197.5	-44.75	2.4	11.05	Horizontal	-36.10	-13.00	23.10	180
4	6930.0	-53.95	4.5	11.15	Horizontal	-47.30	-13.00	34.30	180
5	8662.5	-52.75	5.1	11.35	Horizontal	-46.50	-13.00	33.50	180
6	10395.0	-50.85	5.3	11.95	Horizontal	-44.20	-13.00	31.20	45
7	12127.5	-51.65	5.5	13.55	Horizontal	-43.60	-13.00	30.60	315
8	13860.0	-49.15	6.3	13.75	Horizontal	-41.70	-13.00	28.70	45
9	15592.5	-47.65	6.7	13.85	Horizontal	-40.50	-13.00	27.50	135
10	17325.0	-46.05	6.8	14.25	Horizontal	-38.60	-13.00	25.60	45

Note: 1. The other Spurious RF Radiated emissions level is no more than noise floor.
2. The worst emission was found in the antenna is Horizontal position.

LTE Band 4 QPSK 1.4MHz CH-High, RB 1

Harmonic	Frequency (MHz)	SG (dBm)	Cable Loss (dB)	Gain (dBi)	Antenna Polarization	EIRP Level (dBm)	Limit (dBm)	Margin (dB)	Azimuth (deg)
2	3507.8	-44.65	2.6	10.15	Horizontal	-37.10	-13.00	24.10	135
3	5261.6	-46.75	2.4	11.05	Horizontal	-38.10	-13.00	25.10	180
4	7017.2	-50.65	4.5	11.15	Horizontal	-44.00	-13.00	31.00	180
5	8771.5	-50.05	5.1	11.35	Horizontal	-43.80	-13.00	30.80	45
6	10525.8	-50.45	5.3	11.95	Horizontal	-43.80	-13.00	30.80	0
7	12280.1	-50.55	5.5	13.55	Horizontal	-42.50	-13.00	29.50	0
8	14034.4	-48.65	6.3	13.75	Horizontal	-41.20	-13.00	28.20	135
9	15788.7	-46.85	6.7	13.85	Horizontal	-39.70	-13.00	26.70	90
10	17543.0	-45.65	6.8	14.25	Horizontal	-38.20	-13.00	25.20	270

Note: 1. The other Spurious RF Radiated emissions level is no more than noise floor.
2. The worst emission was found in the antenna is Horizontal position.

LTE Band 4 QPSK 5MHz CH-Low, RB 1

Harmonic	Frequency (MHz)	SG (dBm)	Cable Loss (dB)	Gain (dBi)	Antenna Polarization	EIRP Level (dBm)	Limit (dBm)	Margin (dB)	Azimuth (deg)
2	3425.0	-49.45	2.6	10.15	Horizontal	-41.90	-13.00	28.90	0
3	5131.1	-45.05	2.4	11.35	Horizontal	-36.10	-13.00	23.10	90
4	6850.0	-53.35	4.5	10.85	Horizontal	-47.00	-13.00	34.00	180
5	8562.5	-53.45	5.1	11.35	Horizontal	-47.20	-13.00	34.20	270
6	10275.0	-50.15	5.3	11.95	Horizontal	-43.50	-13.00	30.50	315
7	11987.5	-50.75	5.5	13.55	Horizontal	-42.70	-13.00	29.70	135
8	13700.0	-47.15	6.3	13.75	Horizontal	-39.70	-13.00	26.70	180
9	15412.5	-49.15	6.7	13.85	Horizontal	-42.00	-13.00	29.00	45
10	17125.0	-46.65	6.8	14.25	Horizontal	-39.20	-13.00	26.20	90

Note: 1.The other Spurious RF Radiated emissions level is no more than noise floor.
2. The worst emission was found in the antenna is Horizontal position.

LTE Band 4 QPSK 5MHz CH-Middle, RB 1

Harmonic	Frequency (MHz)	SG (dBm)	Cable Loss (dB)	Gain (dBi)	Antenna Polarization	EIRP Level (dBm)	Limit (dBm)	Margin (dB)	Azimuth (deg)
2	3460.5	-53.25	2.6	10.75	Horizontal	-45.10	-13.00	32.10	0
3	5191.5	-44.85	2.4	11.05	Horizontal	-36.20	-13.00	23.20	0
4	6930.0	-53.85	4.5	11.15	Horizontal	-47.20	-13.00	34.20	0
5	8662.5	-52.65	5.1	11.35	Horizontal	-46.40	-13.00	33.40	90
6	10395.0	-50.45	5.3	11.95	Horizontal	-43.80	-13.00	30.80	315
7	12127.5	-50.55	5.5	13.55	Horizontal	-42.50	-13.00	29.50	45
8	13860.0	-46.85	6.3	13.75	Horizontal	-39.40	-13.00	26.40	45
9	15592.5	-49.05	6.7	13.85	Horizontal	-41.90	-13.00	28.90	90
10	17325.0	-46.25	6.8	14.25	Horizontal	-38.80	-13.00	25.80	135

Note: 1.The other Spurious RF Radiated emissions level is no more than noise floor.
2. The worst emission was found in the antenna is Horizontal position.

LTE Band 4 QPSK 5MHz CH-High, RB 1

Harmonic	Frequency (MHz)	SG (dBm)	Cable Loss (dB)	Gain (dBi)	Antenna Polarization	EIRP Level (dBm)	Limit (dBm)	Margin (dB)	Azimuth (deg)
2	3500.6	-44.75	2.6	10.15	Horizontal	-37.20	-13.00	24.20	0
3	5251.1	-47.95	2.4	11.05	Horizontal	-39.30	-13.00	26.30	90
4	7010.0	-52.75	4.5	11.15	Horizontal	-46.10	-13.00	33.10	180
5	8762.5	-52.05	5.1	11.35	Horizontal	-45.80	-13.00	32.80	315
6	10515.0	-50.15	5.3	11.95	Horizontal	-43.50	-13.00	30.50	135
7	12267.5	-50.15	5.5	13.55	Horizontal	-42.10	-13.00	29.10	180
8	14020.0	-46.35	6.3	13.75	Horizontal	-38.90	-13.00	25.90	45
9	15772.5	-46.65	6.7	13.85	Horizontal	-39.50	-13.00	26.50	90
10	17525.0	-45.05	6.8	14.25	Horizontal	-37.60	-13.00	24.60	0

Note: 1.The other Spurious RF Radiated emissions level is no more than noise floor.

2. The worst emission was found in the antenna is Horizontal position.

LTE Band 4 QPSK 20MHz CH-Low, RB 1

Harmonic	Frequency (MHz)	SG (dBm)	Cable Loss (dB)	Gain (dBi)	Antenna Polarization	EIRP Level (dBm)	Limit (dBm)	Margin (dB)	Azimuth (deg)
2	3440.0	-49.75	2.6	10.15	Horizontal	-42.20	-13.00	29.20	90
3	5133.4	-44.55	2.4	11.35	Horizontal	-35.60	-13.00	22.60	45
4	6880.0	-53.25	4.5	10.85	Horizontal	-46.90	-13.00	33.90	180
5	8600.0	-51.95	5.1	11.35	Horizontal	-45.70	-13.00	32.70	315
6	10320.0	-49.15	5.3	11.95	Horizontal	-42.50	-13.00	29.50	45
7	12040.0	-51.75	5.5	13.55	Horizontal	-43.70	-13.00	30.70	0
8	13760.0	-49.55	6.3	13.75	Horizontal	-42.10	-13.00	29.10	45
9	15480.0	-48.35	6.7	13.85	Horizontal	-41.20	-13.00	28.20	90
10	17200.0	-46.15	6.8	14.25	Horizontal	-38.70	-13.00	25.70	315

Note: 1.The other Spurious RF Radiated emissions level is no more than noise floor.

2. The worst emission was found in the antenna is Horizontal position.

LTE Band 4 QPSK 20MHz CH-Middle, RB 1

Harmonic	Frequency (MHz)	SG (dBm)	Cable Loss (dB)	Gain (dBi)	Antenna Polarization	EIRP Level (dBm)	Limit (dBm)	Margin (dB)	Azimuth (deg)
2	3465.0	-56.25	2.6	10.75	Horizontal	-48.10	-13.00	35.10	135
3	5170.9	-47.65	2.4	11.05	Horizontal	-39.00	-13.00	26.00	180
4	6930.0	-54.05	4.5	11.15	Horizontal	-47.40	-13.00	34.40	45
5	8662.5	-51.75	5.1	11.35	Horizontal	-45.50	-13.00	32.50	90
6	10395.0	-49.45	5.3	11.95	Horizontal	-42.80	-13.00	29.80	0
7	12127.5	-50.15	5.5	13.55	Horizontal	-42.10	-13.00	29.10	90
8	13860.0	-48.65	6.3	13.75	Horizontal	-41.20	-13.00	28.20	45
9	15592.5	-48.55	6.7	13.85	Horizontal	-41.40	-13.00	28.40	180
10	17325.0	-45.65	6.8	14.25	Horizontal	-38.20	-13.00	25.20	315

Note: 1.The other Spurious RF Radiated emissions level is no more than noise floor.
2. The worst emission was found in the antenna is Horizontal position.

LTE Band 4 QPSK 20MHz CH-High, RB 1

Harmonic	Frequency (MHz)	SG (dBm)	Cable Loss (dB)	Gain (dBi)	Antenna Polarization	EIRP Level (dBm)	Limit (dBm)	Margin (dB)	Azimuth (deg)
2	3490.0	-48.45	2.6	10.15	Horizontal	-40.90	-13.00	27.9	45
3	5208.4	-45.45	2.4	11.05	Horizontal	-36.80	-13.00	23.8	180
4	6980.0	-53.45	4.5	11.15	Horizontal	-46.80	-13.00	33.8	315
5	8725.0	-50.85	5.1	11.35	Horizontal	-44.60	-13.00	31.6	45
6	10470.0	-48.75	5.3	11.95	Horizontal	-42.10	-13.00	29.1	0
7	12215.0	-49.85	5.5	13.55	Horizontal	-41.80	-13.00	28.8	45
8	13960.0	-48.95	6.3	13.75	Horizontal	-41.50	-13.00	28.5	90
9	15705.0	-46.65	6.7	13.85	Horizontal	-39.50	-13.00	26.5	315
10	17450.0	-45.55	6.8	14.25	Horizontal	-38.10	-13.00	25.1	135

Note: 1.The other Spurious RF Radiated emissions level is no more than noise floor.
2. The worst emission was found in the antenna is Horizontal position.

LTE Band 12 QPSK 1.4MHz CH-Low, RB 1

Harmonic	Frequency (MHz)	SG (dBm)	Cable Loss (dB)	Gain (dBi)	Antenna Polarization	ERP Level (dBm)	Limit (dBm)	Margin (dB)	Azimuth (deg)
2	1399.4	-55.90	2.00	10.15	Horizontal	-49.90	-13.00	36.90	180
3	2099.1	-58.90	2.50	11.35	Horizontal	-52.20	-13.00	39.20	315
4	2798.8	-59.40	4.20	10.85	Horizontal	-54.90	-13.00	36.90	45
5	3498.5	-58.60	5.20	11.35	Horizontal	-54.60	-13.00	41.60	180
6	4198.2	-58.50	5.50	11.95	Horizontal	-54.20	-13.00	41.20	315
7	4897.9	-59.10	5.70	13.55	Horizontal	-53.40	-13.00	40.40	45
8	5597.6	-56.50	6.30	13.75	Horizontal	-51.20	-13.00	38.20	0
9	6297.3	-55.50	6.80	13.85	Horizontal	-50.60	-13.00	37.60	45
10	6997.0	-53.00	6.90	14.25	Horizontal	-47.80	-13.00	34.80	90

Note: 1.The other Spurious RF Radiated emissions level is no more than noise floor.
2. The worst emission was found in the antenna is Horizontal position.

LTE Band 12 QPSK 1.4MHz CH-Middle, RB 1

Harmonic	Frequency (MHz)	SG (dBm)	Cable Loss (dB)	Gain (dBi)	Antenna Polarization	ERP Level (dBm)	Limit (dBm)	Margin (dB)	Azimuth (deg)
2	1415.0	-58.50	2.00	10.75	Horizontal	-51.90	-13.00	38.90	45
3	2122.5	-58.09	2.51	11.05	Horizontal	-51.70	-13.00	38.70	0
4	2830.0	-58.60	4.20	11.15	Horizontal	-53.80	-13.00	40.80	315
5	3537.5	-58.60	5.20	11.15	Horizontal	-54.80	-13.00	41.80	315
6	4245.0	-58.90	5.50	11.95	Horizontal	-54.60	-13.00	41.60	135
7	4952.5	-59.10	5.70	13.55	Horizontal	-53.40	-13.00	40.40	45
8	5660.0	-56.70	6.30	13.75	Horizontal	-51.40	-13.00	38.40	0
9	6367.5	-55.10	6.80	13.85	Horizontal	-50.20	-13.00	37.20	315
10	7075.0	-52.70	6.90	14.25	Horizontal	-47.50	-13.00	34.50	135

Note: 1.The other Spurious RF Radiated emissions level is no more than noise floor.
2. The worst emission was found in the antenna is Horizontal position.

LTE Band 12 QPSK 1.4MHz CH-High, RB 1

Harmonic	Frequency (MHz)	SG (dBm)	Cable Loss (dB)	Gain (dBi)	Antenna Polarization	ERP Level (dBm)	Limit (dBm)	Margin (dB)	Azimuth (deg)
2	1430.6	-60.50	2.00	10.15	Horizontal	-54.50	-13.00	41.50	0
3	2145.9	-58.19	2.51	11.05	Horizontal	-51.80	-13.00	38.80	135
4	2861.2	-59.50	4.20	11.15	Horizontal	-54.70	-13.00	41.70	45
5	3576.5	-58.10	5.20	11.15	Horizontal	-54.30	-13.00	41.30	180
6	4291.8	-58.00	5.50	11.95	Horizontal	-53.70	-13.00	40.70	45
7	5007.1	-59.10	5.70	13.55	Horizontal	-53.40	-13.00	40.40	90
8	5722.4	-56.30	6.30	13.75	Horizontal	-51.00	-13.00	38.00	45
9	6437.7	-54.10	6.80	13.85	Horizontal	-49.20	-13.00	36.20	90
10	7153.0	-52.10	6.90	14.25	Horizontal	-46.90	-13.00	33.90	315

Note: 1.The other Spurious RF Radiated emissions level is no more than noise floor.
2. The worst emission was found in the antenna is Horizontal position.

LTE Band 12 QPSK 5MHz CH-Low, RB 1

Harmonic	Frequency (MHz)	SG (dBm)	Cable Loss (dB)	Gain (dBi)	Antenna Polarization	ERP Level (dBm)	Limit (dBm)	Margin (dB)	Azimuth (deg)
2	1403.0	-54.10	2.00	10.15	Horizontal	-48.10	-13.00	35.10	180
3	2104.5	-59.70	2.50	11.35	Horizontal	-53.00	-13.00	40.00	45
4	2806.0	-59.10	4.20	10.85	Horizontal	-54.60	-13.00	41.60	90
5	3507.5	-58.70	5.20	11.35	Horizontal	-54.70	-13.00	41.70	90
6	4209.0	-58.90	5.50	11.95	Horizontal	-54.60	-13.00	41.60	315
7	4910.5	-59.90	5.70	13.55	Horizontal	-54.20	-13.00	41.20	135
8	5612.0	-57.60	6.30	13.75	Horizontal	-52.30	-13.00	39.30	45
9	6313.5	-55.70	6.80	13.85	Horizontal	-50.80	-13.00	37.80	0
10	7015.0	-53.20	6.90	14.25	Horizontal	-48.00	-13.00	35.00	315

Note: 1.The other Spurious RF Radiated emissions level is no more than noise floor.
2. The worst emission was found in the antenna is Horizontal position.

LTE Band 12 QPSK 5MHz CH-Middle, RB 1

Harmonic	Frequency (MHz)	SG (dBm)	Cable Loss (dB)	Gain (dBi)	Antenna Polarization	ERP Level (dBm)	Limit (dBm)	Margin (dB)	Azimuth (deg)
2	1415.0	-59.60	2.00	10.75	Horizontal	-53.00	-13.00	40.00	45
3	2122.5	-59.99	2.51	11.05	Horizontal	-53.60	-13.00	40.60	90
4	2830.0	-59.00	4.20	11.15	Horizontal	-54.20	-13.00	41.20	315
5	3537.5	-58.70	5.20	11.15	Horizontal	-54.90	-13.00	41.90	45
6	4245.0	-58.90	5.50	11.95	Horizontal	-54.60	-13.00	41.60	0
7	4952.5	-59.10	5.70	13.55	Horizontal	-53.40	-13.00	40.40	315
8	5660.0	-57.40	6.30	13.75	Horizontal	-52.10	-13.00	39.10	135
9	6367.5	-55.40	6.80	13.85	Horizontal	-50.50	-13.00	37.50	180
10	7075.0	-52.80	6.90	14.25	Horizontal	-47.60	-13.00	34.60	45

Note: 1.The other Spurious RF Radiated emissions level is no more than noise floor.
 2. The worst emission was found in the antenna is Horizontal position.

LTE Band 12 QPSK 5MHz CH-High, RB 1

Harmonic	Frequency (MHz)	SG (dBm)	Cable Loss (dB)	Gain (dBi)	Antenna Polarization	ERP Level (dBm)	Limit (dBm)	Margin (dB)	Azimuth (deg)
2	1427.0	-56.60	2.00	10.15	Horizontal	-50.60	-13.00	37.60	135
3	2140.5	-59.09	2.51	11.05	Horizontal	-52.70	-13.00	39.70	45
4	2854.0	-59.10	4.20	11.15	Horizontal	-54.30	-13.00	41.30	0
5	3567.5	-58.40	5.20	11.15	Horizontal	-54.60	-13.00	41.60	90
6	4281.0	-57.80	5.50	11.95	Horizontal	-53.50	-13.00	40.50	45
7	4994.5	-58.30	5.70	13.55	Horizontal	-52.60	-13.00	39.60	90
8	5708.0	-57.30	6.30	13.75	Horizontal	-52.00	-13.00	39.00	315
9	6421.5	-55.10	6.80	13.85	Horizontal	-50.20	-13.00	37.20	135
10	7135.0	-52.60	6.90	14.25	Horizontal	-47.40	-13.00	34.40	45

Note: 1.The other Spurious RF Radiated emissions level is no more than noise floor.
 2. The worst emission was found in the antenna is Horizontal position.

LTE Band 12 QPSK 10MHz CH-Low, RB 1

Harmonic	Frequency (MHz)	SG (dBm)	Cable Loss (dB)	Gain (dBi)	Antenna Polarization	ERP Level (dBm)	Limit (dBm)	Margin (dB)	Azimuth (deg)
2	1408.0	-56.40	2.00	10.15	Horizontal	-50.40	-13.00	37.40	90
3	2112.0	-59.89	2.51	11.35	Horizontal	-53.20	-13.00	40.20	315
4	2816.0	-59.60	4.20	10.85	Horizontal	-55.10	-13.00	42.10	180
5	3520.0	-60.40	5.20	11.35	Horizontal	-56.40	-13.00	43.40	135
6	4224.0	-60.20	5.50	11.95	Horizontal	-55.90	-13.00	42.90	180
7	4928.0	-60.10	5.70	13.55	Horizontal	-54.40	-13.00	41.40	45
8	5632.0	-57.10	6.30	13.75	Horizontal	-51.80	-13.00	38.80	90
9	6336.0	-55.40	6.80	13.85	Horizontal	-50.50	-13.00	37.50	45
10	7040.0	-53.50	6.90	14.25	Horizontal	-48.30	-13.00	35.30	225

Note: 1.The other Spurious RF Radiated emissions level is no more than noise floor.
 2. The worst emission was found in the antenna is Horizontal position.

LTE Band 12 QPSK 10MHz CH-Middle, RB 1

Harmonic	Frequency (MHz)	SG (dBm)	Cable Loss (dB)	Gain (dBi)	Antenna Polarization	ERP Level (dBm)	Limit (dBm)	Margin (dB)	Azimuth (deg)
2	1415.0	-61.40	2.00	10.75	Horizontal	-54.80	-13.00	41.80	135
3	2122.5	-59.49	2.51	11.05	Horizontal	-53.10	-13.00	40.10	225
4	2830.0	-60.40	4.20	11.15	Horizontal	-55.60	-13.00	42.60	45
5	3537.5	-60.00	5.20	11.15	Horizontal	-56.20	-13.00	43.20	45
6	4245.0	-59.50	5.50	11.95	Horizontal	-55.20	-13.00	42.20	90
7	4952.5	-59.60	5.70	13.55	Horizontal	-53.90	-13.00	40.90	315
8	5660.0	-58.80	6.30	13.75	Horizontal	-53.50	-13.00	40.50	90
9	6367.5	-55.50	6.80	13.85	Horizontal	-50.60	-13.00	37.60	315
10	7075.0	-52.20	6.90	14.25	Horizontal	-47.00	-13.00	34.00	135

Note: 1.The other Spurious RF Radiated emissions level is no more than noise floor.
 2. The worst emission was found in the antenna is Horizontal position.

LTE Band 12 QPSK 10MHz CH-High, RB 1

Harmonic	Frequency (MHz)	SG (dBm)	Cable Loss (dB)	Gain (dBi)	Antenna Polarization	ERP Level (dBm)	Limit (dBm)	Margin (dB)	Azimuth (deg)
2	1422.0	-58.1	2.00	10.15	Horizontal	-52.10	-13.00	39.10	0
3	2133.0	-58.59	2.51	11.05	Horizontal	-52.20	-13.00	39.20	315
4	2844.0	-60.1	4.20	11.15	Horizontal	-55.30	-13.00	42.30	225
5	3555.0	-59.7	5.20	11.15	Horizontal	-55.90	-13.00	42.90	45
6	4266.0	-59.3	5.50	11.95	Horizontal	-55.00	-13.00	42.00	45
7	4977.0	-59.9	5.70	13.55	Horizontal	-54.20	-13.00	41.20	135
8	5688.0	-57.3	6.30	13.75	Horizontal	-52.00	-13.00	39.00	180
9	6399.0	-55.7	6.80	13.85	Horizontal	-50.80	-13.00	37.80	45
10	7110.0	-51.6	6.90	14.25	Horizontal	-46.40	-13.00	33.40	90

Note: 1.The other Spurious RF Radiated emissions level is no more than noise floor.
 2. The worst emission was found in the antenna is Horizontal position.

LTE Band 13 QPSK 5MHz CH-Low, RB 1

Harmonic	Frequency (MHz)	SG (dBm)	Cable Loss (dB)	Gain (dBi)	Antenna Polarization	ERP Level (dBm)	Limit (dBm)	Margin (dB)	Azimuth (deg)
2	1555.8	-56.40	2.00	10.15	Horizontal	-50.40	-40.00	10.40	45
3	2338.5	-54.50	2.50	11.35	Horizontal	-47.80	-13.00	34.80	90
4	3118.0	-61.40	4.20	10.85	Horizontal	-56.90	-13.00	43.90	45
5	3897.5	-58.50	5.20	11.35	Horizontal	-54.50	-13.00	41.50	135
6	4677.0	-58.00	5.50	11.95	Horizontal	-53.70	-13.00	40.70	180
7	5456.5	-56.60	5.70	13.55	Horizontal	-50.90	-13.00	37.90	45
8	6236.0	-56.10	6.30	13.75	Horizontal	-50.80	-13.00	37.80	90
9	7015.5	-52.90	6.80	13.85	Horizontal	-48.00	-13.00	35.00	45
10	7795.0	-53.70	6.90	14.25	Horizontal	-48.50	-13.00	35.50	0

Note: 1.The other Spurious RF Radiated emissions level is no more than noise floor.
 2. The worst emission was found in the antenna is Horizontal position.

LTE Band 13 QPSK 5MHz CH-Middle, RB 1

Harmonic	Frequency (MHz)	SG (dBm)	Cable Loss (dB)	Gain (dBi)	Antenna Polarization	ERP Level (dBm)	Limit (dBm)	Margin (dB)	Azimuth (deg)
2	1564.0	-58.10	2.00	10.75	Horizontal	-51.50	-40.00	11.50	315
3	2346.0	-53.49	2.51	11.05	Horizontal	-47.10	-13.00	34.10	135
4	3128.0	-61.40	4.20	11.15	Horizontal	-56.60	-13.00	43.60	90
5	3910.0	-60.50	5.20	11.15	Horizontal	-56.70	-13.00	43.70	45
6	4692.0	-57.80	5.50	11.95	Horizontal	-53.50	-13.00	40.50	225
7	5474.0	-58.90	5.70	13.55	Horizontal	-53.20	-13.00	40.20	45
8	6256.0	-56.20	6.30	13.75	Horizontal	-50.90	-13.00	37.90	90
9	7038.0	-52.80	6.80	13.85	Horizontal	-47.90	-13.00	34.90	315
10	7820.0	-52.40	6.90	14.25	Horizontal	-47.20	-13.00	34.20	90

Note: 1.The other Spurious RF Radiated emissions level is no more than noise floor.
2. The worst emission was found in the antenna is Horizontal position.

LTE Band 13 QPSK 5MHz CH-High, RB 1

Harmonic	Frequency (MHz)	SG (dBm)	Cable Loss (dB)	Gain (dBi)	Antenna Polarization	ERP Level (dBm)	Limit (dBm)	Margin (dB)	Azimuth (deg)
2	1569.0	-56.80	2.00	10.15	Horizontal	-50.80	-40.00	10.80	45
3	2353.5	-54.89	2.51	11.05	Horizontal	-48.50	-13.00	35.50	135
4	3138.0	-61.80	4.20	11.15	Horizontal	-57.00	-13.00	44.00	45
5	3922.5	-58.60	5.20	11.15	Horizontal	-54.80	-13.00	41.80	90
6	4707.0	-58.20	5.50	11.95	Horizontal	-53.90	-13.00	40.90	45
7	5491.5	-58.10	5.70	13.55	Horizontal	-52.40	-13.00	39.40	225
8	6276.0	-56.00	6.30	13.75	Horizontal	-50.70	-13.00	37.70	45
9	7060.5	-53.10	6.80	13.85	Horizontal	-48.20	-13.00	35.20	90
10	7845.0	-52.80	6.90	14.25	Horizontal	-47.60	-13.00	34.60	315

Note: 1.The other Spurious RF Radiated emissions level is no more than noise floor.
2. The worst emission was found in the antenna is Horizontal position.

LTE Band 13 QPSK 10MHz CH-Low, RB 1

Harmonic	Frequency (MHz)	SG (dBm)	Cable Loss (dB)	Gain (dBi)	Antenna Polarization	ERP Level (dBm)	Limit (dBm)	Margin (dB)	Azimuth (deg)
2	1556.5	-56.20	2.00	10.15	Horizontal	-50.20	-40.00	10.20	180
3	2346.0	-55.99	2.51	11.35	Horizontal	-49.30	-13.00	36.30	45
4	3128.0	-61.30	4.20	10.85	Horizontal	-56.80	-13.00	43.80	135
5	3910.0	-59.40	5.20	11.35	Horizontal	-55.40	-13.00	42.40	45
6	4692.0	-57.20	5.50	11.95	Horizontal	-52.90	-13.00	39.90	135
7	5474.0	-58.80	5.70	13.55	Horizontal	-53.10	-13.00	40.10	180
8	6256.0	-56.20	6.30	13.75	Horizontal	-50.90	-13.00	37.90	45
9	7038.0	-52.60	6.80	13.85	Horizontal	-47.70	-13.00	34.70	90
10	7820.0	-53.10	6.90	14.25	Horizontal	-47.90	-13.00	34.90	45

Note: 1.The other Spurious RF Radiated emissions level is no more than noise floor.
2. The worst emission was found in the antenna is Horizontal position.

LTE Band 13 QPSK 10MHz CH-Middle, RB 1

Harmonic	Frequency (MHz)	SG (dBm)	Cable Loss (dB)	Gain (dBi)	Antenna Polarization	ERP Level (dBm)	Limit (dBm)	Margin (dB)	Azimuth (deg)
2	1555.3	-57.10	2.00	10.75	Horizontal	-50.50	-40.00	10.50	90
3	2346.0	-55.89	2.51	11.05	Horizontal	-49.50	-13.00	36.50	45
4	3128.0	-61.80	4.20	11.15	Horizontal	-57.00	-13.00	44.00	90
5	3910.0	-58.30	5.20	11.15	Horizontal	-54.50	-13.00	41.50	315
6	4692.0	-57.50	5.50	11.95	Horizontal	-53.20	-13.00	40.20	90
7	5474.0	-58.00	5.70	13.55	Horizontal	-52.30	-13.00	39.30	45
8	6256.0	-56.50	6.30	13.75	Horizontal	-51.20	-13.00	38.20	90
9	7038.0	-52.30	6.80	13.85	Horizontal	-47.40	-13.00	34.40	45
10	7820.0	-52.80	6.90	14.25	Horizontal	-47.60	-13.00	34.60	0

Note: 1.The other Spurious RF Radiated emissions level is no more than noise floor.
2. The worst emission was found in the antenna is Horizontal position.

LTE Band 13 QPSK 10MHz CH-High, RB 1

Harmonic	Frequency (MHz)	SG (dBm)	Cable Loss (dB)	Gain (dBi)	Antenna Polarization	ERP Level (dBm)	Limit (dBm)	Margin (dB)	Azimuth (deg)
2	1564.0	-56.70	2.00	10.15	Horizontal	-50.70	-40.00	10.70	225
3	2346.0	-55.49	2.51	11.05	Horizontal	-49.10	-13.00	36.10	0
4	3128.0	-62.00	4.20	11.15	Horizontal	-57.20	-13.00	44.20	90
5	3910.0	-58.80	5.20	11.15	Horizontal	-55.00	-13.00	42.00	315
6	4692.0	-57.70	5.50	11.95	Horizontal	-53.40	-13.00	40.40	135
7	5474.0	-58.80	5.70	13.55	Horizontal	-53.10	-13.00	40.10	45
8	6256.0	-56.50	6.30	13.75	Horizontal	-51.20	-13.00	38.20	0
9	7038.0	-52.70	6.80	13.85	Horizontal	-47.80	-13.00	34.80	315
10	7820.0	-53.20	6.90	14.25	Horizontal	-48.00	-13.00	35.00	45

Note: 1. The other Spurious RF Radiated emissions level is no more than noise floor.

2. The worst emission was found in the antenna is Horizontal position.

6 Main Test Instruments

Name	Manufacturer	Type	Serial Number	Calibration Date	Expiration Date
Base Station Simulator	R&S	CMW500	113645	2018-05-20	2019-05-19
Power Splitter	Hua Xiang	SHX-GF2-2-13	10120101	2018-05-20	2019-05-19
Spectrum Analyzer	Key sight	N9010A	MY50210259	2018-05-20	2019-05-19
Signal Analyzer	R&S	FSV30	100815	2017-12-17	2018-12-16
Signal generator	R&S	SMB 100A	102594	2018-05-20	2019-05-19
EMI Test Receiver	R&S	ESCI	100948	2018-05-20	2019-05-19
Loop Antenna	SCHWARZBECK	FMZB1519	1519-047	2014-12-06	2019-12-05
Trilog Antenna	SCHWARZBECK	VUBL 9163	9163-201	2017-11-18	2020-11-17
Horn Antenna	R&S	HF907	100126	2014-12-06	2019-12-05
Horn Antenna	ETS-Lindgren	3160-09	00102643	2015-01-30	2020-01-29
Climatic Chamber	Re Ce	PT-30B	20101891	2015-07-18	2018-07-17
RF Cable	Agilent	SMA 15cm	0001	NA	NA
Preamplifier	R&S	SCU18	102327	2018-05-20	2019-05-19
MOB COMMS DC SUPPLY	Keysight	66319D	MY43004105	2018-05-20	2019-05-19
Software	R&S	EMC32	V 8.52.0	NA	NA

*****END OF REPORT *****